

**kettal**



4–5	Index
6–7	Kettal
8–15	Sustainability
16–19	Officescape
20–37	Kall
38–51	Pavilion M
52–63	Focus
64–87	Meeting rooms
88–113	Hub

114–133	Support
134–155	M Specs & Lighting
158–181	Passage
182–194	Insula
200–215	A
216–227	Eolias
228–235	Sofa M
234–245	Materials
246	Credits

# Focus

# Meeting&Hub

# Support

# Furniture

## High focus/Workpoints

Kall S  
Page 20-37

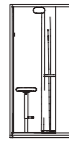

Kall M  
Page 20-37

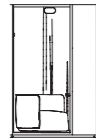

Kall L  
Page 20-37

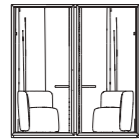

Kall XL  
Page 20-37

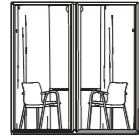

Phone booth S  
(1 person)  
Page 54-63



Phone booth L  
(2 persons)  
Page 54-63

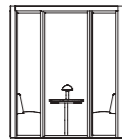

Phone booth XL  
(4 persons)  
Page 54-63

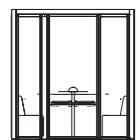

## Formal collaboration/Flexible /Informal/ Collaborative

Meeting rooms  
2-8 persons  
Page 66-87

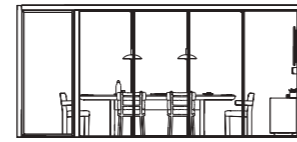

Hub  
Curved  
Page 90-95

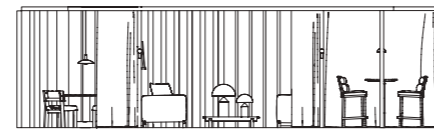

Hub  
Walk-Through  
Page 96-99

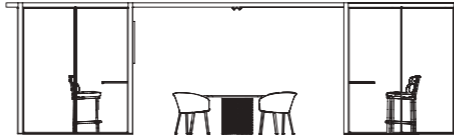

Hub Open  
With meeting  
& Sofas  
Page 100-103

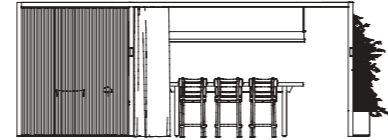

Hub Open  
With Curtains  
Page 108-109

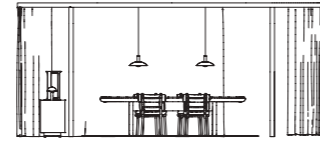

Hub Open  
Page 104-107

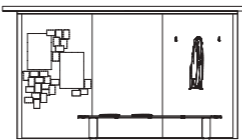

Hub  
Outdoor  
Page 110-113

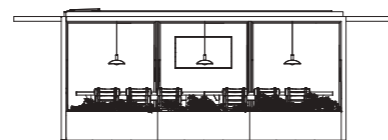

## Business /People support

Reception  
Page 116-119

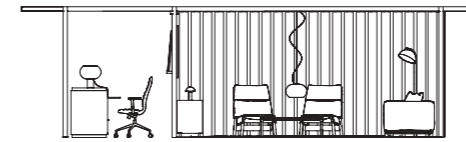

Reception  
With Meeting  
& Printing Area  
Page 120-125

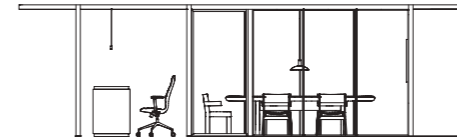

Lockers  
Page 126-129

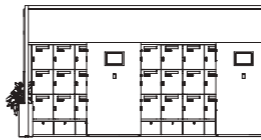

Kitchen  
Page 130-133

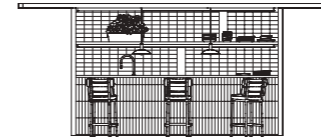

## High focus/Workpoints

Passage by  
Ronan Bouroullec  
Page 158-181

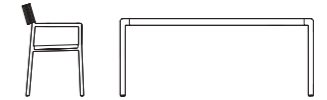

Insula  
by Patricia Urquiola  
Page 182-199

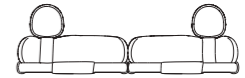

A collection by  
Naoto Fukasawa  
Page 200-215

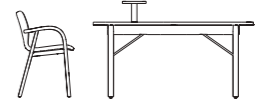

Eolias collection  
by Antonio Citterio  
Page 216-227



Sofa M  
by Kettal Studio  
Page 228-333

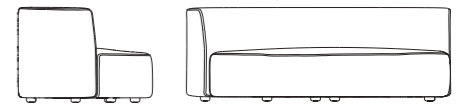

Kettal is a family business established in Europe in 1966.



All of our products are manufactured 45km from Barcelona in a small coastal town. We pride ourselves on our European made quality. In-house manufacturing allows us to pay close attention to detail and gives us the ability to meet our clients' customization requirements, making each piece of Kettal furniture unique and exclusive.

The importance of research – both scientific and technological – has always been at the forefront of our product development. The high-quality products we offer today are the result of our spirit of innovation.

We have our own state of the art manufacturing plant where the product is designed, manufactured and tested locally.

Our manufacturing processes involve intense manual labor and 85% of Kettal products are handmade. Our handmade ethos means that we build strong yet beautiful Kettal pieces that display an exquisite attention to detail.

# Sustainability: Building a greener tomorrow.

At Kettal, we are committed to more than just creating exquisite outdoor furniture and designs. We are dedicated to shaping a sustainable future where beauty and nature coexist harmoniously. Our journey towards sustainability is rooted in a deep respect for the environment and a passion for innovation.

In an era where the preservation of our planet is of utmost importance, Kettal is taking meaningful steps towards reducing our carbon footprint, conserving natural resources, and minimizing waste. Our sustainable practices extend from the selection of eco-

friendly materials to energy-efficient manufacturing processes, all while maintaining our unwavering commitment to craftsmanship and design excellence.

Join us in exploring the world of Kettal Sustainability, where style meets eco-consciousness. Discover how we blend creativity with responsibility, striving to inspire a lifestyle that not only enhances outdoor spaces but also safeguards the planet for generations to come. Together, we can forge a greener tomorrow, one design at a time.

# We monitor the life cycle of our products.

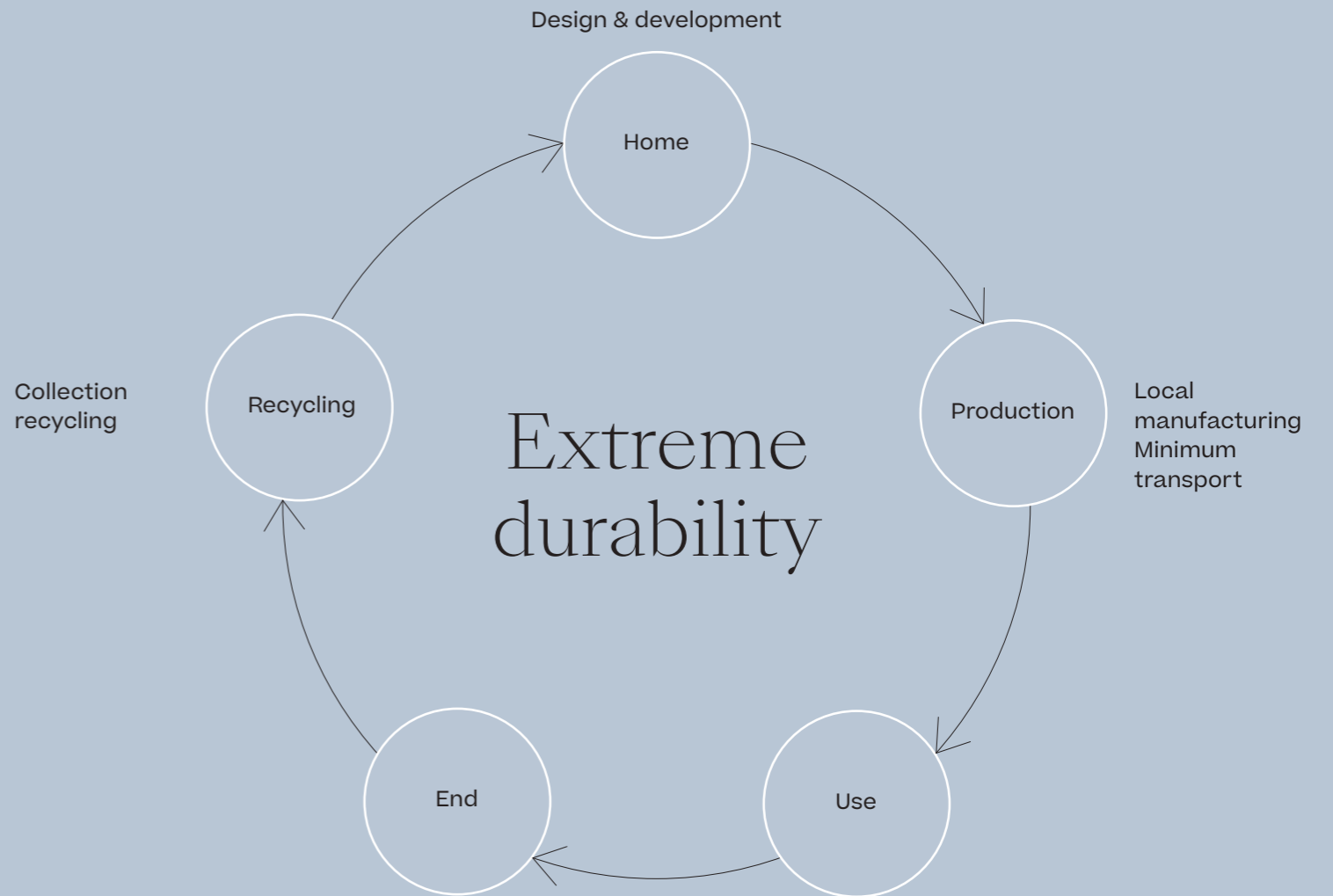

## Environmental aspects

Nearly 100% of paint used is recyclable and eco-friendly.

The most significant environmental aspects in the furniture sector are related to the consumption of raw materials, specifically fuel, paint and wood used in furniture manufacturing. With this in mind, we implement continuous measures to minimise any negative impacts on the environment. For example, Kettal carries out product research to improve processes and assess the possible external impact of its products.

True to its philosophy of respect for the environment, Kettal ensures that its main materials, such as paint and wood, are both high-quality and environmentally sustainable. As a result, almost 100% of the paint it uses is recyclable and environmentally friendly. Its main supplier of paint used in the manufacture of furniture has both quality certifications (Qualicoat, GSB, IKS, Quali Steel Coat) and environmental certifications for its products (verified by AENOR in accordance with its Global EPD type III ecolabel system, ISO standards, etc.).

As regards wood, Kettal uses teak certified by the agency SUCOFINDO, which guarantees environmental requirements, commitment to quality, occupational health and safety and social responsibility. Likewise, following its commitment to offer the best design and the highest product quality, for each new design it draws up an Environmental Product Declaration (EPD) for the purpose of assessing the



environmental impacts. The study for the EPD produces quantitative information on the product's environmental performance through all stages of its life cycle. This information is relevant when identifying sources of environmental impact, prioritising, making decisions focused on minimising the environmental impacts of similar or future products, implementing eco-design strategies and providing consumers with environmental product information.

Given the characteristics of the sectors in which Kettal operates, it does not use any materials or production processes that directly release greenhouse gases (GHGs) or other substances with a serious environmental impact.

## Products

Our products are local manufactured and 85% handmade.

The human factor is crucial as manual processes take priority over mechanical ones. This allows using techniques that would not be possible in a standard production line process and meticulous control over the quality.

Kettal has analyzed the variants of product life cycle to minimize environmental impact as far as possible. Not only in our raw material usage, but also other variables such as CO2 emissions from transport or use and durability. Under this premise, the raw materials are recyclable and/or recycled, and the objective is to produce all components close to the production site. For example, the essential raw material used at Kettal, such as fabric, rope, and aluminium, are produced within a radius of 100km. Also, each design is aesthetically designed and technically developed to last as long as possible, that is why Kettal keeps technical drawings and product patterns that are 30 years old in order to be able to replace components and extend the life of the product.

Our mission is to create furniture that is timeless and contemporary, combining creativity, personality, innovation, and modern production methods. We praise the simplicity and beauty of everyday life, the excellence in our production and customer service. We believe in sustainable growth through building lasting relationships and products.

When it comes to our products, sustainability is at the core of our design and manufacturing processes. We carefully select materials that are ethically sourced and environmentally friendly, ensuring they meet our high standards for quality and durability. We embrace innovative technologies and techniques that reduce waste, energy consumption, and carbon footprint throughout the production cycle.

Additionally, our commitment to sustainability extends to our supply chain. We work closely with our suppliers to ensure they adhere to responsible and sustainable practices. By promoting fair labor conditions, minimizing environmental pollution, and supporting local communities, we strive to create a positive impact beyond our own operations in Bellvei, a small coastal village 45km from Barcelona.



# Materials

Materials are an important part of caring for the environment and a key factor in the product life cycle. All materials are recyclable and recycled as much as possible, as long as they have the characteristics to ensure durability. The better the quality, the longer the product life cycle. And a longer life cycle means it is more environmentally friendly, as fewer manufacturing processes will have to be put in place, reducing the carbon footprint and generating less waste.

Our raw materials are not only recyclable, but recycled. We study the impact of the material recovery process and the durability of the material over time. The essential raw materials are produced locally, within a radius of 100km. We have analysed each product life cycle to minimize environmental impact as far as possible. Not only raw materials, but other variables such as CO<sup>2</sup> emissions from transport or use and durability.

## Materials

Aluminium			Carbon emissions: 6,99kg CO <sub>2</sub> eq/kg Durability average: 30 years
Terrain Coatings			Carbon emissions: 0,88 kg co <sub>2</sub> eq/kg Durability average: 20 years
Relate fabrics			Carbon emissions: 0,321 kg co <sub>2</sub> eq/kg Durability average: 15 years
Glass			Carbon emissions: 0,79 kg co <sub>2</sub> eq/kg Durability average: 30 years
Stainless Steel			Carbon emissions: 4,55 kg co <sub>2</sub> eq/kg Durability average: 20 years
Bela Ropes and Stripes			Carbon emissions: 2,21 kg co <sub>2</sub> eq/kg Durability average: 15 years
Terrain Elements Fabrics			Carbon emissions: 3,81kg co <sub>2</sub> eq/kg Durability average: 15 years
Parallel			Carbon emissions: 2,72 kg co <sub>2</sub> eq/kg Durability average: 20 years
Ceramic			Carbon emissions: 0,67 kg co <sub>2</sub> eq/kg Durability average: 30 years

# Key values

## We do not build in obsolescence.

### Fluorocarbon-free Fabrics

Creation of Terrain Fabrics, first fabric finished with a fluorocarbon-free compound, which is the ideal way to achieve wearing comfort and protect the material in an environmentally friendly way. Since then, all our fabrics are fluorocarbon-free.

### FSC Wood

All wood used in our furniture is FSC certified, ensuring its sustainable origin and responsible management. The wood used in our furniture has been sourced from well-managed forests, supporting the conservation of natural habitats and the livelihoods of local communities.

### Goal: Zero emissions

At Kettal, our goal is to achieve zero emissions by 2036. We are committed to minimizing our environmental impact and actively working towards a sustainable future. Through innovative practices, energy-efficient technologies, and responsible manufacturing processes, we aim to eliminate greenhouse gas emissions from our operations entirely. We understand the urgency of addressing climate change, and reaching this ambitious target is an essential step in creating a better world for future generations.

### Pavilions

Our Pavilions are made with 85% Recycled materials.

### Carbon footprint

Since the past year, we have been analyzing the carbon footprint of each of our products. In our commitment to sustainability, we believe it is essential to understand and reduce the environmental impact of our manufacturing processes. By examining the carbon footprint, we aim to identify areas where improvements can be made, such as optimizing energy consumption, reducing emissions, and implementing eco-friendly materials. This ongoing analysis allows us to make informed decisions and work towards creating more environmentally-conscious products for our customers.

### Environmental-certified materials

Our materials are backed by environmental certifications. These certifications ensure that the materials we use in our products have been sourced and processed in an eco-friendly and sustainable manner. We are committed to upholding these environmental standards and continuously seeking ways to minimize our ecological footprint.

### CFC-free polyurethane

The polyurethane we use is CFC-free. CFC stands for chlorofluorocarbon, which is a harmful substance known for its ozone-depleting properties. By opting for CFC-free polyurethane, we ensure that our products contribute to a healthier planet by reducing the release of harmful substances into the atmosphere. We believe in creating sustainable and responsible designs, and this commitment extends to the materials we choose.

### Paint

The main supplier of paint used in the manufacture of furniture has both quality certifications (Qualicoat, GSB, IKS, Quali Steel Coat) and environmental certifications for its products (verified by AENOR in accordance with its Global EPD type III ecolabel system, ISO standards, etc.).

# We care about our employee's security and wellbeing.

- Strict Workplace Security and Protection norms and continuous Workplace Risk Assessment and Training.
- Internal career promotion enhancement giving priority to fill an open role with an existing employee instead of hiring someone new.
- Improve work-life balance with flexible work hour schedules.



# We promote diversity and inclusion within our employees.

## Gender

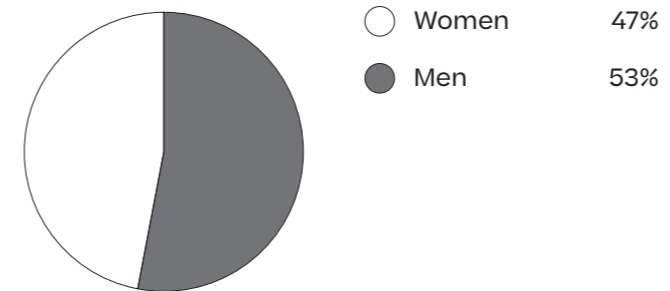

## Nationality

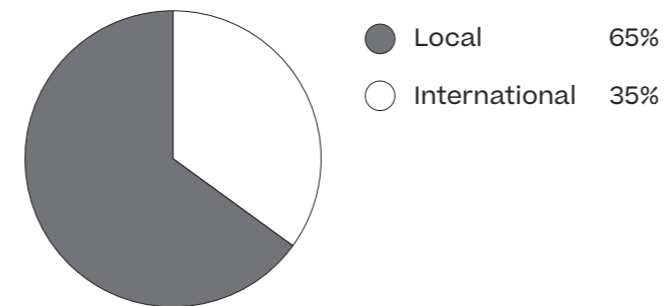

- Advocate for the people to maintain pay equality.
- Equal pay policy between genders implementing fair scheduling practices.
- Recruitment policy does promote gender equality and multi-cultural inclusion.
- Application of Spanish Family leave and childcare policies.
- Acknowledgement of holidays for all cultures.
- Promotion of team working across the organization.

Statistics	Kettal	Industry
Staff Turnover	7	17,1
Work Absenteeism (%)	2,21	6,16
Seniority Average (yr)	19,26	10,26
Accident Frequency	0,02	26,4

Our average period of employment is 19,26 years.

# Officespace

The need for flexible, open-plan workspaces is clear. Pavilion M allows you to define your own layouts in a way that meets both the demands of modern employees and the unique needs of your company. As if you were the architect of your own city, you can use Pavilion M to help you define your workplace's structure, private and public spaces, and overall flow.

A workplace resembling a living city, with its interconnected neighborhoods, networks & spaces.

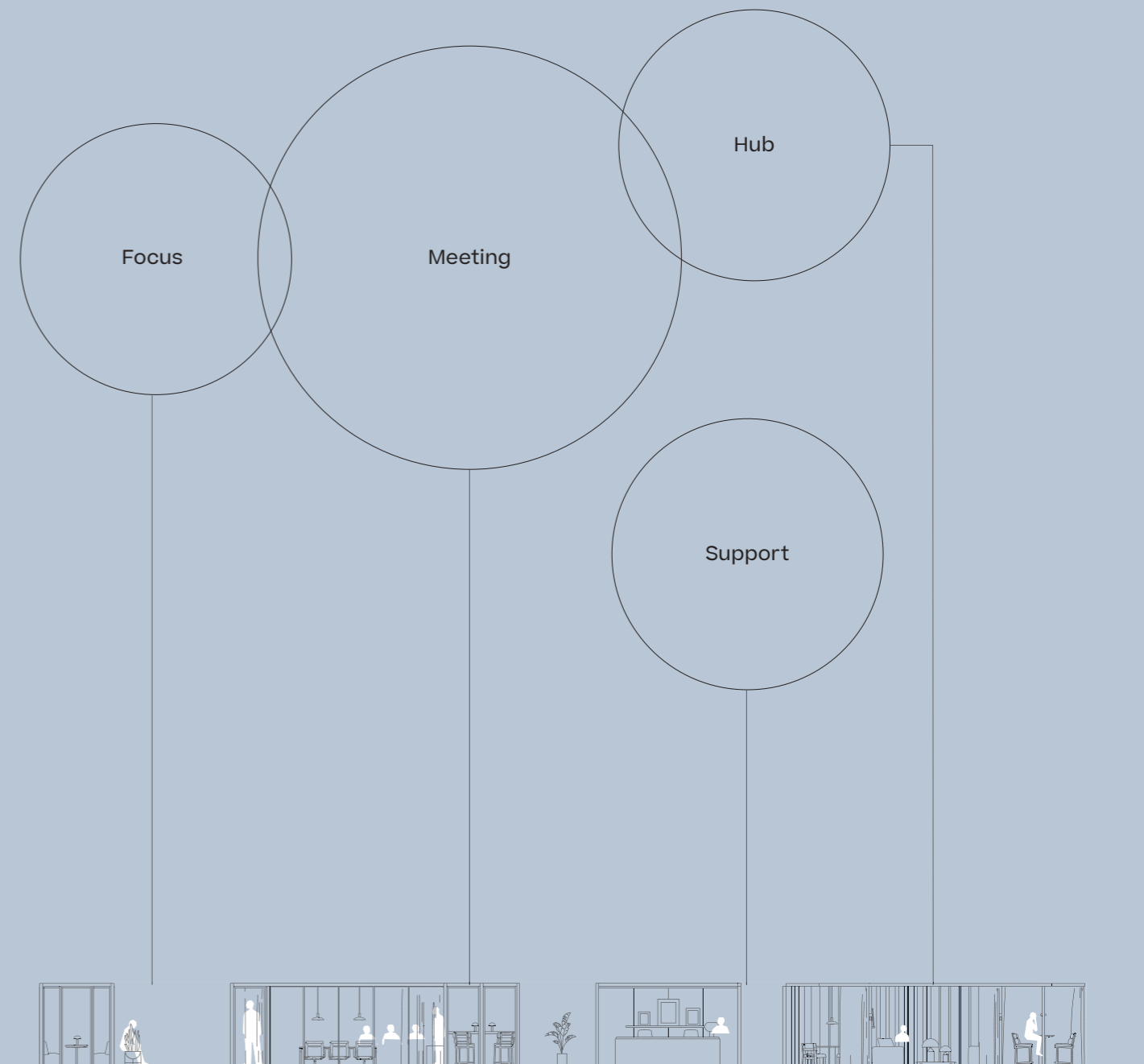



Outdoor area

Meeting rooms

Hub

Office furniture

Focus Phone booth

Support Kitchen

Meeting rooms

Focus Phone Booth

Support Reception

# Kall, by Kettal studio

Part of our Focus system (page 44)

Introducing the Kall Collection - A modern solution for private and comfortable conversations. We believe that a Phone booth should simply be the door of a meeting room, which is why we have made the glass door the protagonist, and the space of the "Phone booth" corresponds to the projection of this door, making it appear embedded against the wall when viewed frontally. Our design ensures minimalism and functionality without any unnecessary frills.

Privacy is a key aspect, and we understand that users need a discreet environment for confidential meetings. Our small side walls provide structural support while also maintaining privacy for documents, device screens, and even facial expressions during a conversation. The addition of a translucent curtain further enhances the sense of protection against prying eyes.

We understand that a Phone booth should not be a cold space, so we have created a warm and inviting environment. Our design provides a pleasant atmosphere, making it closer to a meeting room or a home room rather than a typical elevator cabin.

Technology is an essential component, and we have ensured that the technology is intuitive and user-friendly. Everything is controlled electronically, with scene creation systems, table height regulation, ventilation control, and connectivity all intentionally hidden. Our interaction controls simulate the controls of old HIFI equipment, emphasizing that this booth is a simple and pleasant space where users can provide the main technology using their own devices. For tech-savvy users, we also offer a touchscreen control system.

The Kall Phone booth family consists of various sizes. The "S" is the basic and standard size. The "M" is 30cm wider, allowing for a swivel armchair, similar to a lounge room, with a relaxed work posture. We also offer an "L" version for two people and a "XL" for 4. All of our Phone booths are modular, which means they can be combined to create special configurations according to the situation.















Kall S

KSB300100

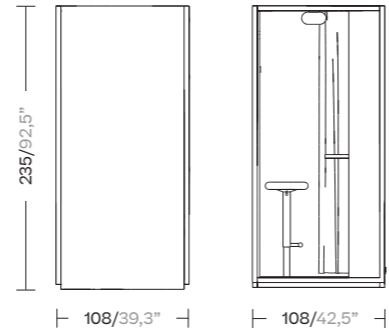

Kall M

KSB300200

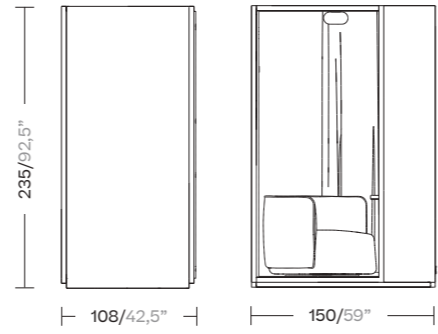

Kall L

KSB300300

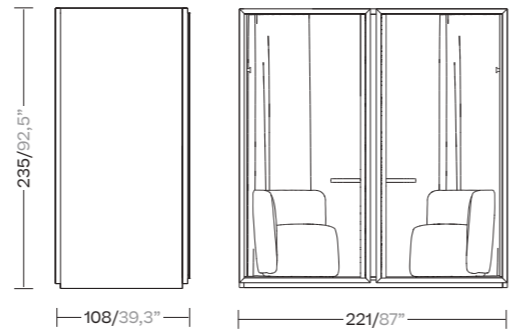

Kall XL

KSB300400

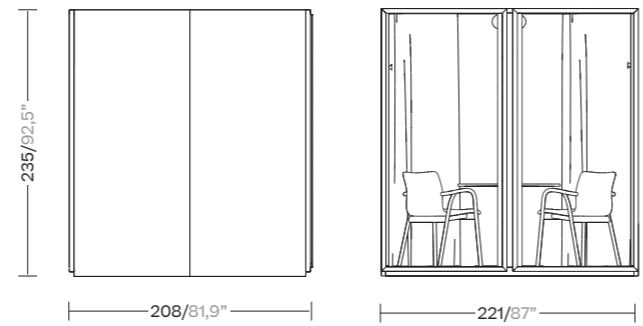

Interior

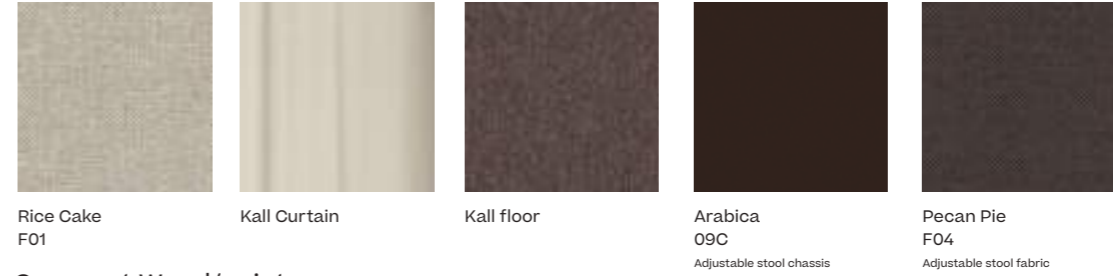

Compact Wood/paint



Outer Panel color

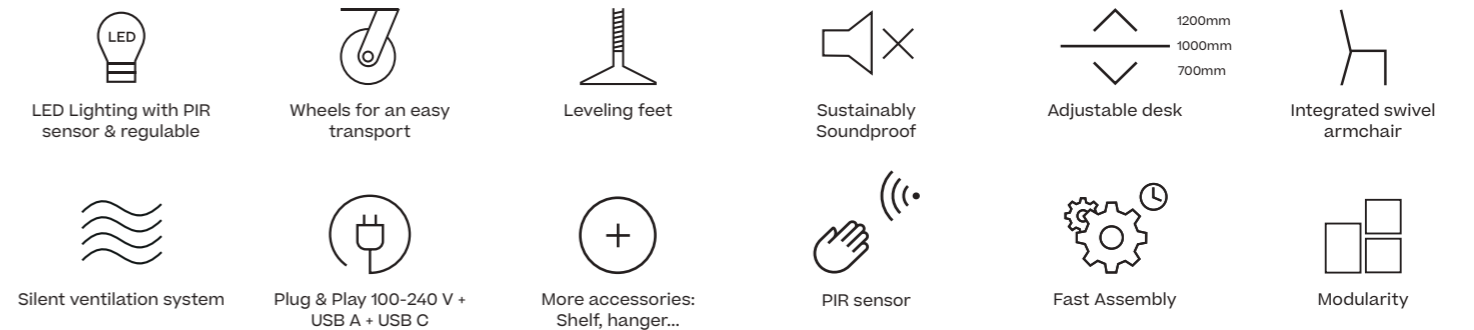
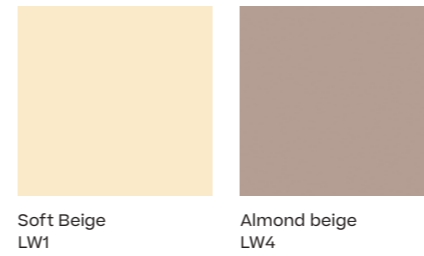

\*Minimum recommended installation height: 2400 mm

# Kall Features

Silent Ventilation



The air enters through the floor (back of the stool) and comes out through the gap of each side of the table panel (1 cm of space) that is used to raise and lower the table. The cabin has a flow rate of 115m<sup>3</sup>/h (32 l/s) 60 air changes/hour inside. The nominal flow rate of the fans is 120m<sup>3</sup>/h.

Integrated wheels and Leveling feet



To ensure the stability of the cabin, the position of the regulator feet should be adjusted to raise the wheels. This procedure can be performed using a wrench, as the regulator feet have a nut that allows for adjustment. To move the cabin it is necessary to raise the regulator feet again.

Sustainably Soundproof



Class B, according ISO 23351-1  
Test: 28,9 dB (D<sub>SA</sub>)  
Acoustic glass panels 3+3 with 35 dB.  
Wood panel + PET + Foamed fabric.

Test Report



Adjustable Stool



- Adjustable via lever located under the seat.
- Adjustable from 550 to 800 mm.
- It supports a maximum weight of 200 kg.

Swivel armchair



This versatile piece of furniture provides a comfortable and stylish seating option that can be easily adjusted to face any direction. With its sleek design and smooth rotation, the Swivel Armchair is ideal for comfortable meetings.

Kern Screen



The Kern screen is an intuitive control interface used in Kall phone booths to manage various environmental settings. With the Kern screen, users can easily adjust lighting, air circulation, and other ambient features, providing a comfortable and customizable experience for private workspaces.

LED Ceiling Light



- LED Ceiling Light
- 3000K (Dimmable)
- Ambient Lighting

LED Shelf with Light



To support your iPad, mobile phone, or complete the space with a picture or different decorative elements

- LED Shelf Light
- 3000K (Dimmable)
- Task Lighting

Adjustable Desk



The table height is adjustable by the cylindrical switch on the controller. It can be adjusted from 700 to 1200 mm in height. When non-adjustable height is 1100mm. It supports a maximum weight of 100 kg.

Controller



Adjustable table version. Plug USB-A / USB-C (3A@60W) / shelf light dimmer, fans power regulator and desk height regulator.

Occupancy Light (optional)



The occupancy light in the phone booth indicates whether the space is free or in use. When the light is green, the booth is available for use, but when it turns red, it signals that someone is inside. This simple system helps manage space effectively and ensures privacy for users.

Modularity

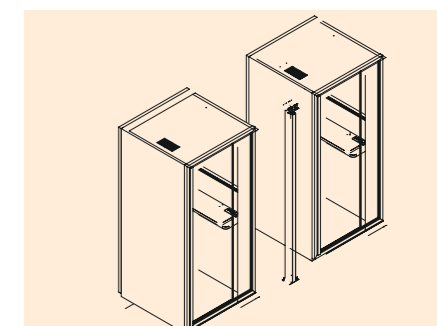

Our Kall booths can be combined in different ways to create work environments according to the needs of each user and adapt to different types of space.



See the video here



CE Certified

# Kall Acoustic side panels

## 28,9 db

### Description

All our panels have been tested to ensure they meet the required acoustic levels. We have evaluated various wall combinations to provide guidelines regarding their acoustic performance. Acoustic performance varies depending on the material selection for each wall.

They are made from sustainable materials such as recycled particleboard and PET, along with a soundproofing membrane that provides an acoustic performance of up to 28.9 dB (DsA). Additionally, the eco-friendly panels reduce and control sound reverberation within the Pavilion, further optimizing sound insulation.

### Key functions

- Sustainable materials
- Memory acoustic foam
- Easy clean material
- Odor free and antimicrobial

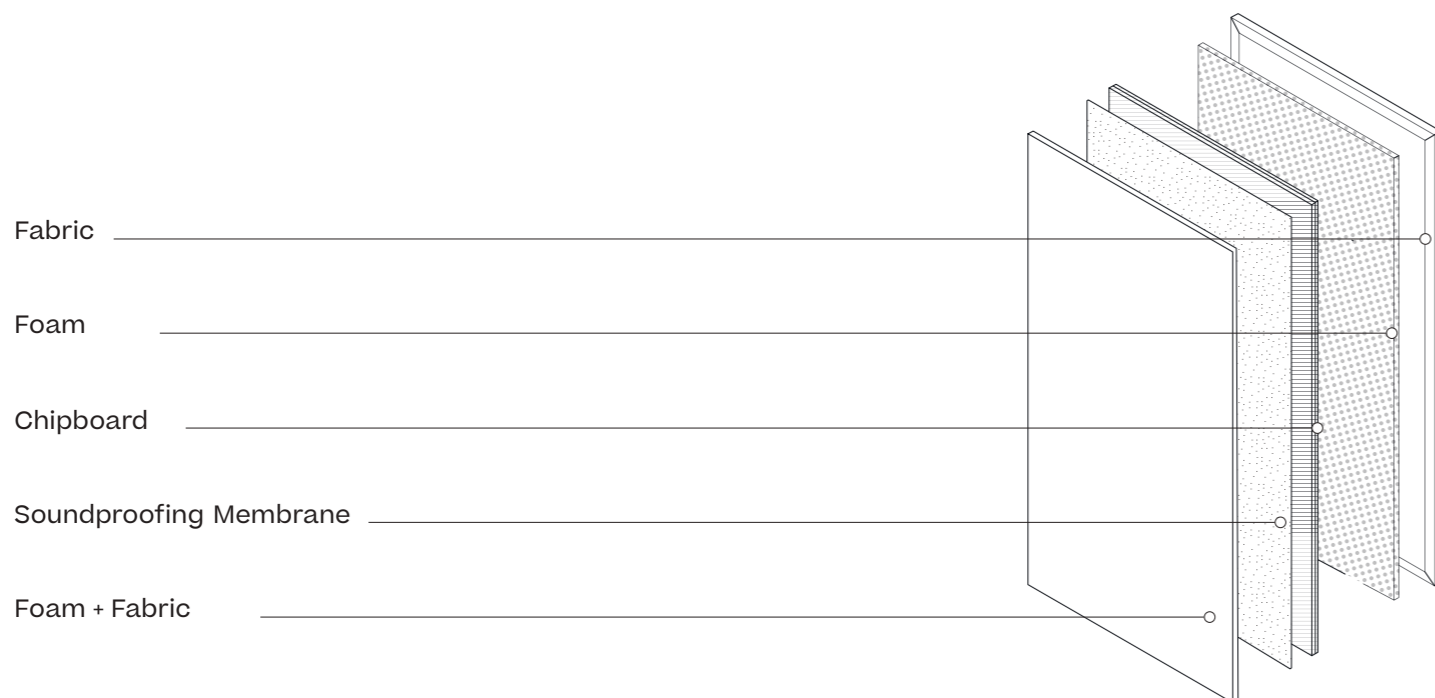

### Acoustic Panels

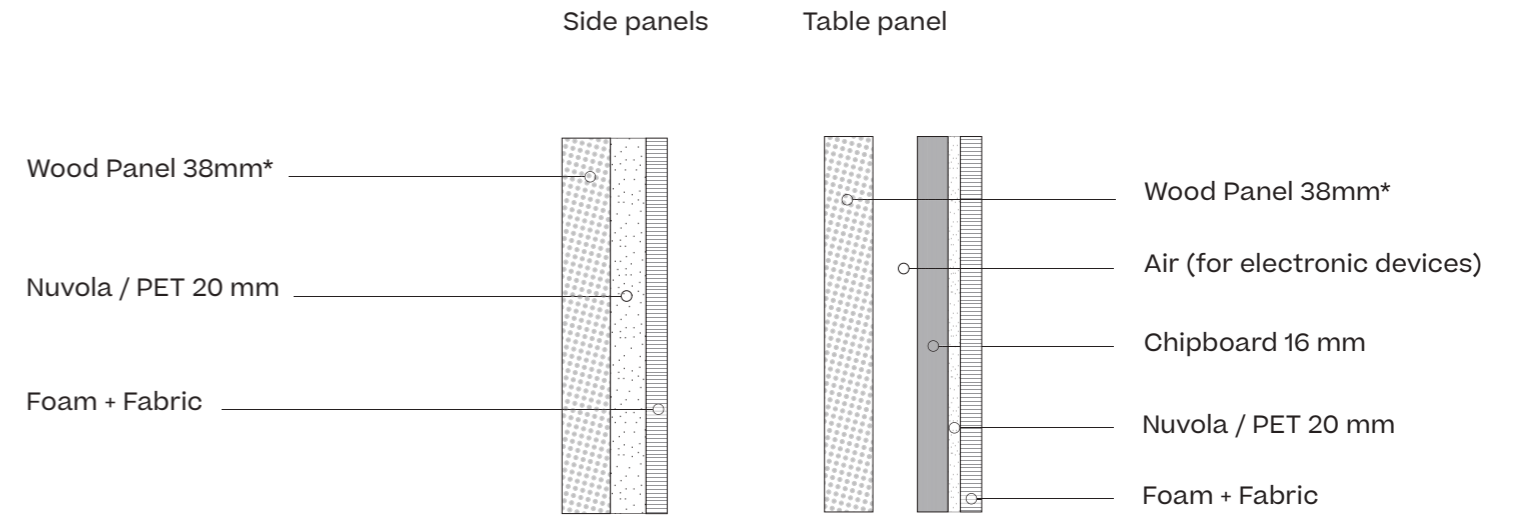

### Nuvola / PET Acoustic Ceiling

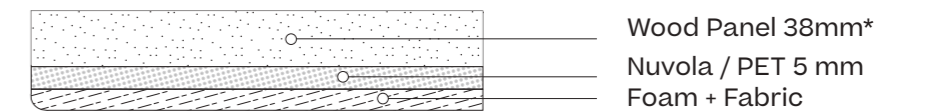

\*8mm Chipboard + 22mm honeycomb cardboard + 8mm chipboard

# Pavilion M, a modular structure to reinvent the workplace.

Many companies have adapted to the increasingly unpredictable market by creating agile organizational structures. To be agile, they also need office structures that can be easily reconfigured to suit ever-changing requirements. Pavilion M is the ideal structure solution for these new work environments.

The principal function of our Pavilion M is to provide a flexible way of dividing offices into zones while offering enclosed workspaces. It consists of an aluminum structure that can be built out with a variety of materials: glass, wood and fabric, as well as practical fittings: shelving, TV unit, whiteboards and bulletin boards. Our Pavilion M also allows for the integration of electrical cables and functional accessories that can be tailored to your company's specific needs.

Pavilion M facilitates the creation of countless office and workspace layouts that can be rapidly adapted to accommodate changes to your headcount or department functions. Thanks to its modular nature, the Pavilion M system gives you the power to respond quickly to the constantly changing modern world of work.

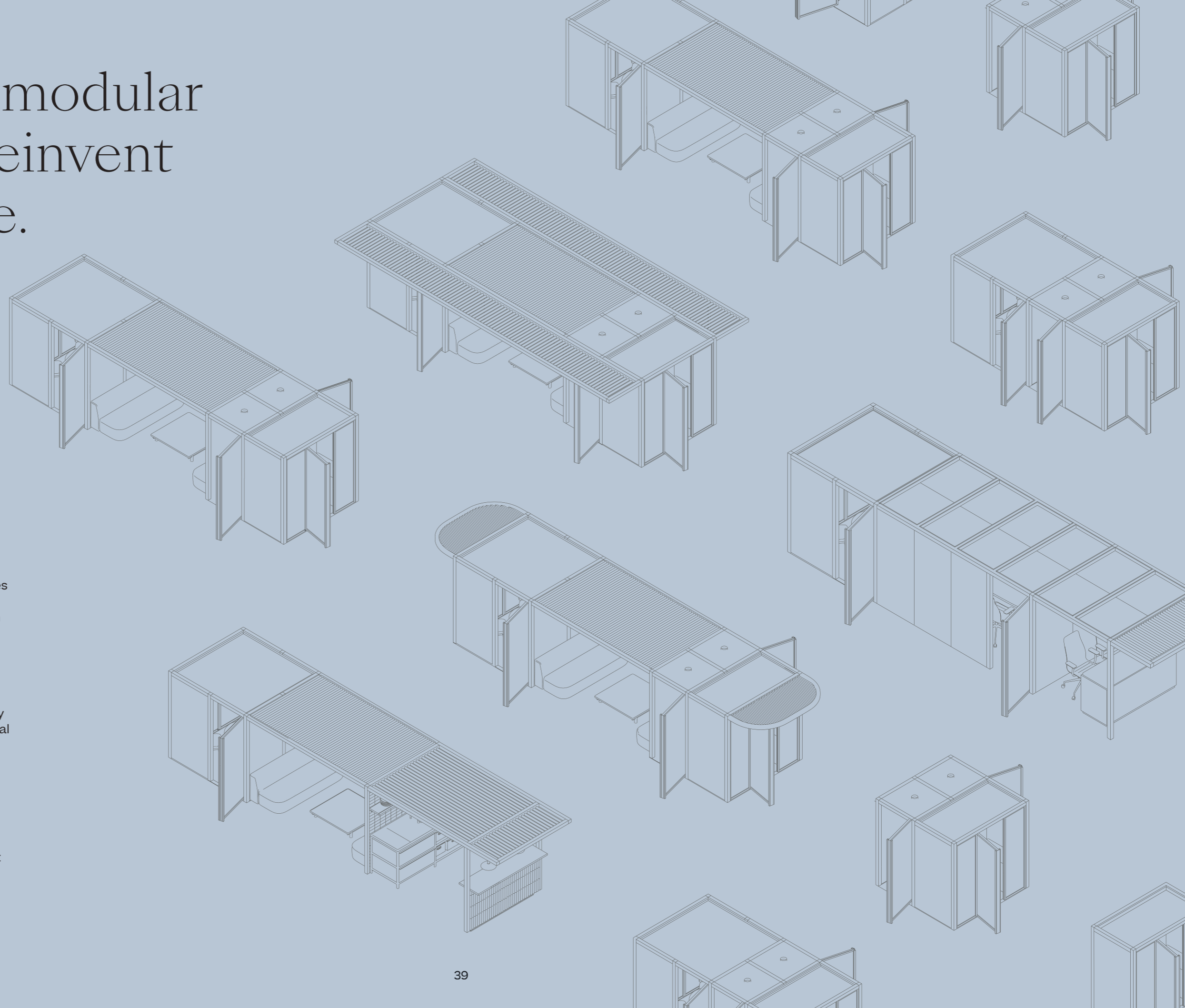

# Modularity

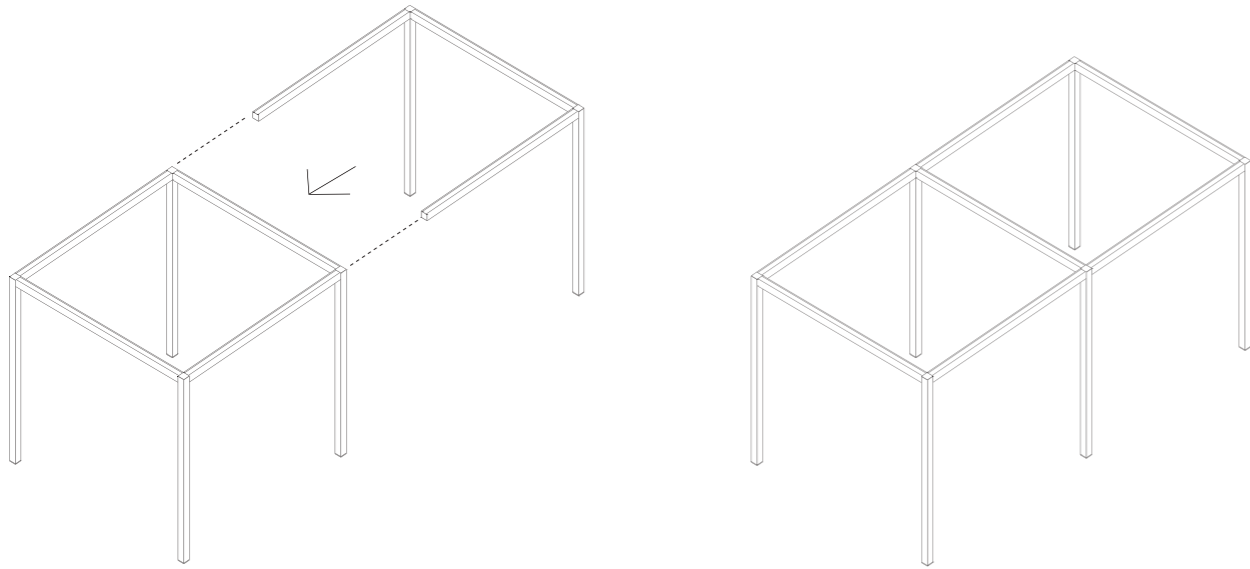

Pavilion M adapts to the context of any modern workspace. It is a dynamic way to transform your office space, thereby increasing productivity and creativity amongst your teams. It gives you the option to create several spaces; from one-person private rooms to those that can accommodate the entire team.

Your office can be set up in a variety of different configurations. The basic structure conforms to the grid layout commonly used in office planning and it has ceiling heights that can adapt to all environments.

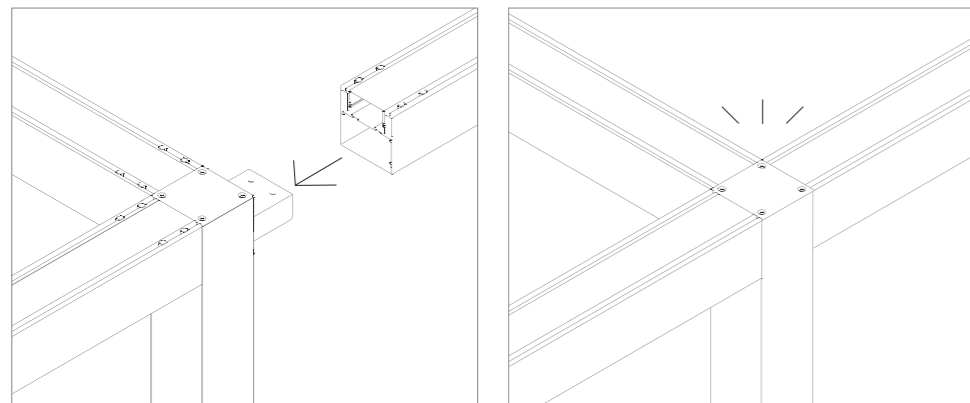

The ingenious square tube and corner connector system generates a sense of light and space.



Find out more

# Click & Work

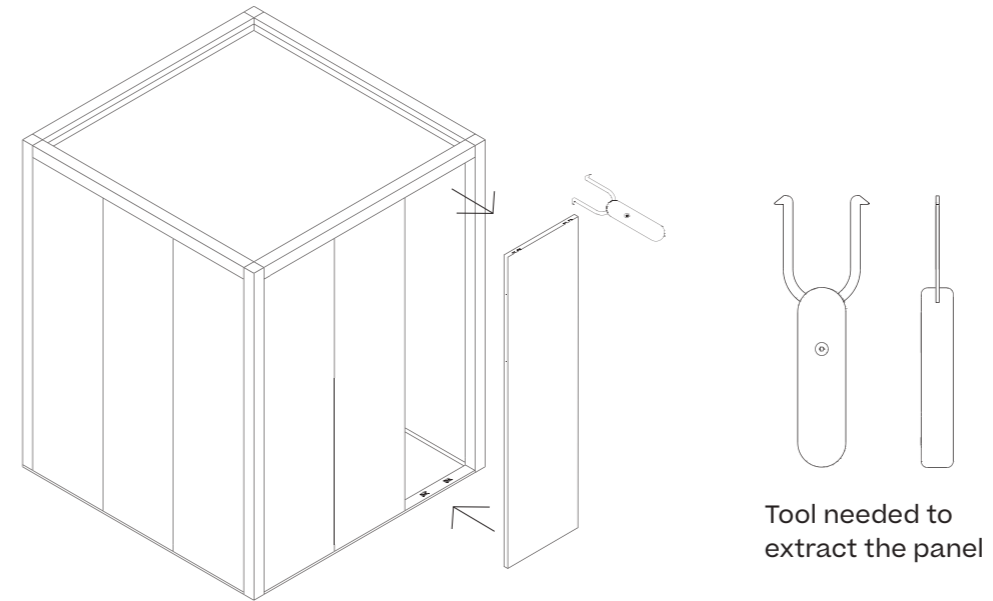

Tool needed to extract the panel

Our unique clipping system means you can transform your spaces to create your own mood ecosystems. Wall to wall or corner to corner, the scope for creating adaptable office spaces is limitless.

Configurations can be altered in a few hours to provide new spaces. A quick and easy installation demountable structure.

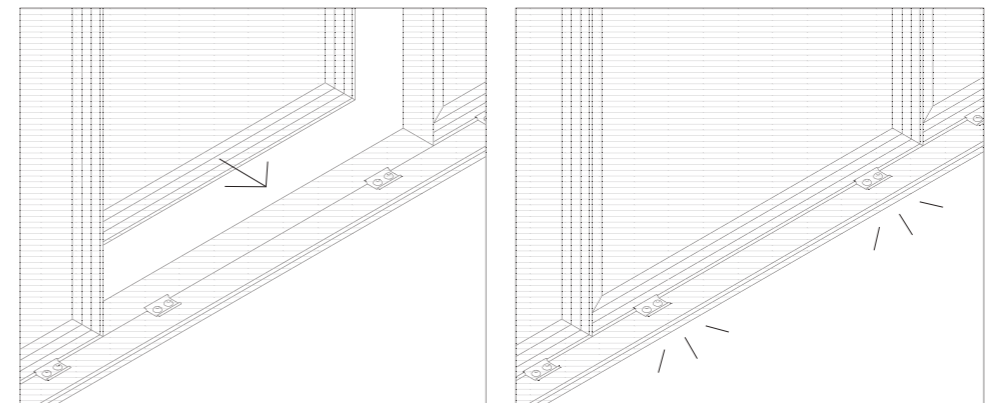

Find out more

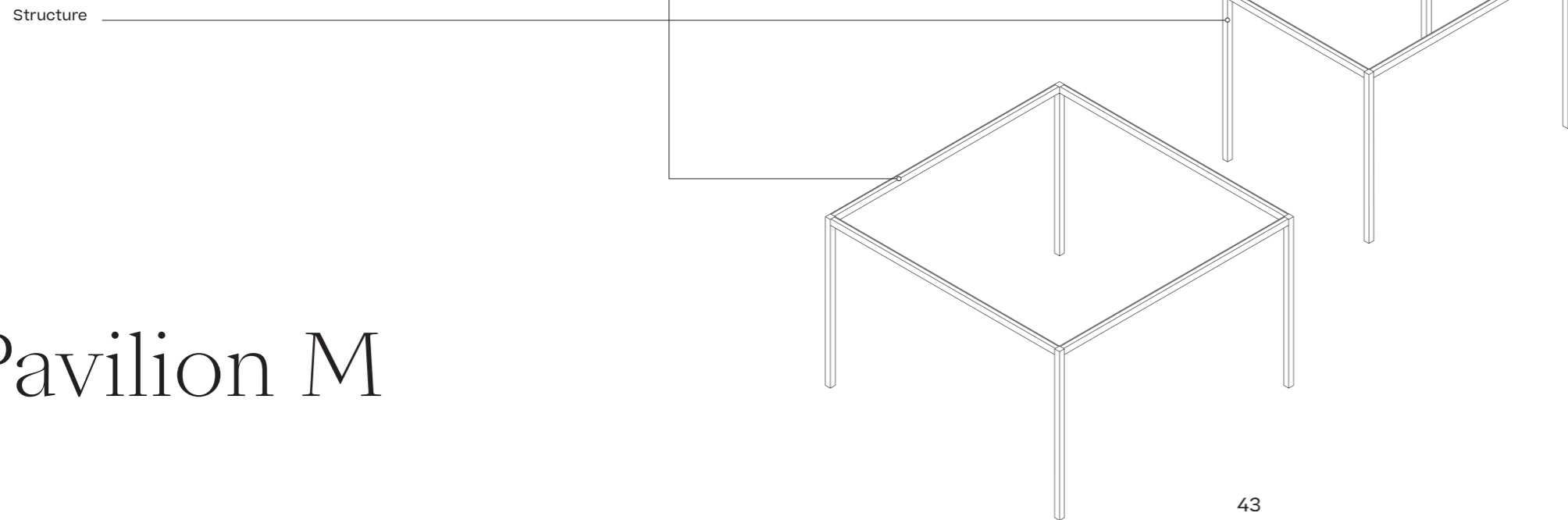
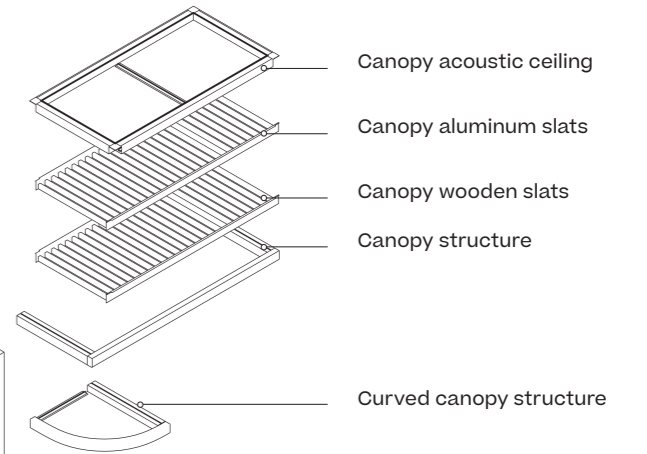
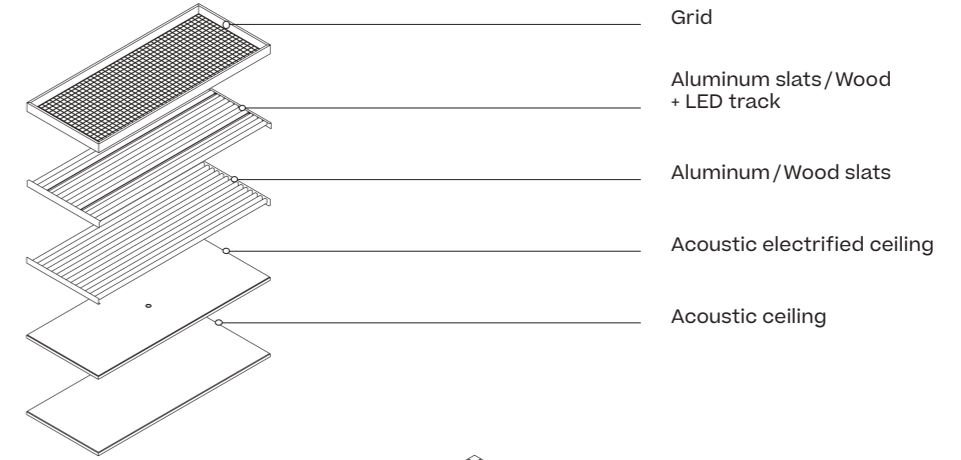
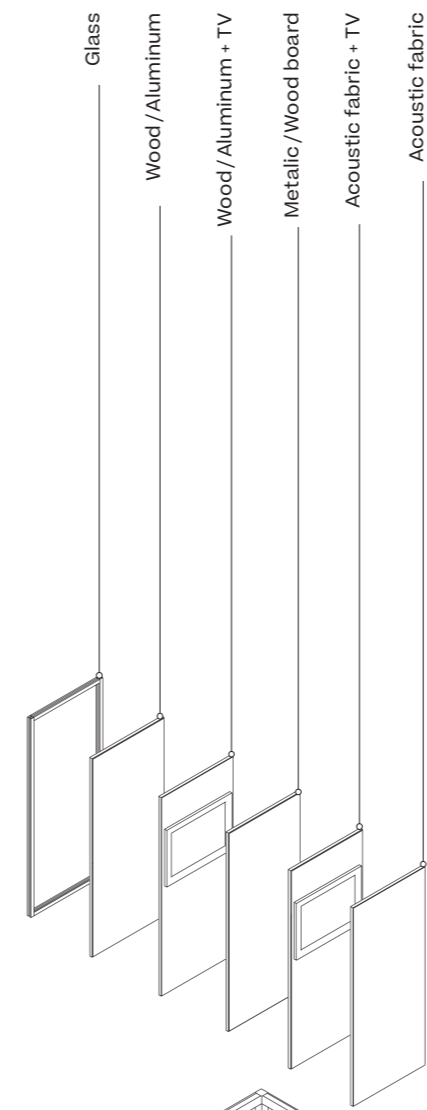
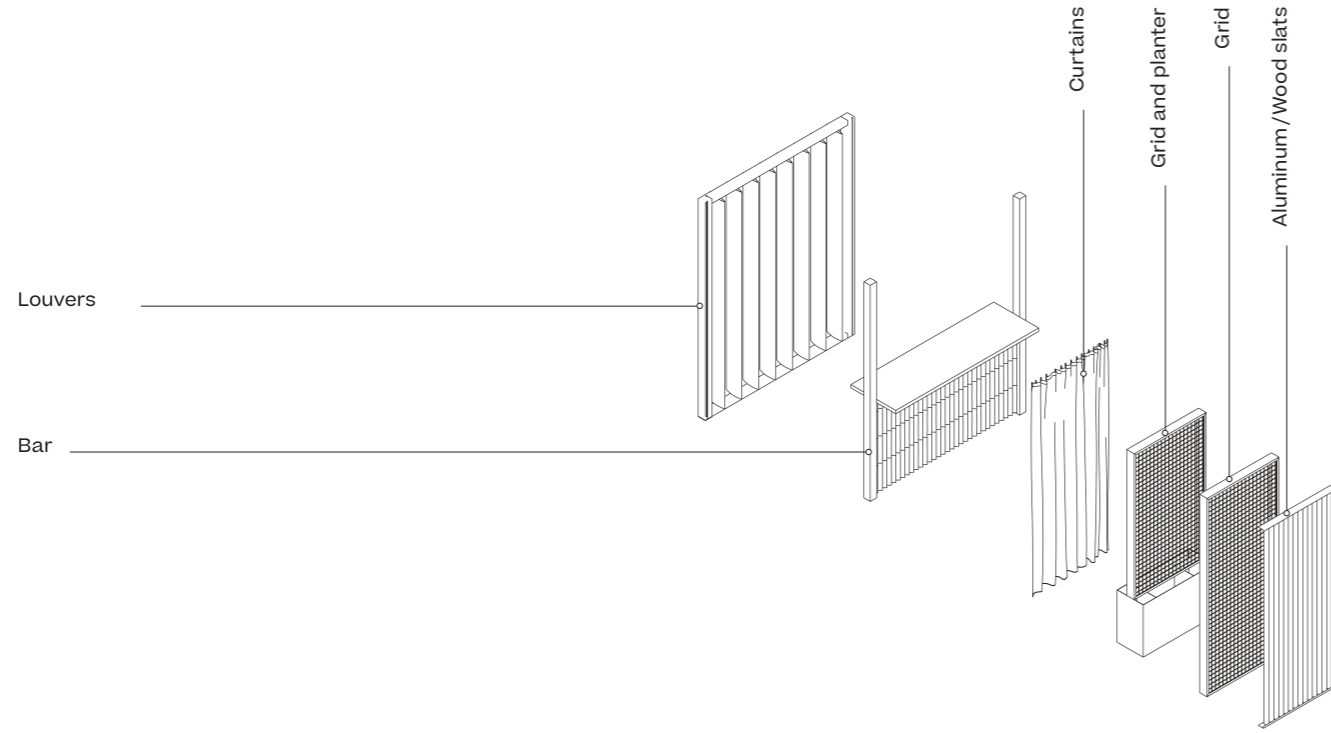

# Pavilion M

Side panels

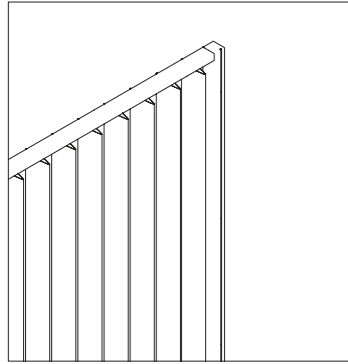

Louvers

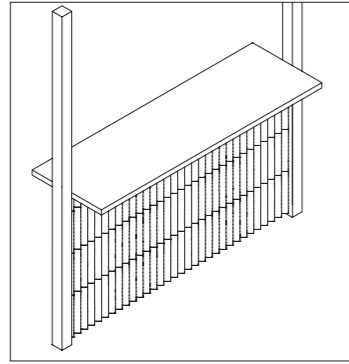

Bar

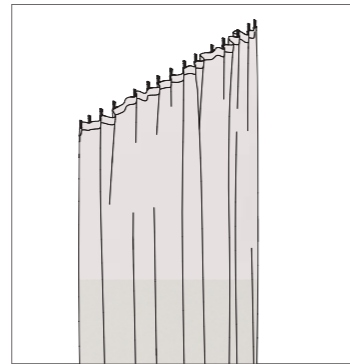

Curtains

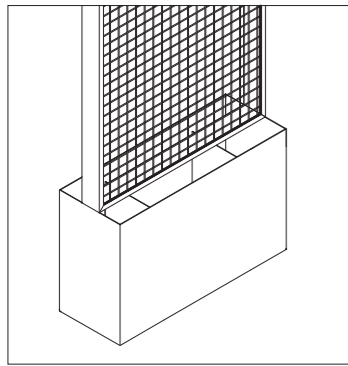

Grid with planter (1m)

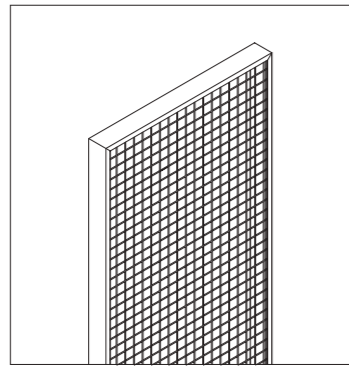

Grid (1m)

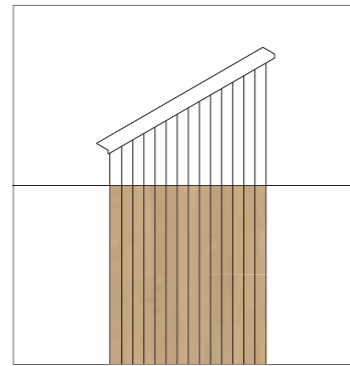

Aluminum / Wooden slats (1m)

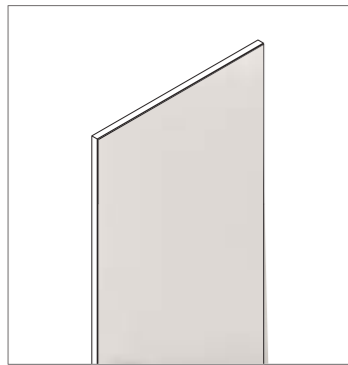

Acoustic fabric panels (1m)

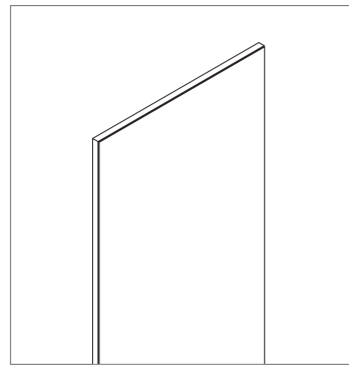

Metallic board (1m)

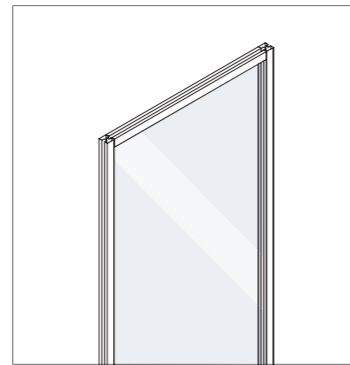

Glass (1m)

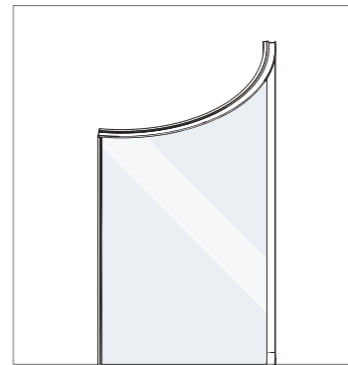

Curved Glass (1m)

Side accessories

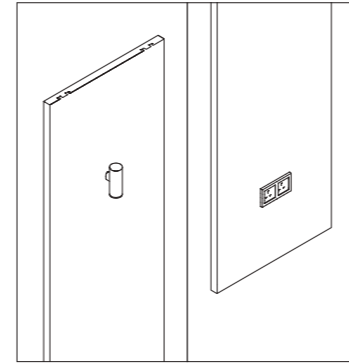

Light and plug

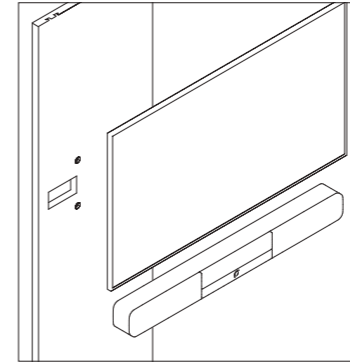

TV

Ceiling

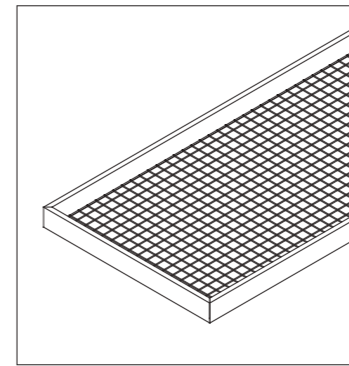

Grid

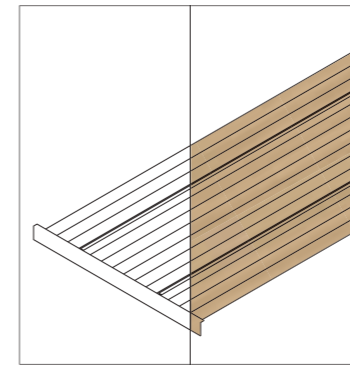

Aluminum or wooden slats with LED track

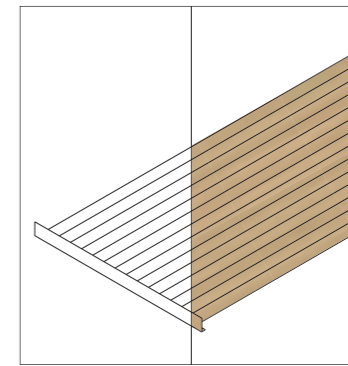

Aluminum / Wooden slats

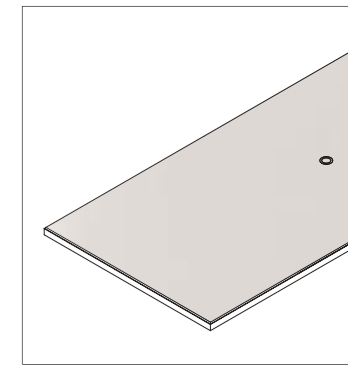

Acoustic electrified ceiling / Acoustic ceiling

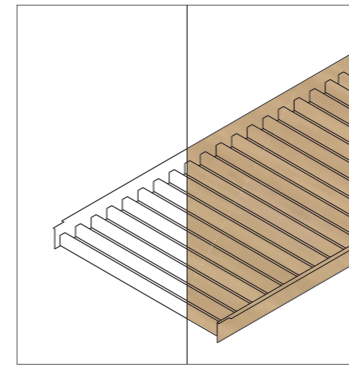

Canopy aluminum slats / Wooden slats

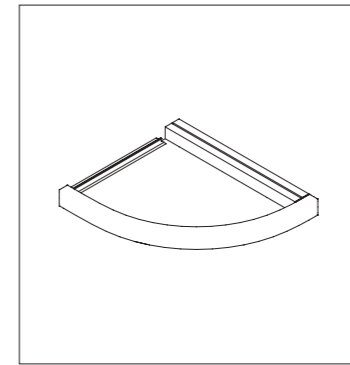

Curved canopy structure



Find out more







# Focus

Certain situations require your employees to increase their focus. It might be a meeting between them and a top client or it could be a puzzling problem that requires quiet analysis. Our system can help you create spaces that allow them to excel in such situations.

# Spaces tailored for those occasions when isolated work is required.

Kall

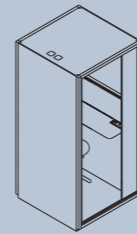

S

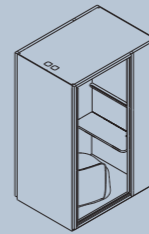

M

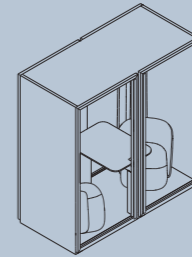

L

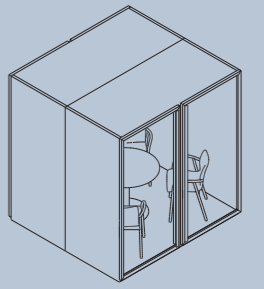

XL

Phone Booth M

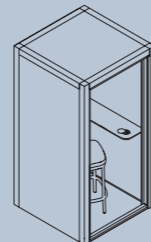

S

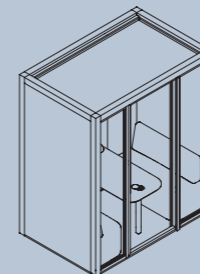

L

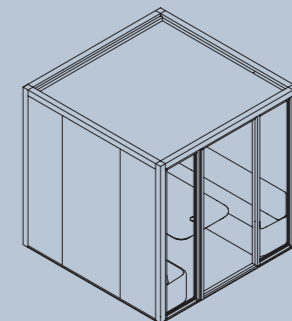

XL

# Phone Booth M, by Kettal studio

Privacy can be hard to come by in large open offices. Our Phone Booth M allows your employees to make calls or hold video conferences with unbroken focus and without disturbing the rest of the team. The Phone Booth M design is inspired by the traditional telePhone booth. They are an elegant yet functional solution for your office. Comfortable and echo-free, the Phone Booth M is also simple to install.









Phone booth M  
S

KSA219200

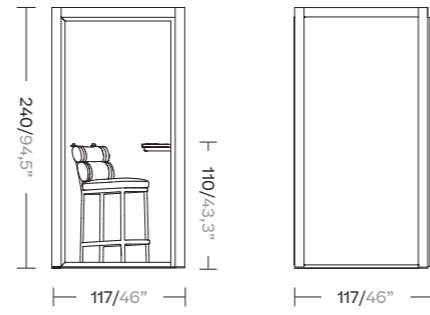

Phone booth M  
L

KSA219600

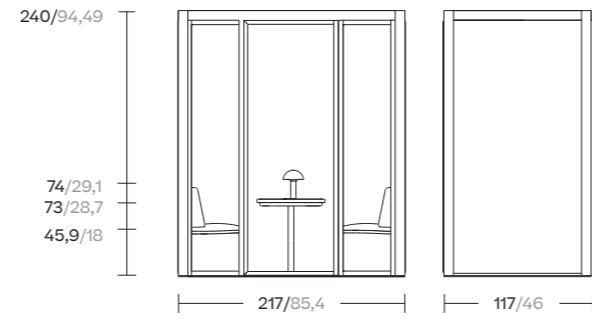

Phone booth M  
XL

KSA220000



Specifications

- 4+4 or 6+6 mm
- Pivot door
- Aluminium frame
- Acoustic panels
- Absorption system
- Fabric or glass
- Faced external wall
- Air ventilation system
- LED lighting
- PIR sensor



See video here



Table with Plug / USB- A / USB-C



Shelf + Led light + PIR



LED track curtain



Handicap flooring, pivoting door



Plug and play



Ventilation system



Crestron screen (optional)



Reconfigurable

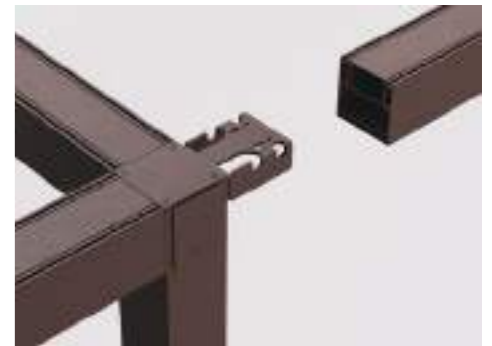

Modularity

# Phone Booth ADA

## Specifications

- 4+4 or 6+6 mm
- Automatic Pivot door
- Aluminium frame
- 5mm floor profile
- Acoustic panels
- Absorption system
- Fabric or glass
- Faced external wall
- Air ventilation system
- LED lighting
- PIR sensor



Specsheet (Pdf)



Phone booth  
ADA

KSA219200

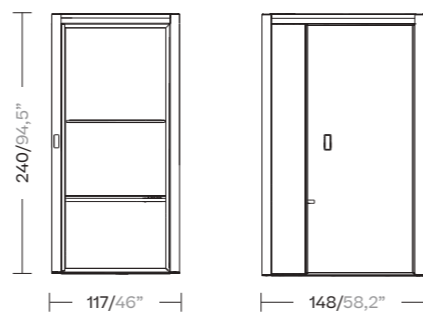

Adjustable table 700 to 1200 mm



Push button for opening



5mm floor profile, pivoting door



# Meeting

Comfort and silence means better communication and better meetings.

Whether it is a meeting with colleagues or clients, you want to optimize its effectiveness. Comfort is crucial — particularly when your meeting is long in duration. We recognize this and have designed accordingly. Our superior sound insulation provides a quiet, distraction-free environment for holding your meetings without disturbing those in the vicinity.

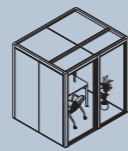

Meeting Room  
2 persons

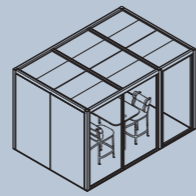

Meeting Room  
2/4 persons

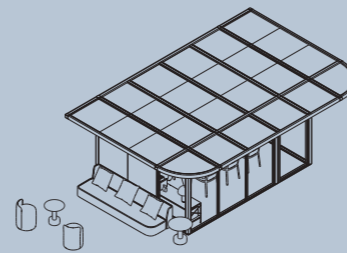

Meeting Room  
4/6 persons

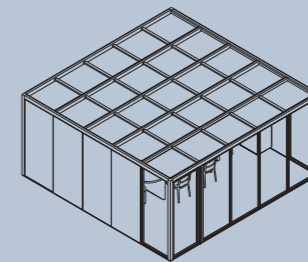

Meeting Room  
6/8 persons

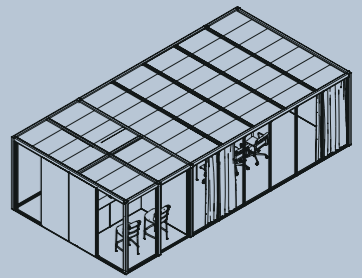

Meeting room  
Special sizes

# Meeting room 2 persons



## Description

A meeting room fitting 2 persons. You can sit down alone for a meeting with your clients or colleagues who are participating remotely. The exceptional acoustics and physical comfort allow for better communication, as well as concentration.

The adaptable system allows for the integration of additional open modules with different functions.

## Specifications

- 4+4 or 6+6 mm
- Pivot door
- Aluminium frame
- Acoustic panels
- Absorption system
- Fabric/Metal/Wood/Glass
- Faced external wall
- Air ventilation system
- LED lighting
- PIR sensor
- Adaptable and modular
- AV systems option
- Dimmable lights



# Meeting room 2/4 persons

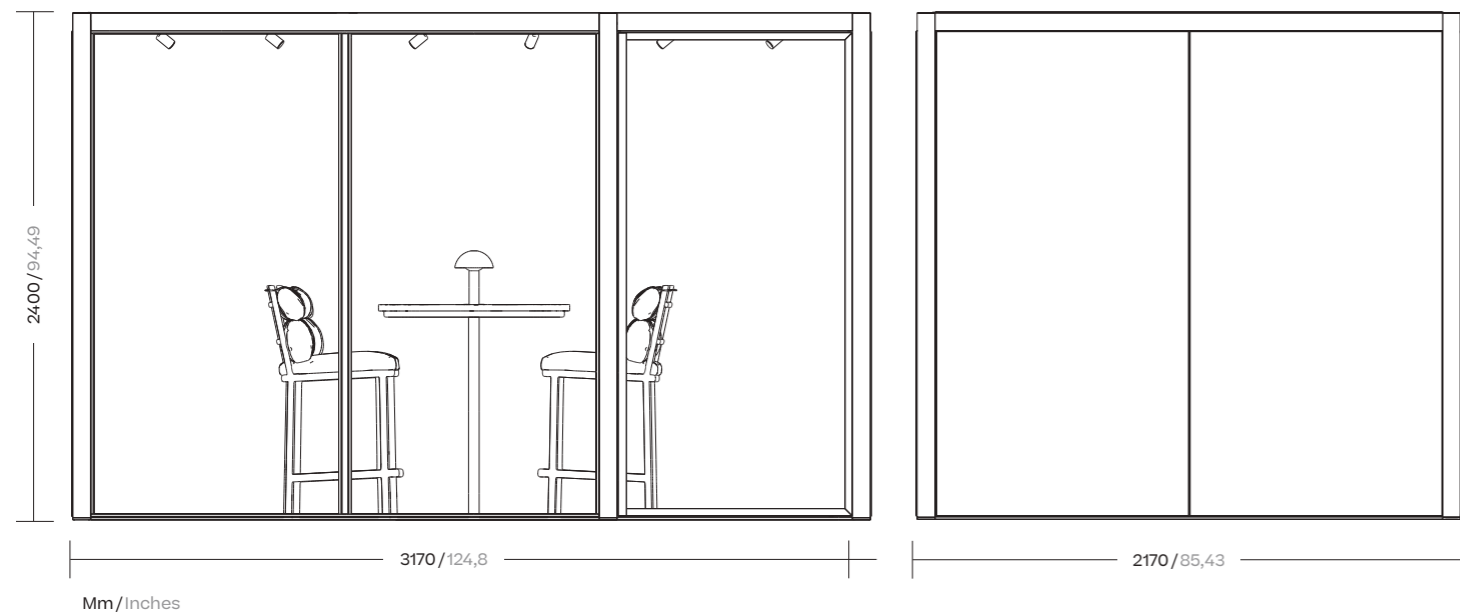

## Description

Gather with a group of up to four to conduct a meeting. The exceptional acoustics and physical comfort allow for better communication, as well as concentration.

The adaptable system allows for the integration of additional open modules with different functions.

## Specifications

- 4+4 or 6+6 mm
- Pivot door
- Aluminium frame
- Acoustic panels
- Absorption system
- Fabric / Metal / Wood / Glass
- Faced external wall
- Air ventilation system
- LED lighting
- PIR sensor
- Adaptable and modular
- Dimmable lights
- AV systems option





# Meeting room 4/6 persons

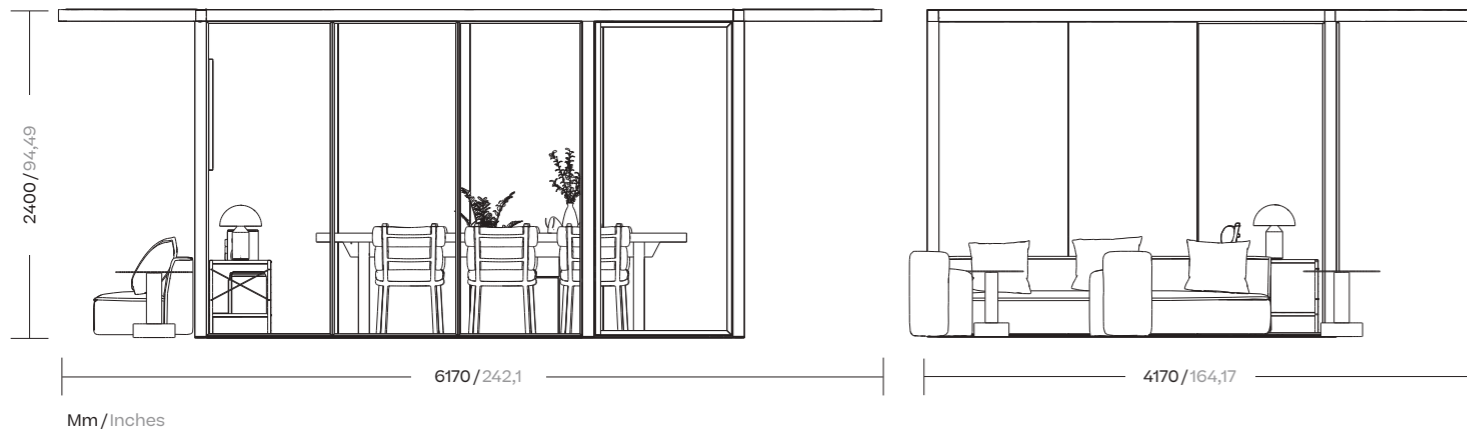

## Description

A meeting room that can accommodate up to 6 persons. The exceptional acoustics and physical comfort allow for better communication, as well as concentration.

The adaptable system allows for the integration of additional open modules with different functions.

## Specifications

- 4+4 or 6+6 mm
- Pivot door
- Aluminium frame
- Acoustic panels
- Absorption system
- Fabric/Metal/Wood/Glass
- Faced external wall
- Air ventilation system
- LED lighting
- PIR sensor
- Adaptable and modular
- Dimmable lights
- AV systems option





# Meeting room 6/8 persons



Video here



## Description

A meeting room for up to 8 persons. The exceptional acoustics and physical comfort allow for better communication, as well as concentration.

The adaptable system allows for the integration of additional open modules with different functions.

## Specifications

- 4+4 or 6+6 mm
- Pivot door
- Aluminium frame
- Acoustic panels
- Absorption system
- Fabric/Metal/Wood/Glass
- Faced external wall
- Air ventilation system
- LED lighting
- PIR sensor
- Adaptable and modular
- Dimmable lights
- AV systems option







# Meeting room Special size

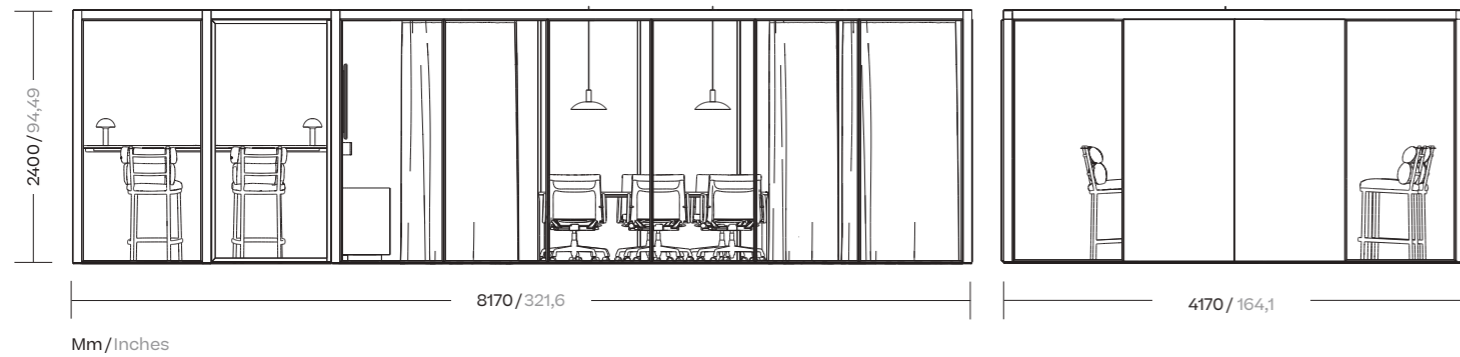

## Description

A meeting room accommodating up to 10 persons. The exceptional acoustics and physical comfort allow for better communication, as well as concentration.

The adaptable system allows for the integration of additional open modules with different functions.

## Specifications

- 4+4 or 6+6 mm
- Pivot door
- Aluminium frame
- Acoustic panels
- Absorption system
- Fabric/Metal/Wood/Glass
- Faced external wall
- Air ventilation system
- LED lighting
- PIR sensor
- Adaptable and modular
- Dimmable lights
- AV systems option







# Hub

# Hybrid structures to connect your staff in a social way.

Hub offers you a third-space within your actual office space. Your employees can mingle for chats, impromptu brainstorming sessions or perhaps a quick coffee after an intense meeting with a top client. The flexibility of our Hub system enables you to create scenes that complement whatever vision you have for your office culture.

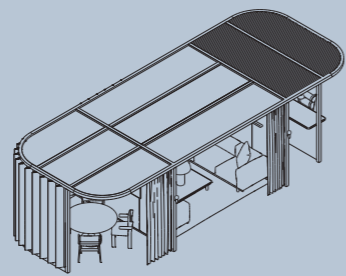

Hub Curved

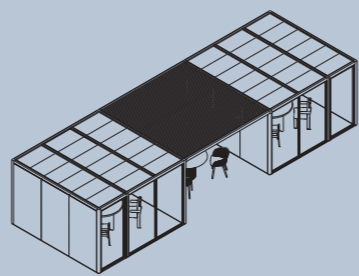

Hub Walk Through

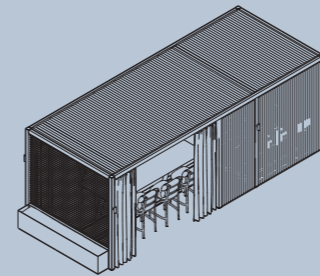

Hub Open  
With Meeting & Sofas

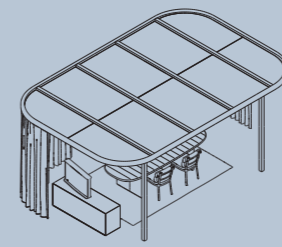

Hub Open  
With Curtains

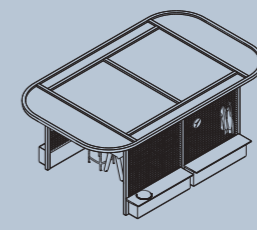

Hub Open

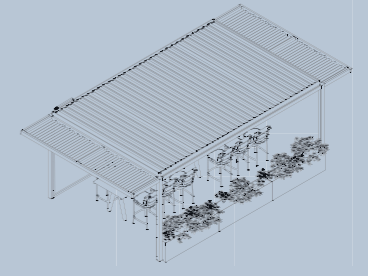

Hub Outdoor

# Hub Curved

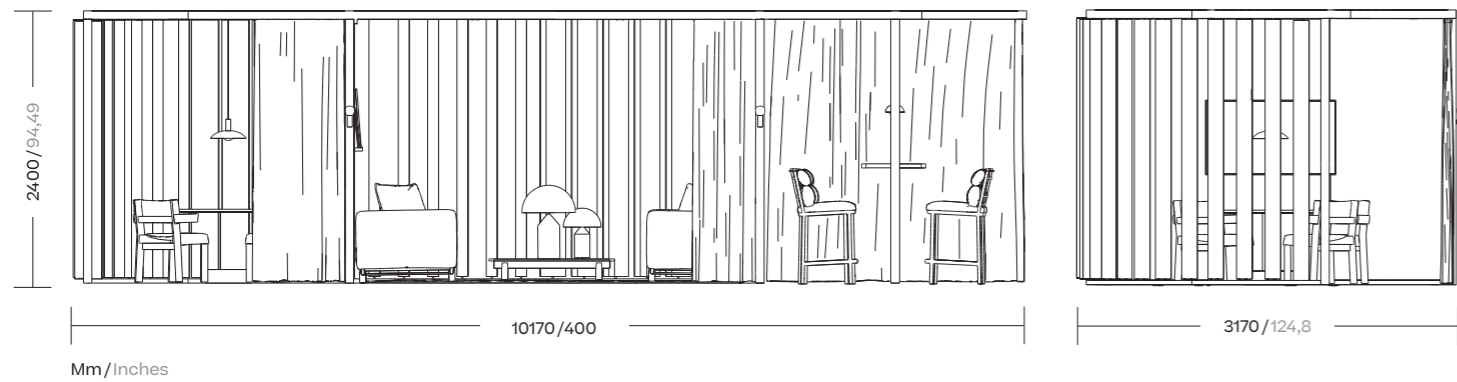

## Description

Three zones under one roof. Whether it is for sitting, meeting or taking a break, this curved structure will suit a variety of casual or impromptu interactions.

## Specifications

- 4+4 or 6+6 mm
- Pivot door
- Aluminium frame
- Acoustic panels
- Absorption system
- Fabric/Metal/Wood
- /Glass
- Faced external wall
- Air ventilation system
- LED lighting
- PIR sensor
- Adaptable and modular
- Dimmable lights
- AV systems option







# Hub Walk Through

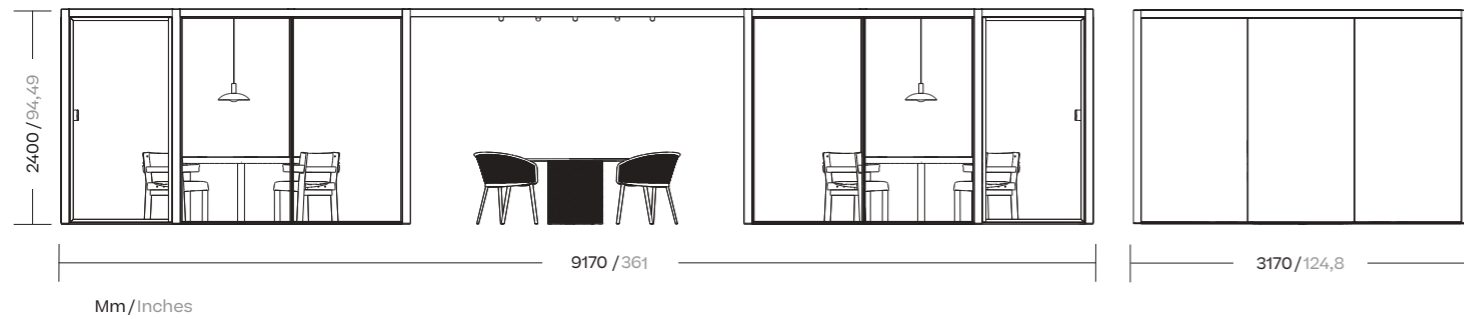

## Description

Two spacious meeting rooms on either side of a more casual open gathering point. Suitable for either formal or relaxed interactions.

## Specifications

- 4+4 or 6+6 mm
- Pivot door
- Aluminium frame
- Metal frame
- Acoustic panels
- Absorption system
- Fabric / Metal / Wood / Glass
- Faced external wall
- Air ventilation system
- LED lighting
- PIR sensor
- Adaptable and modular
- Dimmable lights
- AV systems option





# Hub Open

## With meeting & Sofas

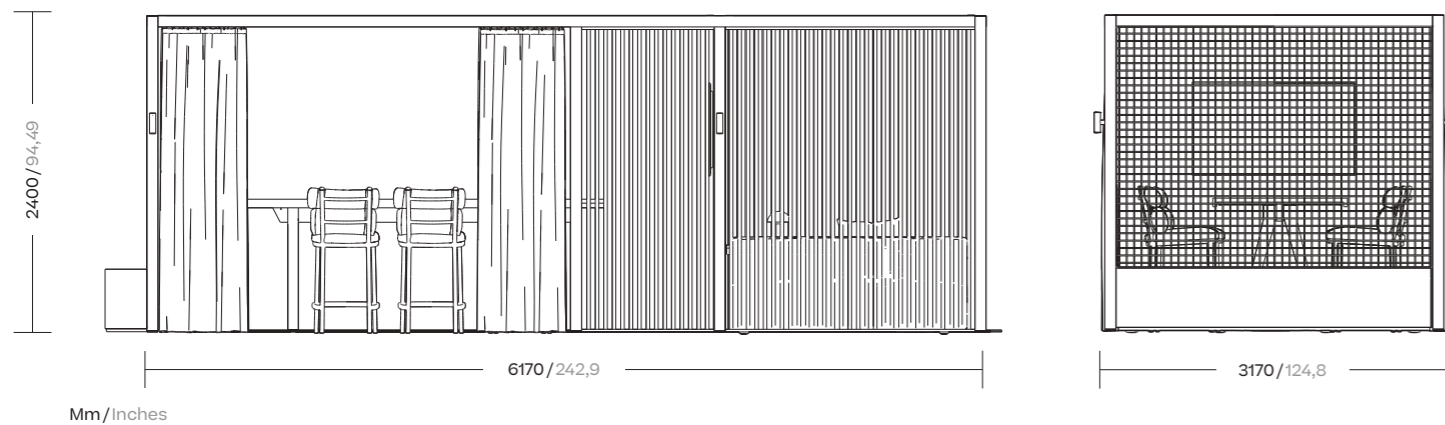

### Description

A six-person, high-table discussion space attached to a sofa area. Suitable for a variety of semi private gatherings.

### Specifications

- Metal frame
- Acoustic panels
- Absorption system
- Fabric/Metal/Wood/Ceramic/Glass
- Faced external wall
- Air ventilation system
- LED lighting
- PIR sensor
- Adaptable and modular
- Dimmable lights
- AV systems option





# Hub Open

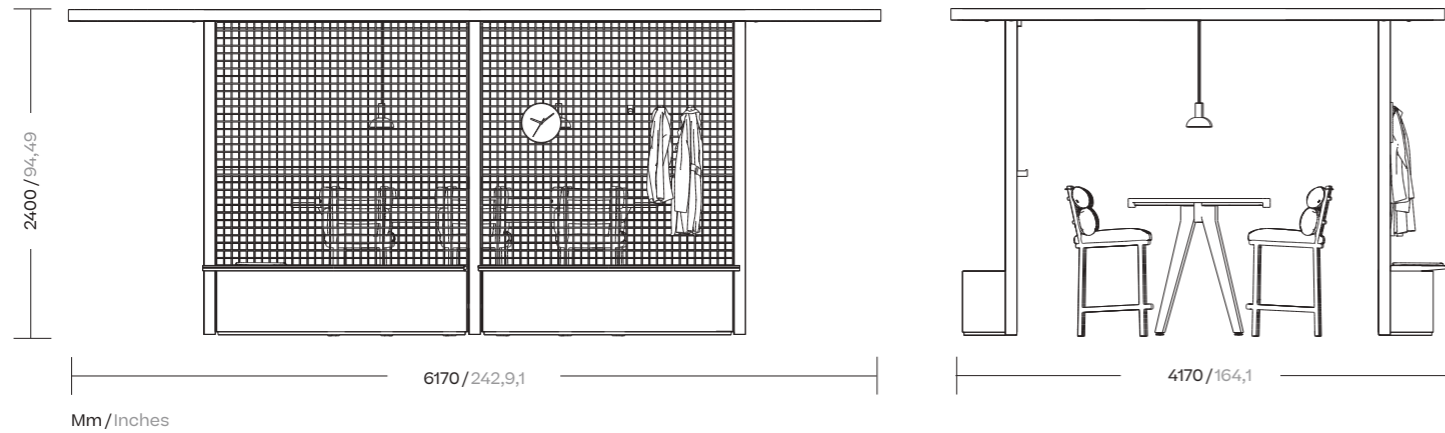

## Description

An open and creative space, ideal for brainstorming on the go. Includes a small bench at the rear.

## Specifications

- 4+4 or 6+6 mm
- Pivot door
- Aluminium frame
- Metal frame
- Acoustic panels
- Absorption system
- Fabric / Metal / Wood / Ceramic / Glass
- Faced external wall
- Air ventilation system
- LED lighting
- PIR sensor
- Adaptable and modular
- Dimmable lights
- AV systems option





# Hub Open With Curtains

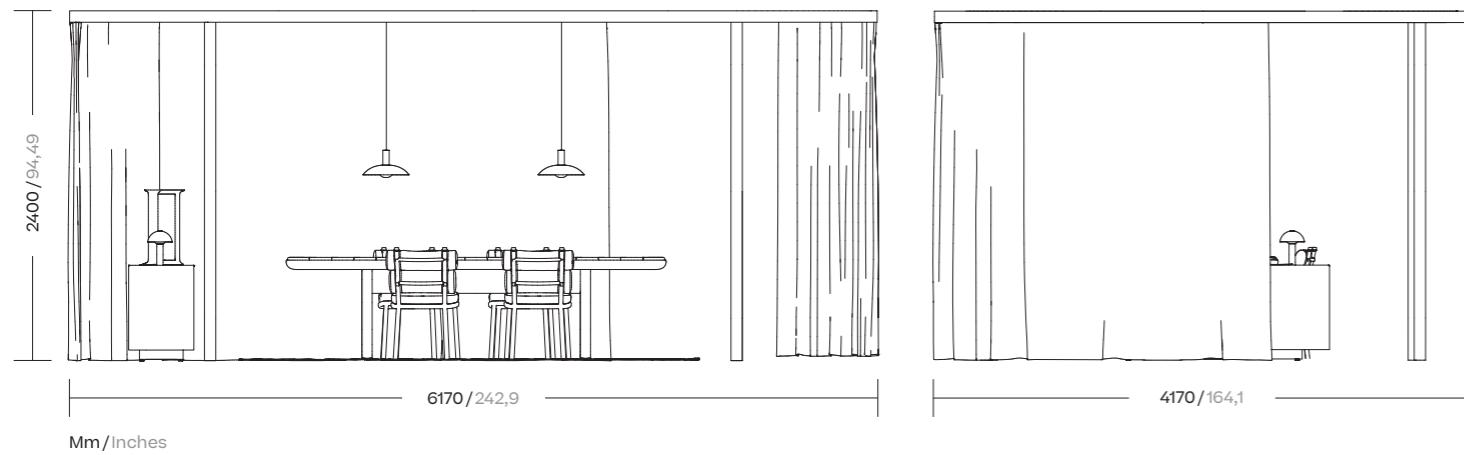

## Description

An open meeting space with curtains that add an atmospheric, living room-like comfort. Suitable for a small group to meet in a relaxed fashion.

## Specifications

- Aluminium frame
- Metal frame
- Fabric / Metal / Wood / Glass
- Faced external wall
- Air ventilation system
- LED lighting
- PIR sensor
- Adaptable and modular
- Dimmable lights
- AV systems option

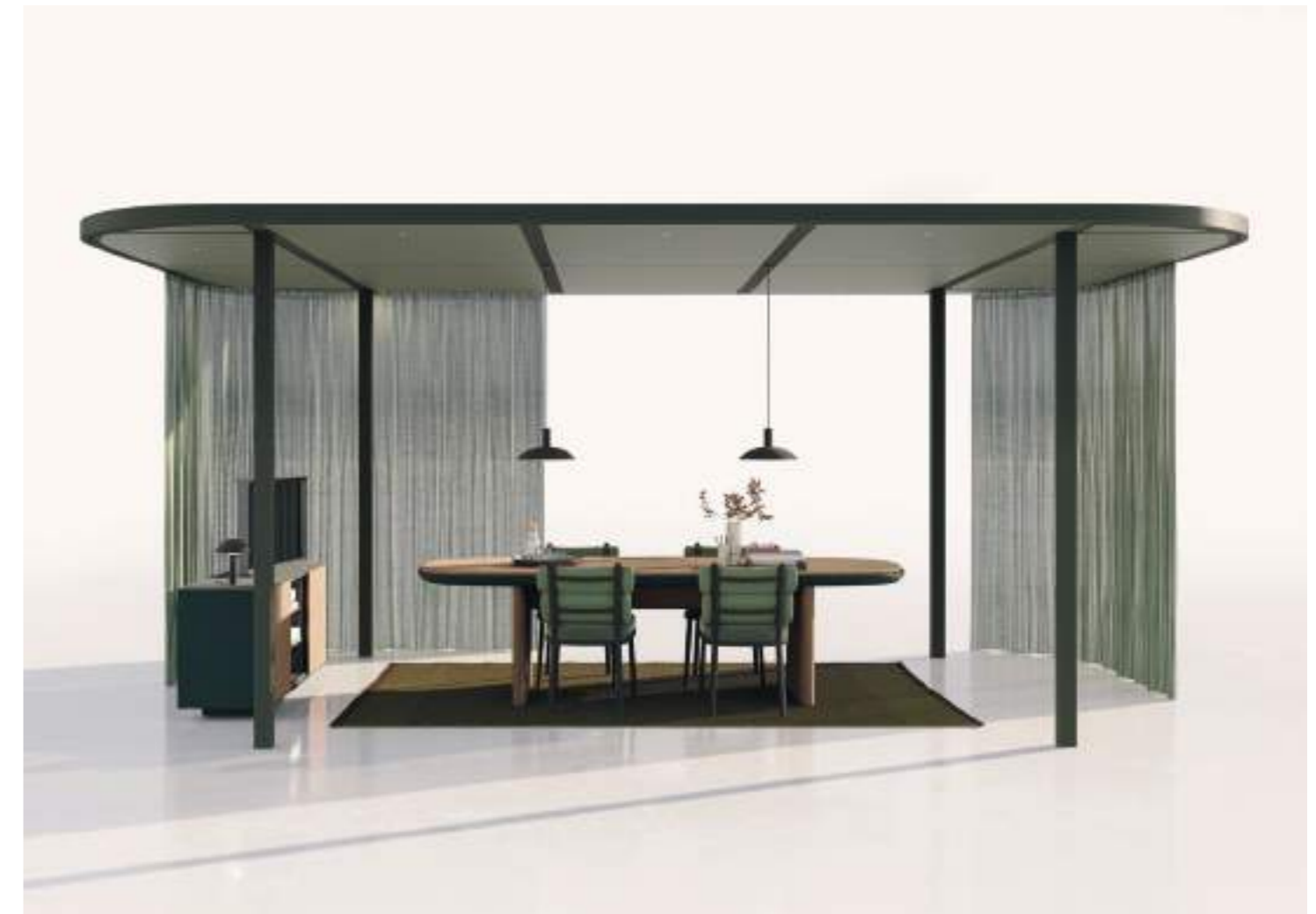

# Hub Outdoor

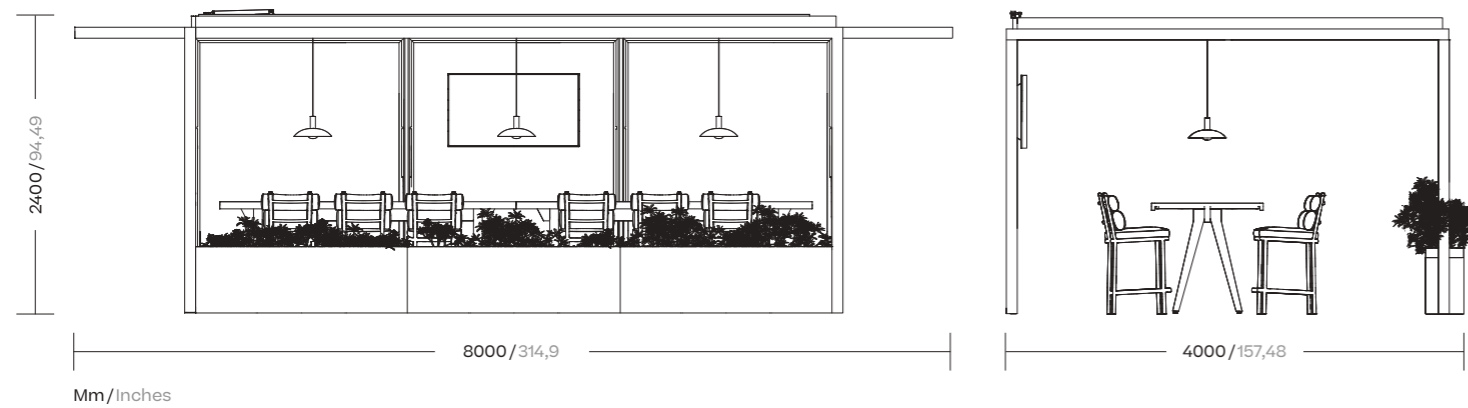

## Description

We designed the pavilion from the perspective of adaptability and it is therefore extremely versatile. It can be integrated not only with indoor spaces but also with outdoor ones. Its flexible and modular structures enable it to be used as a large shade and even for the creation of covered walkways.

## Specifications

- Pavilion H profile
- Aluminium frame
- Accesories
- Fabric, glass, wood, stone
- LED lighting
- PIR sensor





# Support

Functional spaces that support the smooth running of your business.

From receptions and printing areas to kitchens and lockers, there are additional areas that every modern office is expected to have. We have designed structures that can provide for all of these support areas in a most stylish way.

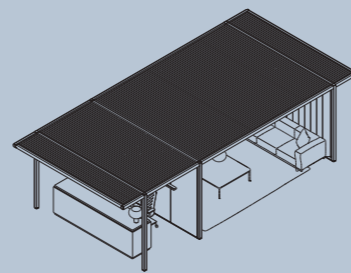

Reception & Lounge

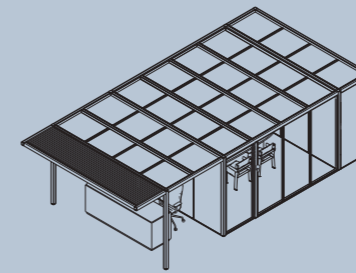

Reception With Meeting & Printing Area

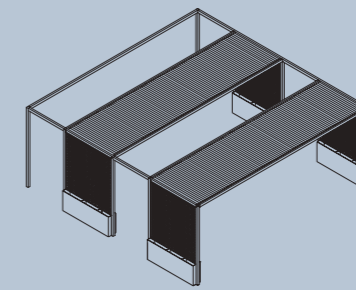

Lockers

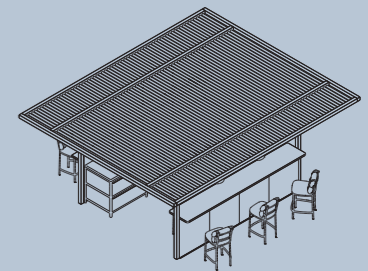

Kitchen

# Reception

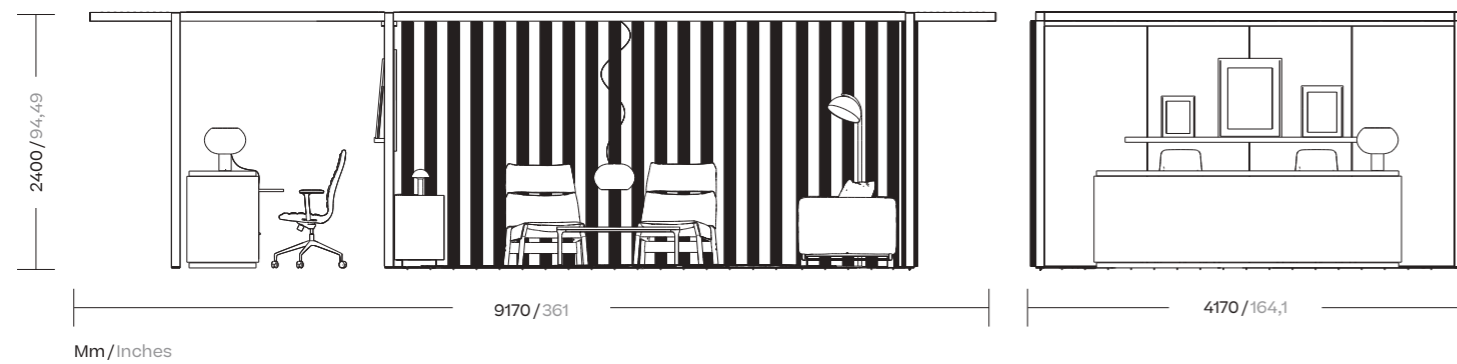

## Description

A sleek reception and waiting area that also impresses visiting clients.

## Specifications

- 4+4 or 6+6 mm
- Pivot door
- Aluminium frame
- Acoustic panels
- Absorption system
- Fabric or glass
- Faced external wall
- Air ventilation system
- LED lighting
- PIR sensor





# Reception With Meeting & Printing Area

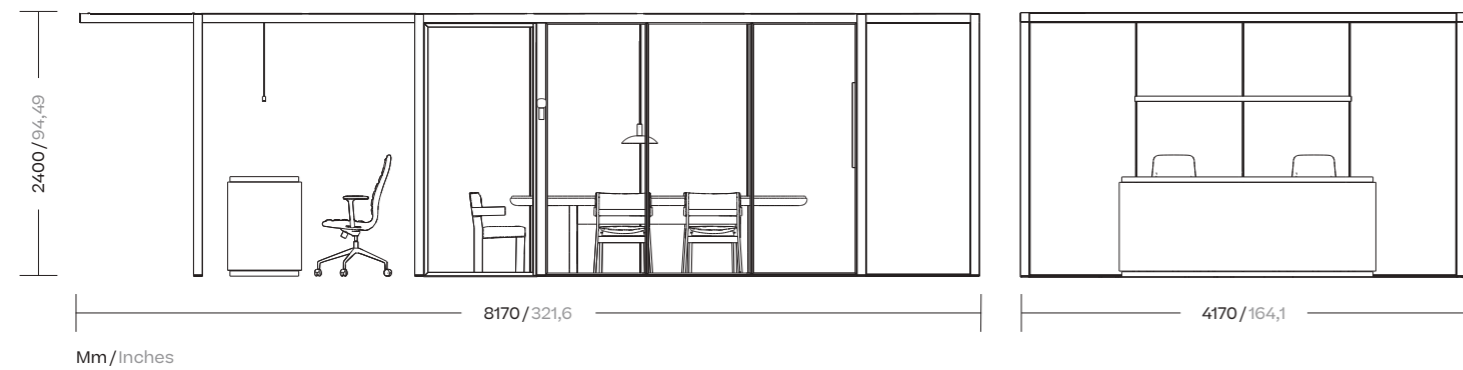

## Description

A dedicated printing area that neighbors a smart reception and spacious meeting room to support your business operations.

## Specifications

- 4+4 or 6+6 mm
- Pivot door
- Aluminium frame
- Acoustic panels
- Absorption system
- Fabric or glass
- Faced external wall
- Air ventilation system
- LED lighting
- PIR sensor







# Lockers

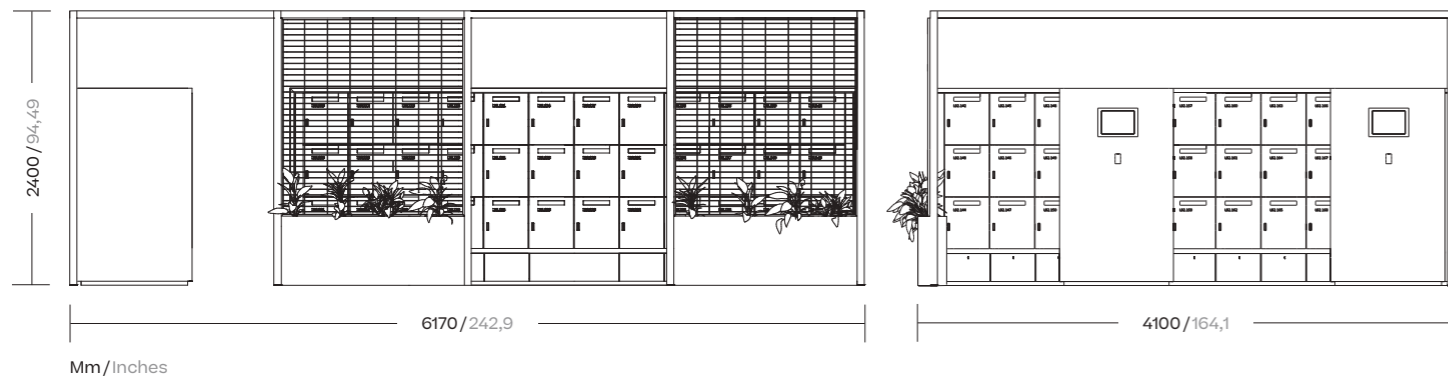

## Description

A convenient locker area to support your employees and their lifestyles.

## Specifications

- 4+4 or 6+6 mm
- Pivot door
- Aluminium frame
- Acoustic panels
- Absorption system
- Fabric or glass
- Faced external wall
- Air ventilation system
- LED lighting
- PIR sensor





# Kitchen



## Description

A clever and open kitchen to support your employees while they recharge and interact with each other.

## Specifications

- 4+4 or 6+6 mm
- Pivot door
- Aluminium frame
- Acoustic panels
- Absorption system
- Fabric or glass
- Faced external wall
- Air ventilation system
- LED lighting
- PIR sensor





# Lighting

A space cannot be designed without careful consideration of lighting. For this reason, we have created a new language of light, from the ground up, that elegantly integrates into the architecture.

We are not just another lighting company. But we know an adequate amount of light and a clever placement improves mood and energy levels, which is essential to consider in the well running of the workspace.

# Elegantly integrated lighting that rounds out your workspaces.

This lighting system is adaptable to all situations: conversation, concentration, relaxation and more. Form, function and performance is driving the fusion of technology and emotion.

# Lighting



Dots Pendant

Magnetic and adjustable hanging lamp (48v) or ceiling-recessed lamp (24V)



Dots Pendant Open/Close

Magnetic and adjustable hanging lamp (48v) or ceiling-recessed lamp (24V)



Dots Articulated

Magnetic and adjustable hanging lamp (48V).



Dots Light Down/Up

Column lamp with accessories and options.



Led Track

Magnetic and adjustable with 48V rail integration.



Led Track Curtain

This linear, homogeneous lighting is integrated with the low-voltage track for the side panels.



# Dots Pendant



## Lighting

This suspended light is based on the Dots spotlight system. With its two open and closed diffusers, it directs most of the light downwards. By directing most of the light downwards, the shade is molded to illuminate spaces while protecting peoples' eyes from any direct glare. The matte white interior of the elliptical shade helps create a uniform light that is ideal for both directed and general ambient lighting needs.



# Technical specifications

Since the introduction of computers, office structures and work habits have never undergone such a radical transformation as the one we are currently experiencing. Thanks to communication technology, offices are becoming public spaces. Many companies create open-plan and inspiring places in which employees and visitors can relax, hold meetings or spend the day working. The daily use of laptops, smartphones and tablets has given rise to new patterns of behavior that are now also observed in offices. Home automation, audiovisual media, network connections and booking rooms are necessary resources for day-to-day work in the office.

# Unlock extra workspace potential with cutting edge technology.

# Air ventilation

## Key functions

- Silent air circulation system
- Intelligent monitoring through CO2, humidity and temperature sensors (optional)
- Equipment has particle filtration and microorganism elimination by germicidal ultraviolet light (optional)
- **Climate building system compatibility**
- Prefilter M5 (65% efficiency 0,3 micron particules)
- Absolute HEPA Filter (99,97% efficiency on 0,3 micron particules. (optional)
- CPZ filter for gas and odor removal (activated Carbon, Potassium Permanganate and Zeolite, efficiency greater than 90%) (optional)

## Air Ventilation values

Room dimensions	Fan box	Air Flow m <sup>3</sup> /h	Renewals
2 X 3	1	384,19	26,68
2 X 4	2	768,38	40,02
3 X 3	2	768,38	35,57
3 x 4	3	1152,58	40,02
3 x 5	4	1536,77	42,69
4 x 4	3	1152,58	30,02
4 x 5	4	1536,77	32,02
5 x 5	6	2305,15	38,42



Room Flow air conditioning

# Connection

## Description

The electrical system within the Pavilion M is designed to be discreet, elegant and practical. Embedded in the structure, it is easily accessible and is thought within the design.



Control center



Socket End points



Pavilion connection point

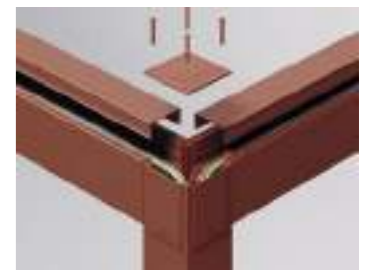

Easy access in-wall wiring

# Acoustic side panels 44 db

## Description

All our panels are tested to ensure they meet the required acoustic levels. We have tested some of the wall combinations to provide guidelines with regard to acoustic levels. Acoustic performance varies depending on the material selection for each wall.

The M glass version offers excellent acoustic performance, creating a comfortable and efficient working environment. It is based on 6+6 laminates with a soundproofing membrane to provide an impressive acoustic performance of up to 44dB. We also offer a range of solid wall options in fabric and wood. Many of these alternative wall options offer excellent acoustic performance properties. Our laminated panels not only provide additional acoustic performance, but also come in a range of colors. As a result, you can customize your Pavilion M to reflect your brand image or simply to create a bright office space. In addition, the eco-friendly panels reduce and control reverberated noise within the Pavilion, further enhancing the overall soundproofing performance.

## Key functions

- Fire retardant M1
- Memory acoustic foam
- Easy clean material
- Odor free and antimicrobial

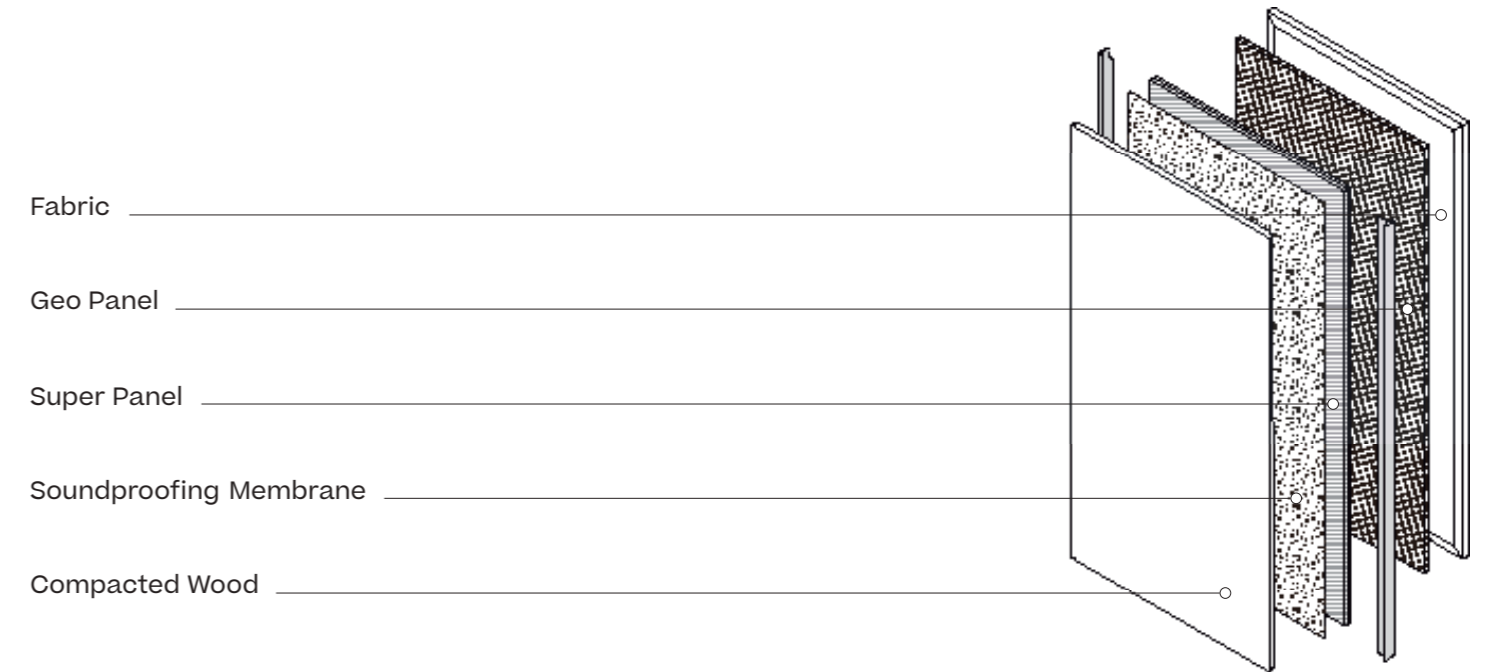

## Acoustic Panel (44 db)

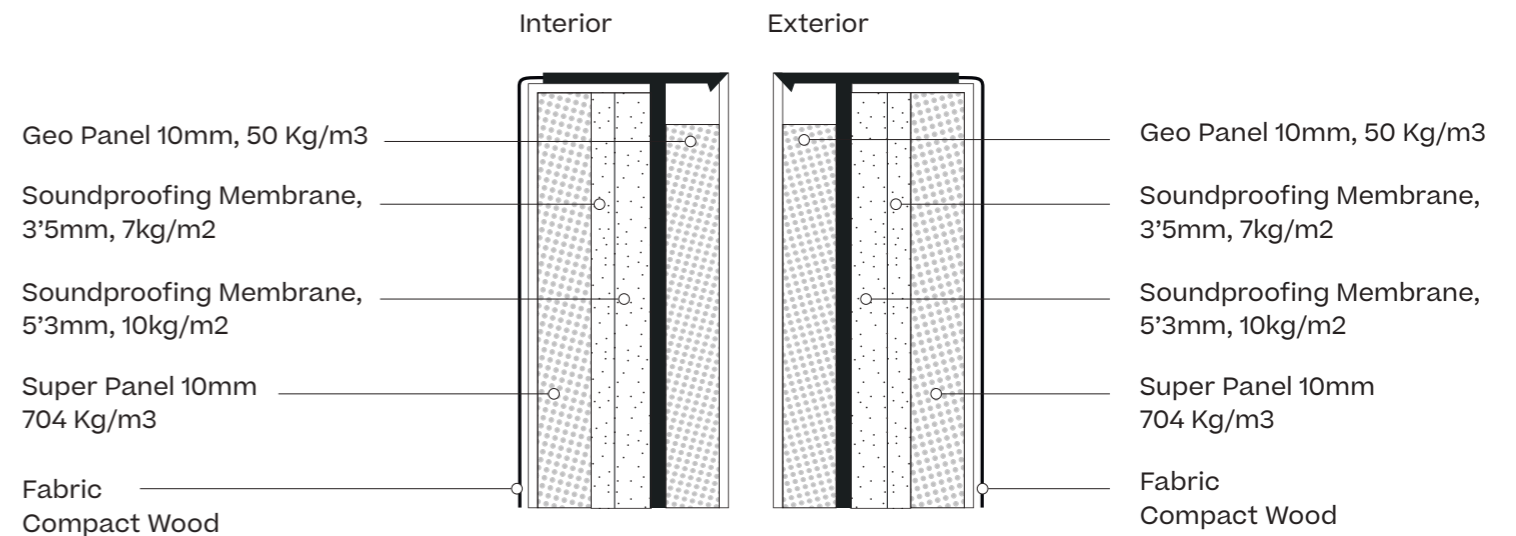

# Acoustic glass panels & Ceiling

Acoustic Glass (38 db)

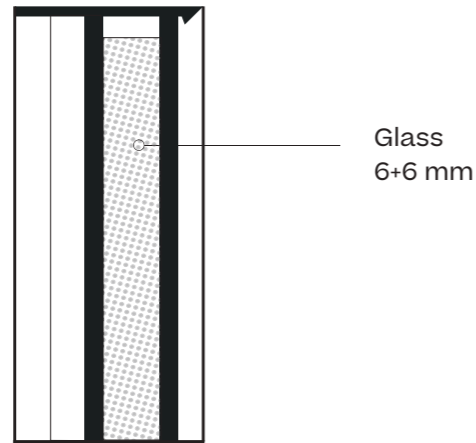

Nuvola / PET Acoustic

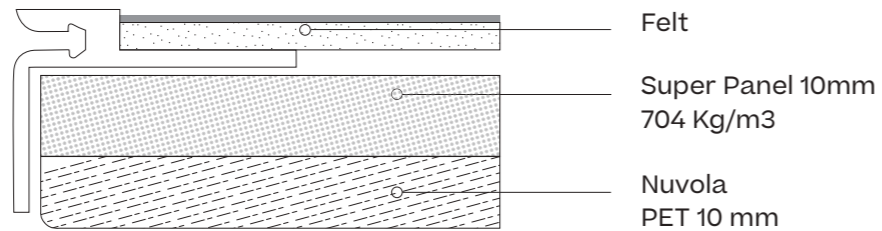

Ceiling Panel Nuvola

## 28 dBa

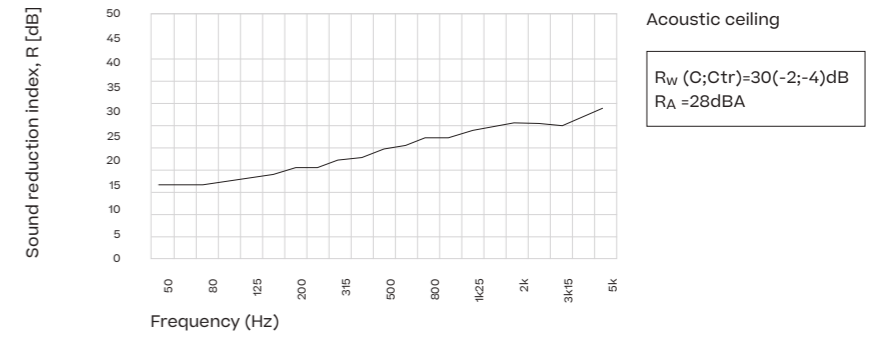

Acoustic Side Panel

## 41 dBa

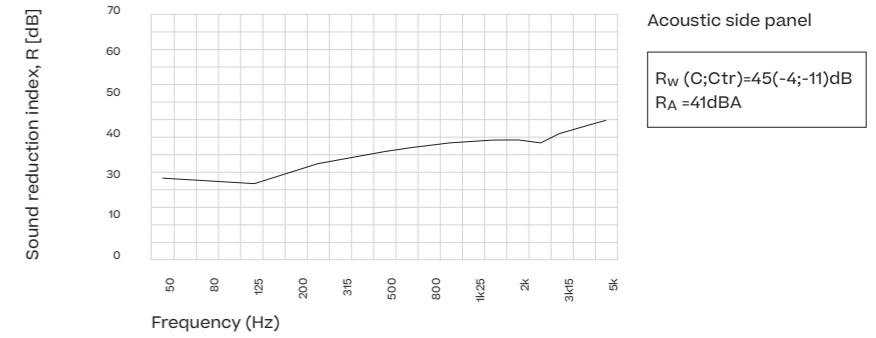

Acoustic Glass & Glass Door

## 38 dBa

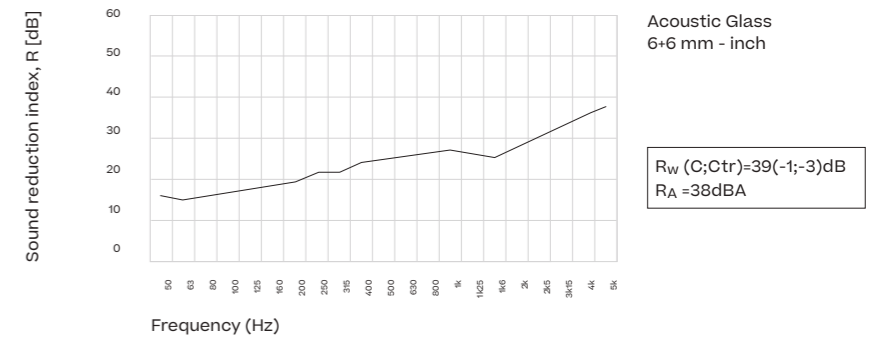

Average reverberation

## 0,2 RT

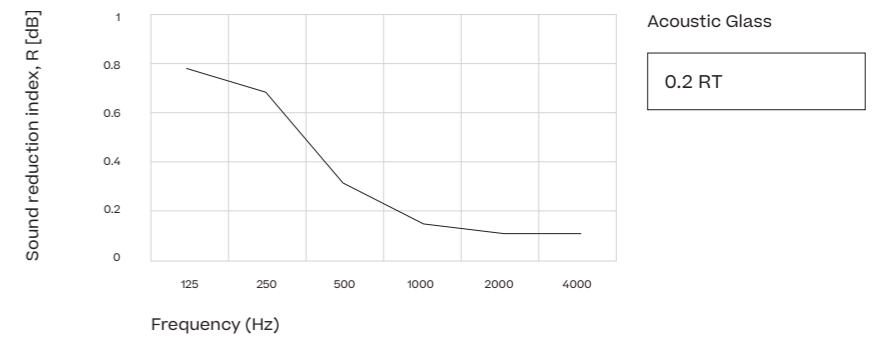

# Management System

Description

A smart technology fully integrated. It's a fully integrated business space solutions that streamline workflows and resource management for smarter, more efficient workplaces. We work with the platforms that enables you to perform all your daily activities (calls, presentations, collaboration) in every one of your workspaces and manage them securely online.

Key functions

- Audiovisual hardware
- Mirroring
- Videocalls
- Booking

Partners



Personal



Creston Booking screen

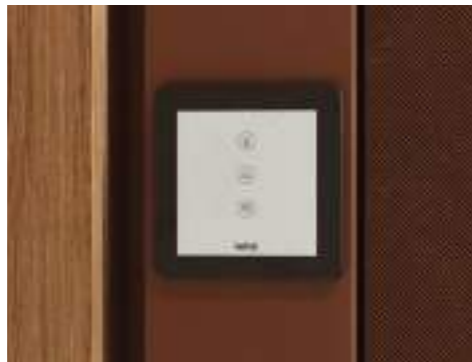

Kern Screen (air ventiaition & lights)



Lutron technology

The Pavilion system allows 2 project layers depending on what the client prefers:

	Stand Alone	Hub Bacnet
Control from presence sensor and push buttons	✓	✓
Control / Dimming from app and mobile device	✗	✓
Status / Occupation	✗	✓
Location map Statis / Occupation	✗	✓
Usage hours	✗	✓
Air renewal control	✓	✓
Room booking with schedule	✗	✓
Notification 10 minutes before the end of the reservation	✗	✓
Equipment failure warning	✗	✓
Sensor CO <sub>2</sub> Bacnet	✗	✓
Warranty	2 years	5 years
Remote support	✗	✓
Scenes & schedules programming	✗	✓

Extra information:

\*In case of not selecting any Hub option, all the material only has a 2-year war

# Monitor & audiovisuals

## Monitor key functions

- Slim video monitor
- Plug & Play system
- 3 different Sizes
- Samsung monitor

## Key Features

- Secure
- Can be managed remotely
- Fast connection
- Data connection between Wireless
- Mirroring

## BARCO bar

- 4K camera with 150° viewing
- Surrounding audiosystem
- Full set of configurable
- ClickShare integrated

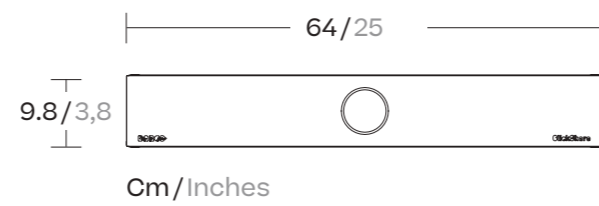
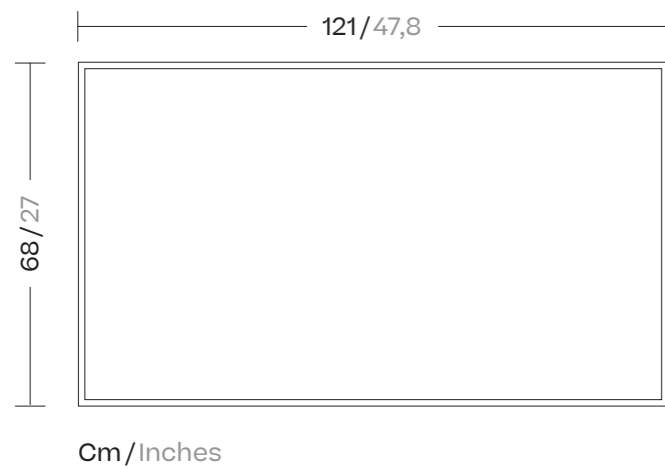

# Kern screen

## Key functions

---

- Intuitive Touchscreen Control: Kern features an intuitive touchscreen interface that simplifies the control of various office functions.
- Lighting Control: Effortlessly manage lighting within your office space, adjusting brightness and ambiance to suit different tasks and preferences.
- Scene Customization: Create and save custom scenes to set the perfect mood or functionality for meetings, presentations, or everyday work.
- Ventilation Management: Take charge of indoor air quality and comfort by controlling the ventilation system, ensuring a conducive working environment.



Air ventilation



Lighting



Scenes



# Safety

## Key functions

---

- Smoke detection & Sprinklers  
(We prepared the ceiling for easy install)



# Wall mounted outlets

## Key functions

- Data Port
- HDMI
- Power Outlet
- USB
- Configurable
- Shatter-proof
- Flat design line

7,4/2,91

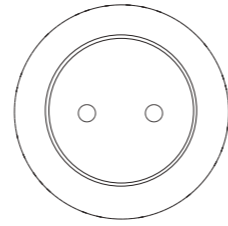

Cm/Inches



# Table/Column mounted outlets

## Hardware

- Simple design
- Power Connections
- USB
- Plug and outlet

10,2/4,01

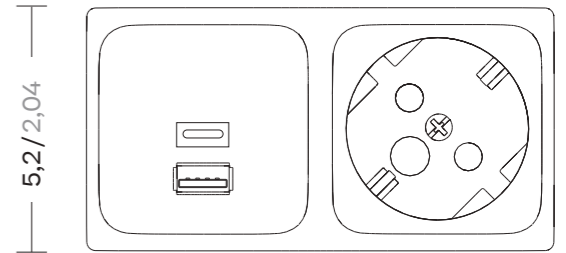

5,2/2,04

Cm/Inches



# Furniture

Elevate your workspace.  
Elevate your life. Discover our new  
collections, where office meets  
home, and style meets productivity.

Discover our new products.

Our wide range of durable collections allow you to create work environments and public spaces that are suitable for a wide variety of uses, both for individuals and for teams. We also design products for areas where people can work in silence and with complete concentration.

The furniture collection, which is suitable for both indoors and outdoors, is lively and expressive. It features modern classic designs, with an informal and stimulating language, enriched by contemporary colors and materials.

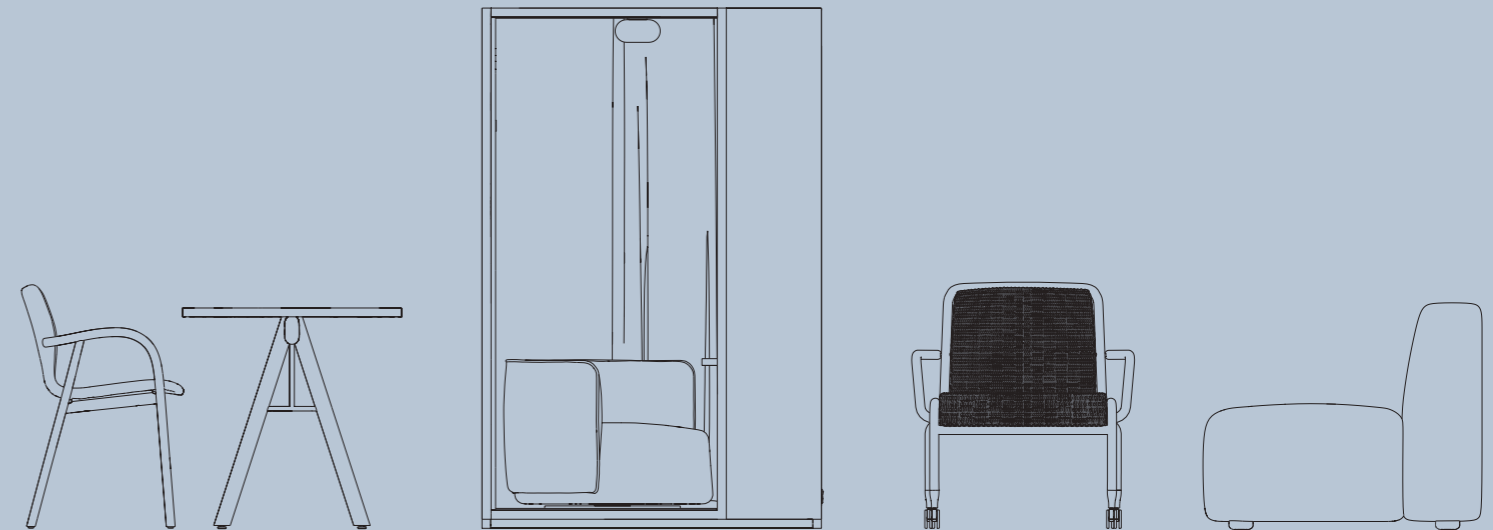

# Passage, by Ronan Bouroullec

Passage as a concept is highly ambiguous and versatile and can be used to describe numerous actions and situations. Passage relates to movement, it describes passing or movement from one place to another, in relation to travel, literature or music.

The Passage chair has any number of uses; it can seamlessly pass from one situation to another, from one place to another, from one use to another... It can be placed indoors or outdoors, displayed in a public place or kept in the comfort of home, in an urban environment or in the country.

Passage is made of aluminium, because this light,





Workplace

















Workplace

Stackable chair

KSB500100



Stackable dining armchair

KSB500400



Stackable Club armchair

KSB501300



Dining rectangular tables

KSB502100 220 x 100 / KSB502200 280 x 100



Dining square table

KSB502000 100x100



Centre table

KSB502300 100x100



Seat options



Cabo Rope



Straps



Synthetic Fiber



Aluminium  
(only available for Chair & Stackable armchair)

Table top



Aluminium  
Table top always Textured Paint  
Legs Glossy or Textured Paint

Passage Indoor

Stackable chair

KSB500100



Dining armchair non stackable

KSB500700



Stackable Club armchair

KSB501300

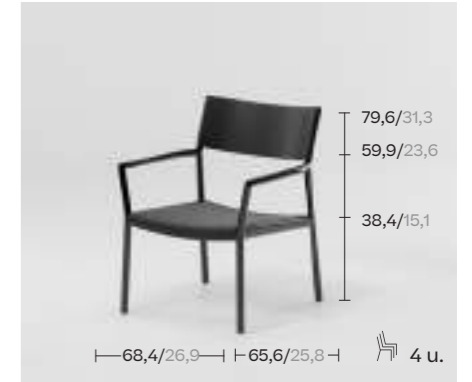

Dining rectangular tables

KSB502100 220 x 100 / KSB502200 280 x 100



Dining square table

KSB502000 100x100



Centre table

KSB502300 100x100



Seat options



Synthetic Fiber



Tapissée



Oak Veneer



Oak Veneer Black

Table top



Oak Veneer  
(Legs Glossy or Textured)



Oak Veneer Black  
(Legs Glossy or Textured)



Passage color options

Blanc d'ivoire version

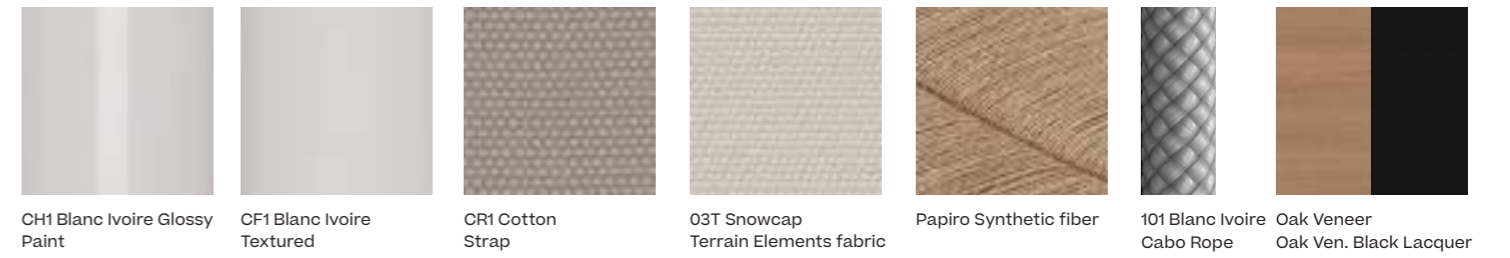

Noir d'ivoire Version

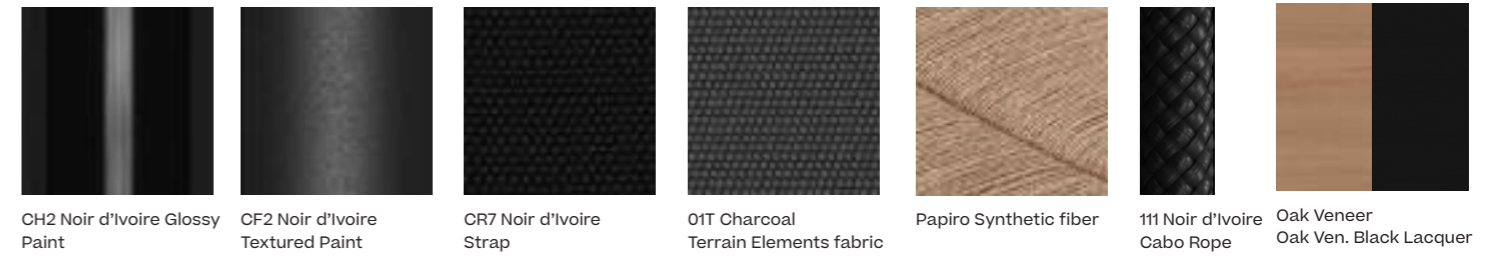

Terre Sienne Version



Vert

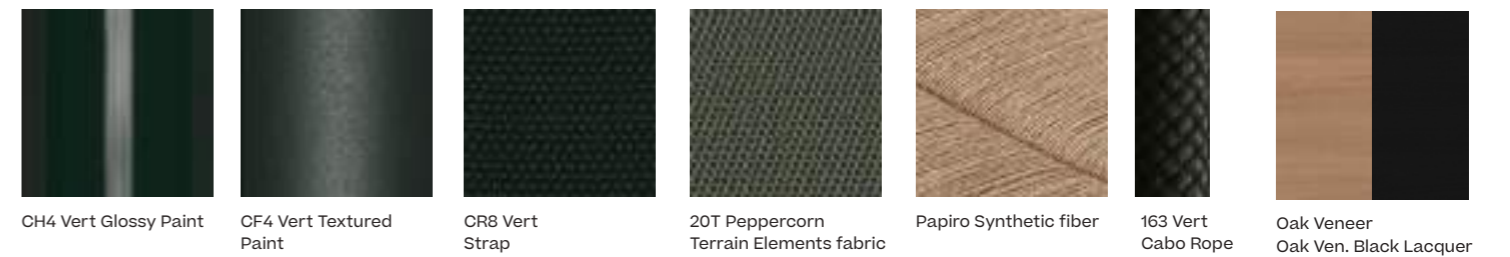

Anodisé Version

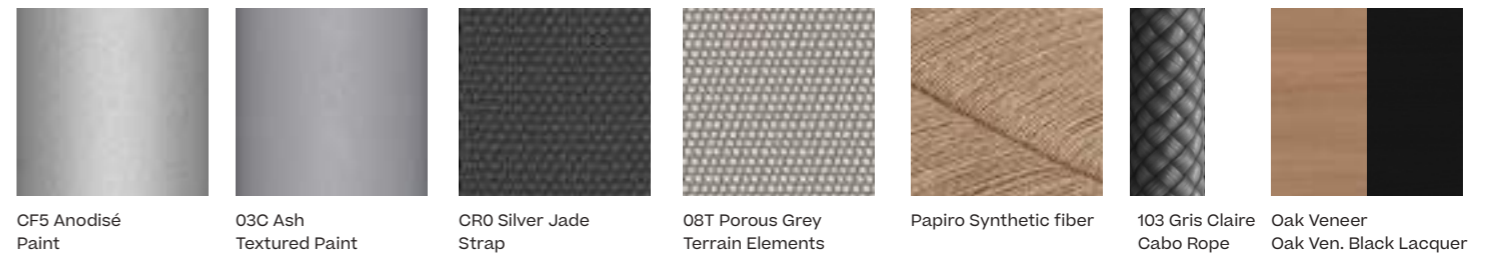

# Insula, by Patricia Urquiola

The Modular Insula sofa is Patricia Urquiola's updated interpretation of traditional seating used in traditional Arab Majlis, where community members gathered to discuss events and local issues, entertain guests, build friendships, and have fun.

Formally, it is a rational modular sofa with very softened shapes and low height, with a Insula in the backrest that concentrates all the protagonism of the design and provides a decidedly horizontal emphasis. It combines carefully balanced proportions as an architectural element that can be subtly integrated.

Functionally, like the original concept of Arab Majlis, the main function of the Insula sofa is socializing. The multitude of configurations allows it to adapt to all kinds of social situations, both indoors and outdoors: from the reception of an office where one can find a place to work relaxed, to resting in a home or outdoors for sunbathing and having fun. Its modular design consists of an orthogonal aluminum base with very softened shapes where the seat cushion, very plush and comfortable, is located. The two sizes of its seats allow for various types of backrests: individual, double, angular, etc.













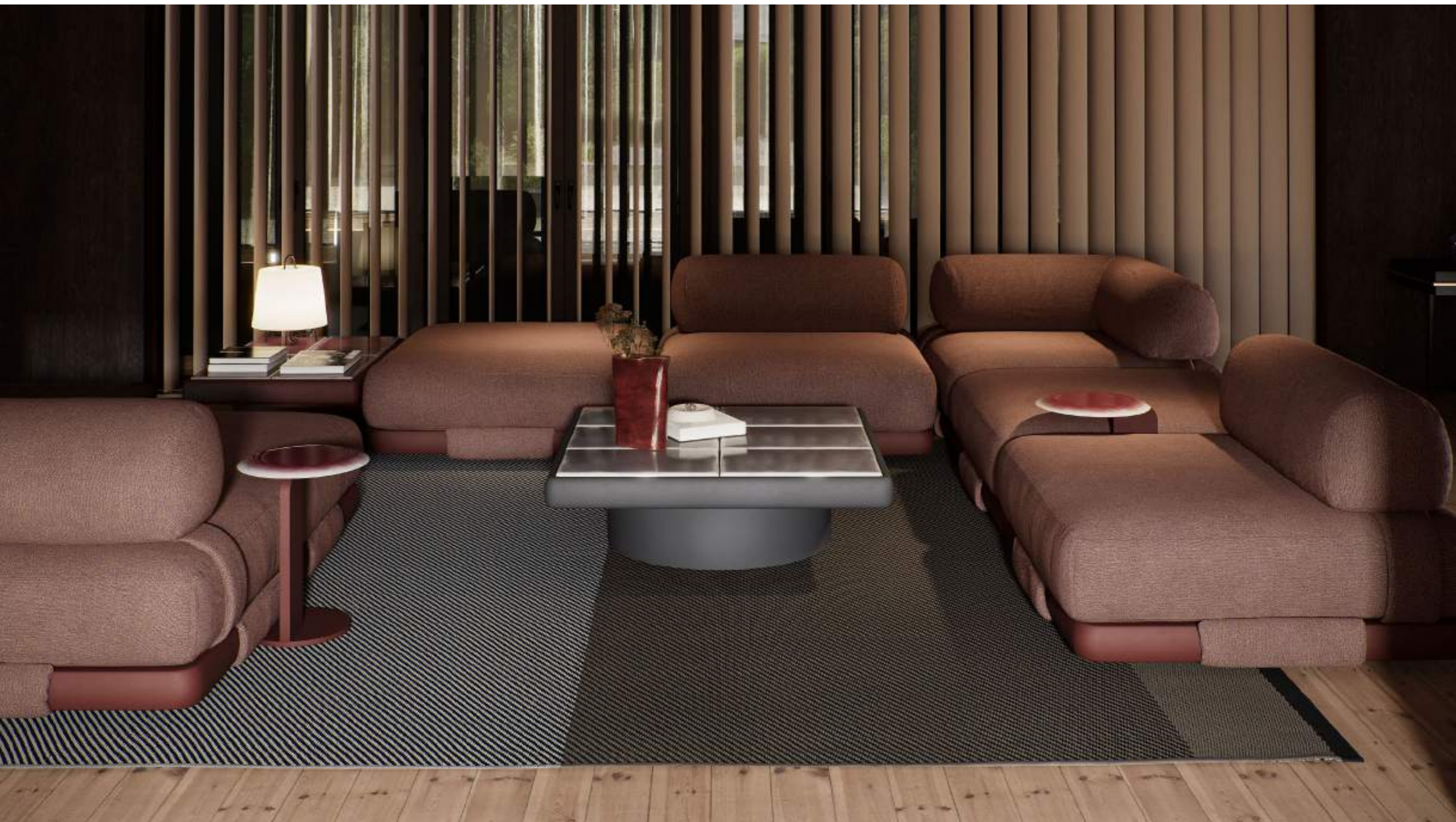





One seat module &  
Two seat module

One seat KSB600700  
Two seat KSB601000

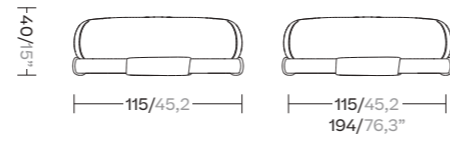

One seat module with back cushion  
Two seat module with back cushion

One seat KSB600800  
Two seat KSB601100

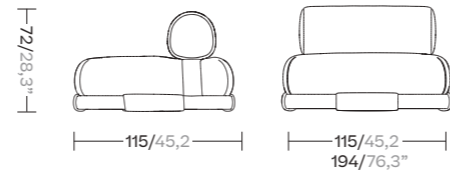

Corner module

KSB600900

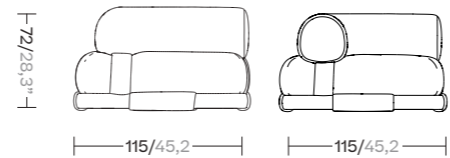

Daybed & Daybed Double

Daybed KSB601100  
Double Daybed KSB601100

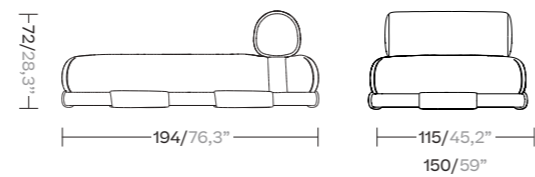

Two seat module with corner cushion

KSB601700

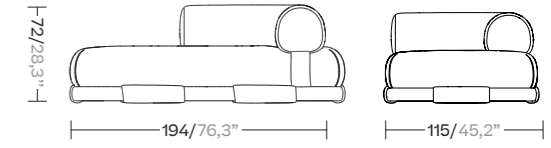

Square table

KSB601200

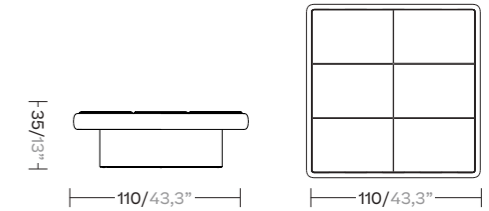

Rectangular table

KSB601300

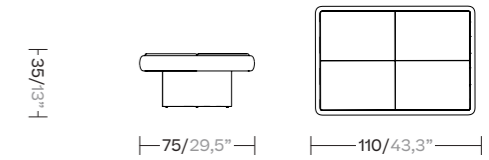

Side table

(charger optional indoor version)

KSB601500

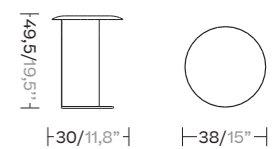

# A, by Naoto Fukasawa

Chairs and desks made of solid wood are not very common in the office environment. The concept of working places integrating home and office made a change, and I think it became more like that. The touch of our hands and bodies with the wood means coexisting with trees and getting closer to nature. It means living together. Wooden round bars do not cast strong line shadows in the space. It is beautiful and warm, in harmony with air, light, and people.





A









# Accessories A system

## Lamp

Add a touch of style and functionality to your System A desk with our sleek ceramic lamp. This versatile lamp can be easily moved from side to side, providing customizable lighting to meet your needs. The dimmable feature allows you to adjust the brightness to your liking, while the ceramic material gives it a modern and sophisticated look. In addition, the lamp features a convenient tray for storing small desk accessories like clips and other items. Available in both black and white, this elegant lamp is the perfect addition to any workspace.

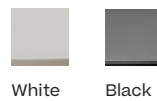

Color temperature: 2700K, 3 step.  
CRI: >90  
Lumen maintenance:  
L70 48.000 hours  
(0% of initial light output  
maintained)

IP20

## Screen

Wicker desk dividers, available in both frontal and lateral designs. Made from high-quality wicker material, these dividers are perfect for creating organized workspaces and reducing distractions. Available in both natural and dark colors, our wicker desk dividers add a touch of elegance to A desk while also providing practical benefits. Whether you need to create private workspaces, organize your desk, or simply add a touch of style, our wicker desk dividers are the perfect solution.



Frontal Screen 90x30 cm / 35,4x11,8"



Side Screen 60x40 cm / 23,6x15,7"



Natural Rattan



Deep Brown Rattan



## Power and USB connectivity

Moving sockets for the A desk system, available in both plug and USB A/C versions. These versatile sockets provide easy access to power and charging options while maintaining a sleek and organized workspace. Upgrade your desk with our functional and stylish lateral moving sockets today.

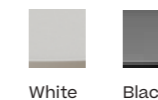

Plug



USB charger Type A & C (25 W)





Chair

KSA000100

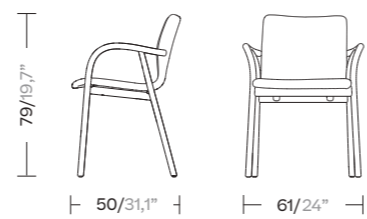

Home Deck

KSA000200

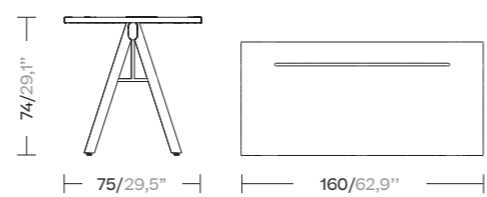

Meeting table

KSA000300

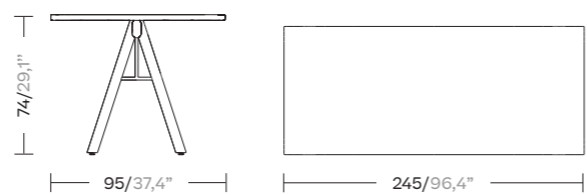

# Eolias, by Antonio Citterio

Eolias Collection by Antonio Citterio, inspired by the breathtaking archipelago located off the coast of Sicily. This versatile collection includes a range of indoor and outdoor furniture pieces designed to elevate any space.

One of the collection's highlights is the Eolias Salinas series, which features a chair, club chair, and club lounge chair made from sturdy aluminum with a woven wicker detail. These pieces come in both indoor and outdoor versions, with the indoor chairs available with or without wheels for added convenience.













Eolias Salinas  
Dining Armchair

KSB200100  
KSB200200 with wheels

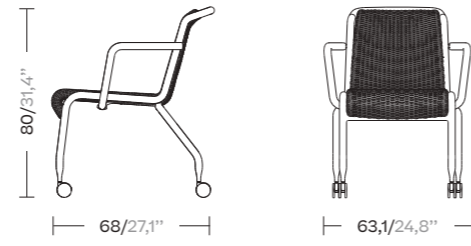

Eolias Salinas  
Club Armchair

KSB200300  
KSB200400 with wheels

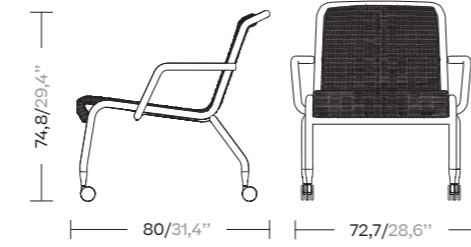

Eolias Salina  
Lounge Club

KSB200900

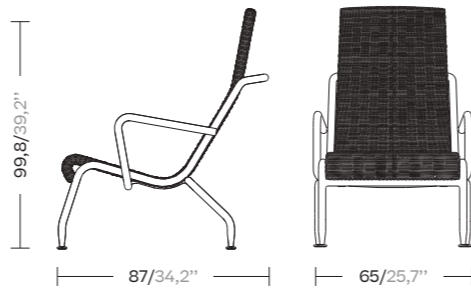

# M Sofa, by Kettal Studio

In the dynamic world of offices and public spaces, blending function and aesthetics is vital. Offices require design that encourages collaboration, innovation, and well-being. Imagine the transformative influence of the Sofa M collection—a blend of modular straight and curved sofas along with a swiveling club chair—gracing these spaces. These innovative pieces bring versatility and adaptability, mirroring the flexibility needed in modern workspaces and communal areas.

Just as the Sofa M collection seamlessly connects its modules, offices embrace adaptable layouts for diverse workstyles, fostering teamwork. Similarly, public spaces emphasize multifunctionality, accommodating various events. In essence, these spaces harmonize productivity and leisure, bridging our professional aspirations and community bonds with the elegant and functional design of the Sofa M collection.







Swivel club M

M120093200

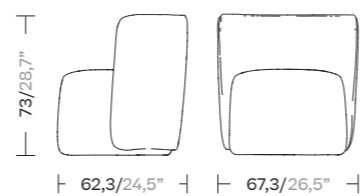

Left / Right Sofa M

Left  
M1439IZQ0L L Size  
M1439IZQXL XL Size  
Right  
M1439DER0L L Size  
M1439DERXL XL Size

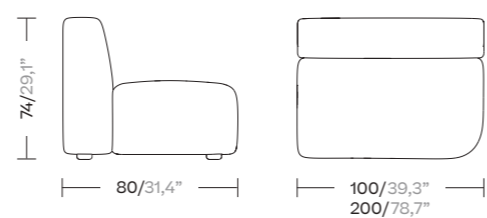

Central Sofa M

M1439TO10L L Size  
M1439TO1XL XL Size

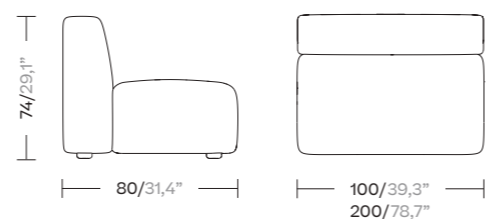

Left / Right Curved Sofa M

Left  
A2039IZQ00  
Right  
A2039DER00

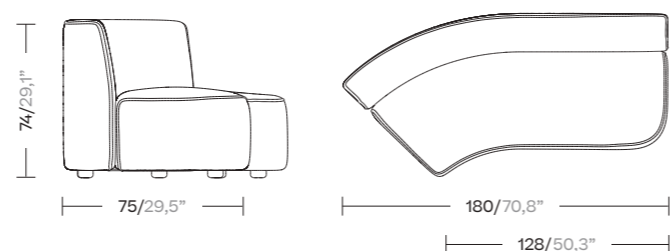

# Materials

The materials in the new collection of the Pavilion M system are represented by fabrics, metals, woods, stones and ceramics. All of these worlds form the basis of the library. The intention is to inspire and invite the professional to explore and combine colors, textures and materials to create new exclusive codes for each project and each use.

Recyclable and exclusive materials, to explore an infinite number of combinations.

Workplace

Base (Eolias indoor & A only)

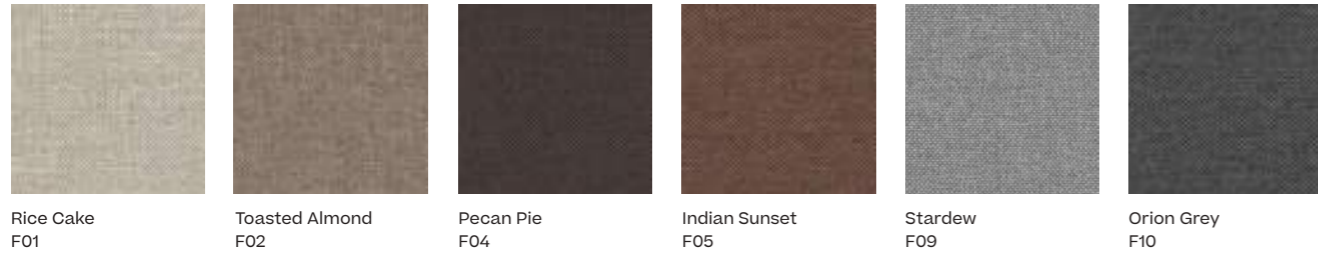

Leather (Eolias indoor & A only)



Relate Fabrics (Pavilion M & Sofa M Collection)

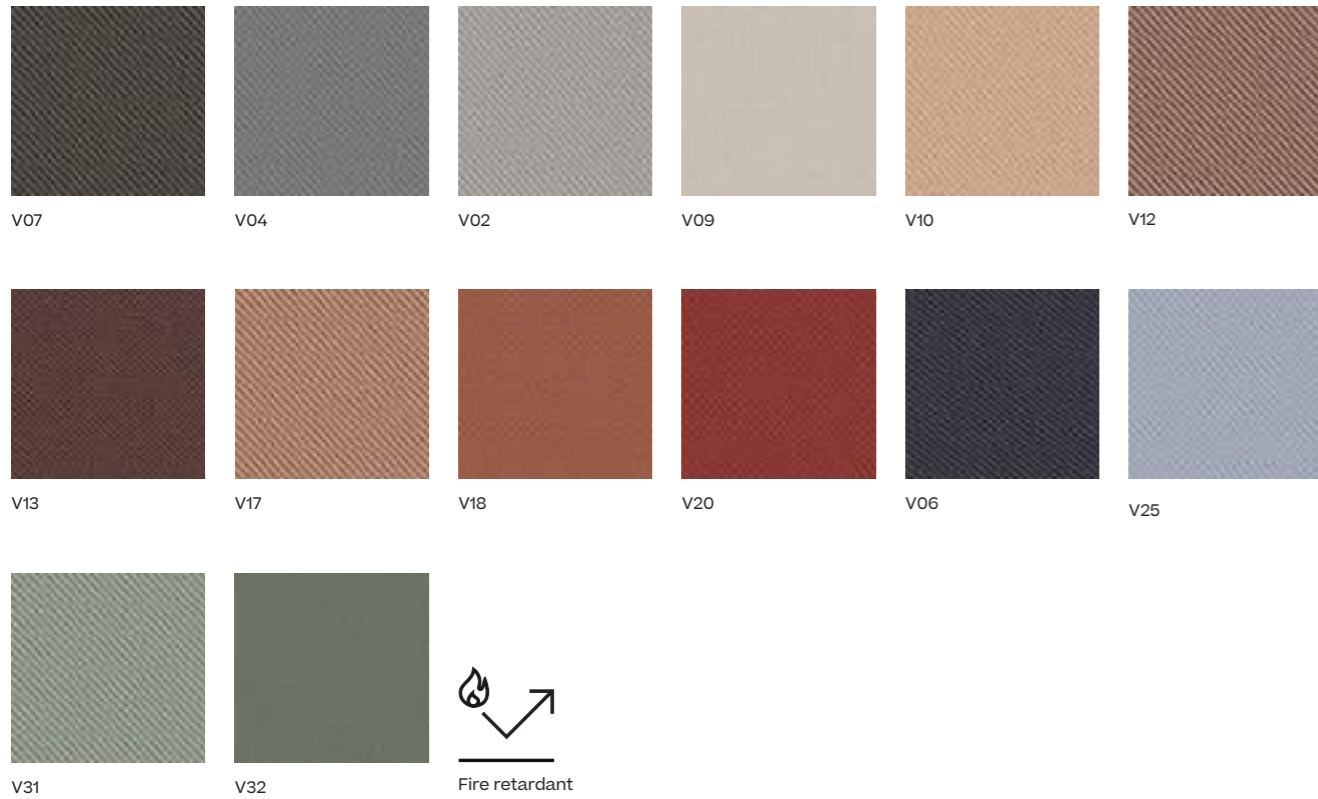

Nuvola (Pavilion M)

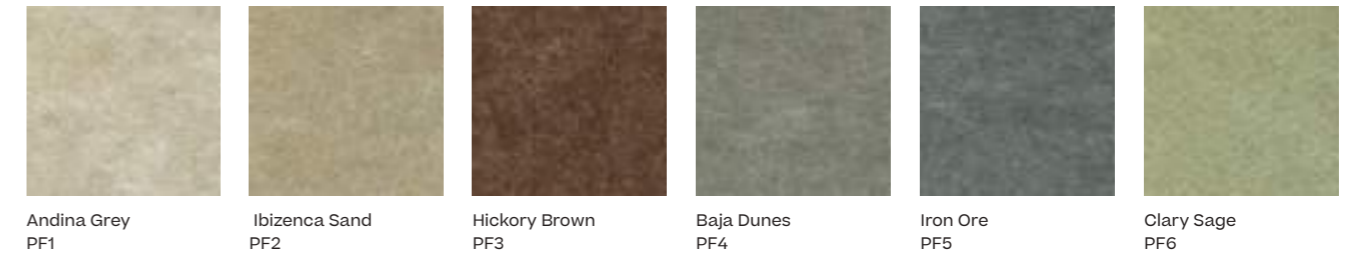

Maya (curtains)

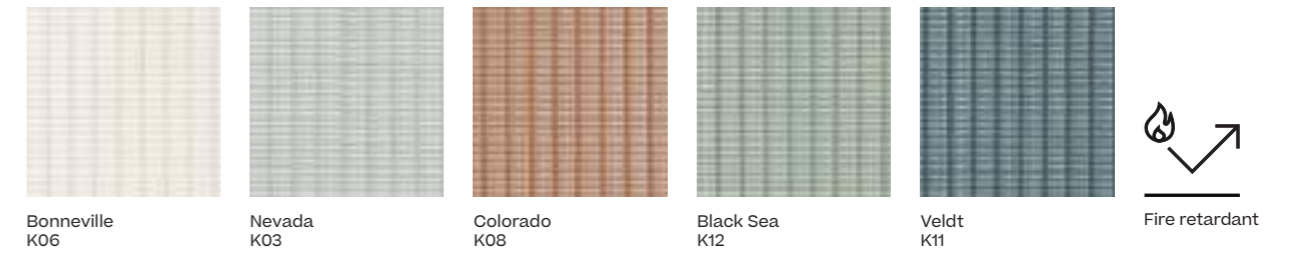



Rockress (Insula Collection)

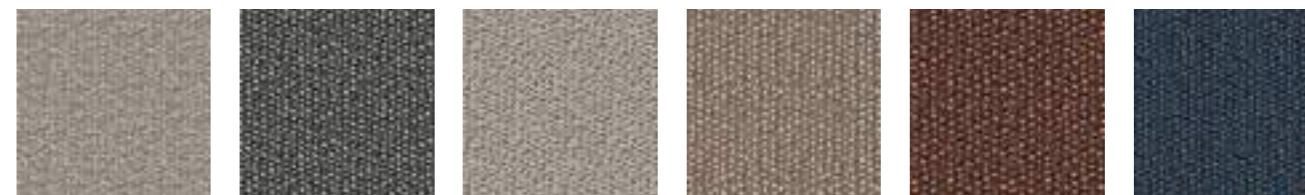

Silver Falls  
D1L

Black Velvet  
D2L

Summer Snow  
D3L

Cherry Caramel  
D4L

Red Robin  
D5L

Blue Thyme  
D6L

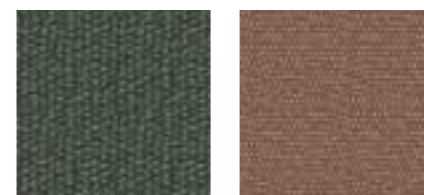

Silver Falls  
D7L

Arabis  
D8L

Agate (Only for the table tops of the Insula collection)

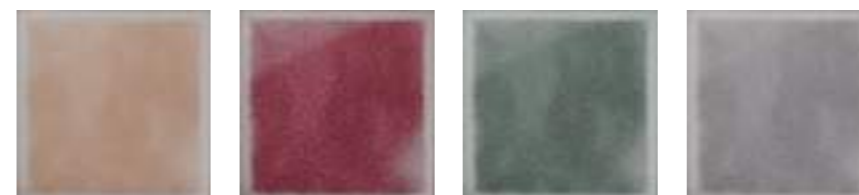

Camelian Agate

Indian Agate

Moss Agate

Botswana Agate

Workplace

Terrain Paint



Slate Stone 01C  
Mysty Smoke 02C  
Ash 03C  
Bone 04C  
Tuff 05C  
Wet Stone 06C  
Sand Dune 07C  
Dry Clay 08C  
Arabica 09C



African Savannah 10C  
Desert Storm 11C  
Ginger Root 12C  
Amber 13C  
Terracota 14C  
Terrarosa 15C  
Rose Canyon 16C  
Sunset Glow 17C  
Ruby Dust 18C

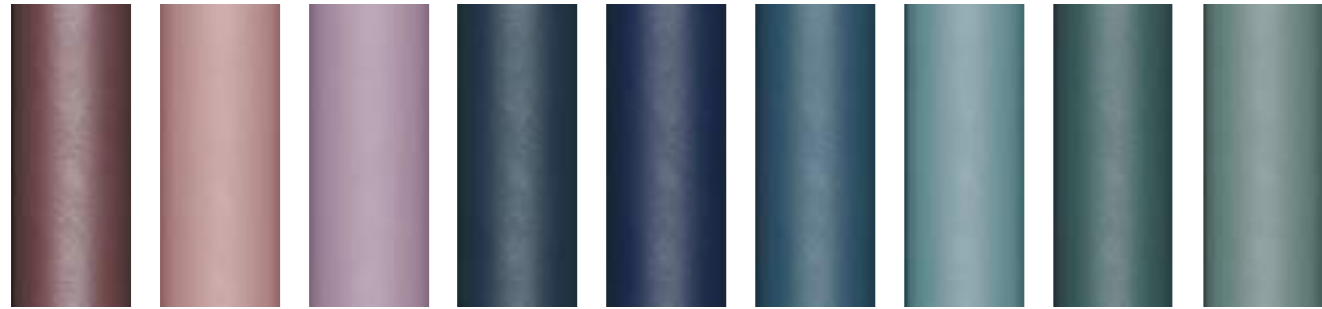

Sepia 019C  
Blossom 020C  
Wild Lupin 21C  
Indigo 22C  
Nightfall 23C  
Polar Sky 24C  
Glacier Ice 25C  
Sea Moss 26C  
Forest Stream 027C

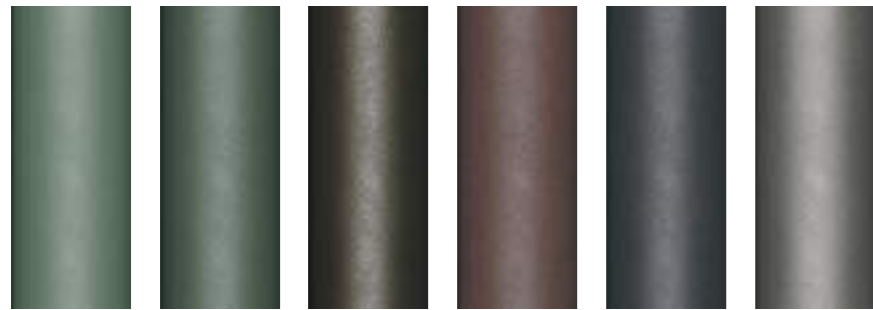

Spring Meadow 28C  
Komby 29C  
Bronze 30C  
Corten 31C  
Manganese 32C  
Galena 33C



Terrain Lustre  
(Eolias only)

Noir d'Ivoire CH2

Ceramics

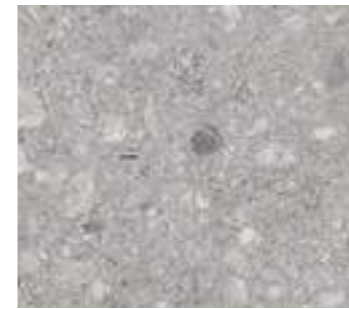

Ceppo di Gre



Du Gent Grey



Neutral Caliza



Royal Black

Blanc d'ivoire version (Passage)

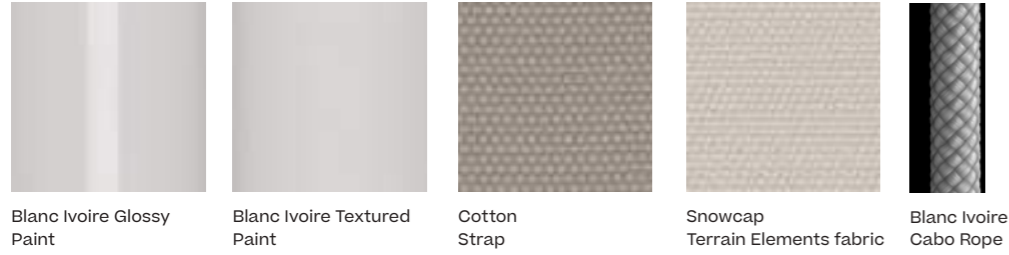

Noir d'ivoire Version (Passage)

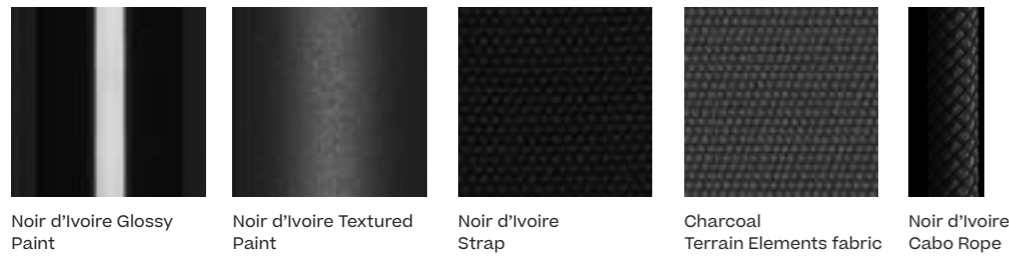

Terre Sienne Version (Passage)



Vert Version (Passage)

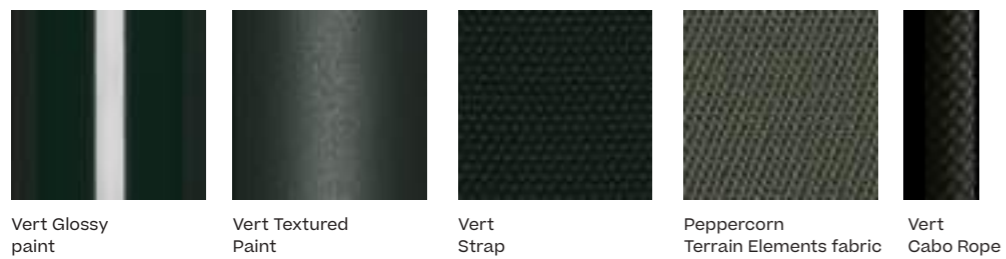

Anodisé Version



Plywood (Passage)

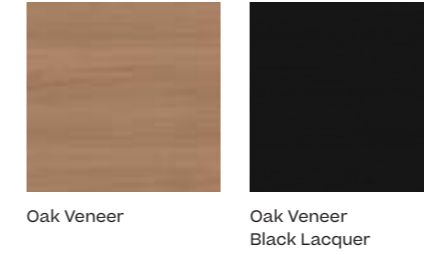



### Wood (A collection)



Natural Oak  
(table)



Burnt Oak  
(table)

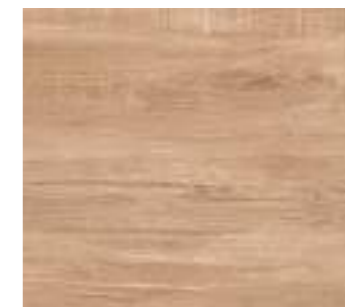

Natural Ash  
(chair)

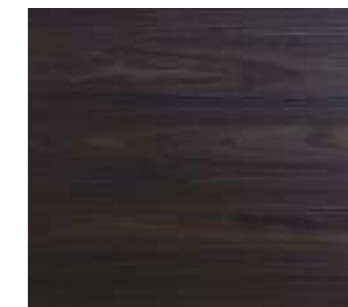

Burnt Ash  
(chair)

### Compact Wood (Kall)



Light Oak  
CW1



Dark Oak  
CW2

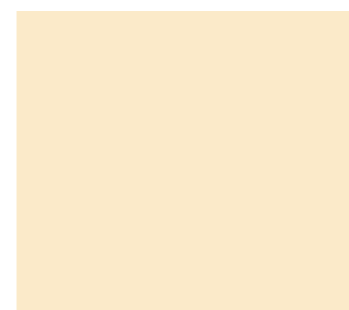

Soft Beige  
LW1

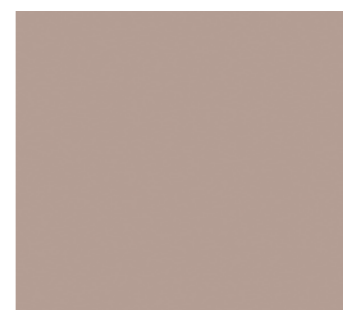

Almond beige  
LW4

Standards:  
- EN 14323  
- EN 438-2  
- ISO 22196

### Compact Wood (Pavilion M)

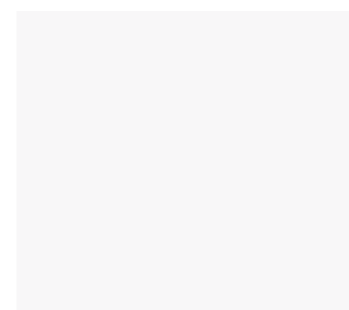

Soft White  
ML0



Waked Oak  
ML1

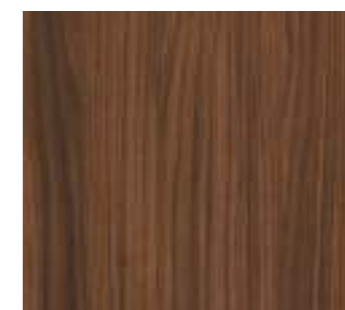

American Walnut  
ML2



Soft Black  
ML3

# We would love to hear from you.

## Head office

Kettal Barcelona  
Aragón, 316  
08009 Barcelona, Spain  
T. (34) 93 487 90 90  
F. (34) 93 487 90 66



Download our  
Living catalogue



Download our  
Contract catalogue

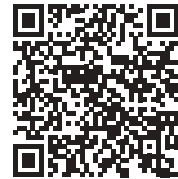

See the finishes of  
each photo

## Showrooms

Miami  
147 Miracle Mile  
Coral Gables,  
Florida 33134, USA  
t. (1) 786 552 90 22  
miami.store@kettal.es

New York  
The D&D Annex:  
222 East 59th Street  
Suite 222-333  
New York, NY 10022, USA  
t. (1) 917-992-9419  
newyork.showroom@kettal.com

London  
15-16 Dufferin St,  
London EC1Y 8UR, Reino Unido  
t. +44 (0) 7498 846 352  
london.showroom@kettal.es

Marbella  
Crtra. de Cádiz, Km.179  
(entre el Marbella Club  
y el Guadalpin)  
29600 Marbella, Spain  
t. (34) 95 277 89 89  
tienda.marbella@kettal.es

Chicago  
The Mart.  
222 Merchandise Mart Plaza,  
Suite 377 (3rd fl.)  
Chicago, IL 60654 USA.  
T. 312.244.0527  
chicago.showroom@kettal.es

Paris  
80, Blvd Malesherbes  
75008 Paris, France  
t. (33) 1 43 59 51 40  
boutique.paris@kettal.es

Barcelona  
Aragón, 316  
08009 Barcelona, Spain  
T. (34) 93 488 10 80  
tienda.bcn@kettal.es

Melbourne  
510 Church Street Melbourne  
Richmond VIC 3121, Australia  
t. (03) 9957 8799

Milan  
Via Broletto 44/46  
Milan  
Coming soon!

Casablanca  
2ème étage, 54 Jean Jaurès St,  
Casablanca  
casablanca.showroom@kettal.es