

100% quality

Freestyle yOUNG COLLECTION

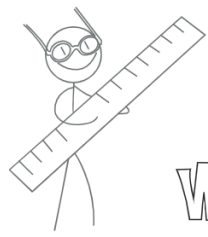

www.erbamobilita.it



NEW

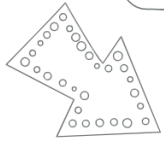

After more than 50 years on the market, Erba is today a leader in the production and creation of bedrooms for kids and children. This dynamic company, located in the heart of Brianza - where you can find the production headquarters, as well as the offices and showrooms - makes use of cutting-edge technology and a young workforce, adjectives that perfectly describe this growing business. We continuously invest in production - one of Italy's most innovative systems - along with research and development of products that meet new styles and needs. All of this has made Erba a world-renown company. Thanks to our hard work, our production unit can now take advantage of high-tech machinery and systems, specifically designed by a team of experts to meet company needs. We can now offer our clients and customers the utmost flexibility and customization for their projects. These products are created for those who want an exclusive style - people who pay a great deal of attention to design - in this case, truly minimalist. Our furnishings are always contemporary, thanks to essential lines and punctitious style. This is a balanced mix of innovation, safety, dependability, and design. And these are the fundamental ingredients that give shape and colour to interiors for your kids.

Présente depuis plus de 50 ans sur le marché, Erba est aujourd'hui un des leaders les plus importants dans la production de chambres pour enfants. Elle est située au cœur de la Brianza où se trouvent l'unité de production, les bureaux et le showroom. Une entreprise dynamique, jeune et technologiquement avancée, ce sont les adjectifs les plus appropriés pour décrire une réalité en croissance constante. Un investissement continu, d'une part dans les systèmes de production, incontestablement parmi les plus innovateurs au niveau national et d'autre part dans les activités de recherche pour le développement de produits toujours actuels, ont fait d'Erba une entreprise reconnue au niveau international. Grâce aux efforts continus, l'unité productive peut utiliser aujourd'hui des installations hautement spécialisées, projetées par des équipes d'experts pour répondre en mode particulier aux exigences de l'entreprise et offrir au client final une plus grande flexibilité et une plus grande personnalisation du projet. Elle propose des produits qui s'adressent à ceux qui recherchent un style exclusif et prêtent une grande attention au design, en l'occurrence extrêmement minimaliste. Des éléments toujours contemporains grâce à leurs lignes essentielles et strictes. Un mélange équilibré d'innovation, sécurité, fiabilité et design. Ce sont précisément les ingrédients indispensables pour donner forme et couleur à l'espace dédié aux jeunes.

Nach mehr als 50 Jahren Marktpräsenz ist Erba heute einer der wichtigsten Anbieter von Einrichtung für das Kinderzimmer. Seine Produktionsstätten, Verwaltungsgebäude und der Showroom befinden sich im Herzen von Brianza, in der Region Lombardei. Es handelt sich um ein junges und dynamisches, technologisch hochqualifiziertes Unternehmen mit kontinuierlichem Wachstumstrend. Dank konstanter Investition in die Entwicklung topaktueller Produkte und in innovative Produktionssysteme, die landesweit zu den fortschrittlichsten gehören, genießt Erba internationales Ansehen. Mit hochspezialisierten Fertigungsanlagen, die von Experten speziell für die Anforderungen des Unternehmens entwickelt wurden, kann Erba dem Endkunden ein Höchstmaß an Flexibilität und Personalisierung der Projekte anbieten. Die Produktpalette richtet sich an ein Publikum mit exklusivem Stil und Sinn für Design - hier mit extremem Minimalismus interpretiert. Essenzielle, formal schlüssige Linien gewährleisten zeitgemäße Optik - ein ausgewogener Mix aus Innovation, Sicherheit, Zuverlässigkeit und Design. Und für die Raumgestaltung von Kindern und Jugendlichen sind genau diese Elemente unverzichtbar.



Dopo oltre 50 anni di presenza sul mercato, Erba è oggi un leader nella produzione di camere per ragazzi. Situata nel cuore della Brianza, dove si trovano l'unità produttiva, gli uffici e lo showroom. Dinamica, giovane e tecnologicamente avanzata, sono gli aggettivi più appropriati per descrivere una realtà continuamente in crescita. Un investimento continuo, da una parte nei sistemi di produzione, in assoluto tra i più innovativi presenti sul mercato, e dall'altra parte nelle attività di ricerca, per lo sviluppo di prodotti sempre di tendenza, ha fatto di Erba un'azienda riconosciuta a livello internazionale.

Grazie a questo continuo impegno, l'unità produttiva è specializzata, progettata da team di esperti appositamente creati per l'azienda che grazie a ciò offre al cliente finale una personalizzazione del progetto. Prodotti rivolti a coloro che ricercano uno stile esclusivo e in questo caso estremamente minimalista. Elementi sempre contemporanei grazie a linee essenziali e rigorose. Un equilibrato mix di innovazione, sicurezza, affidabilità e design. Sono questi gli ingredienti indispensabili per dare forma e colore all'ambiente dedicato ai giovani.

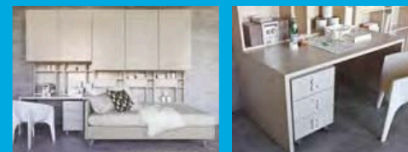

Voi e Erba

Erba and you



I nostri prodotti sono distribuiti solo ed esclusivamente attraverso una rete di rivenditori autorizzati in grado di offrire un servizio di progettazione ed assistenza post-vendita. Ti invitiamo a visitare il nostro sito per conoscere il rivenditore Erba più vicino.

Our products are distributed solely and exclusively through authorized dealers who can also offer design services and after-sales assistance. Please visit our website to find out where you can find the Erba retailer nearest to you.

Nos produits sont distribués uniquement et exclusivement à travers un réseau de revendeurs autorisés en mesure d'offrir un service de projet et d'assistance après-vente. Nous vous invitons à visiter notre site pour connaître le revendeur Erba le plus proche de chez vous.

Unsere Produkte erreichen den Markt über ein exklusives Vertriebsnetz von ausgewählten Partnern, die angemessene Planungs- und Kundenbetreuungsdienste anbieten können. Bitte besuchen Sie unsere Website, um den nächsten autorisierten Vertriebspartner von Erba zu finden.

Puoi scoprire l'intera collezione Erba, i video e le foto ed essere sempre aggiornato sulle ultime novità seguendo la nostra pagina Facebook o Twitter o visitando il nostro sito. Iscrivendoti alla newsletter avrai inoltre la possibilità di ricevere i nostri aggiornamenti.

You can also look through the entire Erba collection, including videos and photographs, with all our new offers, or by following us on Facebook and Twitter. By signing up for our newsletter, you can receive all the latest news on products we offer.

Vous pouvez découvrir toute la collection Erba, les vidéos et les photos et être constamment informé sur les dernières nouveautés en consultant notre page Facebook ou sur Twitter ou en visitant notre site. En vous inscrivant à notre newsletter vous pourrez recevoir nos dernières mises à jour.

Videos, Fotos und umfassende Informationen über die gesamte Kollektion von Erba stehen auf unserer Facebook-Seite, über Twitter oder auf unserer Website zur Verfügung. Abonnieren Sie unseren Newsletter, um den neuesten Stand unserer Angebote zu erhalten.



Il nostro modo per far largo ai colori!

Making the difference: let co

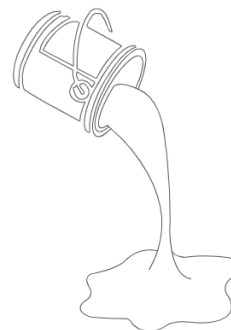

Il nostro attuale sistema tecnologico al mondo, ci permette di offrire una gamma colori della nostra collezione che rispetta le ultime tendenze. Per i nostri prodotti utilizzati in classe E1, a bassa emissione di formaldeide. Scopri tutte le finiture con

Our current production line, edge systems, allows us to offer our collections, keeping exclusive use of class E1 emissions. Please visit our website for more information on and finishing.

Notre système de production technologique au monde, nous permet de proposer une gamme de couleurs de notre collection qui respecte les dernières tendances. Pour nos produits nous utilisons une classe E1, à basse teneur en formaldéhyde. Vous pouvez découvrir toutes

Wir verfügen über ein innovativstes und technologisches System. Dadurch können wir aktuellste Farbpaletten ausschließlich Melamin-beschichtete Melamin-beschichtete Formaldehydemissionen. Informationen über die Fertigung





Buone ragioni per scegliere Freestyle
More great reasons to choose Freestyle



reSearch



**UN prodotto
Senza tempo**



**100%
Made IN italy**



**100%
quality**



**costo
accessibile**



**Le Migliori
Materie prime**

deSign



idé es



iNNOvATION



FLESSibilità



- quality
- Service
- reLIability
- SatISFaction

**attention to
every d**

perSONALizza

Per m
For fu

Why should we simply call it "the kids' room"?
It's the place where parents read fairy tales over and over again,
until they know every word by heart.
Here the kids play. They watch cartoons and then movies.
They study. Sometimes.
Friends stay over, friends for adventures,
or more often, getting into trouble.
They confide, they cry, they laugh, they dream.
They grow up.
An intimate, versatile place,
which needs to be welcoming and practical for those needs,
changing every day.
This is why Freestyle was created.
Because your needs are our goals.

Pourquoi la définir simplement "chambre d'enfants"?
C'est l'espace où les parents lisent et relisent des fables
jusqu'à en connaître par cœur chaque mot.
C'est le lieu où l'on joue. Où l'on regarde des dessins animés et
ensuite des films.
C'est le lieu où l'on étudie. Parfois.
On y reçoit des amis, des compagnons d'aventure
ou plus souvent de mésaventure.
C'est le lieu où l'on se confie, on pleure, on rit, on rêve.
C'est là que l'on grandit.
Un espace intime, versatile,
qui doit savoir accueillir et répondre
aux différentes et nombreuses exigences
qui se présentent en mode récurrent chaque jour.
Freestyle est né pour cela.
Parce que vos désirs sont pour nous synonymes d'objectif.

Mehr als ein "Kinderzimmer"?
Ein Raum, wo vorgelesen wird, bis auch die Eltern jedes Wort
der Geschichte auswendig können.
Ein Raum zum Spielen.
Wo man sich erst Zeichentrick- und später Spielfilme und Dokus ansieht.
Wo Hausaufgaben erledigt werden. Jedenfalls meistens...
Wo Freunde und Spielgefährten zu Besuch kommen.
Wo man anderen das Herz ausschütten, weinen, lachen und träumen kann
Wo man wächst und weiterkommt.
Ein intimer Raum, der vielfältige Funktionen erfüllen muss, um täglich aufs
Neue die unterschiedlichsten Anforderungen zu erfüllen.
Dafür haben wir Freestyle konzipiert.
Denn die Wünsche des Kunden sind uns ein Ziel.

“ Perché definirla semplicemente
È quello spazio dove i genitori
le fiabe fino a cominciare
a memoria ogni singolo
Si gioca. Si guardano i cartoni
Si studia. A volte
Si ospitano gli amici, compaiono
o più spesso, disastri
Ci si confida, si piange, si
Si cresce
Uno spazio intimo
che deve saper accogliere
le diverse esigenze
che si presentano ricorrenti
Freestyle nasce proprio
Perché il vostro desiderio è

LA CAMERA DINAMICA: STUDIARE, DORMIRE E GIOCARE

LO SCRITTOIO SCORREVOLE
È UTILIZZABILE DA ENTRAMBI I LATI
E CONSENTE DI GESTIRE LO SPAZIO
SECONDO LE ESIGENZE

AVETE BISOGNO DI PIÙ SPAZIO?
LO SCRITTOIO SI PUÒ SOVRAPPORRE AL LETTO

The dynamic room:
study, sleep, and play
The sliding desk can be used on both
sides, allowing you to manage your space
based on your needs.
Do you need more space?
The desk can be placed over the bed

La chambre dynamique:
étudier, dormir et jouer
Le bureau coulissant peut être utilisé des
deux côtés et il permet de gérer l'espace
selon les exigences.
Vous avez besoin de plus de place?
Le bureau se superpose au lit

Das dynamische Zimmer:
schlafen, lernen und spielen
Zur bedarfsgerechten Nutzung des
Raums kann der fahrbare Schreibtisch
beidseitig verwendet werden. Es ist mehr
Platz gefragt? Dann kann der Schreibtisch
über das Bett gefahren werden







C'est la musique que j'aime / ⇔

⇨ Je m'en balade
l'après-midi
- 2000 -



PER STUDIARE CON I MODULI DELLA CREARE È UN GIOCO DA R VARIETÀ DI

You need room to study
With the modules of the Multibox
collection, creating the perfect solution is
simply child's play, thanks to the vast
choices of bookshelves and storage units

Pour étudier il faut
Avec les modules
Multibox créer la s
jeu d'enfants grâce
bibliothèques et d'



DESIGN VERSATILE E FUNZIONALE

LA STRUTTURA PONTE
CON LIBRERIE MULTIBOX È UNA SOLUZIONE
INNOVATIVA E FLESSIBILE
PER COLORO CHE NECESSITANO
DI SFRUTTARE AL MEGLIO LO SPAZIO
NON TRASCURANDO
L'ESIGENZA DEL CONTENIMENTO

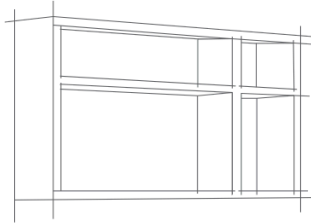

Versatile and practical design

The bridge unit with Multibox booshelves is an innovative and flexible solution for those who need to take full advantage of their interior space without leaving out their storage needs

Design versatile et fonctionnel

La structure pont avec les bibliothèques Multibox est une solution innovatrice et flexible pour ceux qui ont besoin d'exploiter au mieux l'espace sans oublier l'exigence de rangement

Vielseitiges und funktionales Design

Die Brückenstruktur mit Multibox-Bücherregalen ist eine innovative Lösung für optimale Raumnutzung, ohne den Bedarf an Aufbewahrungsbehältern zu vernachlässigen







PROGETTI LE LIBRERIE MU SOVR È POSSIBILE CR S VERO E PROP

Design freedom
The Multibox bookshelves can be
stacked and suspended.
You can create an infinite number of
solutions, without giving up that authentic
designer touch

Projeter en liberté
Les bibliothèques
Multibox peuvent
être suspendues.
Il est possible de créer
des solutions infinies sans renoncer

FUNZIONALITÀ AL PRIMO POSTO

IL LETTO INFERIORE È INDIPENDENTE
GRAZIE ALLE RUOTE
È FACILMENTE SPOSTABILE
E PUÒ ESSERE ESTRATTO
PER AGEVOLARNE
L'UTILIZZO ED IL RIFACIMENTO

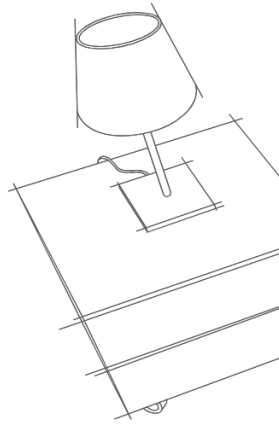

Practicality first
The lower bed is independent, and thanks to the wheels you can move it and take it out with a simple push - easy to tidy up and easy to use

Fonctionnalité à la première place
Le lit inférieur est indépendant et grâce aux roulettes il peut être facilement déplacé et extrait pour l'utiliser et le refaire facilement

Funktionalität hat Vorrang
Das untere Bett ist unabhängig und kann leicht herausgefahren werden, um einfacher verwendet oder bezogen zu werden







UNO S
IL M
IL T
DOTAT

Room for two
The 1x2 bed revolutionizes the traditional
concept of the bunk bed.
Equipped with four wheels, it is also
available in queen size

Un espace pour de
Le lit 1x2 est une ré
traditionnel de lits s
Doté de quatre rou
jusqu'à une place et





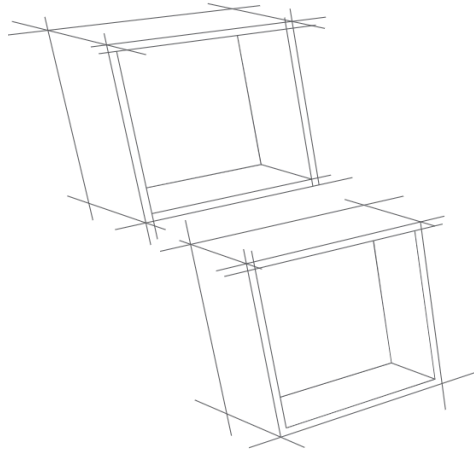

LO SPAZIO È PREZIOSO

IL LETTO A CASTELLO CON ARMADIO
È UNA SOLUZIONE INTELLIGENTE
PER SFRUTTARE AL MEGLIO LO SPAZIO
IL LETTO SUPERIORE PUÒ ESSERE
FACILMENTE RIASSETTATO GRAZIE AL
MECCANISMO DI RIORDINO

Priceless space

The bunk bed with the wardrobe is an intelligent solution, taking full advantage of your space. What's more - the upper bed can be easily made up thanks to the "rearrange" mechanism

L'espace est précieux

Les lits superposés avec armoire représentent une solution intelligente pour exploiter au mieux l'espace. Le lit supérieur peut être facilement refait grâce au mécanisme de rangement

Raum ist kostbar

Etagenbetten mit Schrank sind die intelligente Lösung, um Raum zu gewinnen. Durch einen spezifischen Mechanismus kann das obere Bett leicht gemacht und bezogen werden.







RIGOROSITÀ E VERSATILITÀ IN UNA COMBINAZIONE PERFETTA

UNA NUOVA ED ORIGINALE PROPOSTA
PER RIVISITARE L'IDEA DI COMODINO
LE LIBRERIE MULTIBOX SONO VERSATILI
ED ADATTE AD INTERPRETARE
LE MOLTEPLICI ESIGENZE
DELLO SPAZIO GIOVANI

Thorough and versatile design - the perfect combination

A new, truly original offer that reinvents your concept of the bedside table.

The Multibox bookshelves are versatile and simply perfect for interpreting your kids' numerous needs

Rigueur et polyvalence: une parfaite combinaison

Une nouvelle proposition originale pour repenser l'idée de table de chevet. Les bibliothèques Multibox sont polyvalentes et adaptées à interpréter les multiples exigences de l'espace des jeunes

Perfekte Kombinationen

dank Vielseitigkeit und formaler Strenge
Eine neue und originelle Variation zum Thema des Nachttischs. Multibox - Bücherregale sind vielseitig, um dem unterschiedlichen Raumbedarf junger Leute Rechnung zu tragen

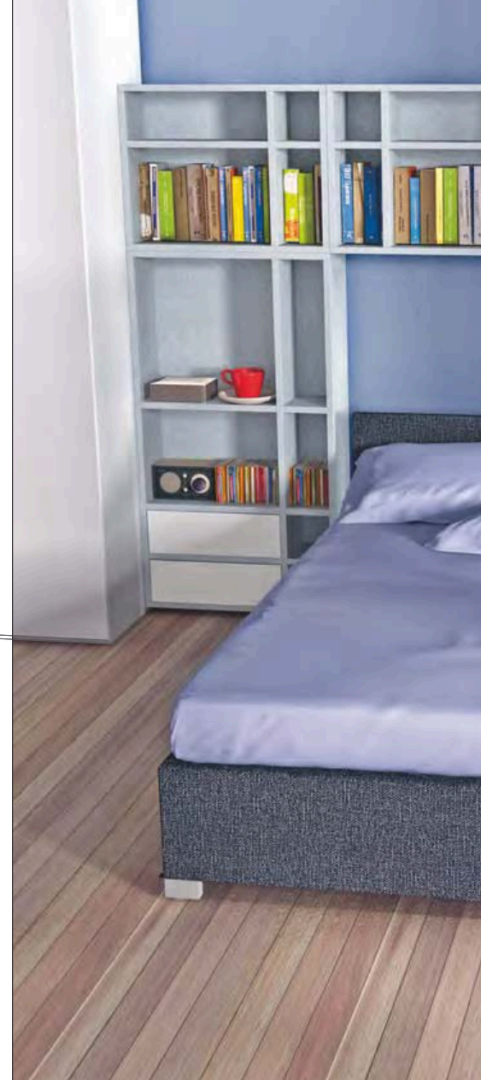





È EST
E
AUTOM

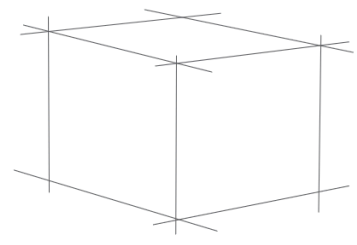

A desk and double the space
The rolling desk can be pulled out and
wheeled around, or even used as a
second, independent workspace

Un bureau: un espa
Le bureau sur rou
pivotant et peut-ê
deuxième espaç

FINO A 3,5 M DI LUNGHEZZA

LA STRUTTURA PONTE SI PUÒ ESTENDERE
FINO AD ACCOGLIERE SIA IL LETTO
CHE LO SCRITTOIO ED È SOSTENUTA
DA UN ROBUSTO TELAIO
NEL QUALE È POSSIBILE INSTALLARE
DELLE LAMPADE

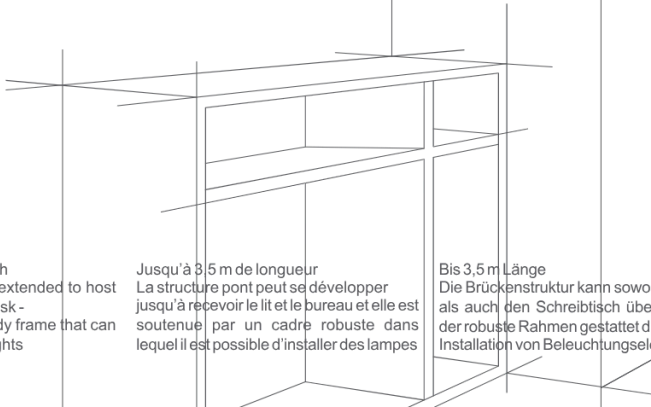

Up to 3.5 meters in length
The bridge unit can be extended to host
the bed as well as the desk -
it is supported by a sturdy frame that can
also be equipped with lights

Jusqu'à 3,5 m de longueur
La structure pont peut se développer
jusqu'à recevoir le lit et le bureau et elle est
soutenue par un cadre robuste dans
lequel il est possible d'installer des lampes

Bis 3,5 m Länge
Die Brückenstruktur kann sowohl das Bett
als auch den Schreibtisch überspannen;
der robuste Rahmen gestattet die
Installation von Beleuchtungselementen





"The alarm rings and a new day begins.
Breakfast and then off to school.
A long day awaits and you need all the energy you can get.
Lunch and then it's time to hit the books.
But you also need a break once in a while - a little bit of TV and some
ruckus with friends, and then back to studying.
The evening sets in and the room is a mess: books, pictures, CDs,
clothes everywhere, a tablet, the console...
...and if someone walked in right now!
A kid's life really isn't that simple.
Thankfully there's Multibox, and everything falls right into place!"

"Le réveil sonne et une nouvelle journée commence.
Un petit-déjeuner et ensuite vite à l'école.
La journée est longue et nécessite un plein d'énergie.
Déjeuner et se mettre à étudier tout de suite après.
Mais de temps en temps il faut faire un break: juste un peu de télé
et un peu de chahut entre amis puis se remettre à étudier.
Le soir arrive et le désordre règne dans la chambre:
livres, photographies, CD, des vêtements par ci par là, la tablette, la console...
...si quelqu'un arrivait à ce moment-là!
La vie de jeunes adolescents n'est pas simple.
Heureusement il y a Multibox et
en un instant tout est rangé!"

"Der Wecker klingelt und ein neuer Tag beginnt.
Nach dem Frühstück geht es ab in die Schule.
Der Tag ist lang und verschlingt viel Energie.
Gleich nach dem Mittagessen wird gelernt.
Aber ab und zu darf man sich eine Spiel- oder Fernseh-Pause mit
Freunden gönnen, bevor man sich wieder an Hefte und Bücher setzt.
Am Abend herrscht dann das reine Chaos: Bücher, CDs, Fotos,
Kleidungsstücke, die Konsole und das Tablet sind im Raum verstreut...
...wenn jetzt bloß keiner reinkommt!
Als Kind lebt es sich auch nicht so einfach.
Zum Glück gibt es Multibox und im Nu ist alles wieder aufgeräumt!"

“ Suona la sveglia ed inizia
Colazione e poi di cor
La giornata è lunga e ci vogli
Pranzo e poi subito
Ma ogni tanto ci vuole un brea
e un po' di caos cor
poi di nuovo su
Arriva sera ed il disordine re
libri, fotografie, CD, vestiti qua e
...se arrivasse qualcuno in
La vita da ragazzi non è p
Per fortuna esiste M
in un attimo tutto è al

Multibox è una collezione di contenitori che si
Multibox is a collection of storage boxes that adapt to meet

adattano a qualsiasi es
the kids' each and every need.

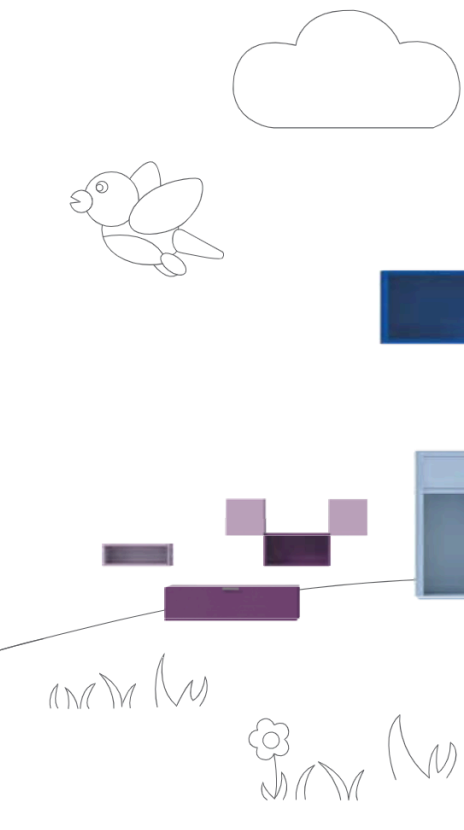

gazzi. Pensili, basi o su ruote. Ante, cassetti e
on wheels. Doors, drawers and chests. An infinite number

cestoni. Infinite combin
of combinations - satisfying e

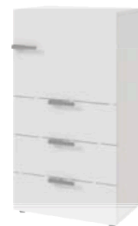

re tutti. **Multibox per giocare, studiare o lavorare.**
studying and working. Discover the entire collection at your

Scopri l'intera collezione
nearest retailer!

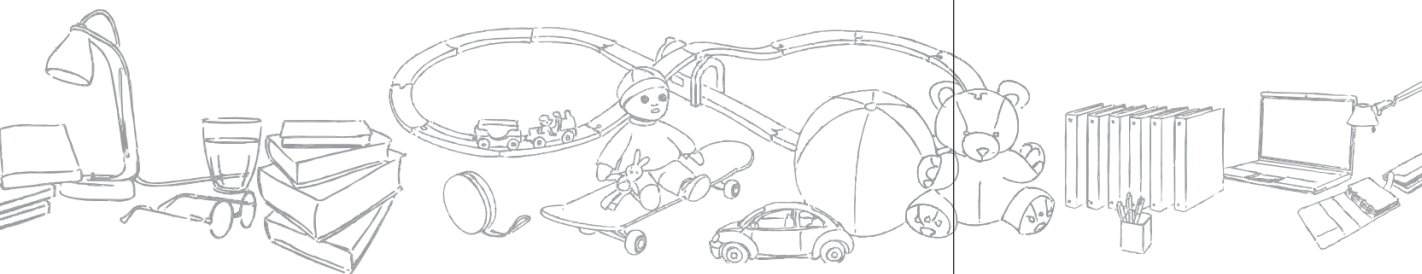
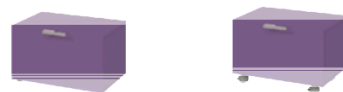

Nella collezione Freestyle sono disponibili armadi, letti singoli ed a castello, scrittoi, librerie, boiserie, mensole e tanti altri accessori che permettono di progettare lo spazio ragazzi in modo originale e funzionale

The Freestyle collection offers wardrobes, single and bunk beds, desks, bookshelves, wainscoting, shelves, and numerous other accessories that will make it easy to design the kids' room in an original and practical way

La collection est composée d'armoires, de lits à une place et superposés, de bureaux, de bibliothèques, de boiseries, de consoles et beaucoup d'autres accessoires qui permettent de projeter l'espace des jeunes adolescents de façon originale et fonctionnelle

In der Kollektion Freestyle stehen Schränke, Einzel- und Etagenbetten, Bücherregale, Wandverkleidungen und Ablagen zur Verfügung - mit vielseitigem Zubehör, um das Kinderzimmer so originell und funktionell wie möglich zu gestalten

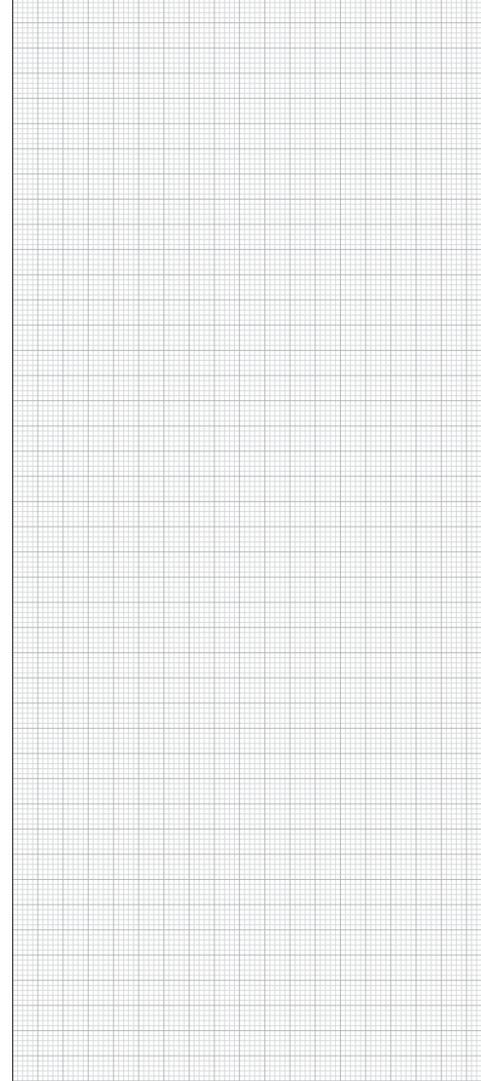



Sistema armadi

Wardrobes system | Système armoires | Systemschränke

Un sistema di contenitori versatile, composto da molteplici soluzioni ed innumerevoli moduli adattabili alle esigenze di ogni singolo cliente per realizzare armadi personalizzati sia nelle misure che nelle finiture.

A system of versatile storage units, made up of numerous solutions and countless modules that will meet the client's each and every need - creating customised wardrobes based on measurements, size, and finishes.

Un système polyvalent d'éléments, composé de multiples solutions et d'innombrables modules adaptables aux exigences de chaque client pour réaliser des armoires personnalisées en termes de mesures et de finitions.

Vielseitiges System für die individuelle Gestaltung von Gesamtlösungen, die in Abmessungen, Farben und Materialien auf die Anforderungen des einzelnen Kunden zugeschnitten sind.

Armadi ante battenti

Wardrobes with leaf doors | Armoires avec portes battantes | Schränke mit Flügeltüren

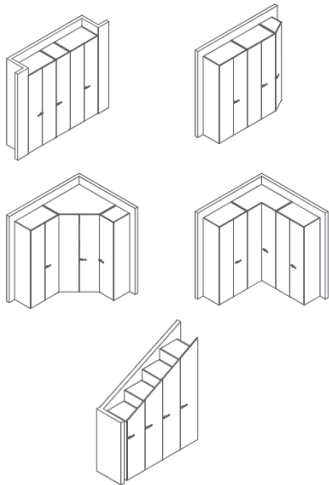

Il sistema di armadi ad ante battenti vanta una modularità molto evoluta che ne consente l'inserimento in ogni spazio. Grazie ad alcuni elementi "speciali" (armadi angolari e terminali) è possibile risolvere le differenti esigenze di arredo.

Il sistema dispone di un'ampia varietà di modelli, con ante, cassetti, cestoni e vani a giorno, liberamente combinabili tra di loro.

È inoltre possibile realizzare soluzioni ad hoc per ambienti mansardati.

This system for wardrobes with leaf doors offers cutting-edge modularity that makes it perfect for any and every interior. Thanks to some "special" elements (corner and end units), you can satisfy even the toughest furnishing needs.

This system also has a vast array of models, doors, drawers, chests, and open units, all which you can pair up in absolute freedom.

Moreover, this system also offers solutions for attics and mansards.

Le système d'armoires à portes battantes vante une modularité très évoluée qui permet son insertion dans tout espace. Grâce à quelques éléments "spéciaux" (armoires d'angle et d'extrémité) il est possible de résoudre toute exigence d'ameublement.

Le système dispose d'une vaste variété de modèles, avec portes, tiroirs, grands paniers et compartiments ouverts, librement associables entre eux.

Il est en outre possible de réaliser des solutions spéciales pour des zones mansardées.

Dank hoher Modularität passt dieses Schranksystem mit Flügeltüren in jeden Raum. Mit "Spezialelementen" (darunter Eckschränke und Endstücke) kann jeder Raum zweckmäßig eingerichtet werden.

Das System bietet ein breit gefächertes Angebot an Modellen und frei kombinierbaren Flügeltüren, Schubladen, Körben und offenen Regalfächern.

Für Mansarden können Ad-hoc-Lösungen erstellt werden.

Armadi anta battente e scorrevole

Wardrobes leaf/sliding door | Armoires porte battante/coulissante



Il sistema misto anta scorrevole e il modulo con anta scorrevole. Questo ne consente l'inserimento in ogni spazio.

This mixed system for wardrobes offers a wide range of advantages: the module with the sliding door allows for the practical addition of open shelves.

Le système mixte porte coulissante et porte battante offre de nombreux avantages. Ce qui permet l'insertion d'éléments ouverts.

Das Kombi-Schranksystem mit einer Element mit Schiebetür für offene Regale und Schreibtische auf.

Armadi scorrevoli

Wardrobes with sliding doors | Armoires avec portes coulissantes

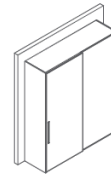

Il sistema di armadi ad ante scorrevole grazie all'ingombro minimo. Disponibili soluzioni con diverse configurazioni.

The system for wardrobes with sliding doors offers a wide range of advantages: thanks to the minimal footprint, these wardrobes are available in a wide range of configurations.

Le système d'armoires avec portes coulissantes offre de nombreux avantages. Ces armoires sont disponibles avec des configurations d'espaces réduits grâce à l'encoche.

Dank ihres minimalen Raumbedarfs sind diese Schranklösungen bei Platzmangel. Es stehen Lösungen mit zwei, drei oder vier Türen zur Verfügung.

Strutture ponte

Bridge units | Structures pont | Brückenstrukturen



①

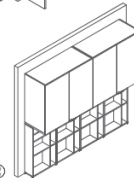

②

Nel sistema armadi sono previste due soluzioni: la struttura ponte con la soluzione ① si può estendere lateralmente con le armoire. La soluzione ② non necessita di sostegno. Multibox.

The system offers two solutions with Multibox. This solution allows the bridge unit to be extended laterally by lateral units or wardrobes. Multibox bookshelves as support.

Dans le système armoires sont prévues deux solutions: la structure pont avec cad. La solution ② n'a pas de limite de hauteur. Multibox.

Im Schranksystem stehen zwei zur Auswahl: Brückenstruktur. Die Lösung ① kann bis zu 3,5 m aufliegen. Die Lösung ② ist eine selbsttragende Multibox-Regale.

C'è più colore in tutto quel che fai!

Make everything you do more colourful! | Toujours plus de couleur!



Uno dei plus della collezione Freestyle è la sua estrema flessibilità, sia in termini di misure che di finiture. Grazie ad un innovativo sistema di produzione siamo in grado di offrire la personalizzazione di ognuno dei 6500 articoli della collezione senza nessun limite. Persino l'interno del vostro armadio sarà personalizzabile scegliendo tra le finiture proposte nella nostra gamma. Una grande possibilità per creare combinazioni uniche.



An extra from the Freestyle collection is its utmost flexibility finishes. Thanks to our innovative production system, we are able to offer the customization of one of our 6500 articles from this collection, without any limitations. Even the interior of your wardrobe can be customised with your choice of finishing from our vast range of combinations.

Un des plus de la collection Freestyle est son extrême flexibilité de finitions. Grâce à notre système innovateur de production nous sommes en mesure d'offrir la personnalisation de chaque article de notre collection sans aucune limite. Même la partie interne de votre vestiaire sera personnalisable en choisissant parmi les finitions proposées à l'intérieur de notre gamme. Une grande possibilité pour créer des combinaisons uniques.

Die extreme Flexibilität bei Abmessungen und Fertigbarbeiten der Kollektion Freestyle. Dank unseres innovativen Produktionssystems können wir die Personalisierung jedes unserer 6500 Artikel aus dieser Kollektion ohne Einschränkungen anbieten. Sogar das Innere Ihres Schrankes kann individuell auf Ihre Wünsche abgestimmt werden. Sogar unsere Verarbeitungsoptionen personalisiert werden. Eine große Möglichkeit, um einzigartige Kombinationen zu erstellen.

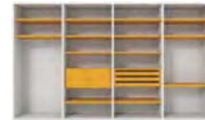



Letti singoli

Single beds | Lits à une place | Einzelbetten



Finiture
Finishing
Finitions
Fertigbearbeitungen

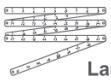

Larghezza
Widths
Largeurs
Breiten



su Misura
Custom-made
Sur-mesure
Maßgeschneidert



Personalizzazione
Customization
Personnalisation
Personalisierung

+28

Colori
Colours | Couleurs | Farben

+60

Tessuti
Fabrics | Tissus | Stoff

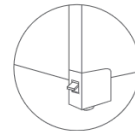
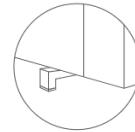
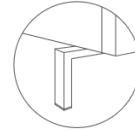
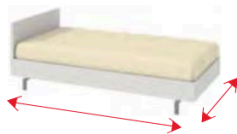
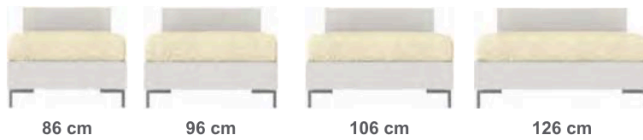

Le nostre collezioni
Our collections:
Nos collections:
Unsere Kollektionen:

system **FH2**
system **FH2**
system **FH1**
system **FH1**



System FH28

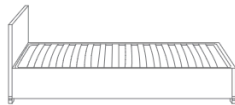
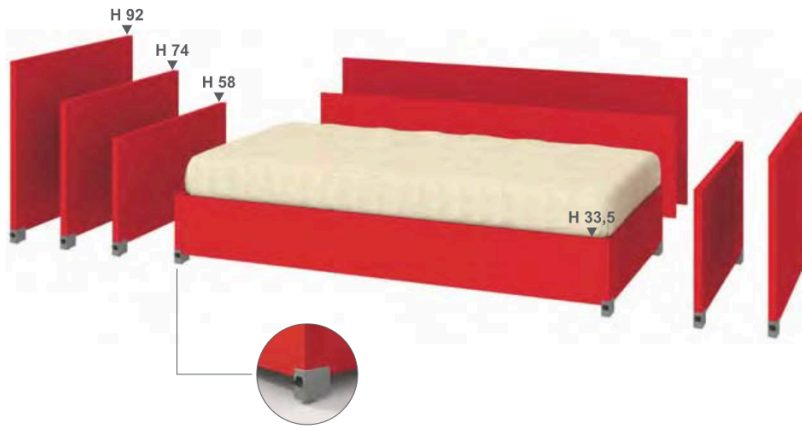

Tipologie
Typologies
Typologies
Typologien

Rete fissa
Fixed slats
Sommier fixe
Fixlattenrost

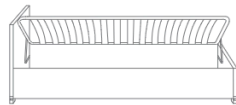

Letto con contenitore
Bed with storage base
Lit avec rangement
Bett mit Kasten

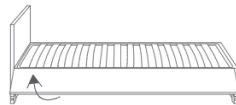

*** Letto con fascia apribile**
Bed with liftable frame
Lit avec bande ouvrante
Bett mit aufklappbarer Leiste



*** Cassettoni su ruote**
Big drawers on wheels
Grands tiroirs sur roulettes
Schubladen auf Rollen

*** Accessori**
Accessories
Accessoires
Zubehör



*** Rete estraibile**
Pull-out slats
Sommier extractible
Ausziehbarer Lattenrost



*** Rete estraibile con testata**
Pull-out slats with headboard
Sommier extractible avec tête
Ausziehbarer Lattenrost mit Kopfteil



System FH28 BIG



Testata e pediera BIG Sp. 10 cm realizzabili unicamente in tessuto
BIG Headboard and footboard Th. 10 cm available only on fabric
Tête et pied BIG Ep. 10 cm réalisables uniquement en tissu
Kopfteil und Fussende BIG St. 10 cm nur aus Stoff realisierbar

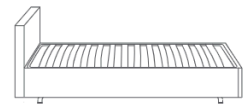

Tipologie
Typologies
Typologies
Typologien

Rete fissa
Fixed slats
Sommier fixe
Fixlattenrost



Letto con contenitore
Bed with storage base



System FH19

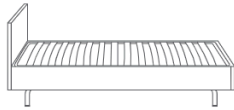

Tipologie
Typologies
Typologies
Typologien

Rete fissa
Fixed slats
Sommier fixe
Fixlattenrost

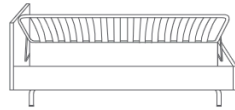

Letto con contenitore
Bed with storage base
Lit avec rangement
Bett mit Kasten



System FH10

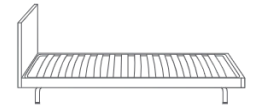
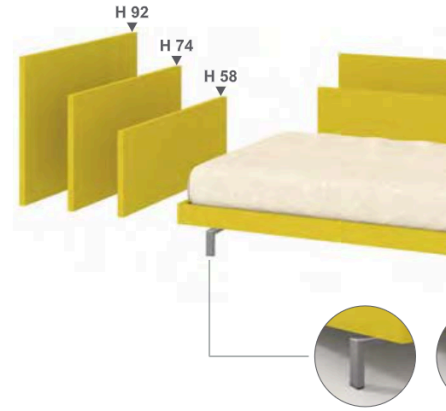

Tipologie
Typologies
Typologies
Typologien

Rete fissa
Fixed slats
Sommier fixe
Fixlattenrost



Letti a castello

Bunk beds | Lits superposés | Etagenbetten



Finiture
Finishing
Finitions
Fertigbearbeitungen



Colori
Colours | Couleurs | Farben



Sistemi di salita
Ladders and stairs
Echelles et escaliers
Treppen / Leitersysteme



Protezioni
Protection bars
Protections
Schutzvorrichtungen



Accessori
Accessories
Accessoires
Zubehör



Meccanismo per
System for the
Mécanisme pour l
Mechanismus zu



su Misura
Custom-made
Sur-mesure
Maßgeschneidert





Sistemi di salita

Ladders and stairs | Echelles et escaliers | Treppen / Leitersysteme



Scala a pioli da riporre nell'apposito contenitore.
Rung ladder that fits in side storage unit.
Echelle à placer dans le logement prévu.
Leiter mit Unterbringung in speziellem Stauraum.



Salita da posizionare a lato del letto. Possibilità di aggiunta di cassetti.
Stair placed next to bed. Drawers can be added.
Escalier à placer le long du lit. Possibilité d'ajouter des tiroirs.
Seitlich am Bett angeordnete Treppe.
Möglichkeit zusätzlicher Schubladen.



Salita da posizionare lungo il letto, dotata di mensola e contenitore. Possibilità di aggiunta di cassetti.
Stair that fits alongside the bed, equipped with shelf and storage unit. Drawers can be added.
Escalier à placer le long du lit avec étagère et élément.
Possibilité d'ajouter des tiroirs.
Treppe wird seitlich am Bett angeordnet und stellt einige Staufächer zur Verfügung. Möglichkeit zusätzlicher Schubladen.



Protezioni

Protection bars | Protections |

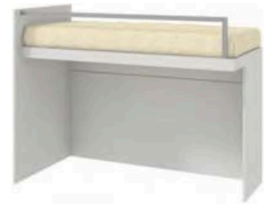



Proposte

Proposals | Propositions | Vorschläge

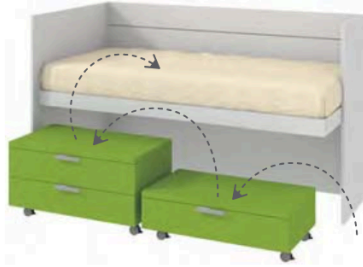

LETTI
1x2

Letti 1x2

1x2 Beds | Lits 1x2 | Betten 1x2



Finiture

Finishing
Finitions

Fertigbearbeitungen



Colori

Colours | Couleurs | Farben



2 letti nello spazio di 1

2 beds in the space of one
2 lits à la place d'un
2 Betten auf dem Platz von 1



Disponibile in oversize fino ad una piazza e mezza

Available in oversize, up to the size of a queen bed
Disponible en oversize jusqu'à une place et demie
Auch in Übergröße als französisches Bett verfügbar



Rifacimento semplice

Easy rearranging
Facile à faire
Bettenbeziehen leicht gemacht



Sacca portaoggetti in tessuto

Fabric storage unit
Poche porte-objets en tissu
Stofftaschen zum Verstauen von Gegenständen



Plus

Plus
Plus
Plus



Accessori

Accessories
Accessoires
Zubehör



Posizione scala

Positioning of the ladder
Position de l'échelle
Leiterpositionierung



su Misura

Custom-made
Sur-mesure
Maßgeschneidert





Letti 1x2 con piedi o con ruote

1x2 with feet/wheels | 1x2 avec pieds/roulettes | 1x2 mit Füßen/Rollen



Larghezze
Widths
Largeurs
Breiten

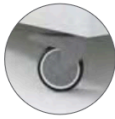

86 cm

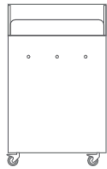

96 cm

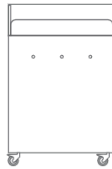

106 cm

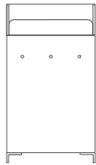

86 cm

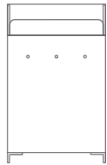

96 cm

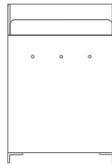

106 cm

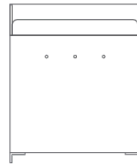

126 cm



Letti 1x2 con fascia ap

1x2 liftable frame | 1x2 bande c



Larghezze
Widths
Largeurs
Breiten

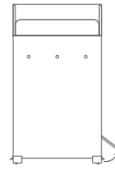

86 cm



96 cm

Accessori
Accessories
Accessoires
Zubehör



Cassettoni su ruote
Big drawers on wheels
Grands tiroirs sur roulettes
Schubladen auf Rollen



Rete
Pull-
Sommie
Ausziehba



Scrittoi

Writing desks | Bureaux | Schreibtische



Finiture
Finishing
Finitions
Fertigbearbeitungen



Colori
Colours | Couleurs | Farben



Piano scrittoio

Writing top | Plan bureau | Schreibtischplatte



su Misura
Custom-made
Sur-mesure
Maßgeschneidert



Personalizzazione
Customization
Personnalisation
Personalisierung

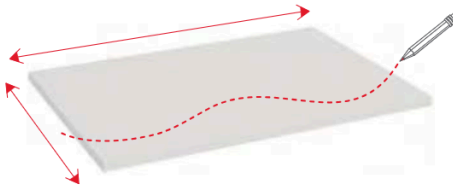

Supporti

Supports | Soutiens | Stützen



Gambe
Legs
Pieds
Beine

Gamba fissa o con ruota
Set leg or with wheel
Pied fixe ou avec roulette
Rollbares oder festes Tischbein

Strutture
Frames
Structures
Rahmen



Moduli
Units
Modules
Elemente





Proposte

Proposals | Propositions | Vorschläge



Scrittoi con struttura in metallo

Il piano scrittoio può essere realizzato al cm estendendosi oltre la struttura

Metal frame writing desk. The desktop can be manufactured based on size requests, extending beyond the frame

Bureaux avec structure en métal. Le plan bureau peut être réalisé au cm en s'étendant outre la structure

Schreibtische mit Metallstruktur. Die Abmessungen der Tischplatte können auf den Zentimeter genau angefertigt werden und länger als die Struktur sein



Scrittoio con doppio piano girevole

Il piano inferiore è estraibile e ruotabile in tutte le direzioni

Writing desk with rotating double top. The lower top can be extracted and rotated in all directions

Bureau avec double plan tournant. Le plan inférieure est extractible et pivotant dans toutes les directions

Schreibtisch mit doppelter drehbarer Tischplatte. Die untere Platte ist herausziehbar und kann in alle Richtungen gedreht werden



Scrittoi con doppio piano indipendente

Lo scrittoio su ruote è una superficie di lavoro riposta sotto lo scrittoio

Writing desk with independent double top on wheels. The mobile cabinet can be placed underneath the fixed top

Bureaux avec double plan indépendant sur roues. Le tiroir mobile est un plan de travail qui peut être rangé sous le bureau fixe

Schreibtische mit doppelter Arbeitsfläche auf Rollen. Bei Bedarf kann der mobile Schreibtisch unter den fixen Schreibtisch gestellt werden



Scrittoi con Multibox

Le possibilità di realizzazione di scrittori personalizzabili a seconda delle esigenze

Writing desks with Multibox. You can create infinite and customizable options, based on your needs

Bureaux avec Multibox. Les possibilités de réalisation sont infinies et personnalisables

Schreibtische mit Multibox. Multibox bietet für jeden Schreibtisch die Möglichkeit einer maßgeschneiderten Lösung

Concept & Graphic Design
DASudio by Erba

Print 03.2014

ERBA s.r.l.

Via don Guanella, 28 - c.p. 119
22066 Mariano Comense (Como)
T +39 031 746 663
F +39 031 750 624
www.erbamobili.it
erba@erbamobili.it

