

DESALTO

**Design
Cloud
#2**

indice generale /general index

tavoli
/tables

Clay
4-11, 46-51

Icaro 015
14-25, 52-59

Skin
28-33, 60-63

sedute
/seats

Sand tessuto
4-9, 64-67

Nara
22-23, 28-31,
68-71

Koki
10-11, 18-21,
32-33, 72-75

sistemi
/systems

Sail
34-37, 80-83

complementi
/complements

Helsinki 15 outdoor
40-43, 76-79

**Design
Cloud
#2**

**under
sky
three**



> **Clay** /table

Sintesi perfetta di bellezza ed armonia delle proporzioni, Clay è un oggetto dall'estetica pura capace di connotare l'ambiente in cui si trova grazie alla sua spiccata personalità.

Perfect blend of beauty and proportions harmony, Clay is an object with a pure aesthetics and capable of defining the space where it is placed with its own pronounced personality.



> **Clay** /table

Clay è un tavolo-scultura nato dall'incontro di due volumi: il piano e il basamento, in equilibrio uno sull'altro, sperimentano l'appoggio ardito di una sezione ridotta al minimo.

Clay is a table-sculpture born from the encounter between two volumes: the top and the base balanced one on the other, a daring experiment in resting on a section reduced to a minimum.



> **Sand tessuto** /chair

Un classico della collezione Desalto riproposto nella nuova versione in tessuto che le conferisce un aspetto più informale adattandosi così a diversi ambienti.

A classic of Desalto collection showcased in the new version with fabric cover, that gives it a more informal aspect, thus adapting to different environments.

> **Clay** /outdoor

Lo speciale rivestimento in pietra lavica applicata tramite spatolatura manuale dona un'idea di naturalezza ed è ideale anche per ambienti esterni dove crea atmosfere suggestive.
The special lava stone finishing applied manually by a broad knife gives an idea of naturalness and is also ideal for outdoor areas, where creates suggestive atmospheres.







> **Icaro 015** /small table

La struttura in acciaio che caratterizza la collezione Icaro 015 incorpora dei cassetti ad estrazione totale: elementi funzionali che non ne pregiudicano l'estetica.
The steel frame characterizing the Icaro 015 collection incorporates full extendible drawers: functional elements that do not affect the aesthetics.

> **Icaro 015** /small table
Anche in versione tavolino, Icaro 015 mantiene le stesse caratteristiche di eleganza e raffinatezza. Le "slitte" di raccordo per le gambe gli conferiscono una linea più geometrica.
Icaro 015 in the small table version has the same characteristics of elegance and refinement. The connection slides for the legs give it a more geometrical line.



> **Icaro 015** /table
Rivisitazione di un prodotto storico di successo, Icaro 015
viene riproposto con una linea più essenziale ed attuale.
*Restyling of a successful historical product, Icaro 015 is
reintroduced with a more essential and modern shape.*





> **Koki** /chair

Sedia ispirata al mondo del contract, trova ideale collocazione anche all'interno di spazi privati e all'aperto conferendone un tocco di freschezza. In Koki tecnologia e design si fondono perfettamente. Linee e dettagli armonici danno origine ad una forma affascinante da ogni prospettiva la si guardi.
Chair inspired by the world of contract, it can find also an ideal location within private and outdoor spaces giving a touch of freshness.

In the Koki chair, technology and design merge perfectly. Lines and harmonious details create a shape which appeals whichever way you look at it.





> **Icaro 015** /console

La collezione Icaro 015 si declina anche in una versatile console dalla linea estremamente pulita, perfetta per valorizzare ogni ambiente.

Icaro 015 collection also boasts a versatile console with an extremely clean line, perfect to enhance any environment.





> **Nara** /chair

Accogliente seduta dal sapore classico per rilassanti conversazioni. La forma arrotondata viene impreziosita dai nuovi rivestimenti in tessuto.

Cozy chair with a classical flavour for relaxing conversations. The rounded shape of the upholstered seat is enhanced by new fabric covers.

> **Skin** /table

Nel tavolo Skin il design si fonde con un'attenta ricerca tecnologica. Le generose dimensioni raggiungibili lo rendono adatto sia alla zona living che per uffici e sale riunioni.
In Skin table, design merges with a careful technological research. The generous sizes that can be reached make it suited to the living area, offices and meeting rooms.



> **Skin** /table

Skin, nella sua versione allungabile, esprime il know-how dell'azienda nella lavorazione del metallo e nella ingegnerizzazione di cinematismi, creando un perfetto connubio fra forma, funzionalità ed innovazione.

Skin, in its extendible version, expresses the Company's know-how in metal manufacturing and engineering of mechanisms, creating a perfect combination of form, functionality and innovation.





> **Sail** /system

Il sistema Sail offre molteplici soluzioni per il supporto TV, ideali sia per ambienti domestici che pubblici. Nella versione a parete, il particolare segno grafico dona estrema leggerezza all'oggetto, rendendolo particolarmente gradevole.

Sail system offers many solutions for TV stand, ideal for both domestic and public settings. In the wall fixing version, the particular graphic shape gives lightness to the item, making it particularly appealing.







> **Helsinki 15 outdoor** /complements

I tavolini Helsinki, nella versione per esterni, permettono contaminazioni di ambienti indoor e outdoor per un unico, raffinato spazio living.

The small tables Helsinki, in the outdoor version, are allowed to meddle in indoor and outdoor environments for a unique, refined living space.





tavoli
/tables

Clay
46-51

Icaro 015
52-59

Skin
60-63

sedute
/seats

Sand tessuto
64-67

Nara
68-71

Koki
72-75

sistemi
/systems

Sail
80-83

complementi
/complements

Helsinki 15 outdoor
76-79

Clay

Marc Krusin 2015

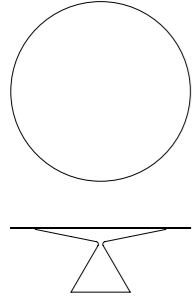

altezza /height
piano ceramica /ceramic top 73 cm
piano cristallo /glass top 73,2 cm
piano MDF /MDF top 74 cm
misure /measures
ø 120 /140 /160 /180 cm



Clay

Tavolo con base in poliuretano rigido disponibile nei colori bianco o grafite, lucido o opaco, oppure nella speciale finitura in pietra lavica spatolata manualmente. Piani in cristallo temperato da 8 mm bianco o grafite nelle versioni lucido o opaco, ceramica da 6 mm nei colori bianco calce, asfalto o lava, MDF o cristallo spatolato pietra lavica. La versione con piano in ceramica o cristallo spatolato pietra lavica è utilizzabile anche per outdoor.

Table with base in rigid polyurethane available in white and graphite colours, glossy or matt, or in the special lava stone finish spread by hand using a broad knife. Tops in toughened glass 8 mm white or graphite in glossy or matt versions, ceramic 6 mm in the following colours: white calce, asphalt or lava, in MDF or glass covered with lava stone paste. The version with top in ceramic or glass covered with lava stone is suitable also for outdoor.





Tisch mit Gestell aus hart-Polyurethan verfügbar in den Farben weiss oder graphite, glänzend oder matt, oder in der Spezialausführung aus Lavastein Hand gespachtelt. Temperierte Glasplatten 8 mm weiss oder graphite in den Ausführungen glänzend oder matt, Keramik 6 mm in den Farben weiss calce, asphalt oder Lava, oder aus MDF oder Glas mit Lavastein gespachtelt. Die Version mit Platte aus Keramik oder aus Glas mit Lavastein gespachtelt ist geeignet auch für den Aussenbereich.

Table avec base en polyuréthane rigide disponible dans les finitions blanc ou graphite, brillant ou mat, ou encore dans la spéciale finition en pierre de lave, obtenue par étalement manuel avec une spatule. Plateaux en verre trempé 8 mm blanc ou graphite,

dans la version brillante ou mat, en céramique 6 mm dans les couleurs blanc chaux, asphalt et lava, en MDF ou en verre revêtus de pierre de lave. Avec plateau en céramique ou en verre revêtu de pierre de lave utilisable aussi à l'extérieur.

Mesa con base en poliuretano rígido disponible en los colores blanco o grafito, brillante o mate, o en el acabado especial en piedra de lava, obtenido mediante aplicación manual con espátula. Encimeras en cristal templado mm 8 blanco o grafito en las versiones brillante o mate, en cerámica 6 mm en los colores blanco calce, asfalto, lava, en MDF o en cristal revestido de piedra de lava. Con encimera en cerámica o en cristal revestido de piedra de lava utilizable en exteriores.

Icaro 015

Caronni + Bonanomi 2015

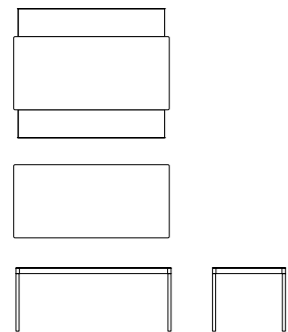

altezza /height 74 cm
misure /measures
85x140 cm
85x180 cm
85x220 cm
100x180 cm
100x220 cm
140x140 cm



Icaro 015

Tavoli, tavolini o console con struttura e cassetti in acciaio nelle finiture opache bianco o grafite, piani in cristallo temperato da 8 mm bianco o grafite nelle versioni opaco o lucido, oppure in ceramica da 6 mm bianco calce, cemento, asfalto o lava. Cassetti montati su guide a sfera ad estrazione totale. Portaoggetti per interno cassetti in neoprene lavabile di colore nero (opzionali).

Tables, small tables or console with frame and drawers in steel white or graphite matt finishes, tops in toughened glass 8 mm white or graphite in the matt or glossy versions, or in ceramic 6 mm white calce, concrete, asphalt and lava colours. Drawers on full extension ball bearing slides. Drawers storage accessories in washable black neoprene (optional).



Tische, Couchtische und Console mit Gestell und Schubladen aus Stahl in den matten Ausführungen weiss oder graphite, temperierte Glasplatten 8 mm weiss oder graphite in den matten oder glänzenden Versionen, oder aus Keramik 6 mm weiss calce, zement, asphalt oder lava. Schubladen auf Kugelführungen mit Völligauszug. Innen-Handschuhfach aus waschbarem Neopren in der Farbe schwarz (wahlfrei).

Tables, tables basses et consoles avec structure et tiroirs en acier dans les finitions mat blanc ou graphite, plateaux en verre trempé 8 mm laqué blanc ou graphite mat ou brillant, ou en céramique 6 mm

blanc chaud, ciment, asphalte ou lava. Tiroirs montés sur charnières coulissantes à roulement à extraction totale. Porte-objets pour l'intérieur des tiroirs en néoprène lavable, en couleur noir (en option).

Mesas, mesitas y consolas con estructura y cajones en acero en los acabados mates blanco o grafite, sobres en cristal templado 8 mm lacados blanco o grafite mate o brillante, o en cerámica 6 mm blanco calce, cemento, asfalto o lava. Cajones montados sobre guías esféricas de extracción total. Porta-objetos internos para cajones en neopreno lavable en color negro (opcional).



Icaro 015 console /small table

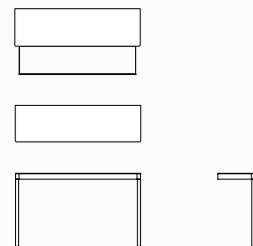

altezza /height 84 cm
misure /measures
42x140 cm



Per i tavolini sono disponibili "slitte" opzionali di raccordo per le gambe (in foto).

Connection slides for legs available for small tables (optional, see picture).

Für die Couchtische sind verfügbar Befestigungselemente zwischen den Beinen (in dem Foto).

Des platines de raccord entre les pieds sont disponibles en option pour les tables basses (voir photo).

Para las mesitas están disponibles piezas de conexión opcionales entre las patas (ver foto).

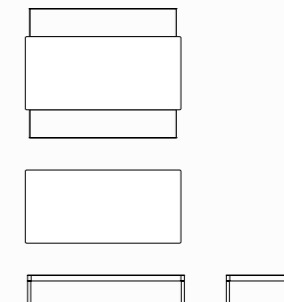

altezza /height 35 cm
misure /measures
85x140 cm
85x180 cm
85x220 cm
100x180 cm
100x220 cm
140x140 cm



Skin

Marco Acerbis 2015

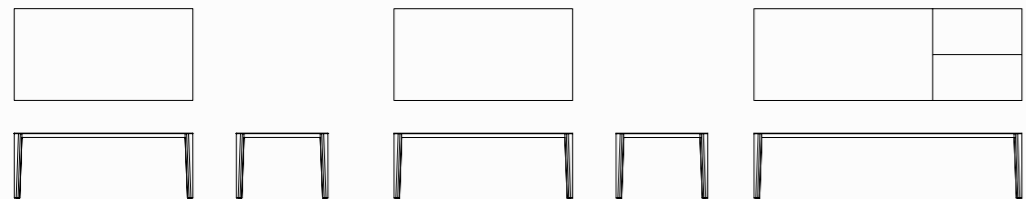

fisso /fix

altezza /height 73,5 cm
misure /measures
85x140 cm
85x170 cm
100x200 cm
100x300 cm
140x140 cm
200x200 cm

allungabile /extendible

altezza /height 73,5 cm
misure /measures
100x200 (300)



Tavolo fisso o allungabile con struttura in alluminio estruso nelle finiture opache laccato bianco, nero, tortora o grafite, oppure ossidiana spazzolato o litium. Piani in cristallo temperato da 8 mm bianco, tortora o grafite, nelle versioni opaco o lucido, oppure ceramica da 6 mm bianco calce, cemento, deserto o asfalto. La versione fissa con piano in ceramica e gambe laccate è utilizzabile anche per outdoor. Nella versione allungabile, il sottile telaio (42 mm) estensibile tramite apertura telescopica, contiene una prolunga con apertura a libro nello stesso materiale del piano.

Fix or extendible table with frame in extruded aluminium in the following matt finishes: lacquered white, black, turtle-dove, graphite, or brushed ossidiana or lithium. Tops in toughened glass 8 mm white, turtle-dove or graphite, matt or glossy version, or in ceramic 6 mm white calce, concrete, desert or asphalt colours.

The fix version with ceramic top and lacquered legs is suitable also for outdoor. In the extendible version, the thin frame (42 mm) extensible through telescopic opening, contains a folding leave in the same material and finish as the top.

Skin

Tisch fix oder ausziehbar mit Gestell aus extrudiertem Aluminium in den matten Ausführungen weiss, schwarz, tortora, graphite, oder aus gebürstetem Ossidiana oder Litium. Temperierte Glasplatten 8 mm weiss, tortora oder graphite, in den Ausführungen matt oder glänzend, oder aus Keramik 6 mm weiss calce, zement, asphalt. Die fixe Version mit Platte aus Keramik und lackierten Beinen ist geeignet auch für den Aussenbereich. In der Ausziehbaren Version, enthält der dünne Rahmen (42 mm), ausziehbar durch eine teleskopische Öffnung, eine Ausziehplatte mit Buchauszug, die in der gleichen Material der Platte ist.

Table fixe et à rallonges avec structure en aluminium extrudé en finition mate, laqué blanc, noir, tourterelle et graphite, ou en ossidiana brossé ou litium. Plateaux en verre trempé 8 mm laqué mat ou brillant dans les couleurs blanc, tourterelle ou graphite, ou en céramique 6 mm en couleur blanc chaud, ciment,

désert et asphalt. La version fixe avec plateau en céramique et pieds laqués est utilisable également à l'extérieur. Dans la version à rallonges, le cadre mince (42 mm), extensible au moyen d'une ouverture télescopique, contient une rallonge à fermeture portefeuille dans le même matériau et finition que le plateau.

Mesa fija o extensible con estructura en aluminio estruso en los acabados mates blanco, negro, tortora o grafito, o en ossidiana cepillada o litium. Sobres en cristal templado 8 mm en los colores blanco, tortora, grafite, en las versiones mate o brillante, o en cerámica 6 mm blanco calce, cemento, desierto o asfalto. La versión fija con encimera en cerámica y patas lacadas también es apta para uso en exterior. En la versión extensible, el marco delgado (42 mm), que se abre a través de una apertura telescópica, contiene una extensión a libro en el mismo material y acabado que el sobre.



Sand tessuto /chair

Pocci + Dondoli 2015

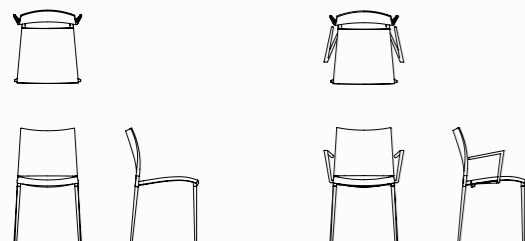

447

larghezza /width 47 cm
profondità /depth 54 cm
altezza totale /total height 82 cm
altezza seduta /seat height 45 cm

448

larghezza /width 53,5 cm
profondità /depth 54 cm
altezza totale /total height 82 cm
altezza seduta /seat height 45 cm

Sedia o sgabello con o senza braccioli, struttura in alluminio pressofuso nelle finiture alluminio lucido, litium, ossidiana opaco, ossidiana lucido, o laccata nei colori a listino. Seduta e schienale rivestiti in tessuto non sfoderabile, disponibili nelle varianti e colori a campionario.

Stacking chair or barstool, with or without armrests, die-cast aluminium frame in the following finishes: polished aluminium, lithium, polished or matt ossidiana, or lacquered in the colours as per price-list. Seat and frame covered with not removable fabric, available in the categories and colours as per our sample collection.

Stuhl oder Hocker mit oder ohne Armlehnen, Gestell aus Pressgussaluminium in den Ausführungen Aluminium glänzend, Litium, Ossidiana matt, Ossidiana glänzend, oder lackiert in den Farben laut

unsere Preisliste. Sitz und Rückenlehne aus Stoff, nicht abziehbar, verfügbar in den Farben von der Musterliste.

Chaise et tabouret avec ou sans accoudoirs, structure en aluminium moulé sous pression dans les finitions aluminium poli, litium, ossidiana mat, ossidiana brillant, ou laqué dans les couleurs indiquées dans le tarif. Assise et dossier revêtus en tissu non déhoussable, disponibles dans les coloris prévus en collection.

Silla o taburete con o sin brazos, con estructura en fusión de aluminio en acabados aluminio pulido, litium, ossidiana mate, ossidiana brillante o lacado en los colores indicados en la lista de precios. Asiento y respaldo revestidos en tejido no desenfundable, disponible en las variantes y colores de nuestro muestrario.



Sand tessuto /barstool

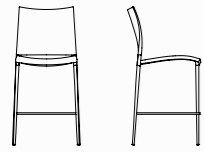

524
larghezza /width 47 cm
profondità /depth 54 cm
altezza totale /total height 99 cm
altezza seduta /seat height 64 cm

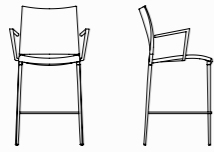

525
larghezza /width 53,5 cm
profondità /depth 54 cm
altezza totale /total height 99 cm
altezza seduta /seat height 64 cm

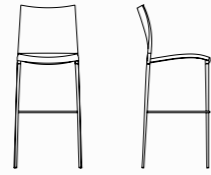

592
larghezza /width 47 cm
profondità /depth 54 cm
altezza totale /total height 115 cm
altezza seduta /seat height 80 cm



593
larghezza /width 53,5 cm
profondità /depth 54 cm
altezza totale /total height 115 cm
altezza seduta /seat height 80 cm



Nara

Piergiorgio Cazzaniga 2014

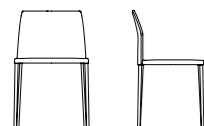

larghezza /width 50 cm
profondità /depth 51 cm
altezza totale /total height 78 cm
altezza seduta /seat height 46,5 cm

Sedia imbottita rivestita in tessuto nelle varianti e colori della collezione, oppure pelle o ecopelle. Scocca in poliuretano flessibile e gambe in alluminio pressofuso nelle finiture alluminio lucido, litium, ossidiana opaco, ossidiana lucido, o laccata nei colori a listino. La versione in tessuto è interamente sfoderabile.

Padded chair covered with fabric in the categories and colours of our collection, or leather or eco-leather. Body in flexible polyurethane and legs in die-cast aluminium in the following finishes: polished aluminium, lithium, polished or matt ossidiana, or lacquered in the colours as per price-list. The fabric version is fully removable.

Gepolsteter Stuhl bezogen aus Stoff in der Farben laut unserer Kollektion, oder aus Leder oder Kunstleder. Sitzschale aus Polyurethanschaum und Beine aus Pressgussaluminium in den Ausführungen Aluminium glänzend, Litium, Ossidiana matt, Ossidiana glänzend, oder lackiert in den Farben laut unserer Musterliste. Die Version aus Stoff ist komplett abziehbar.

Chaise rembourrée revêtue en tissu dans les coloris de la collection, ou en cuir souple ou en simili-cuir. Coque en polyuréthane flexible et pieds en aluminium moulé sous pression dans les finitions aluminium poli, litium, ossidiana mat, ossidiana brillant, ou laqués dans les finitions indiquées dans le tarif. Le revêtement en tissu est complètement déhoussable.

Silla tapizada revestida en tejido en las variantes y colores de nuestro muestrario, o en piel o piel ecológica. Casco en poliuretano flexible y patas en presofusión de aluminio en los acabados aluminio pulido, litium, ossidiana mate, ossidiana brillante o lacado en los colores indicados en la lista de precios. La versión en tejido es completamente desenfudable.





Koki

Pocci + Dondoli 2015

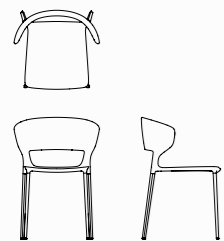

larghezza /width 55 cm
profondità /depth 50 cm
altezza totale /total height 78 cm
altezza seduta /seat height 45 cm



Sedia impilabile con scocca autoportante in poliuretano integrale contenente una struttura in acciaio. Verniciatura realizzata in stampo nelle sette tonalità goffrate a campionario. Gambe d'acciaio in tubolare conificato a sezione quadra nelle finiture cromo, litium, ossidiana opaco o laccate negli stessi colori della scocca. La versione con gambe laccate è utilizzabile anche per outdoor.

Stacking chair with self-standing body in integral polyurethane, containing a steel frame. Mould-coating available in seven different embossed colours as per sample collection. Steel legs in conic shape tubular, square section, in the following finishes: chrome, lithium, matt ossidiana or lacquered in the same colours as the body. The version with lacquered legs is also suitable for outdoor.



Stapelbarer Stuhl mit integralem Polyurethan mit Stahlgestell. Lackierung in Form hergestellt in den sieben gaufrierten Farben der Musterliste. Beine aus konischem Rohr Stahl mit quadratischem Abschnitt in den Ausführungen chrom, litium, Ossidiana matt oder lackiert in den gleichen Farbe von dem Sitzschale. Die Version mit lackierten Beinen ist geeignet auch für den Aussenbereich.

Chaise empilable avec coque autoportante en mousse de polyuréthane intégrale et structure intérieure en acier. Laquage au moulage dans les sept couleurs gaufrées en collection.

Pieds tubulaire en acier conique à section carrée dans les finitions chrome, litium, ossidiana mat, ou laqués dans les mêmes couleurs de la coque. La version avec pieds laqués est utilisable aussi à l'extérieur.

Silla apilable con casco en poliuretano integral barnizado en molde, con estructura interna en acero. Disponible en los siete colores gofrados en la colección. Patas en acero cónico con sección cuadrada en los acabados cromo, litium, ossidiana mate o lacado en los mismos colores que el casco. La versión con patas lacadas es apta para uso en el exterior.



Helsinki 15 outdoor

Caronni + Bonanomi 2015

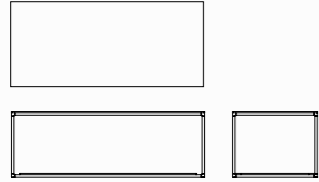

altezza /height
25-30-40-50-55 cm
misure /measures:
35x35
35x118
35x140
52x52
52x78
52x118
52x140
78x78
78x118
78x140
118x118



Helsinki 15 outdoor

Sistema di tavolini con struttura tubolare in acciaio inox, sezione 1,5x1,5 cm e giunti in pressofusione. Finiture opache bianco, grafite o corda. Piani in ceramica da 6 mm nei colori bianco calce, cemento, asfalto, lava o deserto.

Range of small tables with stainless steel frame, section 1,5x1,5 cm, and die-cast joints.

Matt finishes white, graphite or rope beige.

Tops in ceramic 6 mm in the following colours: white calce, concrete, asphalt, lava or desert.

System von Couchtischen mit Rohrgestell aus Edelstahl, Sektion 1,5x1,5 cm und Verbindungselemente aus Pressguss. Matte Ausführungen weiss, graphite oder seilbeige. Platten aus Keramik 6 mm in den Farben weiss calce, zement, asphalt, lava oder wüste.

Système de tables basses avec structure tubulaire en acier inox, 1,5x1,5 cm et joints moulés sous pression. Finitions mates blanc, graphite ou corde. Plateaux en céramique 6 mm en couleur blanc calce, ciment, asphalte, lava, désert.

Sistema de mesitas con estructura en tubo de acero inoxidable, sección 1,5x1,5 cm y juntas en presofusión. Acabados mates en los colores blanco, grafite o corda. Encimeras en cerámica 6 mm en los colores blanco calce, cemento, asfalto, lava o desierto.



Sail

Caronni + Bonanomi 2015

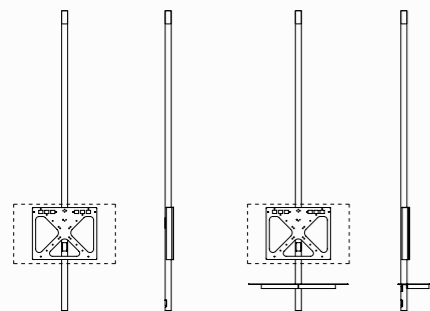

307 D01 /D02
altezza box porta TV /TV panel height 94 cm
altezza max soffitto /ceiling max height 350 cm

307 D03 /D04
altezza box porta TV /TV panel height 119 cm
altezza max soffitto /ceiling max height 350 cm

307 D05 /D06
altezza box porta TV /TV panel height 151 cm
altezza max soffitto /ceiling max height 350 cm

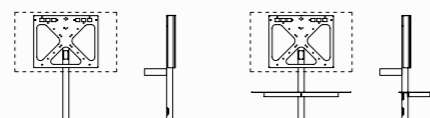

304 C01 /C02
altezza /height 94 cm

304 C03 /C04
altezza /height 119 cm

304 C05 /C06
altezza /height 151 cm

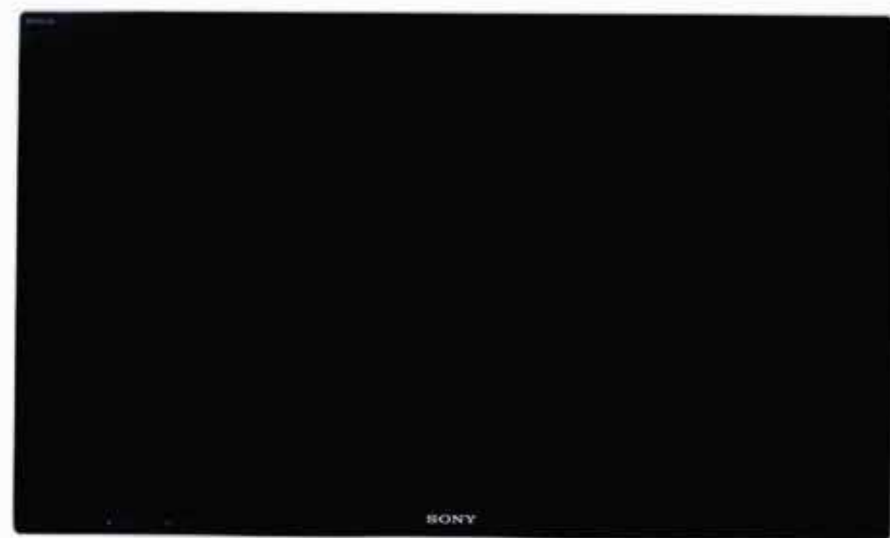

Sail



Porta TV a piantana girevole con fissaggio pavimento/soffitto. Box porta TV nelle altezze: 94, 119, 151. Disponibile con o senza mensola. Nella versione con mensola, la stessa ruota insieme alla struttura.

TV-stand with swivelling floor-ceiling upright. TV panel at the following heights: 94, 119, 151. Available with or without shelf. In the version with shelf, the same rotates together with the frame.

TV-Träger mit drehbarem Ständer mit Boden/Decke Befestigung. Tv-Träger in den Höhen: 94, 119, 151. In der Version mit Boden, dreht der Boden zusammen mit dem Gestell.

Porte-TV avec montant pivotant à fixation sol-plafond. Positionnement du panneau porte-TV aux hauteurs 94, 119, 151 cm. Disponible avec ou sans étagère. Dans la version avec étagère, celle-ci pivote avec la structure.

Porta TV con montante giratorio con fijación a techo. Posicionamiento del panel porta-TV en las alturas cm 94, 119, 151. Disponible con o sin repisa. En la version con repisa, esta gira con la estructura.



Porta TV a piantana con fissaggio pavimento/parete. Box porta TV girevole nelle altezze: 94, 119, 151. Disponibile con mensola (fissa) o senza.

Swivelling TV-stand with rear fixing system to the wall. TV panel at the following heights: 94, 119, 151. Available without or with fixed shelf.

Tv Träger mit Befestigung Boden/Wand. Drehbarer Tv-Träger in den Höhen: 94, 119, 151. Verfügbar mit Boden (fix) oder ohne.

Porte TV avec fixation sol/mur. Positionnement du panneau porte-TV aux hauteurs 94, 119, 151 cm. Disponible avec ou sans étagère (fixe).

Porta TV con fijación suelo/pared. Posicionamiento del panel porta-TV en las alturas cm 94, 119, 151. Disponible con o sin repisa (fija).

project
chiara boselli studio

concept image and styling
elisa ossino studio

still life
p 48-83 davide lovatti

pre press
de pedrini

print
grafica gioia

© 09.2015
printed in italy

thanks to
abc italia
atelier areti
flos
golran
l'arte nel pozzo
living divani
marco guazzini
norman copenhagen
paola paronetto
vertigo bird
vitra
zero lighting



desalto spa
via per montesolaro
22063 cantù (como) italia
t. +39 031 7832211
f. +39 031 7832290
info@desalto.it
www.desalto.it

