

THE WOOD



PARK  AVENUE

Precious Wood Floors

REAL MATERIAL
EXCELLENT CRAFT
UNIC DESIGN
PERSONALIZED

Park Avenue presents “Precious Wood Floors”, a journey that celebrates the culture of wood and the art of craftsmanship, a collection that embodies the essence of exclusivity by celebrating the beauty of Italian artistry. Excellence is not just an objective, but a commitment maintained by Park Avenue. Tapping into the profound values of traditional Tuscan craftsmanship and knowledge of antique wood flooring, each element is a tribute to craftsmanship and dedication.



Park Avenue celebrates beauty in its purest form. The rigorous choice of woods, combined with meticulous and detailed workmanship, creates settings with extraordinary balance, reflecting all the creativity of the craftsmanship.



With uncompromising aesthetic research, THE WOOD collection offers original installation styles and sophisticated textural mixes. Precious wood, stone, marble and metals are mixed to create a broad range of patterns, turning each wood floor element into a work of art.



True magic surfaces when each space has the ability to reflect the unique essence of its inhabitant. Park Avenue appreciates the importance of personal expression by offering a broad variety of wood types, finishes and shades: the key to making each room a pure reflection of the taste and character of the person that lives in it.



INDEX



Castle	13
Ship	19
Phoenix	25
Thread	29
Hydra	31
Tie	37
Mansion	41
Spectrum	43
Hive	47
Lacunari	53
Hexagonal	57
Weaving	61
Bee	63
Labirinth	67
Herringbone	73
Herringbone & Metal	77
Planks Balloon	83
Material Library	85



Castle

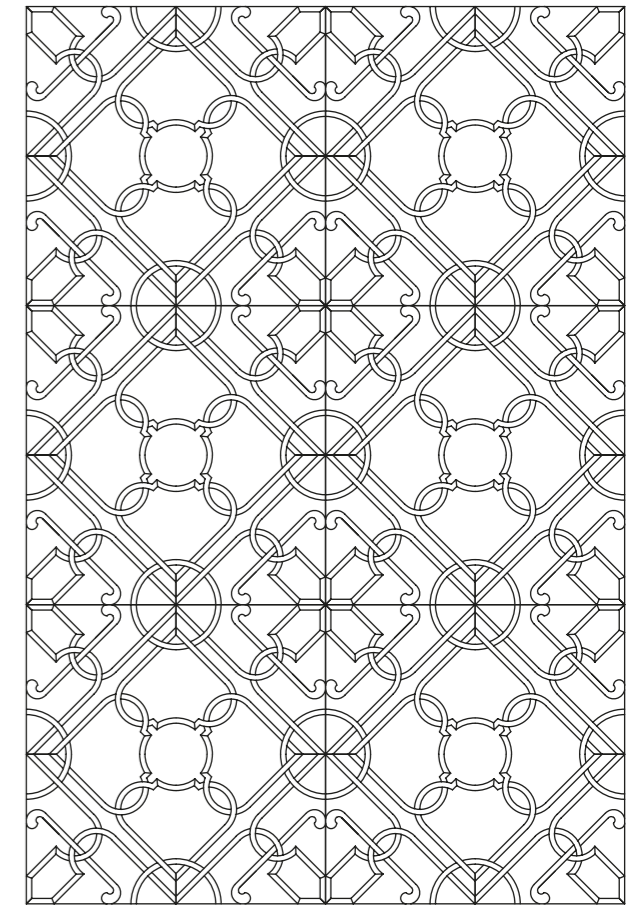
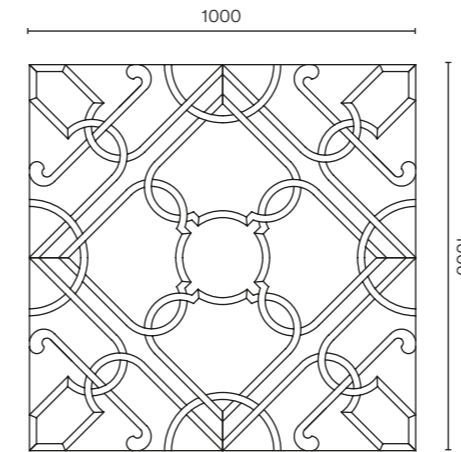

- Size:** 1000x1000 mm
- Thickness:** 15/4 mm
- Wood type:** Rustic oak
PKCASTLE
- Processing:** Hand sanded
- Colour:** Light glossy walnut
- Finish:** Oil and wax

Wood types, finishes and colours can be customised on request.



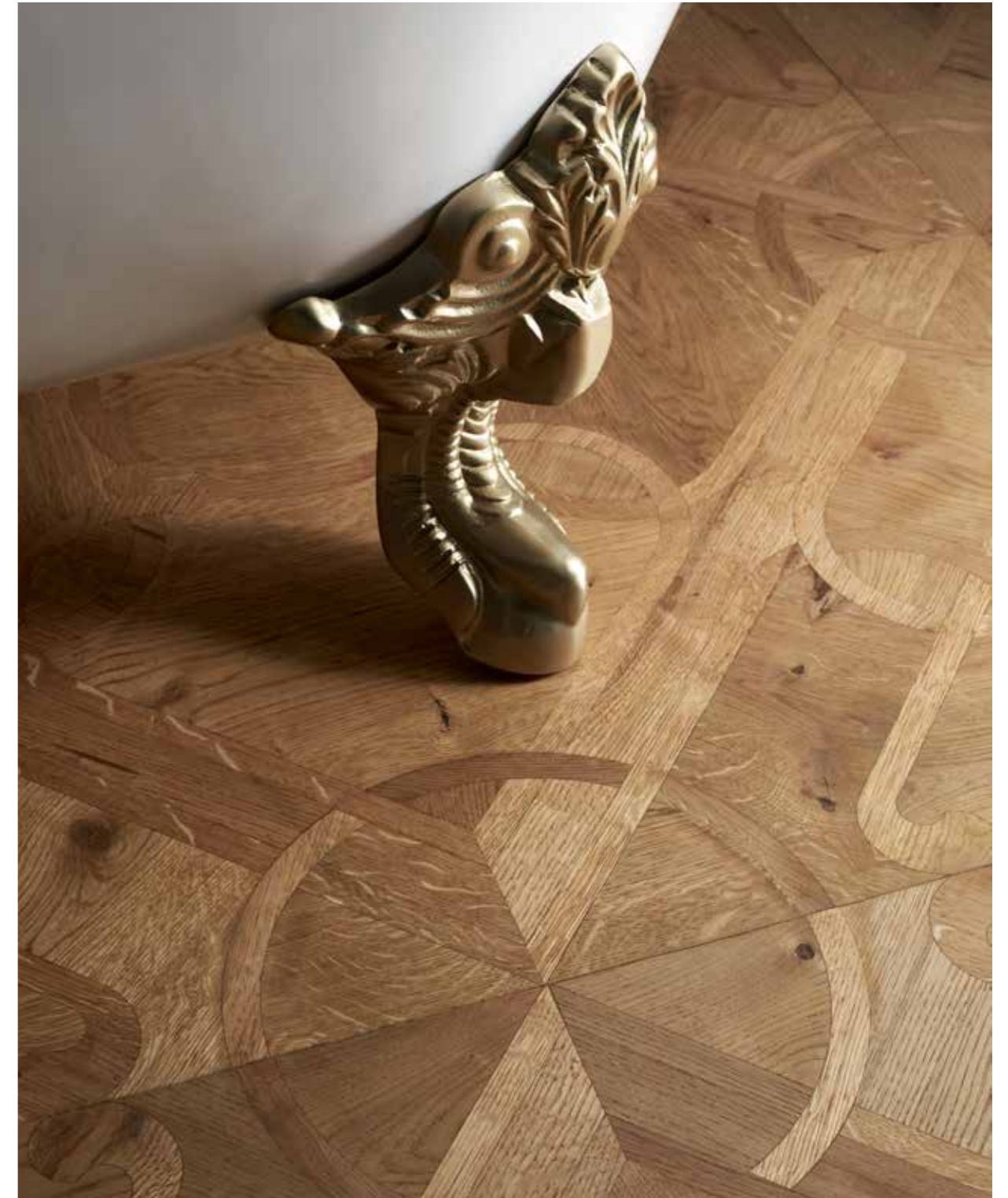

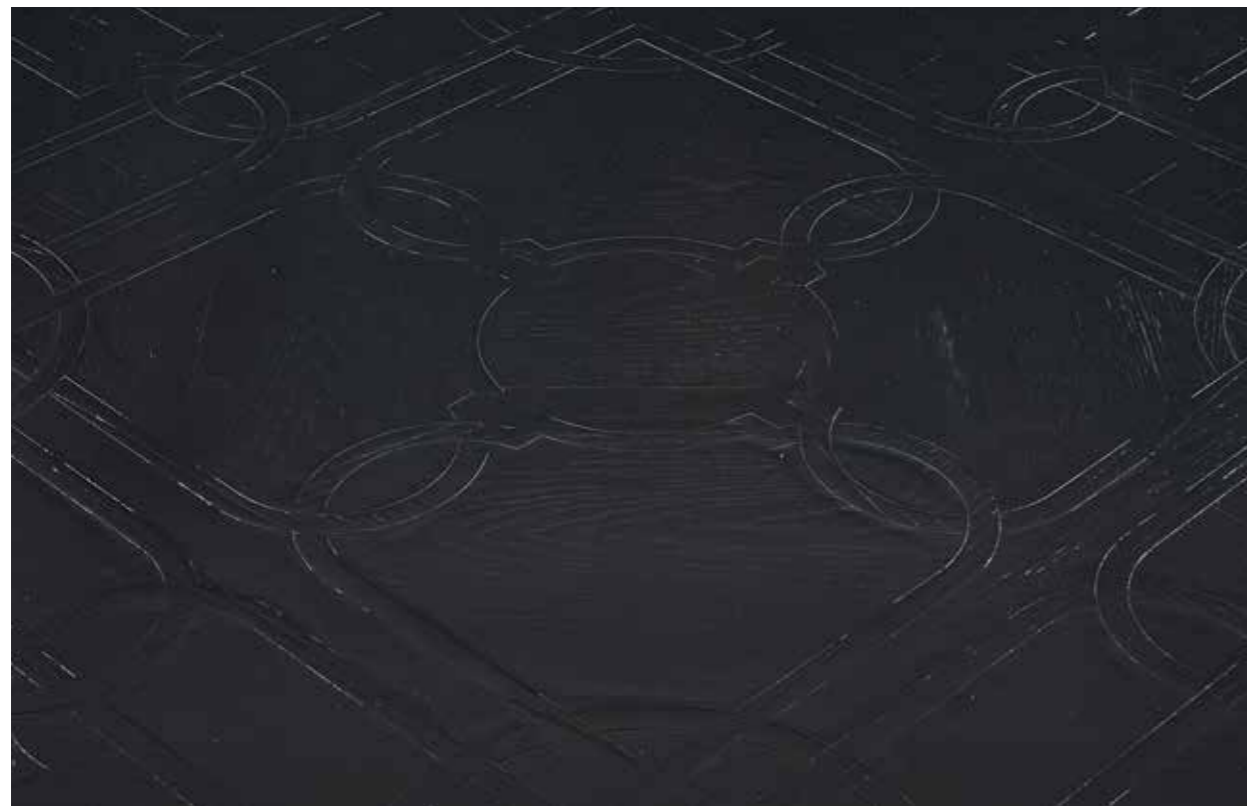



Ship

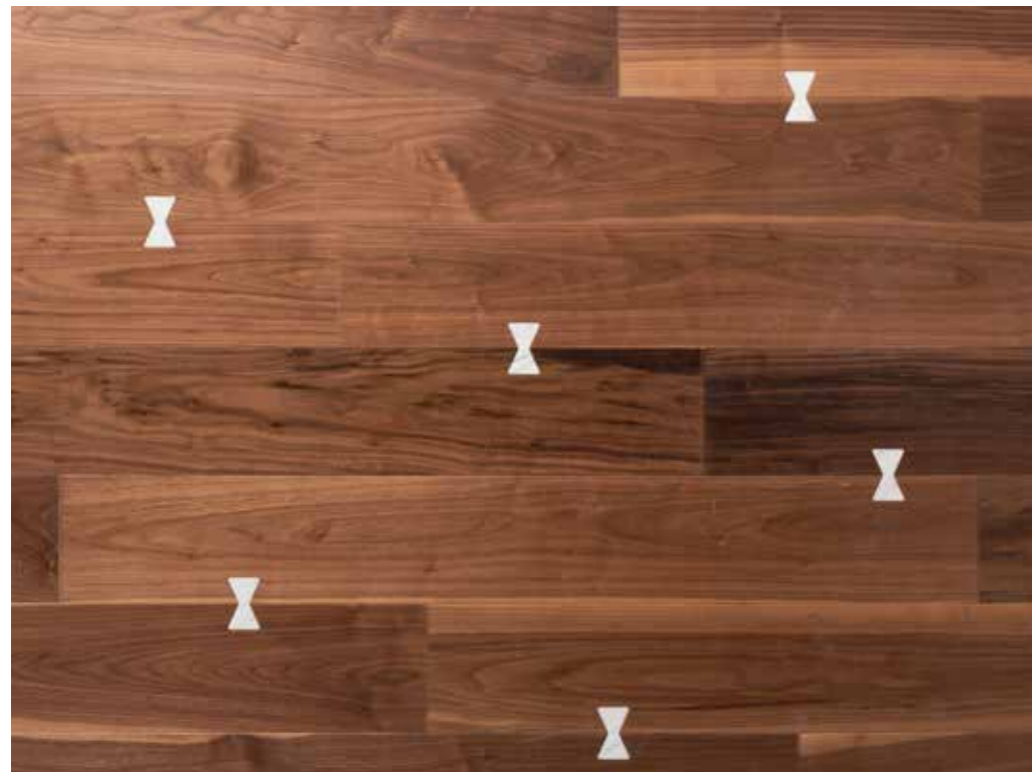
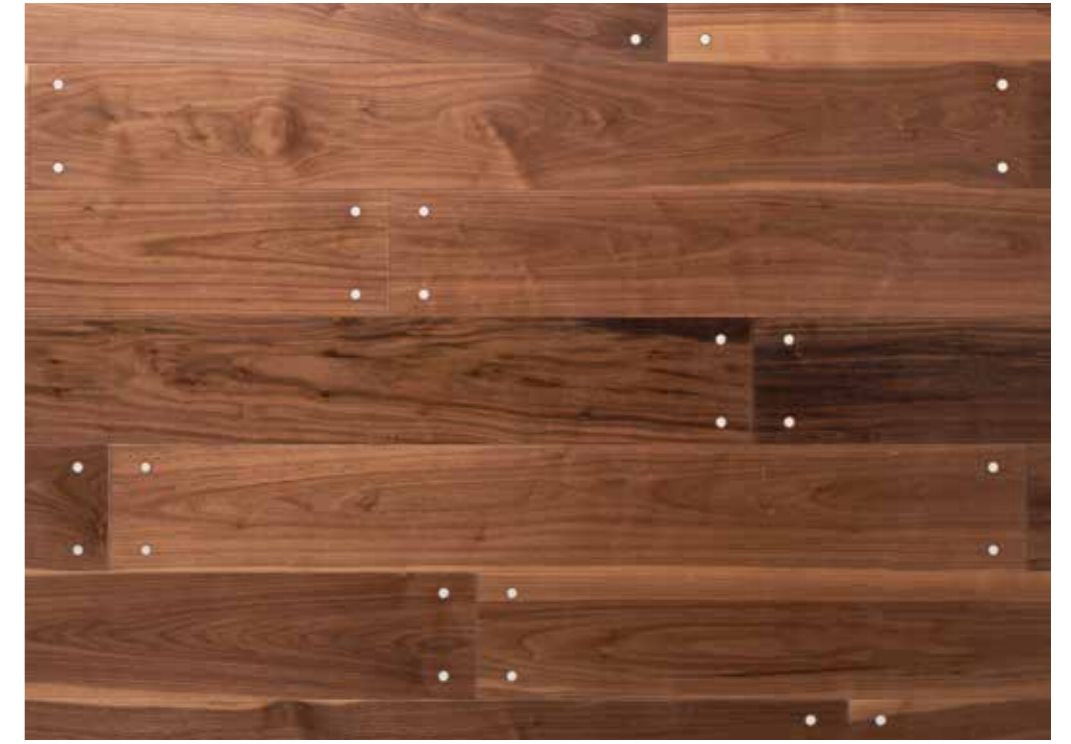

Ship Stick

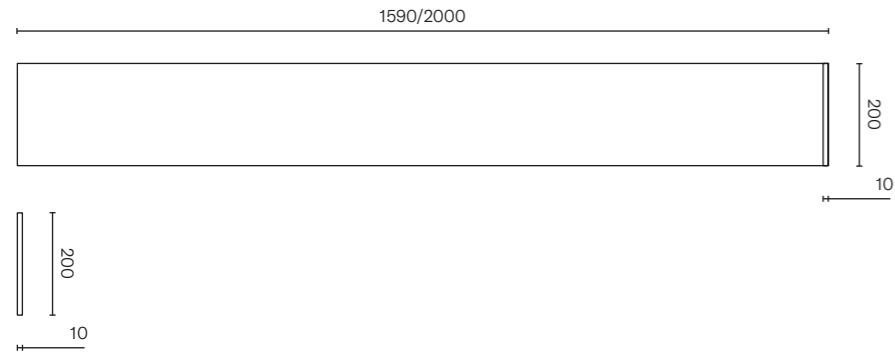

Size: 200 x 1590/2000 mm (approximately)
 Thickness: 15/4 mm
 Wood type: American walnut | Maple
 Inserts: Stone | Marble | Metal | Wood
 PKSTICKNCAR
 Processing: Hand sanded
 Colour: Natural
 Finish: Oil and wax

Wood types, finishes and colours can be customised on request.

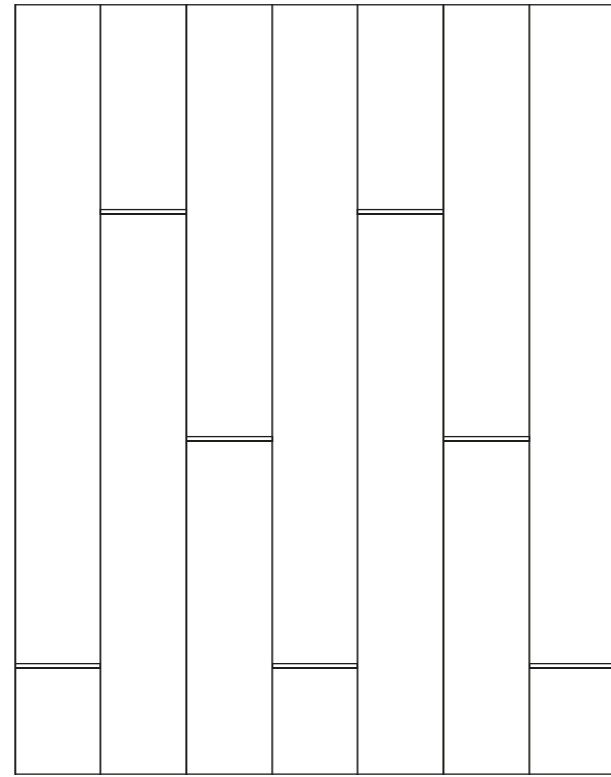

Ship Dots

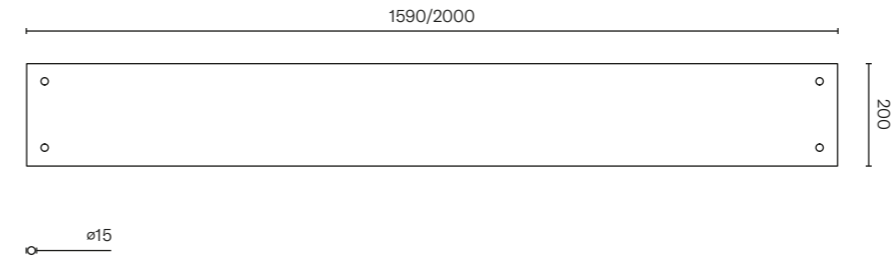

Size: 200 x 1590/2000 mm (approximately)
 Thickness: 15/4 mm
 Wood type: American Walnut | Maple
 Inserts: Stone | Marble | Metal | Wood
 PKDOTSNCAR
 Processing: Hand sanded
 Colour: Natural
 Finish: Oil and wax

Wood types, finishes and colours can be customised on request.

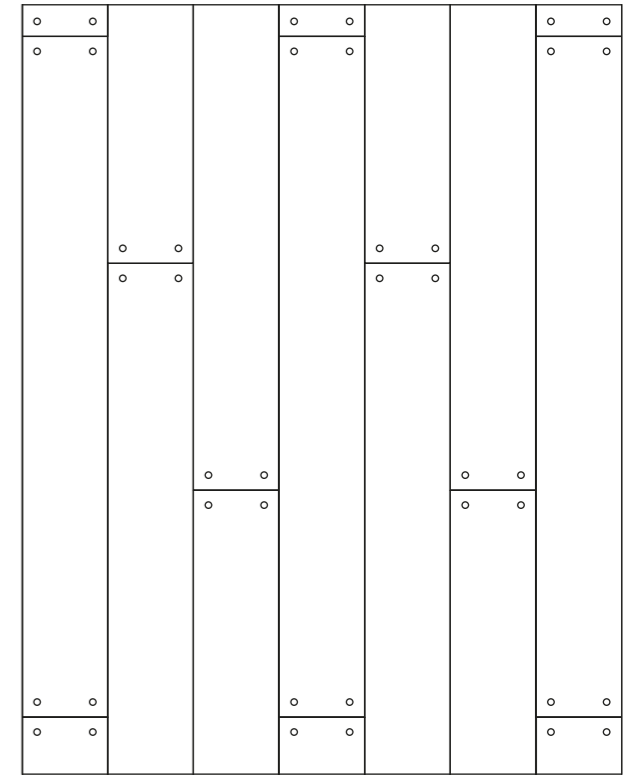

Ship Papillon

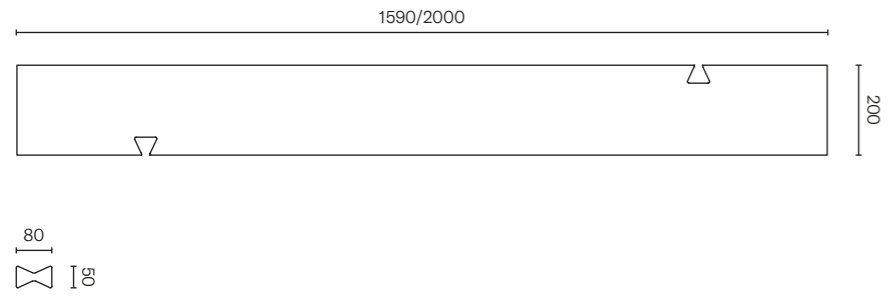

Size: 200 x 1590/2000 mm (approximately)
 Thickness: 15/4 mm
 Wood type: American walnut | Maple
 Inserts: Stone | Marble | Metal | Wood
 PKPAPILLONNCAR
 Processing: Hand sanded
 Colour: Natural
 Finish: Oil and wax

Butterflies supplied separately. - PKFARCAR
 Wood types, finishes and colours can be customised on request.

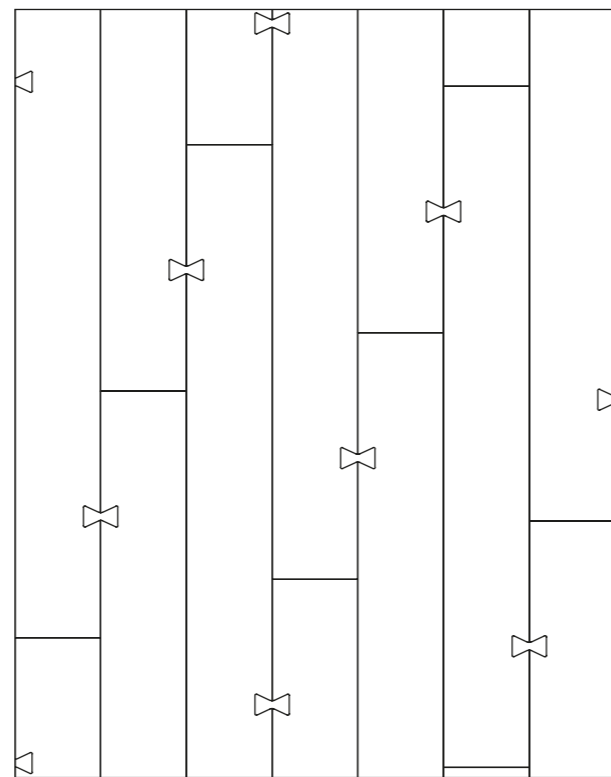

Ship Stick & Dots

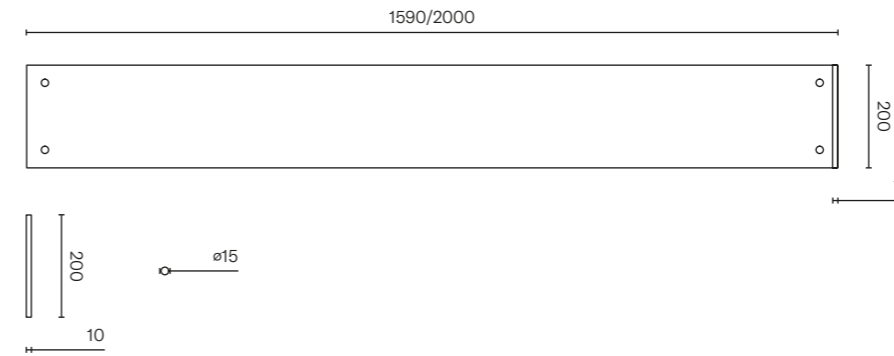

Size: 200 x 1590/2000 mm (approximately)
 Thickness: 15/4 mm
 Wood type: American walnut | Maple
 Inserts: Stone | Marble | Metal | Wood
 PKSTICKDOTSAMAR
 Processing: Hand sanded
 Colour: Natural
 Finish: Oil and wax

Wood types, finishes and colours can be customised on request.

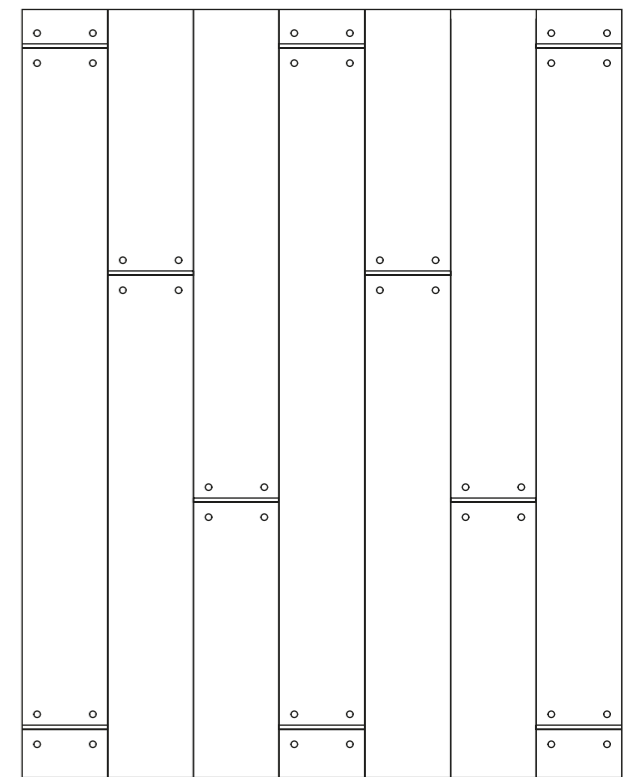

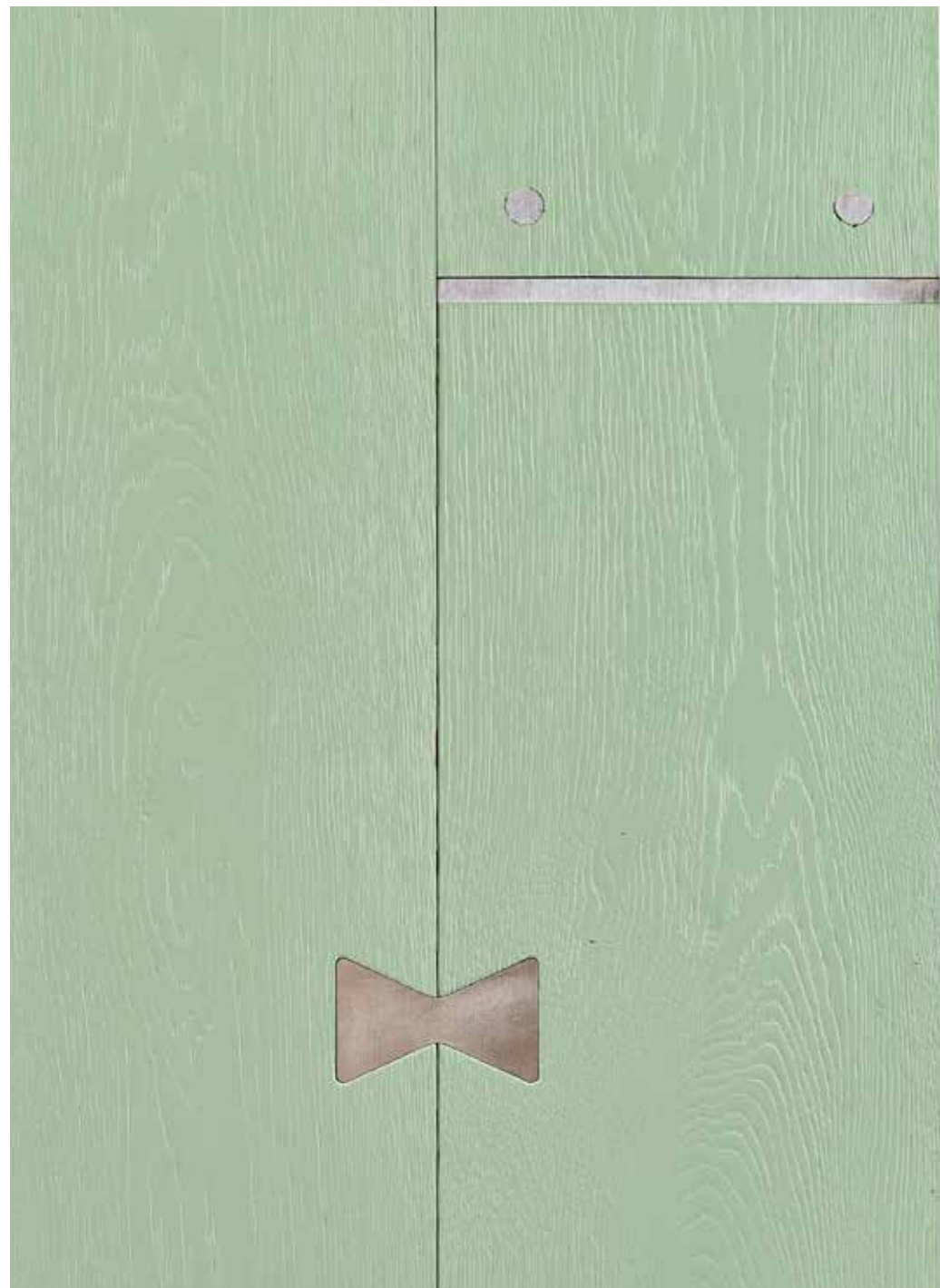

Phoenix

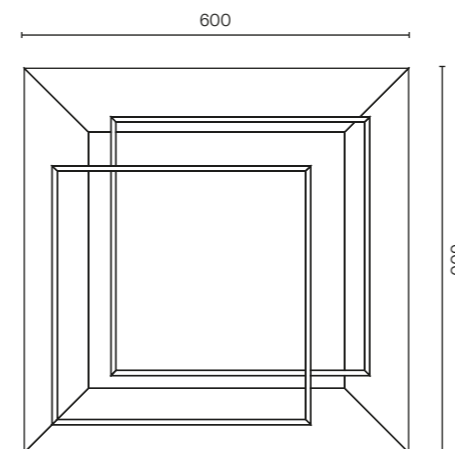

Size:	600x600 mm
Thickness:	15/4 mm
Wood type:	Heat-treated rustic oak
Inserts:	Brushed Aluminium PKPHOENIXRALS
Processing:	Hand sanded Brushed
Colour:	Natural
Finish:	Oil

Wood types, finishes and colours can be customised on request.

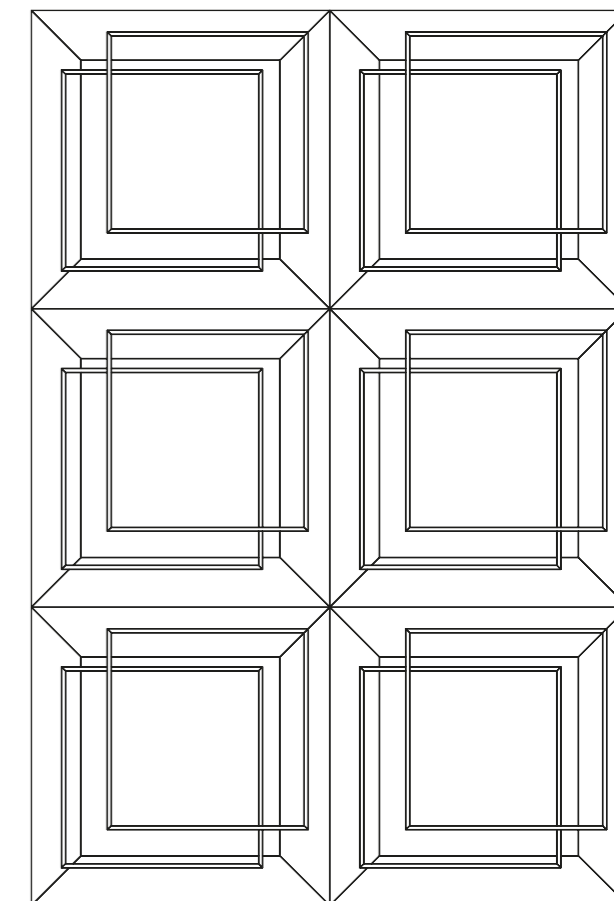

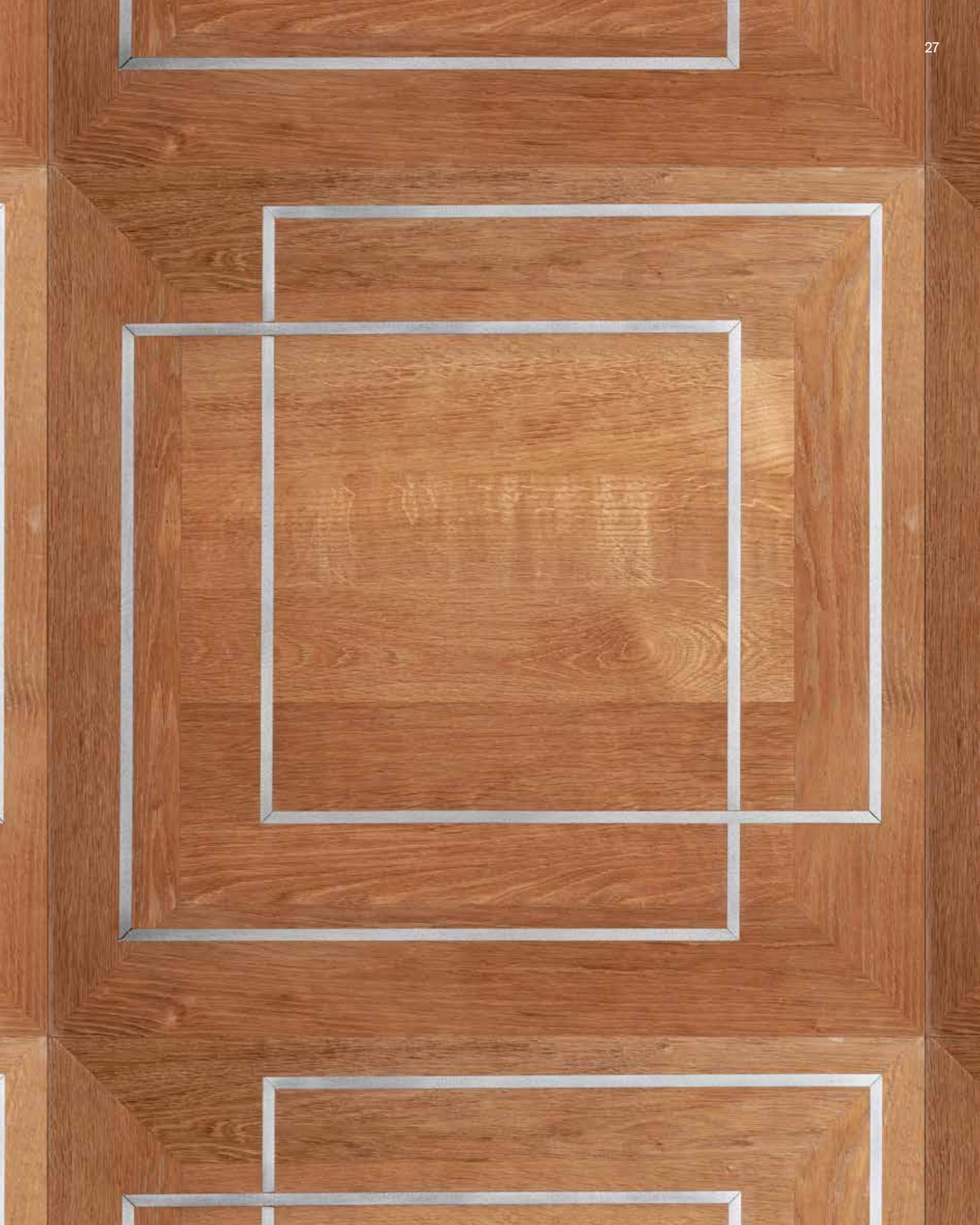

Thread

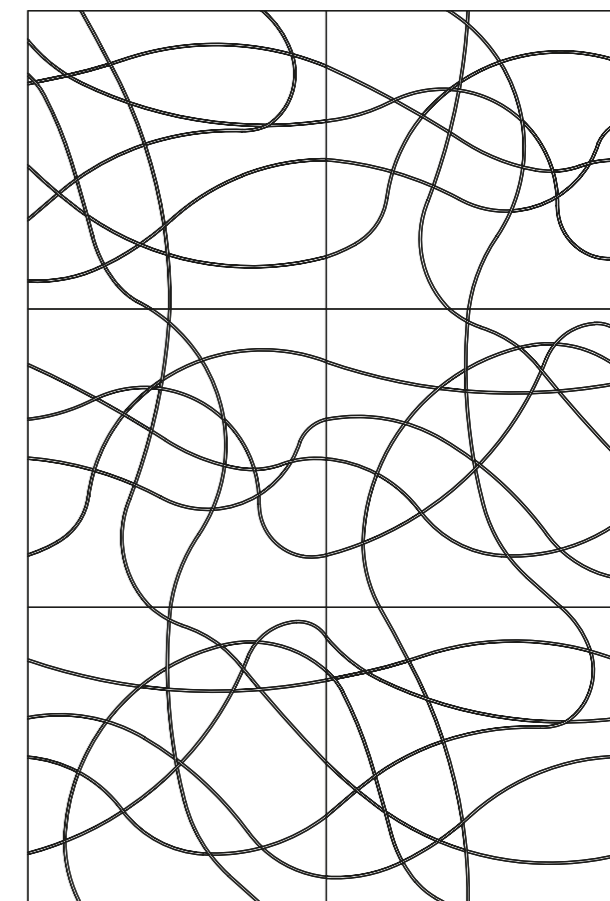
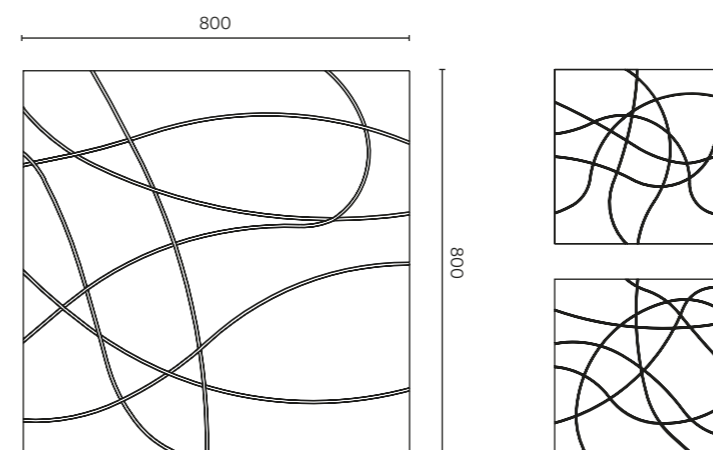

Size:	800x800 mm
Thickness:	15/4 mm
Wood type:	Rustic oak / Brushed Aluminium PKTHREADRALS
Processing:	Hand sanded Brushed
Colour:	Dark patina walnut
Finish:	Oil and wax

Wood types, finishes and colours can be customised on request.



Hydra

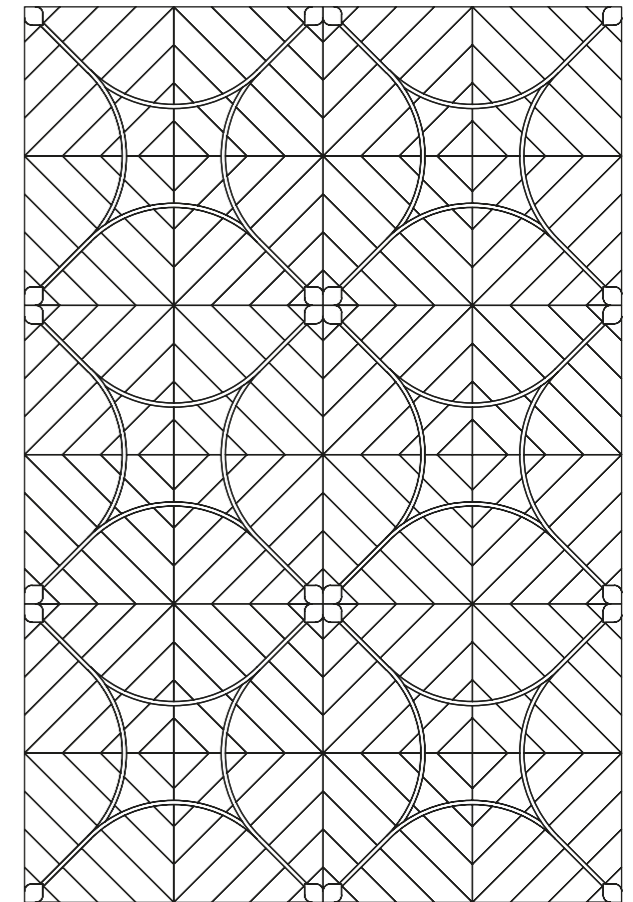
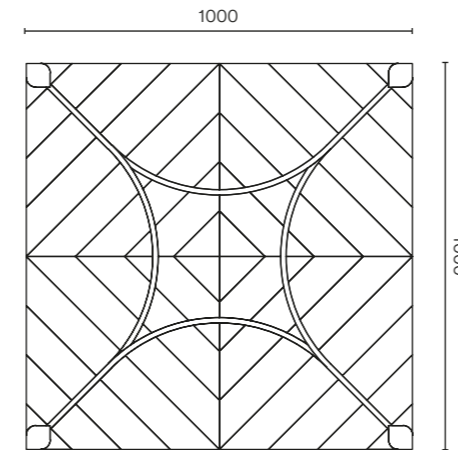

Size:	1000x1000 mm
Thickness:	15/4 mm
Wood type:	Rustic oak High-gloss steel PKHYDRARNAL
Processing:	Hand sanded Brushed
Colour:	Black
Finish:	Varnish

Wood types, finishes and colours can be customised on request.

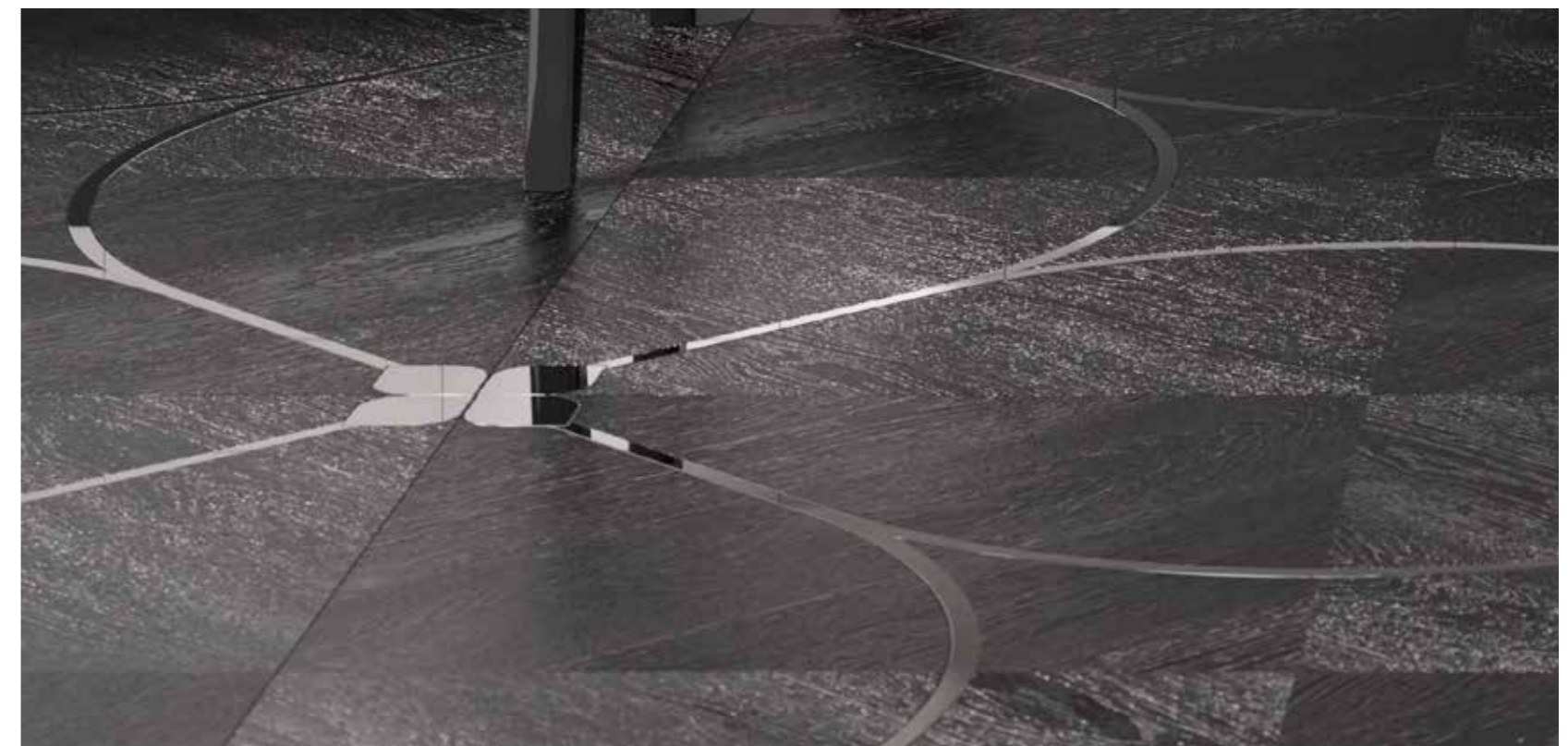







Tie

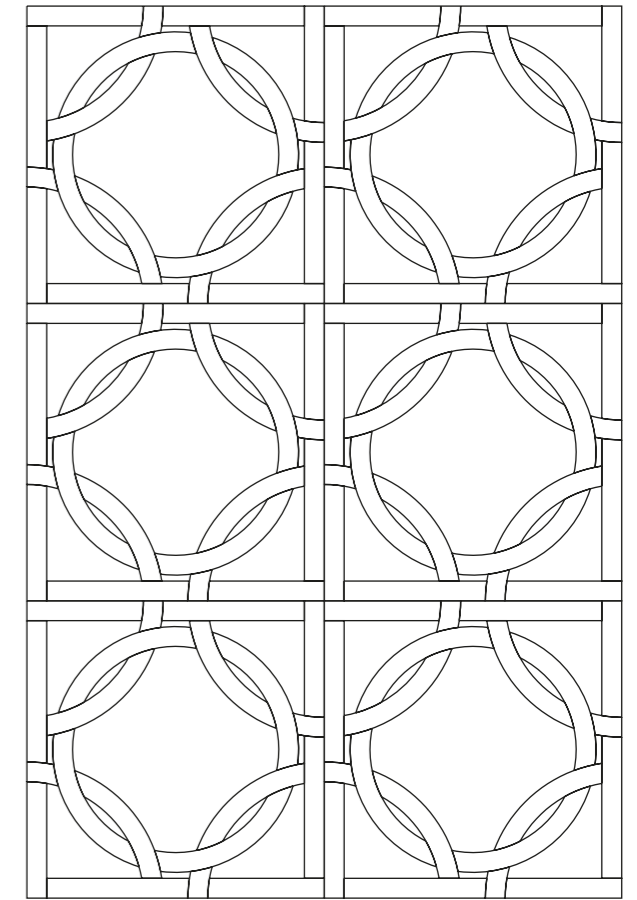
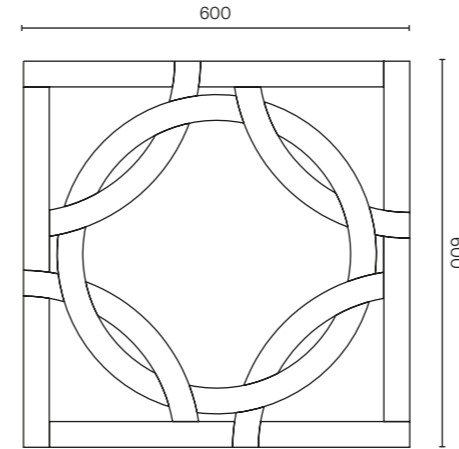

- Size: 600x600 mm
- Thickness: 15/4 mm
- Wood type: Rustic oak
PKTIE
- Processing: Hand sanded
- Colour: Light glossy walnut
- Finish: Oil and wax

Wood types, finishes and colours can be customised on request.







Mansion

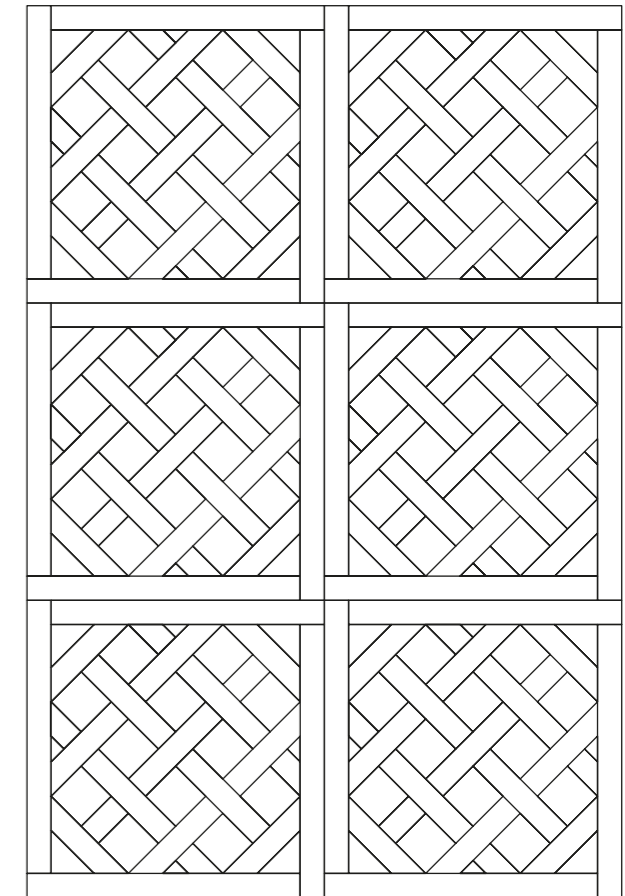
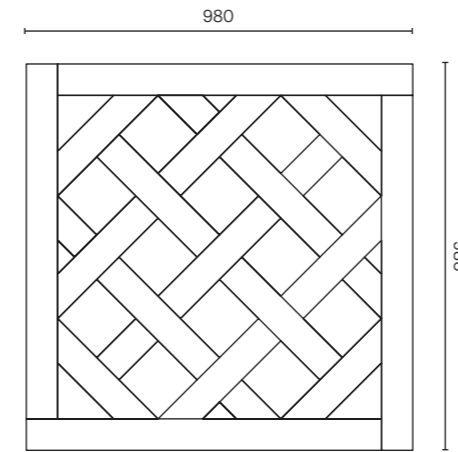

- Size: 980x980 mm
- Thickness: 15/4 mm
- Wood type: Rustic oak
PKMANSION
- Processing: Hand sanded
- Colour: Light glossy walnut
- Finish: Oil and wax

Wood types, finishes and colours can be customised on request.





Spectrum

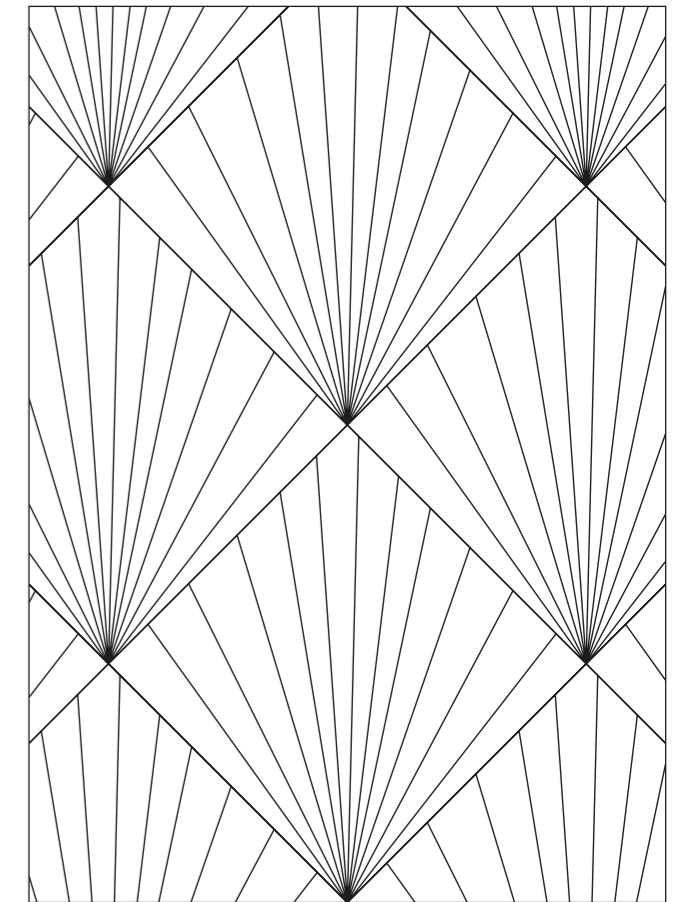
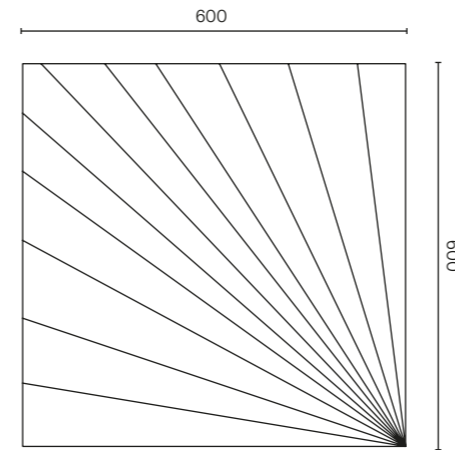

- Size: 600x600 mm
- Thickness: 15/4 mm
- Wood type: American Walnut
PKSPECTRUMN
- Processing: Hand sanded
- Colour: Natural
- Finish: Oil and wax

Wood types, finishes and colours can be customised on request.





Hive

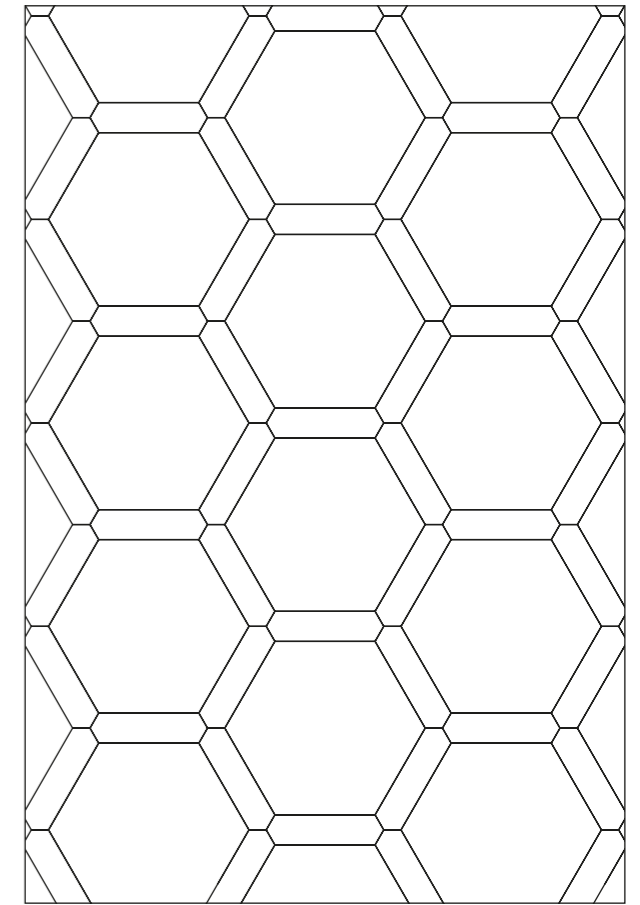
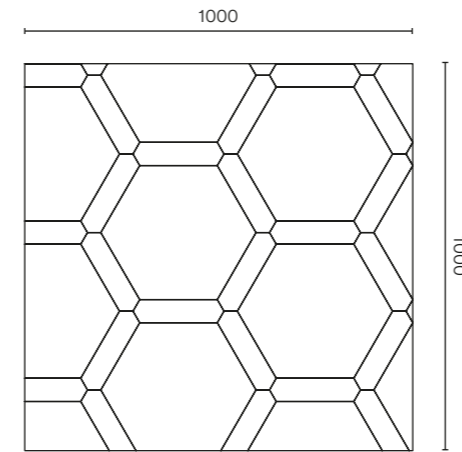

Size:	Hexagon 346x400 mm Lozenge 60x200/235 mm
Thickness:	15/4 mm
Wood type:	Maple/Wengé American Walnut/Wengé PKHIVEWA PKHIVEWN
Processing:	Hand sanded
Colour:	Natural
Finish:	Varnish

Wood types, finishes and colours can be customised on request.
The flooring is provided in separate elements.







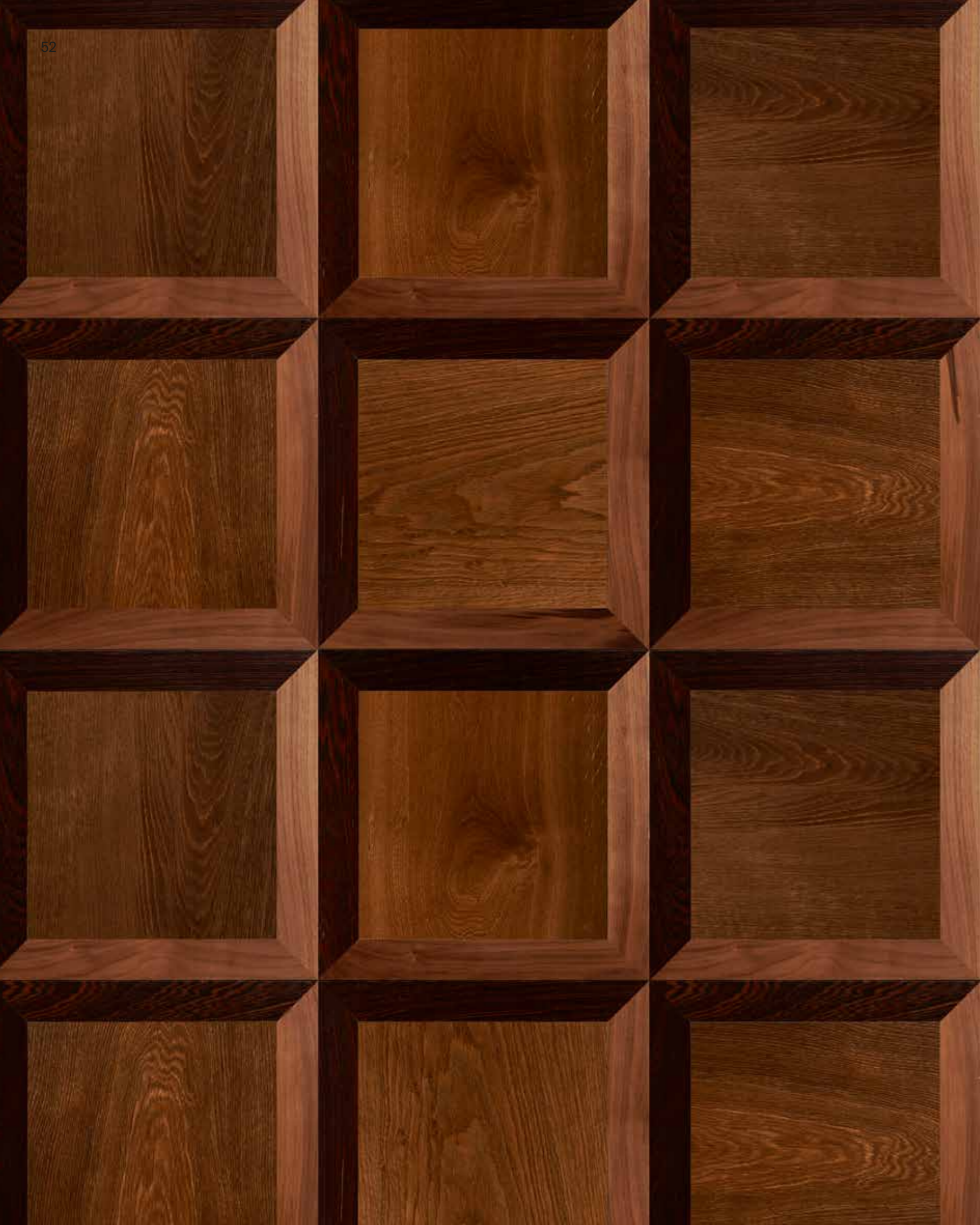

Lacunari

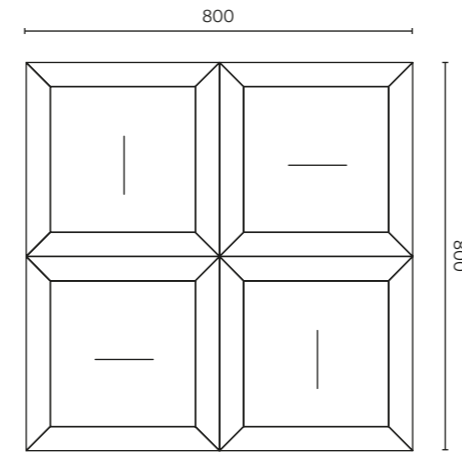

Size:	800x800 mm
Thickness:	15/4 mm
Wood type:	Wengé/American walnut/Heat-treated oak PKLACUNARIRNW
Processing:	Hand sanded
Colour:	Natural
Finish:	Varnish

Wood types, finishes and colours can be customised on request.

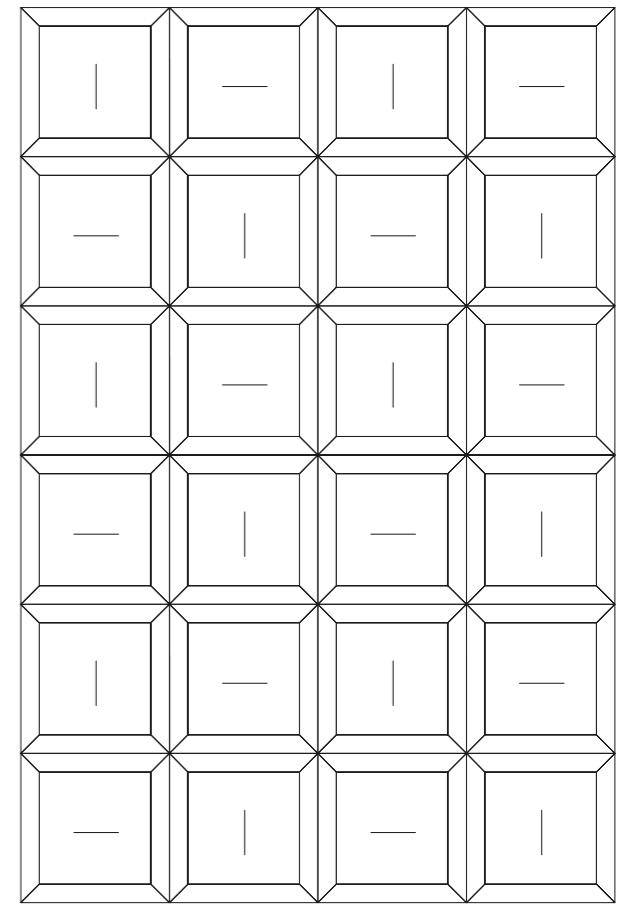

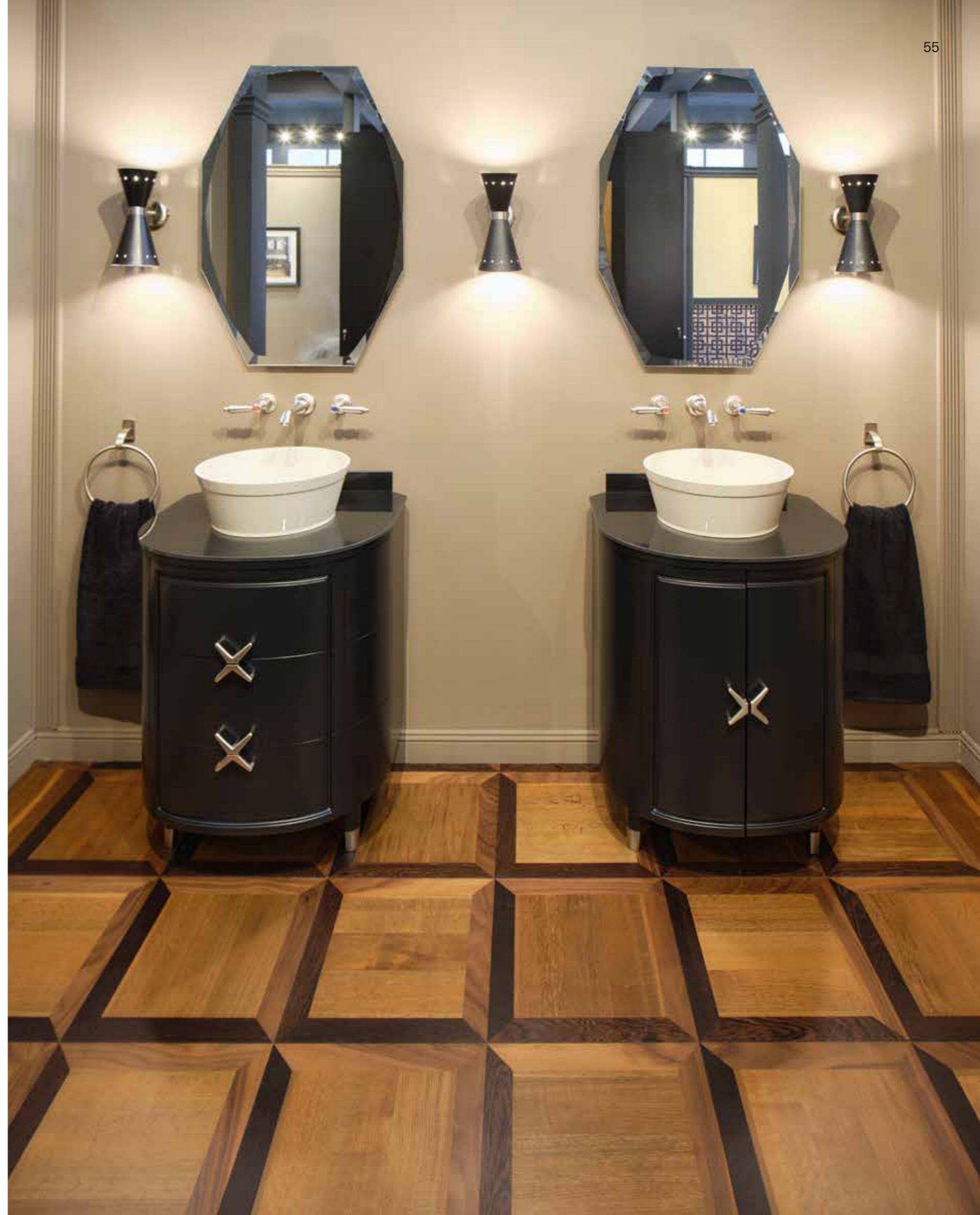



Hexagonal

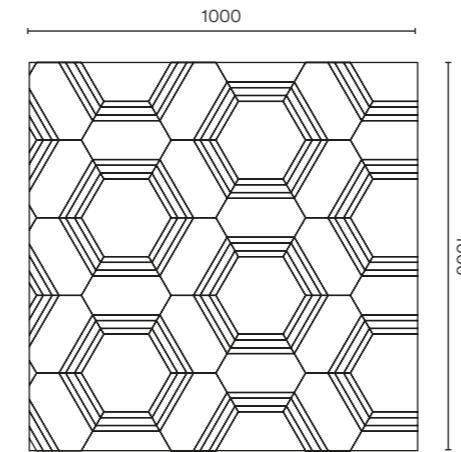

Size:	Hexagon 200x231 mm Slats Wengé 15 mm Slats Maple 20 mm
Thickness:	15/4 mm
Wood type:	Maple/Wengé PKHEXAGONALAW
Processing:	Hand Sanded
Colour:	Natural
Finish:	Varnish

Wood types, finishes and colours can be customised on request.
The flooring is provided in separate elements.

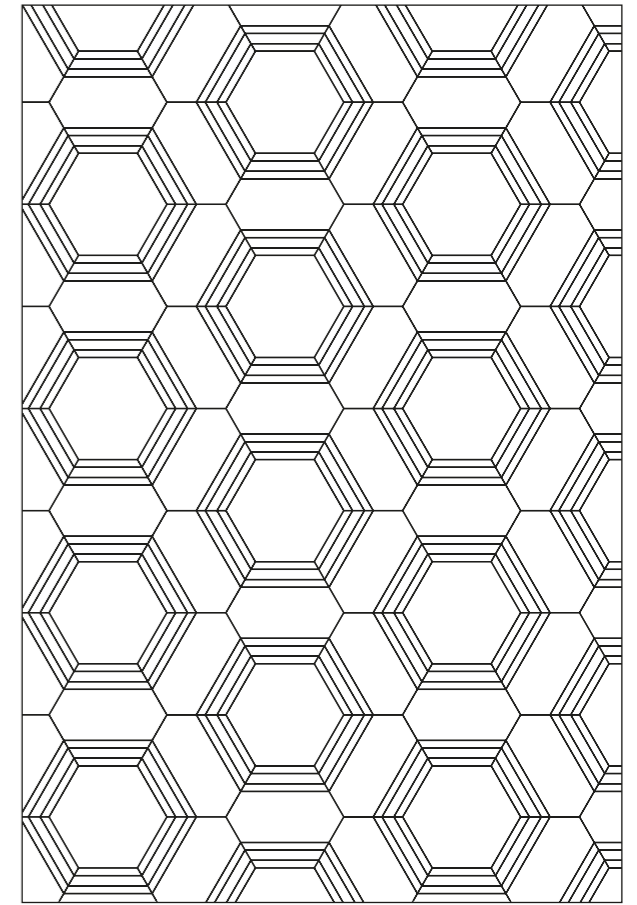





Weaving

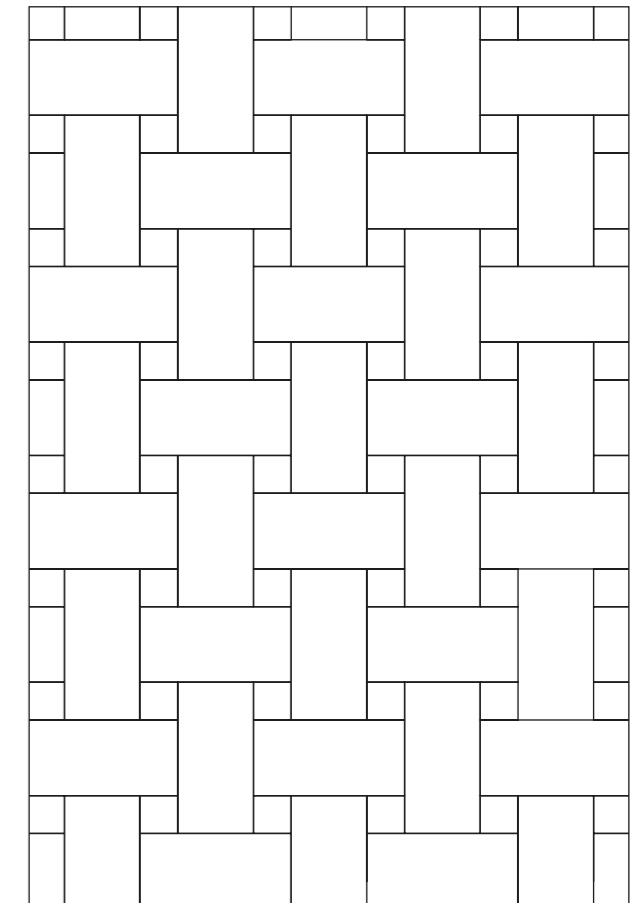
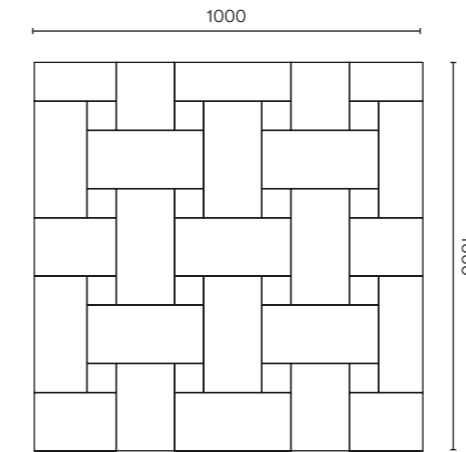

- Size:** Square Module 75x75 mm
Rectangular Module 300x150 mm
- Thickness:** 15/4 mm
- Wood type:** American walnut/Wengé
PKWEAVINGNW
- Processing:** Hand sanded
- Colour:** Natural
- Finish:** Varnish

Wood types, finishes and colours can be customised on request.
The flooring is provided in separate elements.



Bee

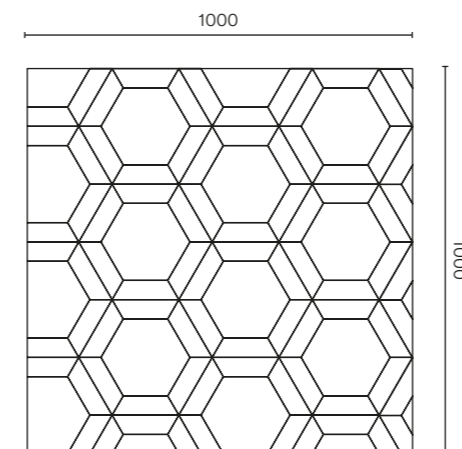

Size:	300x346 mm
Thickness:	15/4 mm
Wood type:	Maple/Wengé American Walnut/Wengé PKBEEWA PKBEEWN
Processing:	Hand sanded
Colour:	Natural
Finish:	Varnish

Wood types, finishes and colours can be customised on request.
Module composed of internal hexagon and external slats.

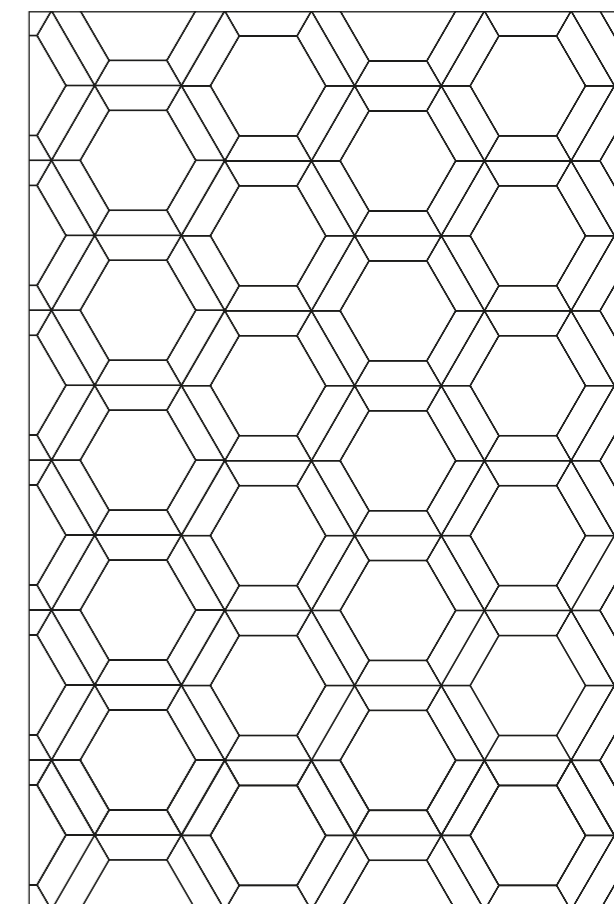

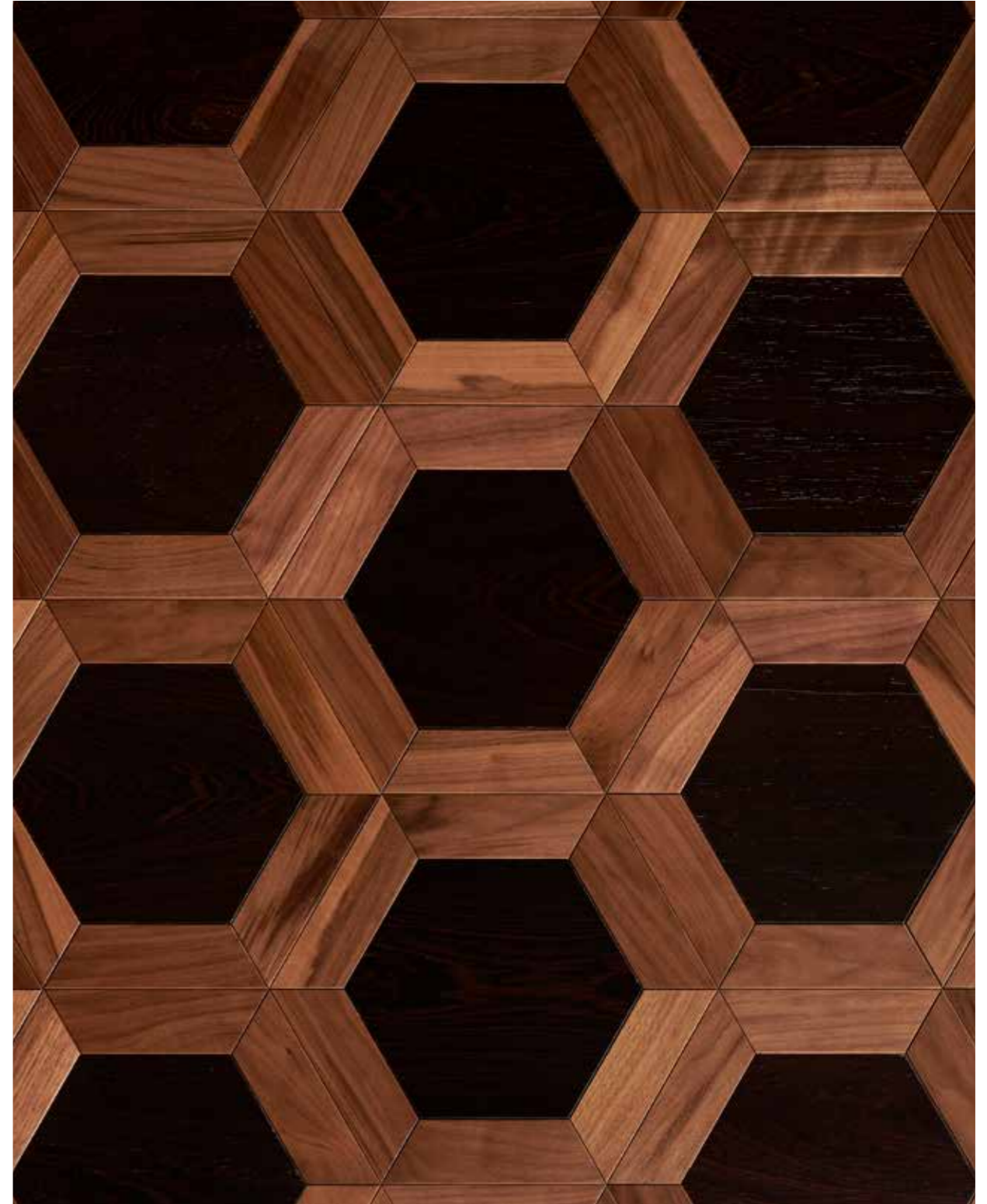
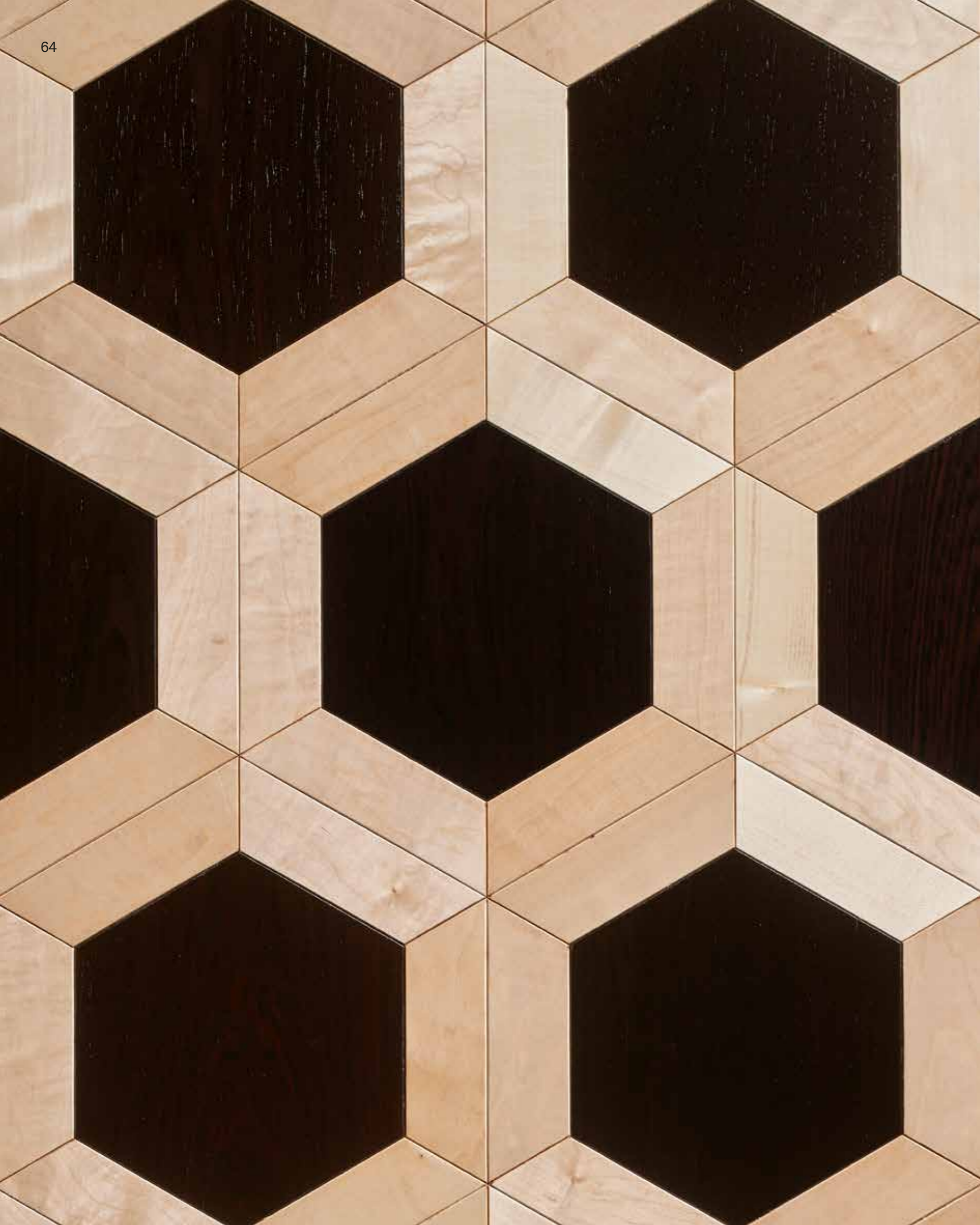



Labirinth

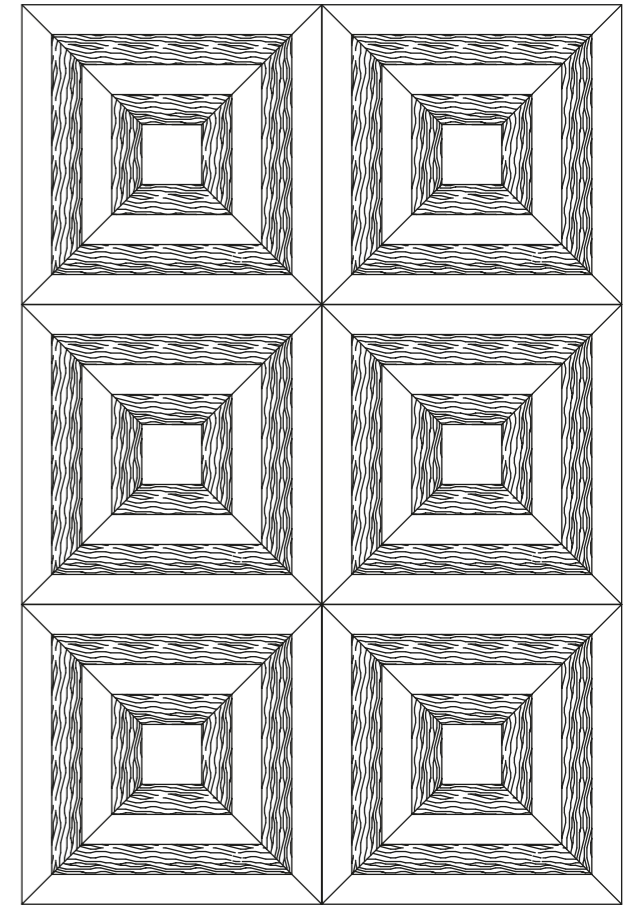
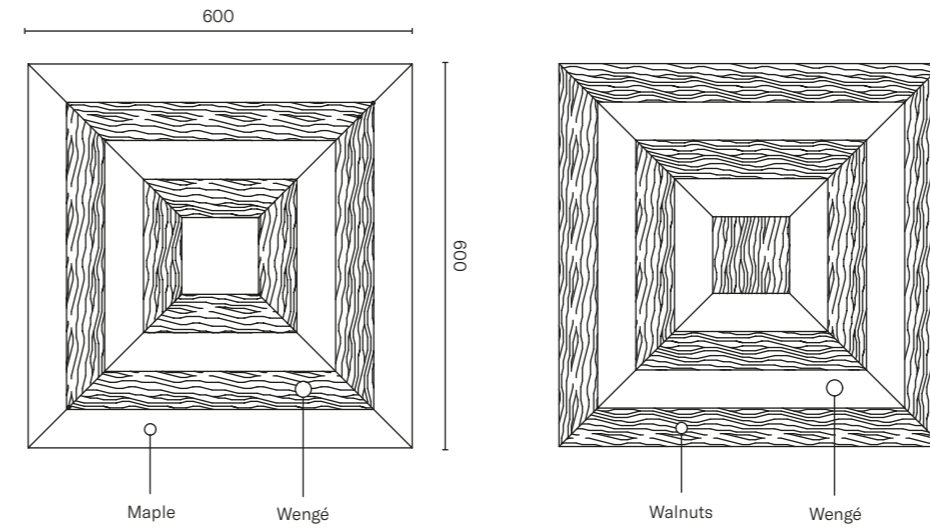

Size:	600x600 mm
Thickness:	15/4 mm
Wood type:	Maple Wengé PKLABIRINTHAW PKLABIRINTHNW
Processing:	Hand sanded
Colour:	Natural
Finish:	Varnish

Wood types, finishes and colours can be customised on request.







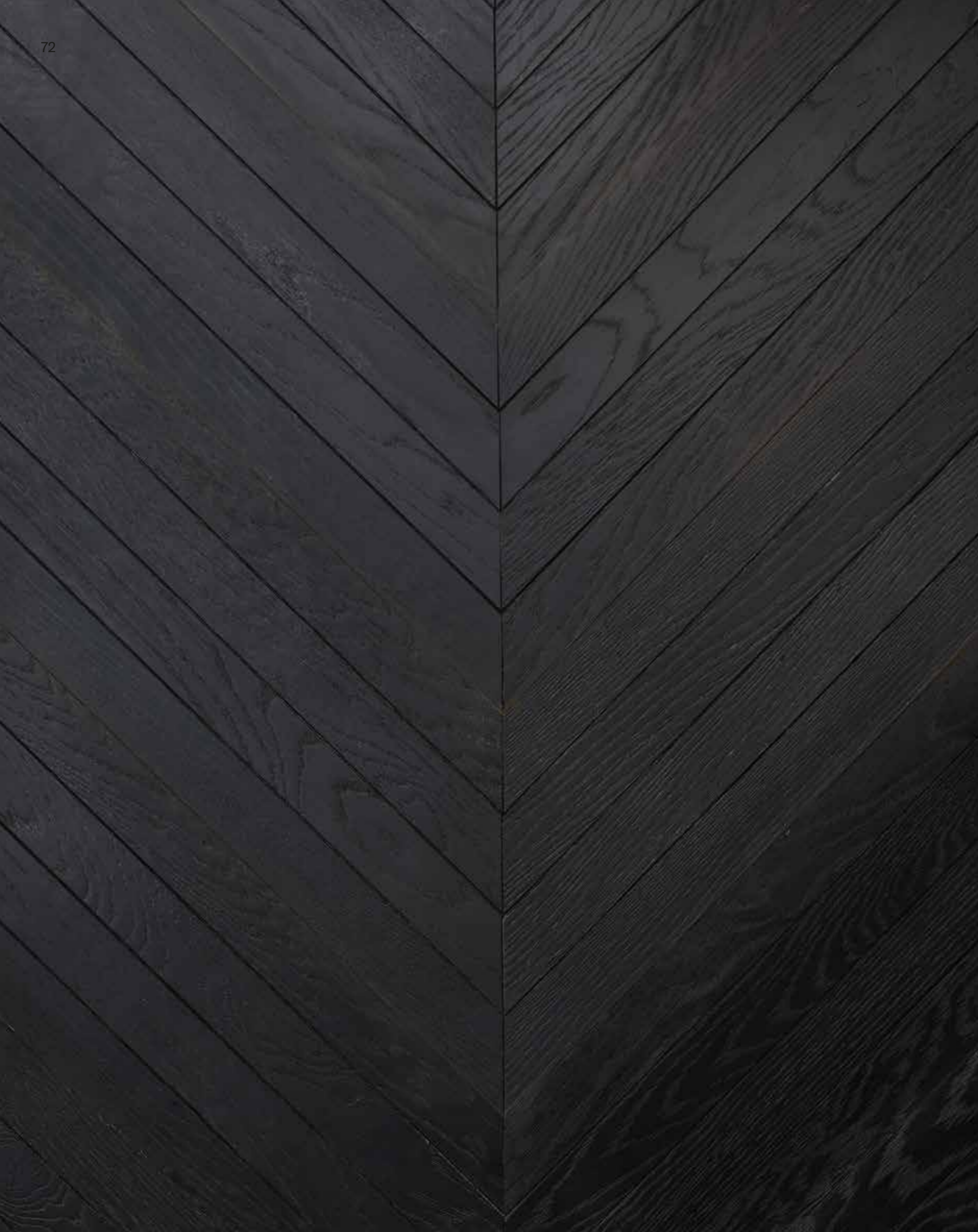

Herringbone

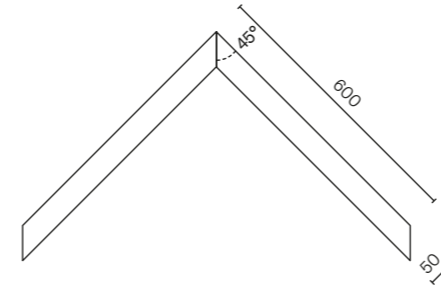

Size:	50 x 600 mm
Thickness:	15/4 mm
Wood type:	Rustic oak PKHERRINGBONE
Processing:	Hand sanded
Colour:	Black
Finish:	Varnish

Wood types, finishes and colours can be customised on request.

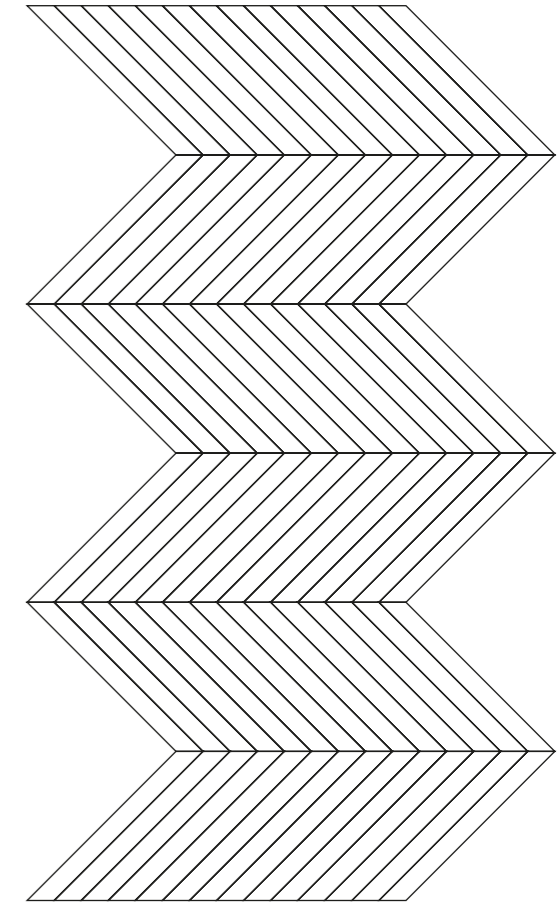



Herringbone & Metal

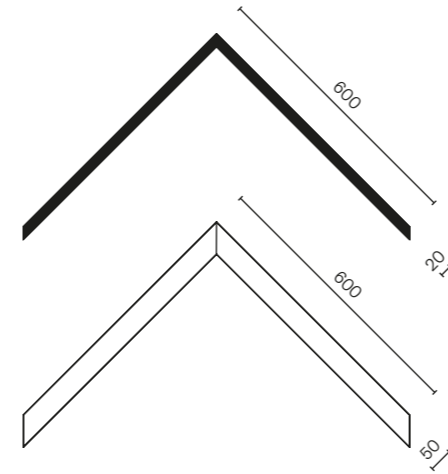

Size:	50 x 600 mm oak 20 x 600 mm metal
Thickness:	15/4 mm
Wood type:	Rustic oak
Insert:	Polished Steel Polished brass PKHERRING&ACL PKHERRING&OTL
Processing:	Hand sanded
Colour:	Black
Finish:	Varnish

One metal slat every four herringbones.
Wood types, finishes and colours can be customised on request.

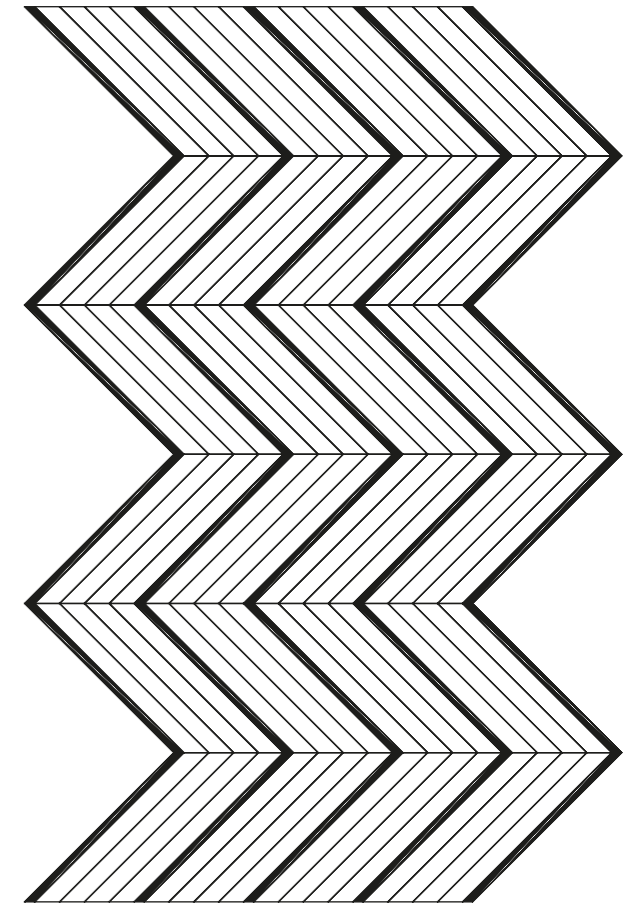

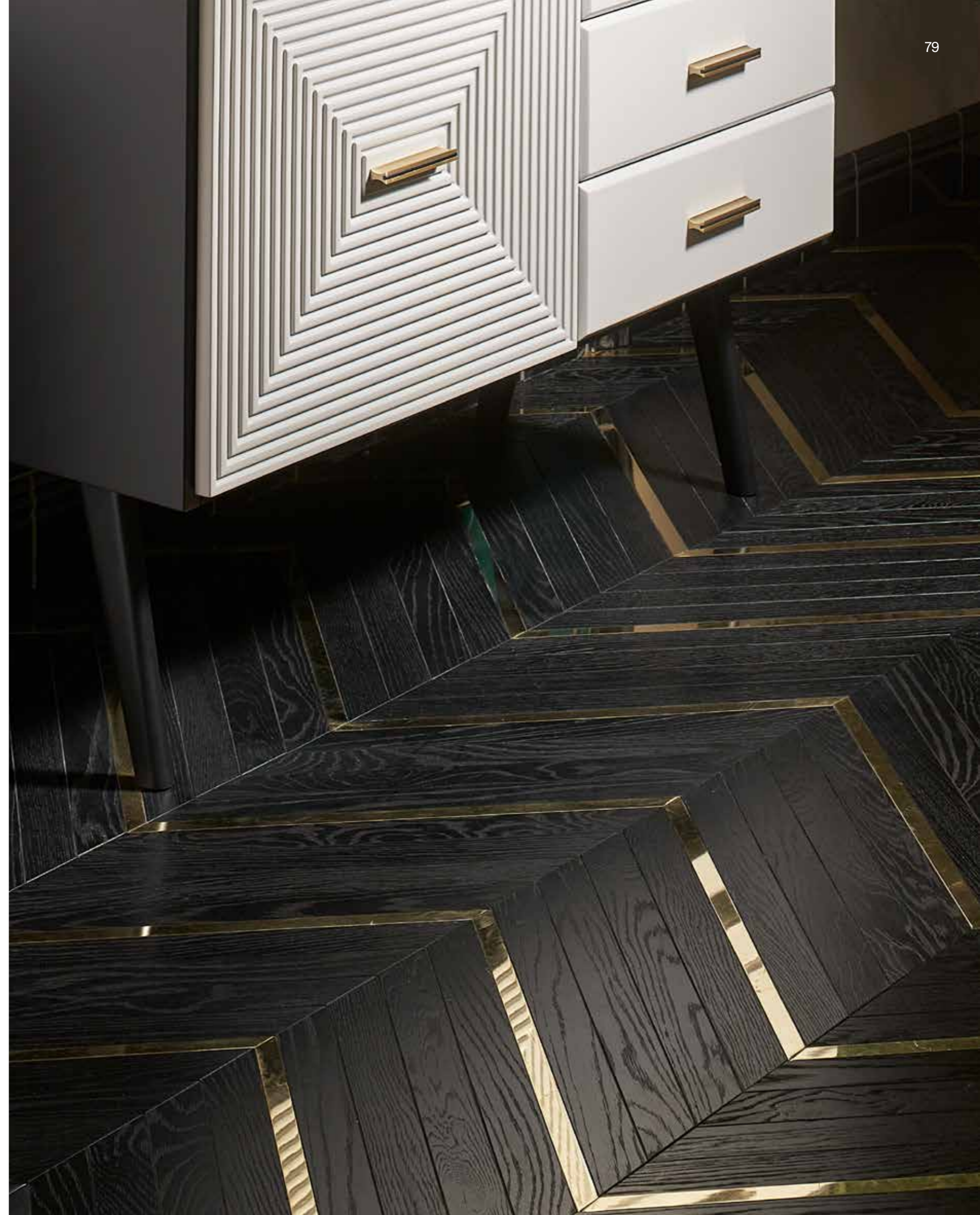

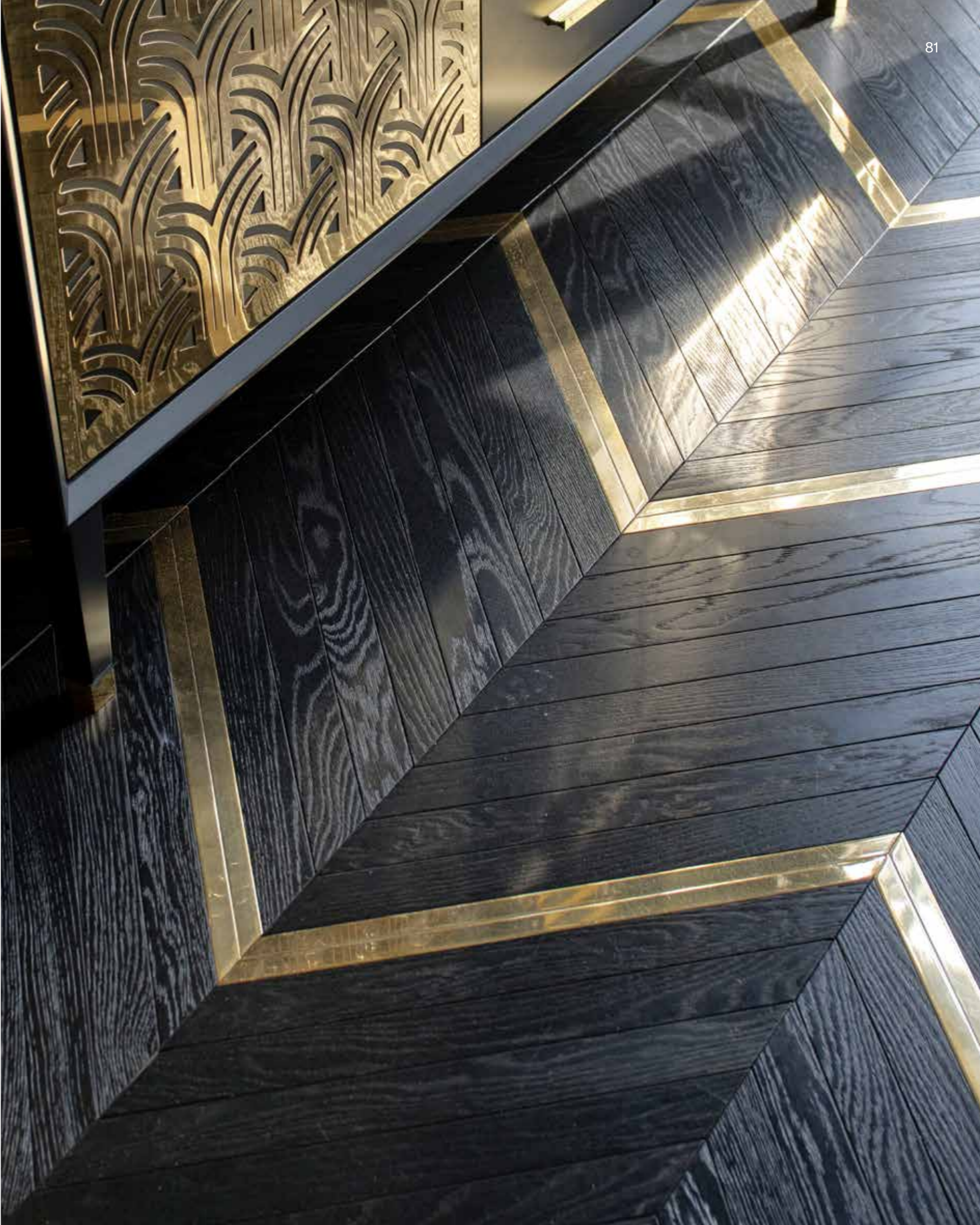



Planks Balloon

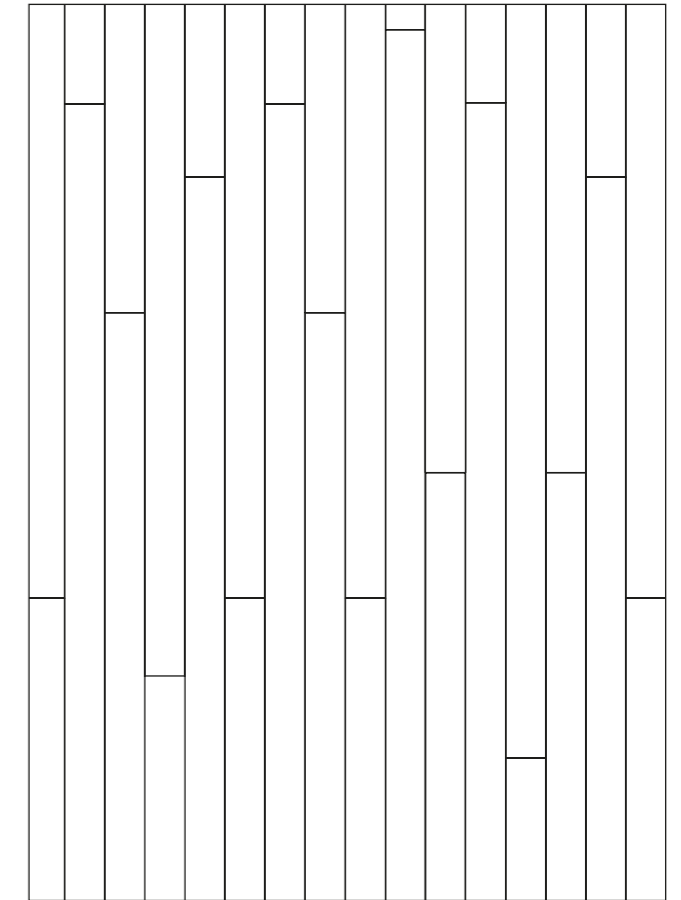
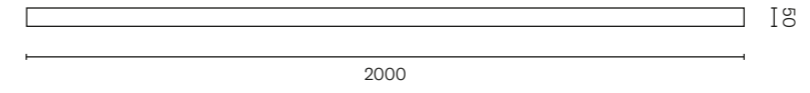

- Size: 50 x 2000 mm (approximately)
- Thickness: 15/4 mm
- Wood type: Rustic oak
PKPLANKSBAL
- Processing: Hand sanded
- Colour: Patinated Light Walnut
- Finish: Oil and wax

Wood types, finishes and colours can be customised on request.



MATERIAL LIBRARY

Wood Floor

WOOD

Oak
Walnut
Maple
Wengé
Teak

Inserts

METALS

Steel
Brass
Aluminium
Copper
Bronze

MARBLE

Carrara
Marquina
Emperador Dark
Bardiglio
Rosso Verona

WOOD

Oak
Walnut
Maple
Wengé
Teak



PARK  AVENUE

Via Spartaco Marmugi, 1
50059 Sovigliana/Vinci – Firenze (Italy)

Tel. + 39 0571 531 282

info@parkavenue.it
www.parkavenue.it

