



KITCHEN
COLLECTION 2023

KITCHEN
COLLECTION 2023

Il gruppo Cubo Design ama le sfide e propone una nuova collezione densa di novità e dettagli di rilevata importanza. Il leitmotiv è il concetto di apertura, inteso come invasione spaziale in ambiti differenti dalla cucina, che genera spazi infiniti e la priva dei suoi confini reali. Una ricca piattaforma con oltre 350 finiture per i frontali, 120 per i piani di lavoro, garantisce un'offerta in grado di soddisfare le differenti richieste estetiche e funzionali che il mercato avanza. Un'eccellenza italiana che si tramanda da generazioni guardando al futuro. Nei primi anni '60 Giuseppe Arangiaro comincia l'avventura. Presto si accorge che il Made in Italy è garanzia di successo, e comincia l'esportazione delle sue creazioni; in pochi anni diventa uno dei maggiori esportatori di cucine componibili, tanto da indurre una multinazionale americana a credere in lui. Certo i tempi cambiano, cambiano i materiali, la richiesta, il design e il gusto. Non cambia, invece, il bisogno di qualità, interesse primario allora come oggi. E oggi c'è Antonio, figlio di Giuseppe, che con la stessa lungimiranza gestisce l'azienda, consapevole che la qualità, l'estro e l'affidabilità dei prodotti italiani offrono ancora garanzie in tutto il mondo. E l'avventura continua, con l'apertura di un nuovo polo produttivo, che integra perfettamente i processi di Industria 4.0, Smart Factory, efficienza energetica e approccio green. Il risultato di questa vision è un polo produttivo avveniristico, in cui i flussi di lavoro sono stati ridisegnati attraverso l'automazione digitale, nell'ottica della massima efficienza. L'energia che muove le imprese e le persone viene prodotta autonomamente e re-impiegata in un circolo virtuoso. Ogni cosa è pensata nel rispetto del pianeta. Ogni sforzo viene fatto per dare un presente migliore alle generazioni future.

The Cubo Design group loves challenges and proposes a new collection full of news and important details. The leitmotiv is the concept of opening, like a spatial invasion in different areas of the kitchen, which generates infinite spaces and deprives its real confines. A rich platform with over 350 finishes for the fronts, 120 for the worktops, guarantees an offer able to meet the different aesthetic and functional requirements that the market is advancing. An Italian excellence passed down through generations with an eye to the future. In the early 1960s, Giuseppe Arangiaro embarked on his endeavor. He soon realized that made in Italy items guaranteed success, so he began exporting his creations; in the space of a few years, he became one of the biggest exporters of modular kitchens, such that his exploits attracted the attention of an American multinational company. Times change, however, alongside materials, demand, design and taste. What doesn't change, though, is the need for quality, an essential requirement then and now. The company is now managed by Antonio, Giuseppe's son, with the same foresightedness and awareness that Italian products - with their creativity and reliability - are still held in high regard throughout the world. Thus the adventure continues with the opening of a new production center, which perfectly integrates the processes of Industry 4.0, Smart Factory, energy efficiency and green approach. The result of this vision is a futuristic production pole, in which the workflows have been redesigned through digital automation, with a view to maximum efficiency. The energy that drives businesses and people is produced autonomously and re-employed in a virtuous circle. Everything is designed with respect for the planet. Every effort is made to give a better present to future generations.





COLLEZIONE

COLLECTION

MÉNTA	9
ANUBA	91
MEDEA	103
TES	117
TALÌA	143

MÉNTA

BILAMINATO OPACO GRIGIO EMME



BILAMINATO LEGNO EUCALIPTO FUMO







*Uno spazio da vivere che
unisce estetica e funzionalità.*

A LIVING SPACE THAT BRINGS AESTHETICS AND FUNCTIONALITY TOGETHER





Le madie sono in Bilaminato Legno Eucalipto Fumo.
Le colonne ripercorrono gli stessi materiali anche nel sistema Waind, in abbinamento al Bilaminato opaco Grigio Emme dei moduli accanto.

Sideboards are in Eucalipto Fumo wood bilaminated. The Waind columns system use the same materials while the next part is made in Grigio Emme Matt Bilaminated.





L'isola è in Bilaminato opaco Grigio Emme con apertura tramite gola raggio \emptyset nero traffico, il piano di lavoro è in Gres Pietra Piasentina Grigio Fiammato. La libreria ed il piano Sandwich sono in Bilaminato Legno Eucalipto Fumo.

The island is made in Grigio Emme matt bilaminated with opening by black groove raggio \emptyset . The worktop is made in Pietra Piasentina Grigio Fiammato gres finish. The library and the Sandwich snack worktop are in Eucalipto Fumo wood bilaminated.



MÉNTA

BILAMINATO OPACO **BETON GIOVE**



LAMINATO PET OPACO **NERO ONICE**



BILAMINATO LEGNO **ROVERE SCANDY**







L'isola è in Bilaminato Cemento Beton Giove con al centro le basi con cassetti in luce con frontali in Bilaminato Legno Rovere Scandy come il piano snack, sorretto da una gamba Industrial in metallo nero opaco. Il top è in Gres Fokos Sale opaco.

The island is in Bilaminato Cemento Beton Giove with base units with drawers in the centre with fronts in wood Bilaminato Rovere Scandy like the snack panel, supported by an Industrial leg in matt black metal. The worktop is in matt gres Fokos Sale.

Un ambiente dall'estetica moderna e raffinata.

MODERN AND RIFINED AMBIENCE



A destra, le colonne sono Ménta in Laminato PET Nero Onice ed il vano a giorno è in Bilaminato Legno Rovere Scandy.

To the right, Ménta Columns are in Matt Nero Onice PET Laminate and open spaces unit is in Rovere Scandy Wood Bilaminate.







Dettaglio maniglia IRON in alluminio nero traffico. A destra l'isola in Bilaminato Cemento Beton Giove con maniglia Jay nero opaco.

Detail of IRON handle in aluminium black. To the right is the Beton Giove concrete bilaminated island with matt black Jay handle.



Credenza con modulo vetrina Petra con struttura e ripiani in Bilaminato Legno Rovere Scandy e vetro fumè. Ante superiori e inferiori in Laminato PET Nero Onice opaco.

Cupboard with smoked glass door Petra structured with Scandy Wood Bilaminate shelves. Higher and lower doors are matt Nero Onice PET Laminate.





MÉNTA

LAMINATO PET OPACO BIANCO NORDICO



BILAMINATO LEGNO ROVERE CHIARO

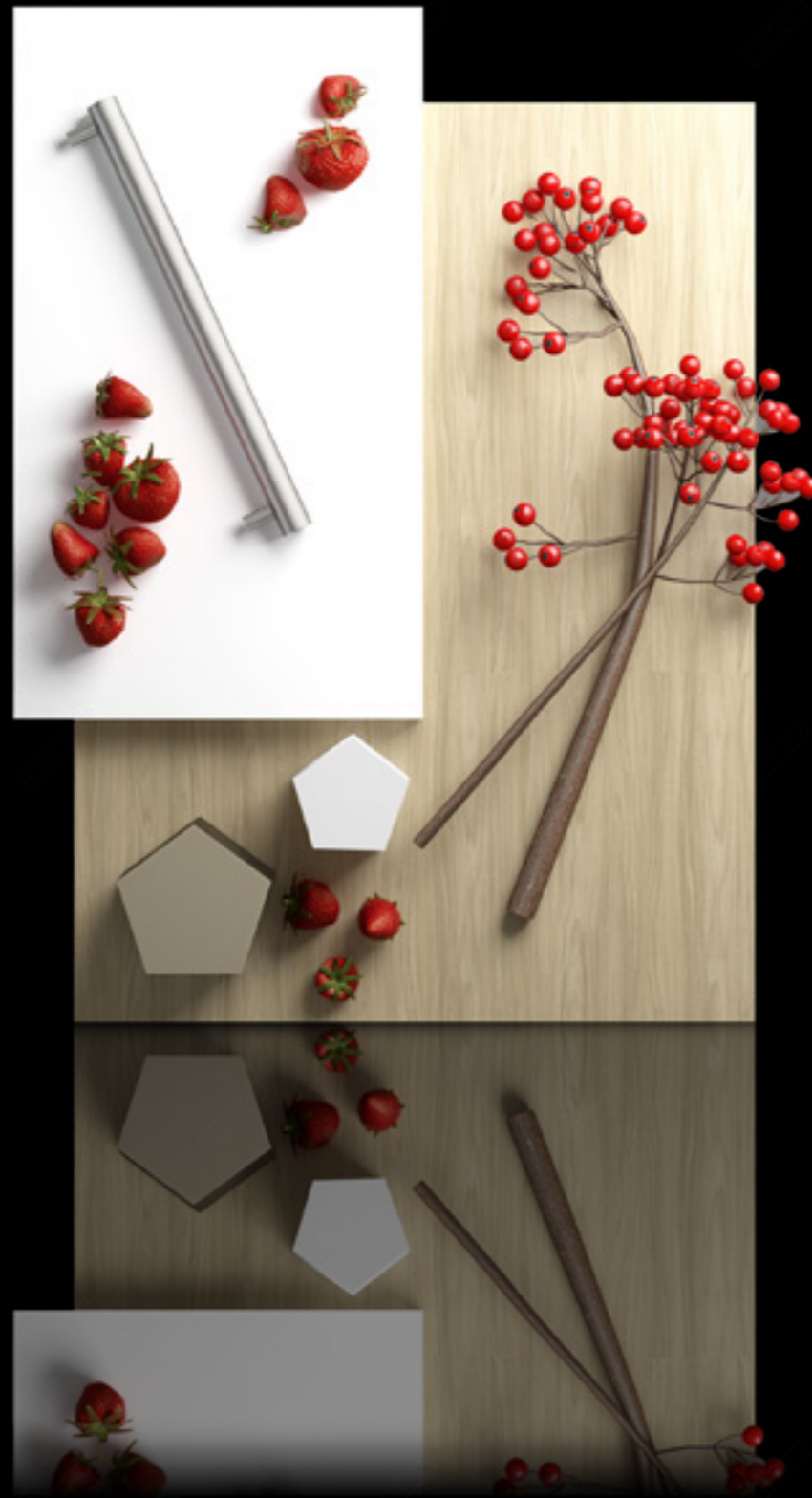





Le colonne sono in Laminato PET Bianco Nordico opaco, le mensole e gli schienali sono in Bilaminato Legno Rovere Chiaro.

The columns are in Matt Bianco Nordico PET Laminate, the shelves and the back panels are in Rovere Chiaro wood bilaminate.

Linee essenziali raccontano una perfetta sintonia materica.

ESSENTIAL LINES TELL ABOUT A PERFECT HARMONY OF MATERIALS





L'isola è in Laminato PET Bianco Nordico opaco, con maniglia Jay alluminio champagne nella parte operativa. Il top è in Gres White Mat da sp. 1,2 cm.

The island is made in Matt Bianco Nordico PET Laminate, with aluminium champagne Jay handle on the operative part. Top is Mat White Gres finish.





MÉNTA

BILAMINATO LEGNO NOCE ADIGE



LAMINATO PET OPACO CRETA OPACO







*L'isola è il cuore della
convivialità e condivisione.*

THE ISLAND BECOMES THE CENTER OF A CONVIVIAL SPACE





L'isola è in Laminato PET Creta opaco con metodo di apertura con gola raggio \emptyset nero traffico. Le colonne ed i vani a giorno Waind sono in Bilaminato Legno Noce Adige.

The island is made with Creta opaco PET Laminate with black groove raggio \emptyset . Columns and Waind open units are in Noce Adige wood bilaminate.





SPAZI INFINITI

Le madie Miri sono in Bilaminato Legno Noce Adige con maniglia Linear nera opaca. L'angolo living ripercorre gli stessi materiali della cucina e consente l'inserimento di vetrine Bellevue vetro fumè e vani a giorno Waind_K altezza 138 cm.

ENDLESS SPACES

The Miri sideboards are made in Noce Adige wood bilaminated with Linear handle in matt black finish. The living area has the same shown materials and allows Bellevue glass units insertion in smoked glass finish as well as Waind open units 138 cm tall.





MÉNTA

BILAMINATO LEGNO NOCE CORDESCO



LAMINATO PET OPACO VERDE POLVERE

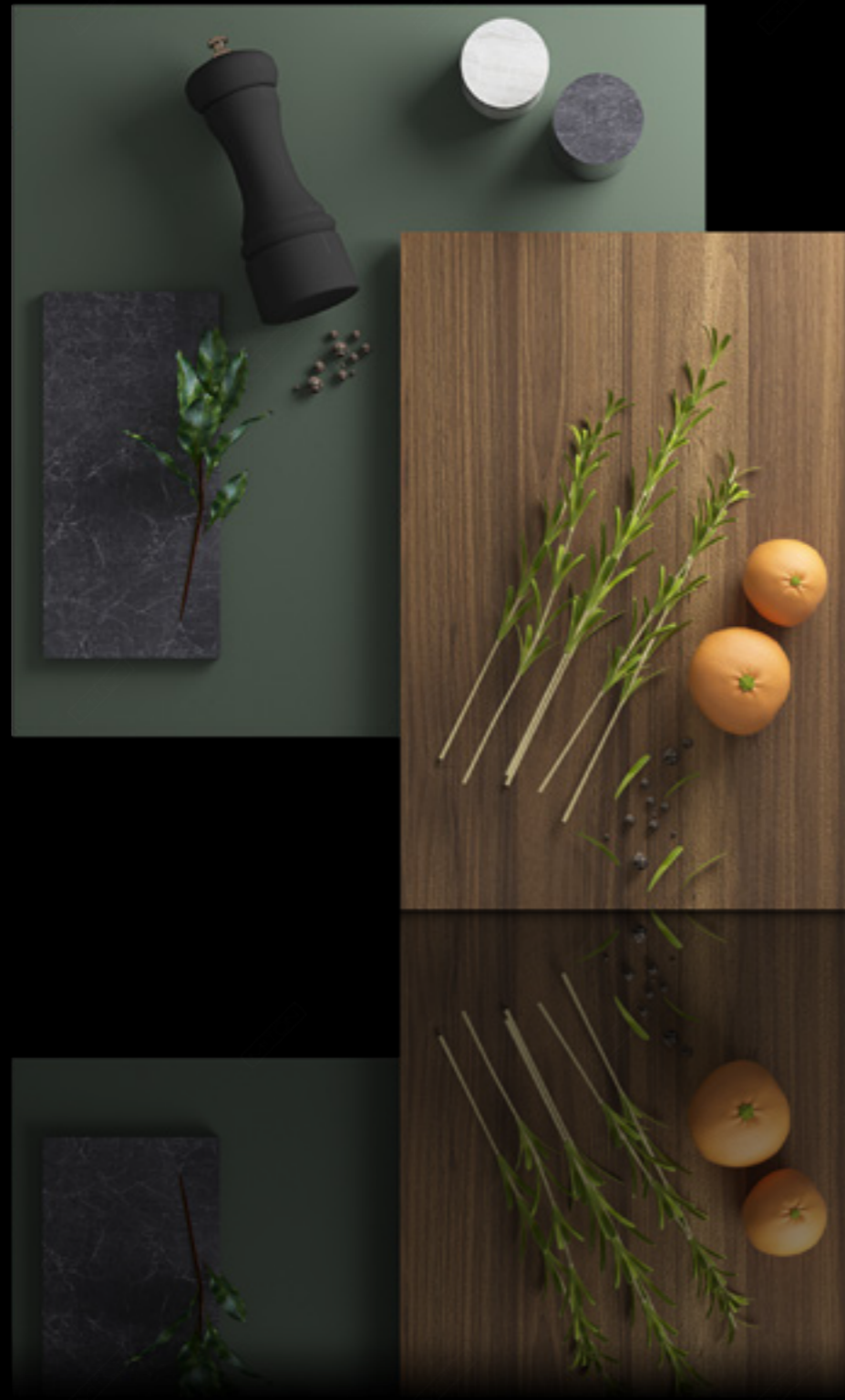





L'isola è in Bilaminato Legno Noce Cordesco, il piano di lavoro è in Gres Nero Greco sp. 1,2 cm.

The island is in Noce Cordesco Wood Bilaminate, the worktop is made in Nero Greco matt gres finish, 1,2 cm thick.

Dualismi cromatici esclusivi protagonisti della cucina.

EXCLUSIVE CHROMATIC DUALISMS GET THE SPOTLIGHT IN THE KITCHEN





LE MOLTEPLICI ESSENZE DI MÉNTA
THE MANY ESSENCES OF MÉNTA

Le colonne sono in Laminato PET Verde Polvere opaco, i vani a giorno Waind sono in Bilaminato Legno Noce Cordesco.
 Columns are in Matt Verde Polvere PET Laminate, the Waind open units made with in Noce Cordesco Wood Bilaminate.





MÉNTA

BILAMINATO OPACO GRIGIO MEDIO



LAMINATO PET OPACO GRIGIO ARDESIA



BILAMINATO LEGNO NOCE NATURALE





*Contaminazioni materiche si
fondono in uno spazio razionale.*

DIFFERENT MATERIALS CREATE A RATIONAL SPACE





La penisola è in Laminato PET Grigio Ardesia opaco ed il piano di lavoro è in Gres sp. 1,2 cm. Le madie sono in Bilaminato Legno Noce Naturale con schienale in finitura.

The peninsula is in matt Grigio Ardesia PET Laminate and the worktop is in Gres th. 1,2 cm. Sideboards are in Noce Naturale Wood Bilaminate with back panel in finishing.





Le colonne sono in Bilaminato opaco Grigio Medio ed i vani a giorno Waind sono in Bilaminato Legno Noce Naturale.
The columns are in Matt Bilaminate Grigio Medio and Waind open units are in Noce Naturale Wood Bilaminate.





ANUBA

LACCATO OPACO PAXOS GREY



BILAMINATO LEGNO ROVERE RUSTICO





Le colonne concepite come dei portali sono in Laccato opaco Paxos Grey con inserti e maniglie Ride-M/XL canna di fucile.

Tall units are designed like portals and are made in matt Lacquered Paxos Grey with inserts and Ride-M/ XL gunmetal finish handles.





L'irresistibile fascino delle atmosfere mediterranee.

THE IRRESISTIBLE CHARM OF MEDITERRANEAN ATMOSPHERES

L'isola è in Laccato opaco Paxos Grey con inserti e maniglie Ride-XL canna di fucile. Il piano di lavoro alto spessore è in Gres Marmorino Oro opaco, accanto ad esso un piano in Gres sp. 1,2 cm in finitura e uno snack alto spessore in Bilaminato Legno Rovere Rustico.

The island is made in matt lacquered Paxos Grey with inserts and gunmetal finish handle Ride-XL. The thick worktop is in matt Marmorino Oro gres finish. Next to it a 1,2 cm thick worktop in the same finish and a snack in Rovere Rustico Wood Bilaminate finish.





Dettaglio maniglie Ride-M/XL canna di fucile
Ride-M/XL gunmetal handle detail



MEDEA

BILAMINATO 22 OPACO **VISONE**



BILAMINATO 22 OPACO **BIANCO LUNA**



BILAMINATO LEGNO **NOCE ADIGE**

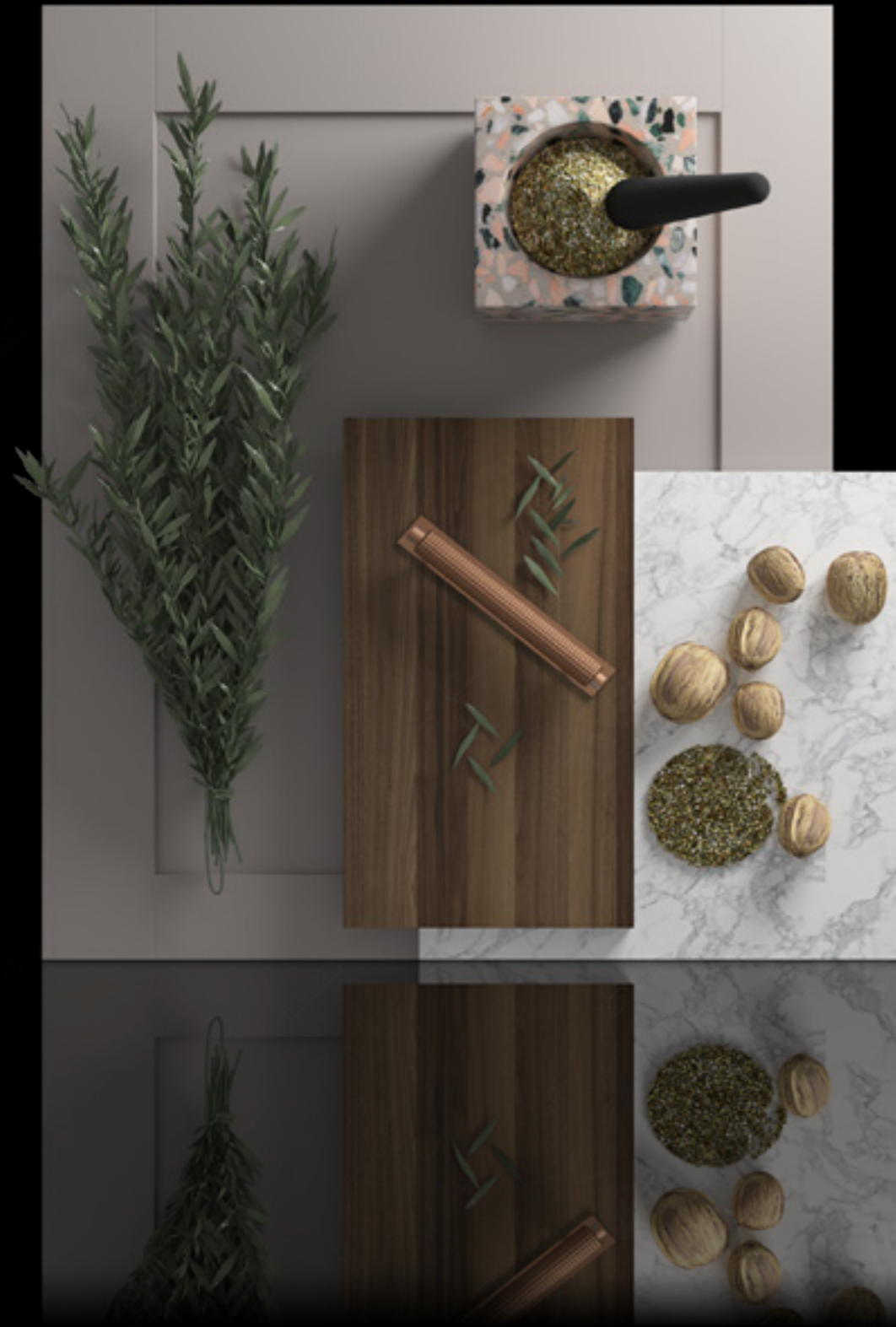



*Un equilibrato intreccio di
memoria e innovazione.*

A BALANCED WEAVING OF MEMORY AND INNOVATION







Le basi e i pensili a parete sono in Bilaminato 22 opaco Visone. La boiserie Frame è costituita da tramezzi in alluminio anodizzato bronzo scuro, schienali in Bilaminato Visone opaco e mensole led in Bilaminato Legno Noce Adige. Top in gres Arabescato Oro opaco da sp. 1,2 cm con fascia monoblocco in finitura.

Base and wall mounted units are made in Matt 22 Bilaminate Visone. The Frame boiserie is composed by dark bronze anodized aluminum partitions, back panels in matt Bilaminate Visone and led shelves in Wood Bilaminate Noce Adige. Worktop in Arabescato Oro gres matt finish th. 1,2 cm and sink cover in finishing.





L'isola e le colonne sono in Bilaminato 22 opaco Bianco Luna, il piano snack è in Bilaminato Legno Noce Adige. I moduli a giorno Frame posti alle estremità dell'isola sono in alluminio anodizzato bronzo scuro con ripiani in vetro fumè.

The island and columns are in Matt 22 Bilaminate Bianco Luna, the snack plan is in Wood Bilaminate Noce Adige. Frame open units placed at the ends of the island are in dark bronze anodized aluminum with smoked glass shelves.



TES

LACCATO OPACO CARRUBA



BILAMINATO LEGNO NOCE ADIGE







L'isola, le colonne e le basi a parete sono in laccato opaco Carruba con maniglia Rem S e Rem L in finitura canna di fucile. Il Top è in gres Taj Mahal Silk sp. 4 cm. Il piano snack è in Bilaminato legno Noce Adige sp.6 cm. In alto un dettaglio della maniglia Rem L in finitura canna di fucile.

The island, columns and the base units are in matt lacquered Carruba with Rem S e Rem L in gunmetal finish. Worktop is in matt gres Taj Mahal Silk th. 4 cm. The snack plane is in wood bilaminated Noce Adige. Above, a detail of the Rem L handle in gunmetal finish.





La credenza è costituita dalle vetrine con struttura in bilaminato legno Noce Adige e anta vetro Petra. Le basi sono in Laccato opaco Carruba con maniglia Rem S e Rem L canna di fucile.

The sideboard consists of the glass unit with structure in bilaminated wood Noce Adige and Petra glass door. The base units are in Carruba matt lacquered with Rem S and Rem L gunmetal handles.

Ispirazioni contemporanee per un ambiente autentico.

CONTEMPORARY INSPIRATIONS FOR AN AUTHENTIC ENVIRONMENT.



L'isola è in Laccato opaco Carruba con maniglia Rem S in finitura canna di fucile. Il Top e il monoblocco sono in gres Taj Mahal Silk sp 4 cm. Il piano snack è in Bilaminato legno Noce Adige.

The island is in matt Lacquered Carruba with Rem S in gunmetal finish. Worktop is in matt gres Taj Mahal Silk th. 4 cm. The snack plane is in Wood Bilaminate Noce Adige.



TES

LACCATO OPACO GRIGIO BOX



BILAMINATO LEGNO NOCE MONZA







*Inedite suggestioni tra
profumi e calore domestico.*

INEDITED SUGGESTIONS BETWEEN FRAGRANCES AND DOMESTIC WARMTH.





La penisola con anta Tes è in Laccato opaco Grigio Box con metodo di apertura tramite gola raggio \emptyset nero traffico, il piano di lavoro è in Gres Statuario opaco sp. 1,2 cm.

The Tes peninsula is made in Grigio Box matt Lacquered with opening by black groove raggio \emptyset , the worktop is in Statuario gres matt finish.





Le colonne sono Ménta in Bilaminato Legno Noce Monza ed il vano a giorno è in Laminato PET Nero Onice da 12 mm.

Ménta Columns are in Noce Monza Wood Bilaminate and open space unit is in Matt Nero Onice PET Laminate th. 12 mm.



TALIA

LACCATO OPACO PORO APERTO GRIGIO ANTRACITE



LACCATO OPACO PORO APERTO COTONE



BILAMINATO LEGNO NOCE AMERICANO

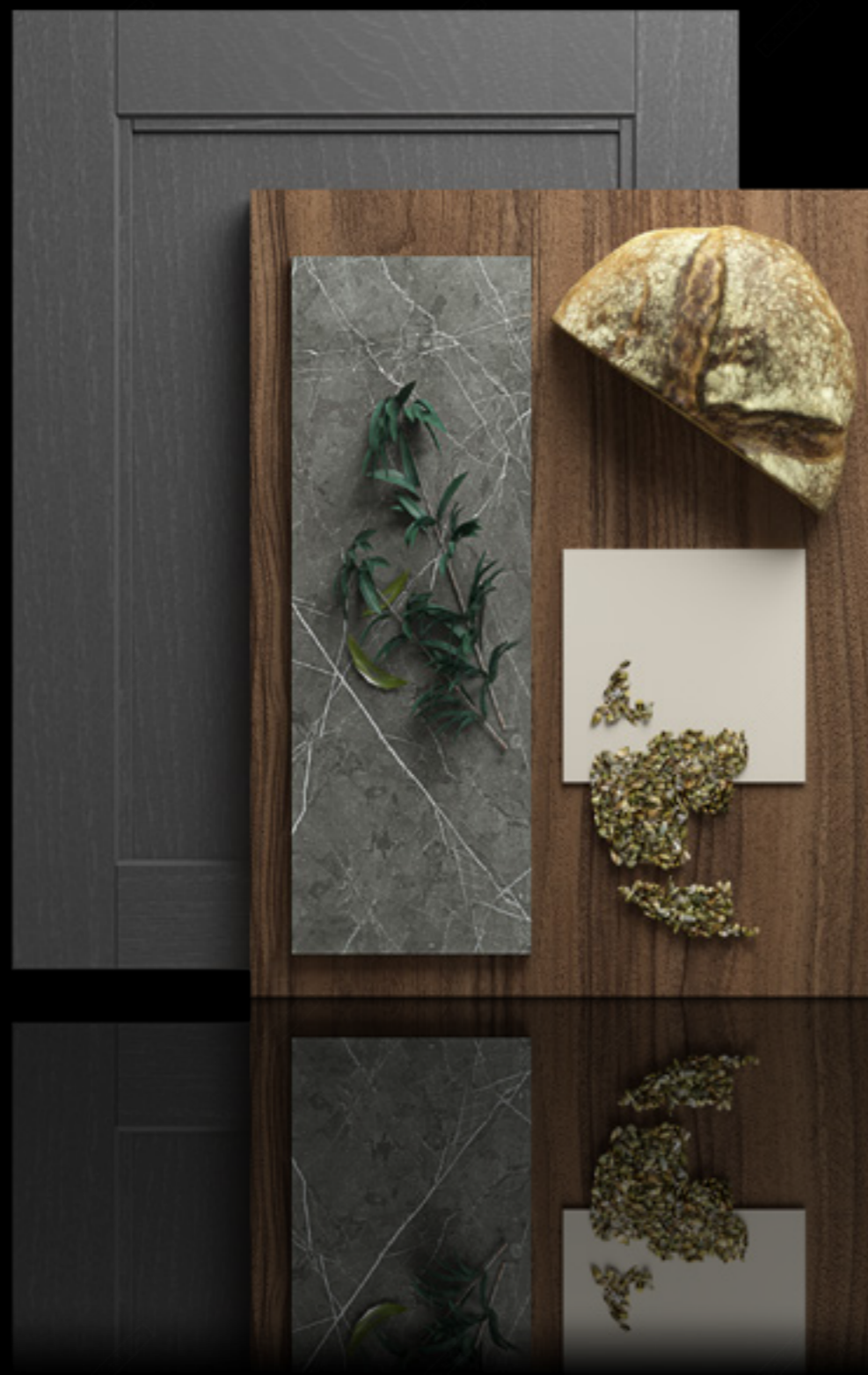





*Un'anima tradizionale vestita
di rigore architettonico.*

A TRADITIONAL SOUL FRAMED WITH ARCHITECTURAL STRICTNESS.





Le colonne sono in laccato opaco poro aperto Cotone con maniglia Tube nera, i vani a giorno Waind sono in bilaminato legno Noce Americano con schienali di serie in Nero Carbone.

The tall units are in matt lacquered Open Pore Cotone with black Tube handle, Waind open units are in wood bilaminate Noce Americano and its standard back panels are in bilaminate Nero Carbone.





La penisola è in laccato opaco poro aperto Grigio Antracite con gola nera ed il piano di lavoro è in gres sp. 1,2 cm. I pensili sono in Bilaminato legno Noce Americano.

The peninsula is in matt lacquered open Pore Grigio Antracite with black groove and the worktop is in Gres matt th. 1,2 cm. Wall units are in Noce Americano Wood Bilaminate.



Dettaglio della libreria Pivot costituita da pali in alluminio nero opaco e da mensole laccato opaco Nero Traffico.

Detail of Pivot library composed by poles in black matt aluminum and matt lacquered Nero Traffico shelves.



TECNICHE

TECHNICAL

MÉNTA

BILAMINATO OPACO GRIGIO EMME +
BILAMINATO LEGNO EUCALIPTO FUMO

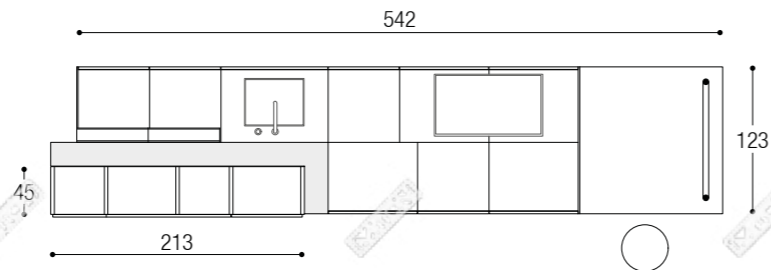
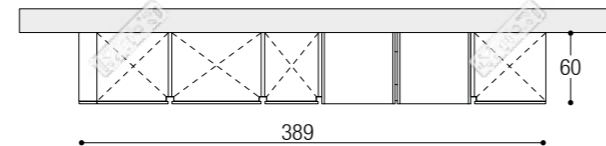
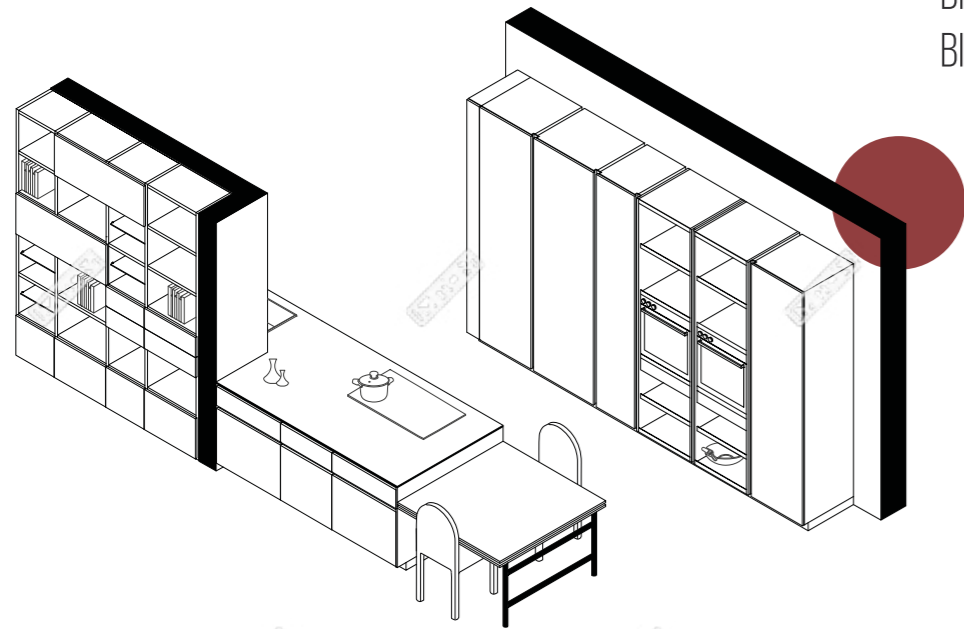

ANTA COLONNE_ MÉNTA BILAMINATO OPACO GRIGIO EMME
SISTEMA WAIND_ STRUTTURA APERTA IN BILAMINATO LEGNO EUCALIPTO FUMO CON SCHIENA IN FINITURA ED ILLUMINAZIONE LED
ANTA ISOLA_ MÉNTA BILAMINATO OPACO GRIGIO EMME
ANTA ISOLA_ MÉNTA IN BILAMINATO LEGNO EUCALIPTO FUMO
WORKTOP_ GRES PIETRA PIASENTINA GRIGIO FIAMMATO
LIBRERIA_ LIBRERIA BIFACCIALE IN BILAMINATO LEGNO EUCALIPTO FUMO E ANTE IN BILAMINTO OPACO GRIGIO EMME ED ILLUMINAZIONE LED
TAVOLO_ SANDWICH IN BILAMINATO LEGNO EUCALIPTO FUMO
NEW GRID_ SCHIENA IN BILAMINATO LEGNO EUCALIPTO FUMO E MENSOLA IN LAMINATO PET NERO ONICE

COLUMNS DOOR_ MÉNTA GRIGIO EMME MATT BILAMINATE
WAIND SYSTEM_ OPEN STRUCTURE IN WOOD BILAMINATE EUCALIPTO FUMO WITH BACK PANEL IN THE SAME FINISH AND LED LIGHT
ISLAND DOOR_ MÉNTA GRIGIO EMME MATT BILAMINATE
ISLAND DOOR_ MÉNTA WOOD BILAMINATE EUCALIPTO FUMO
WORKTOP_ PIETRA PIASENTINA GRIGIO FIAMMATO MATT GRES
LIBRARY_ TWO-SIDE LIBRARY IN WOOD BILAMINATE EUCALIPTO FUMO AND GRIGIO EMME DOORS WITH LED LIGHT
TABLE_ SANDWICH IN WOOD BILAMINATE EUCALIPTO FUMO
NEW GRID_ BACK PANEL IN WOOD BILAMINATE EUCALIPTO FUMO WITH SHELVES IN LAMINATE PET NERO ONICE OPACO

MÉNTA

BILAMINATO OPACO BETON GIOVE +
LAMINATO PET OPACO NERO ONICE +
BILAMINATO LEGNO ROVERE SCANDY

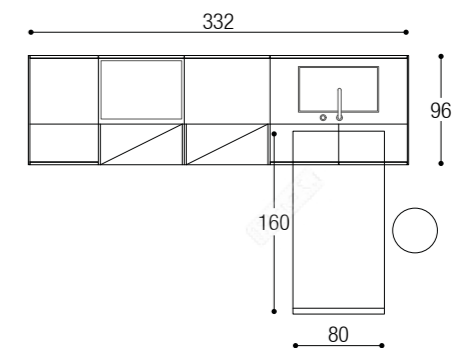
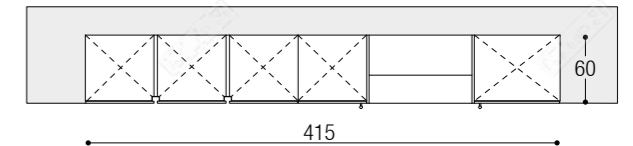
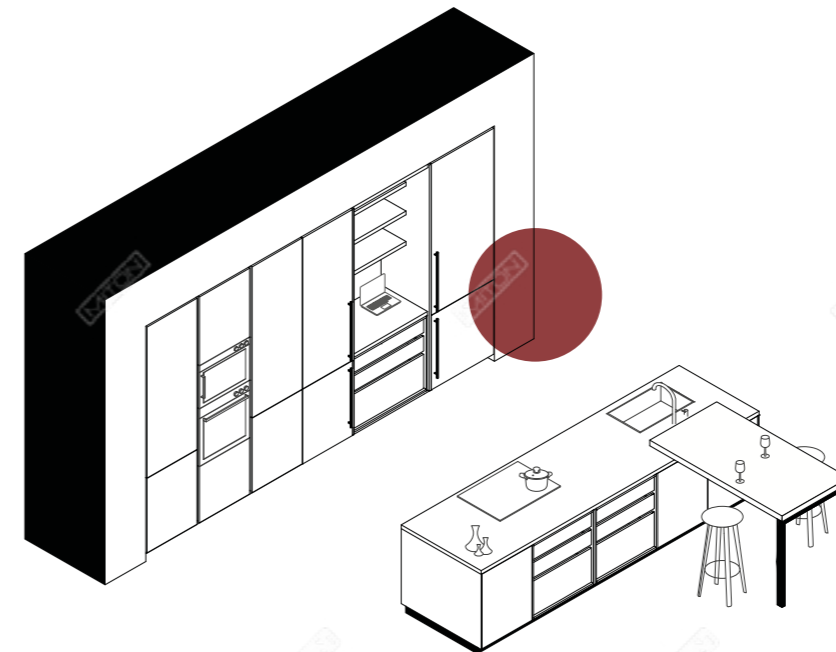

ANTA COLONNE_ MÉNTA COSTITUITA DA PANNELLO IN LAMINATO PET NERO ONICE OPACO
HOME OFFICE_ STRUTTURA APERTA IN BILAMINATO LEGNO ROVERE SCANDY CON PIANO, MENSOLE E ILLUMINAZIONE LED
ANTA ISOLA_ MÉNTA IN BILAMINATO CEMENTO BETON GIOVE
BASI IN LUCE_ FRONTALE IN BILAMINATO LEGNO ROVERE SCANDY E STRUTTURA IN NERO CARBONE
SNACK_ PIANO IN BILAMINATO LEGNO ROVERE SCANDY GAMBA INDUSTRIAL NERA
ANTA VETRINA_ ANTA VETRO PETRA CON TELAIO IN ALLUMINIO NERO TRAFFICO E VETRO NERO FUMÈ
WORKTOP_ IN GRES FOKOS SALE SP. 4 CM

COLUMNS DOOR_ MENTA COMPOSED BY PANEL IN PET LAMINATE NERO ONICE MATT
HOME OFFICE_ OPEN STRUCTURE IN BILAMINATE WOOD ROVERE SCANDY WITH PLAN, SHELVES AND LED LIGHTING
ISLAND DOOR_ MENTA IN BILAMINATE CEMENTO BETON GIOVE
BASE UNIT IN VIEW_ FRONTS IN BILAMINATE WOOD ROVERE SCANDY AND STRUCTURE IN BLACK CARBON
SNACK_ TOP IN BILAMINATE WOOD ROVERE SCANDY BLACK INDUSTRIAL FOOT
SHOWCASE_ PETRA GLASS FRONT WITH BLACK TRAFFICO ALUMINUM FRAME AND BLACK SMOKED GLASS
WORKTOP_ IN FOKOS SALE GRES TH. 4 CM

MÉNTA

LAMINATO PET OPACO BIANCO NORDICO +
BILAMINATO LEGNO ROVERE CHIARO

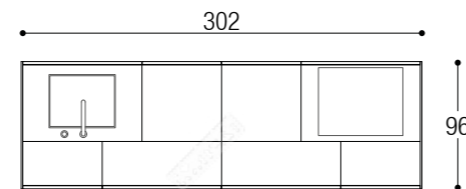
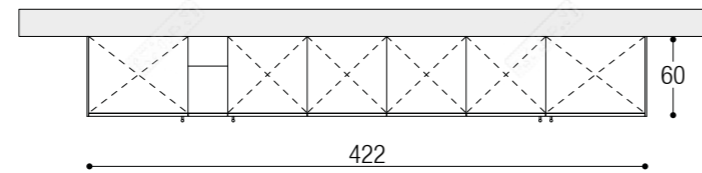
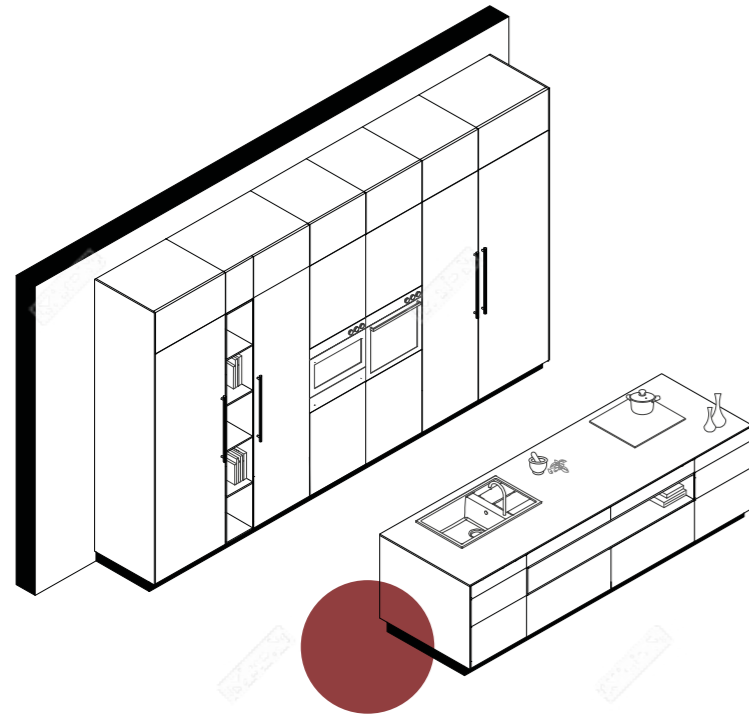

COLUMNS DOOR_ MÉNTA PET LAMINATE IN BIANCO NORDICO FINISH
BASE UNIT DOOR_ MÉNTA PET LAMINATE IN BIANCO NORDICO FINISH
OPEN SPACE_ IN WOOD BILAMINATE ROVERE CHIARO
WORKTOP_ GRES WHITE MAT FINISH TH. 1,2 CM

MÉNTA

BILAMINATO LEGNO NOCE ADIGE +
LAMINATO PET OPACO CRETA OPACO

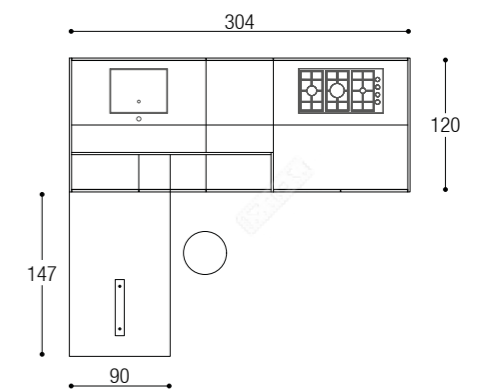
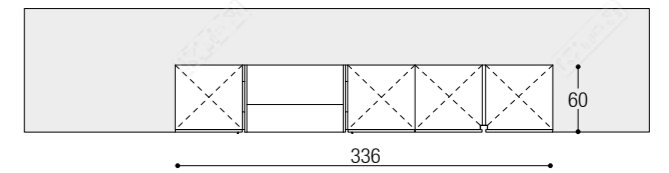
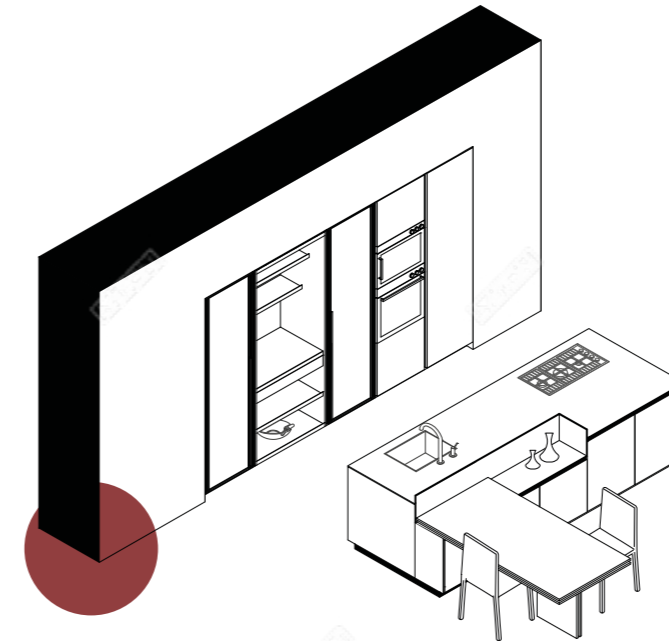

ANTA COLONNE_ MÉNTA BILAMINATO LEGNO IN FINITURA NOCE ADIGE
SISTEMA WAIND_ STRUTTURA APERTA IN BILAMINATO LEGNO NOCE ADIGE ED ILLUMINAZIONE LED
ANTA VETRINA_ BELLEVUE CON TELAIO IN ALLUMINIO NERO OPACO, VETRO FUMÉ E MANIGLIA LINEAR VERTICALE. STRUTTURA IN BILAMINATO LEGNO NOCE ADIGE ED ILLUMINAZIONE LED
ANTA ISOLA_ MÉNTA LAMINATO PET IN FINITURA CRETA OPACO
TAVOLO_ IN FINITURA BILAMINATO LEGNO NOCE ADIGE
GOLA_ ELLE IN FINITURA NERO TRAFFICO OPACO

COLUMNS DOOR_ MÉNTA WOOD BILAMINATE NOCE ADIGE FINISH
WAIND SYSTEM_ OPEN STRUCTURE IN WOOD BILAMINATE NOCE ADIGE AND LED LIGHT
GLASS UNIT DOOR_ BELLEVUE WITH MATT BLACK ALUMINUM FRAME, SMOKED GLASS AND LINEAR HANDLE. STRUCTURE IN WOOD BILAMINATE NOCE ADIGE AND LED LIGHT
ISLAND DOOR_ MÉNTA IN PET LAMINATE CRETA OPACO
TABLE_ IN WOOD BILAMINATE NOCE ADIGE FINISH
GROOVE_ ELLE IN MATT BLACK FINISH

MÉNTA

BILAMINATO LEGNO NOCE CORDESCO +
LAMINATO PET OPACO VERDE POLVERE

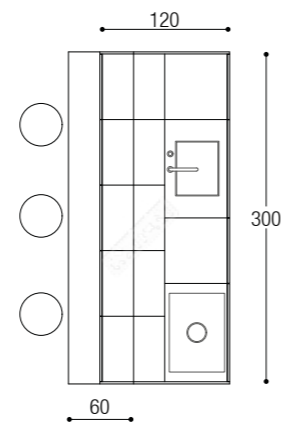
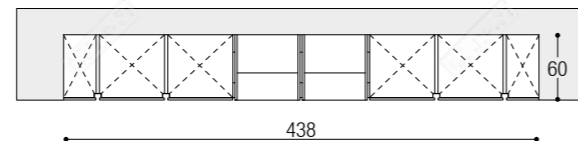
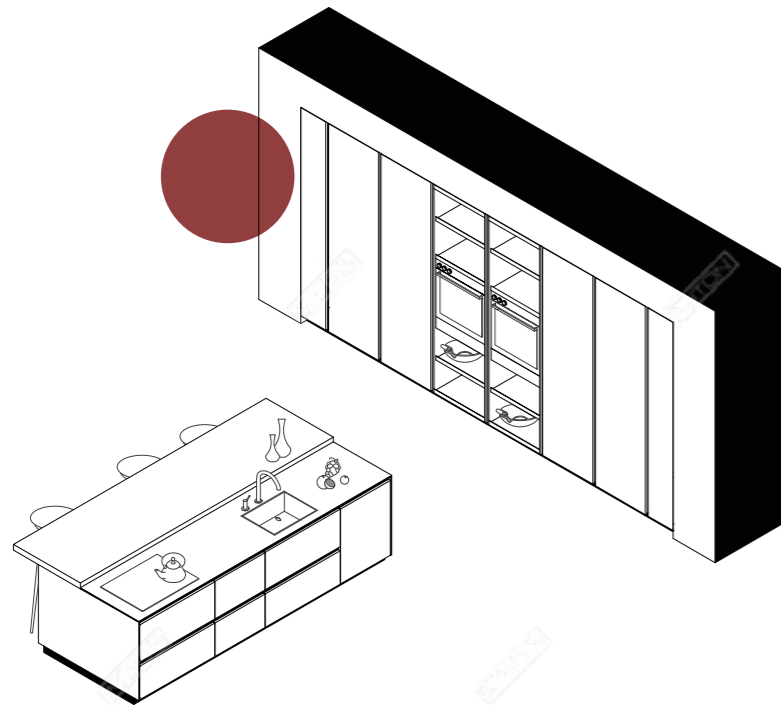

ANTA COLONNA_ MÉNTA LAMINATO PET VERDE POLVERE OPACO
SISTEMA WAIND_ STRUTTURE APERTE IN BILAMINATO LEGNO NOCE
CORDESCO E ILLUMINAZIONE LED
ANTA ISOLA_ MÉNTA BILAMINATO LEGNO NOCE CORDESCO
WORKTOP_ GRES IN FINITURA NERO GRECO SPESSORE 1,2 CM

COLUMN DOORS_ MÉNTA PET LAMINATE MATT VERDE POLVERE
WAIND SYSTEM_ OPEN SPACE MODULE IS IN BILAMINATE WOOD FINISH
NOCE CORDESCO AND LED LIGHT
ISLAND DOOR_ MÉNTA IS MADE IN WOOD BILAMINATE NOCE CORDESCO
WORKTOP_ GRES NERO GRECO FINISH TH. 1,2 CM

MÉNTA

LAMINATO PET OPACO GRIGIO ARDESIA +
BILAMINATO OPACO GRIGIO MEDIO OPACO +
BILAMINATO LEGNO NOCE NATURALE

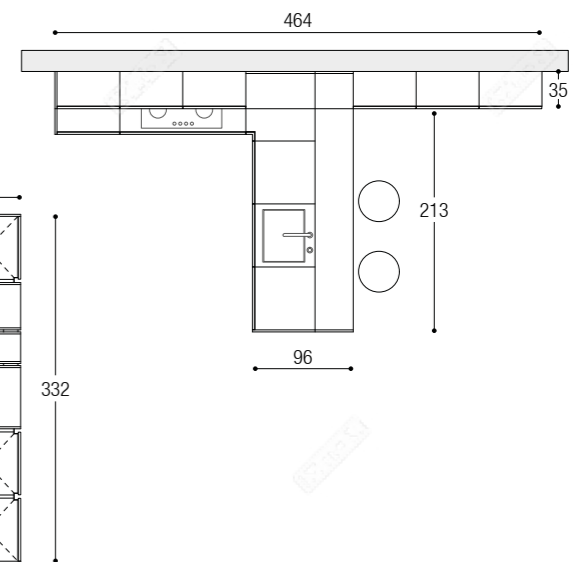
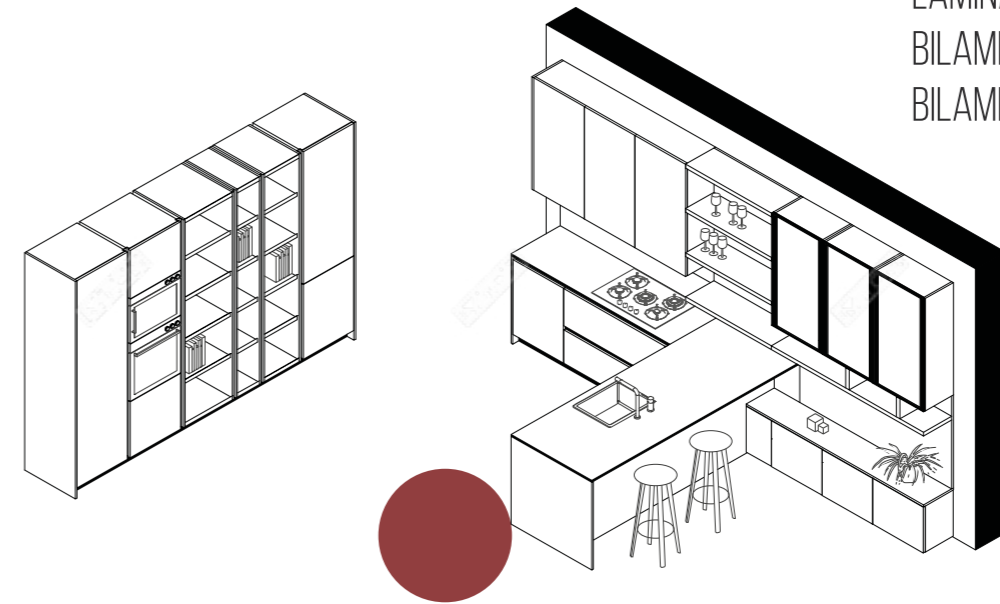

ANTA COLONNE_ MÉNTA BILAMINATO OPACO IN FINITURA GRIGIO
MEDIO OPACO
ANTA BASI E PENSILI_ MÉNTA LAMINATO PET GRIGIO ARDESIA OPACO
ANTA VETRINA_ BELLEVUE CON TELAIO IN ALLUMINIO NERO
OPACO E VETRO FUMÉ STRUTTURA IN GRIGIO ANTRACITE OEA E
ILLUMINAZIONE LED
SISTEMA WAIND_ STRUTTURA APERTA IN BILAMINATO LEGNO
NOCE NATURALE CON SCHIENALI DI SERIE GREY FABRIC ED
ILLUMINAZIONE LED
WORKTOP_ GRES OPACO SPESSORE 1,2 CM

COLUMNS DOOR_ MÉNTA MATT BILAMINATE GRIGIO MEDIO FINISH
BASE UNITS AND WALL UNITS DOOR_ MÉNTA MATT PET LAMINATE
GRIGIO ARDESIA FINISH
GLASS UNIT DOOR_ BELLEVUE WITH MATT BLACK ALUMINUM FRAME,
SMOKED GLASS AND LINEAR HANDLE. STRUCTURE IN BILAMINATE
ANTRACITE OEA AND LED LIGHT
WAIND SYSTEM_ OPEN STRUCTURE IN WOOD BILAMINATE NOCE
NATURALE WITH STANDARD BACK PANEL IN GREY FABRIC AND LED LIGHT
WORKTOP_ MATT GRES TH. 1,2 CM

ANUBA

LACCATO OPACO PAXOS GREY +
BILAMINATO LEGNO ROVERE RUSTICO

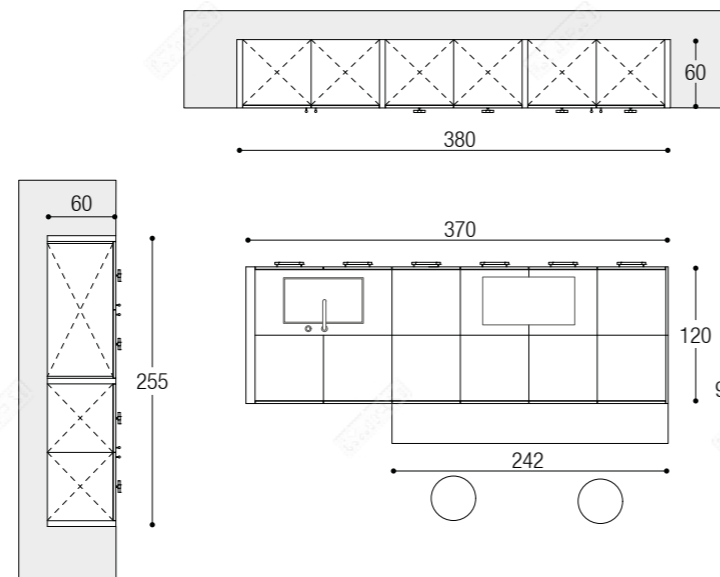
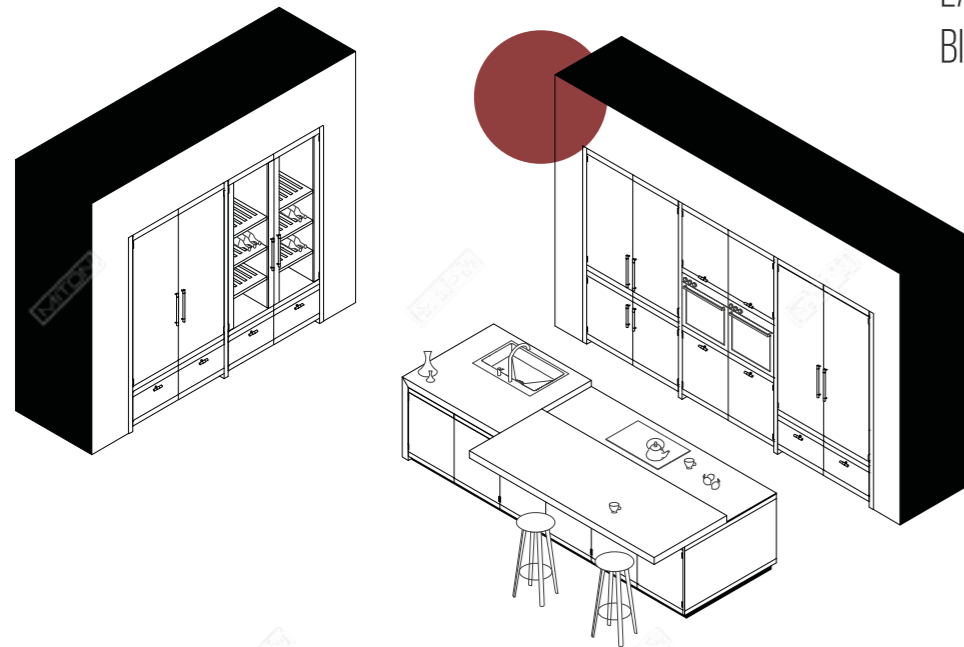

ANTA COLONNE E ISOLA_ ANUBA FINITURA LACCATO OPACO PAXOS GREY CON FRESATE, GLI INSERTI E LE MANIGLIE RIDE SONO IN FINITURA CANNA DI FUCILE
SNACK_ IN BILAMINATO LEGNO FINITURA ROVERE RUSTICO
MONOBLOCCO LAVELLO_ IN GRES MARMORINO ORO OPACO SP. 8 CM
WORKTOP_ IN GRES MARMORINO ORO OPACO SP. 1,2 CM

COLUMN AND ISLAND DOOR_ ANUBA IS MADE IN MATT LACQUERED PAXOS GREY WITH MILLED LINE, INSERTS AND RIDE HANDLES ARE IN GUNMETAL
FINISH SNACK_ IS IN WOOD BILAMINATE ROVERE RUSTICO
FINISH SINK BLOCK_ IS MADE IN GRES MATT MARMORINO ORO TH. 8 CM
WORKTOP_ IS IN GRES MATT MARMORINO ORO TH. 1,2 CM

MEDEA

BILAMINATO 22 VISONE OPACO +
BILAMINATO 22 BIANCO LUNA OPACO +
BILAMINATO LEGNO NOCE ADIGE

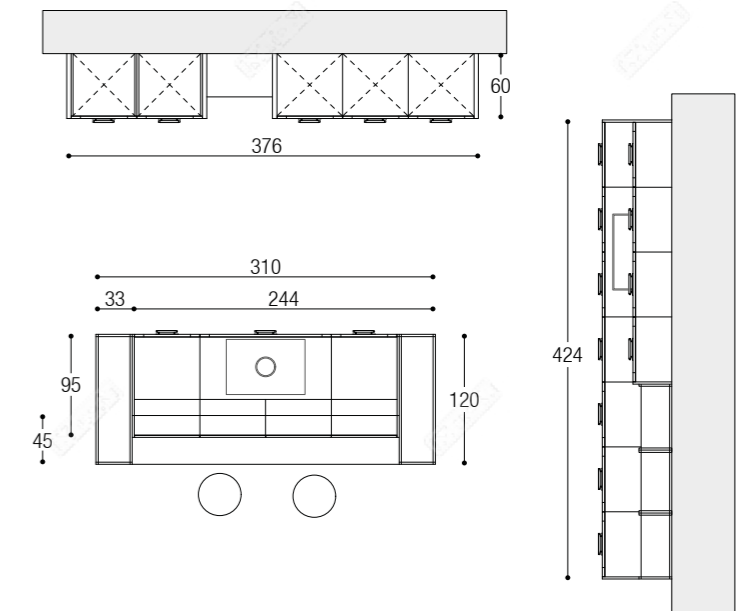
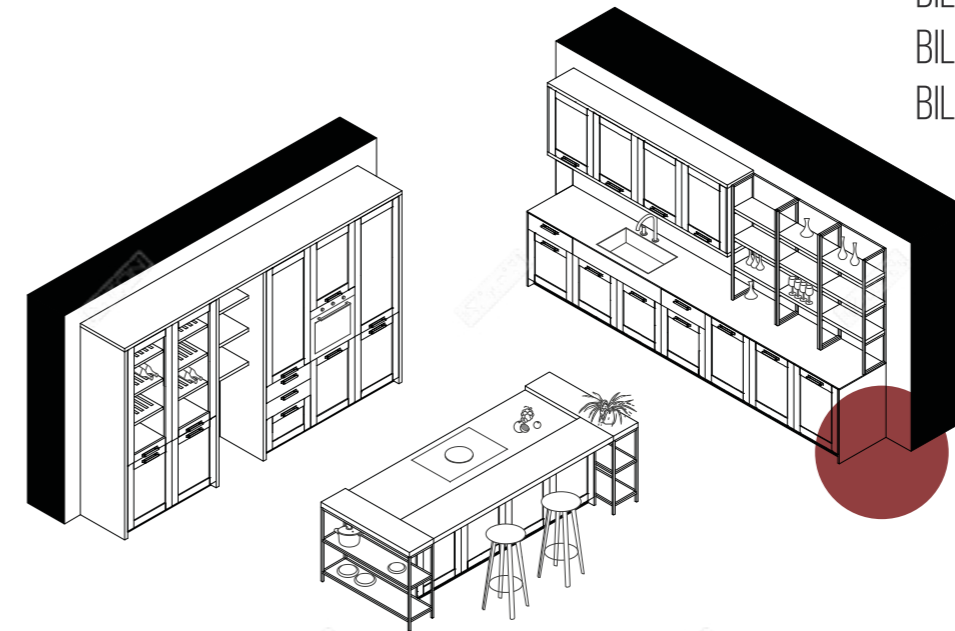

ANTA COLONNE E BASI_ MEDEA IN FINITURA BILAMINATO 22 OPACO VISONE E BIANCO LUNA
BOISERIE_ FRAME IN ALLUMINIO ANODIZZATO BRONZO SCURO E BILAMINATO LEGNO NOCE ADIGE
ANTA ISOLA_ MEDEA IN FINITURA BILAMINATO LEGNO NOCE ADIGE
VANI A GIORNO FRAME_ IN ALLUMINIO ANODIZZATO BRONZO SCURO CON RIPIANI IN BILAMINATO LEGNO NOCE ADIGE DA SP. 4 CM
WORKTOP_ IN GRES ARABESCATO ORO OPACO SP. 1,2 CM

COLUMNS AND BASE UNITS DOOR_ MÉDEA IN MATT 22 BILAMINATE VISONE AND BIANCO LUNA
BOISERIE_ FRAME IN ANODIZED ALUMINUM BRONZO SCURO AND WOOD BILAMINATE NOCE ADIGE
ISLAND DOOR_ MÉDEA IN WOOD BILAMINATE NOCE ADIGE
OPEN UNITS FRAME_ IN ANODIZED ALUMINUM BRONZO SCURO WITH SMOKED GLASS SHELVES
WORKTOP_ IN GRES MATT ARABESCATO ORO TH. 1,2 CM

TES

LACCATO OPACO CARRUBA +
BILAMINATO LEGNO NOCE ADIGE

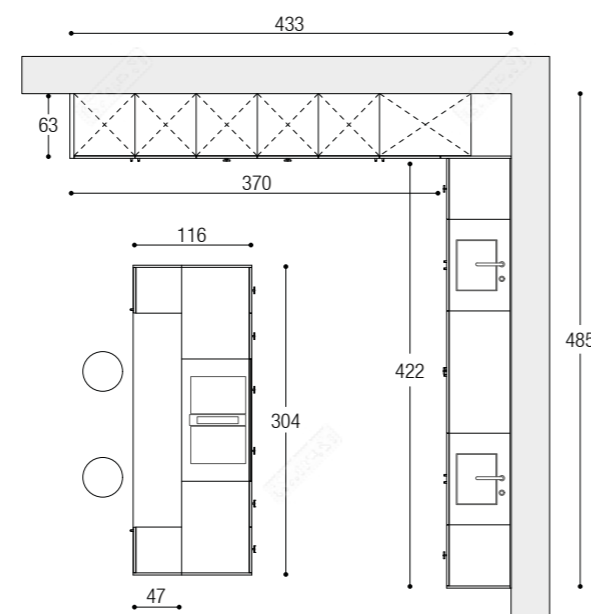
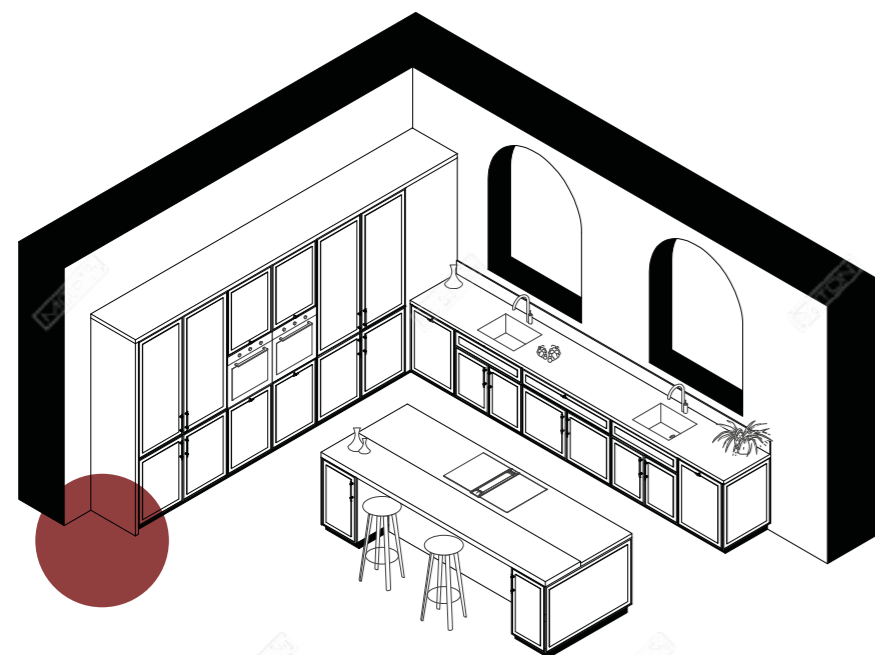

ANTA COLONNE, BASI_ TES IN FINITURA LACCATO OPACO CARRUBA CON MANIGLIA REM S E REM L FINITURA CANNA DI FUCILE
WORKTOP_ GRES TAJ MAHAL SILK SP. 4 CM
MANIGLIA_ REM S E REM L FINITURA CANNA DI FUCILE
VETRINE_ STRUTTURA IN BILAMINATO LEGNO NOCE ADIGE, VETRINA PETRA CON VETRO FUMÈ
PIANO SNACK_ BILAMINATO LEGNO NOCE ADIGE

COLUMNS, BASE DOOR_ TES MATT LACQUERED CARRUBA WITH REM S AND REM L HANDLE GUNMETAL FINISH
WORKTOP_ GRES MATT TAJ MAHAL SILK TH. 4 CM
HANDLE_ REM S AND REM L GUNMETAL FINISH
GLASS UNIT_ BILAMINATE WOOD NOCE ADIGE STRUCTURE, PETRA DOOR WITH SMOKED GLASS
SNACK PLANE_ BILAMINATE WOOD NOCE ADIGE

TES

LACCATO OPACO GRIGIO BOX +
BILAMINATO LEGNO NOCE MONZA

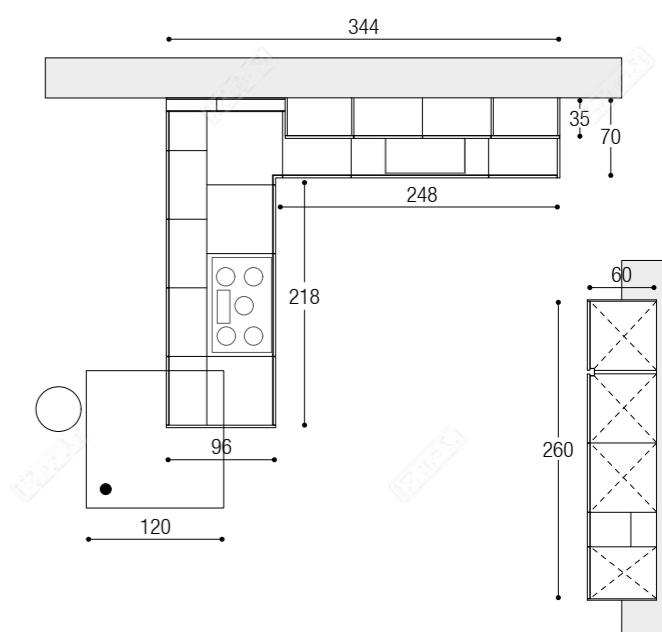
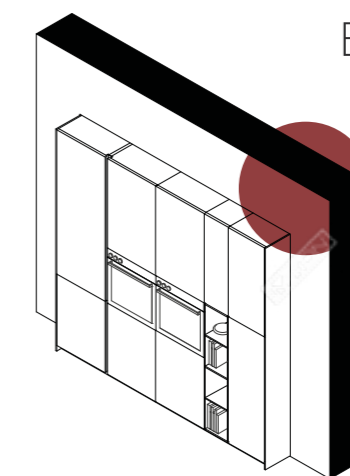
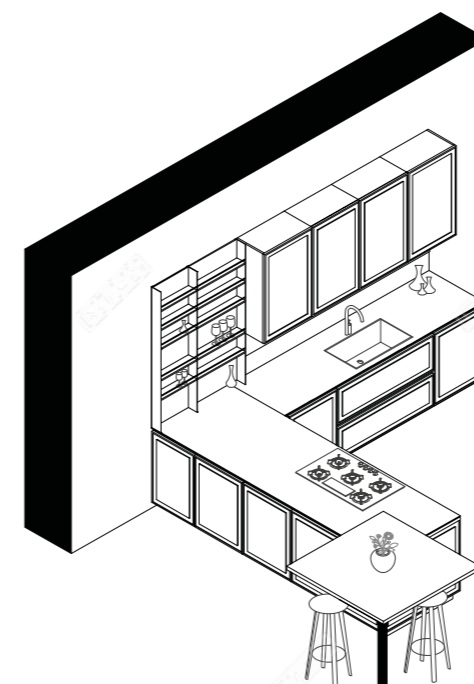

ANTA COLONNE_ MÉNTA BILAMINATO LEGNO IN FINITURA NOCE MONZA
ANTA BASI_ TES LACCATO OPACO GRIGIO BOX
ANTA VETRINA_ TES CON TELAIO LACCATO OPACO GRIGIO BOX, VETRO EXTRACHIARO ED ILLUMINAZIONE LED
WORKTOP_ GRES STATUARIO OPACO SPESSORE 1,2 CM
PIANO SNACK_ BILAMINATO LEGNO IN FINITURA NOCE MONZA
NEW GRID_ SCHIENA IN BILAMINATO LEGNO EUCALIPTO FUMO E MENSOLA IN LAMINATO PET NERO ONICE

COLUMNS DOOR_ MÉNTA WOOD BILAMINATE NOCE MONZA
BASE UNITS DOOR_ TES MATT LACQUERED GRIGIO BOX
GLASS UNIT DOOR_ TES MATT LACQUERED GRIGIO BOX, EXTRA-CLEAR GLASS AND LED LIGHT
WORKTOP_ GRES MATT STATUARIO TH. 1,2 CM
SNACK PLANE_ WOOD BILAMINATE NOCE MONZA
NEW GRID_ BACK PANEL IN WOOD BILAMINATE NOCE MONZA WITH SHELVES IN PET LAMINATE NERO ONICE

TALÌA

LAC. OPACO PORO APERTO GRIGIO ANTRACITE +
 LAC. OPACO PORO APERTO COTONE OPACO +
 BILAMINATO LEGNO NOCE AMERICANO

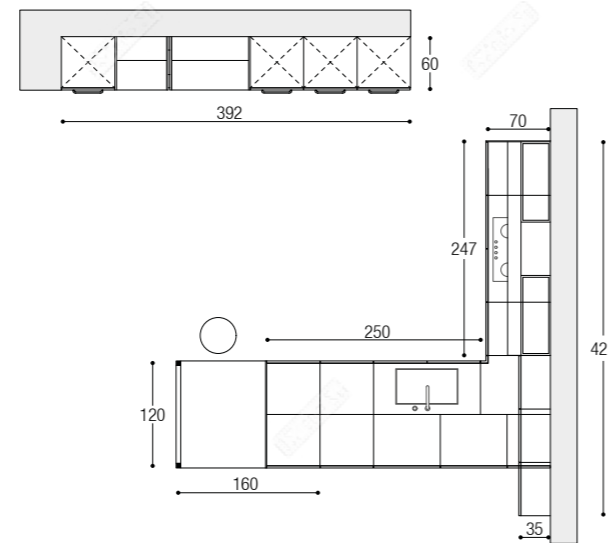
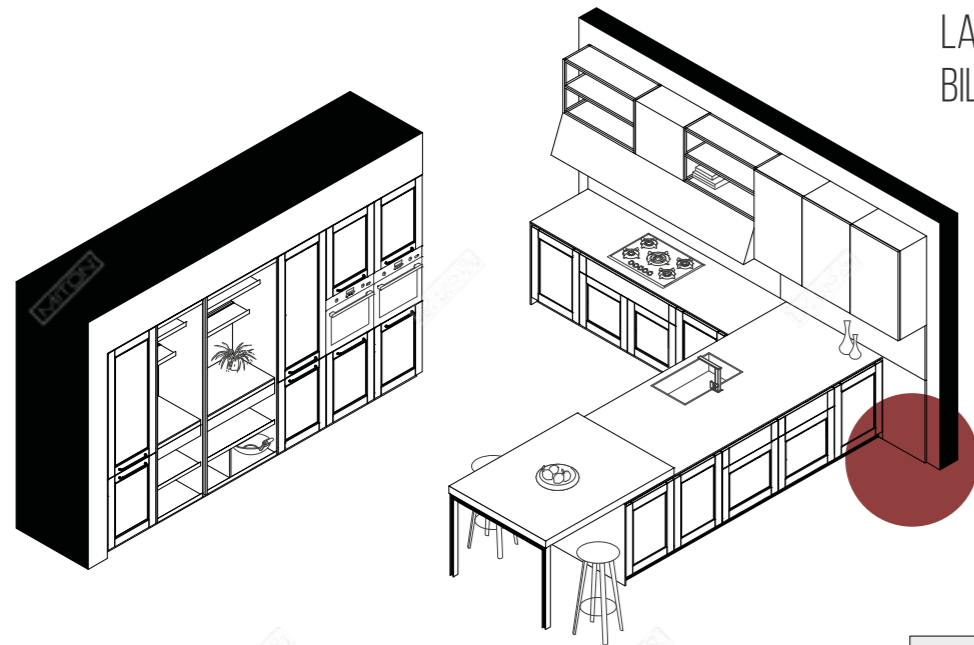

ANTA COLONNE_ TALÌA LACCATO OPACO PORO APERTO COTONE
 ANTA BASI_ TALÌA LACCATO OPACO PORO APERTO GRIGIO ANTRACITE
 ANTA PENSILI_ MÉNTA BILAMINATO LEGNO NOCE AMERICANO
 SISTEMA WAIND_ STRUTTURA APERTA IN BILAMINATO LEGNO
 NOCE AMERICANO CON SCHIENALI DI SERIE NERO CARBONE ED
 ILLUMINAZIONE LED
 WORKTOP_ GRES OPACO SP. 1,2 CM
 SNACK_ BILAMINATO LEGNO NOCE AMERICANO
 GAMBA_ INDUSTRIAL IN FINITURA NERO OPACO
 MANIGLIA_ TUBE IN FINITURA NERO OPACO

COLUMNS DOOR_ TALÌA MATT LACQUERED OPEN PORE COTONE
 BASE UNITS DOOR_ TALÌA MATT LACQUERED OPEN PORE GRIGIO ANTRACITE
 WALL UNITS DOOR_ MÉNTA SPECIAL WOOD VENEER NOCE AMERICANO
 WAIND SYSTEM_ OPEN STRUCTURE IN WOOD BILAMINATE NOCE
 AMERICANO WITH STANDARD BACK PANEL IN NERO CARBONE
 AND LED LIGHT
 WORKTOP_ MATT GRES TH. 1,2 CM
 SNACK PLANE_ BILAMINATE WOOD NOCE AMERICANO
 LEG_ INDUSTRIAL IN MATT BLACK FINISH
 HANDLE_ TUBE IN MATT BLACK FINISH

MATERIALI MATERIAL

BILAMINATO OPACO E CEMENTO /
MATT AND CONCRETE BILAMINATE

SP./TH. 20 MM

MÉNTA



BILAMINATO LEGNO / WOOD BILAMINATE

SP./TH. 20 MM

MÉNTA



BILAMINATO 22 OPACO / 22 MATT BILAMINATE SP./TH. 22 MM

MÉNTA



**LAMINATO PET OPACO E LUCIDO/
MATT AND GLOSSY PET LAMINATE**

SP./TH. 20 MM

MÉNTA



**BILAMINATO 22 OPACO E BILAMINATO LEGNO/
22 MATT BILAMINATE AND WOOD BILAMINATE**

MÉDEA



SP. 22 MM

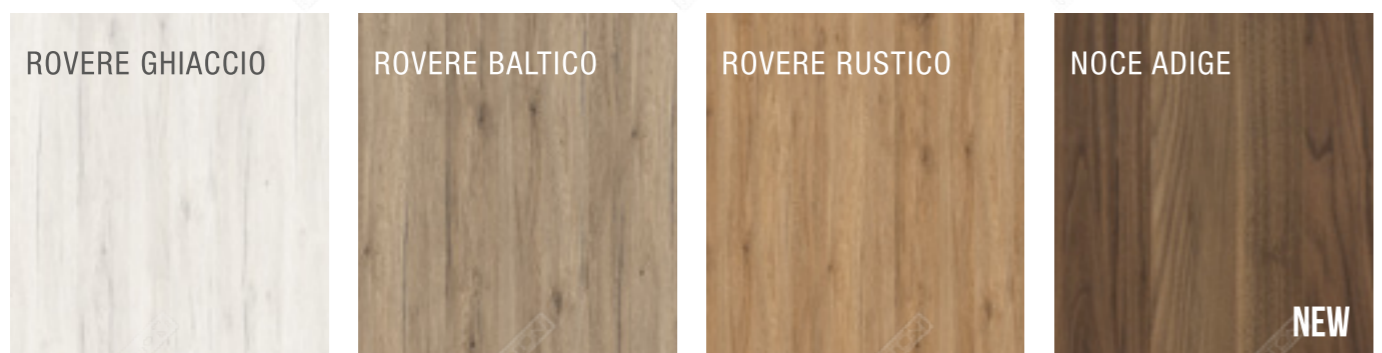

SP.
20
MM

**LACCATO OPACO E LUCIDO/
MATT AND GLOSSY LACQUERED**

SP./TH. 22 MM

MÉNTA /ANUBA*/ TES

TITAN WHITE	BIANCO PURO	AVORIO	SAHARA BEIGE
BEIGE KENIA	GRIGIO BOX	CAPPUCCINO	GRIGIO LAVA
FERRO	CARRUBA	CAFFE'	COTONE NEW
NOCCIOLA NEW			

**LACCATO OPACO E LUCIDO/
MATT AND GLOSSY LACQUERED**

SP./TH. 22 MM

MÉNTA /ANUBA*/ TES

ARAGOSTA	ROSSO TOSCA	ROSSO VINO	OTTANIO
INK BLUE	BLU OCEANO NEW	SALVIA	VERDE BOSCO
PAXOS GREY NEW	GRIGIO ANTRACITE	NERO TRAFFICO	

*NB: Anuba è disponibile solo laccato opaco / Anuba is only available matt lacquered
L'Anuba est uniquement disponible en laque mate / Anuba sólo está disponible en laca mate

*NB: Anuba è disponibile solo laccato opaco / Anuba is only available matt lacquered
L'Anuba est uniquement disponible en laque mate / Anuba sólo está disponible en laca mate

LAMINATO FENIX / FENIX LAMINATE

SP./TH. 21 MM

MÉNTA



LEGNO IMPIALLACCIATO / WOOD VENEER

SP./TH. 23 MM

MÉNTA

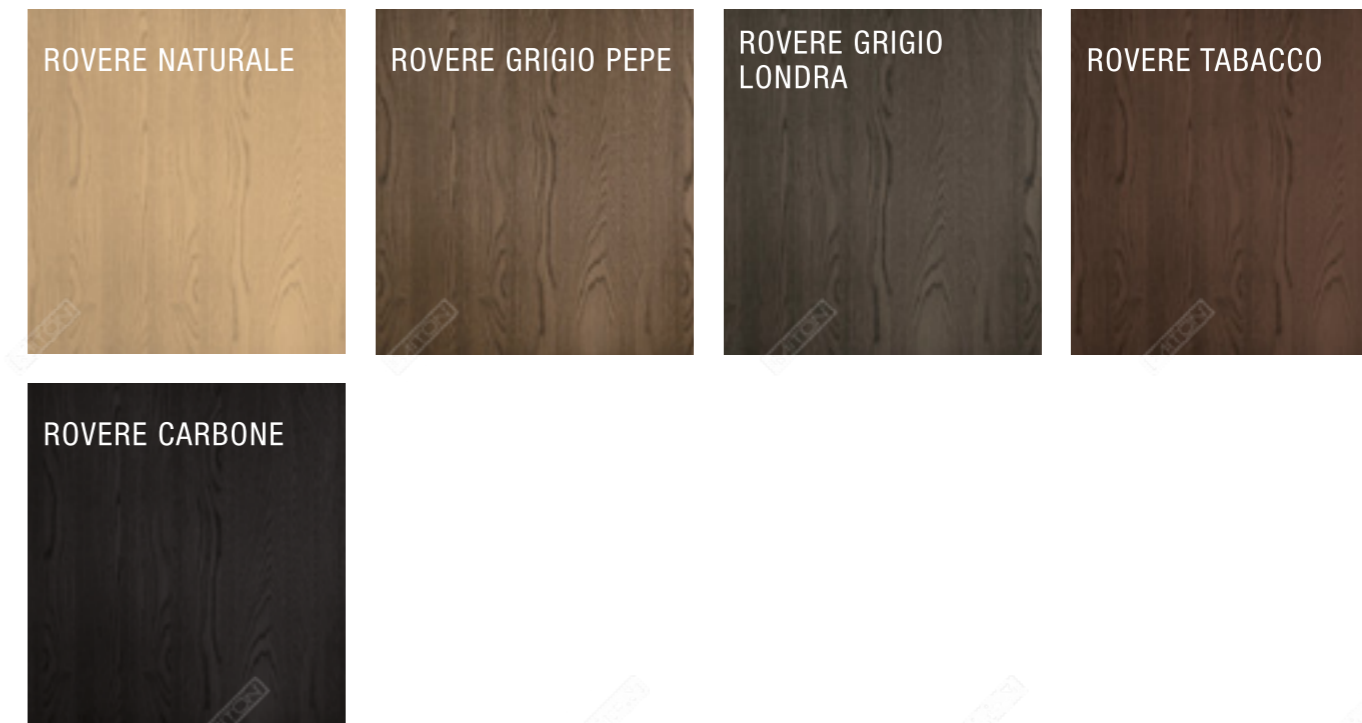

**LEGNO IMPIALLACCIATO SPECIALE /
SPECIAL WOOD VENEER**

SP./TH. 23 MM

MÉNTA

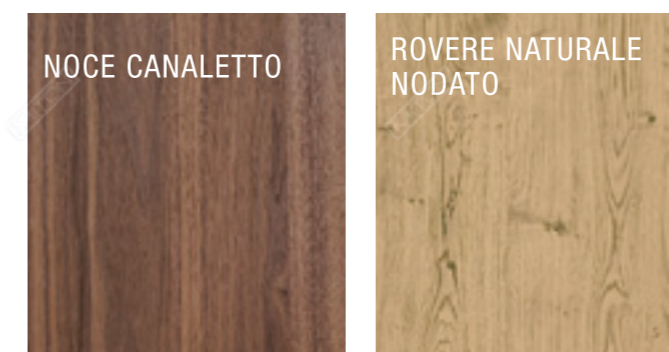

LAMINATO HPL / LAMINATE HPL

SP./TH. 21 MM

MÉNTA



LACCATO OPACO PORO APERTO /
MATT LACQUERED OPEN PORE

SP./TH. 22 MM

TALÌA / MÉNTA



LAMINATO HPL / HPL LAMINATE

SP./TH. 20/40 MM

WORKTOP



LAMINATO HPL / HPL LAMINATE

SP./TH. 20/40 MM

WORKTOP

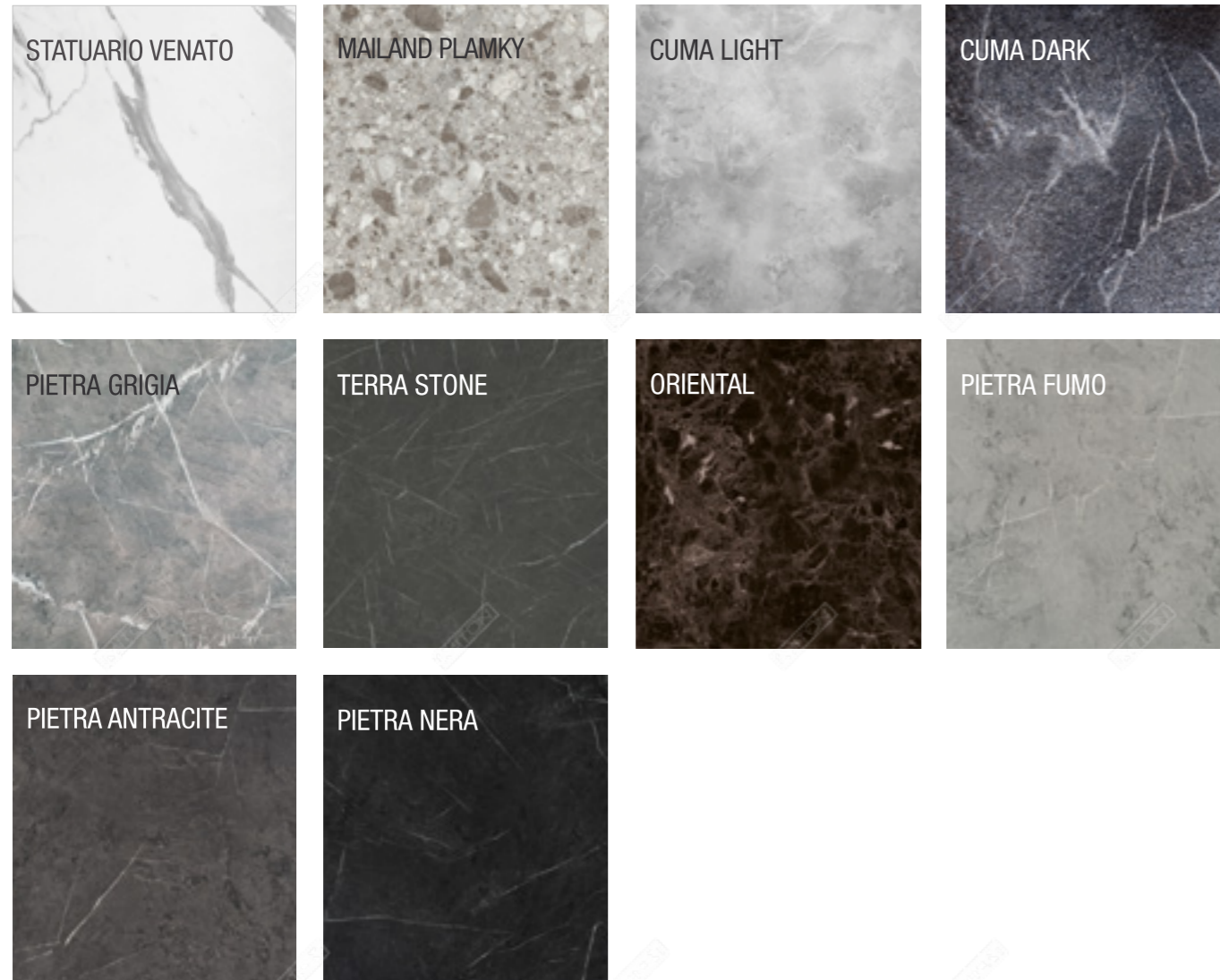

QUARZO SANTAMARGHERITA / QUARTZ
GRANIGLIE SANTAMARGHERITA

SP./TH. 20/40/60/80MM

WORKTOP

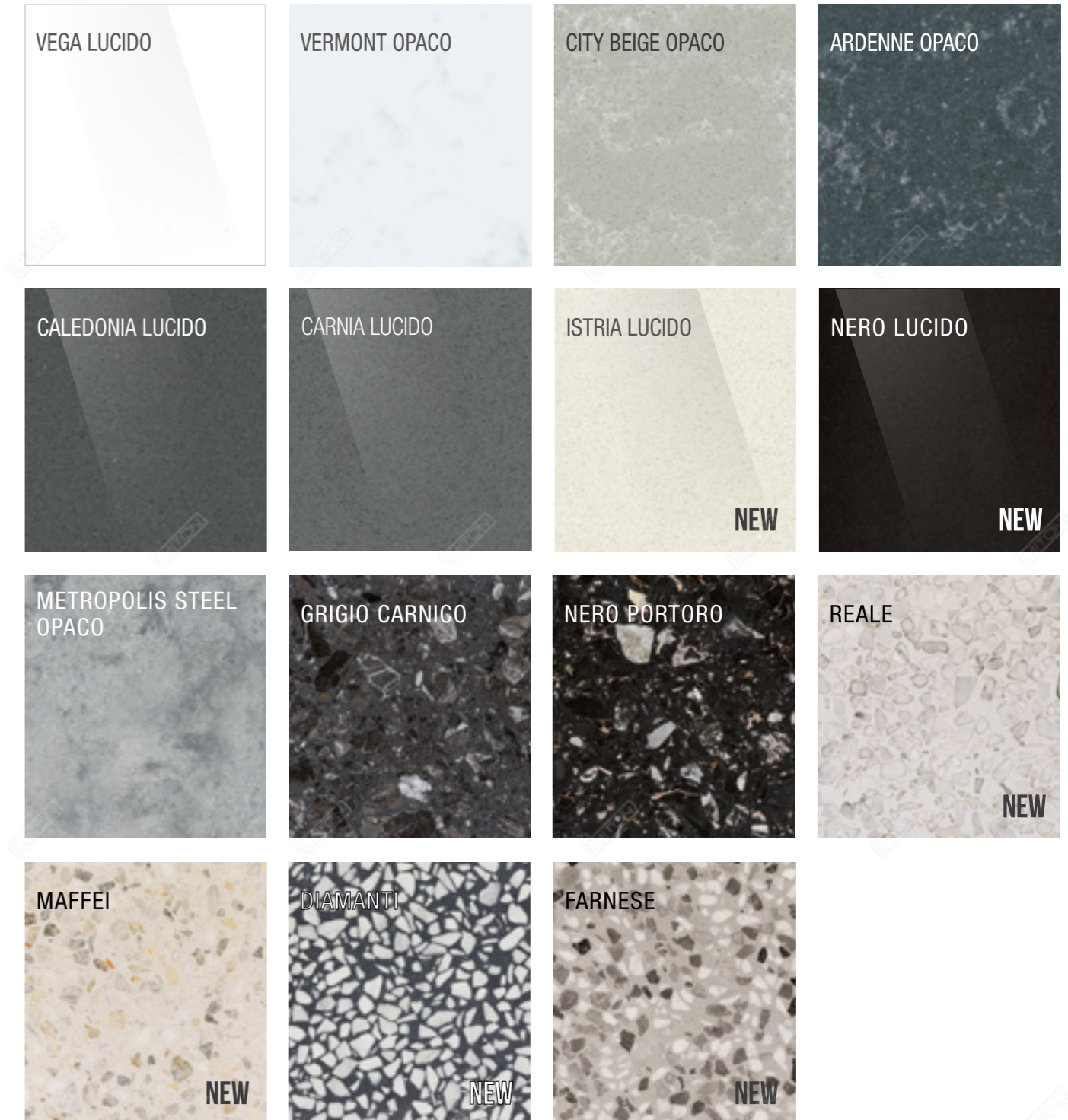

GRES FASCIA 1 / GRES BAND 1

SP./TH. 12/40/60/80 MM

WORKTOP



GRES FASCIA 1 / GRES BAND 1

SP./TH. 12/40/60/80 MM

WORKTOP

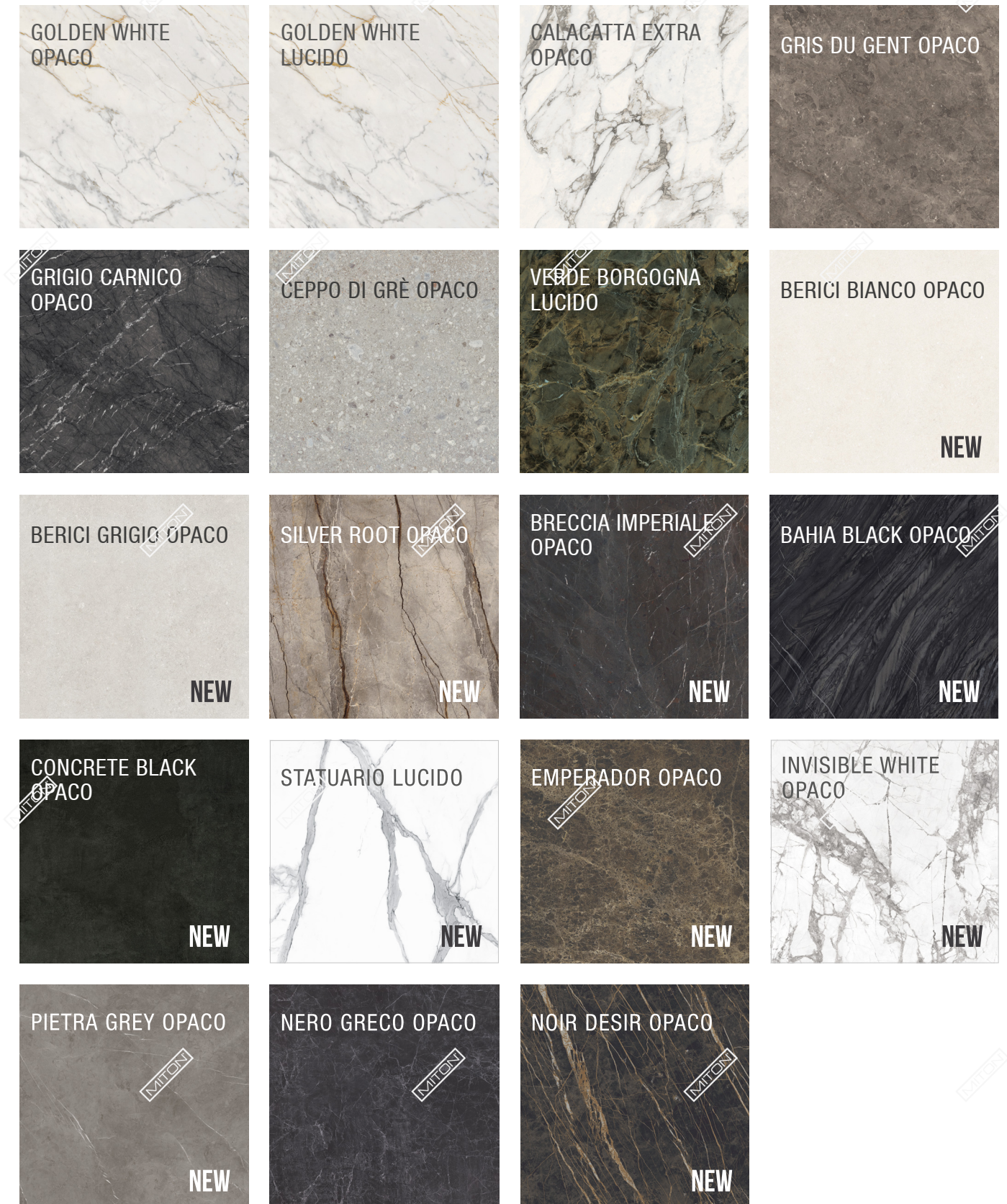

GRES FASCIA LUXURY / LUXURY GRES

SP./TH. 12/40/60/80 MM

WORKTOP

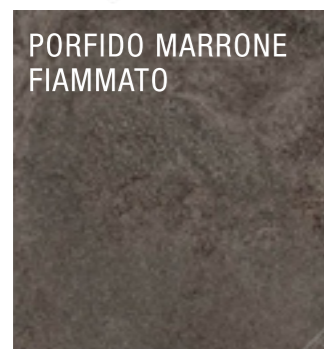
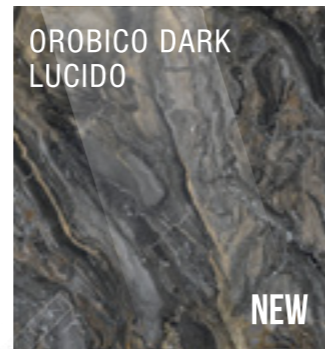
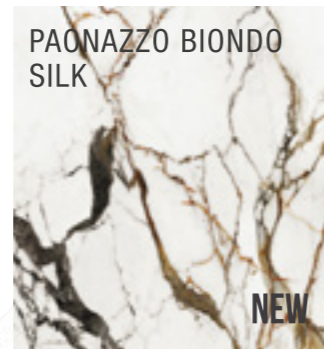
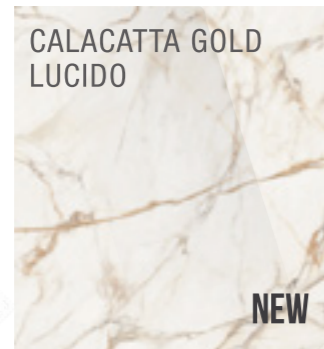
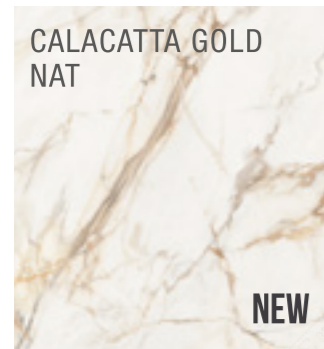

PIETRA NATURALE / NATURAL STONE

SP./TH. 20/40/60/80 MM

WORKTOP

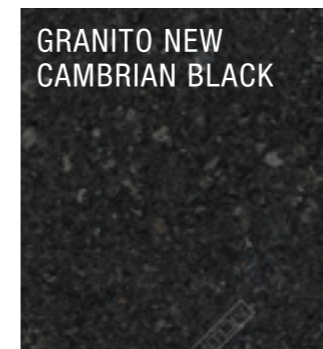
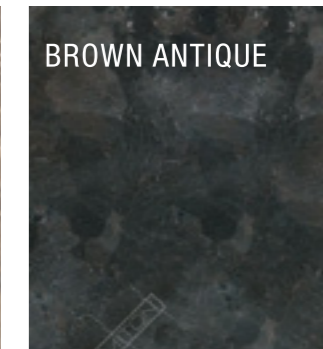
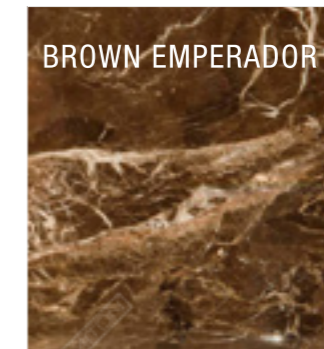
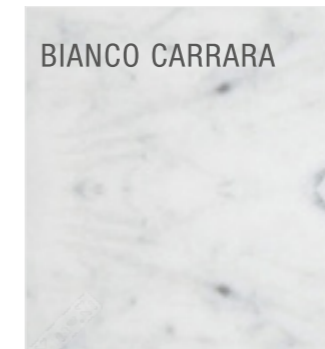



The mark of
responsible forestry
FSC® C136914

Prodotti certificati FSC® disponibili su richiesta



ART DIRECTOR, RICERCA E SVILUPPO CUBO DESIGN
PHOTOGRAPHY, MATIC ANIMATION
COLOUR SEPARATION, MATIC ANIMATION
GRAPHIC DESIGN, RICERCA E SVILUPPO CUBO DESIGN

RENDER, MATIC ANIMATION (MÉNTA - MÉDEA)
RENDER, BIEFFE RENDERING (MÉNTA_NOCE CORDESCO E VERDE POLVERE - ANUBA - TALÌA)

CUBO DESIGN S.R.L.

LOCALITÀ CASE SCIARRONI - GRASCIANO
I-64024 NOTARESCO - TERAMO (TE) - ITALY
INFO@CUBODESIGN.IT

CUBO DESIGN S.R.L. NEL PERSEGUIRE UNA POLITICA VOLTA AL COSTANTE MIGLIORAMENTO, SI RISERVA IL DIRITTO DI APPORTARE, IN QUALSIASI MOMENTO E SENZA PREAVVISO, LE MODIFICHE AI PRODOTTI CHE RITERRÀ UTILI E NECESSARIE / **IN ORDER TO CONSTANTLY IMPROVE ITS PRODUCTS, CUBO DESIGN S.R.L. RESERVES THE RIGHT TO MODIFY ITS PRODUCTS AS IT SEES FIT, WITHOUT PRIOR NOTIFICATION.**

L'EFFETTIVA DISPONIBILITÀ DI QUANTO A CATALOGO DEVE ESSERE EFFETTIVAMENTE VERIFICATA AL MOMENTO DELL'ORDINE / **THE EFFECTIVE AVAILABILITY OF THE ARTICLES IN THE CATALOGUE, MUST BE ACTUALLY CHECKED OUT AT THE TIME OF THE ORDER.**

A CAUSA DI NATURALI LIMITI TECNICI DI RIPRODUZIONE E STAMPA, IL COLORE DEI MODELLI A CATALOGO È PURAMENTE INDICATIVO E NON PUÒ COSTITUIRE MOTIVO DI RIVALSA / **BECAUSE OF NATURAL TECHNICAL LIMITS OF THE METHOD OF REPRODUCTION AND PRINTING, THE COLOUR OF THE MODELS IN THE CATALOGUE IS PURELY INDICATIVE AND CANNOT BE CLAIMED AS REASON FOR COMPENSATION AND LEGAL ACTION.**

CUBO DESIGN S.R.L. DECLINA OGNI RESPONSABILITÀ PER DIFETTI E MALFUNZIONAMENTI DI ELETTRODOMESTICI ED APPARECCHIATURE: EVENTUALI CONTESTAZIONI DOVRANNO ESSERE RIVOLTE DIRETTAMENTE AL PRODUTTORE ED AI LORO CENTRI DI ASSISTENZA / **CUBO DESIGN S.R.L. EVERY LIABILITY FOR DEFECTS AND MALFUNCTIONING OF APPLIANCES AND PIECES OF EQUIPMENT: EVENTUAL CLAIMS WILL HAVE TO BE ADDRESSED DIRECTLY TO THE PRODUCERS AND THEIR ASSISTANCE CENTRES.**