

GRUPPI LETTI

Suites and beds
2025

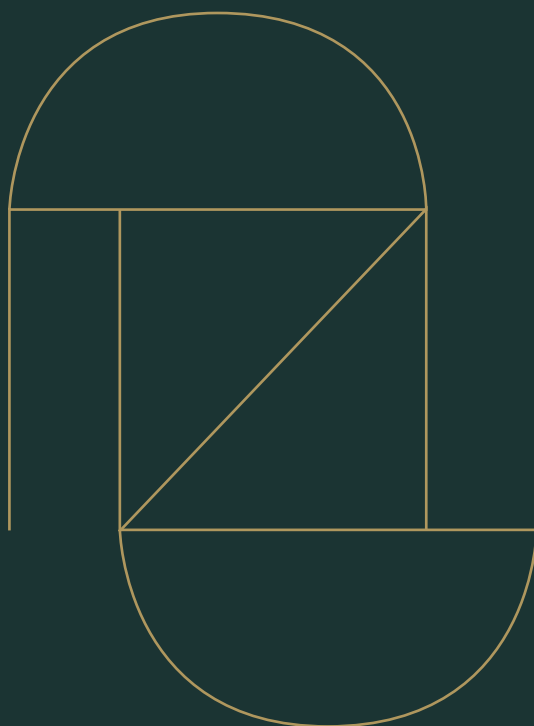

MARONESE ACF[®]

GRUPPI — LETTI

Suites and beds

MARONESE ACF®

LETTI

Beds



AIDA p. 56



ALBY p. 08



CITY p. 238



DEO p. 226



ESTER p. 210



FLASH p. 130



GINGER p. 38
GINGER IMBOTTITO p. 40



HENRY p. 26



LENA p. 158



LOLA p. 194



LOVE p. 72



OLIVER p. 94



SCUDO p. 142
SCUDO IMBOTTITO p. 144



SKY p. 110
SKY IMBOTTITO p. 126



SLIDE p. 184

SISTEMI

Systems



SISTEMA SETA p. 248



SISTEMA BUMPY p. 254



VELA p. 172



VIKI p. 82



SOMMIER p. 248



CLOUD p. 254

GRUPPI

Suites



BETA p. 212 - 301



BOLD p. 166 - 178 - 302



BRIO p. 160 - 220 - 303



CAPRI p. 28 - 48 - 74 - 304



CITY p. 240 - 305



CROSS p. 186 - 306



EDEN p. 70 - 96 - 307



GARDENIA p. 200 - 308



GRIP p. 234 - 309



**JAZZ
JAZZ PLUS** p. 120
p. 58 - 196 - 272 - 310



LIGHT p. 10 - 34 - 248
274 - 311



MONO p. 16 - 52 - 78 - 312



OSLO p. 20 - 228 - 313

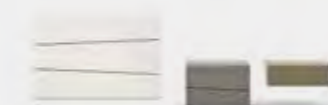

SCUDERIA p. 150 - 190 - 314



SETA p. 132 - 260 - 266 - 315



STREET p. 64 - 138 - 206
316



UNIX p. 15 - 112 - 126 - 144 - 254
278 - 284 - 317



WAY p. 90 - 174 - 318



45° p. 40 - 84 - 104 - 319

TAVOLINI

Coffee tables



CAPITOL p. 138 - 182 - 243



EVEN p. 10 - 96 - 225
232 - 273



NEMO p. 64



NIKO

GRUPPI — LETTI

Attraverso armonie e contrasti tra linee, materiali e finiture, MARONESE ACF® interpreta l'evoluzione della tradizione italiana dell'abitare.

Letti, gruppi e complementi sono espressioni di ricerca funzionale e cultura estetica e danno forma ad ambienti notte sempre coordinati e accoglienti.

Suites & beds

Thanks to harmonious or contrasting shapes, materials and finishes, MARONESE ACF® interprets the evolution of the Italian way of life. Beds, suites and accessories embrace the latest research into functionality and aesthetic culture to give rise to matching and welcoming bedroom settings.

008	LETTI Beds
246	SISTEMI Systems
300	GRUPPI Suites
320	COMPLEMENTI Complements
328	MOOD & INSPIRATIONS Mood & Inspirations
340	FINITURE Finishes
348	CARTE DA PARATI Wallpapers

Alby

Letto - Bed

Confortevole letto tessile
dall'alta testiera imbottita.
La falda laterale è impreziosita
da una raffinata lavorazione
con cuciture sartoriali.
Abbinabile a più giroletti,
anche con base contenitore.

Comfortable fabric bed with upholstered headboard.
The side flap is embellished with sophisticated workmanship and tailored seams.
Designed to match several bed frames, including with storage.

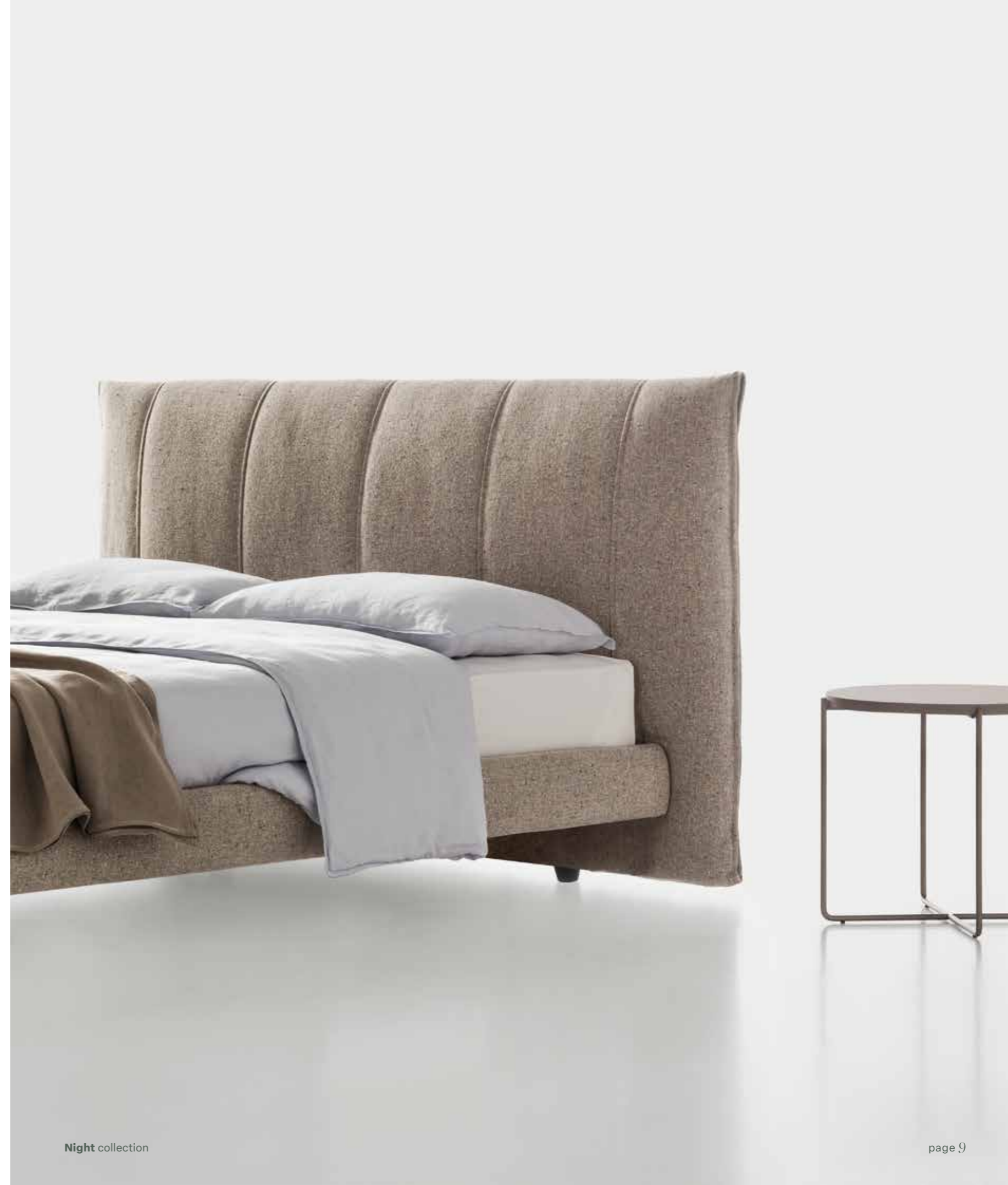

Night collection

Letto **Alby** in tessuto
Ripley 10 con piedini in
Manganese -
Gruppo Light con
frontale millerighe
laccato opaco Bronzo

Alby bed in Ripley 10
fabric with Manganese
feet - Light suite with
Bronzo matt lacquered
millerighe front



Il gruppo Light si caratterizza per il capiente vano a giorno illuminato.
Il frontale del cassetto è personalizzabile in tante finiture differenti:
qui è proposto con il pregevole effetto millerighe laccato Bronzo.

The Light suite stands out for its generously sized lit open compartment.
The drawer front can be customised in multiple different finishes:
here, it is shown with the prized Bronzo lacquered Millerighe effect.



Composizioni versatili ad alta funzionalità

La base sospesa del gruppo Unix è incastonata tra i due specchi a parete: una composizione che disegna una perfetta postazione make up, per organizzare i quotidiani rituali di cura della persona.

Versatile and highly functional compositions

The wall-mounted base unit of the Unix suite is nestled between two wall mirrors: a composition that creates the perfect make-up station, for a seamless daily beauty ritual.



Night collection

Letto **Alby** in tessuto Elettra 11 - Gruppo Mono basamento "R" in Rovere Nordico e gambe in Manganese

Alby bed in Elettra 11 fabric - Mono suite with "R" base in Nordico oak and Manganese legs





Night collection

Letto **Alby** in tessuto Amsterdam 105 e piedini in Manganese - Gruppo Oslo in melaminico Cashmere e top in laccato opaco Cotto

Alby bed in Amsterdam 105 fabric and Manganese feet - Oslo suite in Cashmere melamine and top in Cotto matt lacquer



Il giroletto sospeso bilancia l'ampio volume della testiera del letto Alby.

The floating bed frame balances the generous volume of the Alby bed headboard.



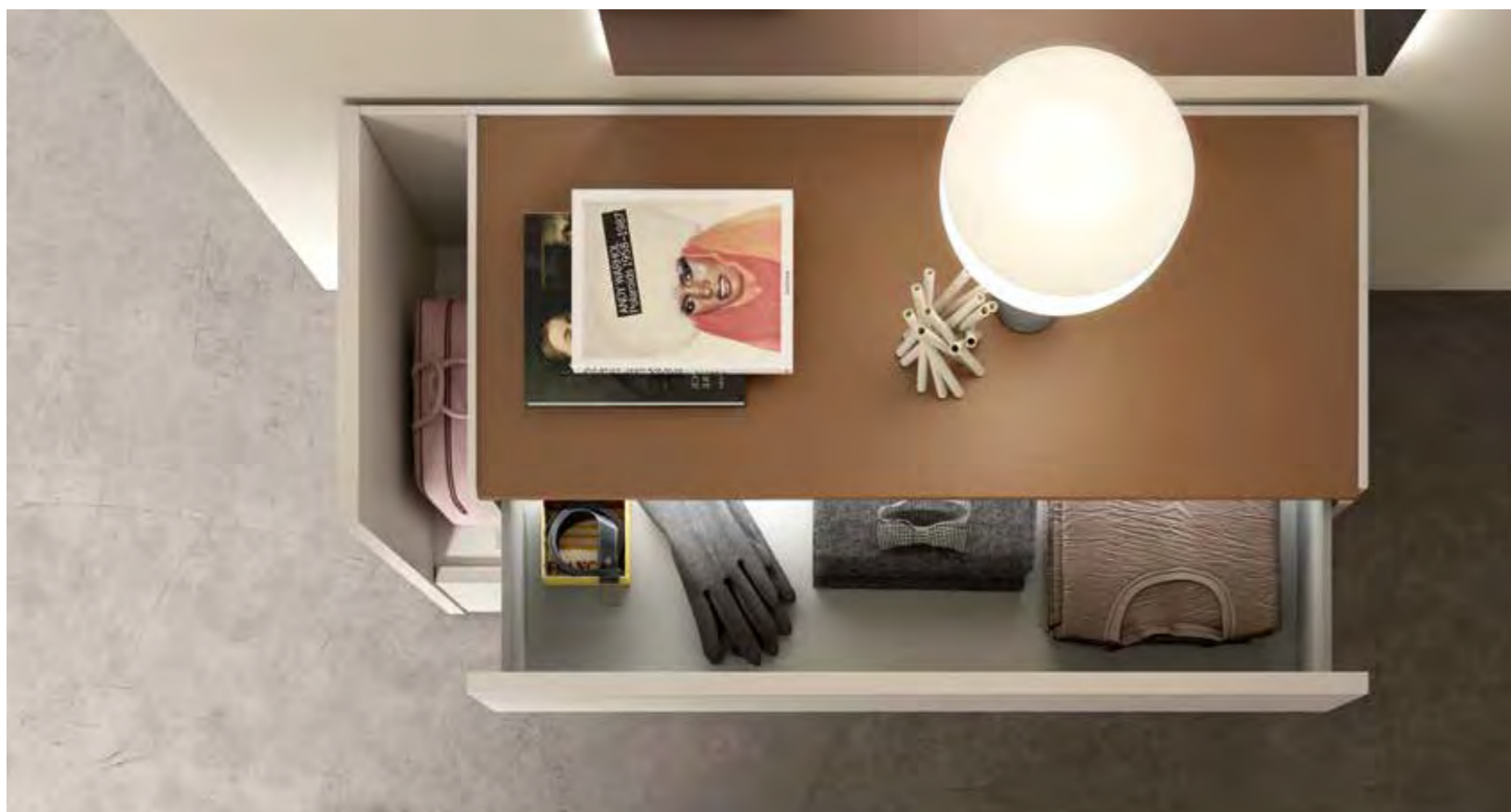

Il cassetto è illuminato

Il gruppo Oslo offre la possibilità di avere cassetti illuminati. Il top in laccato Cotto trova armonia con la tonalità Cashmere della scocca.

The drawer has a light

The Oslo suite can be fitted with illuminated drawers. The Cotto lacquered top blends harmoniously with the Cashmere hue of the body.



Henry

Letto - Bed

L'avvolgente testiera del letto Henry è interamente rivestita in tessuto o ecopelle, coordinandosi al giroletto. Gli originali piedini, sottili eppure solidissimi, conferiscono leggerezza al design.

The enveloping headboard of the Henry bed is entirely covered with fabric or eco-leather, to match the bed frame. The original, slim yet extremely sturdy feet lend lightness to the design.



Night collection

Letto **Henry** in tessuto
Sogno 500 con piedini
in Manganese -
Gruppo Capri laccato
opaco Terra e top in
Nocciola

Henry bed in Sogno 500
fabric with Manganese
feet - Capri suite in
Terra matt lacquer and
top in Nocciola



Capri è il gruppo d'ispirazione retrò, con angoli arrotondati e forme sinuose per un design sobrio e di classe.

Capri is a retro-inspired suite, featuring rounded corners and sinuous shapes, for an understated yet classy design.





Night collection

Letto **Henry** in tessuto
Elettra 05 -
Gruppo **Light** in
laccato opaco
Castagno e pressato
impiallacciato Cacao

Henry bed in Elettra 05
fabric - Light suite in
Castagno matt lacquer
and pressed Cacao
veneered





Comfort in ogni spazio

Il comodino Light è disponibile in più dimensioni: la versione alta e stretta sa inserirsi anche in ambienti con misure ridotte, senza rinunciare a eleganza e capienza.

Comfort in every space

The Light bedside cabinet is available in a variety of sizes: the tall and narrow version is also ideal for compact settings, without forgoing elegance and storage space.



Ginger

Letto - Bed

Giocando con accostamenti tra volumi asimmetrici, profondità diverse e materiali coordinati o a contrasto, Ginger moltiplica le possibilità di personalizzazione ed esalta la tridimensionalità della testiera. Abbinabile a più giroletti, anche con base contenitore.

Disponibile anche nella versione Ginger imbottito
Also available in the upholstered version

By playing with combinations of asymmetrical volumes, different depths and matching or contrasting materials, Ginger extends the customisation possibilities and brings out the dimensional appeal of the headboard. Designed to match several bed frames, including with storage.



Ginger imbottito

Night collection

Letto **Ginger imbottito**
in tessuto Elettra 05
e testiera in tessuto
Amsterdam 64 -
Gruppo 45° in laccato
opaco Taupe e top in
Rovere Nordico

Ginger bed in Elettra 05
fabric and headboard in
Amsterdam 64 fabric -
45° suite in Taupe matt
lacquer and top in
Nordico oak



La morbida testiera è dotata di LED perimetrale,
per offrire una scenografica luce di cortesia.

The soft headboard is fitted with a perimeter
LED to offer a scenic courtesy light.





Un contenitore che alleggerisce il design
Il giroletto è fornito anche con il contenitore rientrante, rivestito in tessuto o in finiture melaminiche.

A storage unit that lightens up the design
The bed frame is also supplied with a recessed storage unit, covered in fabric or melamine finishes.

Dettagli di design

La scocca è leggermente rialzata rispetto al top, così da disegnare una comoda presa per il cassetto superiore. L'apertura laterale degli altri cassetti è invece definita attraverso un taglio verticale che caratterizza i comò e comodini del Gruppo 45°.

Designer details

The body is raised slightly higher than the top, creating a convenient grip for the top drawer. The side opening of the other drawers is instead made possible by a vertical cut which distinguishes the dressers and bedside cabinets in the 45° suite.



Ginger

Night collection

Letto **Ginger** in Rovere Nordico e testiera in tessuto Sogno 904 - Gruppo Capri in Rovere Nordico e top in laccato opaco Magma

Ginger bed in Nordico oak and headboard in Sogno 904 fabric - Capri suite in Nordico oak and top in Magma matt lacquer





Massima possibilità di personalizzazione
Scocca e top del Gruppo Capri sono componibili anche in finiture e colori diversi.

Maximum customisation possibilities
The body and the top of the Capri suite are modular and come in different finishes and colours.

Night collection

Letto **Ginger** in Rovere
Thea con inserto
millerighe laccato opaco
Sabbia e tessuto Flirt
Grigio Lino -
Gruppo Mono
basamento "R" e "S" in
Metal bronzo opaco

Ginger bed in Thea
oak with Sabbia matt
lacquered millerighe
insert and Flirt Grigio
Lino fabric - Mono suite
with "R" e "S" base in
matt bronze Metal





Aida

Letto - Bed

La testiera di Aida è caratterizzata dal morbido cuscino a inserto, personalizzabile in tutti i tessuti e le ecopelli. Abbinabile a più giroletti, anche con base contenitore.

The Aida headboard is distinguished by a soft cushion insert, which can be customised in all fabrics and eco-leathers. Designed to match several bed frames, including with storage.



Night collection

Letto **Aida** in
impiallacciato Nocciola
e testiera in tessuto
Elettra 12 -
Gruppo Jazz Plus in
melaminico Sabbia e in
pressato Nocciola

Aida bed in veneered
Nocciola and headboard
in Elettra 12 fabric -
Jazz Plus suite in Sabbia
melamine and Nocciola
pressed



Il primo cassetto del gruppo Jazz Plus è personalizzato in finitura Pressato, per dialogare con l'elegante boiserie Seta.

The top drawer of the Jazz Plus suite is customised in a pressed finish, to liaise with the elegant Seta wood panelling.





Night collection

Letto **Aida** in Rovere
Thea e testiera in
Eco-pelle Tortora -
Gruppo Street in Rovere
Thea e profilo laccato
opaco Ottone

Aida bed in Thea oak
and headboard in
Tortora eco-leather -
Street suite in Thea oak
and profile in Ottone
matt lacquer

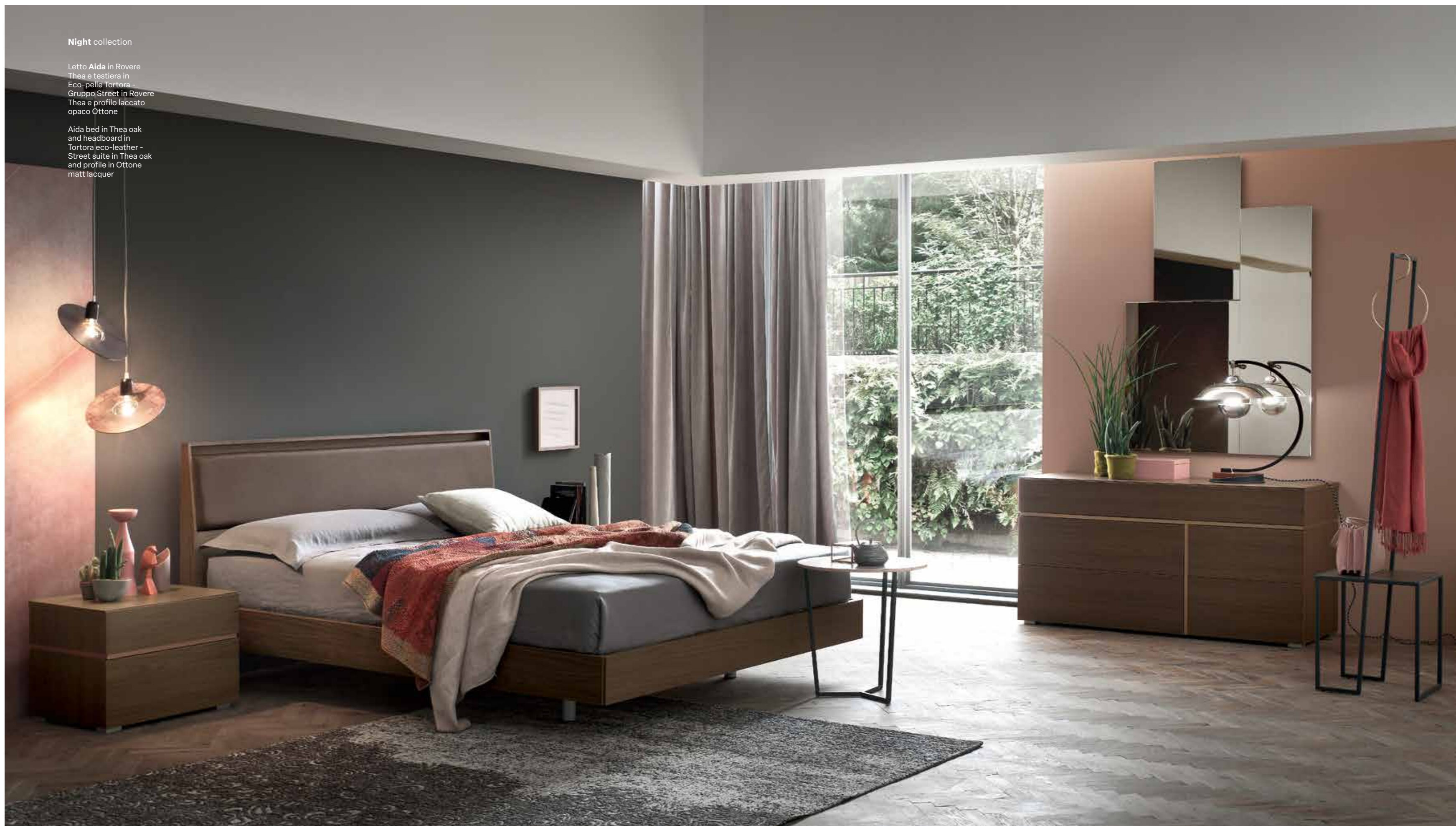



Comodino Street in diverse misure

La linea Street è disponibile in diverse dimensioni per inserirsi in ogni spazio domestico.

Street bedside cabinet in several sizes

The Street line is available in different sizes to blend in with any domestic setting.

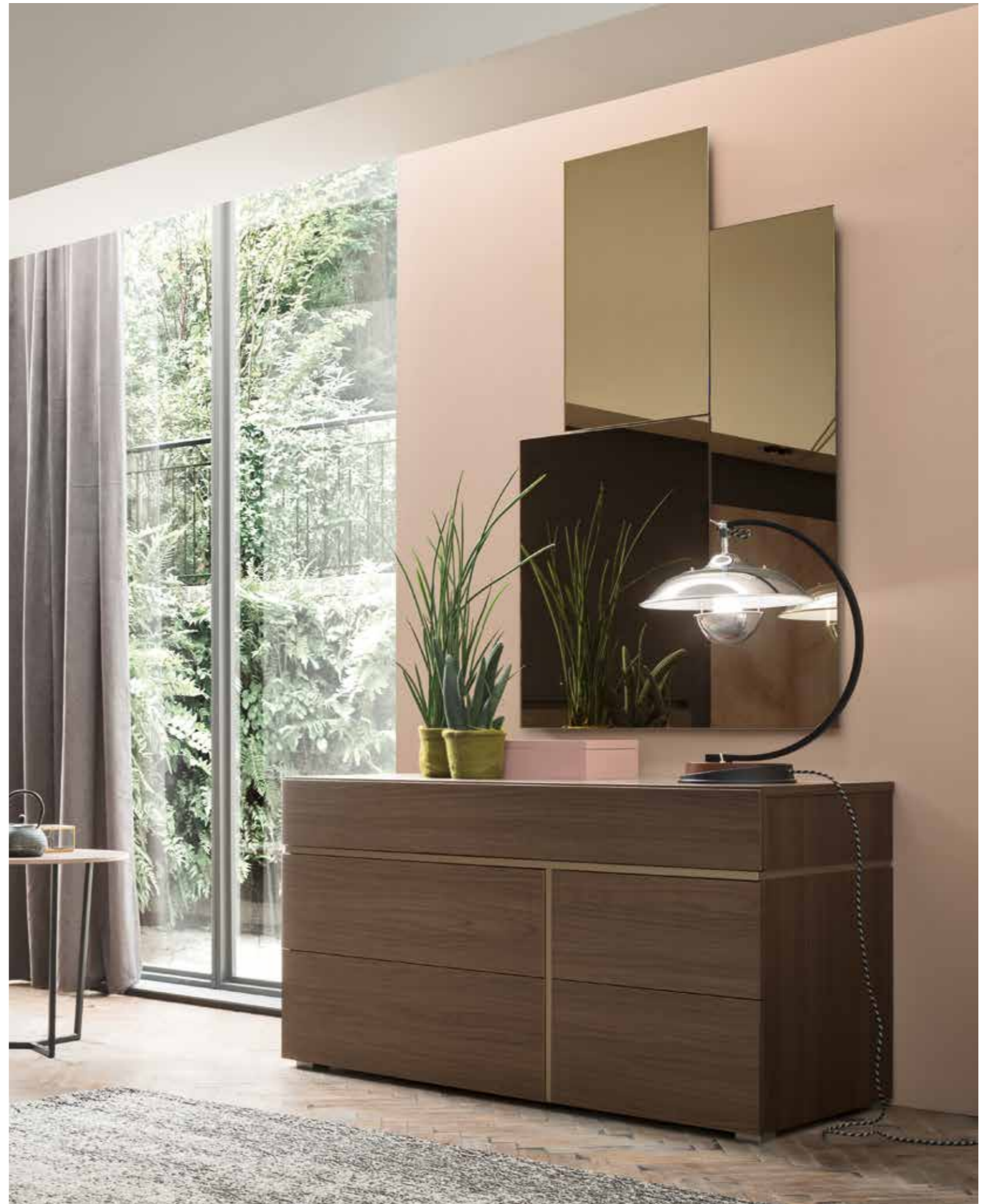

Night collection

Letto **Aida** in laccato opaco Sabbia e testiera in Eco-pelle Tortora
Gruppo **Eden** in laccato opaco Sabbia e top in Marmo Calacatta

Aida bed in Sabbia matt lacquer and headboard in Tortora eco-leather
Eden suite in Sabbia matt lacquer and top in Calacatta Marble



Love

Letto - Bed

La testiera è formata da due ampi cuscini divergenti, che insieme evocano la forma di un cuore. Love si abbina a diversi giroletti, anche con contenitore.

Disponibile nella versione sospeso o a terra
Available in the floating or floor-standing version

The headboard consists of two large, diverging cushions, which together suggest the shape of a heart.
Love matches several bed frames, including with storage.

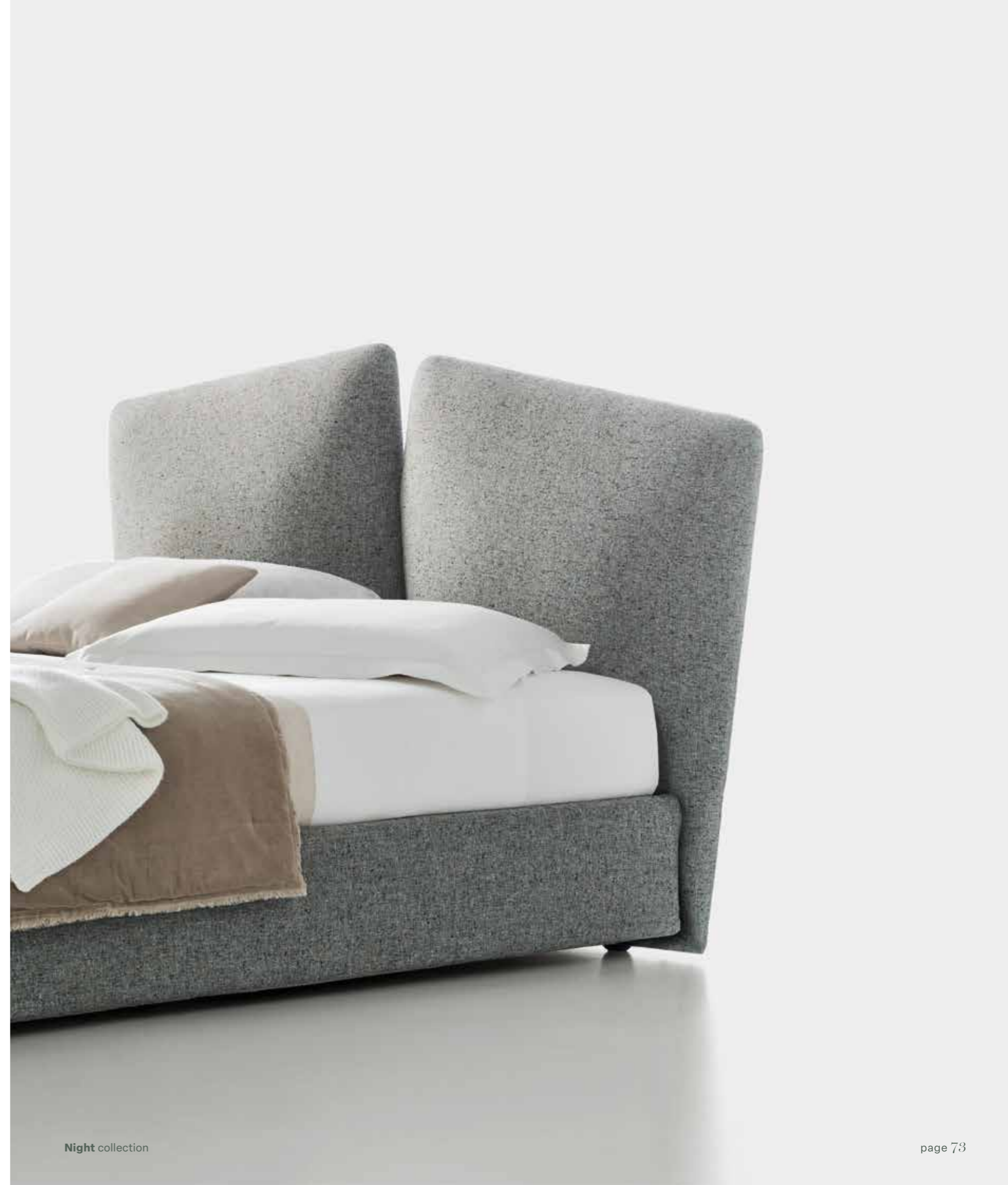

Night collection

Letto **Love** in
Tessuto Replay 19 -
Gruppo Capri in
Olmo Tabacco e top
in Gres Onice grigio

Love bed in Replay
19 fabric - Capri suite
in Tabacco elm and
Grey Onice top gres



La bordatura della scocca offre un'agevole presa al cassetto superiore e incastona il piano a vassoio, qui presentato in finitura gres Onice Giada.

The edge of the body provides a convenient grip for the top drawer and is embedded with the tray top, shown here in the Onice Giada stoneware finish.

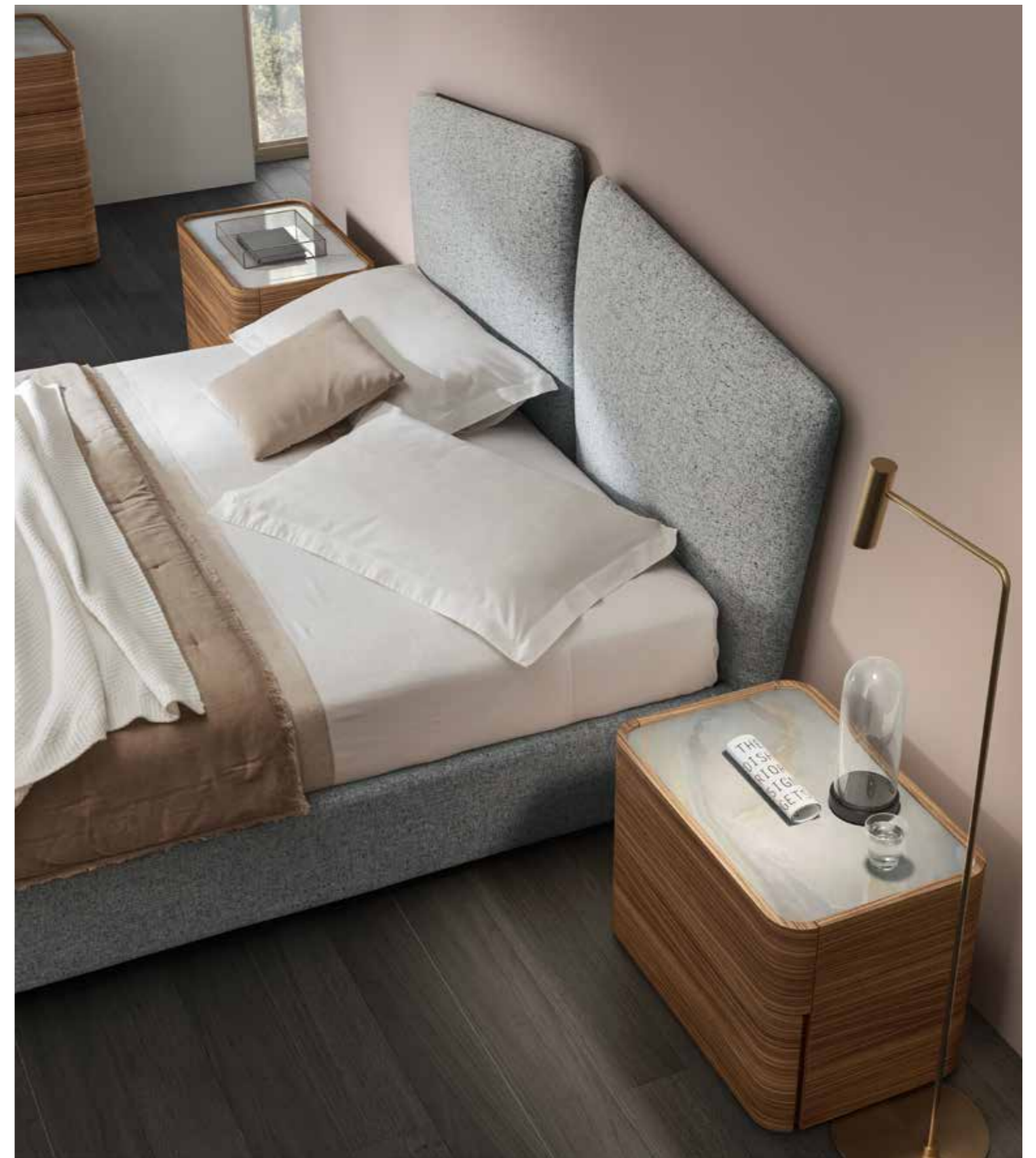

Night collection

Letto **Love** in tessuto
Rally 602 e Olmo
Tabacco -
Gruppo Mono in
Olmo Tabacco con
maniglia B100

Love bed in Rally 602
fabric and Tabacco
elm - Mono suite in
Tabacco elm with
B100 handle





Viki

Letto - Bed

Letto con testiera in forte spessore, che si assottiglia nella parte superiore con una linea curva che ne slancia la figura. Disponibile anche in tutti i colori laccati opachi.

Bed with extra thick headboard, which tapers at the top with a curved line that elongates its shape. Also available in all matt lacquered colours.



Night collection

Letto Viki in
Impiallacciato Miele -
Gruppo 45° in laccato
lucido Ghiaccio e top
Impiallacciato Miele

Viki bed in Miele
Veneered - 45° suite in
Ghiaccio glossy lacquer
and top Miele Veneered







Il comodino del Gruppo 45° è personalizzabile con vano giorno oppure con cassetto.

The bedside cabinet in the 45° Suite can be customised with an open compartment or with a drawer.



Night collection

Letto **Viki** in frassino Bianco Gruppo Way in frassino laccato Cipria

Viki bed in Bianco ash Way suite in Cipria lacquered ash





Comò, comodini e settimanali del Gruppo Way sono personalizzabili in una grande varietà di finiture: laccati opachi e lucidi, Frassino colore o con le eleganti venature del legno.

The dressers, bedside cabinets and chests of drawers in the Way suite can be customised in a wide variety of finishes: glossy and matt lacquers, coloured ash wood or with elegant wood grain.



Oliver

Letto - Bed

La testiera è imbottita con motivo trapuntato e retrofinita, per un'eventuale collocazione discostata dalla parete. Il giroletto a terra è in rivestimento coordinato.

The headboard is upholstered with a quilted pattern and is also finished on the back, making it also ideal for free-standing installation. The floor-standing bed frame features matching upholstery.



Night collection

Letto **Oliver** in
Amsterdam 64 -
Gruppo **Eden** con
comò in Olmo Tabacco
e comodini in laccato
opaco Taupe

Oliver bed in
Amsterdam 64 -
Eden suite with dresser
in Tabacco elm and
bedside cabinets in
Taupe matt lacquer





Il fronte del giroletto richiama la medesima trama trapuntata dello schienale.
Oliver è disponibile anche con l'ampio vano contenitore.

The front of the bed frame is reminiscent of the same quilted pattern as the
backrest. Oliver is also available with a generously sized storage compartment.



La gola laterale permette l'apertura dei capienti cassetti del comò.
In questo esempio, top e scocca si accordano in finitura Olmo Tabacco.

The side groove allows you to open the roomy dresser drawers.
In this example, the top and body match in Tabacco Elm finish.



Night collection

Letto **Oliver** in tessuto
Amsterdam 64 -
Gruppo 45° in
Rovere Nordico, top in
laccato castagno

Oliver bed in
Amsterdam 64 fabric -
45° suite in Nordico oak,
castagno lacquered top





Meccanismo lombare

Un esclusivo sistema brevettato permette di reclinare facilmente gli schienali e di abbassare i braccioli, per una postura più confortevole.

Lower back mechanism

An exclusive patented system makes reclining the backrests and lowering the armrests, for a more comfortable posture.



Il perimetro superiore della scocca è leggermente più alto del top, definendo così un comodo piano a vassoio e offrendo al contempo una presa per l'apertura del primo cassetto.

The upper perimeter of the body is slightly higher than the top, and thus shapes a convenient grip to open the top drawer.

Sky

Letto - Bed

Piani geometrici e forme essenziali definiscono il design del letto Sky. Il pannello testiera in forte spessore può essere personalizzato in più configurazioni, con cuscini e inserti applicabili allo schienale.

Disponibile anche nella versione Sky imbottito
Also available in the upholstered version

Geometric planes and understated shapes define the design of the Sky bed. The extra thick headboard panel can be customised in a variety of configurations, with cushions and inserts applicable to the backrest.

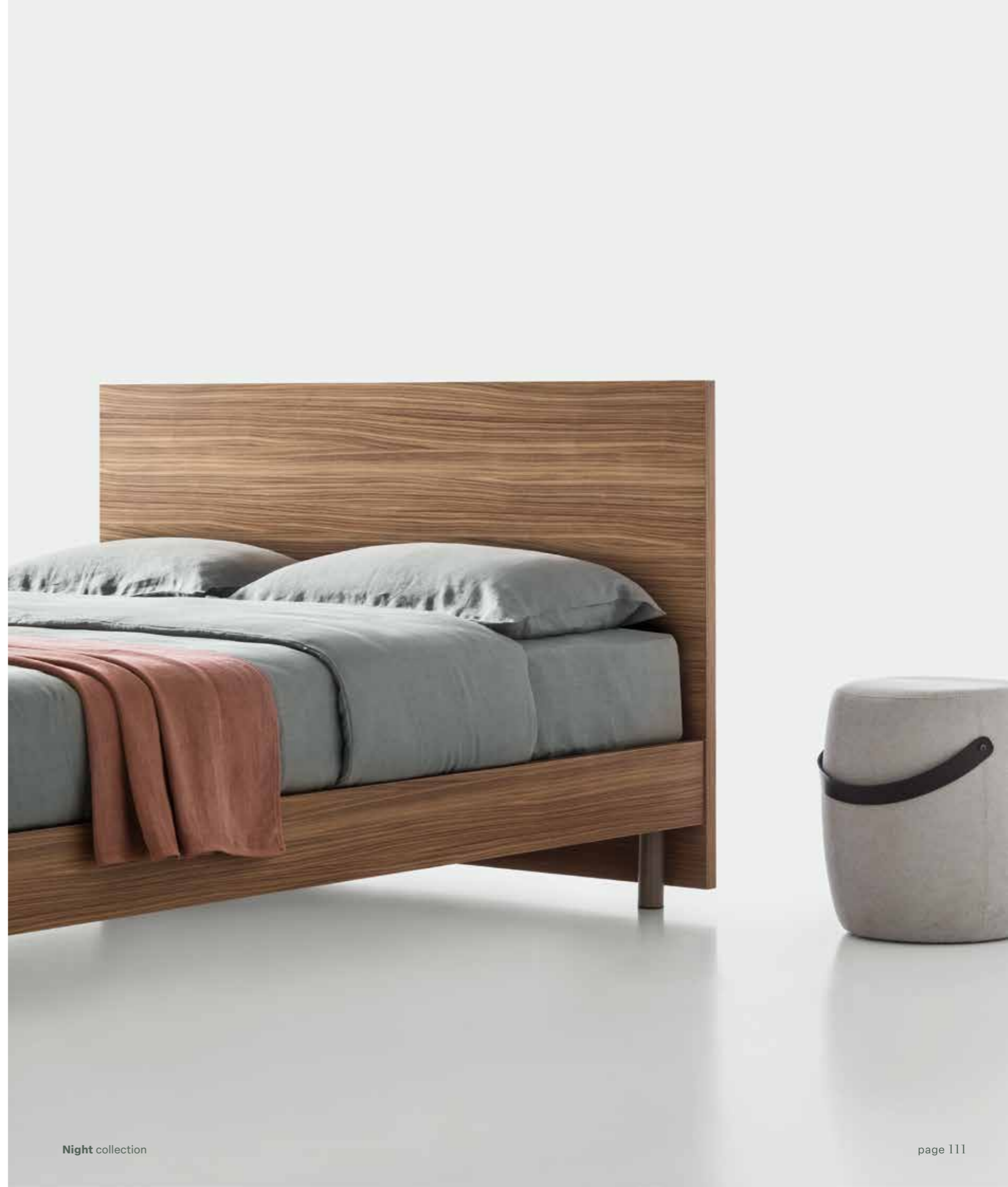

Night collection

Letto **Sky** in Olmo
Tabacco con cuscino
capitoné in tessuto
Elettra 15 - Gruppo Unix
in melaminico Sabbia e
gambe in Manganese

Sky bed in Tabacco elm
with capitonné cushion
in Elettra 15 fabric -
Unix suite in Sabbia
melamine and
Manganese legs





L'opzione dei pannelli laterali è studiata per accrescere l'impatto scenico del letto Sky. La base contenitore rientrante soddisfa esigenze funzionali ed equilibrio estetico.

The optional side panels have been devised to enhance the scenic impact of the Sky bed. The recessed storage unit meets functional requirements while striking an aesthetic balance.

Personalizzazione della testiera

La testiera del letto Sky è componibile in più configurazioni, per interpretare stili ed esigenze differenti.

Headboard customisation

The headboard of the Sky bed is modular, offering multiple configurations to accommodate a variety of styles and requirements.



Testiera liscia

Smooth headboard

Esalta la matericità della finitura e la geometria delle forme, per un design ultra essenziale.

Enhancing the texture of the finish and the geometric shapes, for an ultra sleek design.



Testiera con cuscini

Headboard with cushions

Due grandi cuscini imbottiti applicati direttamente alla testiera offrono ancora più comfort.

Two large upholstered cushions applied directly onto the headboard provide even more comfort.



Testiera con pannello in tessuto

Headboard with fabric panel

L'inserto orizzontale lungo tutto la testiera è personalizzabile in tutti i tessuti ed ecopelli.

The long horizontal insert stretching all along the headboard can be customised in all fabrics and eco-leathers.



Testiera con pannello in capitonné

Headboard with tufted panel

Allure classica ed estrema comodità, grazie all'inserto con la raffinata lavorazione capitonné.

A classic look combined with extreme comfort, thanks to the insert featuring sophisticated tufted upholstery.



Night collection

Letto **Sky** in laccato opaco Verde Palude e testiera in Eco-pelle gold 01 - Gruppo Jazz in Olmo Artico e inserto maniglia in laccato opaco Verde Palude

Sky bed in Verde Palude matt lacquer and headboard in gold 01 eco-leather - Jazz suite in Artico elm and handle insert in Verde Palude matt lacquer





Gli inserti a contrasto dei comodini Jazz si combinano con il laccato opaco di giroletto e testiera.

The contrasting inserts of the Jazz bedside cabinets match the matt lacquered bed frame and headboard.



Tra le varie configurazioni del gruppo Jazz, anche il solo tassello interno può essere personalizzato con tonalità a contrasto.

Among the various configurations of the Jazz suite, even just the inner tile can be customised in a contrasting colour.



Sky imbottito

Night collection

Letto Sky in tessuto Lino Planet 504 - Gruppo Unix in laccato opaco Verde Palude e Cotto

Sky bed in Lino Planet 504 fabric - Unix suite in Verde Palude and Cotto matt lacquer

I contenitori del Sistema Unix possono essere disposti in linea o sfalsati per creare nuove e personali geometrie.

The Unix System storage units can be aligned or staggered to create new, custom geometries.



Flash

Letto - Bed

Un letto iconico, grazie al decoro pantografato che scorre lungo la testata e ai pannelli opzionali laterali che accolgono il comodino. Tra i giroletti disponibili, anche quello a terra con contenitore.

An iconic bed, with a moulded decoration running along the headboard and optional side panels to accommodate the bedside cabinet. The bed frames available also include the floor-standing option with storage.

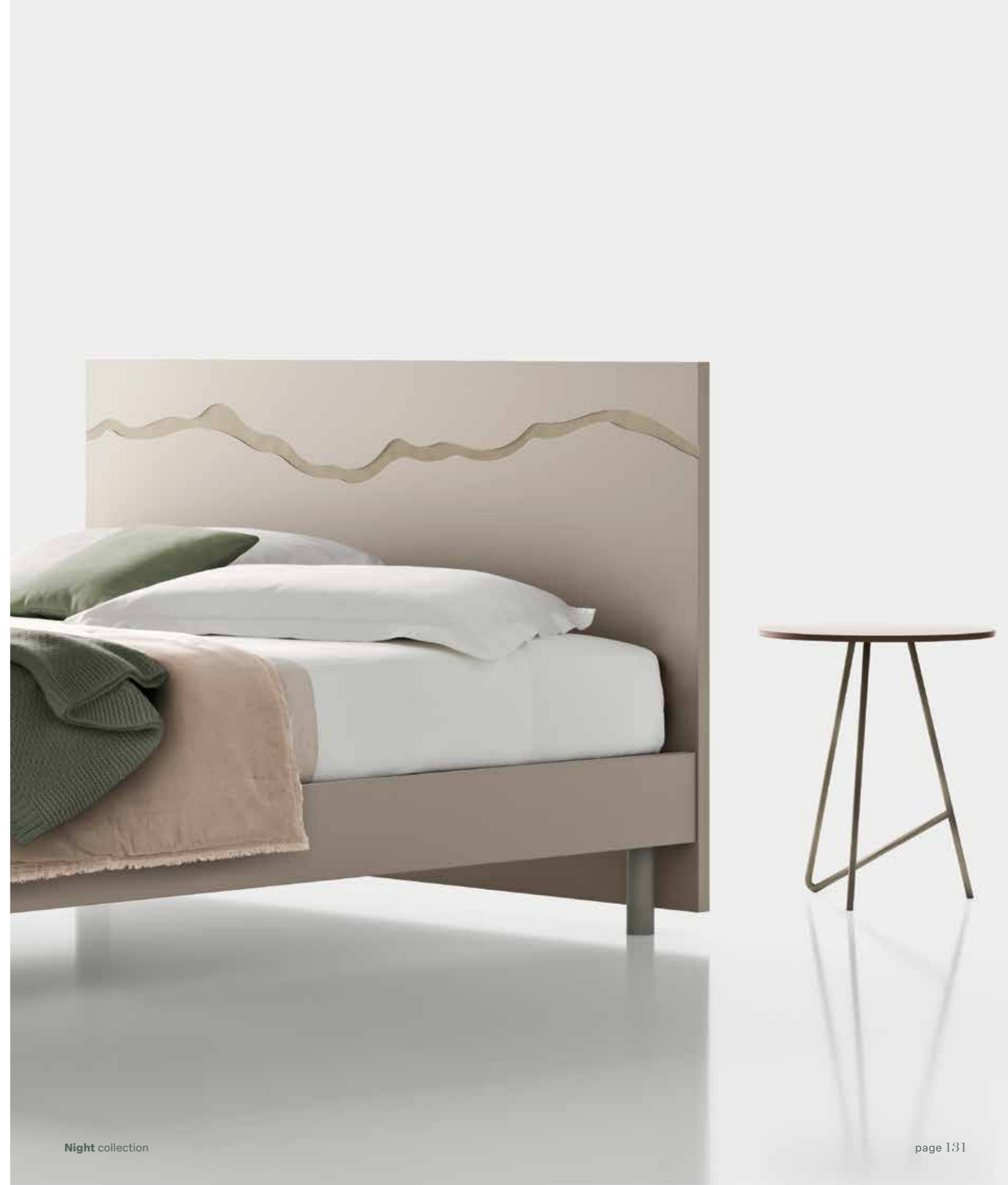

Night collection

Letto **Flash** in melaminico Sabbia e decorazione in Nichel - Gruppo Seta in melaminico Sabbia e vassoio in Rovere Nordico

Flash bed in Sabbia melamine and Nichel decoration - Seta suite in Sabbia melamine and tray top in Nordico oak



Il decoro sulla testiera è frutto di una particolare lavorazione, che conferisce dinamismo e originalità alla zona notte.

The headboard's intricate detailing is the result of unique craftsmanship, adding a dynamic and original touch to the bedroom.



Il top a vassoio può essere personalizzato con finitura a contrasto. Tutti i cassetti del gruppo Seta hanno apertura Push & Pull e chiusura rallentata di serie.

The tray top can be customised in a contrasting finish. All the drawers in the Seta Suite have a push-pull opening and soft close as standard.



Night collection

Letto **Flash** in melaminico
Grafite e decoro in
laccato opaco Nichel -
Gruppo Street in Olmo
Tabacco e profilo laccato
opaco Nichel

Flash bed in Grafite
melamine and matt
lacquer Nichel decoration
Street suite in Tabacco
elm and Nichel matt
lacquered profile



Ai lati della testiera possono essere aggiunti uno o due pannelli, personalizzabili secondo il proprio gusto: uno può dare continuità al decoro, l'altro in una finitura diversa per coordinarsi al resto degli arredi.

One or two panels can be added to the side of the headboard, customised to personal taste: one can provide continuity with the decoration while the other with remainder of the furnishings.



Scudo

Letto - Bed

Scudo è la testiera dal design inconfondibile: una composizione che alterna doghe in Rovere e inserti in finitura, coordinata o a contrasto, anche imbottiti. La pannellatura laterale in laccato è applicabile a un solo lato.

Disponibile anche nella versione Scudo imbottito, da completare con Sommier
Also available in the upholstered version, to be completed with the Divan bed

The Scudo headboard sports an unmistakable design: a composition featuring oak slats alternating with matching or contrasting inserts, which can also be upholstered. The lacquered side panelling can be applied to one side only.



Scudo imbottito

Night collection

Testiera **Scudo imbottita**
in tessuto Elettra 02 e
Impiallacciato Miele, giroletto
Cloud in Impiallacciato Miele -
Gruppo Unix in laccato opaco
Verde Militare

Scudo headboard padded in
Elettra 02 fabric and Miele
veneered, Cloud bed frame in
Miele veneered - Unix suite in
Verde Militare matt lacquer



Le doghe possono essere anche rivestite in tessuto oppure ecopelle.
La testiera Scudo è abbinabile a tutti i giroletti sommier.

The slats can also be upholstered in fabric or eco-leather.
The Scudo headboard is designed to be paired with all divan bed frames.





Arredi sospesi

Il comodino Unix e il giroletto Cloud sono entrambi sospesi e ancorati alla parete. La pannellatura laterale, applicabile su un solo lato, diventa schienale per il comodino.

Floating units

The Unix bedside cabinet and the Cloud bed frame are both floating and anchored to the wall. The side panelling, which can be applied to one side only, becomes the back panel for the bedside cabinet.



Scudo

Night collection

Letto **Scudo** in
impiallacciato Scuderia e
tessuto Point 28
Gruppo Scuderia in
laccato opaco Ghiaccio e
impiallacciato Scuderia

Scudo bed in Scuderia
Veneered and Point 28
fabric - Scuderia suite
in Ghiaccio matt lacquer
and Scuderia Veneered



Comodino abbinato
Linee e finiture del sistema Scudo si coordinano a quelle del gruppo Scuderia.

Matching bedside cabinet
The silhouettes and finishes of the Scudo system match those of the Scuderia suite.



Night collection

Letto **Scudo** in
impiallacciato Grigio e
Sommier in laccato opaco
Bianco - Gruppo Scuderia
in laccato opaco Bianco e
impiallacciato Grigio

Scudo bed in Grigio
Veneered and divan bed
in Bianco matt lacquer
Scuderia suite in Bianco
matt lacquer and
Grigio Veneered

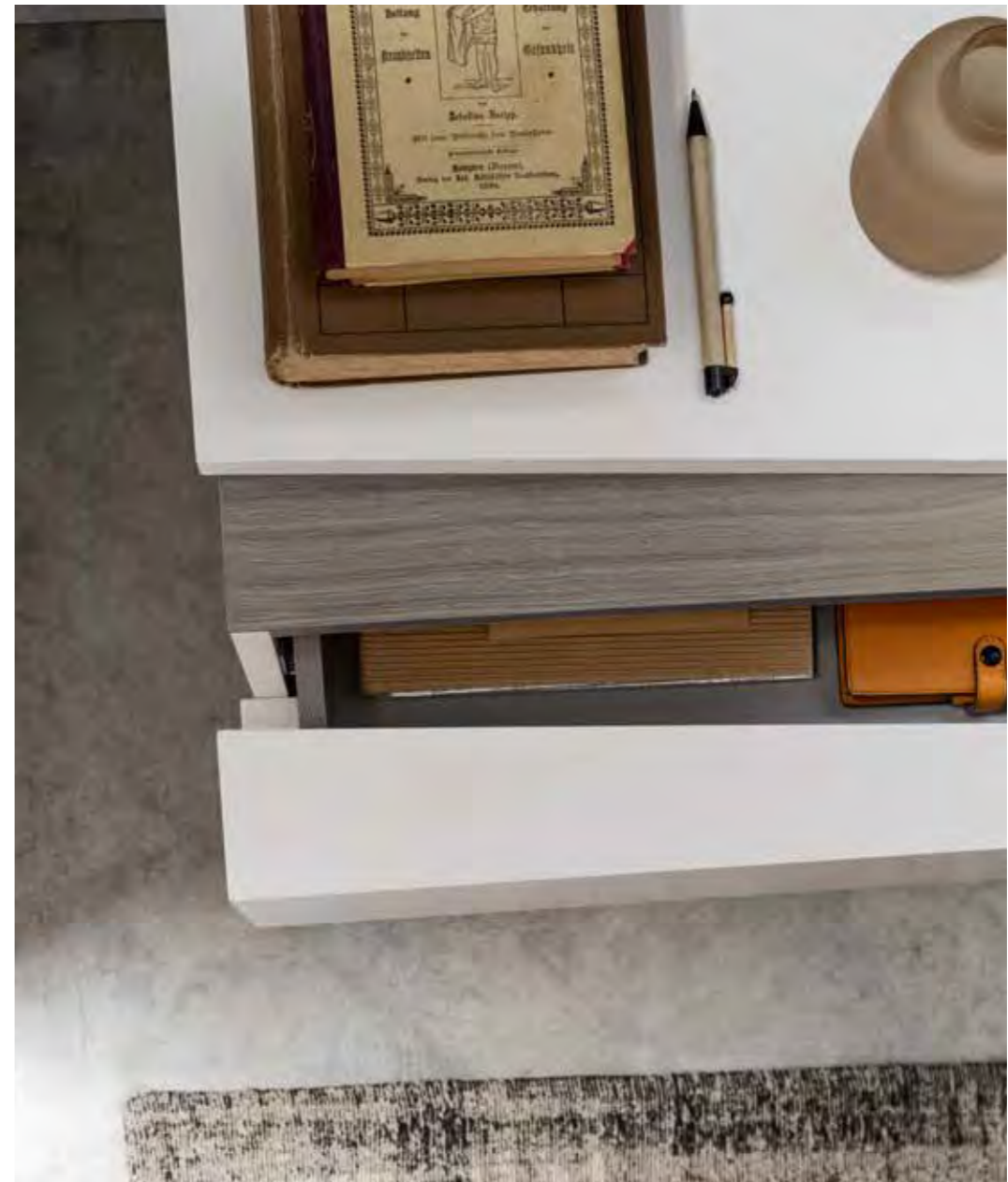

Lena

Letto - Bed

La testiera è disponibile con un unico cuscino o due cuscini. In entrambi i casi lo schienale leggermente inclinato assicura l'ergonomia del design. Abbinabile a più giroletti, anche con contenitore.

Disponibile nella versione sospeso o a terra
Available in the floating or floor-standing version

The headboard is available with one or two cushions. In both cases, the slightly slanted backrest ensures the design is ergonomic. Designed to match several bed frames, including with storage.



Night collection

Letto **Lena** in tessuto
Sogno 800 e laccato
opaco Terra -
Gruppo **Brio** in
laccato opaco Terra

Lena bed in Sogno
800 fabric in Terra
matt lacquer -
Brio suite in Terra
matt lacquer





Funzionalità integrata al design

La particolare lavorazione a 45° forma una sofisticata dentatura tra top e cassetto superiore, rendendo gli spigoli più robusti. Il fianco leggermente rientrante offre la presa laterale dei cassetti.

Functionality incorporated into the design

The special 45° workmanship creates a sophisticated groove between the top and the top drawer, making the edges more robust. The slightly recessed side panel creates a side grip to open the drawers.





Night collection

Letto **Lena** in Olmo
Tabacco e testiera in
tessuto Rally 600 -
Gruppo **Bold** in laccato
opaco Ghiaccio e
Olmo Tabacco

Lena bed in Tabacco
elm and headboard in
Rally 600 fabric -
Bold suite in Ghiaccio
matt lacquer and
Tabacco elm





Finiture coordinate
L'inserto del comodino Bold trova corrispondenza nella finitura del giroletto con altezza 10 cm.

Matching finishes
The Bold bedside cabinet insert matches the bed frame finish, 10 cm high.

Specchiera Pato

La scelta dei complementi definisce lo stile e le funzionalità della camera da letto.

Pato mirror

Accessories can be chosen to set the style and function of the bedroom.



Vela

Letto - Bed

La testiera delicatamente curva caratterizza il design. Il giroletto è disponibile in più varianti, anche con contenitore rientrante.

The gently curved headboard distinguishes the design. The bed frame is available in several versions, including with a recessed storage unit.





Night collection

Letto **Vela** in Rovere
Nordico - Gruppo **Way** in
laccato lucido Cashmere

Vela bed in Nordico
oak - Way suite in
Cashmere glossy lacquer



Night collection

Letto **Vela** in Olmo
Artico - Gruppo **Bold** in
Olmo Artico e laccato
opaco Celeste

Vela bed in Artico elm -
Bold suite in Artico
elm and Celeste matt
lacquer





Il vivace design è caratterizzato da un angolo dritto e un angolo curvo, con l'inserto colorato che diventa presa maniglia. Il fianco nasconde un confortevole vano segreto.

The lively design is distinguished by one straight and one curved corner, featuring a coloured insert that serves as a handle grip. The side panel conceals a convenient secret compartment.



Slide

Letto - Bed

La testiera si compone in due pannelli di diverso spessore, separati da un taglio obliquo lungo il quale può correre la luce a LED. Abbinabile a tutti i giroletti, con o senza contenitore.

The headboard consists of two different thickness panels, separated by an oblique cut along which an LED light can be fitted. Designed to be paired with all bed frames, with or without a storage compartment.





Night collection

Letto **Slide** in Rovere Nordico - Gruppo **Cross** in Rovere Nordico e inserti in laccato opaco Agata

Slide bed in Nordico oak - Cross suite in Nordico oak and inserts in Agata matt lacquer

Il gruppo Cross completa lo stile d'arredo del letto Slide.
Il taglio diagonale divide in due i cassetti e le finiture di comò e comodini.

The Cross suite completes the furnishing style of the Slide bed.
A diagonal cut divides the drawers on the dresser and bedside cabinets
in two, as well as separating the two different finishes.



Night collection

Letto **Slide** in Olmo
Tabacco -
Gruppo Scuderia in
laccato opaco Terra

Slide bed in
Tabacco elm -
Scuderia suite in
Terra matt lacquer





Letto Slide abbinato al gruppo Scuderia: un dialogo tra linee e direzioni diagonali che infonde dinamismo all'arredo.

Slide bed paired with the Scuderia suite: a dynamic interplay of lines and angles that energises the décor.



Lola

Letto - Bed

Un letto imbottito con rivestimento sfoderabile in tessuto o ecopelle. I cuscini della testata sono reclinabili manualmente per un comodo riposo lombare.

An upholstered bed, with removable fabric or eco-leather upholstery. The headboard cushions can be reclined manually for comfortable lower back support.



Night collection

Letto **Lola** in tessuto
Ripley 19 - Gruppo Jazz
Plus in Cemento Bianco
e laccato opaco Pluvia

Lola bed in Ripley 19
fabric - Jazz Plus suite
in Cemento White and
Pluvia matt lacquer





Gruppo Jazz Plus con maniglia decentrata
Il comò è incorniciato dalla sofisticata boiserie Seta in tonalità coordinata, per una composizione d'arredo estremamente distintiva.

Jazz Plus suite with offset handle
The dresser is framed by the sophisticated Seta wood panelling in a matching colour, delivering a one-of-a-kind furnishing composition.

Night collection

Letto **Lola** in tessuto
Elettra 11 - Gruppo
Gardenia in frassino
laccato Agata

Lola bed in Elettra 11
fabric - Gardenia suite
in Agata lacquered ash







Il gruppo Gardenia gioca con gli opposti: allure classica e design moderno, calore ed essenzialità, dinamismo e armonia.

The Gardenia suite plays with opposites: classic allure and modern design, warmth and understated appeal, dynamism and harmony.

Night collection

Letto **Lola** in Lino Naturale 548 - Gruppo Street in melaminico Ghiaccio e inserti in laccato opaco Cipria

Lola bed in Lino Naturale 548 fabric - Street suite in Ghiaccio melamine and inserts in Cipria matt lacquer

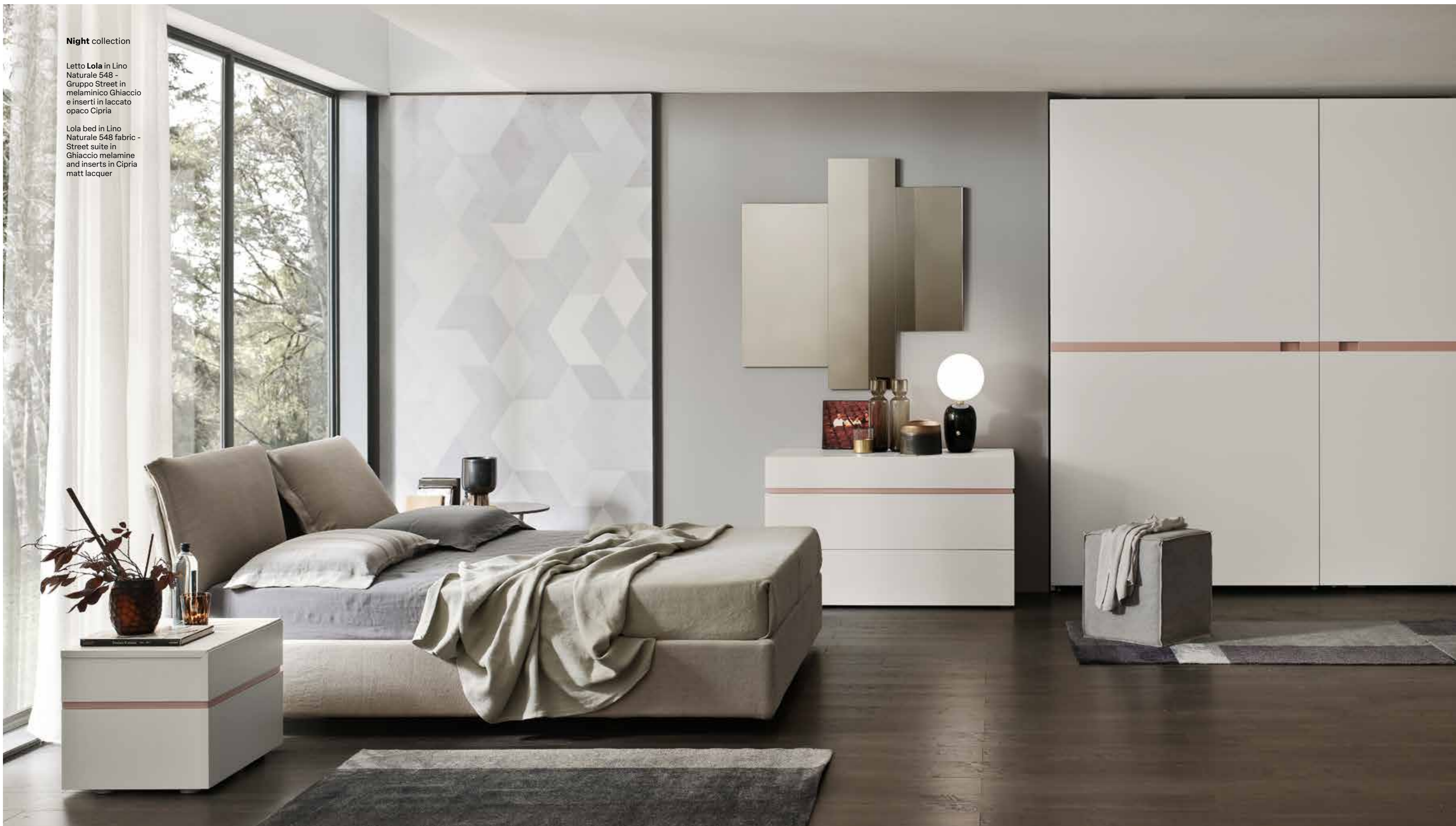



Presenza ergonomica integrata al design

Il taglio a 45° applicato al cassetto offre un'apertura semplice e intuitiva, sostituendosi a maniglie e pomelli.

Ergonomic grip incorporated into the design

The 45° cut applied to the drawer offers simple and user-friendly opening, replacing handles and knobs.

Ester

Letto - Bed

Interamente rivestito in tessuto o in ecopelle, con due morbidi cuscini reclinabili applicati alla testiera. Disponibile solo con giroletto a terra, con o senza contenitore.

Entirely upholstered in fabric or eco-leather, with two soft reclining cushions applied to the headboard. Only available with floor-standing bed frame, with or without storage unit.



Night collection

Letto **Ester** in tessuto Ripley 19 - Gruppo Beta in laccato opaco Carta da Zucchero

Ester bed in Ripley 19 fabric - Beta suite in Carta da Zucchero matt lacquer





Sfoderabile e retrofinito
Il rivestimento rifinito anche sullo schienale della testiera permette di posizionare il letto anche discostato dal muro.

With removable upholstery and finished back
The upholstery finish on the back of the headboard too means the bed can also be fitted set away from the wall.



Libertà di colori e finiture

Il gruppo Beta è personalizzabile in tutti i colori laccati, in Frassino colore e nei melaminici in essenza.

Free colours and finishes

The Beta suite can be customised in all lacquered colours, coloured ash wood and wood-finish melamine.

Il frontale del primo cassetto sporge leggermente dal top diventando presa maniglia.

The top drawer front protrudes slightly from the top and serves as a grip.



Night collection

Letto **Ester** in tessuto
Sogno 401 - Gruppo
Brio in Rovere Thea

Ester bed in Sogno 401
fabric - Brio suite in
Thea oak





I rivestimenti di Ester

Testiera e giroletto possono essere rivestiti in tessuto, anche con lavorazione bouclé, oppure in ecopelle. La libreria O Pen è pensata per creare originali elementi di design.

Ester upholstery

The headboard and bed frame can be upholstered in fabric, also with a bouclé finish, or in eco-leather. The O Pen bookcase is designed to create original design elements.



Deo

Letto - Bed

La ricerca stilistica reinterpreta l'estetica classica del capitonné, esaltandola per incontrare i gusti della modernità. Disponibile anche con luce perimetrale a LED, che definisce la cornice sulla testiera.

Classic aesthetics have been reinterpreted, giving the traditional tufted finish new style to suit modern tastes. Also available with LED perimeter light, outlining the headboard frame.

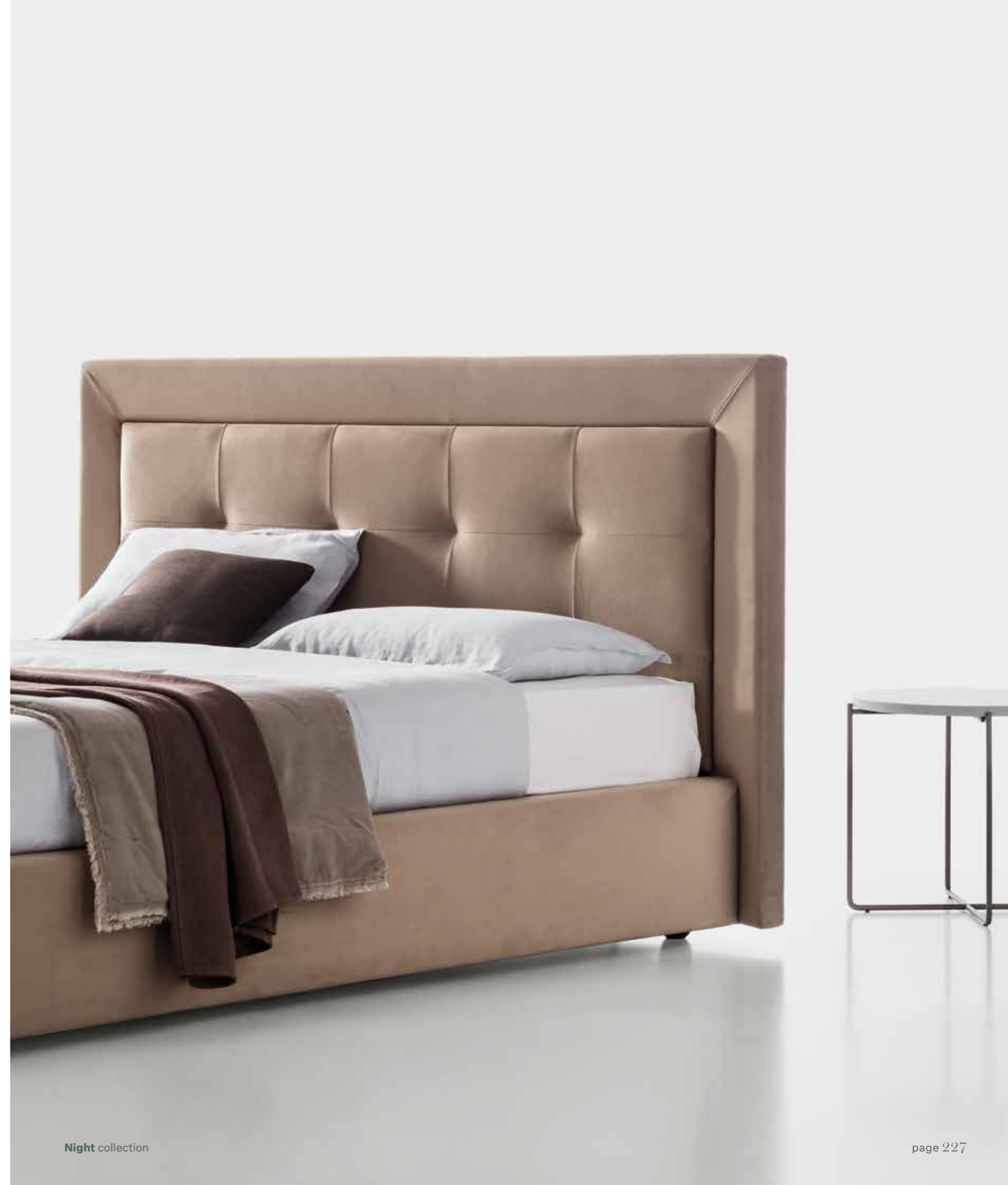

Night collection

Letto Deo in tessuto
Amsterdam 44 -
Gruppo Oslo in Rovere Thea

Deo bed in Amsterdam
44 fabric - Oslo suite in
Thea oak



Morbidi rivestimenti

Il rivestimento in tessuto o in ecopelle avvolge la testiera e il giroletto a terra. Deo è disponibile anche con base contenitore.

Soft upholsteries

The fabric or eco-leather upholstery envelops the headboard and the floor-standing bed frame. Deo is also available with storage unit.

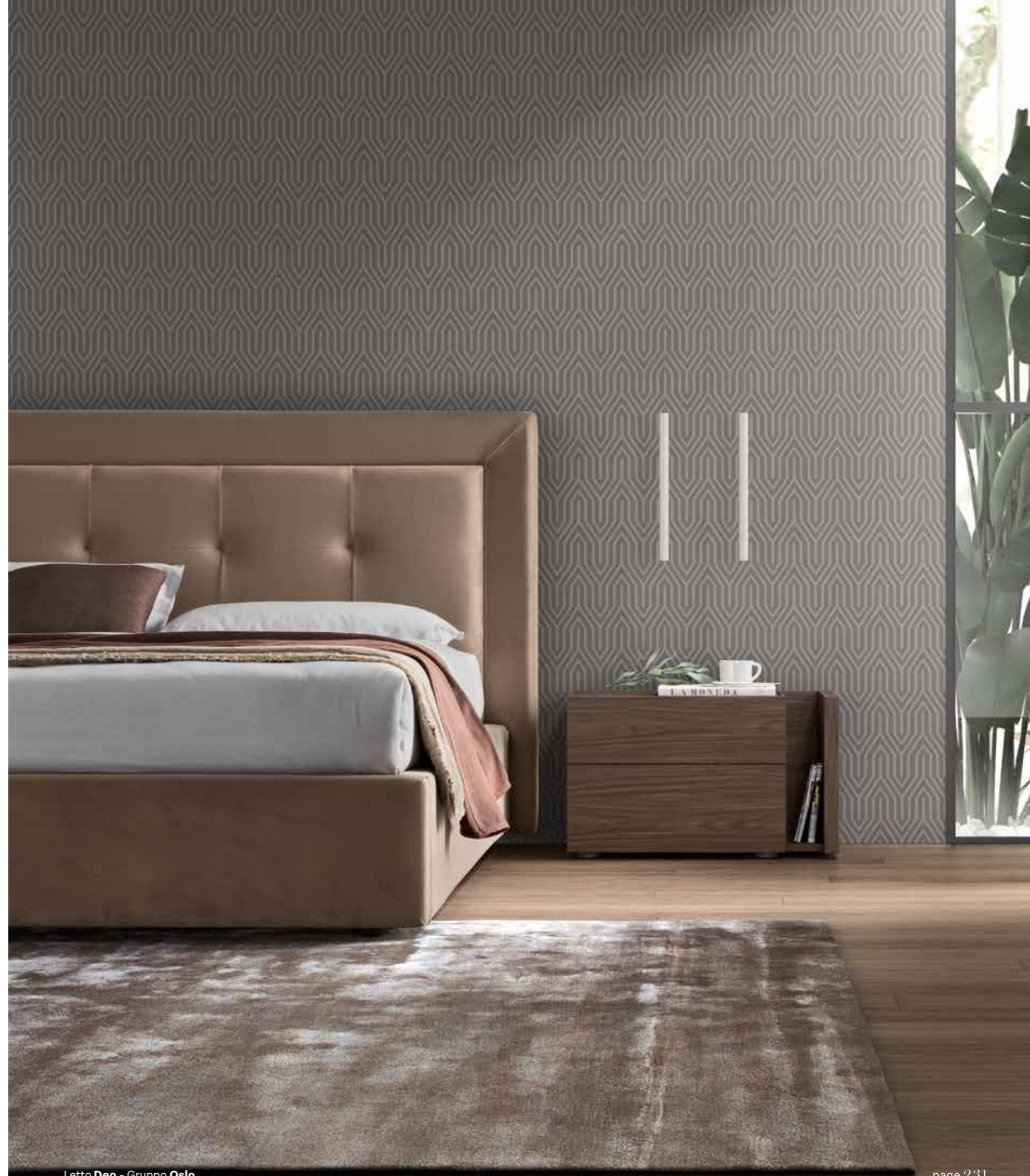



Con vano a giorno

Il gruppo Oslo si distingue per la particolare mini-libreria laterale. Il top in gres a vassoio è personalizzabile anche con finitura a contrasto.

With open compartment

The Oslo suite stands out for the distinctive miniature bookcase on the side. The tray in gres top can also be customised with contrasting finish.

Night collection

Letto **Deo** con pediera e inserto testiera in ecopelle Gold col.05 e cornice testiera in ecopelle Gold col.06 - Gruppo Grip in laccato lucido Sabbia

Deo bed with footboard and headboard insert in Gold eco-leather col.05 and headboard frame in Gold eco-leather col.06 - Grip suite in Sand glossy lacquer





City

Letto - Bed

Due morbidi decori a onda percorrono orizzontalmente la testiera, rendendo distintivo il design del letto City. Disponibile con più giroletti e contenitore.

Two soft wave-like decorations run horizontally across the headboard, making the design of the City bed distinctive. Available with several bed frames and storage unit.





Night collection

Letto **City** in
Ecopelle Bianco -
Gruppo **City** in
frassino Bianco

City bed in Bianco
eco-leather - City
suite in Bianco ash



Frontali decorati

Le linee curve incise sui frontali dei cassetti danno una forte impronta decorativa alla camera.

Decorated fronts

The curved lines carved into the drawer fronts give the bedroom clear decorative direction.

Movimento all'arredo

I cassetti di comò, comodini e settimanali hanno un profilo leggermente bombato, per trasmettere dinamicità agli arredi.

Movement for furniture

The drawers in dressers, bedside cabinets and chests of drawers have a slightly rounded profile to make the furniture appear rounded.



SISTEMI — MODULARI

Seta e Bumpy sono due sistemi modulari, completi di pannellature e boiserie ancorate a parete con misura al mq, e mensole coordinate. Ogni pannello è disponibile in molteplici colori e finiture, ed è progettato per arredare pareti, comporre schienali e testiere, e caratterizzare così lo stile dell'arredamento.

Beds Systems

Seta and Bumpy are two modular systems, complete with panelling and boiserie wood panelling anchored to the wall, sized by the square meter, and with matching shelves. Each panel is available in multiple colours and finishes, and is designed to furnish walls, put together backrests and headboards, thereby characterising the style of interiors.

248 **SISTEMA
SETA**
Seta System

254 **SISTEMA
BUMPY**
Bumpy System

Sistema Seta

Night collection

Sistema Seta con Boiserie in laccato opaco Pluvia, centorighe Nocciola e giroletto **Sommier** in tessuto Amsterdam 08 Gruppo Light in laccato opaco Pluvia

Seta system with Boiserie, in Pluvia matt lacquered and Centorighe Nocciola wood panelling **Sommier**, and bed frame in Amsterdam 08 fabric - Light suite in Pluvia matt lacquer





La boiserie Seta permette l'inserimento di una luce posteriore, dialogando così con il vano illuminato del comodino Light.
The Seta wood panelling can be fitted with a rear light, thus liaising with the illuminated compartment in the Light bedside cabinet.

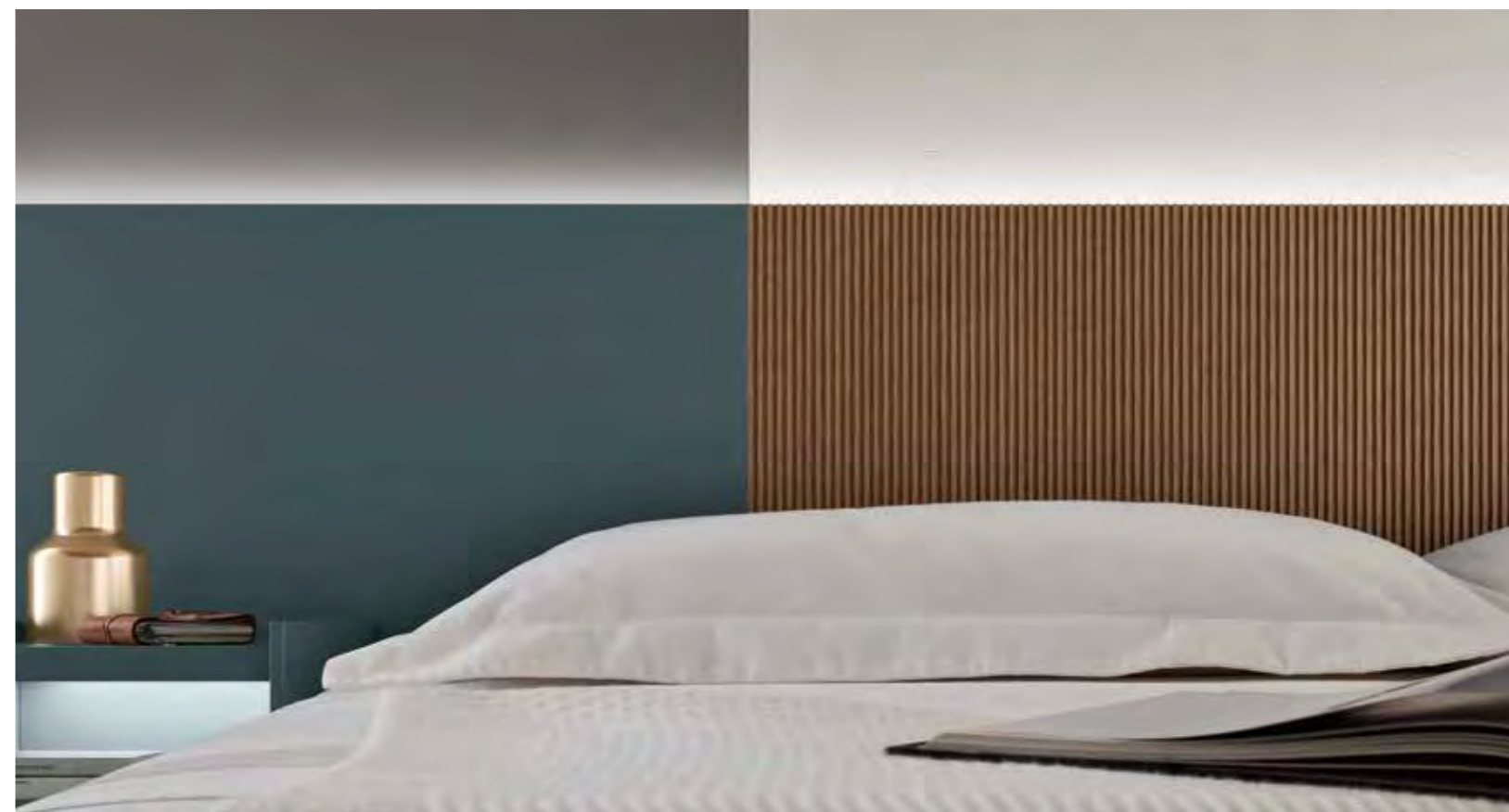

Massima libertà espressiva

La grande varietà di moduli e finiture consente accostamenti distintivi, come quello tra il laccato Pluvia e il motivo centorighe Nocciola.

Maximum freedom of expression

The wide variety of modules and finishes makes for distinctive combinations, such as Pluvia lacquer and the Centorighe Nocciola pattern.

Sistema Bumpy

Night collection

Sistema Boiserie Bumpy e giroletto Cloud in Rovere Nordico - Gruppo Unix in laccato opaco Cotto

Bumpy boiserie system and Cloud bed frame in Nordico oak - Unix suite in Cotto matt lacquer



Le mensole integrabili alle boiserie del sistema Bumpy sono in finitura metallizzata. La pannellatura unica orizzontale esalta il fascino intramontabile della venatura.

The shelves designed to fit into the wood panelling in the Bumpy range are in a metallic finish. The single horizontal panelling emphasises the timeless charm of the wood grain.





Night collection

Testiera **Bumpy** in tessuto Flirt Lino Grigio e laccato opaco Cashmere, giroletto Cloud in tessuto Flirt Lino Grigio - Gruppo Seta in laccato opaco Cashmere e Olmo Tabacco

Bumpy headboard in Flirt Lino Grigio fabric and Cashmere matt lacquer, Cloud bed frame in Flirt Lino Grigio fabric - Seta suite in Cashmere matt lacquer and Tabacco elm



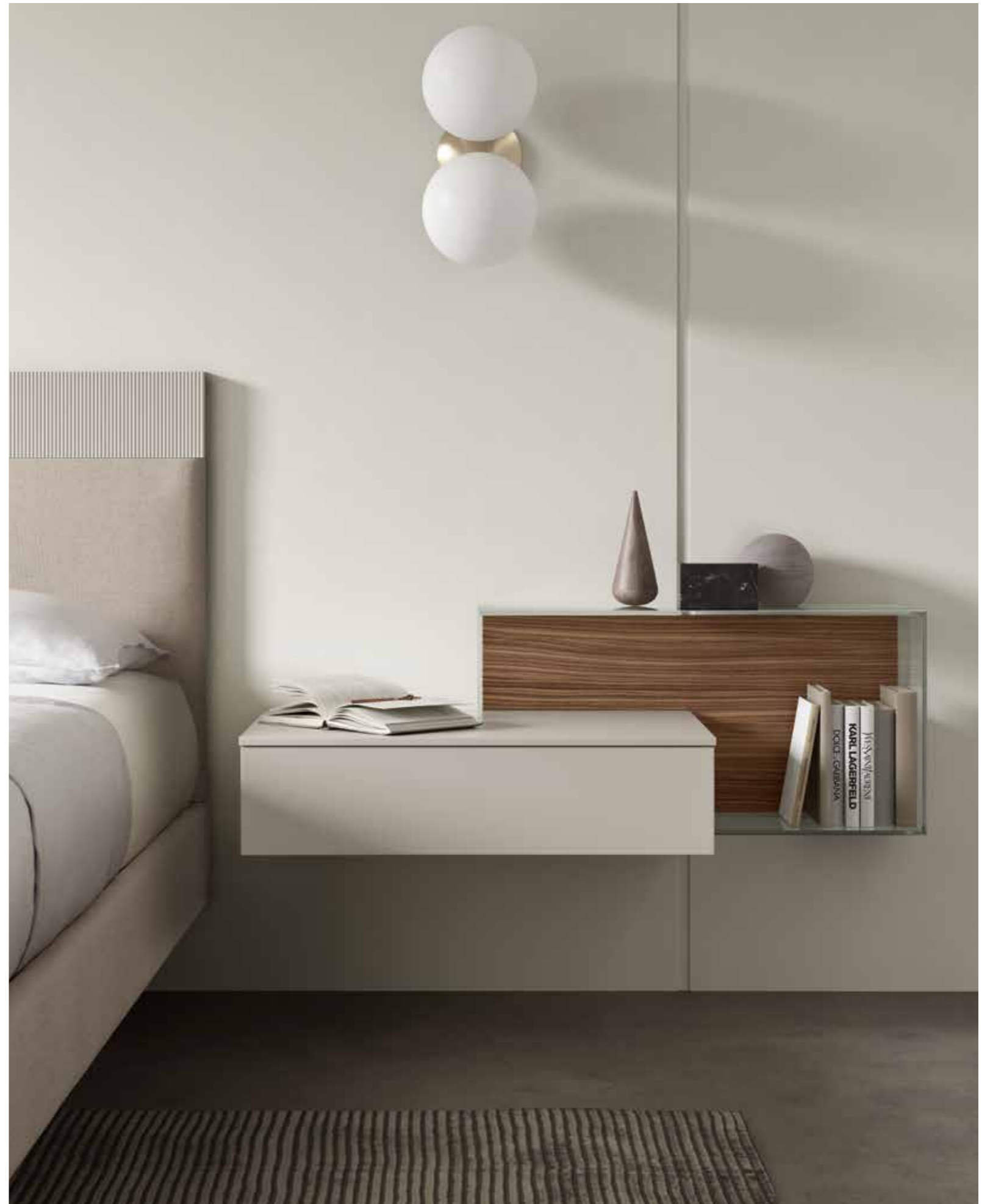

Al comò del gruppo Seta può essere applicato un top in forte spessore con scorrimento laterale. Con un semplice gesto, è possibile così creare una comoda posizione scrivania.

The dresser in the Seta suite can be fitted with an extra thick top that slides out to the side. In one simple move, a desk top can therefore be set up.





Night collection

Sistema Bumpy
con giroletto **Cloud** e
testiera in Elettra 06 -
Gruppo Seta e Boiserie in
Cemento Bianco e laccato
opaco in Rosa Vintage

Bumpy system
with Cloud bed frame
and headboard in Elettra
06 - Seta suite and wood
panelling in Cemento
Bianco and in Rosa
Vintage matt lacquer



La modularità dei pannelli Seta permette di ridisegnare completamente la parete, salendo fino al soffitto.

The modularity of the Seta panels allows you to rearrange the wall entirely, exploiting the full height up to the ceiling.



Night collection

Sistema **Bumpy** con giroletto **Cloud** in Rovere Nordico e testiera in tessuto Sogno 401 - Gruppo Jazz Plus in laccato opaco Palude e pressato Palude

Bumpy system with Cloud bed frame in Nordico oak and headboard in Sogno 401 fabric - Jazz Plus suite in Palude matt lacquer and pressed Palude



Night collection

Sistema **Bumpy** con giroletto **Sommier** in tessuto Lino Planet 515/534 e in melaminico Grafite - Gruppo Light in melaminico Cemento Bianco e Grafite

Bumpy system with Sommier bed frame in Lino Planet 515/534 fabric and Grafite melamine - Light suite in White Cemento and Grafite melamine





Night collection

Sistema **Bumpy** con giroletto **Sommier** in tessuto Lino Planet 529 e Olmo Tabacco - Gruppo Unix in laccato opaco Verde Plaude e Olmo Tabacco

Bumpy system with Sommier bed frame in Lino Planet 529 fabric and Tabacco elm - Unix suite in Verde Palude matt lacquer and Tabacco elm







Presca ergonomica integrata al design

La forma sagomata del cassetto offre una presa comoda e intuitiva, eliminando la necessità di maniglie e pomelli.

Ergonomic grip incorporated into the design

The contoured shape of the drawer ensures a comfortable and intuitive grip, replacing handles or knobs.



Night collection

Sistema **Bumpy** con giroletto **Sommier** in tessuto Sogno 401 - 904 e Rovere Thea - Gruppo Unix comodini in Rovere Thea e comò in Rosa Vintage

Bumpy system with Sommier bed frame in Sogno 401 - 904 fabric and Thea oak - Unix suite with bedside cabinets in Thea oak and dresser in Rosa Vintage

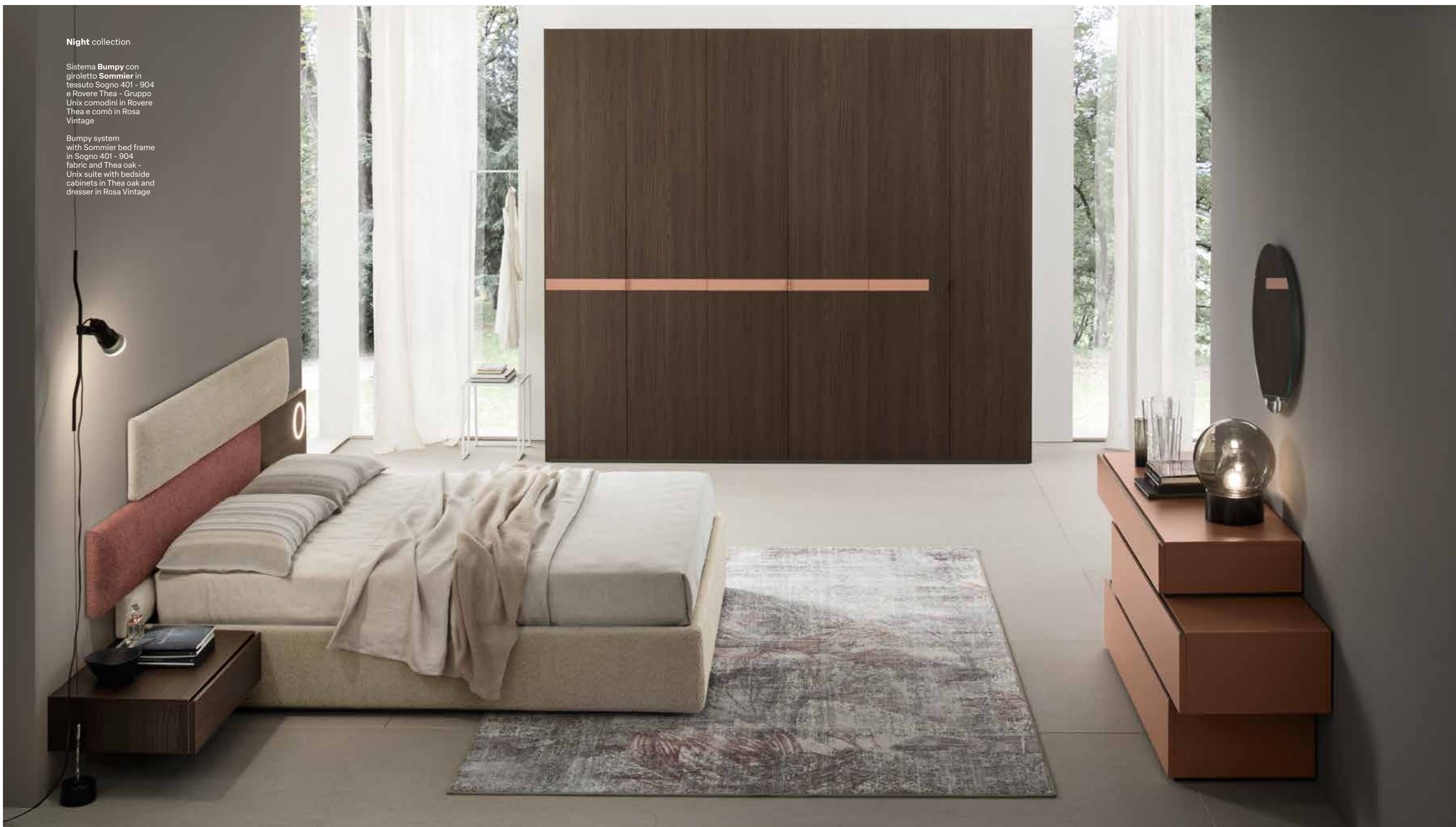



Il sistema Bumpy permette di mettere in dialogo la boiserie-testiera con il tessuto del giroletto e le finiture dei comodini.

The Bumpy system is devised to create an interplay between the headboard/wood panelling and the bed frame fabric plus the bedside cabinet finishes.



TECHNICAL — AREA

293	APERTURE LETTI Bed opening mechanisms
294	PIEDINI Feet
298	TOP Top
300	GRUPPI Suites
320	TAVOLINI Bedside tables
322	POUF E CUSCINI Pouf and Pillows
324	POLTRONCINE Armchairs
324	SPECCHIERE Mirrors
328	MOOD & INSPIRATIONS Mood & Inspirations
340	FINITURE Finishes
349	CARTE DA PARATI Wallpapers

APERTURE LETTI

Bed opening mechanisms

Per l'apertura dei letti con contenitore, è possibile scegliere tra due pratici sistemi ad alta funzionalità.

You can choose between two highly functional and practical systems to open storage beds.

APERTURA **OPEN**

Open opening mechanisms



APERTURA **PRATIKO**

Pratiko opening mechanisms





PIEDINI

Feet

Linee sottili e geometrie pulite sottolineano la forza dei materiali e regalano un totale comfort visivo.

Clean lines and geometric shapes emphasise the strength of the materials and create a sense of visual comfort.



GRUPPO **SETA**
Seta Suites



GRUPPO **UNIX**
Unix Suites



GRUPPO **MONO**
Mono Suites



GRUPPO **GARDENIA**
Gardenia Suites

PIEDINI

Feet

L'estetica degli arredi notte si completa con la gamma di piedini e supporti, per interpretare diversi stili d'arredo.

The aesthetics of the bedroom furniture are finished off with a range of feet and supports to suit different furnishing styles.



Personalizzazione del top

Il top a vassoio è personalizzabile in diverse finiture materiche: gres, melaminico marmo, vetro stampato e vetro colorato.

Top customisation

The tray top can be customised with various textured finishes: stoneware, marble melamine, printed glass and coloured glass.



Top disponibile nei 6 Gres
Top available in 6 stoneware finishes



Top disponibile nei 3 melaminici marmo
Top available in 3 marble melamine finishes



Top disponibile nei 6 vetri stampati
Top available in 6 printed glass finishes

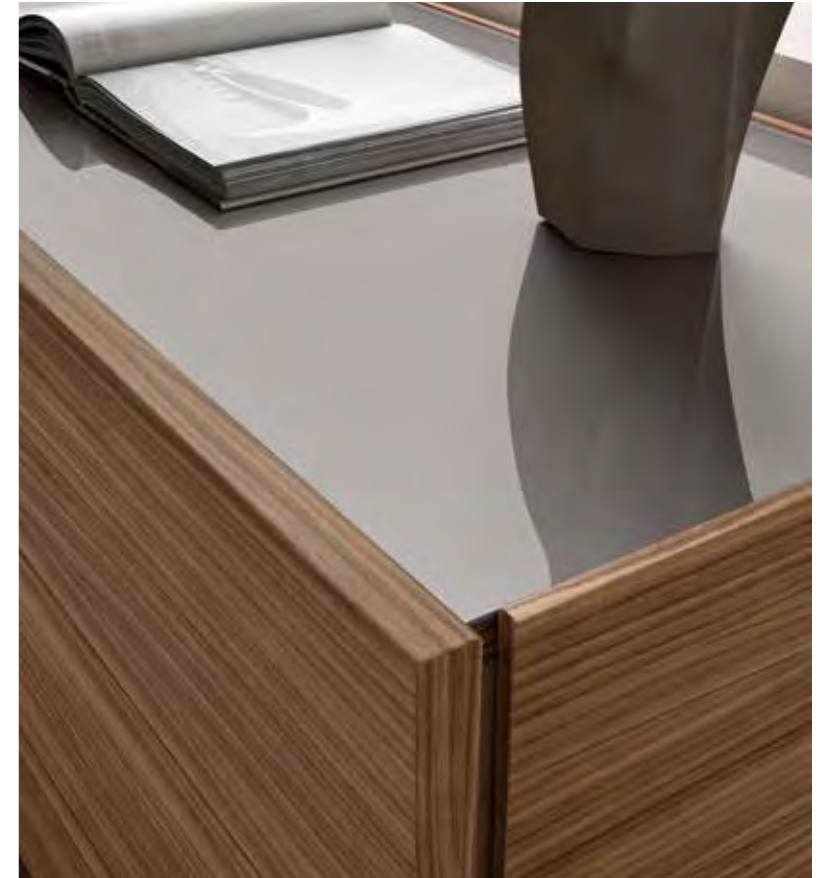

Top in vetro colorato con i colori della mazzetta laccati
Coloured glass top in any of the lacquered colours

GRUPPI

Suites

I gruppi comò e comodino definiscono lo stile della zona notte, offrendo alla camera da letto una perfetta organizzazione degli spazi e una forte impronta estetica.

The dresser and bedside cabinet suites define the style of the bedroom, providing perfectly organized space and a strong aesthetic impact.

- 301 **BETA**
- 302 **BOLD**
- 303 **BRIO**
- 304 **CAPRI**
- 305 **CITY**
- 306 **CROSS**
- 307 **EDEN**
- 308 **GARDENIA**
- 309 **GRIP**
- 310 **JAZZ / JAZZ PLUS**
- 311 **LIGHT**
- 312 **MONO**
- 313 **OSLO**
- 314 **SCUDERIA**
- 315 **SETA**
- 316 **STREET**
- 317 **UNIX**
- 318 **WAY**
- 319 **45°**

BETA

Gruppo - Suite



Dimensioni disponibili
Available sizes

Vedi a pagina 212
See page

Comodino 2 cassetti 2 bedside drawers	Comò 3 cassetti 3 drawers dresser	Settimanale 6 cassetti Weekly 6 drawers
L 497/566 x H 396 x P 443	L 1216 x H 797 x P 543	L 566 x H 1091 x P 443

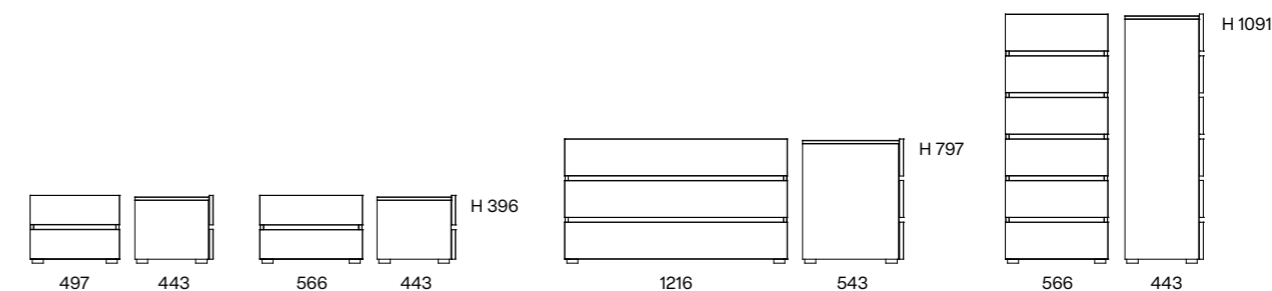

BOLD

Gruppo - Suite



Dimensioni disponibili
Available sizes

Comodino 2 cassetti DX-SX
2 bedside drawers RH-LH
L 556 x H 422 x P 418

Comò 3 cassetti DX-SX
3 drawers dresser RH-LH
L 1317 x H 743 x P 560

Vedi a pagina 166 - 178
See page

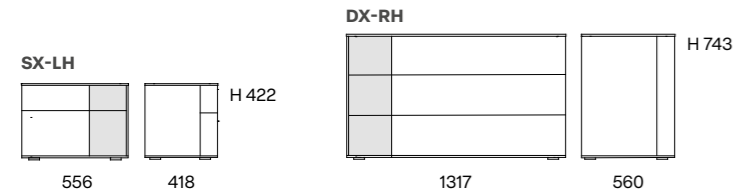

BRIO

Gruppo - Suite



Dimensioni disponibili
Available sizes

Comodino 2 cassetti
2 bedside drawers
L 382 x H 482 x P 443
L 567 x H 372 x P 443

Comò 3 cassetti
3 drawers dresser
L 1217 x H 773 x P 543

Settimanale 6 cassetti
Weekly 6 drawers
L 567 x H 1067 x P 443

Vedi a pagina 160 - 220
See page

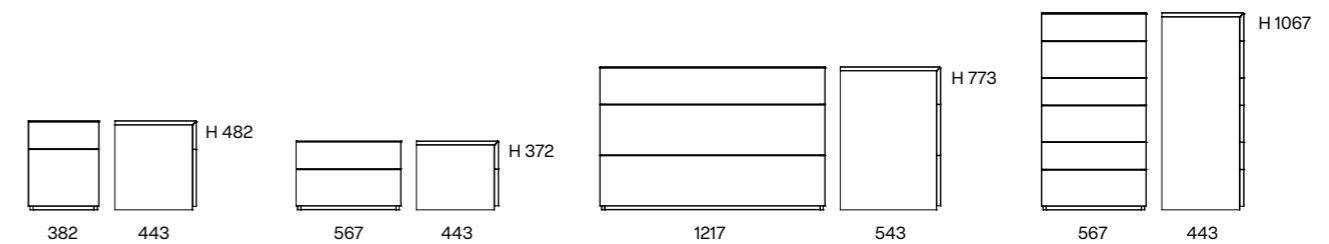

CAPRI

Gruppo - Suite



Dimensioni disponibili
Available sizes

Comodino 2 cassetti
2 bedside drawers

L 628 x H 458 x P 410

Comò 3 cassetti
3 drawers dresser

L 1318 x H 723 x P 535

Vedi a pagina 28 - 48 - 74
See page

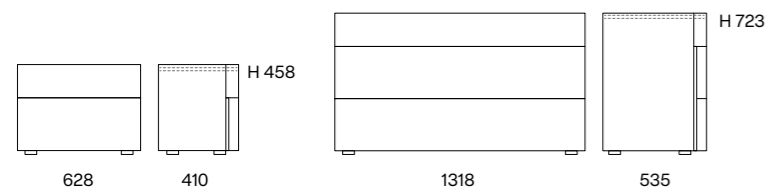

CITY

Gruppo - Suite



Dimensioni disponibili
Available sizes

Comodino 2 cassetti
2 bedside drawers

L 570 x H 368 x P 443

Comò 3 cassetti
3 drawers dresser

L 1220 x H 769 x P 543

Settimanale 6 cassetti
Weekly 6 drawers

L 570 x H 1063 x P 443

Vedi a pagina 240
See page

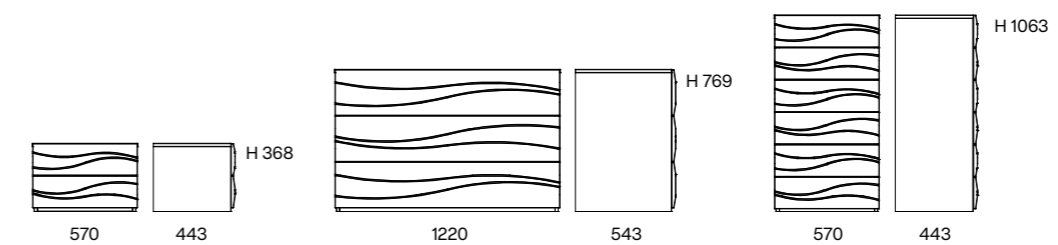

CROSS

Gruppo - Suite



Dimensioni disponibili
Available sizes

Comodino 2 cassetti
2 bedside drawers

L 533 x H 406 x P 413

Comò 3 cassetti
3 drawers dresser

L 1252 x H 792 x P 553

Vedi a pagina 186
See page

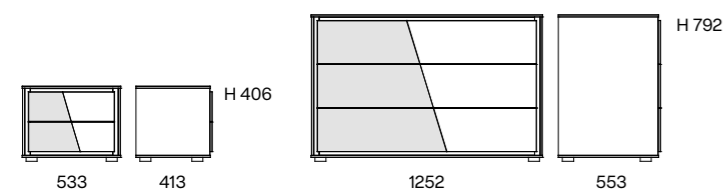

EDEN

Gruppo - Suite



Dimensioni disponibili
Available sizes

Comodino 2 cassetti
2 bedside drawers

L 574 x H 425 x P 442

Comò 3 cassetti
3 drawers dresser

L 1224 x H 717 x P 562

Settimanale 5 cassetti
Weekly 5 drawers

L 574 x H 1127 x P 442

Vedi a pagina 70 - 96
See page

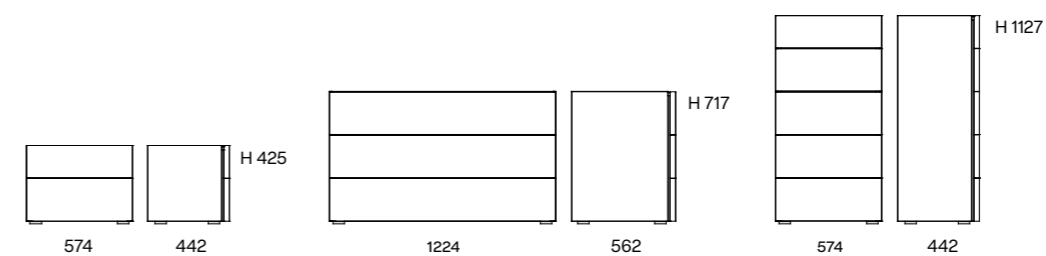

GARDENIA

Gruppo - Suite



Dimensioni disponibili

Available sizes

Comodino 2 cassetti
2 bedside drawers

L 528 x H 471 x P 492
L 564 x H 481 x P 492

Comò 3 cassetti
3 drawers dresser

L 1232 x H 735 x P 492

Settimanale 5 cassetti
Weekly 5 drawers

L 528 x H 1087 x P 492

Vedi a pagina 200

See page

Le misure indicate sono comprensive di top 12 mm (standard) e piedini/basamenti. Il top può essere personalizzato (vedi listino) in sp. 30 o 60 mm.
Dimensions are including 12 mm th. top and legs\base. The top can be customized (see pricelist) with th. 30 or 60 mm.

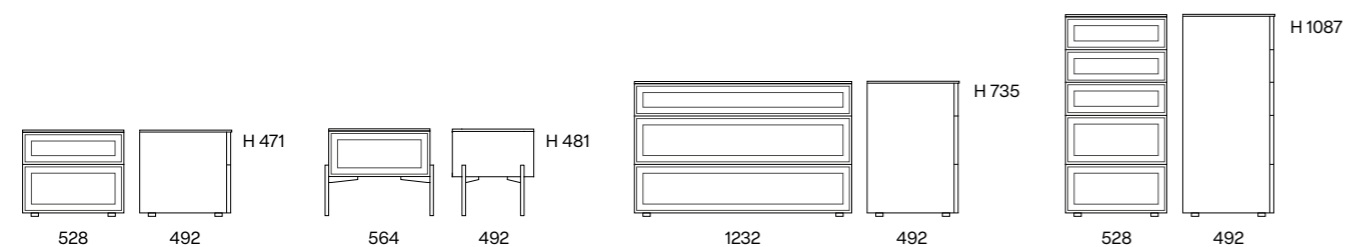

I frontali si possono personalizzare con la serigrafia (vedi pag. 345)

The fronts can be customised with screen printing (see p. 345)

GRIP

Gruppo - Suite



Dimensioni disponibili

Available sizes

Comodino 2 cassetti
2 bedside drawers

L 533 x H 406 x P 402

Comò 3 cassetti
3 drawers dresser

L 1252 x H 792 x P 542

Settimanale 6 cassetti
Weekly 6 drawers

L 533 x H 1170 x P 402

Vedi a pagina 234

See page

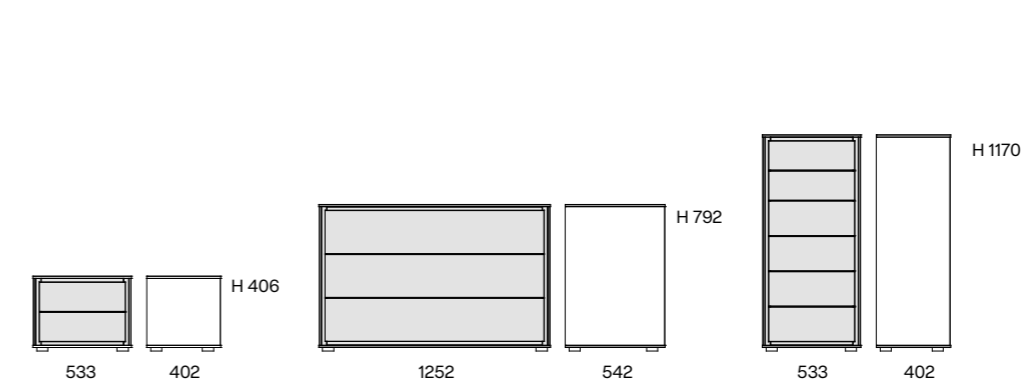

JAZZ - JAZZ PLUS

Gruppo - Suite



Dimensioni disponibili

Available sizes

Comodino 2 cassetti	Comò 3 cassetti	Settimanale 5 cassetti
2 bedside drawers	3 drawers dresser	Weekly 5 drawers
L 506 x H 412 x P 408	L 1226 x H 723 x P 550	L 506 x H 1171 x P 408

Jazz vedi a pagina 120
Jazz Plus pagina 58 - 196 - 272
 See page

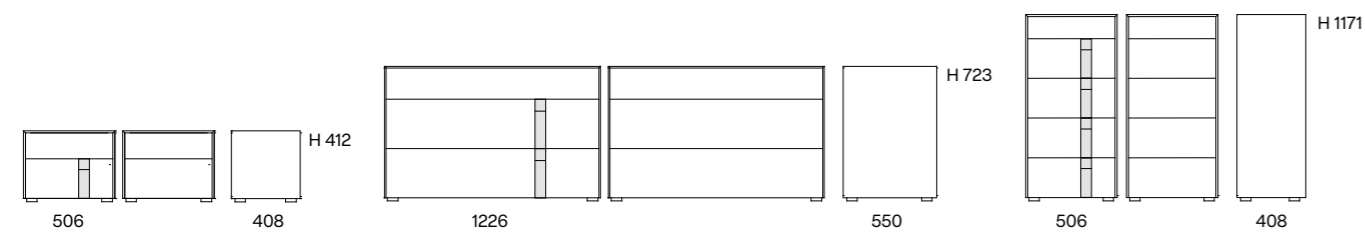

LIGHT

Gruppo - Suite



Dimensioni disponibili

Available sizes

Comodino 1 cassetto	Comò 3 cassetti
1 bedside drawer	3 drawers dresser
L 552-728 x H 466 x P 483 L 376 x H 552 x P 429	L 1225 x H 855 x P 533

Vedi a pagina 10 - 34 - 248 - 274
 See page

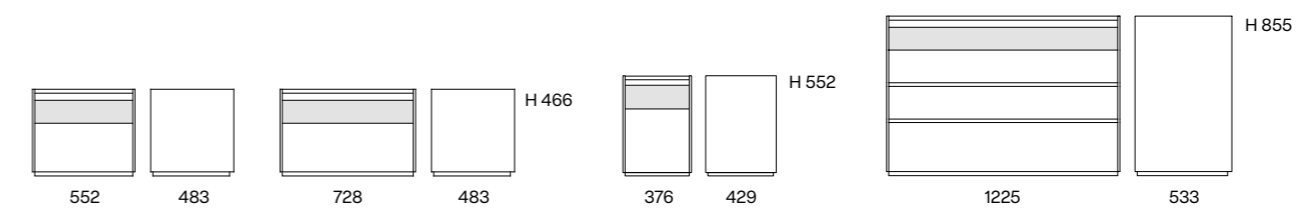

MONO

Gruppo - Suite



Dimensioni disponibili

Available sizes

Comodino 1 cassetto 1 bedside drawer	Comodino 2 cassetti 2 bedside drawers	Comò 3 cassetti 3 drawers dresser	Settimanale 5 cassetti Weekly 5 drawers
L 650 x H 448 x P 420	L 433 x H 500 x P 420 L 618 x H 442 x P 420	L 1268 x H 726 x P 542 L 1300 x H 837 x P 542	L 618 x H 1142 x P 420

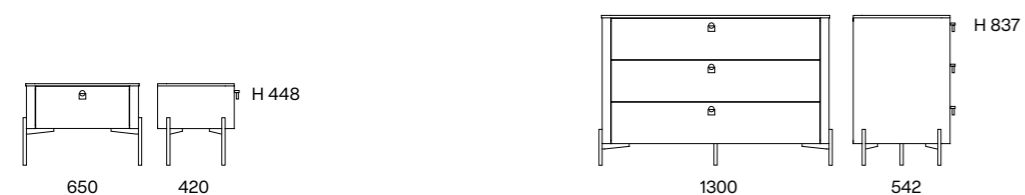
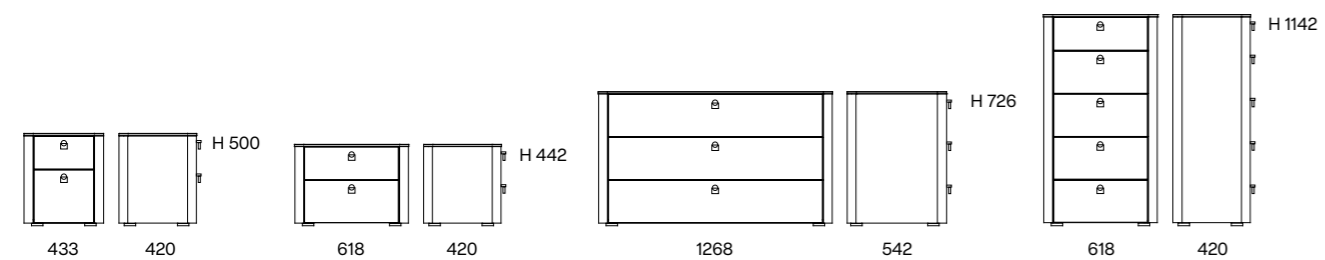

Mono vedi a pagina 16 - 52 - 78
See page

OSLO

Gruppo - Suite



Dimensioni disponibili

Available sizes

Comodino 2 cassetti DX-SX 2 bedside drawers RH-LH	Comò 3 cassetti DX-SX 3 drawers dresser RH-LH
L 705 x H 425 x P 444	L 1400 x H 717 x P 564

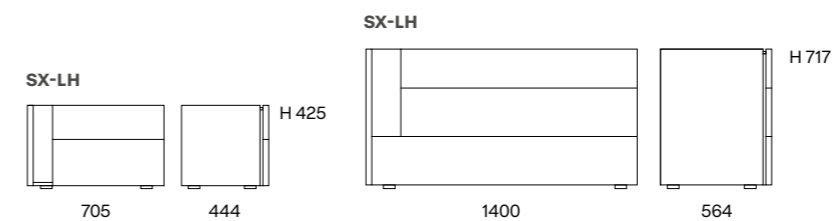

Vedi a pagina 20 - 228
See page

SCUDERIA

Gruppo - Suite



Dimensioni disponibili
Available sizes

**Comodino sospeso
1 cassetto**
Wall-hung 1-drawer
bedside table

L 567 x H 180 x P 442

**Comodino a terra
2 cassetti**
Floor-standing 2-drawer
bedside table

L 567 x H 389 x P 442

Comò 3 cassetti
3 drawers dresser

L 1217 x H 790 x P 542

Vedi a pagina 150 - 190
See page

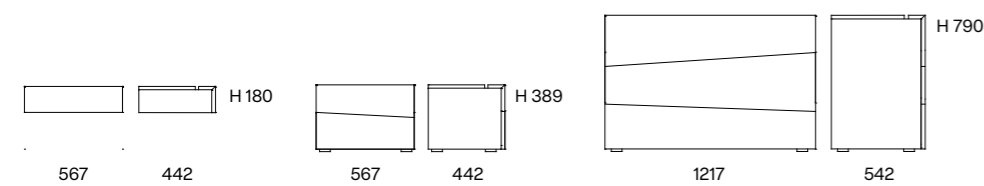

SETA

Gruppo - Suite



Dimensioni disponibili
Available sizes

**Comodino sospeso
1 cassetto**
Wall-hung 1-drawer
bedside table

L 704 x H 188 x P 492

Comodino 2 cassetti
2 bedside drawers

L 528 x H 471 x P 492
L 566 x H 481 x P 492

Comò 3 cassetti
3 drawers dresser

L 1232 x H 735 x P 492

Settimanale 5 cassetti
Weekly 5 drawers

L 528 x H 1087 x P 492

Vedi a pagina 132 - 260 - 266
See page

Le misure indicate sono comprensive di top 12 mm (standard) e piedini/basamenti. Il top può essere personalizzato (vedi listino) in sp. 30 o 60 mm.
Dimensions are including 12 mm th. top and legs\base. The top can be customized (see pricelist) with th. 30 or 60 mm.

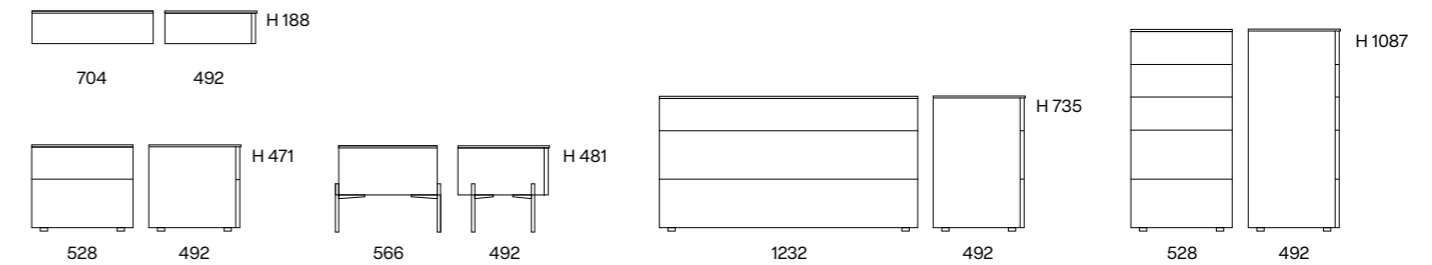

STREET

Gruppo - Suite



Dimensioni disponibili
Available sizes

Comodino 2 cassetti
2 bedside drawers

L 382 x H 502 x P 442
L 567 x H 432 x P 442

Comò 3 cassetti
3 drawers dresser

L 1217 x H 742 x P 542

Comò 5 cassetti
5 drawers dresser

L 1423 x H 742 x P 542

Vedi a pagina 64 - 138 - 206
See page

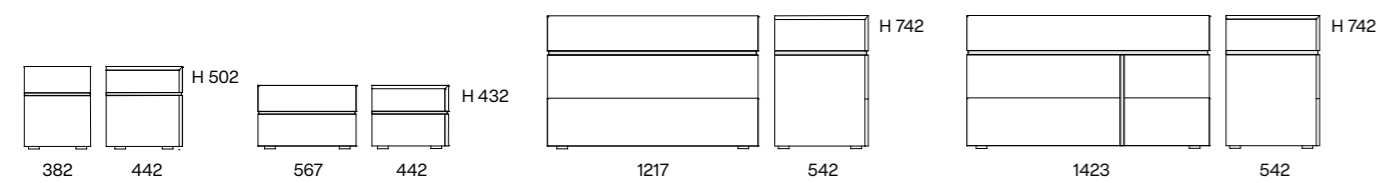

UNIX

Gruppo - Suite



Dimensioni disponibili
Available sizes

Comodino sospeso 1 cassetto
Wall-hung 1-drawer bedside table

L 704 x H 188 x P 487

Comodino 2 cassetti
2 bedside drawers

L 528 x H 478 x P 487

Comò 3 cassetti DX-SX
3 drawers dresser RH-LH

L 1760 x H 761 x P 487

Vedi a pagina 15 - 112 - 126 - 144 - 254 - 278 - 284
See page

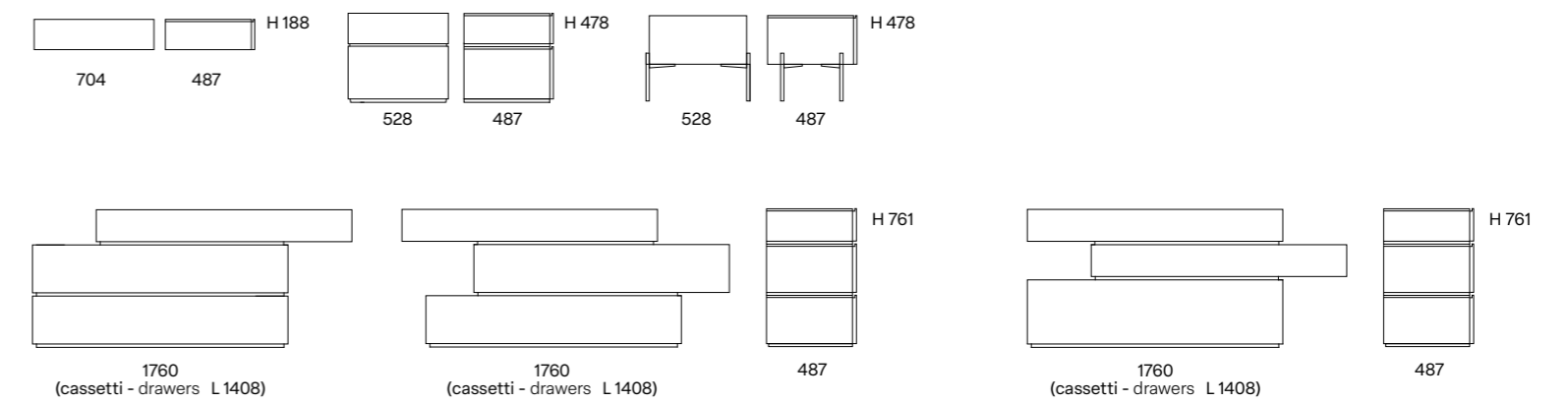

WAY

Gruppo - Suite



Dimensioni disponibili

Available sizes

Comodino 2 cassetti

2 bedside drawers

L 385 x H 478 x P 443
L 570 x H 368 x P 443

Comò 3 cassetti

3 drawers dresser

L 1220 x H 769 x P 543

Settimanale 6 cassetti

Weekly 6 drawers

L 570 x H 1063 x P 443

Vedi a pagina 90 - 174

See page

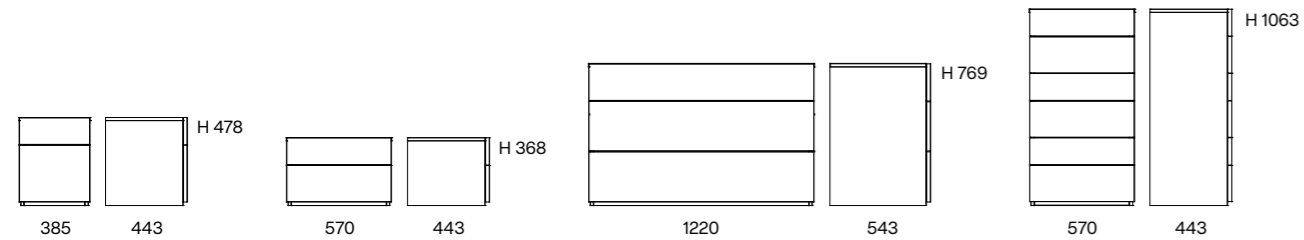

45°

Gruppo - Suite



Dimensioni disponibili

Available sizes

Comodino 2 cassetti

2 bedside drawers

L 602 x H 445 x P 442
L 417 x H 499 x P 417

Comò 3 cassetti

3 drawers dresser

L 1252 x H 774 x P 542

Vedi a pagina 40 - 84 - 104

See page

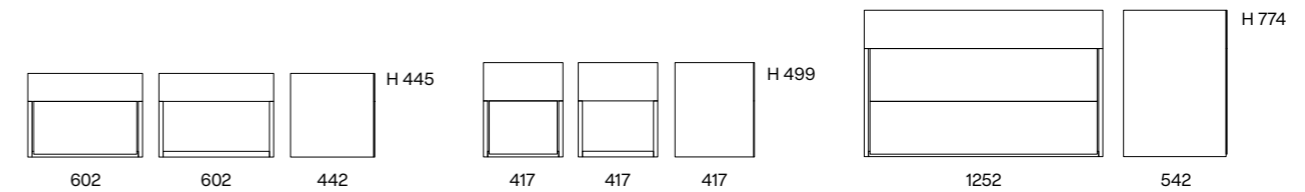

DRESS HOLDERS E TAVOLINI

Dress holders and bedside tables

01 - art. SL018
L 450 x P 300 x H 800 mm

02 - art. L0082
ø 450 x H 512 mm

03 - art. L0084
ø 750 x H 344 mm

04 - art. L0087
L 430 x P 420 x H 512 mm

05 - art. L0028
ø 450 x H 450 mm
art. L0029
ø 500 x H 580 mm

06 - art. L0086
ø 450 x H 512 mm

07 - art. AP010
L 350 x P 400 x H 1700 mm

08 - art. L0083
L 450 x P 450 x H 512 mm



POUF E CUSCINI

Pouf and pillows

I cuscini rendono la notte ancora più soft; i pouf arredano con una grande varietà di forme e colori: tanti elementi per completare la camera.

The cushions soften the look of the bedroom and the pouffes introduce different shapes and colours to the composition. Together they create the bedroom space.

POUF TONDI - Round pouffes

01 - art. SL073
ø 400 x H 450 mm

02 - art. SL072
ø 600 x H 360 mm

03 - art. SL040
ø 400 x H 460 mm

POUF QUADRATI - Square pouffes

04 - art. SL074
L 400 x P 400 x H 450 mm

05 - art. SL076
L 600 x P 600 x H 360 mm

CUSCINI - Cushions

06 - art. SL061
L 400 x L 400 x H 60 mm

07 - art. SL063
L 450 x L 450 x H 60 mm

08 - art. SL062
L 600 x L 300 x H 60 mm



POLTRONCINE

Armcharis

01 - art. SL064
L 630 x P 500 x H 940 mm
Seduta H 460 mm

02 - art. SL007
L 700 x P 650 x H 770 mm
Seduta H 460 mm

03 - art. SL080
L 730 x P 810 x H 590 mm
Seduta H 390 mm

04 - art. SL081
L 750 x P 620 x H 790 mm
Seduta H 430 mm

05 - art. SL022
L 620 x P 620 x H 790 mm
Seduta H 460 mm

06 - art. SL023
L 700 x P 500 x H 740 mm
Seduta H 460 mm



01



02



03



04



05



06

SPECCHIERE

Mirrors

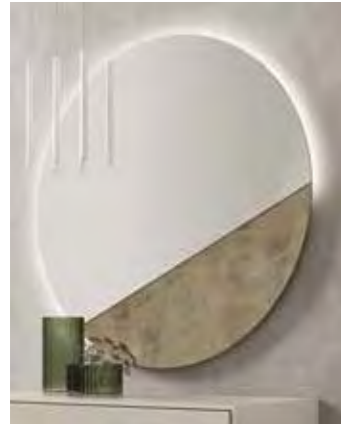

Globo

Ø 1200 - sp. 38 mm

Melaminico: cartella completa
Frassino colore / Laccato colore opaco
Laccato colore lucido / Impiallacciato /
Impiallacciato colore / Pressato /
Millerighe / Decor

Melamine: full colour chart
Coloured ash / Matt lacquered colour
Glossy lacquered colour / Veneered /
Colour veneered / Pressed /
Millerighe / Decor



Sfera

Ø 300 - Ø 500 - Ø 600 - sp. 26 mm



Tonda

Ø 1000 - sp. 26 mm



Ovale

L 1100 x H 700 - sp. 26 mm

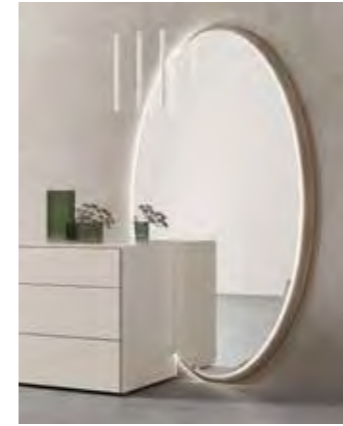

Bend dx-sx

L 1024 x H 1854 - sp. 32 mm

Laccato colore opaco e lucido
Matt and gloss colour lacquered



Fly dx-sx

L 520 x H 1750 - sp. 26 mm

Melaminico: cartella completa
Frassino colore / Laccato colore opaco
Laccato colore lucido / Impiallacciato /
Impiallacciato colore

Melamine: full colour chart
Coloured ash / Matt lacquered colour
Glossy lacquered colour / Veneered /
Colour veneered



Home

L 520 x H 1750 - sp. 22 mm

Melaminico: cartella completa
Frassino colore / Laccato colore opaco
Laccato colore lucido / Impiallacciato /
Impiallacciato colore

Melamine: full colour chart
Coloured ash / Matt lacquered colour
Glossy lacquered colour / Veneered /
Colour veneered



Menhir

L 920 x H 1800 - sp. 22 mm

Melaminico: cartella completa
Frassino colore / Laccato colore opaco
Laccato colore lucido / Impiallacciato /
Impiallacciato colore

Melamine: full colour chart
Coloured ash / Matt lacquered colour
Glossy lacquered colour / Veneered /
Colour veneered

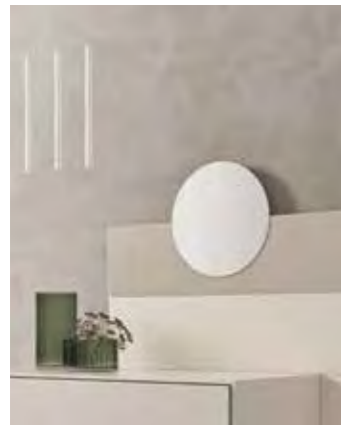

Seta

Ø 400 - sp. 38 mm



Lego

L 352 - 602 x H 752 x P 26 mm
L 352 x H 1202 x P 26 mm
L 452 x H 702 x P 26 - 852 x P 26 mm

Specchio - Bronzo filo lucido
Mirror - Polished edge Bronze



Pato

L 1200 x H 720 x P 80
L 720 x H 1800 x P 80

Melaminico: cartella completa
esclusi marmi
Frassino colore / Laccato colore opaco

Melamine: full colour chart
excluding marble
Coloured ash / Matt lacquered colour



Joy

L 1130 x H 640 - sp. 26 mm



Way

L 1200 x H 720 - sp. 22 mm

Melaminico: cartella completa
Frassino colore / Laccato colore opaco
Laccato colore lucido / Impiallacciato /
Impiallacciato colore

Melamine: full colour chart
Coloured ash / Matt lacquered colour
Glossy lacquered colour / Veneered /
Colour veneered



Scuderia

L 1100 x H 700 - sp. 52 mm

Impiallacciato / Impiallacciato colore
Veneered / Colour veneered



Sky

L 800 x H 960 - sp. 26 mm

Melaminico: cartella completa
Frassino colore
Laccato colore lucido

Melamine: full colour chart
Coloured ash wood
Coloured glossy lacquer

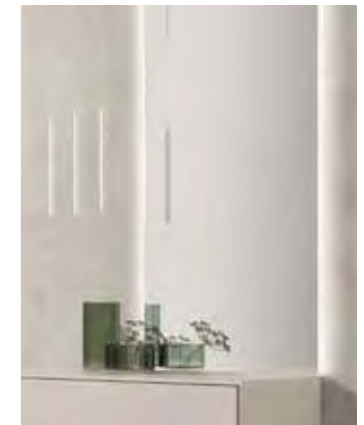

Filo

min. 264 x 264 mm
max. 2900 x 1300 - sp. 26 mm

A richiesta con luci led
retroilluminanti

On request, with LED
backlighting

MOOD & — INSPIRATIONS

Un compendio visivo di colori e materiali, di texture e finiture, per guidare accostamenti che infondono carattere e stile alla camera da letto.

A visual compendium of colours, materials, textures and finishes helps you create a bedroom with character and style.

MOOD & — INSPIRATIONS

Le venature del gres dialogano con nuance calde e delicati, dando vita a composizioni che interpretano la zona notte in chiave moderna e personale.

The stoneware vein draws on other warm, delicate nuances to create compositions that give your bedroom a modern, personal touch.

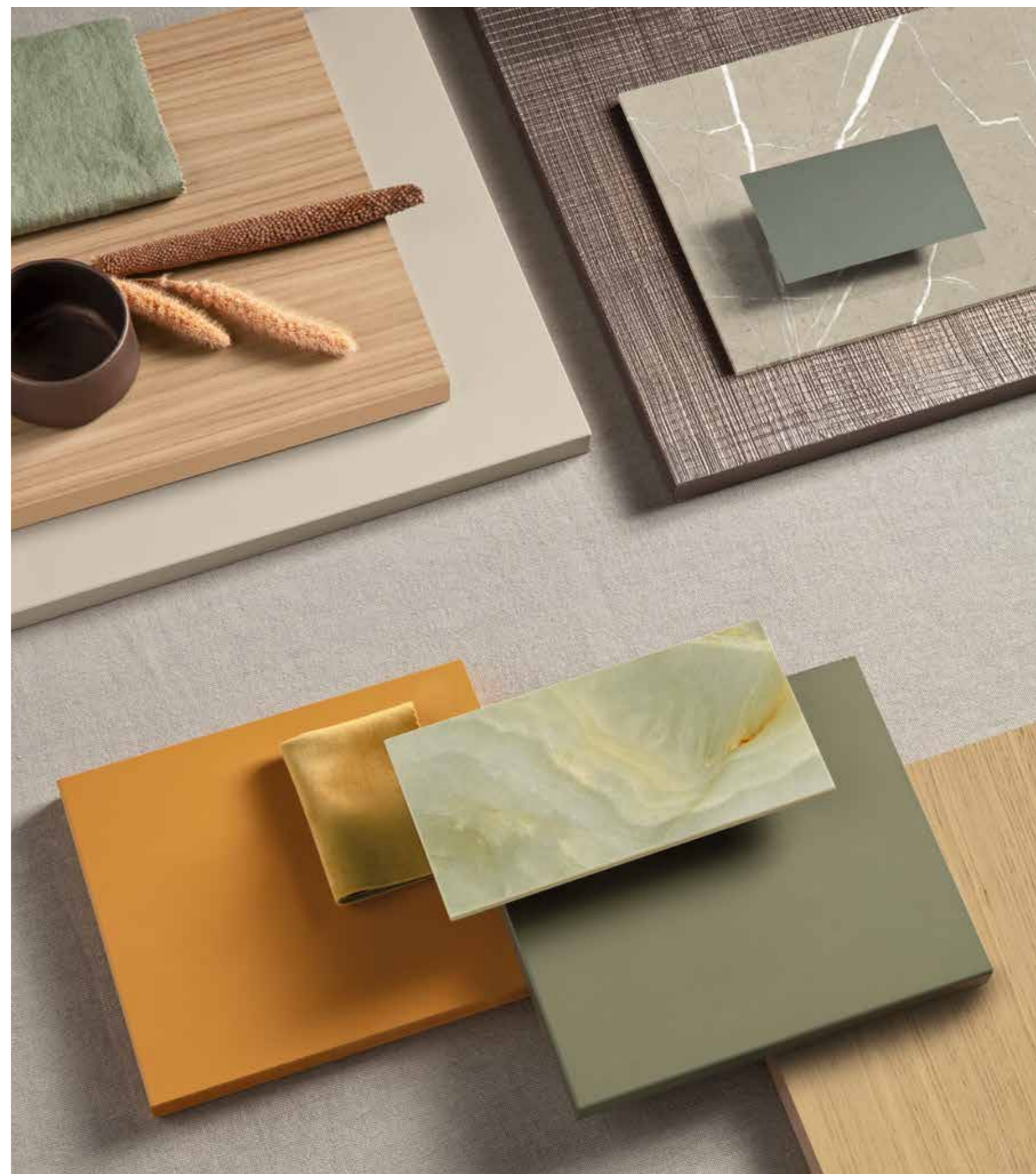

MOOD & —
INSPIRATIONS

Melaminici Essenza
Wood Melamine

Vetri
Glass

Colori laccati
Lacquered colours

Centorighe

Gres

Tessuti
Fabrics

MOOD & —
INSPIRATIONS

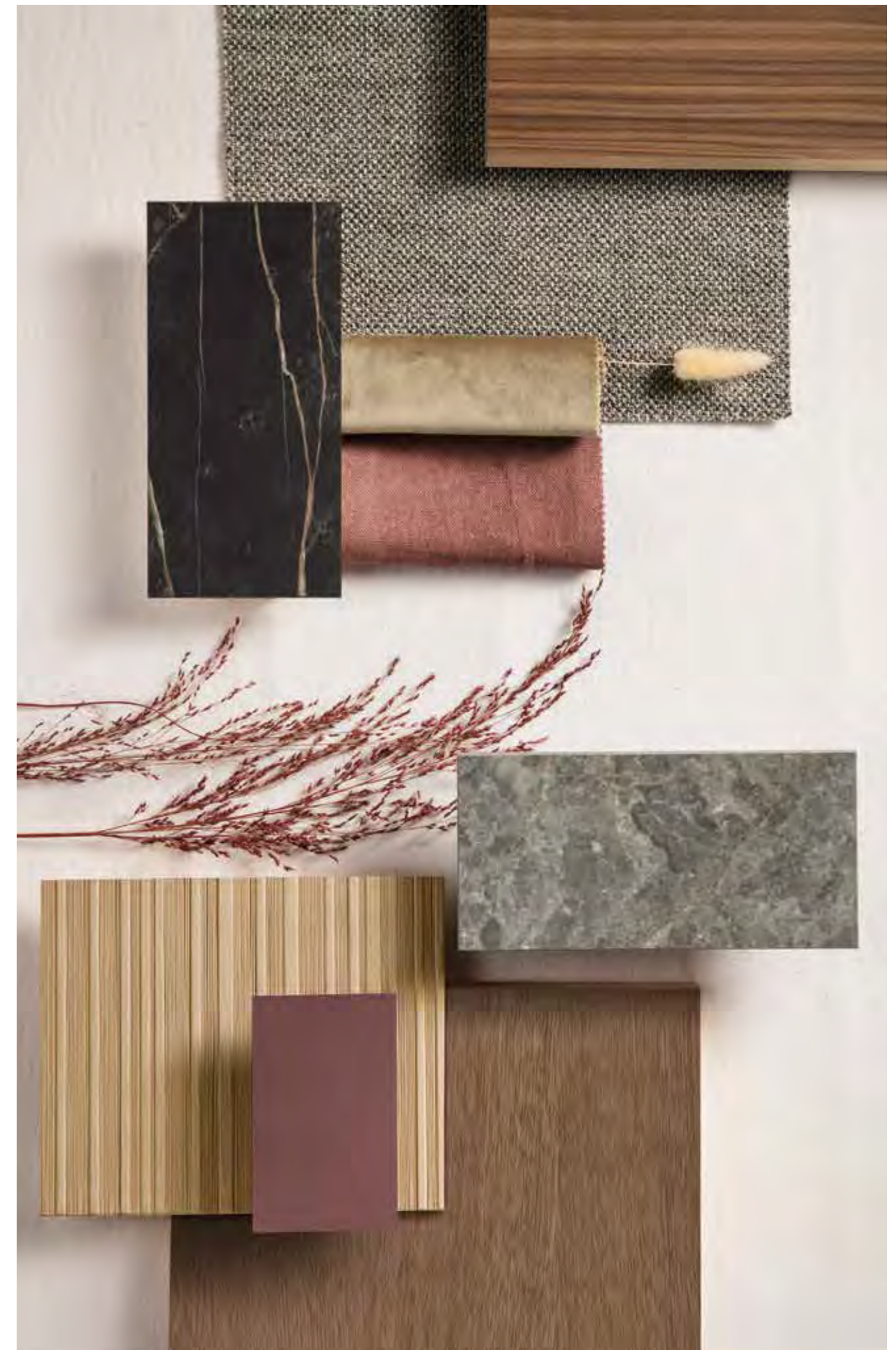

MOOD & — INSPIRATIONS

Un piacevole equilibrio si rivela nelle essenze del legno, nelle finiture del vetro, nei toni metallizzati e nella tattilità dei tessuti, in abbinamenti di sorprendente armonia.

Combine wood grain, glass finishes, metallic tones and tactile textiles in a surprisingly harmonious way to create a pleasant balance.

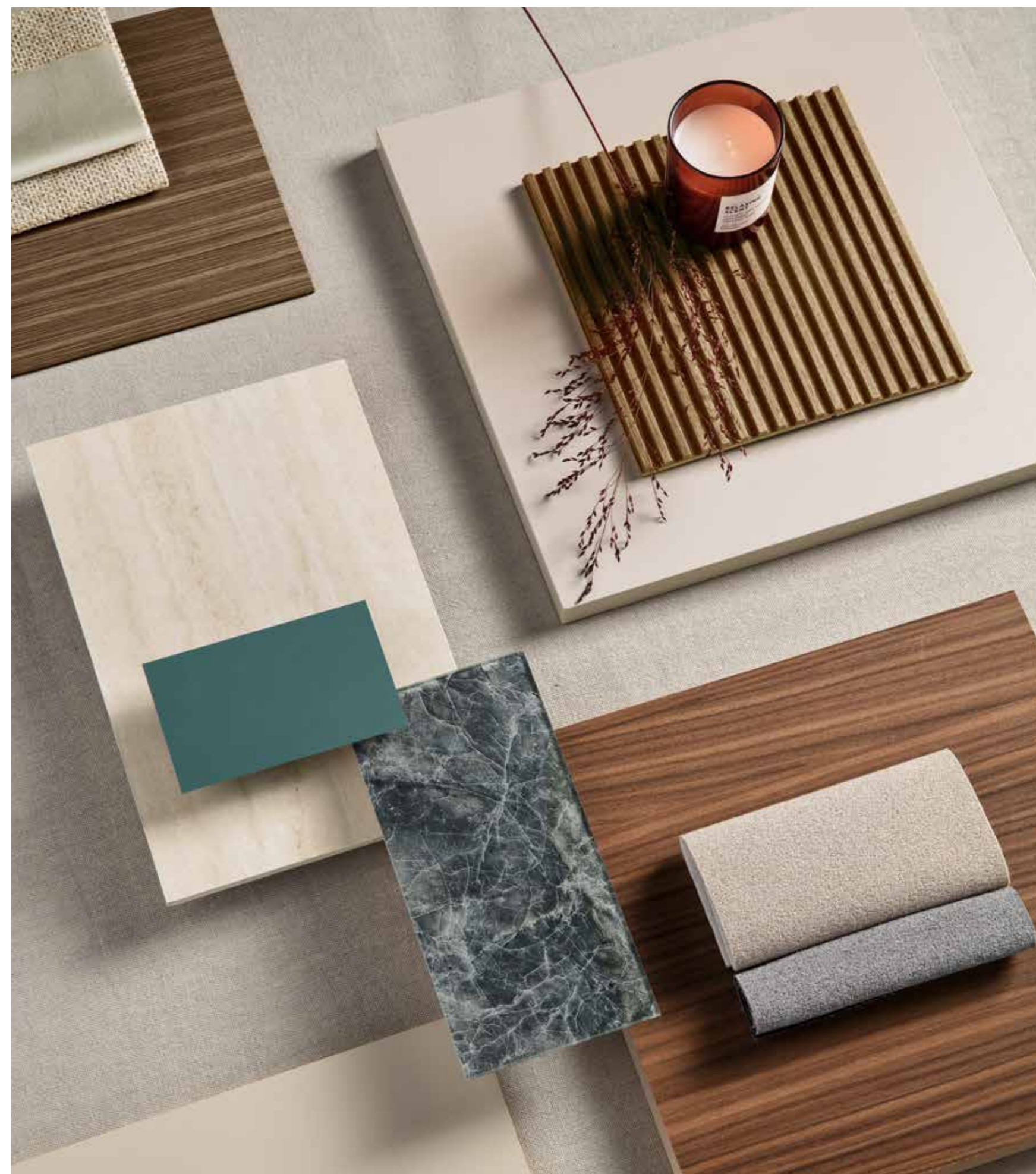

**MOOD & —
INSPIRATIONS**

Melaminici Essenza
Wood Melamine



Gres

Impiallacciati
Veneered



Vetri
Glass

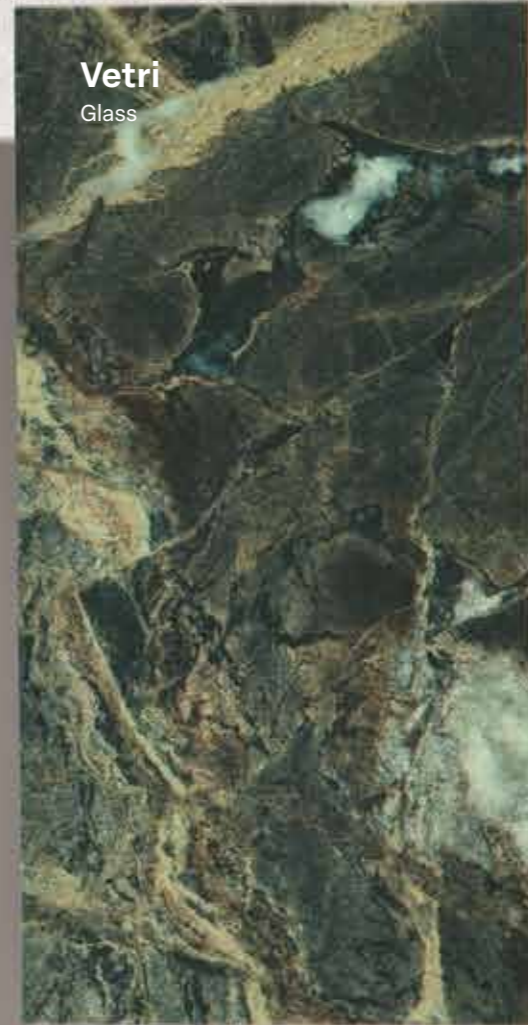

Tessuti
Fabrics



Colori laccati
Lacquered colours



Metallizzato
Metallic



FINITURE

Finishes

Melaminici Essenza - Wood Melamine



Olmo Artico



Olmo Tabacco

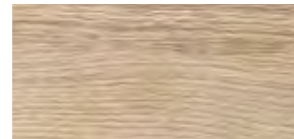

Rovere Nodato



Rovere Nordico



Rovere Thea



Frassino Bianco

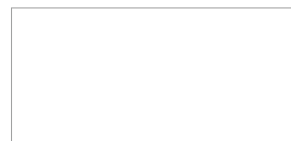

Bianco

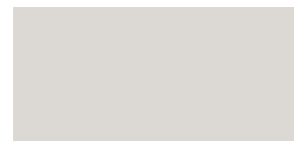

Ghiaccio



Cashmere



Sabbia



Grafite

Melaminici Marmo - Marble Melamine

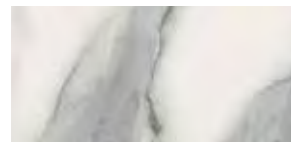

Calacatta



Ash Stone

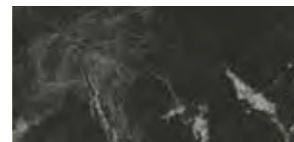

Nero Marquinia

Melaminici Cemento - Cement Melamine

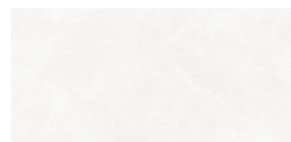

Cemento Bianco

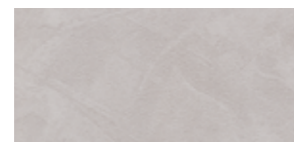

Cemento Grigio

Impiallacciati - Veneered



Miele



Nocciola



Grigio



Cacao

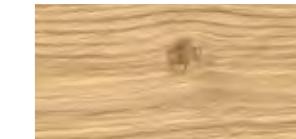

Scuderia

Disponibili in tutti i colori laccati opachi
Available in all matt lacquered colours

Pressato - Pressed



Pressato Miele

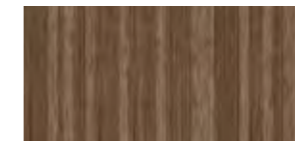

Pressato Nocciola



Pressato Grigio



Pressato Cacao



Pressato*

* Disponibili in tutti i colori laccati opachi
* Available in all matt lacquered colours

Centorighe

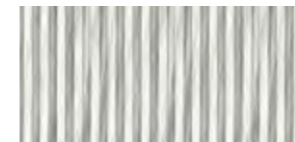

Disponibili in tutti i colori laccati opachi
Available in all matt lacquered colours

Millerighe



Disponibili in tutti i colori laccati opachi
Available in all matt lacquered colours

FINITURE

Finishes

Vetri - Glass



Deserto



Natura



Aria



Abisso



Eclisse

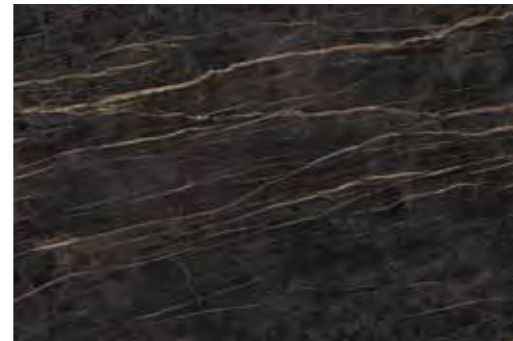

Carbone

Vetri colorati - Colored glass

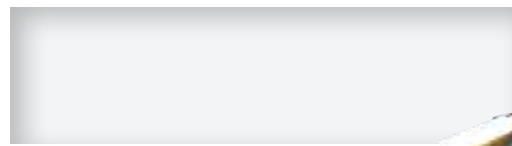

Disponibili in tutti i colori laccati opachi
Available in all matt lacquered colours

Gres



Travertino Navona



Golden White



Onice Giada



Ceppo di Grè Grey



Gris du Gent



Emperador



Frassino colore / Colori laccati lucidi e opachi - Ash wood colours / Glossy and matt lacquered colours

Bianco	Ecrù	Ghiaccio	Grigio Pietra	Agata	Taupe
Titanio	Carta da Zucchero	Cenere	Magma	Grafite	Antracite
Nero	Verde Bosco	Verde Militare	Verde Oliva	Verde Palude	Salvia
Pluvia	Celeste	Ceruleo	Navy	Petrolio	Giallo Polline
Melograno	Rosso Lips	Bordeaux	Porpora	Cipria	Rosa Vintage
Tigre	Cotto	Castagno	Terra	Sabbia	Cashmere
Terranova	Brown				
Bronzo Metallizzato	Ottone Metallizzato	Champagne Metallizzato	Nichel Metallizzato	Ferro Metallizzato	Manganese Metallizzato

Colori laccati utilizzabili in abbinamento con Impiallacciati, Pressati e Centorighe
 Lacquered colours options in combination with Veneered, Pressed and Centorighe finishes

Miele	Nocciola	Grigio	Cacao

Serigrafia disponibile solo per gruppo Gardenia in 4 colorazioni: Bianco - Cashmere - Sabbia - Magma
 Screen printing is only available for the Gardenia suite in 4 colours: Bianco - Cashmere - Sabbia - Magma

Serigrafia 03B Bianco Cashmere Sabbia Magma	Serigrafia 04B Bianco Cashmere Sabbia Magma

Tessuti - Fabrics



Tessuti Lino - Flax Fabrics

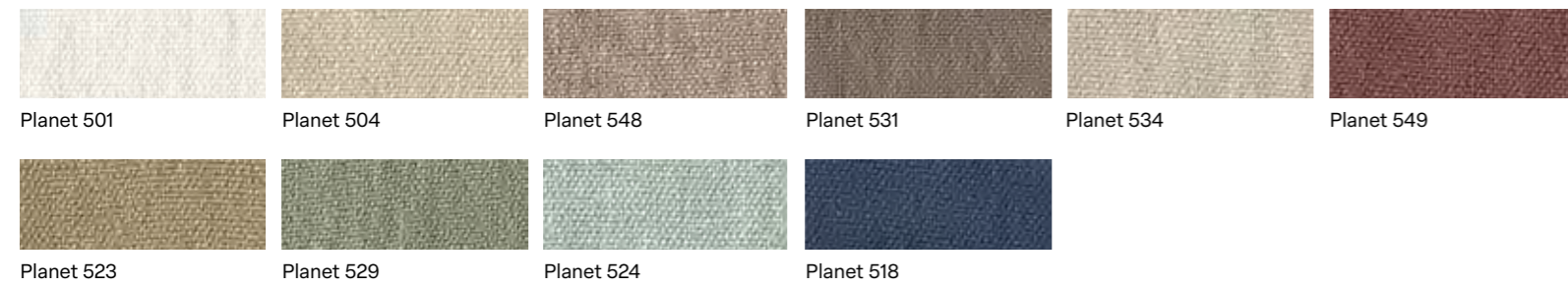

Tessuti Plus - Plus Fabrics



Ecopelli - Eco-leathers



Ecopelli Gold - Gold Eco-leathers



Finiture Decor - Decor Finishes

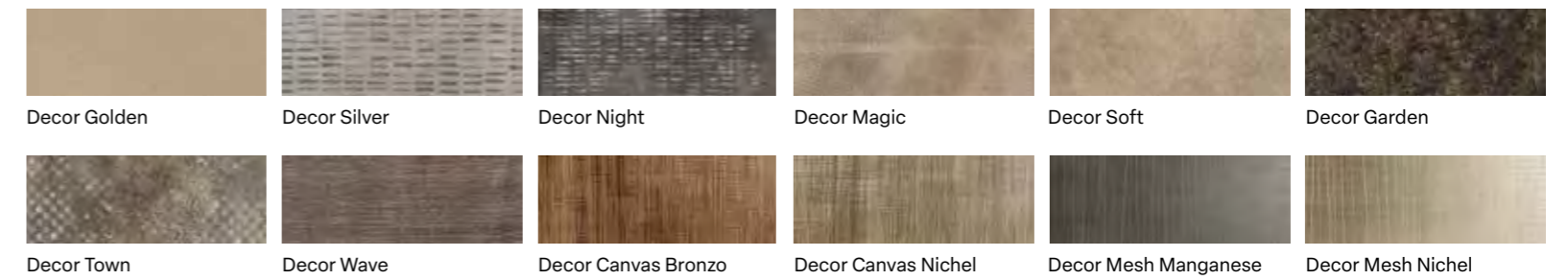

CARTE DA PARATI

Wallpapers

01 - MODERN

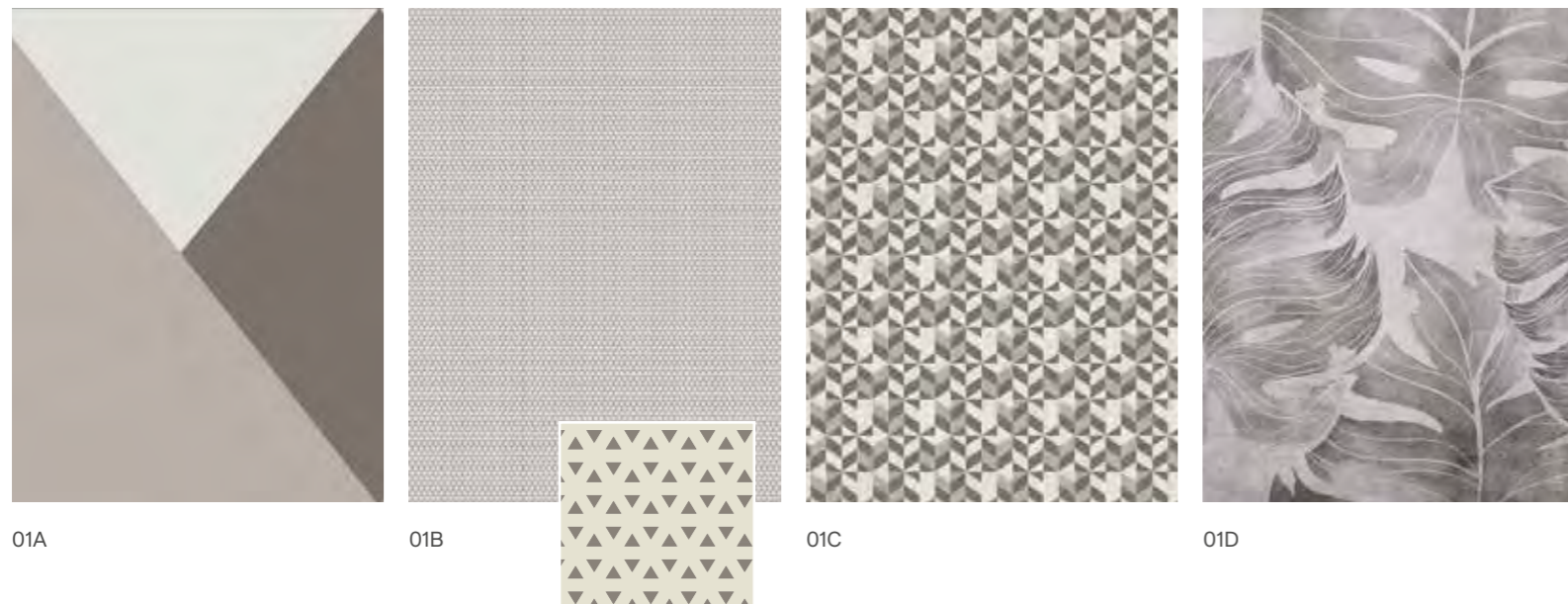

03 - TEXTURE

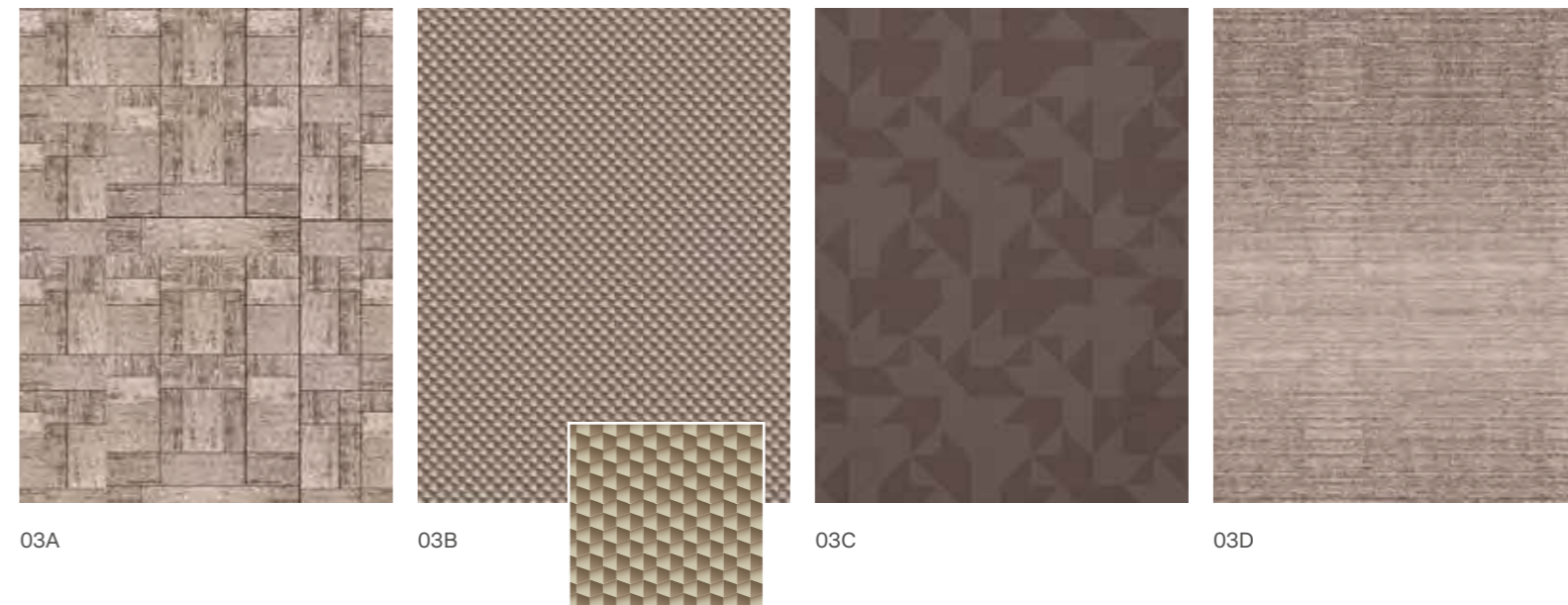

02 - MIX

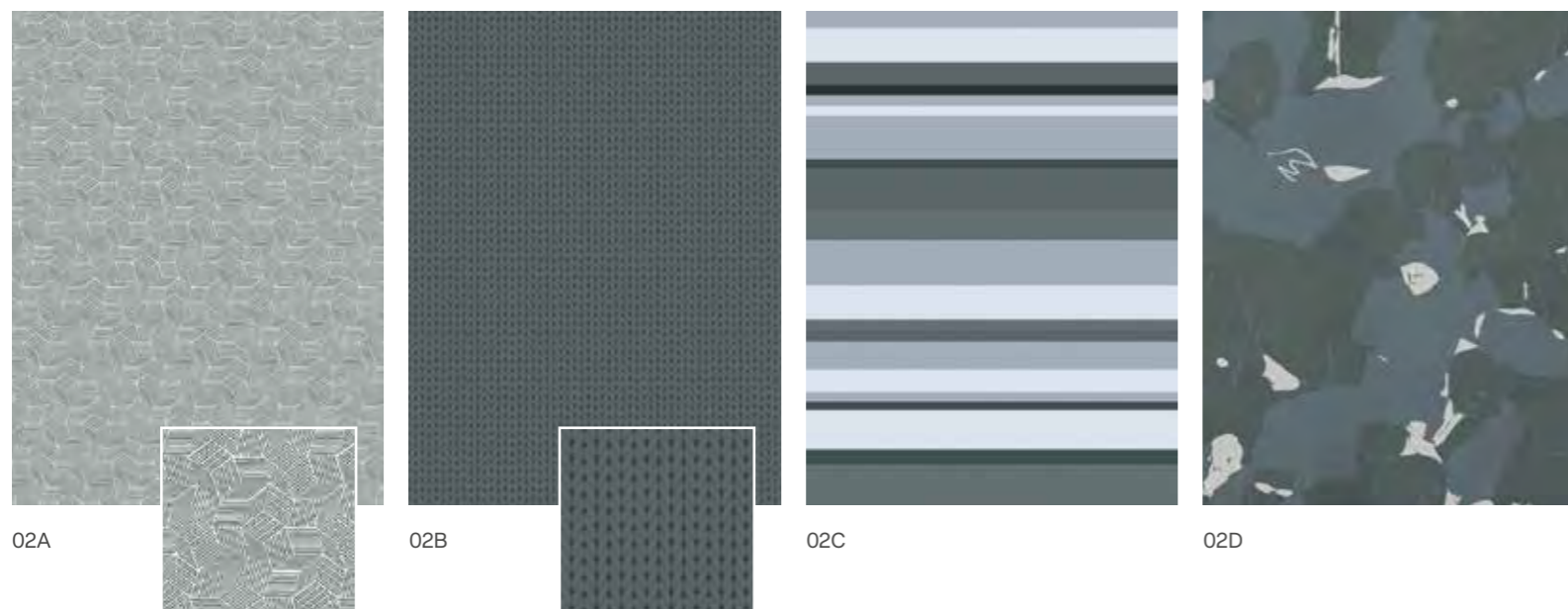

04 - ELEGANCE

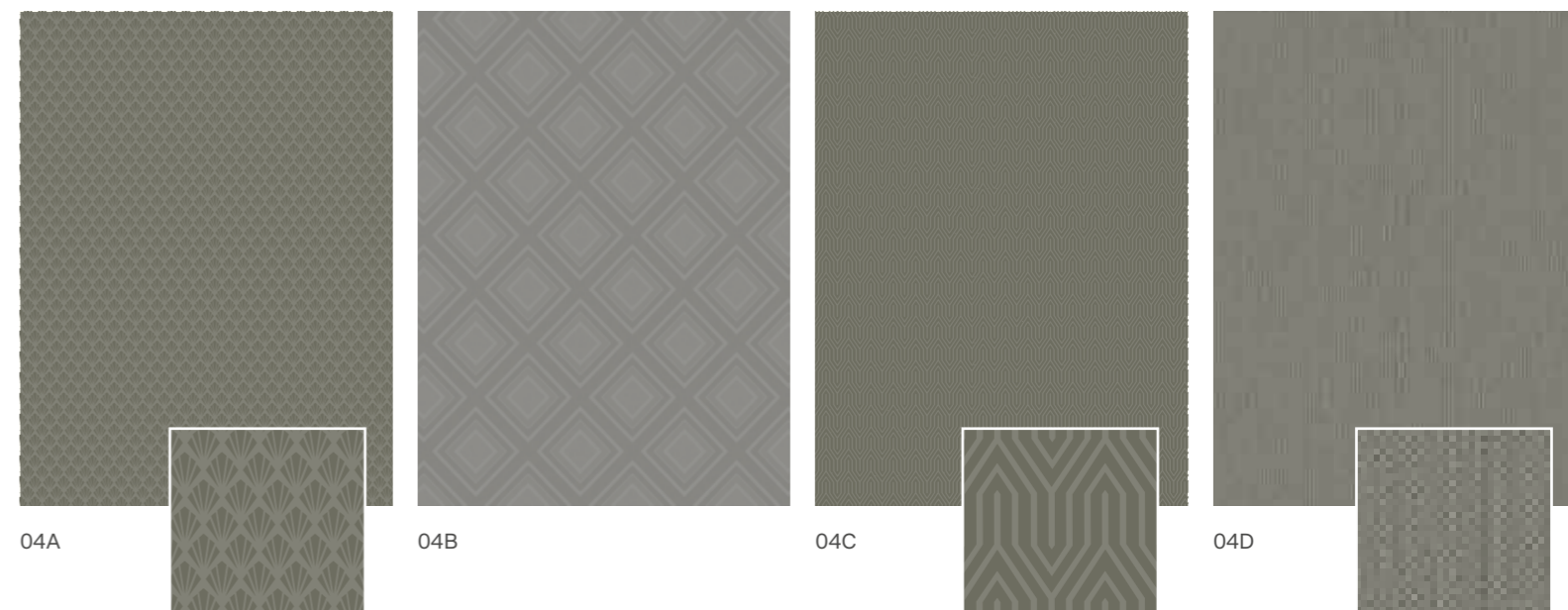

Cambio colore - Change color

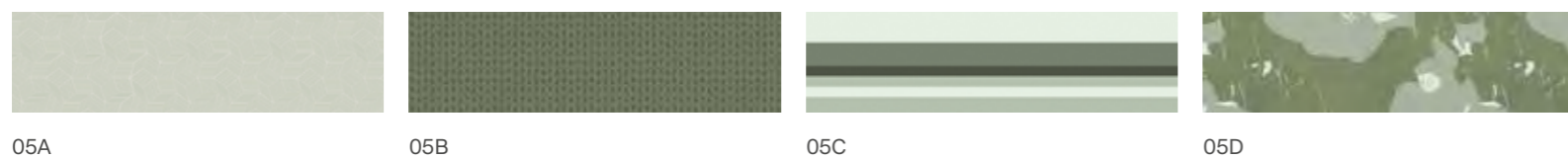

CARTE DA PARATI

Wallpapers



Risonanze



Miami



Orbitali



Fioriture



Lettering



Affresco



Geometrici

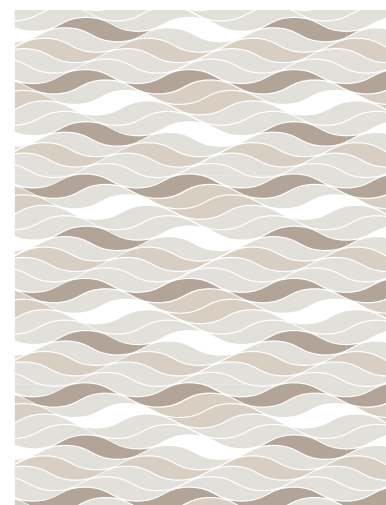

Onda



Cuore



Rombi



Anni 50



Spina pesce



Iride



Iride b/n



Marrakesh



Piume

La carta da parati viene fornita in rotoli da L 600 mm, altezza massima disponibile H 3000 mm. Compresa di colla per il fissaggio alla parete.

The wallpaper is supplied in 600 mm wide rolls, maximum length 3000 mm. Provided with glue to apply it to the wall.

Scegli il colore dalla mazzetta laccati "Maronese ACF®"

Choose the colour from the "Maronese ACF®" lacquer fan-deck

Thank you

Design & Coordination
Maronese Acf® - F100

Technical consulting
Loris Biasatti

Art direction & Graphic Design
Lokomotiv

Photo & Render
Indoor

Colour separation
Lucegroup.it

Print
Lucegroup.it

2025

MARONESE ACF®

MARONESE INTERNATIONAL SRL Via Taglio 60, 33070 Maron di Brugnera (PN) Italy
T. +39 0434 623421 - F. +39 0434 623695

info@maroneseacf.it www.maroneseacf.com

maroneseacf.com