

GLOW

HENGE

MADE IN ITALY

GLOW

HENGE LIGHTING COLLECTION

HENGE

MADE IN ITALY



28	Abaco	232	Pipe S
126	AirLight	238	Skyfall
32	Arcade		
138	Bat	44	Spyder
		250	Spyder 80
144	Crystal	244	Spyder X
150	Crystal Evo	254	Spyder XS
154	Crystal XL		
		110	Stalagmite
92	Flat		
96	Flat Table	260	Starlight
		266	Starlight Horizontal
158	Floyd	272	Superb-All
86	Floyd T	276	Superb-All Horizontal
80	Floyd W	282	Superb-All Horizontal Evo
164	Floyd Seven		
170	Gatsby	286	Tape
176	Ghost	50	Tape Wall
100	Ghost Lamp		
48	Gladio	292	Tele
180	Go go go		
184	Helix	114	Test One
70	Legacy	120	Test Two
		126	Test Tree
188	Light Ring	298	Tubular
194	Light Ring Horizontal	296	Tubular Single
202	Light Ring Horizontal XS	306	Tubular Floor to Ceiling
208	Light Ring Horizontal Polygonal	56	Tubular Wall
216	Light Ring Horizontal Polygonal Evo	302	Tubular Horizontal
222	Light 5 Ring Multimateric		
226	Maple	60	Wall Clips
106	Pipe L	64	Vibe

"IN THE RIGHT LIGHT, AT THE RIGHT TIME,
EVERYTHING IS EXTRAORDINARY." — AARON ROSE



Henge is proud to present "Glow," our exclusive lighting collection. Light and matter intertwine to form unique creations, transforming spaces with the elegance and character that are the essence of our brand. A collection where each piece is a masterpiece, seamlessly blending Italian craftsmanship with research and technological innovation. Allow yourself to be inspired by the timeless beauty of our lights, thoughtfully designed to evoke deep emotions and illuminate your daily life.

Henge is a brand renowned for its meticulous research into rare and exceptional materials, masterfully transformed into exquisite furniture, home accessories, and lighting. Founded in 2011 in Italy's Veneto region by visionary entrepreneur and CEO Paolo Tormena, Henge has quickly become a benchmark for refined and innovative interior design. From the very beginning, Henge has been dedicated to preserving the art of craftsmanship, collaborating with local artisans and specialized workshops. This approach allows the brand to push the boundaries of raw materials, achieving unattainable results through industrial processes.

Henge's collections stand out for their meticulous material research and innovative craftsmanship, resulting in a curated selection of rare and exceptional stones, marbles, metals, and woods. Among these, is the Breccia Medicea dell'Acqua Santa, a remarkably rare marble famously used by the Medici family during the Renaissance to embellish European churches. Over the years, Henge has collaborated with esteemed international designers, including Massimo Castagna, Yabu Pushelberg, and Ugo Cacciatori, whose visionary contributions have played a significant role in defining the brand's identity.

Henge continues to expand its global presence with the opening of flagship showrooms in key cities, including Henge London and Henge Miami, with Henge Dubai and Henge Venice set to launch soon. The Milan showroom at Via della Spiga 34 remains a cornerstone, serving as a showcase for the brand's new collections during the prestigious Design Week and beyond.

Sustainability is also at the core of Henge's philosophy. In 2024, the brand opened the Henge Factory, a transformative project revitalizing a disused industrial area—once dominated by excessive concrete and asbestos—into a harmonious, nature-inspired space. This initiative reflects Henge's commitment to blending exceptional design with environmental responsibility.





LIGHT SCULPTURES WITH AN UNMISTAKABLE DESIGN.

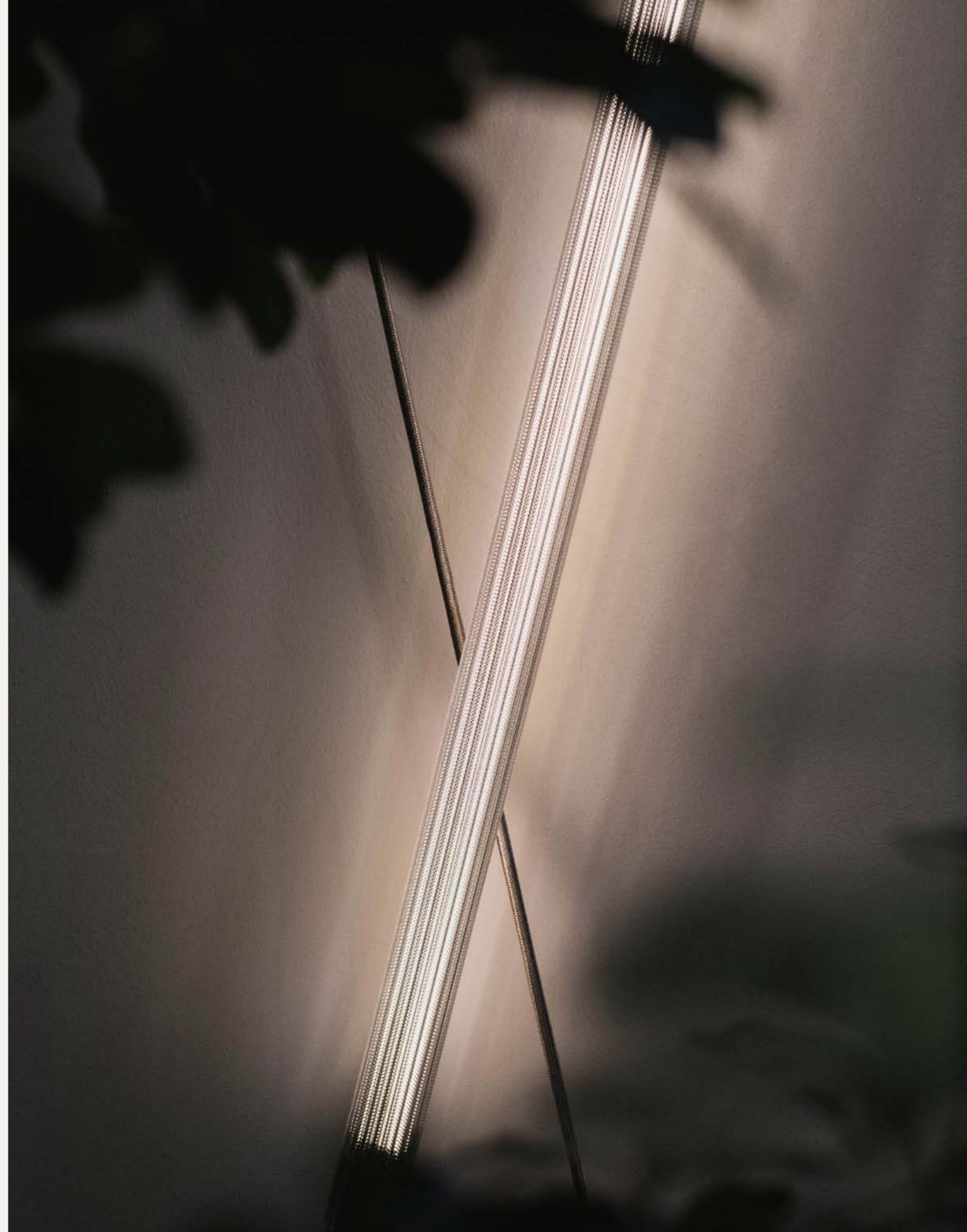
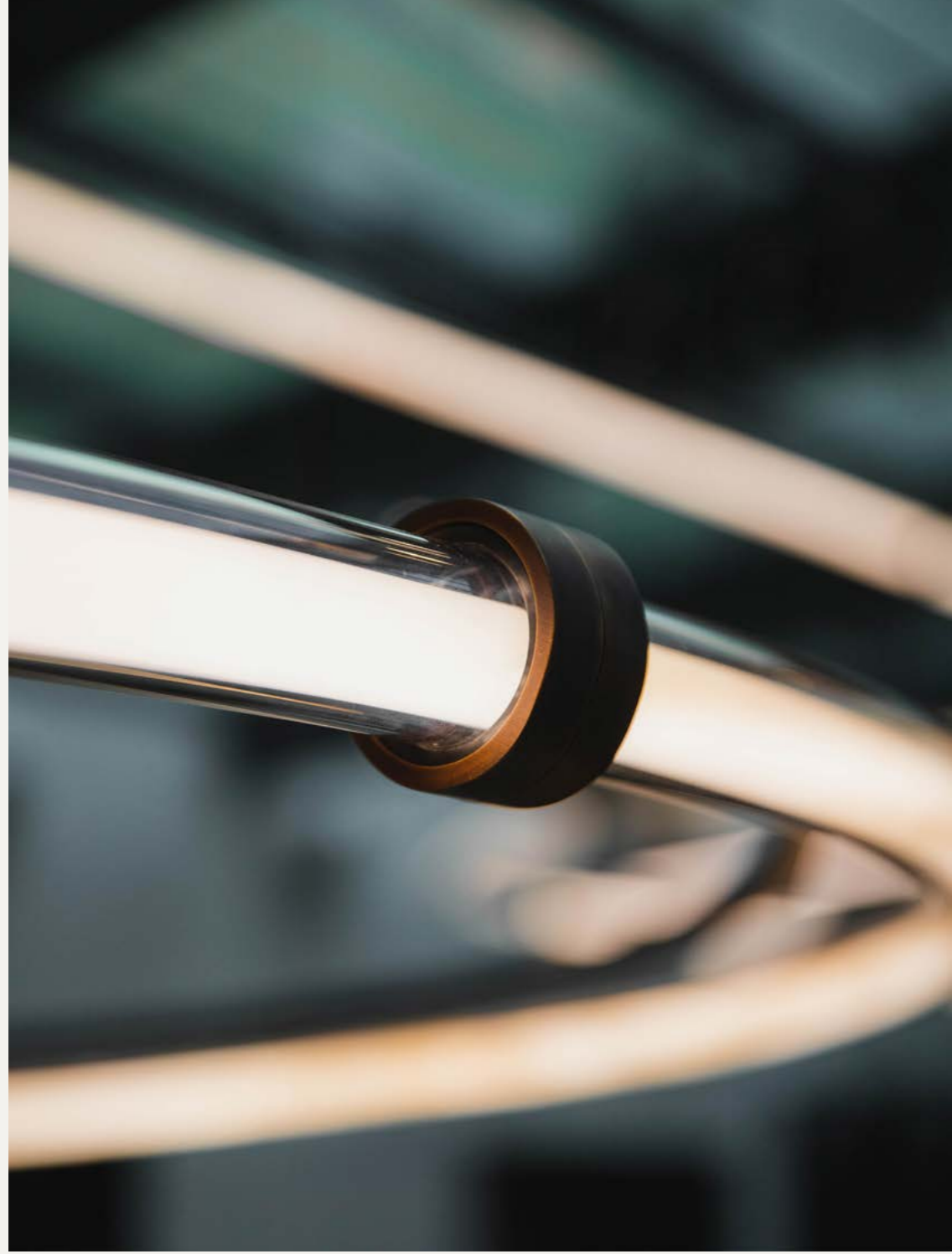



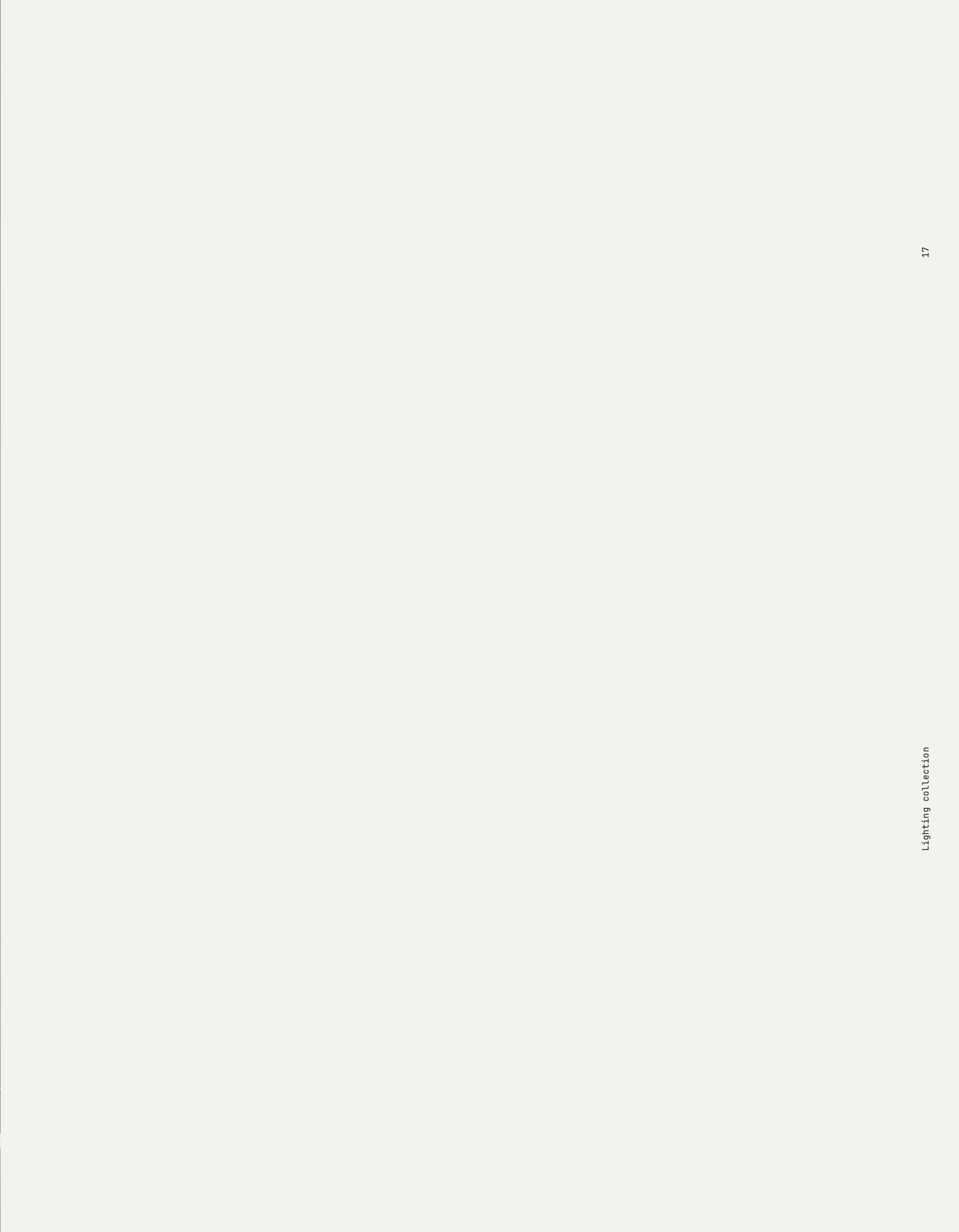





PRODUCTS OVERVIEW

WALL LIGHTS

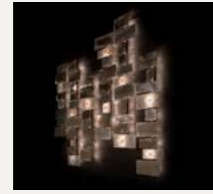

Abaco p. 28



Arcade p. 32

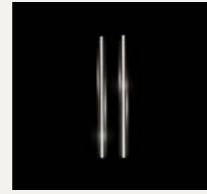

Gladio p. 48



Spyder p. 44



Tape Wall p. 50



Tubular Wall p. 56

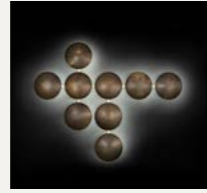

Wall Clips p. 60



Vibe p. 64

TRACK LIGHTING



Legacy p. 70

TABLE AND FLOOR LAMPS



Floyd W p. 80

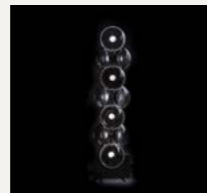

Floyd T p. 86



Flat p. 92



Flat Table p. 96



Ghost Lamp p. 100

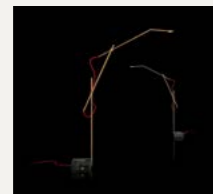

Pipe L p. 106



Stalagmite p. 110



Test-One p. 114



Test-Two p. 120



Test-Tree p. 126

CHANDELIERS



Airlight p. 134

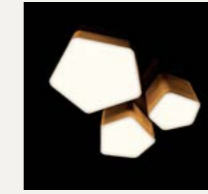

Bat p. 138



Crystal p. 144

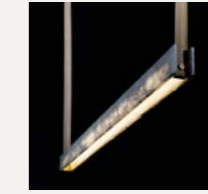

Crystal Evo p. 150

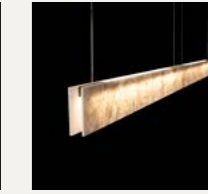

Crystal XL p. 154



Floyd p. 158

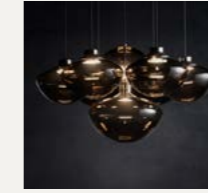

Floyd Seven p. 164



Gatsby p. 170



Go go go p. 180

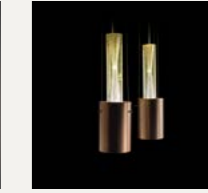

Ghost p. 176



Helix p. 184



Light Ring p. 188



Light Ring Horizontal p. 194



Light Ring Horizontal XS p. 202

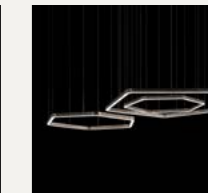

Light Ring Horizontal Polygonal p. 208



Light Ring Polygonal Evo p. 216



Light Ring 5 Multimateric p. 222

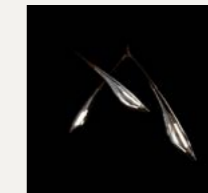

Maple p. 226



Pipe S p. 232

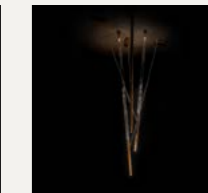

Skyfall p. 238



Spyder X p. 244

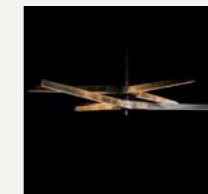

Starlight p. 260

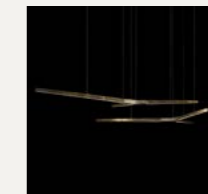

Starlight Horizontal p. 266

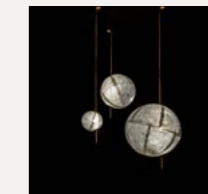

Superb-All p. 272

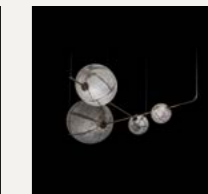

Superb-All Horizontal p. 276

PRODUCTS OVERVIEW

CHANDELIERS



Superb-All
Horizontal Evo p. 282



Spyder 80 p. 250



Spyder XS p. 254



Tape p. 286



Tele p. 292



Tubular p. 298



Tubular Single p. 296



Tubular
Horizontal p. 302



Tubular
Floor to Ceiling p. 306

NOTES For indoor use only. These items are carefully crafted by skilled artisans, who devote meticulous care to their creation. As a result of their handmade and hand-finished nature, variations in the marble, metal, or woodwork are to be expected and celebrated. Each piece is unique and possesses its own individuality, ensuring that no two are exactly alike.

NOTE Solo per uso interno. Questi articoli sono realizzati con cura da abili artigiani, che dedicano meticolosa attenzione alla loro creazione. La loro natura artigianale e rifinita a mano prevede variazioni nel risultato finale di marmo, metallo o legno. Ogni articolo è unico e possiede una propria autenticità, assicurando che non esistano due pezzi esattamente uguali.**



WALL LIGHTS

ABACO

WALL LIGHT



Light and matter conspire, forging together an ironic and elegant artistic statement. Metal modules, aligned and alternated with White Crystal stone pieces of different irregular sizes, compose a faceted pattern animated by beams of light intriguingly radiating from the intersections.

Luce e materia cospirano, dando vita insieme ad un gesto artistico ironico ed elegante. Moduli metallici, allineati ed intervallati a tasselli in White Crystal stone di diverse dimensioni, compongono un ordito sfaccettato animato dalla luce che intrigante si sprigiona dalle intersezioni.

DESIGNER
Massimo Castagna

DETAILS

- Wall light available in 4 different configurations.
- Energy-saving with warm light (energy efficiency index A).
- Metal structure with rectangular tiles available in different finishes including White Crystal stone and metal.
- Transformer must be placed remotely.

LIGHT SOURCE

- LED 24 V - 3000 K.
- Upon request available with extra warm light 2700 K.
- Available 110 V upon request.
- Dimming function included.

DETTAGLI

- Luce da parete disponibile in 4 configurazioni.
- Risparmio energetico con luce calda (efficienza energetica di tipo A).
- Struttura in metallo con piastre rettangolari disponibile con diverse finiture che includono: White Crystal e metallo.
- Il trasformatore deve essere posizionato a remoto.

FONTE LUMINOSA

- LED 24 V 3000 K.
- Su richiesta disponibile con luce extra calda a 2700 K.
- Disponibile 110 V su richiesta.
- Dimmerabile

CONSTRUCTION SPECIFICATION

Weight: 7.5-9 kg
Material: Stone, Metal
Finish:
• Burnished Titanio, White Crystal, Burnished Platino
• Burnished Brass, White Crystal, Black Burnished Brass
• Silver Patina, White Crystal, H-Silver Black
• Burnished Titanio, White Crystal, H-Pale Gold

Certified Product
Prodotto certificato

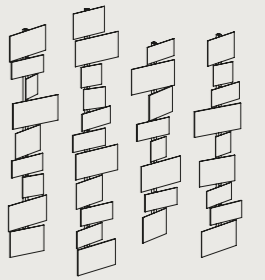

TECHNICAL DATA

Net Weight: 7.5 kg
Light source: LED-technology 24 V
Input Voltage [V]: 220-240 V or 110-120 V upon request
Max Power [W]: 5.6 W
Light colour [K]: 3000 K or 2700 K upon request
Flux [lm]: 2700 K - 360 lm / 3000 K - 379 lm**
CRI: >90
Dimming: Push / Phase cut / 0-10 V / 1-10 V / DMX / DALI-2 dimmable

Abaco
8 Elements

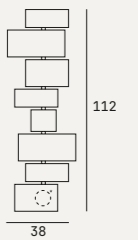

TECHNICAL DATA

Net Weight: 8.3 kg
Light source: LED-technology 24 V
Input Voltage [V]: 220-240 V or 110-120 V upon request
Max Power [W]: 6.3 W
Light colour [K]: 3000 K or 2700 K upon request
Flux [lm]: 2700 K - 405 lm / 3000 K - 426 lm**
CRI: >90
Dimming: Push / Phase cut / 0-10 V / 1-10 V / DMX / DALI-2 dimmable

Abaco
9 Elements

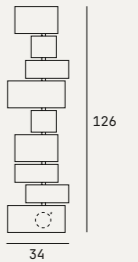

TECHNICAL DATA

Net Weight: 8.4 kg
Light source: LED-technology 24 V
Input Voltage [V]: 220-240 V or 110-120 V upon request
Max Power [W]: 6.3 W
Light colour [K]: 3000 K or 2700 K upon request
Flux [lm]: 2700 K - 405 lm / 3000 K - 426 lm**
CRI: >90
Dimming: Push / Phase cut / 0-10 V / 1-10 V / DMX / DALI DALI-2 dimmable

Abaco
9 Elements

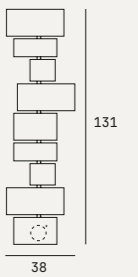

TECHNICAL DATA

Net Weight: 9 kg
Light source: LED-technology 24 V
Input Voltage [V]: 220-240 V or 110-120 V upon request
Max Power [W]: 7.7 W
Light colour [K]: 3000 K or 2700 K upon request
Flux [lm]: 2700 K - 495 lm / 3000 K - 521 lm**
CRI: >90
Dimming: Push / Phase cut / 0-10 V / 1-10 V / DMX / DALI-2 dimmable Other dimming options on demand.

Abaco
11 Elements

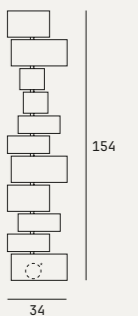

**Output of led inside the lamp. Losses due to diffusor and reflectors are not considered. Values are indicative, ambient temperature, height and position of the lamp may vary the values.
**Emissione del LED all'interno della lampada. Le perdite dovute a diffusore e riflettori non sono considerate. I valori sono indicativi: temperatura ambiente, altezza e posizione della lampada possono influenzare i valori.



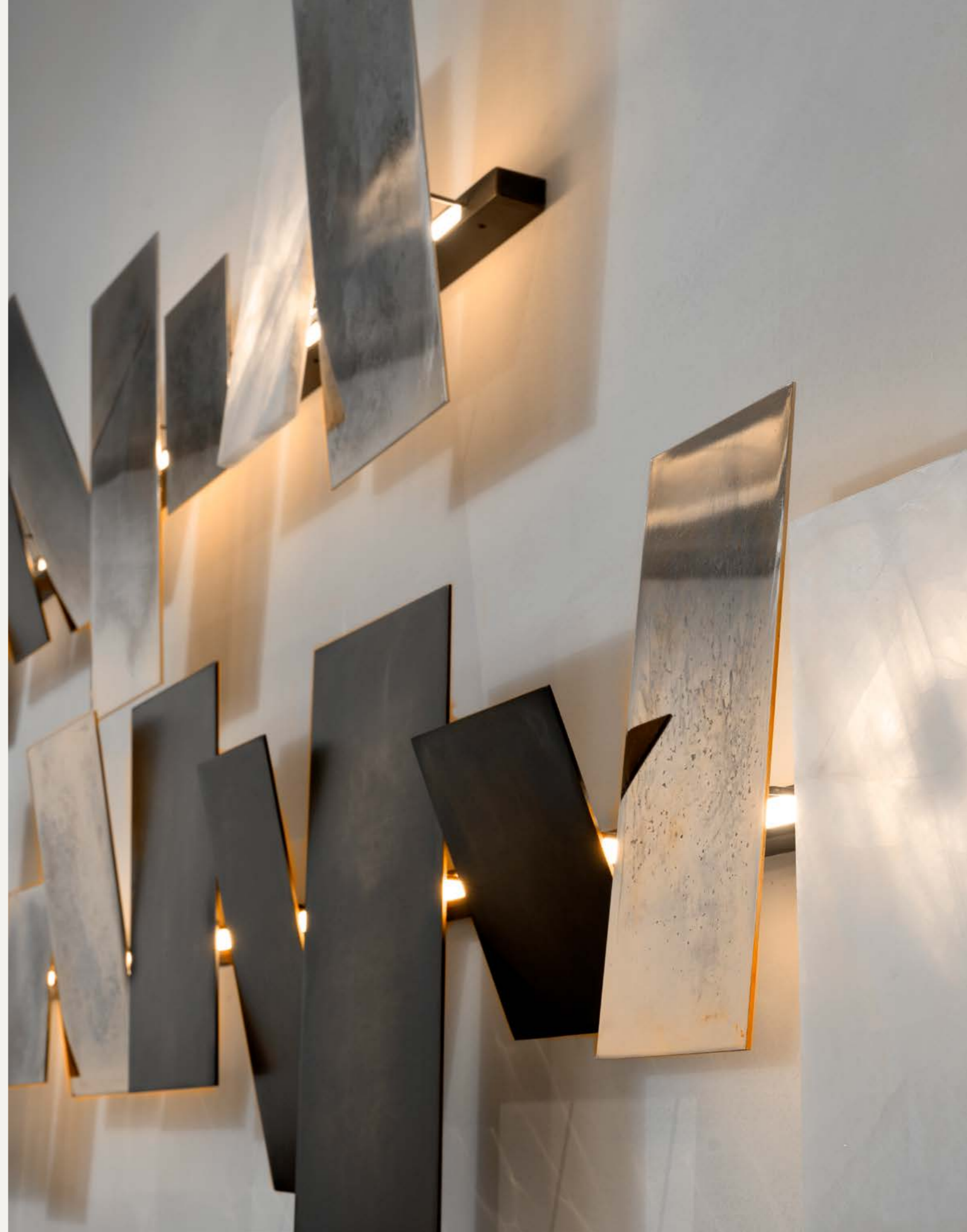

ARCADE

LAMPS/CHANDELIERS



An interplay of blown glass with geometric, polyhedric forms, reiterated and joined together, composes ARCADE lightscape. Light breaths life into the multi-faceted pattern lending it movement and three-dimensionality, creating a dynamic, highly sonorous visual effect, an enchanting spectacle of transparencies and reflections.

Un gioco di forme geometriche poliedriche in vetro soffiato, reiterate e unite tra loro, compone il paesaggio luminoso di ARCADE. La luce infonde vita al motivo sfaccettato, conferendogli movimento e tridimensionalità, creando un effetto visivo dinamico ed altamente sonoro, uno spettacolo incantevole di trasparenze e riflessi.

DESIGNER
Ugo Cacciatori

DETAILS

- Wall light available in 8 different configurations.
 - Energy-saving with warm COB LED light (energy efficiency index A).
 - Metal structure in black burnished steel.
 - Murano blown glass with an elegant smoked finish.
 - Dimming function. (DALI, DMX, 1-10V, 0-10 or Phase cut) Available upon request
 - Extra warm light 2700K.
 - 110V.
 - Connection joint for multi-module compositions.
- Check the required quantity based on the configuration.

DETTAGLI

- Lampada da parete disponibile in 8 diverse configurazioni.
- Risparmio energetico con luce LED COB calda (indice di efficienza energetica A).
- Struttura in acciaio brunito nero.
- Vetro soffiato di Murano con eleganze finitura Fumè.
- Funzione dimmer. (DALI, DMX, 1-10V, 0-10 o Taglio di fase) Disponibile su richiesta.
- Luce extra calda 2700K.
- 110V.
- Giunto di collegamento per composizioni a più moduli. Verificare quantità necessaria in base alla composizione.

CONSTRUCTION SPECIFICATION

Weight: 6-42 kg
Material: Metal, Blown glass Fumè
Finish: Black Burnished Steel

Certified Product
Prodotto certificato

CE EAC IP20

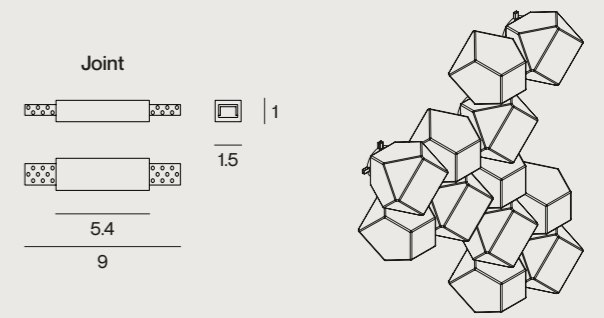

TECHNICAL DATA

Net Weight: 6 kg
Light source: COB LED
Input Voltage [V]: 220-240 V or 110-120 V upon request
Max Power [W]: 8 W
Light colour [K]: 3000 K or 2600 K upon request
Flux [lm]: 2600 K - 960 lm / 3000 K - 1080 lm**
CRI: >90
Dimming: Push / Phase cut / 0-10 V / 1-10 V / DMX / DALI-2 dimmable

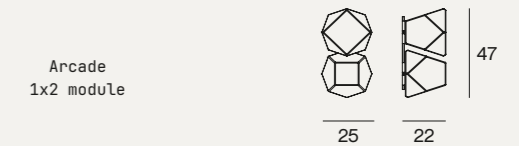

TECHNICAL DATA

Net Weight: 9 kg
Light source: COB LED
Input Voltage [V]: 220-240 V or 110-120 V upon request
Max Power [W]: 12 W
Light colour [K]: 3000 K or 2600 K upon request
Flux [lm]: 2600 K - 1440 lm / 3000 K - 1710 lm**
CRI: >90
Dimming: Push / Phase cut / 0-10 V / 1-10 V / DMX / DALI-2 dimmable

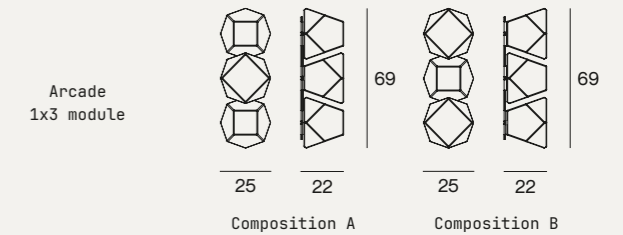

TECHNICAL DATA

Net Weight: 12 kg
Light source: COB LED
Input Voltage [V]: 220-240 V or 110-120 V upon request
Max Power [W]: 16 W
Light colour [K]: 3000 K or 2600 K upon request
Flux [lm]: 2600 K - 1920 lm / 3000 K - 2160 lm**
CRI: >90
Dimming: Push / Phase cut / 0-10 V / 1-10 V / DMX / DALI-2 dimmable

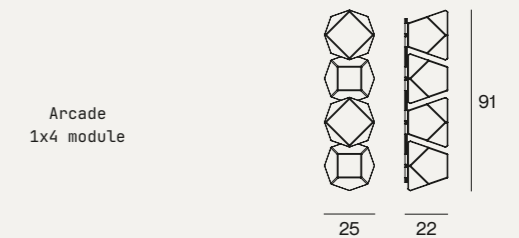

**Output of led inside the lamp. Losses due to diffusor and reflectors are not considered. Values are indicative, ambient temperature, height and position of the lamp may vary the values.
**Emissione del LED all'interno della lampada. Le perdite dovute a diffusore e riflettori non sono considerate. I valori sono indicativi: temperatura ambiente, altezza e posizione della lampada possono influenzare i valori.

TECHNICAL DATA

Net Weight: 15 kg
 Light source: COB LED
 Input Voltage [V]: 220-240 V or 110-120 V upon request
 Max Power [W]: 20 W
 Light colour [K]: 3000 K or 2600 K upon request
 Flux [lm]: 2600 K - 2400 lm / 3000 K - 2700 lm**
 CRI: >90
 Dimming: Push / Phase cut / 0-10 V / 1-10 V / DMX / DALI-2 dimmable

Arcade
 1x5 module

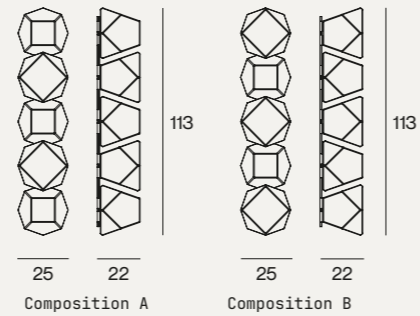

TECHNICAL DATA

Net Weight: 12 kg
 Light source: COB LED
 Input Voltage [V]: 220-240 V or 110-120 V upon request
 Max Power [W]: 16 W
 Light colour [K]: 3000 K or 2600 K upon request
 Flux [lm]: 2600 K - 1920 lm / 3000 K - 2160 lm**
 CRI: >90
 Dimming: Push / Phase cut / 0-10 V / 1-10 V / DMX / DALI-2 dimmable

Arcade
 2x2 module

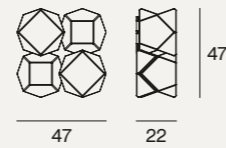

TECHNICAL DATA

Net Weight: 18 kg
 Light source: COB LED
 Input Voltage [V]: 220-240 V or 110-120 V upon request
 Max Power [W]: 24 W
 Light colour [K]: 3000 K or 2600 K upon request
 Flux [lm]: 2600 K - 2880 lm / 3420 K - 3420 lm**
 CRI: >90
 Dimming: Push / Phase cut / 0-10 V / 1-10 V / DMX / DALI-2 dimmable

Arcade
 2x3 module

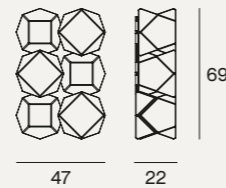

TECHNICAL DATA

Net Weight: 24 kg
 Light source: COB LED
 Input Voltage [V]: 220-240 V or 110-120 V upon request
 Max Power [W]: 32 W
 Light colour [K]: 3000 K or 2600 K upon request
 Flux [lm]: 2600 K - 3840 lm / 4320 K - 426 lm**
 CRI: >90
 Dimming: Push / Phase cut / 0-10 V / 1-10 V / DMX / DALI DALI-2 dimmable

Arcade
 2x4 module

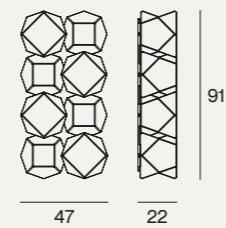

TECHNICAL DATA

Net Weight: 30 kg
 Light source: COB LED
 Input Voltage [V]: 220-240 V or 110-120 V upon request
 Max Power [W]: 40 W
 Light colour [K]: 3000 K or 2600 K upon request
 Flux [lm]: 2600 K - 4800 lm / 3000 K - 5400 lm**
 CRI: >90
 Dimming: Push / Phase cut / 0-10 V / 1-10 V / DMX / DALI-2 dimmable

Arcade
 2x5 module

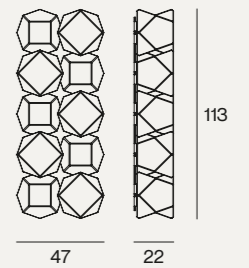

TECHNICAL DATA

Net Weight: 36 kg
 Light source: COB LED
 Input Voltage [V]: 220-240 V or 110-120 V upon request
 Max Power [W]: 48 W
 Light colour [K]: 3000 K or 2600 K upon request
 Flux [lm]: 2600 K - 5760 lm / 3000 K - 6480 lm**
 CRI: >90
 Dimming: Push / Phase cut / 0-10 V / 1-10 V / DMX / DALI-2 dimmable

Arcade - Composition A
 12 elements

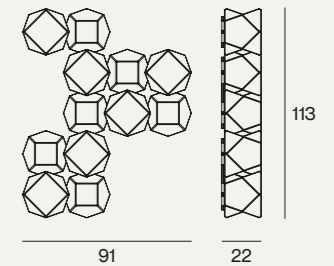

TECHNICAL DATA

Net Weight: 33 kg
 Light source: COB LED
 Input Voltage [V]: 220-240 V or 110-120 V upon request
 Max Power [W]: 44 W
 Light colour [K]: 3000 K or 2700 K upon request
 Flux [lm]: 2700 K - 5280 lm / 3000 K - 6030 lm**
 CRI: >90
 Dimming: Push / Phase cut / 0-10 V / 1-10 V / DMX / DALI-2 dimmable

Arcade - Composition B
 11 elements

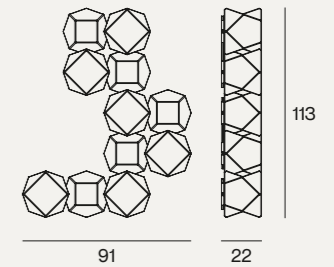

TECHNICAL DATA

Net Weight: 42 kg
 Light source: COB LED
 Input Voltage [V]: 220-240 V or 110-120 V upon request
 Max Power [W]: 56 W
 Light colour [K]: 3000 K or 2600 K upon request
 Flux [lm]: 2600 K - 6720 lm / 3000 K - 7560 lm**
 CRI: >90
 Dimming: Push / Phase cut / 0-10 V / 1-10 V / DMX / DALI DALI-2 dimmable

Arcade - Composition C
 14 elements

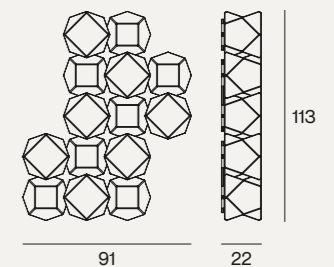

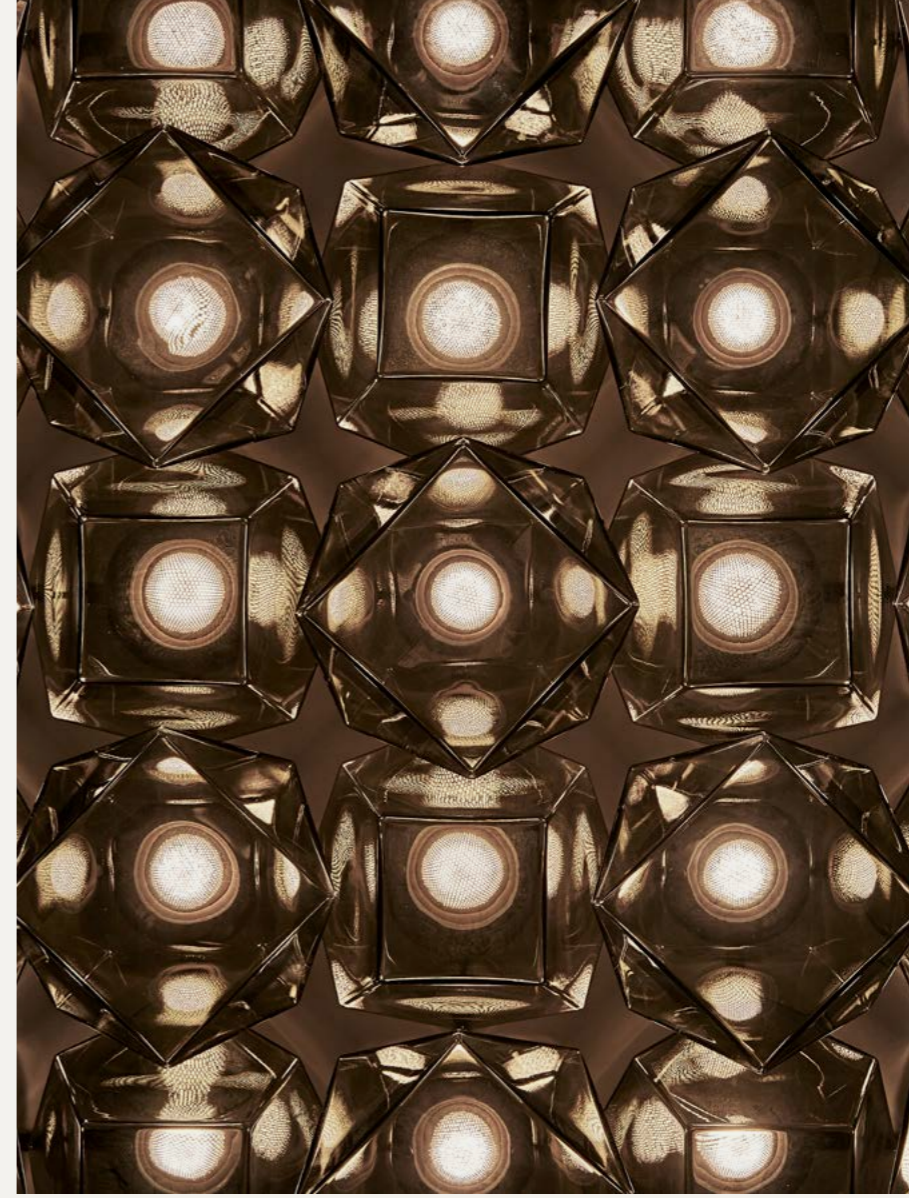



GLADIO

WALL LIGHT

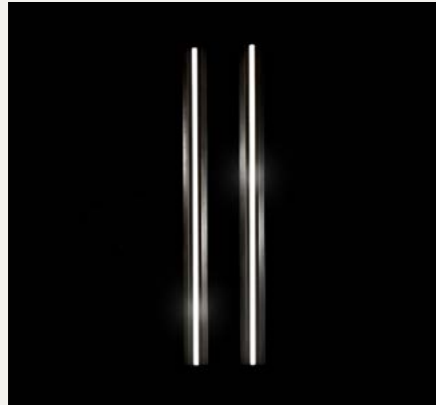

A clear, sleek, distinctive sign expresses the wall lights, Gladio, long glass trihedrons framed by titanium bands; stylized icons privileging a pure beauty.

Un segno netto, slanciato, distintivo esprime le applique Gladio, lunghi triedri di vetro incorniciati da bande di titanio; icone stilizzate che privilegiano una pura bellezza.

CONSTRUCTION SPECIFICATION

Weight: 9.7-12.5 kg
Material: Brass, steel or stone profile with a trihedron of Murano glass diffuser
Finish: • Burnished Titanio, Burnished Platino, Burnished Brass, Black Burnished Brass, H-Silver Patina, H-Pale Gold
• Stones from our range

Certified Product
Prodotto certificato



TECHNICAL DATA

Net Weight: 9.7-12.5 kg
Light source: strip LED 24 V
Input Voltage [V]: 220-240 V or 110-120 V upon request
Max Power [W]: 16 W
Light colour [K]: 3000 K or 2700 K upon request
Flux [lm]: 2700 K - 1205 lm / 3000 K - 1323 lm**
CRI: >90
Dimming: Push / Phase cut / 0-10 V / 1-10 V / DMX / DALI-2 dimmable

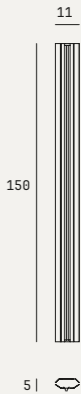

DESIGNER
Ugo Cacciatori

DETAILS

- Dimmable wall light made of metal or stone with a trihedron Murano glass.
- Energy-saving LED light (Energy efficiency index A).
- Transformer included in the wall box.

LIGHT SOURCE

- LED 24 V - 3000 K.
- Upon request available with extra warm light 2700 K.
- Upon request available 110 V.
- Dimming function included.

DETTAGLI

- Lampada da parete dimmerabile in metallo con un triedro in vetro di Murano.
- LED a risparmio energetico (Indice di efficienza energetica A).
- Trasformatore integrato nel box a muro.

FONTE LUMINOSA

- Strip led 24 V, luce calda 3000 K.
- Su richiesta disponibile con luce extra calda a 2700 K.
- Disponibile 110 V su richiesta.
- Dimmerabile.

**Output of led inside the lamp. Losses due to diffusor and reflectors are not considered. Values are indicative, ambient temperature, height and position of the lamp may vary the values.
**Emissione del LED all'interno della lampada. Le perdite dovute a diffusore e riflettori non sono considerate. I valori sono indicativi: temperatura ambiente, altezza e posizione della lampada possono influenzare i valori.





SPYDER

WALL LIGHT



The wall-mounted lights, Spyder, a triangulation of stretched out in tension metal cables and backlit glass cylinders in an industrial chic style. With a burnished brass finish, this light offers the possibility of 'spider web' compositions and interweaving, creative and endless patterns with powerful graphic incisiveness.

Le luci a parete, Spyder, una triangolazione di cavi metallici tesi in tensione e cilindri di vetro retroilluminati in stile industrial chic. Con finitura in ottone brunito, questa lampada offre la possibilità di composizioni e intrecci a 'ragnatela', trame creative e infinite dalla potente incisività grafica.

CONSTRUCTION SPECIFICATION

Weight: 3.8-7.8 kg
 Material: Brass with light source in borosilicate glass
 Finish: Burnished Brass, Black Burnished Brass

Certified Product
 Prodotto certificato **CE**

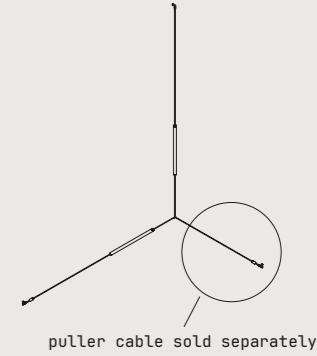

TECHNICAL DATA

Net Weight: 3,80 kg
 Light source: Strip led 24V
 Input Voltage [V]: 220-240 V or 110-120 upon request
 Max Power [W]: 29 W
 Light colour [K]: 3000 K or 2700 K upon request
 Flux [lm]: 2700 K-2173 lm; 3000 K-2385 lm**
 CRI: >90
 Dimming: Push/Phase cut/0-10 V/1-10 V/DMX/DALI-2 dimmable

Spyder 100h
 Wall/Ceiling mounted

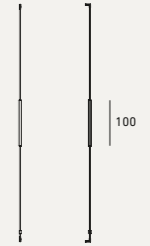

TECHNICAL DATA

Net Weight: 4,80 kg
 Light source: Strip led 24V
 Input Voltage [V]: 220-240 V or 110-120 upon request
 Max Power [W]: 46 W
 Light colour [K]: 3000 K or 2700 K upon request
 Flux [lm]: 2700 K-3780 lm; 3000 K-3444 lm**
 CRI: >90
 Dimming: Push / Phase cut / 0-10 V/1-10 V/DMX / DALI-2 dimmable

Spyder 150h
 Wall/Ceiling mounted

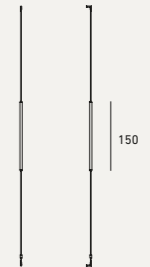

TECHNICAL DATA

Net Weight: 6,80 kg
 Light source: Strip led 24V
 Input Voltage [V]: 220-240 V or 110-120 upon request
 Max Power [W]: 58 W
 Light colour [K]: 3000 K or 2700 K upon request
 Flux [lm]: 2700 K-4346 lm; 3000 K-4770 lm**
 CRI: >90
 Dimming: Push/Phase cut/0-10 V/1-10 V/DMX / DALI-2 dimmable

Spyder
 100h+100h
 Wall/Ceiling mounted

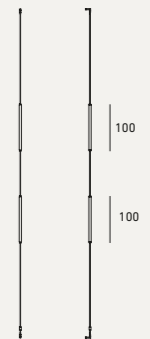

DESIGNER
 Massimo Castagna

STRUCTURE

- Light source incorporated in a borosilicate cylindrical glass.
- Available in 2 configurations: single or double light with cable puller to create different scenarios.
- Puller loop made of leather.
- Energy-saving LED light (Energy efficiency index A).
- Transformer must be placed remotely.
- Power supply cable coated with metal cord (2.5 meters long).

LIGHT SOURCE

- LED 24V 3000K.
- Upon request available with extra warm light 2700K.
- Available 110V upon request.
- Dimming function included.

STRUTTURA

- Sorgente luminosa incorporata in un vetro cilindrico borosilicato.
- Disponibile in 2 configurazioni: luce singola o doppia con tiracavo per creare diversi scenari.
- Gangio tiracavo in pelle.
- Luce calda a risparmio energetico (indice di efficienza energetica A).
- Il trasformatore deve essere posizionato a remoto.
- Cavo elettrico rivestito in metallo.

FONTE LUMINOSA

- Strip LED 24V 3000K.
- Su richiesta disponibile con luce extra calda a 2700K.
- Disponibile 110V su richiesta.
- Dimmerabile.



TECHNICAL DATA

Net Weight: 7,80 kg
Light source: Strip LED 24V
Input Voltage [V]: 220-240 V or 110-120 upon request
Max Power [W]: 74 W
Light colour [K]: 3000 K or 2700 K upon request
Flux [lm]: 2700 K-5617 lm; 3000 K-6165 lm**
CRI: >90
Dimming: Push/Phase cut/0-10 V/1-10 V/DMX/
DALI-2 dimmable

Spyder 150h+100h
Wall/Ceiling mounted

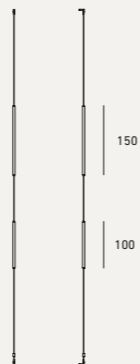

**Output of led inside the lamp. Losses due to diffusor and reflectors are not considered. Values are indicative, ambient temperature, height and position of the lamp may vary the values.
**Emissione del LED all'interno della lampada. Le perdite dovute a diffusore e riflettori non sono considerate. I valori sono indicativi: temperatura ambiente, altezza e posizione della lampada possono influenzare i valori.

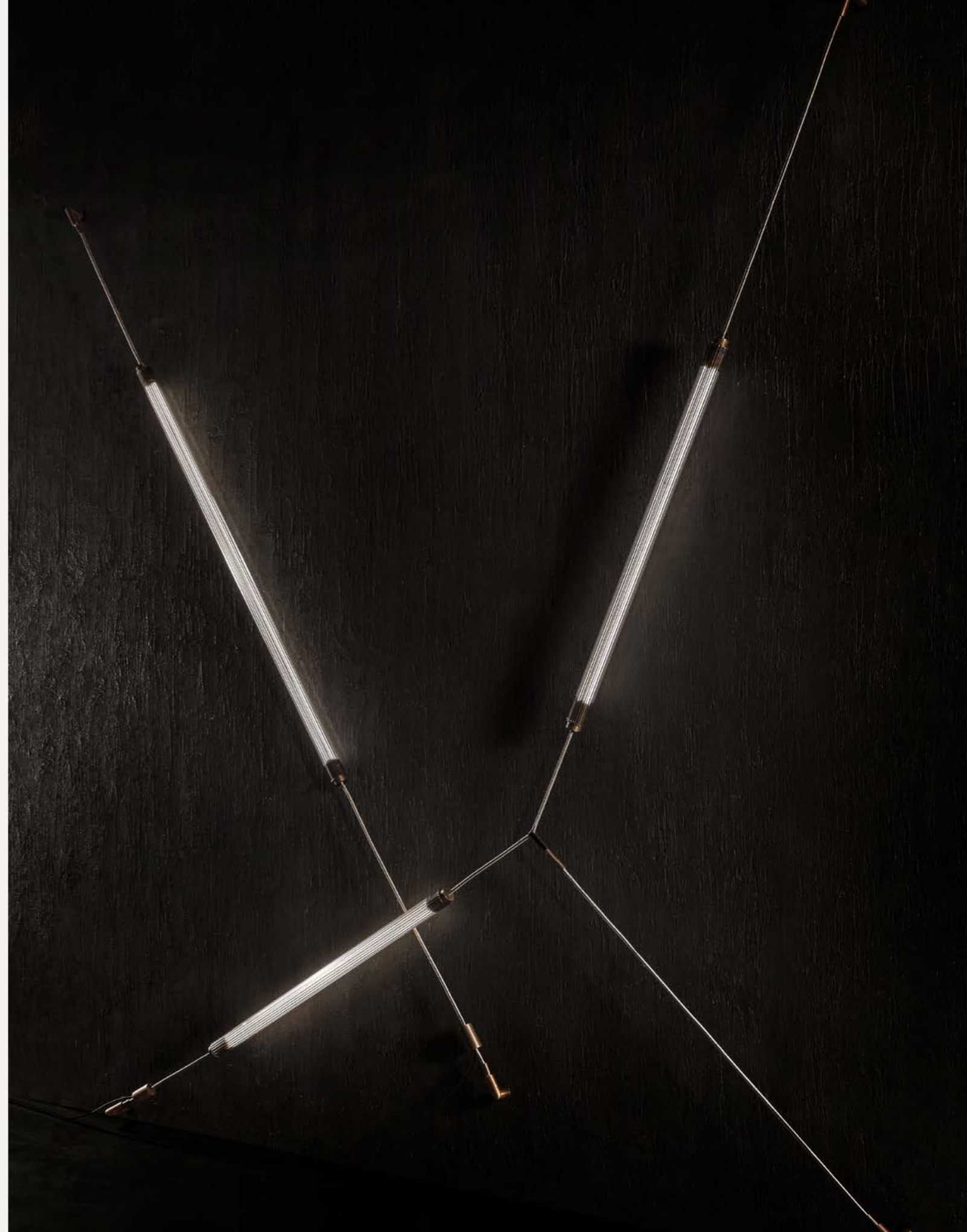



TAPE WALL

WALL LIGHT



Delicate, sinuous organic forms generate with exuberant, explosive dynamism multiple sequences of harmonious, fluid complexity. Luminous ribbons lightly meander, rhythmically enhancing floating seductive, ethereal textures.

Forme organiche delicate e sinuose generano con dinamismo esuberante ed esplosivo molteplici sequenze di complessità armonica e fluida. Nastri luminosi serpeggiano leggermente, esaltando ritmicamente trame fluttuanti, seducenti ed eteree.

DESIGNER
Massimo Castagna

DETAILS

- Wall lights made with hand-carved metal bars of various sizes and configurations.
- Energy-saving LED light (Energy efficiency index A).
- Transformer incorporated in the wall rosette.

LIGHT SOURCE

- LED 24V 3000K.
- Upon request available with extra warm light 2700K.
- Available 110V upon request.
- Dimming function included.

DETTAGLI

- Lampade a muro realizzate con barre metalliche curvate a mano di varie dimensioni e configurazioni.
- Led a risparmio energetico (Indice di efficienza energetica A).
- Trasformatore incorporato nel rosone a parete

FONTE LUMINOSA

- Strip LED 24V 3000K.
- Su richiesta disponibile con luce extra calda a 2700K.
- Disponibile 110V su richiesta.
- Dimmerabile.

CONSTRUCTION SPECIFICATION

Weight: 4,20 kg-5,50 kg
Material: Brass profile with polycarbonate diffuser
Finish: Burnished Brass, Black Burnished Brass, Burnished Titanio, Burnished Platino, H-Silver, H-Silver Black

Certified Product
Prodotto certificato



TECHNICAL DATA

Net Weight: 4,20 kg
Light source: Strip led 24V
Input Voltage [V]: 220-240 V or 110-120 upon request
Max Power [W]: 10 W
Light colour [K]: 3000 K or 2700 K upon request
Flux [lm]: 2700 K-1296 lm; 3000 K-1488 lm**
CRI: >80
Dimming: 0-10 V/1-10 V/DMX/DALI dimmable

Tape Wall
163h

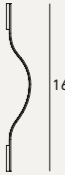

TECHNICAL DATA

Net Weight: 4,60 kg
Light source: Strip led 24V
Input Voltage [V]: 220-240 V or 110-120 upon request
Max Power [W]: 14 W
Light colour [K]: 3000 K or 2700 K upon request
Flux [lm]: 2700 K-1728 lm; 3000 K-1984 lm**
CRI: >80
Dimming: 0-10 V/1-10 V/DMX/DALI dimmable

Tape Wall
205h

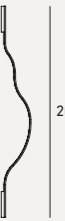

TECHNICAL DATA

Net Weight: 5,50 kg
Light source: Strip led 24V
Input Voltage [V]: 220-240 V or 110-120 upon request
Max Power [W]: 17 W
Light colour [K]: 3000 K or 2700 K upon request
Flux [lm]: 2700 K-2052 lm; 3000 K-2356 lm**
CRI: >80
Dimming: 0-10 V/1-10 V/DMX/DALI dimmable

Tape Wall
225h

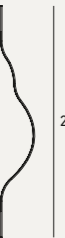

**Output of led inside the lamp. Losses due to diffuser and reflectors are not considered. Values are indicative, ambient temperature, height and position of the lamp may vary the values.
**Emissione del LED all'interno della lampada. Le perdite dovute a diffusore e riflettori non sono considerate. I valori sono indicativi: temperatura ambiente, altezza e posizione della lampada possono influenzare i valori.







TUBULAR WALL

WALL LIGHT



Slender cylindrical suspended bodies, anchored to branched brass structures, create geometrically calibrated and intriguing compositions.

Esili corpi cilindrici sospesi, ancorati a strutture ramificate in ottone, creano composizioni geometricamente calibrate e intriganti.

CONSTRUCTION SPECIFICATION

Weight: 1,15 kg-2 kg
Material: Brass tube
Finish: Burnished Brass, Black Burnished Brass, Burnished Titanio, Burnished Platino

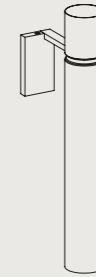

Certified Product
Prodotto certificato



TECHNICAL DATA

Net Weight: 3 kg
Light source: GU10 led bulb 24V
Input Voltage [V]: 220-240 V or 110-120 upon request
Max Power [W]: 9,20 W
Light colour [K]: 3000 K or 2700 K upon request
Flux [lm]: 700 lm**
CRI: >80
Dimming: Phase cut dimmable

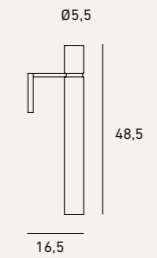

DESIGNER
Massimo Castagna

TECHNICAL DATA

Net Weight: 4 kg
Light source: GU10 led bulb 24V
Input Voltage [V]: 220-240 V or 110-120 upon request
Max Power [W]: 9,20 W
Light colour [K]: 3000 K
Flux [lm]: 700 lm**
CRI: >80
Dimming: Phase cut dimmable

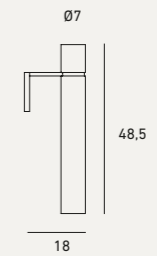

DETAILS

- Wall lamp made of cylinders made of Burnished Brass, Burnished Platino, or Titanio.
- Energy-saving LED light (Energy efficiency index A).

LIGHT SOURCE

- GU10 10 LED bulb.
- Upon request available with extra warm light 2700K.
- Available 110V upon request, bulbs not included.
- Phase cut dimmable.

DETTAGLI

- Lampada da parete composta da cilindri in Ottone Brunito, Platino Brunito o Titanio.
- Luce LED a risparmio energetico (Indice di efficienza energetica A).

SORGENTE LUMINOSA

- Lampadina GU10 10 LED.
- Su richiesta disponibile con luce extra calda 2700K.
- Disponibile 110V su richiesta, lampadine non incluse.
- Dimmerabile a taglio di fase.



**Output of led inside the lamp. Losses due to diffusor and reflectors are not considered. Values are indicative, ambient temperature, height and position of the lamp may vary the values.
**Emissione del LED all'interno della lampada. Le perdite dovute a diffusore e riflettori non sono considerate. I valori sono indicativi: temperatura ambiente, altezza e posizione della lampada possono influenzare i valori.



WALL CLIPS

WALL LIGHT

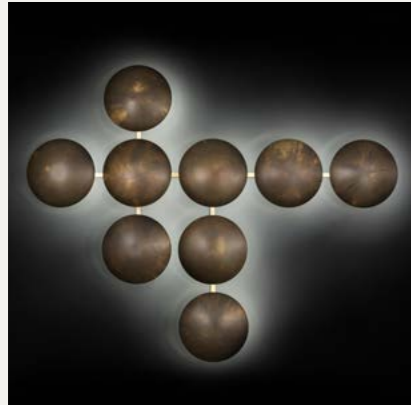

Backlit metal handcrafted clips, in different combinations, enliven the walls with the graphic rhythm of striking geometries.

Clip artigianali in metallo retroilluminati, in diverse combinazioni, animano le pareti con il ritmo grafico di suggestive geometrie.

DESIGNER
Massimo Castagna

DETAILS

- Wall light available in 4 different configurations or as a single Clip.
- Metal structure with rounded Clips available in different finishes.
- Clip diameter Ø 23.5 cm, Ø 40 cm.
- Energy-saving LED light (Energy efficiency index A).
- Transformer included in the wall box.

LIGHT SOURCE

- COB LED 24V 3000K.
- Upon request available with extra warm light 2700K.
- Upon request available 110V.
- Dimming function included.

DETTAGLI

- Lampada da parete disponibile in 4 diverse configurazioni o come singola Clip.
- Struttura in metallo con clip tonde disponibili in diverse finiture.
- Diametro clip Ø 23,5 cm, Ø 40 cm.
- Sospensione a led a risparmio energetico (Indice di efficienza energetica A).
- Trasformatore integrato nel rosone.

FONTE LUMINOSA

- COB LED 24V 3000K.
- Su richiesta disponibile con luce extra calda a 2700K o 4000K.
- Disponibile 110V su richiesta.
- Dimmerabile.

CONSTRUCTION SPECIFICATION

Weight: 1 kg-12 kg
Material: Metal
Finish: Burnished Brass, Black Burnished Brass, Black Burnished Steel, Burnished Platino, Burnished Titanio, H-Silver, H-Silver Black

Certified Product
Prodotto certificato

CE EAC IP20

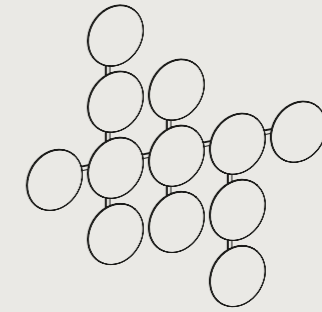

----- *punti di elettrificazione
*electrification points

TECHNICAL DATA

Net Weight: 5 kg-7,5 kg
Light source: COB led
Input Voltage [V]: 220-240 V or 110-120 upon request
Max Power [W]: 28 W
Light colour [K]: 3000 K or 2700 K upon request
Flux [lm]: 2700 K-2520 lm; 3000 K-2660 lm**
CRI: >80
Dimming: Push/DMX dimmable

7 Elements-Ø23,5/Ø40

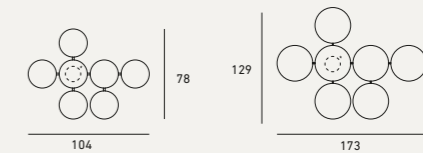

TECHNICAL DATA

Net Weight: 6 kg-9 kg
Light source: COB led
Input Voltage [V]: 220-240 V or 110-120 upon request
Max Power [W]: 36 W
Light colour [K]: 3000 K or 2700 K upon request
Flux [lm]: 3240 lm**
CRI: >80
Dimming: Push/DMX dimmable

9 Elements-Ø23,5/Ø40

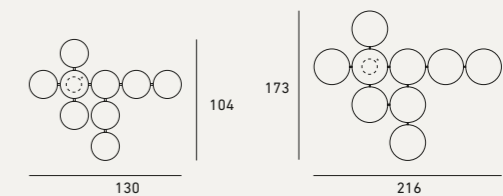

TECHNICAL DATA

Net Weight: 6,50 kg-10 kg
Light source: COB led
Input Voltage [V]: 220-240 V or 110-120 upon request
Max Power [W]: 5,90 W
Light colour [K]: 3000 K or 2700 K upon request
Flux [lm]: 2700 K-3600 lm; 3000 K-3800 lm**
CRI: >80
Dimming: DMX; dimmable 1-10 V; dimmable 0-10 V; DALI; dimmable push

10 Elements-Ø23,5/Ø40

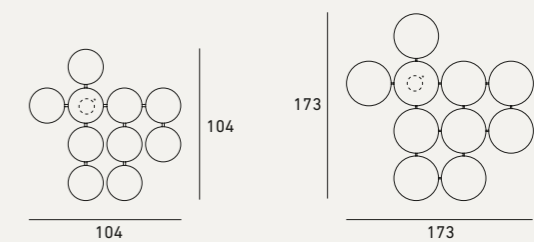

12 Elements-Ø23,5/Ø40

TECHNICAL DATA

Net Weight: 8 kg-12 kg
 Light source: COB led
 Input Voltage [V]: 220-240 V or 110-120 upon request
 Max Power [W]: 48 W
 Light colour [K]: 3000 K or 2700 K upon request
 Flux [lm]: 2700 K-4320 lm; 3000 K-4560 lm**
 CRI: >80
 Dimming: DMX; dimmable 1-10 V; dimmable 0-10 V;
 DALI; dimmable push

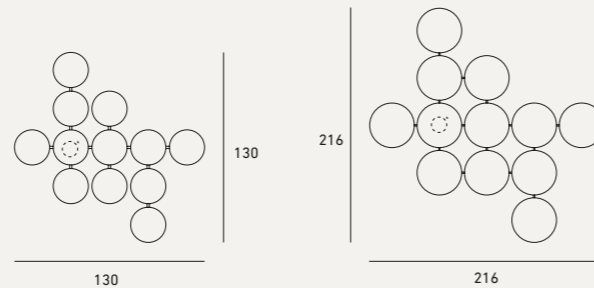

TECHNICAL DATA

Net Weight: 1 kg
 Light source: COB led
 Input Voltage [V]: 220-240 V or 110-120 upon request
 Max Power [W]: 4 W
 Light colour [K]: 3000 K or 2700 K upon request
 Flux [lm]: 2700 K-360 lm; 3000 K-380 lm**
 CRI: >80
 Dimming: DMX; dimmable 1-10 V; dimmable 0-10 V;
 DALI; dimmable push

1 Element-Ø40



Ø40



**Output of led inside the lamp. Losses due to diffusor and reflectors are not considered. Values are indicative, ambient temperature, height and position of the lamp may vary the values.
 **Emissione del LED all'interno della lampada. Le perdite dovute a diffusore e riflettori non sono considerate. I valori sono indicativi: temperatura ambiente, altezza e posizione della lampada possono influenzare i valori.

VIBE

WALL LIGHT

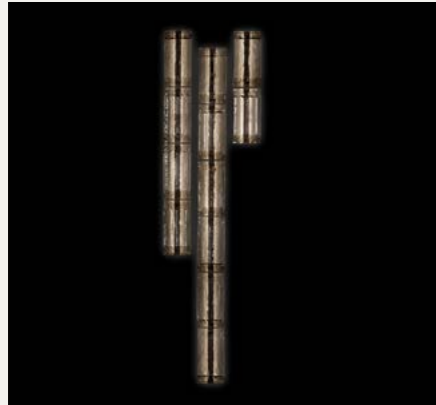

Taste for formal enchantment forges the lighting sculpture: textured blown glass tiles chase each other in vertical sequences along the wall in an alluring, ethereal game of endless modulations and nuances of light and transparencies, seduction, and reflections.

Gusto per l'incanto formale forgia la scultura luminosa: tessere testurizzate di vetro soffiato si rincorrono in sequenze verticali lungo la parete in un gioco etereo ed intrigante di infinite modulazioni e sfumature di luci e trasparenze, seduzione e riflessi.

DESIGNER
Massimo Castagna

DETAILS

- Dimmable wall light available in 3 different configurations.
- Black burnished brass structure with Murano grey glass.
- Energy-saving LED light (Energy efficiency index A)
- The transformer must be placed remotely.

LIGHT SOURCE

- LED 24V 3000K.
- Upon request available with extra warm light 2700K.
- Upon request available 110V.
- Dimming function included.

DETTAGLI

- Luce da parete dimmerabile disponibile in 3 configurazioni.
- Struttura in ottone brunito nero con vetro di Murano grigio.
- LED a risparmio energetico (Indice di efficienza energetica A).
- Il trasformatore deve essere posizionato a remoto.

FONTE LUMINOSA

- Strip led 24V, luce calda 3000K, CRI > 90.
- Su richiesta disponibile con luce extra calda a 2700K.
- Disponibile 110V su richiesta.
- Dimmerabile.

CONSTRUCTION SPECIFICATION

Weight: 4.5-13.5 kg
Material: Black burnished brass structure with Murano grey glass
Finish: Black Burnished Brass
Fixing type: Remote transformer

Certified Product
Prodotto certificato



Optional box for power supply and dimmer

* 10
17.5 2.5

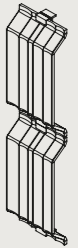

TECHNICAL DATA

Net Weight: 4.5 kg
Light source: Strip led 24 V
Input Voltage [V]: 220-240 V or 110-120 V upon request
Max Power [W]: 14 W
Light colour [K]: 3000 K or 2700 K upon request
Flux [lm]: 2700 K-1372 lm/3000 K-1460 lm**
CRI: >90
Dimming: Push/Phase cut/0-10 V/1-10 V/DMX/DALI-2 dimmable

Vibe 76h

----- *punti di elettrificazione
*electrification points

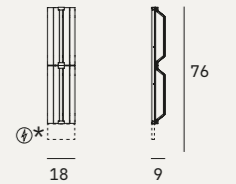

TECHNICAL DATA

Net Weight: 9 kg
Light source: Strip led 24 V
Input Voltage [V]: 220-240 V or 110-120 V upon request
Max Power [W]: 30 W
Light colour [K]: 3000 K or 2700 K upon request
Flux [lm]: 2700 K-2820 lm/3000 K-3000 lm**
CRI: >90
Dimming: Push/Phase cut/0-10 V/1-10 V/DMX/DALI-2 dimmable

Vibe 152h

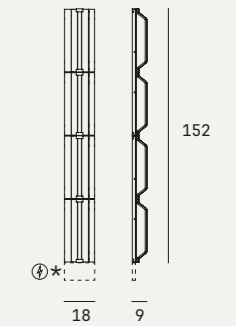

TECHNICAL DATA

Net Weight: 13.5 kg
Light source: Strip led 24 V
Input Voltage [V]: 220-240 V or 110-120 V upon request
Max Power [W]: 45 W
Light colour [K]: 3000 K or 2700 K upon request
Flux [lm]: 2700 K-4249 lm/3000 K-4520 lm**
CRI: >90
Dimming: Push/Phase cut/0-10 V/1-10 V/DMX/DALI-2 dimmable

Vibe 228h

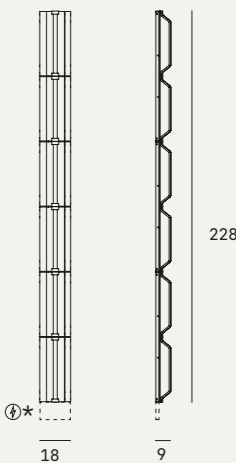

**Output of led inside the lamp. Losses due to diffusor and reflectors are not considered. Values are indicative, ambient temperature, height and position of the lamp may vary the values.
**Emissione del LED all'interno della lampada. Le perdite dovute a diffusore e riflettori non sono considerate. I valori sono indicativi: temperatura ambiente, altezza e posizione della lampada possono influenzare i valori.



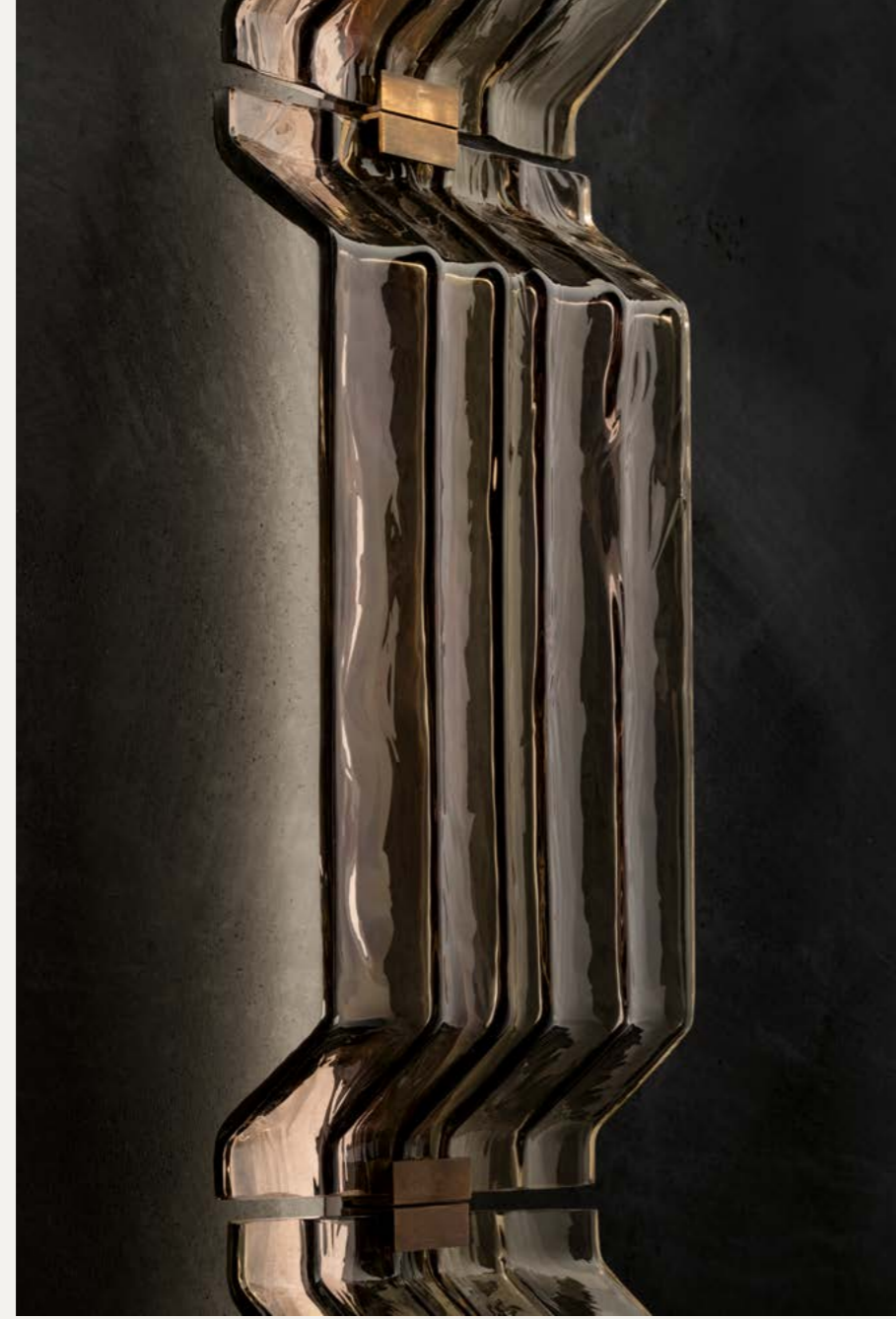

TRACK LIGHTING

LEGACY

TRACK LIGHTING



An exercise of subtraction and a search for atypical statements of minimalist aesthetics rethink spatial dynamics leading to Legacy. A thin, long glass tube with dimmable LED light, supported by rings of an overlying burnished brass cylindrical structure, runs with dynamic linearity through the space, tracing with a simple gesture iconic, floating sculptural configurations.

Un esercizio di sottrazione e una ricerca di affermazioni atipiche dell'estetica minimalista ripensano le dinamiche spaziali portando a Legacy. Un sottile e lungo tubo di vetro con luce LED dimmerabile, sostenuto dagli anelli di una sovrastante struttura cilindrica in ottone brunito, corre con dinamica linearità attraverso lo spazio, tracciando con un semplice gesto iconiche, fluttuanti configurazioni scultoree.

DESIGNER
Davide Nascimbeni

DETAILS

- Metal pendant lights made of straight and curved glass elements.
- The glass elements are joined and held by Sand Cast Peltro rings. The rings are connected by a rounded metal bar.
- Pendant energy-saving LED light (Energy efficiency index A).
- Transformer integrated into the ceiling rosette.
- Alternative mounting system with a remote transformer.
- Standard total height 180 cm. (Height can be customised).

LIGHT SOURCE

- 360° Neon LED 24 V, warm white 3000 K, CRI >90
- Upon request available with extra warm light 2700 K.
- Upon request available 110 V.
- Dimming function included.

DETTAGLI

- Lampade a sospensione in metallo composte da elementi in vetro dritti e curvi.
- Gli elementi in vetro sono uniti e trattenuti da anelli in metallo fuso in sabbia finitura Peltro. Gli anelli sono collegati da una barra arrotondata di metallo.
- Sospensione a led a risparmio energetico (Indice di efficienza energetica A).
- Trasformatore integrato nel rosone a soffitto.
- Sistema di montaggio alternativo con trasformatore remoto.
- Altezza totale standard 180 cm.

FONTE LUMINOSA

- Neon LED 360° 24V, bianco caldo 3000K.
- Su richiesta disponibile con luce extra calda a 2700K.
- Disponibile 110V su richiesta.
- Dimmerabile.

CONSTRUCTION SPECIFICATION

Weight: 9 kg-28,5 kg
Material: Brass profiles with Sand-casted Peltro details, high clarity cast polymer (PMMA polymethyl-methacrylate) diffuser and Lustrò Grey glass finish
Finish: Burnished Brass, Black burnished Brass, Burnished Titano

Certified Product
Prodotto certificato

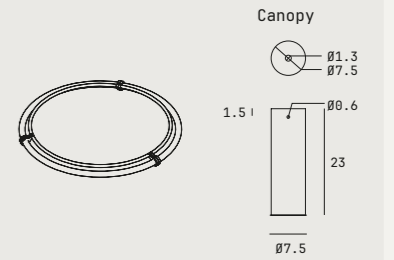

TECHNICAL DATA

Net Weight: ray: 2,25 kg-straight pipe: 2,5 kg
Light source: 360° Neon LED-technology 24V
Input Voltage [V]: 220/240 V or 110/120 V upon request
Max Power [W]: ray: 11 W-straight pipe: 14W
Light colour [K]: 3000K or 2700 K upon request
Flux [lm]: ray: 2700 K-760 lm; 3000 K-760 lm**
straight pipe: 2700 K-979 lm; 3000 K-979 lm** >90
CRI: >90
Dimming: Push / Phase cut / 0-10 V / 1-10 V / DMX / DALI-2 dimmable

Legacy ray 50
Internal

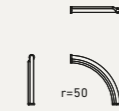

Legacy ray 50
External

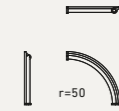

Legacy 100

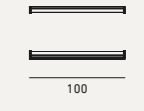

TECHNICAL DATA

Net Weight: 9 kg
Light source: 360° Neon LED-technology 24V
Input Voltage [V]: 220-240 V or 110-120 V upon request
Max Power [W]: 46 W
Light colour [K]: 3000K or 2700 K upon request
Flux [lm]: 2700 K-3069 lm; 3000 K-3069 lm** >90
CRI: >90
Dimming: Push / Phase cut / 0-10 V / 1-10 V / DMX / DALI-2 dimmable

Legacy Circle
Ø100

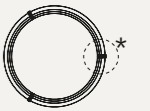

----- *punti di elettrificazione
*electrification points

TECHNICAL DATA

Net Weight: 14 kg
Light source: 360° Neon LED-technology 24V
Input Voltage [V]: 220-240 V or 110-120 V upon request
Max Power [W]: 72 W
Light colour [K]: 3000K or 2700 K upon request
Flux [lm]: 2700 K-4998 lm; 3000 K-4998 lm** >90
CRI: >90
Dimming: Push / Phase cut / 0-10 V / 1-10 V / DMX / DALI-2 dimmable

Legacy Oval
50+100+50

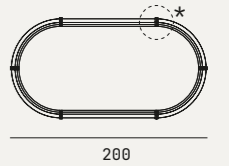

TECHNICAL DATA

Net Weight: 28,5 kg
Light source: 360° Neon LED-technology 24V
Input Voltage [V]: 220-240 V or 110-120 V upon request
Max Power [W]: 150 W
Light colour [K]: 3000K or 2700 K upon request
Flux [lm]: 2700 K-10434 lm; 3000 K-10434 lm** >90
CRI: >90
Dimming: Push / Phase cut / 0-10 V / 1-10 V / DMX / DALI-2 dimmable

Legacy Circuit
422x214

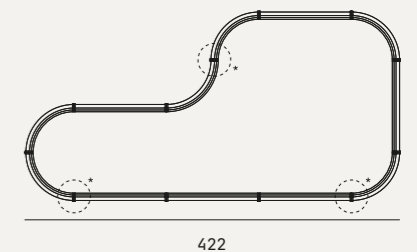

CONSTRUCTION SPECIFICATION

Weight: 10 kg-32,7 kg
 Material: Brass profiles with Sand-casted Peltro details, high clarity cast polymer (PMMA polymethyl-methacrylate) diffuser and Lustro Grey glass finish
 Finish: Burnished Brass, Black burnished Brass, Burnished Titano

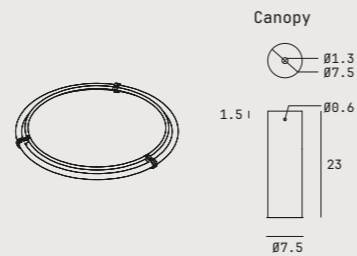

Certified Product
 Prodotto certificato

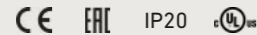

TECHNICAL DATA

Net Weight: ray: 2,50 kg-straight pipe: 2,95 kg
 Light source: 360° Neon LED-technology 24V
 Input Voltage [V]: 220/240V or 110/120V upon request
 Max Power [W]: ray: 13 W-straight pipe: 17 W
 Light colour [K]: 3000K or 2700 K upon request
 Flux [lm]: ray: 2700 K-912 lm; 3000 K-912 lm**
 straight pipe: 2700 K-1169 lm; 3000 K-1169 lm**
 CRI: >90
 Dimming: Push/Phase cut/0-10 V/1-10 V/DMX / DALI-2 dimmable



TECHNICAL DATA

Net Weight: 10 kg
 Light source: 360° Neon LED-technology 24V
 Input Voltage [V]: 220-240 V or 110-120 V upon request
 Max Power [W]: 55 W
 Light colour [K]: 3000K or 2700 K upon request
 Flux [lm]: 2700 K-3646 lm; 3000 K-3646 lm**
 CRI: >90
 Dimming: Push/Phase cut/0-10 V/1-10 V/DMX / DALI-2 dimmable

Legacy Circle Ø120

----- *punti di elettrificazione
 *electrification points

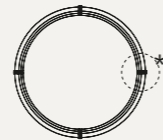

TECHNICAL DATA

Net Weight: 15,9 kg
 Light source: 360° Neon LED-technology 24V
 Input Voltage [V]: 220-240 V or 110-120 V upon request
 Max Power [W]: 86 W
 Light colour [K]: 3000K or 2700 K upon request
 Flux [lm]: 2700 K-5986 lm; 3000 K-5986 lm**
 CRI: >90
 Dimming: Push/Phase cut/0-10 V/1-10 V/DMX / DALI-2 dimmable

Legacy Oval 60+120+60

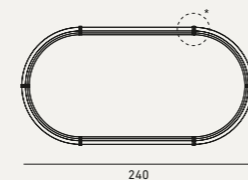

TECHNICAL DATA

Net Weight: 32,7 kg
 Light source: strip LED 24V
 Input Voltage [V]: 220-240 V or 110-120 V upon request
 Max Power [W]: 180 W
 Light colour [K]: 3000K or 2700 K upon request
 Flux [lm]: 2700 K-12486 lm; 3000 K-12486 lm**
 CRI: >90
 Dimming: Push/Phase cut/0-10 V/1-10 V/DMX / DALI-2 dimmable

Legacy Circuit 502x254

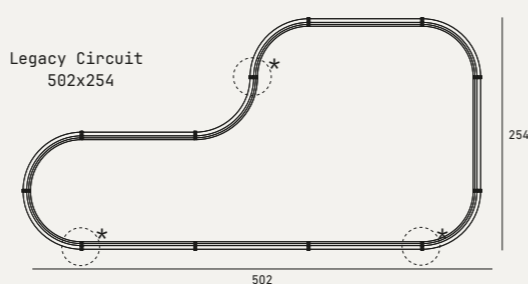

CONSTRUCTION SPECIFICATION

Weight: 11,20 kg- 37,2 kg
 Material: Brass profiles with Sand-casted Peltro details, high clarity cast polymer (PMMA polymethyl-methacrylate) diffuser and Lustro Grey glass finish
 Finish: Burnished Brass, Black burnished Brass, Burnished Titano

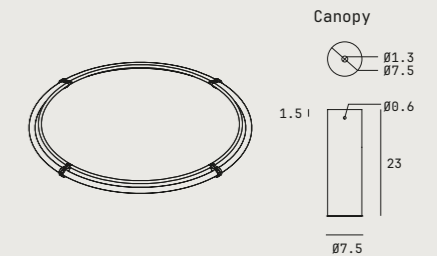

Certified Product
 Prodotto certificato



TECHNICAL DATA

Net Weight: ray: 2,80 kg-straight pipe: 3,40 kg
 Light source: 360° Neon LED-technology 24V
 Input Voltage [V]: 220/240V or 110/120V upon request
 Max Power [W]: ray: 16 W-straight pipe: 20 W
 Light colour [K]: 3000K or 2700 K upon request
 Flux [lm]: ray: 2700 K-1064 lm; 3000 K-1064 lm**
 straight pipe: 2700 K-1359 lm; 3000 K-1359 lm**
 CRI: >90
 Dimming: Push/Phase cut/0-10 V/1-10 V/DMX / DALI-2 dimmable

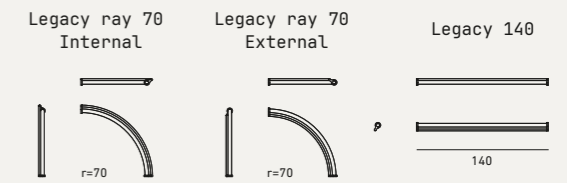

TECHNICAL DATA

Net Weight: 11,20 kg
 Light source: 360° Neon LED-technology 24V
 Input Voltage [V]: 220-240 V or 110-120 V upon request
 Max Power [W]: 64 W
 Light colour [K]: 3000K or 2700 K upon request
 Flux [lm]: 2700 K-4243 lm; 3000 K-4243 lm**
 CRI: >90
 Dimming: Push/Phase cut/0-10 V/1-10 V/DMX / DALI-2 dimmable

Legacy Circle Ø140

----- *punti di elettrificazione
 *electrification points

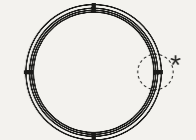

TECHNICAL DATA

Net Weight: 18 kg
 Light source: 360° Neon LED-technology 24V
 Input Voltage [V]: 220-240 V or 110-120 V upon request
 Max Power [W]: 104 W
 Light colour [K]: 3000K or 2700 K upon request
 Flux [lm]: 2700 K-6974 lm; 3000 K-6974 lm**
 CRI: >90
 Dimming: Push/Phase cut/0-10 V/1-10 V/DMX / DALI-2 dimmable

Legacy Oval 70+140+70

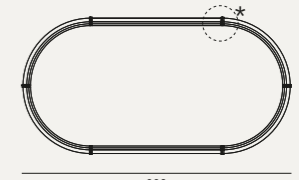

TECHNICAL DATA

Net Weight: 37,2 kg
 Light source: 360° Neon LED-technology 24V
 Input Voltage [V]: 220-240 V or 110-120 V upon request
 Max Power [W]: 215 W
 Light colour [K]: 3000K or 2700 K upon request
 Flux [lm]: 2700 K-14538 lm; 3000 K-14538 lm**
 CRI: >90
 Dimming: Push/Phase cut/0-10 V/1-10 V/DMX / DALI-2 dimmable

Legacy Circuit 582x249

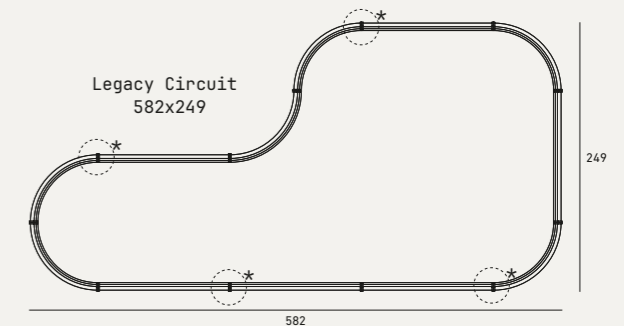

**Output of led inside the lamp. Losses due to diffusor and reflectors are not considered. Values are indicative, ambient temperature, height and position of the lamp may vary the values.
 **Emissione del LED all'interno della lampada. Le perdite dovute a diffusore e riflettori non sono considerate. I valori sono indicativi: temperatura ambiente, altezza e posizione della lampada possono influenzare i valori.





TABLE AND FLOOR LAMPS

FLOYD W

TABLE AND FLOR LAMPS



From the dexterity of the historic Venini's master glassmakers blossoms the exquisite, fumè purity of a sinuous shape replicated in double expansion: a fully-fledged artform that amazes with its endless polyhedric versatility.

Dalla destrezza dei maestri vetrai dello storico Venini scaturisce la squisita purezza fumè di una forma sinuosa replicata in doppia espansione: un vero e proprio oggetto d'arte che stupisce con la sua infinita poliedrica versatilità.

DESIGNER
Ugo Cacciatori

DETAILS

- Sculptural floor glass and stone lamp.
- Base available in stones from our range.
- Venini Murano blown glass element grey finish.
- Transformer incorporated in the base.
- Power supply cable black (3 meters long).
- The 237 cm version is anchored to the ceiling.

LIGHT SOURCE

- COB LED 24 V-3000 K.
- Upon request available with extra warm light 2700 K.
- Available 110 V upon request.
- Touch dimmable.

DETTAGLI

- Lampada da pavimento scultorea in vetro e pietra.
- Basamento disponibile nelle pietre di gamma.
- Il corpo luce è composto da 2 pezzi vetro soffiato da Venini Murano finitura grigia.
- Trasformatore incorporato nel basamento.
- Cavo elettrico nero (lungo 3 metri).
- La versione 237 cm è ancorata a soffitto.

FONTE LUMINOSA

- COB LED 24V 3000K.
- Su richiesta disponibile con luce extra calda a 2700K.
- Disponibile 110V su richiesta.
- Dimmerabile.

CONSTRUCTION SPECIFICATION

Weight: 108.2-186 kg
Material: Burnished Titanio with light source in blown glass
Finish:

- Burnished Titanio
- Grey Glass finish
- Stones from our range

Certified Product
Prodotto certificato

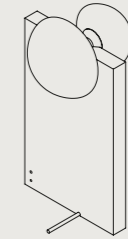
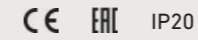

TECHNICAL DATA

Net Weight: 186 kg
Light source: Strip led 24 V
Input Voltage [V]: 220-240 V or 110-120 V upon request
Max Power [W]: 20 W
Light colour [K]: 3000 K or 2700 K upon request
Flux [lm]: 2700 K-2600 lm/3000 K-2960 lm**
CRI: >90
Dimming: Touch Switch dimmable

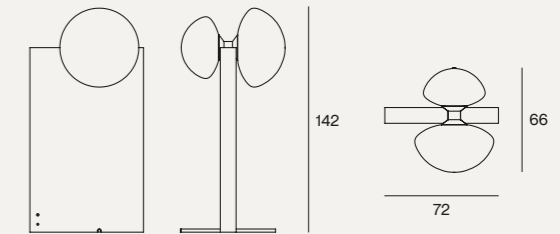

**Output of led inside the lamp. Losses due to diffusor and reflectors are not considered. Values are indicative, ambient temperature, height and position of the lamp may vary the values.
**Emissione del LED all'interno della lampada. Le perdite dovute a diffusore e riflettori non sono considerate. I valori sono indicativi: temperatura ambiente, altezza e posizione della lampada possono influenzare i valori.







FLOYD T

TABLE AND FLOR LAMPS



From the dexterity of the historic Venini's master glassmakers blossoms the exquisite, fumè purity of a sinuous shape replicated in double expansion: a fully-fledged artform that amazes with its endless polyhedric versatility.

Dalla destrezza dei maestri vetrai dello storico Venini scaturisce la squisita purezza fumè di una forma sinuosa replicata in doppia espansione: un vero e proprio oggetto d'arte che stupisce con la sua infinita poliedrica versatilità.

DESIGNER
Ugo Cacciatori

DETAILS

- Sculptural floor glass and stone lamp.
- Base available in stones from our range.
- Venini Murano blown glass element grey finish.
- Transformer incorporated in the base.
- Power supply cable black (3 meters long).
- The 237 cm version is anchored to the ceiling.

LIGHT SOURCE

- COB LED 24 V-3000 K.
- Upon request available with extra warm light 2700 K.
- Available 110 V upon request.
- Touch dimmable.

DETTAGLI

- Lampada da pavimento scultorea in vetro e pietra.
- Basamento disponibile nelle pietre di gamma.
- Il corpo luce è composto da 2 pezzi vetro soffiato da Venini Murano finitura grigia.
- Trasformatore incorporato nel basamento.
- Cavo elettrico nero (lungo 3 metri).
- La versione 237 cm è ancorata a soffitto.

FONTE LUMINOSA

- COB LED 24V 3000K.
- Su richiesta disponibile con luce extra calda a 2700K.
- Disponibile 110V su richiesta.
- Dimmerabile.

CONSTRUCTION SPECIFICATION

Weight: 108.2-186 kg
Material: Burnished Titanio with light source in blown glass
Finish: • Burnished Titanio
• Stones from our range
• Grey Glass finish

Certified Product
Prodotto certificato

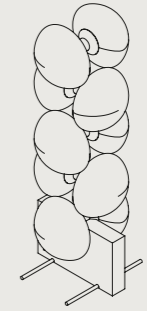

TECHNICAL DATA

Net Weight: 108.2 kg
Light source: Strip led 24 V
Input Voltage [V]: 220-240 V or 110-120 V upon request
Max Power [W]: 104 W
Light colour [K]: 3000 K or 2700 K upon request
Flux [lm]: 2700 K-13000 lm/3000 K-14800 lm**
CRI: >90
Dimming: Touch Switch dimmable

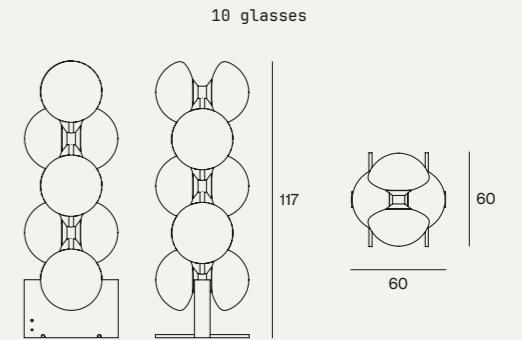

10 glasses

TECHNICAL DATA

Net Weight: 127.9 kg
Light source: Strip led 24 V
Input Voltage [V]: 220-240 V or 110-120 V upon request
Max Power [W]: 145 W
Light colour [K]: 3000 K or 2700 K upon request
Flux [lm]: 2700 K-18200 lm/3000 K-20720 lm**
CRI: >90
Dimming: Touch Switch dimmable

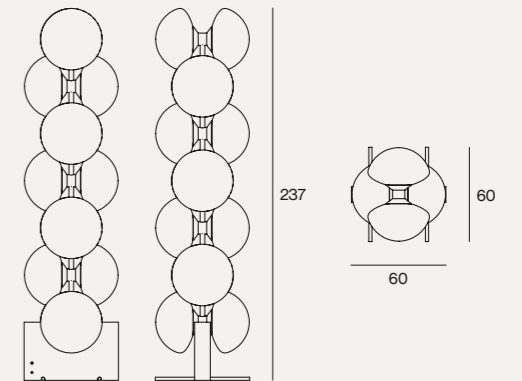

14 glasses
anchored to the ceiling

**Output of led inside the lamp. Losses due to diffusor and reflectors are not considered. Values are indicative, ambient temperature, height and position of the lamp may vary the values.
**Emissione del LED all'interno della lampada. Le perdite dovute a diffusore e riflettori non sono considerate. I valori sono indicativi: temperatura ambiente, altezza e posizione della lampada possono influenzare i valori.







FLAT

TABLE AND FLOR LAMPS

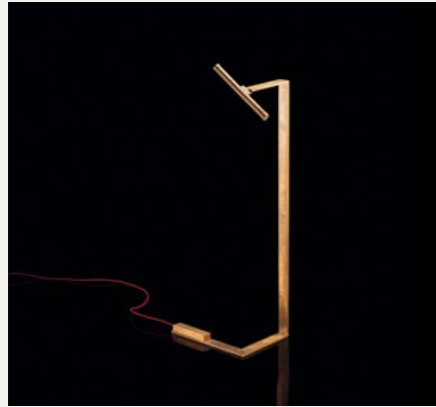

Floor lamp, Flat, expresses the luxury of rigor and functionality combined with essentiality. A flat brass stem, articulated with sculptural simplicity and incisiveness, playing with geometric lines and angles, defines the presence of a strong and sophisticated personality.

Lampada da terra, Flat, esprime il lusso del rigore e della funzionalità uniti all'essenzialità. Uno stelo piatto in ottone, articolato con scultorea semplicità e incisività, giocando con linee e angoli geometrici, definisce la presenza di una personalità forte e sofisticata.

DESIGNER
Massimo Castagna

DETAILS

- Sculptural floor light made of brass.
- Multi-directional light.
- Led light with energy efficiency index A++.
- Power supply cable coated with red silk (3 meters long).

LIGHT SOURCE

- LED spot 3000K.
- Upon request available with extra warm light 2700K.
- Available 110V upon request.
- On/Off with push-button.
- Touch dimmable upon request.

DETTAGLI

- Piantana scultorea in ottone.
- Luce multidirezionale.
- Luce a led con indice di efficienza energetica A++.
- Cavo elettrico rivestito di seta rossa (lungo 3 metri).

FONTE LUMINOSA

- LED spot 3000K.
- Su richiesta disponibile con luce extra calda a 2700K.
- Disponibile 110V su richiesta.
- On/Off con pulsante.
- Dimmerabile con pulsante touch su richiesta.

CONSTRUCTION SPECIFICATION

Weight: 2 kg-4,60 kg
Material: Metal
Finish: Burnished Brass, Black Burnished Brass
H-Silver, H-Silver Black

Certified Product
Prodotto certificato

CE ENEC IP20

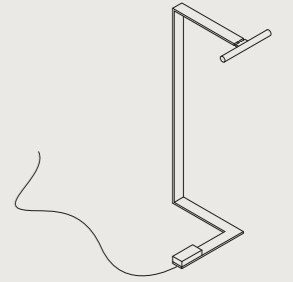

TECHNICAL DATA

Net Weight: 4,60 kg
Light source: LED spot Trio 350mA
Input Voltage [V]: 220-240 V or 110-120 V upon request
Max Power [W]: 3 W
Light colour [K]: 3000K or 2700 K upon request
Flux [lm]: 370 lm**
CRI: >80
Dimming: Touch switch dimmable upon request

3 mt plaited
power lead

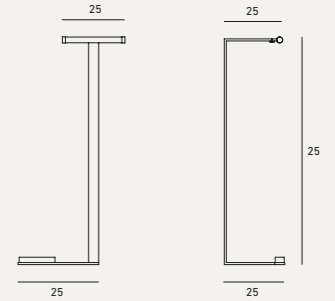

**Output of led inside the lamp. Losses due to diffusor and reflectors are not considered. Values are indicative, ambient temperature, height and position of the lamp may vary the values.
**Emissione del LED all'interno della lampada. Le perdite dovute a diffusore e riflettori non sono considerate. I valori sono indicativi: temperatura ambiente, altezza e posizione della lampada possono influenzare i valori.



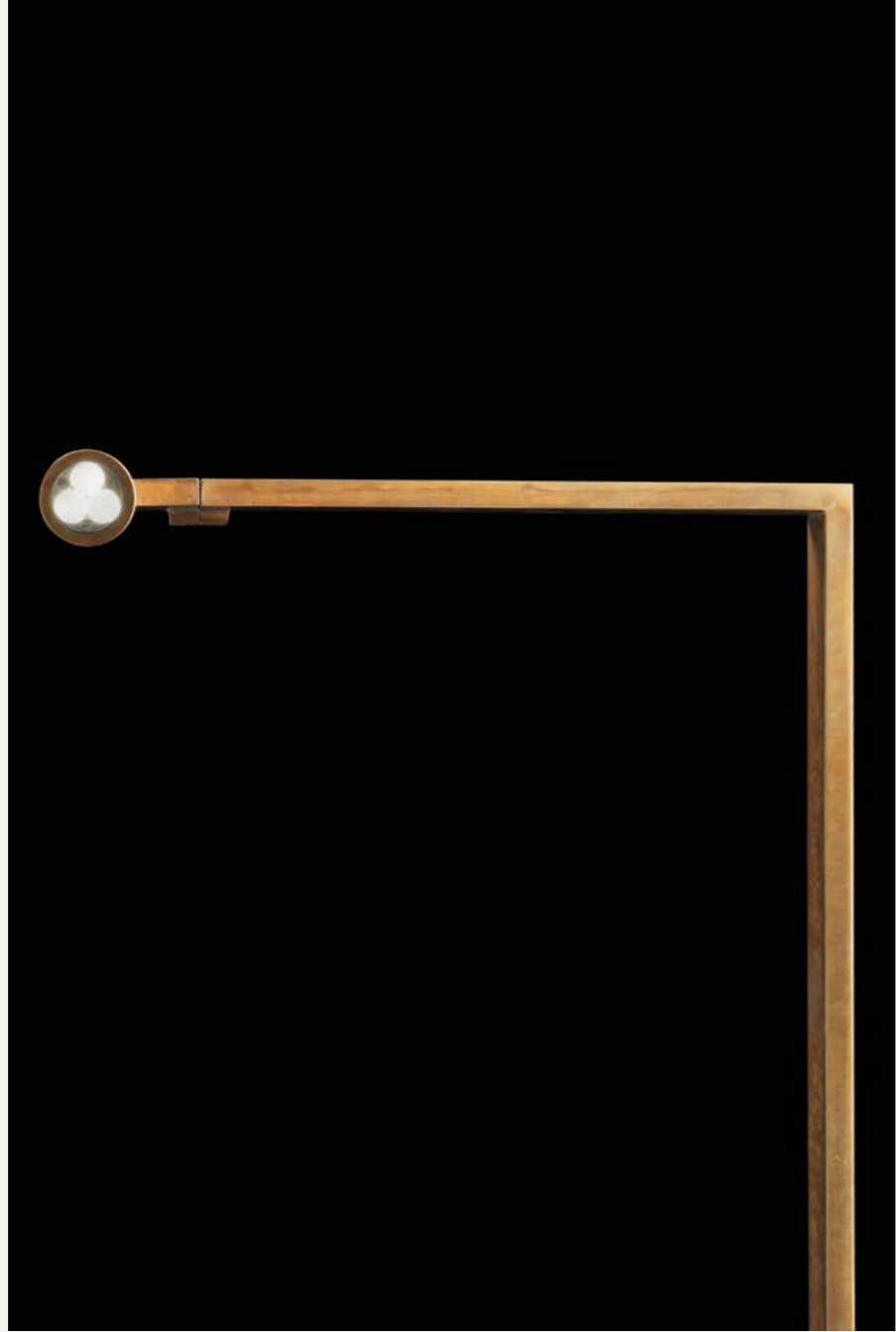

FLAT TABLE

TABLE AND FLOR LAMPS



Table lamp, Flat, expresses the luxury of rigor and functionality combined with essentiality. A flat brass stem, articulated with sculptural simplicity and incisiveness, playing with geometric lines and angles, defines the presence of a strong and sophisticated personality.

Lampada da tavolo, Flat, esprime il lusso del rigore e della funzionalità uniti all'essenzialità. Uno stelo piatto in ottone, articolato con scultorea semplicità e incisività, giocando con linee e angoli geometrici, definisce la presenza di una personalità forte e sofisticata.

DESIGNER
Massimo Castagna

DETAILS

- Sculptural floor light made of brass.
- Multi-directional light.
- Led light with energy efficiency index A++.
- Power supply cable coated with red silk (3 meters long).
- Counterweight in stone from our range.

LIGHT SOURCE

- LED spot 3000K.
- Upon request available with extra warm light 2700K.
- Available 110V upon request.
- On/Off with push-button.
- Touch dimmable upon request.

DETTAGLI

- Piantana scultorea in ottone.
- Luce multidirezionale.
- Luce a led con indice di efficienza energetica A++.
- Cavo elettrico rivestito di seta rossa (lungo 3 metri).
- Contrappeso in pietra di gamma.

FONTE LUMINOSA

- LED spot 3000K.
- Su richiesta disponibile con luce extra calda a 2700K.
- Disponibile 110V su richiesta.
- On/Off con pulsante.
- Dimmerabile con pulsante touch su richiesta.

CONSTRUCTION SPECIFICATION

Weight: 2 kg-4,60 kg
Material: Metal
Finish: Burnished Brass, Black Burnished Brass
H-Silver, H-Silver Black

Certified Product
Prodotto certificato

CE EAC IP20

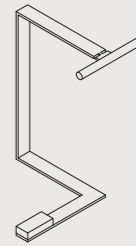

TECHNICAL DATA

Net Weight: 2 kg
Light source: LED spot Trio 350mA
Input Voltage [V]: 220-240 V or 110-120 V upon request
Max Power [W]: 3 W
Light colour [K]: 3000K or 2700 K upon request
Flux [lm]: 370 lm**
CRI: >80
Dimming: Touch switch dimmable upon request

2 mt plaited
power lead

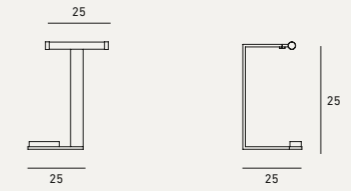

**Output of led inside the lamp. Losses due to diffusor and reflectors are not considered. Values are indicative, ambient temperature, height and position of the lamp may vary the values.
**Emissione del LED all'interno della lampada. Le perdite dovute a diffusore e riflettori non sono considerate. I valori sono indicativi: temperatura ambiente, altezza e posizione della lampada possono influenzare i valori.

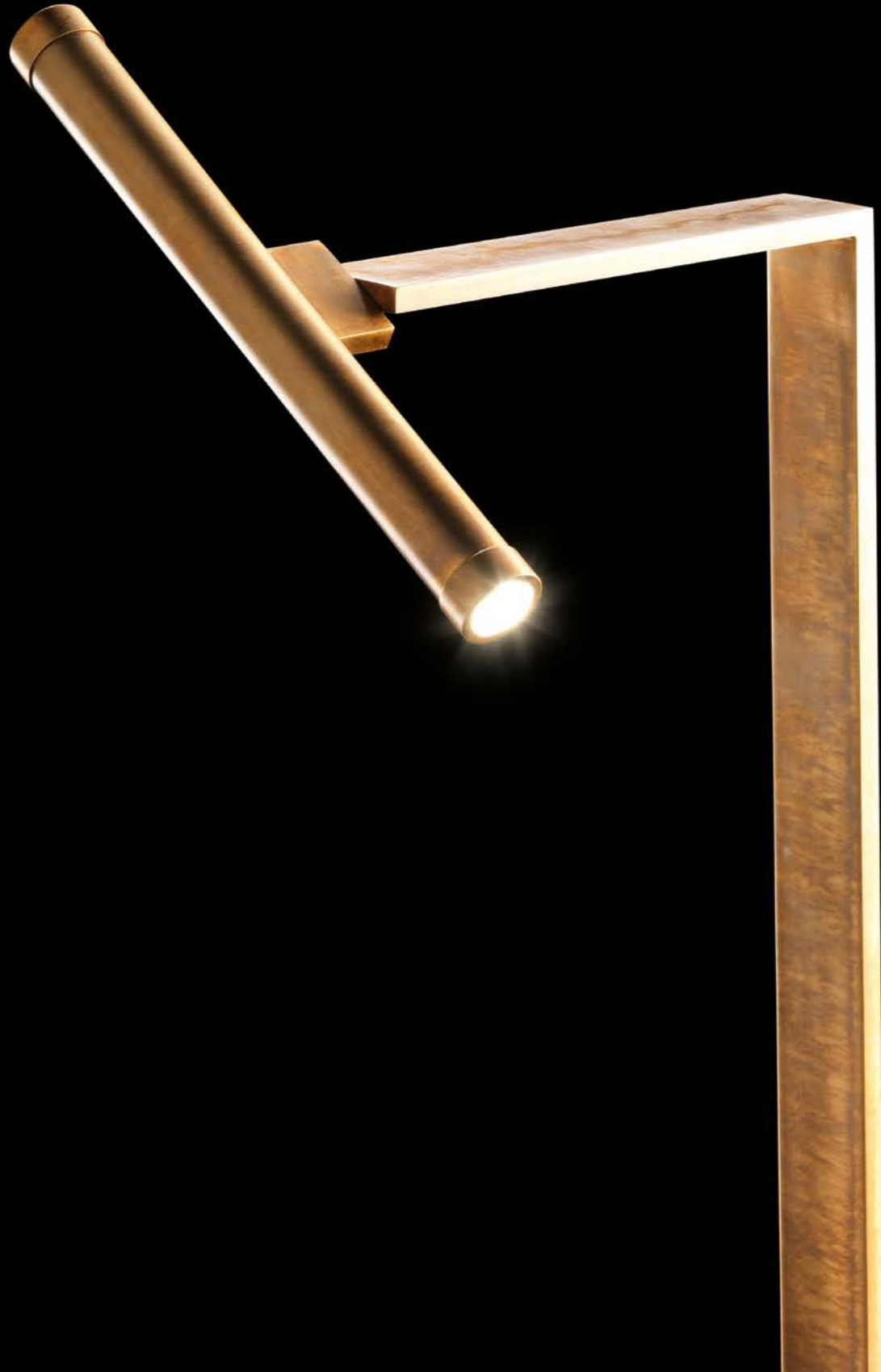

GHOST LAMP

TABLE AND FLOR LAMPS



A central cylindrical body in resin, matched with hand-burnished metals, becomes a vivid and intense note that fascinates with the unexpected possibilities of chromatic transformations provoked by the light. Its totemic presence, on a table or pendant, single or replicated, confers to any interior special accents of identity.

Un corpo cilindrico centrale in resina, abbinato a metalli bruniti a mano, diventa una nota vivida e intensa che affascina per le inaspettate possibilità di trasformazioni cromatiche provocate dalla luce. La sua presenza totemica, su un tavolo o pendente, singolo o replicato, conferisce a qualsiasi interno speciali accenti di identità.

DESIGNER
Massimo Castagna

DETAILS

- Central component made of transparent or grey resin, Ø 9 cm.
- The metal lamp shade can be personalized.
- Pendant energy-saving LED light (Energy efficiency index A).
- Standard total height cm 180h.

LIGHT SOURCE

- AC LED BOARD 3000 K - 220-240V
- Upon request available with extra warm light 2700 K.
- Upon request available 110-120 V.
- Wired version not dimmable, rechargeable version touch dimmable.

DETTAGLI

- Componente centrale in resina trasparente o grigia, Ø 9 cm.
- Il paralume in metallo può essere personalizzato.
- Sospensione a led a risparmio energetico (Indice di efficienza energetica A).
- Altezza totale standard cm 180h.

FONTE LUMINOSA

- SCHEDA LED AC 3000 K - 220-240V
- Su richiesta disponibile con luce extra calda 2700 K.
- Su richiesta disponibile 110-120 V.
- Versione cablata non dimmerabile, versione ricaricabile touch dimmerabile.

CONSTRUCTION SPECIFICATION

Weight: 3,90 kg-4,20 kg
Material: • Lampshade in metal
• Central element in transparent or grey resin
Finish: Black Burnished Steel, Burnished Titanio, Burnished Platino, Burnished Brass, Black Burnished Brass, H-Silver, H-Silver Black

Certified Product
Prodotto certificato

CE EAC IP20

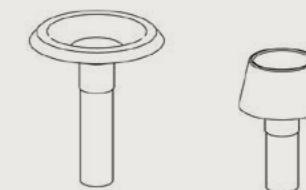

TECHNICAL DATA

Net Weight: 3.9 kg
Light source: AC LED BOARD
Input Voltage [V]: 220-240 V or 110-120 V upon request
Max Power [W]: 4.5 W
Light colour [K]: 3000 K or 2700 K upon request
Flux [lm]: 456 lm**
(275 lm for rechargeable lamp)
CRI: >80
Dimming: On/Off. Touch switch dimmable for rechargeable version only

Ghost Lamp Ø25

Available in a rechargeable version



TECHNICAL DATA

Net Weight: 4.2 kg
Light source: AC LED BOARD
Input Voltage [V]: 220-240 V or 110-120 V upon request
Max Power [W]: 4.5 W
Light colour [K]: 3000 K or 2700 K upon request
Flux [lm]: 456 lm**
(275 lm for rechargeable lamp)
CRI: >80
Dimming: On/Off. Touch switch dimmable for rechargeable version only

Ghost Lamp Ø38

Available in a rechargeable version



**Output of led inside the lamp. Losses due to diffusor and reflectors are not considered. Values are indicative, ambient temperature, height and position of the lamp may vary the values.
**Emissione del LED all'interno della lampada. Le perdite dovute a diffusore e riflettori non sono considerate. I valori sono indicativi: temperatura ambiente, altezza e posizione della lampada possono influenzare i valori.





PIPE L

TABLE AND FLOR LAMPS

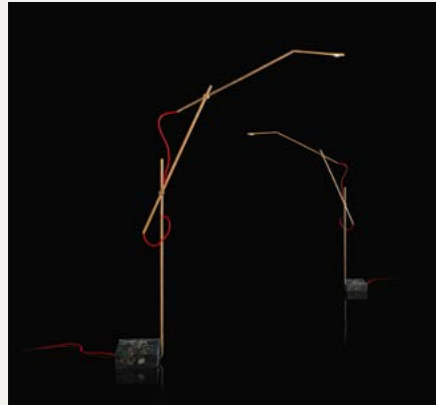

Flexible and slender, easily adjustable, Pipe Light, floor-standing, in burnished brass, celebrates with a contemporary spirit a minimalist aesthetic with an industrial flavor, characterized by evocative signs of the past.

Flessibile e slanciata, facilmente orientabile, Pipe Light, da terra, in ottone brunito, celebra con spirito contemporaneo un'estetica minimalista dal sapore industriale, caratterizzata da suggestivi segni del passato.

DESIGNER
Massimo Castagna

DETAILS

- Pendant light made of burnished brass.
- Ø 4.5 cm.
- Light Inclination adjustable.
- Steel wire suspension.
- Power supply cable coated with red silk.
- Standard overall height 250 cm.

LIGHT SOURCE

- Light bulb E 27 tungsten, warm light 3000K, blown glass ampoule with visible filament shaped like an old carbon light.
- Upon request available with extra warm light 2700K.
- Available 110V upon request.
- Phase cut dimmable.

DETTAGLI

- Lampada a sospensione in ottone brunito.
- Ø 4,5 cm.
- Inclinazione della luce regolabile.
- Sospensione in filo d'acciaio.
- Cavo di alimentazione rivestito di seta rossa.
- Altezza complessiva standard 250 cm.
- Su richiesta disponibile 110V.

FONTE LUMINOSA

- Lampadina E 27 tungsteno, luce calda, ampolla in vetro soffiato con filamento visibile a forma di vecchia luce al carbonio.
- Su richiesta disponibile con luce extra calda a 2700K.
- Disponibile 110V su richiesta.
- Dimmerabile taglio di fase.

CONSTRUCTION SPECIFICATION

Weight: 4,10 kg
Material: Brass with stone base
Finish: Red Silk power lead cover
Burnished Brass

Certified Product
Prodotto certificato

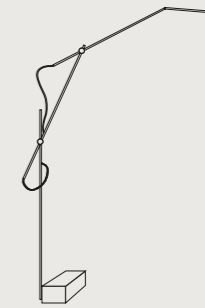

TECHNICAL DATA

Net Weight: 4,10 kg
Light source: Led-technology 24V
Input Voltage [V]: 220-240 V or 110-120 upon request
Max Power [W]: 6 W
Light colour [K]: 3000 K
Flux [lm]: 565 lm**
CRI: >90
Dimming: Not dimmable

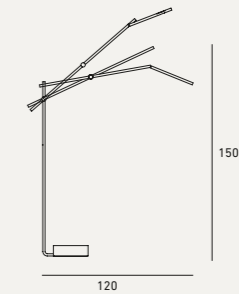

**Output of led inside the lamp. Losses due to diffusor and reflectors are not considered. Values are indicative, ambient temperature, height and position of the lamp may vary the values.
**Emissione del LED all'interno della lampada. Le perdite dovute a diffusore e riflettori non sono considerate. I valori sono indicativi: temperatura ambiente, altezza e posizione della lampada possono influenzare i valori.





STALAGMITE

LAMPS/CHANDELIERS



STALAGMITE ascends from the floor like a tall, deconstructed sculptural totem, vibrating ethereal with surprising chromatic effects. The clean lines of the dichroic glass play with light, radiating shimmers and scattering beams in an unexpected dance of shifting hues. A luminous presence that dissolves the boundary between design and art.

STALAGMITE si erge dal pavimento come un alto totem scultoreo decostruito, vibrando eterea con sorprendenti effetti cromatici. Le linee pulite del vetro dicroico giocano con la luce, irradiando riflessi e diffondendo fasci di luce in un'inaspettata danza di tonalità cangianti. Una presenza luminosa che dissolve il confine tra design e arte.

DESIGNER
Johanna Grawunder

DETAILS

- Sculptural floor dichroic glass lamp with metal structure in Burnished Titanio or Platino, Burnished Brass or Brass Patina.
- Energy-saving with warm COB LED light (energy efficiency index A).
- Switch and dimming touch functions.
- Transformer incorporated in the structure.
- Upon request available with extra warm light 2700K (no extra cost).
- Voltage: 240V, 220V or 110V available upon request.

DETTAGLI

- Lampada da pavimento scultorea in vetro dicroico con struttura in Titanio o Platino Brunito, Ottone Brunito o Ottone Patina.
- Risparmio energetico con luce LED COB calda (indice di efficienza energetica A).
- Funzioni di accensione e dimmer touch.
- Trasformatore incorporato nella base.
- A richiesta disponibile con luce extra calda 2700K (senza sovrapprezzo).
- Tensione: 240V, 220V o 110V disponibile su richiesta.

CONSTRUCTION SPECIFICATION

Weight: 50 kg
Material: Metal, Dichroic Glass
Finish: Burnished Titanio or Platino, Burnished Brass or Brass Patina

Certified Product
Prodotto certificato



TECHNICAL DATA

Net Weight: 50 kg
Light source: Upward / Downward COB LED
Input Voltage [V]: 220-240 V or 110-120 V upon request
Max Power [W]: 17 W
Light colour [K]: 3000 K or 2700 K upon request
Flux [lm]: 2700 K - 2230 lm / 3000 K - 2365 lm**
CRI: >90
Dimming: Push / Phase cut / 0-10 V / 1-10 V / DMX / DALI-2 dimmable



**Output of led inside the lamp. Losses due to diffusor and reflectors are not considered. Values are indicative, ambient temperature, height and position of the lamp may vary the values.
**Emissione del LED all'interno della lampada. Le perdite dovute a diffusore e riflettori non sono considerate. I valori sono indicativi: temperatura ambiente, altezza e posizione della lampada possono influenzare i valori.





TEST-ONE

TABLE AND FLOR LAMPS



A table lamp, the Test series is an elegant and slender stone monolith, characterized by essential lines and rich material opulence. A presence with a strong personality that reveals a hidden expressive soul: brutalism that transforms into sculptural opalescence or lights up through its natural cavities, conspiring for sophisticated atmospheres of intimacy.

Lampada da tavolo, la serie Test è un monolite di pietra elegante e slanciato, caratterizzato da linee essenziali e ricca opulenza materica. Una presenza dalla forte personalità che rivela un'anima espressiva nascosta: il brutalismo che si trasforma in opalescenza scultorea o si illumina attraverso le sue naturali cavità, cospirando per sofisticate atmosfere di intimità.

DESIGNER
Ugo Cacciatori

DETAILS

- Sculptural stone table lamp with hollowed monolithic body.
- Available in Ice Onyx or Rapolano Travertine.
- The body is made of 2 pieces of stone joined by a metal ring (Burnished Brass or Burnished Titanium).
- Energy-saving LED light (energy efficiency index A).
- Transformer incorporated in a metal box matching the color of the ring.
- Plug incorporated in a metal cap matching the color of the ring.
- Power supply cable coated with metal cord (3 meters long).

LIGHT SOURCE

- LED 24V 3000K.
- Upon request available with extra warm light 2700K.
- Available 110V upon request.
- Touch dimmable.

DETTAGLI

- Lampada da tavolo scultorea in pietra con corpo monolitico scavato.
- Disponibile in Ice Onyx o Travertino di Rapolano.
- Il corpo è composto da 2 pezzi di pietra uniti da una ghiera in metallo (ottone o Titanio brunito) con funzioni di accensione e dimmer touch.
- Led a risparmio energetico (Indice di efficienza energetica A).
- Trasformatore incorporato in una scatola metallica abbinata al colore dell'anello.
- Spina incorporata in un cappuccio metallico abbinato al colore dell'anello.
- Cavo elettrico rivestito in metallo (lungo 3 metri).

FONTE LUMINOSA

- LED 24V 3000K.
- Su richiesta disponibile con luce extra calda a 2700K.
- Disponibile 110V su richiesta.
- Dimmerabile touch.

CONSTRUCTION SPECIFICATION

Weight: 11 kg
Material: Stone
Finish: Ice Onyx, Rapolano Stone

Certified Product
Prodotto certificato

CE ENEC IP20



TECHNICAL DATA

Net Weight: 11 kg
Light source: strip LED 24V
Input Voltage [V]: 220-240 V or 110-120 upon request
Max Power [W]: 67 W
Light colour [K]: 3000 K or 2700 K upon request
Flux [lm]: 2700 K-1599 lm; 3000 K-1755 lm**
CRI: >90
Dimming: Touch switch dimmable

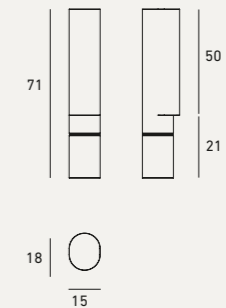

**Output of led inside the lamp. Losses due to diffusor and reflectors are not considered. Values are indicative, ambient temperature, height and position of the lamp may vary the values.
**Emissione del LED all'interno della lampada. Le perdite dovute a diffusore e riflettori non sono considerate. I valori sono indicativi: temperatura ambiente, altezza e posizione della lampada possono influenzare i valori.



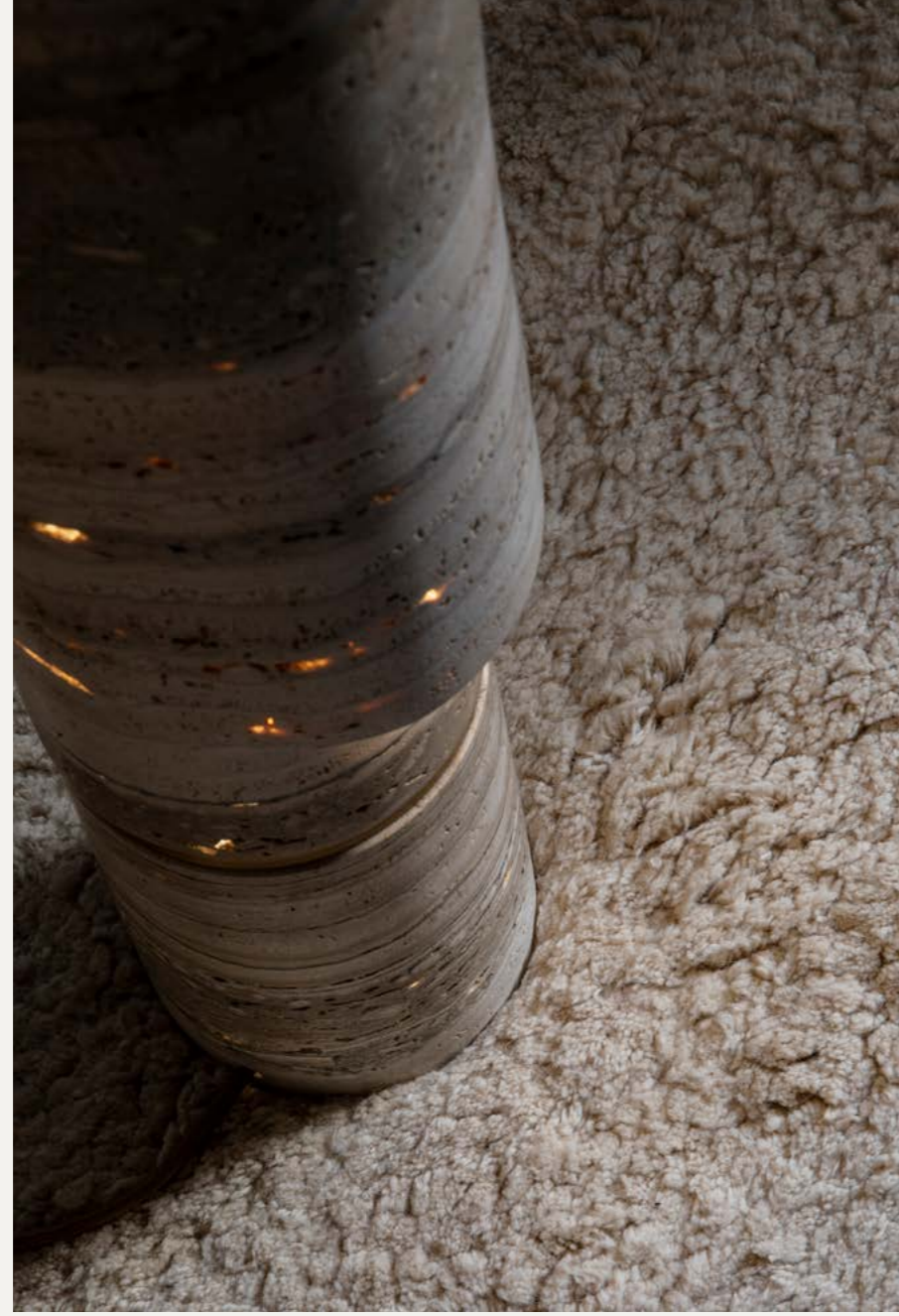

TEST-TWO

TABLE AND FLOR LAMPS



A floor lamp, the Test series is an elegant and slender stone monolith, characterized by essential lines and rich material opulence. A presence with a strong personality that reveals a hidden expressive soul: brutalism that transforms into sculptural opalescence or lights up through its natural cavities, conspiring for sophisticated atmospheres of intimacy.

Lampada da terra, la serie Test è un monolite di pietra elegante e slanciato, caratterizzato da linee essenziali e ricca opulenza materica. Una presenza dalla forte personalità che rivela un'anima espressiva nascosta: il brutalismo che si trasforma in opalescenza scultorea o si illumina attraverso le sue naturali cavità, cospirando per sofisticate atmosfere di intimità.

DESIGNER
Ugo Cacciatori

DETAILS

- Sculptural stone table lamp with hollowed monolithic body.
- Available in Ice Onyx or Rapolano Travertine.
- The body is made of 2 pieces of stone joined by a metal ring (Burnished Brass or Burnished Titanium).
- Energy-saving LED light (energy efficiency index A).
- Transformer incorporated in a metal box matching the color of the ring.
- Plug incorporated in a metal cap matching the color of the ring.
- Power supply cable coated with metal cord (3 meters long).

LIGHT SOURCE

- LED 24V 3000K.
- Upon request available with extra warm light 2700K.
- Available 110V upon request.
- Touch dimmable.

DETTAGLI

- Lampada da tavolo scultorea in pietra con corpo monolitico scavato.
- Disponibile in Ice Onyx o Travertino di Rapolano.
- Il corpo è composto da 2 pezzi di pietra uniti da una ghiera in metallo (ottone o Titanio brunito) con funzioni di accensione e dimmer touch.
- Led a risparmio energetico (Indice di efficienza energetica A).
- Trasformatore incorporato in una scatola metallica abbinata al colore dell'anello.
- Spina incorporata in un cappuccio metallico abbinato al colore dell'anello.
- Cavo elettrico rivestito in metallo (lungo 3 metri).

FONTE LUMINOSA

- LED 24V 3000K.
- Su richiesta disponibile con luce extra calda a 2700K.
- Disponibile 110V su richiesta.
- Dimmerabile touch.

CONSTRUCTION SPECIFICATION

Weight: 25 kg
Material: Stone and brass joints
Finish: Ice Onyx, Rapolano Stone

Certified Product
Prodotto certificato

CE ENEC IP20

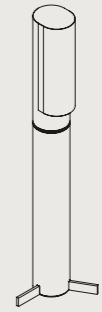

TECHNICAL DATA

Net Weight: 25 kg
Light source: strip LED 24 V
Input Voltage [V]: 220-240 V or 110-120 V upon request
Max Power [W]: 67 W
Light colour [K]: 3000 K or 2700 K upon request
Flux [lm]: 2700 K-2952 lm/3000 K-3240 lm**
CRI: >90
Dimming: Touch switch dimmable

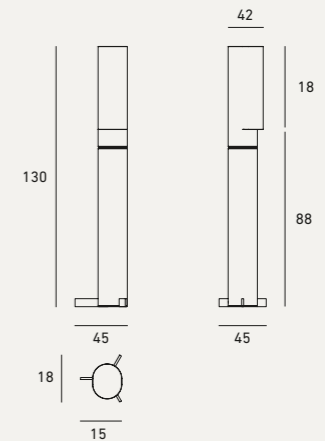

**Output of led inside the lamp. Losses due to diffusor and reflectors are not considered. Values are indicative, ambient temperature, height and position of the lamp may vary the values.
**Emissione del LED all'interno della lampada. Le perdite dovute a diffusore e riflettori non sono considerate. I valori sono indicativi: temperatura ambiente, altezza e posizione della lampada possono influenzare i valori.







TEST-TREE

TABLE AND FLOR LAMPS



Eccentric and sophisticated, in an extravagant high-tech interpretation, the floor lamp, Test-tree, synthesizes classic and contemporary in its minimal geometric structure. The slender silhouette of its segmented body, embellished with cylindrical diffusers in Ice Onyx, connected by brass joints, becomes in any ambience a catalyzing focal point.

Eccentrica e sofisticata, in una stravagante interpretazione high-tech, la lampada da terra Test-tree sintetizza classico e contemporaneo nella sua struttura geometrica minimale. La silhouette slanciata del suo corpo segmentato, impreziosito da diffusori cilindrici in Onice Ghiaccio, collegati da giunti in ottone, diventa in ogni ambiente un punto focale catalizzatore.

CONSTRUCTION SPECIFICATION

Weight: 16 kg
Material: Stone and brass joints
Finish: Ice Onyx

Certified Product
Prodotto certificato



TECHNICAL DATA

Net Weight: 16 kg
Light source: strip LED 24V
Input Voltage [V]: 220-240 V or 110-120 upon request
Max Power [W]: 67 W
Light colour [K]: 3000 K or 2700 K upon request
Flux [lm]: 2700 K-5002 lm; 3000 K-5490 lm**
CRI: >90
Dimming: Touch switch dimmable

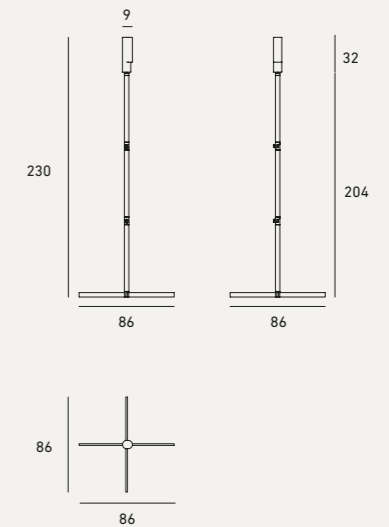

DESIGNER
Ugo Cacciatori

DETAILS

- Sculptural stone floor lamp with hollowed monolithic body.
- Available only in Ice Onyx.
- The body is made of 4 pieces of Onyx connected by 3 directional metal joints (Burnished Brass).
- Energy-saving LED light (energy efficiency index A).
- Transformer incorporated in a metal box matching the color of the joints with an On/Off and dimming button.
- Plug incorporated in a metal cap matching the color of the joints.
- Power supply cable coated with metal cord (2.5 meters long).

LIGHT SOURCE

- LED 24V 3000K.
- Upon request available with extra warm light 2700K.
- Available 110V upon request.
- Dimming function included.

DETTAGLI

- Lampada da tavolo scultorea in pietra con corpo monolitico scavato.
- Disponibile in Ice Onyx.
- Il corpo è composto da 4 pezzi di onice uniti da 3 snodi in metallo (ottone brunito).
- Led a risparmio energetico (Indice di efficienza energetica A).
- Trasformatore incorporato in una scatola metallica abbinata al colore dell'anello con interruttore On/Off e dimmer.
- Spina incorporata in un cappuccio metallico abbinato al colore dell'anello.
- Cavo elettrico rivestito in metallo (lungo 2,5 metri).

FONTE LUMINOSA

- LED 24V 3000K.
- Su richiesta disponibile con luce extra calda a 2700K.
- Disponibile 110V su richiesta.
- Dimmerabile.

**Output of led inside the lamp. Losses due to diffusor and reflectors are not considered. Values are indicative, ambient temperature, height and position of the lamp may vary the values.
**Emissione del LED all'interno della lampada. Le perdite dovute a diffusore e riflettori non sono considerate. I valori sono indicativi: temperatura ambiente, altezza e posizione della lampada possono influenzare i valori.





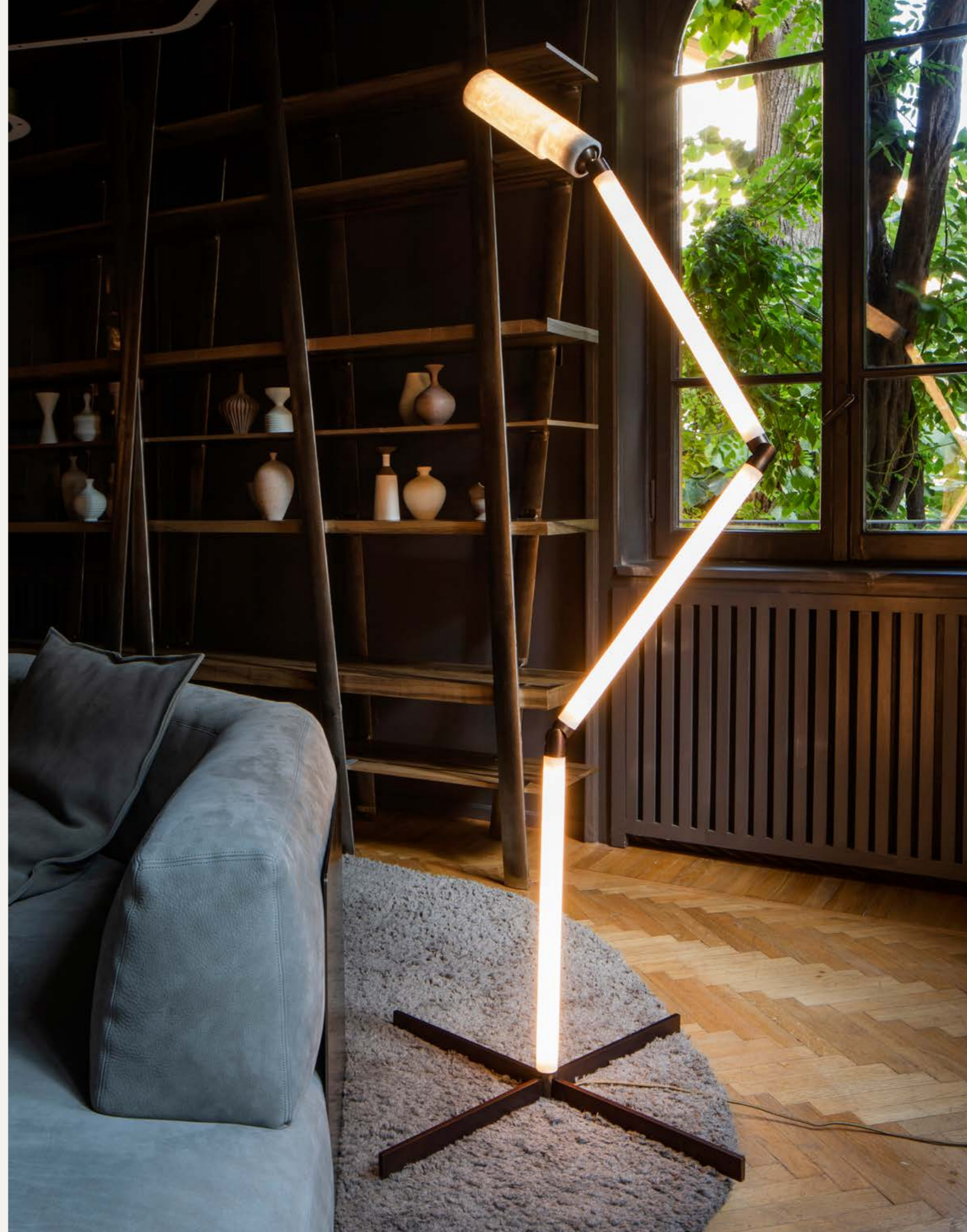

CHANDELIERS

AIRLIGHT

CHANDELIERS



From a synthesis between materiality and transparency emerges a strong stage presence. Delicate polyhedral glass diffusers blown by masters of Murano, suspended from a brass support structure, display a magnetic allure, radiating with a choreographic three-dimensional play of swirls and reflections a sophisticated and precious aura.

Da una sintesi tra materialità e trasparenza emerge una forte presenza scenica. Delicati diffusori poliedrici in vetro soffiato da maestri muranesi, sospesi ad una struttura portante in ottone, manifestano un'allure magnetica, irradiando con un coreografico gioco tridimensionale di volute e riflessi un'aura sofisticata e preziosa.

DESIGNER
Massimo Castagna

DETAILS

- Irregular polyhedral shape tubes made of Murano Glass cm 85h.
- Transparent or Grey Glass.
- Available in 3 different configurations.
- Total height including metal stems cm 180h.

LIGHT SOURCE

- Led bulb light G9 3000K, phase cut dimmable.
- Optional led bulb 2700 K.
- Available upon request 110V.

DETTAGLI

- Tubi di forma poliedrica irregolare in Vetro di Murano cm 85h.
- Vetro Trasparente o Grigio.
- Disponibile in 3 diverse configurazioni.
- Altezza totale compresi steli in metallo cm 180h.

FONTE LUMINOSA

- Lampadina a led G9 3000K, dimmerabile a taglio di fase.
- Lampadina led opzionale 2700 K.
- Disponibile su richiesta 110V.

CONSTRUCTION SPECIFICATION

Weight: 6.3-117.3 kg
Material: Metal and Glass
Finish:
• Burnished Brass-Transparent Glass
• Black Burnished Steel-Grey Glass

Certified Product
Prodotto certificato **CE EAC IP20**

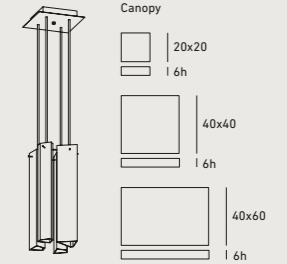

TECHNICAL DATA

Net Weight: 22.2 kg (A 6.3 kg/B 7.4 kg/C 8.5 kg)
Light source: 69 led bulb
Input Voltage [V]: 220-240 V or 110-120 V upon request
Max Power [W]: 9 W-2700 K/12 W-3000 K
Light colour [K]: 2700 K or 3000 K
Flux [lm]: 2700 K-750 lm/3000 K-990 lm**
CRI: 80
Dimming: Dimmable (phase cut for 2700K only), not dimmable 3000 K

1 Element

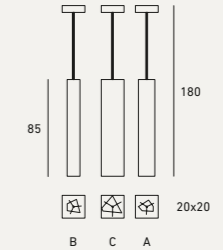

TECHNICAL DATA

Net Weight: 117.3 kg
Light source: 69 led bulb
Input Voltage [V]: 220-240 V or 110-120 V upon request
Max Power [W]: 48 W-2700 K/64 W-3000 K
Light colour [K]: 2700 K or 3000 K
Flux [lm]: 2700 K-4000 lm/3000 K-5.280 lm**
CRI: 80
Dimming: Dimmable (phase cut for 2700 K only), not dimmable 3000 K

4 Elements

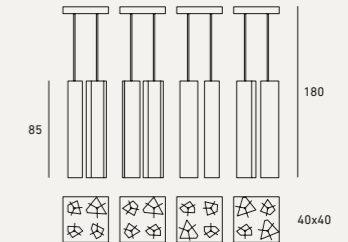

TECHNICAL DATA

Net Weight: 88.8 kg
Light source: 69 led bulb
Input Voltage [V]: 220-240 V or 110-120 V upon request
Max Power [W]: 36 W-2700 K/48 W-3000 K
Light colour [K]: 2700 K or 3000 K
Flux [lm]: 2700 K-3000 lm/3000 K-3.960 lm**
CRI: 80
Dimming: Dimmable (phase cut for 2700 K only), not dimmable 3000 K

6 Elements

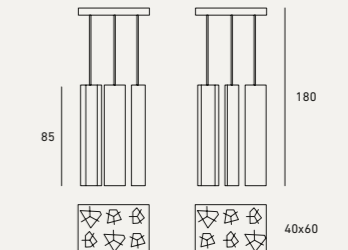

**Output of led inside the lamp. Losses due to diffusor and reflectors are not considered. Values are indicative, ambient temperature, height and position of the lamp may vary the values.
**Emissione del LED all'interno della lampada. Le perdite dovute a diffusore e riflettori non sono considerate. I valori sono indicativi: temperatura ambiente, altezza e posizione della lampada possono influenzare i valori.

TECHNICAL DATA

Net Weight: 117.3 kg
 Light source: 69 led bulb
 Input Voltage [V]: 220-240 V or 110-120 V upon request
 Max Power [W]: 48 W - 2700 K / 64 W - 3000 K
 Light colour [K]: 2700 K or 3000 K
 Flux [lm]: 2700 K - 4000 lm / 3000 K - 5.280 lm**
 CRI: 80
 Dimming: Dimmable (phase cut for 2700 K only),
 not dimmable 3000 K

4 Elements

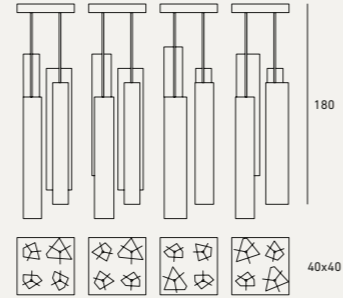

TECHNICAL DATA

Net Weight: 88.8 kg
 Light source: 69 led bulb
 Input Voltage [V]: 220-240 V or 110-120 V upon request
 Max Power [W]: 36 W - 2700 K / 48 W - 3000 K
 Light colour [K]: 2700 K or 3000 K
 Flux [lm]: 2700 K - 3000 lm / 3000 K - 3.960 lm**
 CRI: 80
 Dimming: Dimmable (phase cut for 2700 K only),
 not dimmable 3000 K

6 Elements

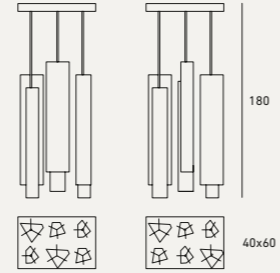

BAT

CHANDELIERS



Organic forms, stemming from nature, propose simple and delicate entities of great aesthetic appeal. Individually or in small clusters, they diffuse warm and discreet light, reiterating harmonious natural rhythms with their balanced compositional structures.

Forme organiche, nate dalla natura, propongono entità semplici e delicate di grande fascino estetico. Singolarmente o a piccoli grappoli, diffondono una luce calda e discreta, ripetendo armoniosi ritmi naturali con le loro equilibrate strutture compositive.

DESIGNER
Massimo Castagna

DETAILS

- Ceiling led light made of Burnished Brass.
- Energy-saving with warm light (energy efficiency index A).
- Transformer incorporated in the lamp.

LIGHT SOURCE

- LED 24V 3000K.
- Upon request available with extra warm light 2700K.
- Available 110V upon request.
- Dimming function included.

DETTAGLI

- Lampada a soffitto a led realizzata in Ottone Brunito.
- Risparmio energetico con luce calda (efficienza energetica di tipo A).
- Trasformatore incorporato.

DISPONIBILE SU RICHIESTA

- LED 24V 3000K.
- Su richiesta disponibile con luce extra calda a 2700K.
- Disponibile 110V su richiesta.
- Dimmerabile.

CONSTRUCTION SPECIFICATION

Weight: 5,5 kg-7 kg
Material: Metal
Finish: Burnished Brass, Black Burnished Brass

Certified Product
Prodotto certificato

CE EAC IP20

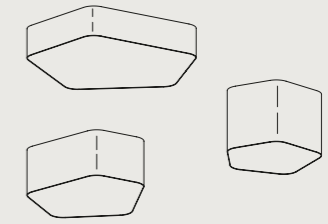

TECHNICAL DATA

Net Weight: 5.5 kg
Light source: strip LED 24 V
Input Voltage [V]: 220-240 V or 110-120 V upon request
Max Power [W]: 16.32 W
Light colour [K]: 3000 K or 2700 K upon request
Flux [lm]: 2700 K - 2125 lm / 3000 K - 2270 lm**
CRI: >90
Dimming: Push / Phase cut / 0-10 V / 1-10 V / DMX / DALI-2 dimmable

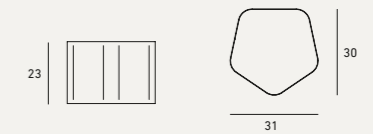

TECHNICAL DATA

Net Weight: 5.9 kg
Light source: strip LED 24 V
Input Voltage [V]: 220-240V or 110-120 V upon request
Max Power [W]: 19.20 W
Light colour [K]: 3000 K or 2700 K upon request
FLux [lm]: 2700 K - 2500 lm / 3000 K - 2670 lm**
CRI: >90
Dimming: Push / Phase cut / 0-10 V / 1-10 V / DMX / DALI-2 dimmable

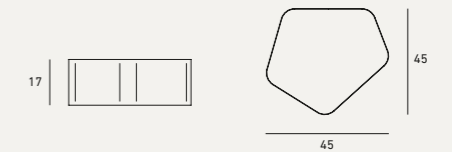

TECHNICAL DATA

Net Weight: 7 kg
Light source: strip LED 24 V
Input Voltage [V]: 220-240 V or 110-120 V upon request
Max Power [W]: 42.24 W
Light colour [K]: 3000 K or 2700 K upon request
Flux [lm]: 2700 K - 5500 lm / 3000 K - 5874 lm**
CRI: 90
Dimming: Push / Phase cut / 0-10 V / 1-10 V / DMX / DALI-2 dimmable

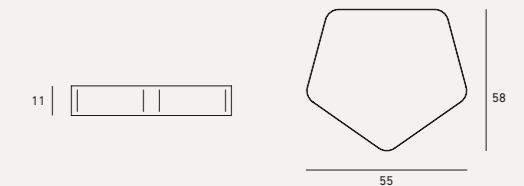

**Output of led inside the lamp. Losses due to diffusor and reflectors are not considered. Values are indicative, ambient temperature, height and position of the lamp may vary the values.
**Emissione del LED all'interno della lampada. Le perdite dovute a diffusore e riflettori non sono considerate. I valori sono indicativi: temperatura ambiente, altezza e posizione della lampada possono influenzare i valori.





CRYSTAL

CHANDELIERS



Long rectangular rods hover lightly in the air, displaying choreographic compositions, synergies between creativity and rigor, spectacularity and control, exhibiting alchemies of light, and translucencies of arabesque textures.

Lunghe aste rettangolari si librano leggere nell'aria, mostrando composizioni coreografiche, sinergie tra creatività e rigore, spettacolarità e controllo, esibendo alchimie di luce, trasparenze di trame arabesche.

DESIGNER
Massimo Castagna

DETAILS

- Central light source made of White Crystal.
- Pendant energy-saving led light (Energy efficiency index A).
- Low voltage power supplied through suspension cable.
- Transformer integrated into the ceiling rosette.
- Alternative mounting system with a remote transformer.
- Standard total height cm 180h.

LIGHT SOURCE

- LED 24V 3000K.
- Upon request available with extra warm light 2700K.
- Available 110V upon request.
- Dimming function included.

DETTAGLI

- Sorgente luminosa centrale in White Crystal.
- Sospensione a led a risparmio energetico (Indice di efficienza energetica A).
- Alimentazione a bassa tensione fornita tramite cavo di sospensione.
- Trasformatore incorporato nel rosone a soffitto.
- Sistema di montaggio alternativo con trasformatore remoto.
- Altezza totale standard cm 180h.

FONTE LUMINOSA

- LED 24V 3000K.
- Su richiesta disponibile con luce extra calda a 2700K.
- Disponibile 110V su richiesta.
- Dimmerabile.

CONSTRUCTION SPECIFICATION

Weight: 8.7 kg
Material: Metal
Finish:
• White Crystal stone
• Burnished Brass, Burnished Titanio,
Burnished Platino, Pale Gold Patina

Certified Product
Prodotto certificato

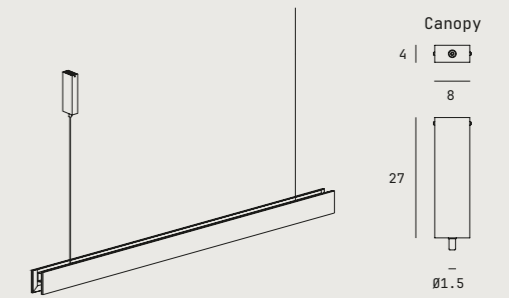

TECHNICAL DATA

Net Weight: 8.7 kg
Light source: strip LED 24 V
Input Voltage [V]: 220-240 V or 110-120 V upon request
Max Power [W]: 23.52 W
Light colour [K]: 3000 K or 2700 K upon request
FLUX [lm]: 2700 K - 3031 lm / 3000 K - 3199 lm**
CRI: >90
Dimming: Push / Phase cut / 0-10 V / 1-10 V / DMX / DALI-2 dimmable

Crystal
Single Element

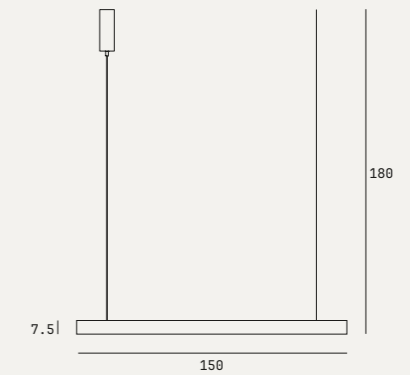

Crystal
Central Element

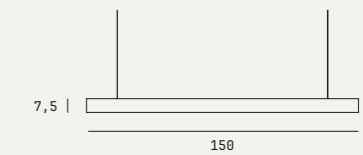

Crystal
Terminal Element



**Output of led inside the lamp. Losses due to diffusor and reflectors are not considered. Values are indicative, ambient temperature, height and position of the lamp may vary the values.
**Emissione del LED all'interno della lampada. Le perdite dovute a diffusore e riflettori non sono considerate. I valori sono indicativi: temperatura ambiente, altezza e posizione della lampada possono influenzare i valori.

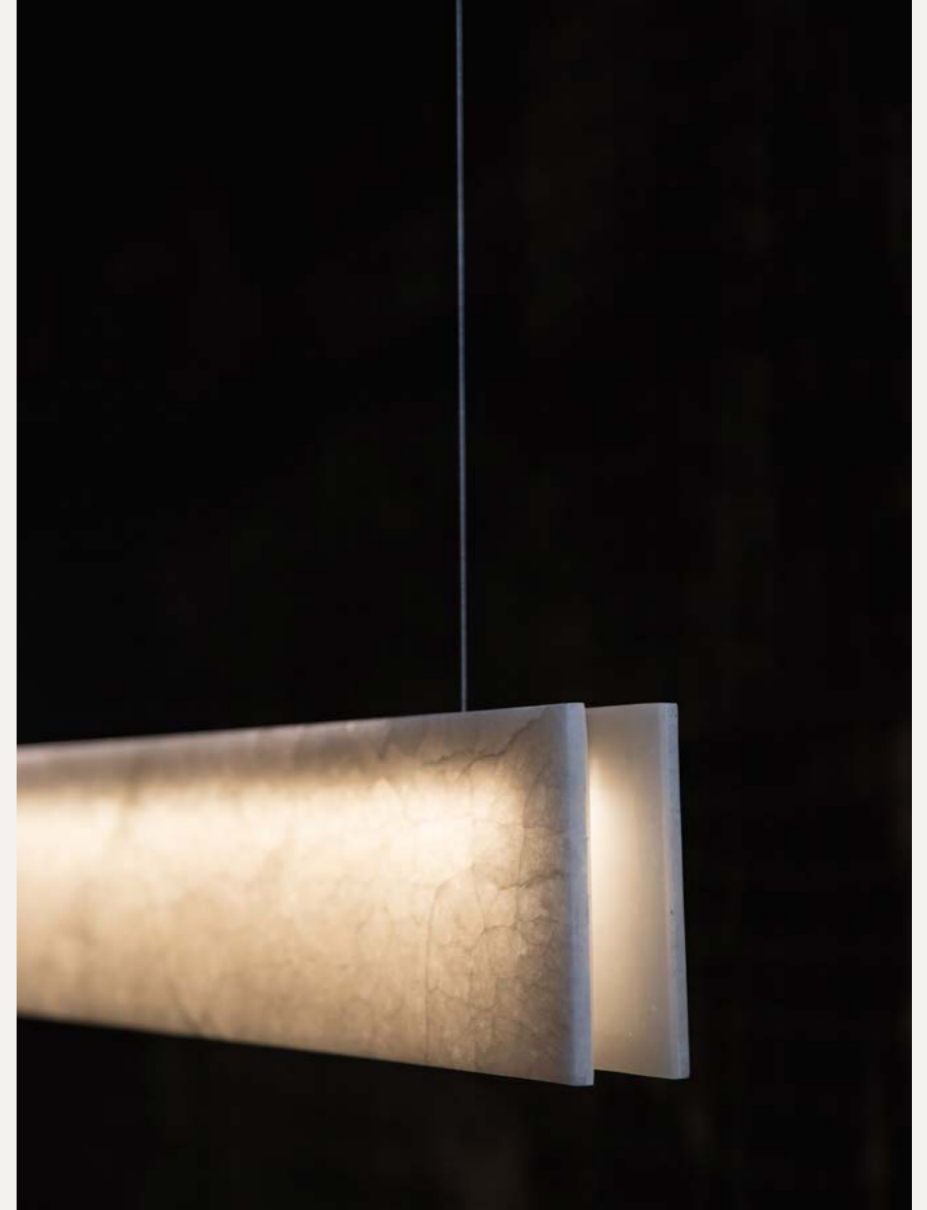



CRYSTAL EVO

CHANDELIERS



Long rectangular rods hover lightly in the air, displaying choreographic compositions, synergies between creativity and rigor, spectacularity and control, exhibiting alchemies of light, and translucencies of arabesque textures.

Lunghe aste rettangolari si librano leggere nell'aria, mostrando composizioni coreografiche, sinergie tra creatività e rigore, spettacolarità e controllo, esibendo alchimie di luce, trasparenze di trame arabesche.

CONSTRUCTION SPECIFICATION

Weight: 9.7 kg
Material: Metal frame in aluminum and brass, diffuser in stone lateral bands in leather
Finish:

- Burnished Brass (other finishes on demand)
- White Crystal stone
- Natural leather with dark red or black edges

Certified Product
 Prodotto certificato

CE EAC IP20

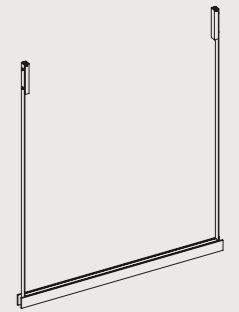

TECHNICAL DATA

Net Weight: 9.7 kg
Light source: strip LED 24 V
Input Voltage [V]: 220-240 V or 110-120 V upon request
Max Power [W]: 23.52 W
Light colour [K]: 3000 K or 2700 K upon request
FLux [lm]: 2700 K - 3031 lm / 3000 K - 3199 lm**
CRI: >90
Dimming: Push / Phase cut / 0-10 V / 1-10 V / DMX / DALI-2 dimmable

Crystal
 Single Element

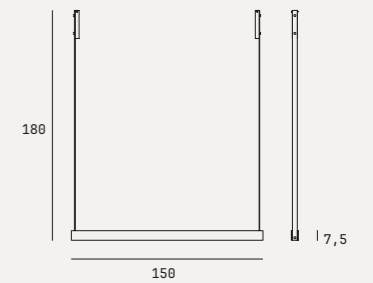

DESIGNER
 Massimo Castagna

DETAILS

- Central light source made of White Crystal.
- Side strips made of 4.5 cm cowhide leather available in natural or black color upon request.
- Pendant energy-saving led light (Energy efficiency index A).
- Low voltage power supplied through suspension cable.
- Transformer included in the ceiling rosette.
- Standard total height cm 180h.

DETTAGLI

- Sorgente luminosa centrale in White Crystal.
- Fasce laterali in pelle di vacchetta da 4,5 cm disponibili su richiesta nei colori naturale o nero.
- Sospensione a led a risparmio energetico (Indice di efficienza energetica A).
- Alimentazione a bassa tensione fornita tramite cavo di sospensione.
- Trasformatore incorporato nel rosone a soffitto.
- Altezza totale standard cm 180h.

FONTE LUMINOSA

- LED 24V 3000K.
- Su richiesta disponibile con luce extra calda a 2700K.
- Disponibile 110V su richiesta.
- Dimmerabile.

LIGHT SOURCE

- LED 24V 3000K.
- Upon request available with extra warm light 2700K.
- Available 110V upon request.
- Dimming function included.



Canopy USA



Min. height: 45 cm

Canopy CE

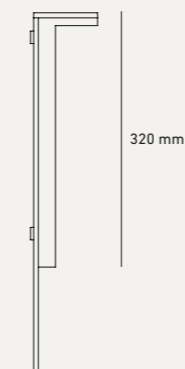

Min. height: 40 cm

Canopy Remote Dimmer

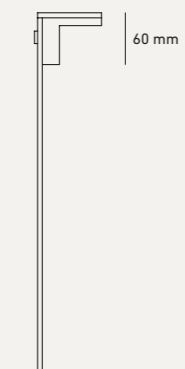

Min. height: 20 cm

**Output of led inside the lamp. Losses due to diffuser and reflectors are not considered. Values are indicative, ambient temperature, height and position of the lamp may vary the values.
 **Emissione del LED all'interno della lampada. Le perdite dovute a diffusore e riflettori non sono considerate. I valori sono indicativi: temperatura ambiente, altezza e posizione della lampada possono influenzare i valori.

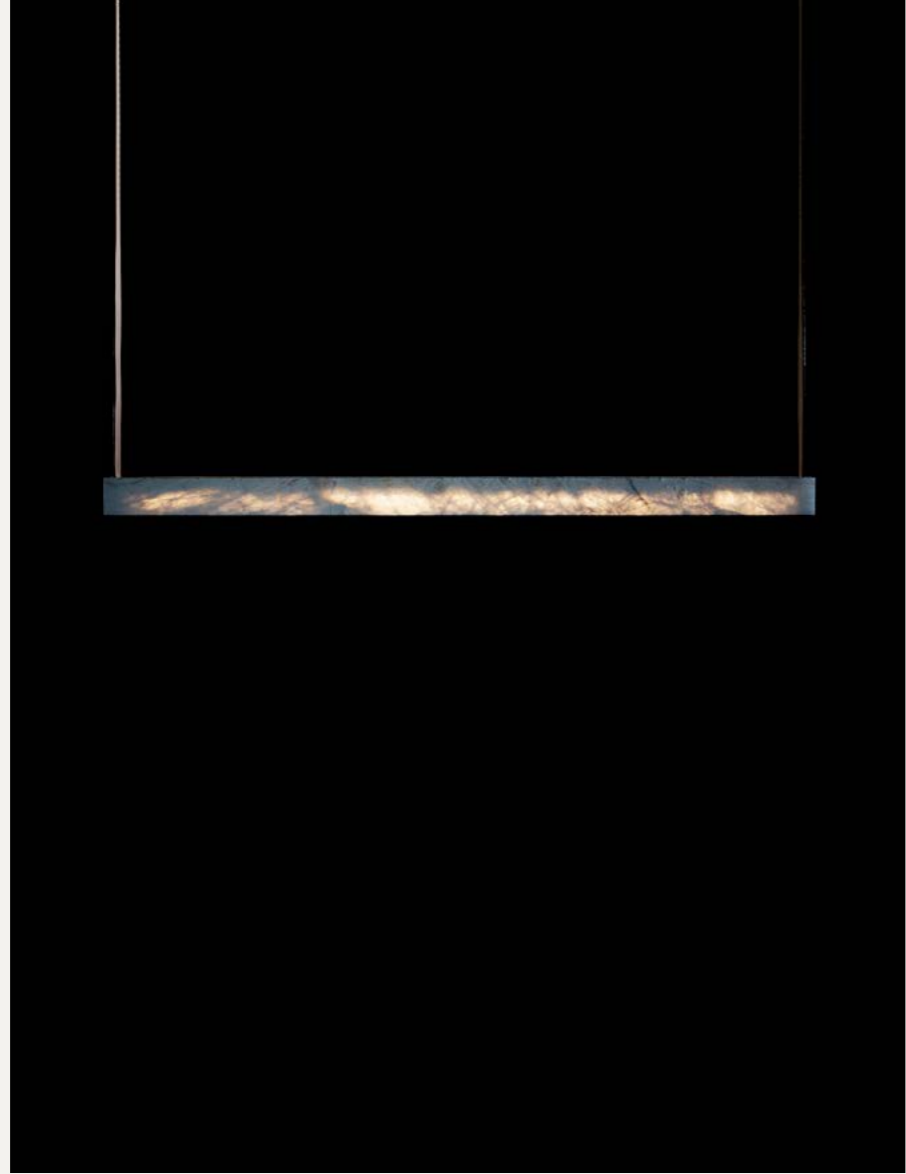

CRYSTAL XL

CHANDELIERS



Long rectangular rods hover lightly in the air, displaying choreographic compositions, synergies between creativity and rigor, spectacularity and control, exhibiting alchemies of light, and translucencies of arabesque textures.

Lunghe aste rettangolari si librano leggere nell'aria, mostrando composizioni coreografiche, sinergie tra creatività e rigore, spettacolarità e controllo, esibendo alchimie di luce, trasparenze di trame arabesche.

DESIGNER
Massimo Castagna

DETAILS

- Central light source made of White Crystal.
- Bi-emission lamp with upward and downward pointing led
- Pendant energy-saving led light (Energy efficiency index A).
- Low voltage power supplied through suspension cable.
- Transformer included in the ceiling rosette.
- Total height cm 180h.
- Upon request available with extra warm light 2700 K (no extra cost).
- Dimmer available upon request.

DETTAGLI

- Sorgente luminosa centrale in Cristallo Bianco.
- Lampada a biemissione verso l'alto e verso il basso led di puntamento
- Lampada a sospensione a led a risparmio energetico (Indice di efficienza energetica A).
- Alimentazione a bassa tensione fornita tramite cavo di sospensione.
- Trasformatore incluso nel rosone a soffitto.
- Altezza totale cm 180h.
- Su richiesta disponibile con luce extra calda 2700 K (senza sovrapprezzo).
- Dimmer disponibile su richiesta.

CONSTRUCTION SPECIFICATION

Weight: 16.5 kg
Material: Metal frame in aluminum and brass, diffuser in stone
Finish: • Burnished Brass (other finishes on demand)
• White Crystal stone

Certified Product
Prodotto certificato

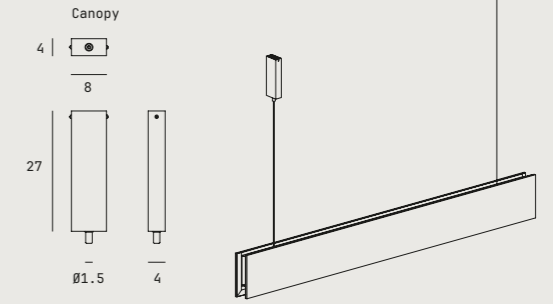

TECHNICAL DATA

Net Weight: 16.5 kg
Light source: strip LED 24 V
Input Voltage [V]: 220-240 V or 110-120 V upon request
Max Power [W]: 35.04 W
Light colour [K]: 3000 K or 2700 K upon request
Flux [lm]: 2700 K - 4531 lm (1500 up/3031 down) / 3000 K - 4801 lm (1602 up/3199 down)
CRI: >90
Dimming: Push / Phase cut / 0-10 V / 1-10 V / DMX / DALI-2 dimmable

Crystal XL
Single Element

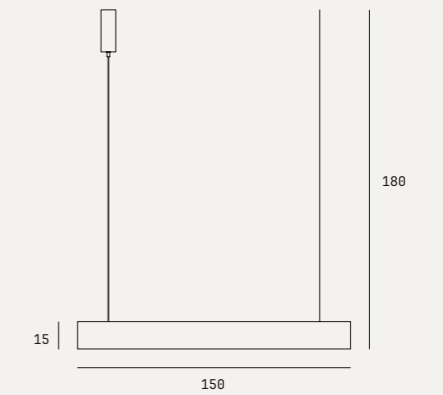

Crystal XL
Central Element

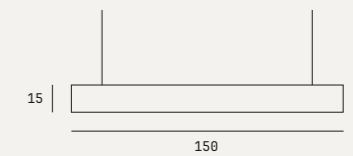

Crystal XL
Terminal Element



**Output of led inside the lamp. Losses due to diffusor and reflectors are not considered. Values are indicative, ambient temperature, height and position of the lamp may vary the values.
**Emissione del LED all'interno della lampada. Le perdite dovute a diffusore e riflettori non sono considerate. I valori sono indicativi: temperatura ambiente, altezza e posizione della lampada possono influenzare i valori.



FLOYD

CHANDELIERS



From the dexterity of the historic Venini's master glassmakers blossoms the exquisite, fumè purity of a sinuous shape replicated in double expansion: a fully-fledged artform that amazes with its endless polyhedric versatility.

Dalla destrezza dei maestri vetrai dello storico Venini scaturisce la squisita purezza fumè di una forma sinuosa replicata in doppia espansione: un vero e proprio oggetto d'arte che stupisce con la sua infinita poliedrica versatilità.

DESIGNER
Ugo Cacciatori

DETAIL

- Murano blown glass
- Grey Glass finish
- Energy-saving LED light (Energy efficiency index A)
- Transformer incorporated in the ceiling rosette
- Alternative mounting system with a remote transformer
- Low voltage power supplied through suspension cables
- Standard total height 180 cm

LIGHT SOURCE

- COB LED 24 V - 3000 K
- Upon request available with extra warm light 2700 K
- Upon request available 110 V
- Dimming function included

DETTAGLI

- Vetro soffiato di Murano
- Finitura vetro grigio
- Luce LED a risparmio energetico (indice di efficienza energetica A)
- Trasformatore incorporato nel rosone a soffitto
- Sistema di montaggio alternativo con trasformatore remoto
- Alimentazione a bassa tensione tramite cavi di sospensione
- Altezza totale standard 180 cm

FONTE LUMINOSA

- LED COB 24 V - 3000 K
- Su richiesta disponibile con luce extra calda 2700 K
- Su richiesta disponibile 110 V
- Dimmerabile

CONSTRUCTION SPECIFICATION

Weight: 10-170 kg
Material: Burnished Titanio with light source in blown glass
Grey Glass finish
Finish: Standard - Different Canopy dimensions
Remote transformer with fixing type A - B - C

Certified Product
Prodotto certificato

CE ENEC IP20

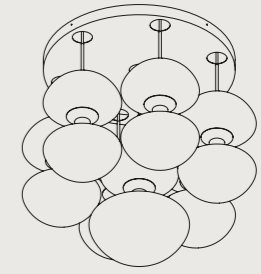

Canopy

Floyd Lamp Ø39/50

Floyd Lamp Ø119

Floyd Lamp Ø150

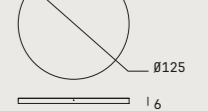
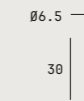

TECHNICAL DATA

Net Weight: 10 kg
Light source: COB LED 24 V
Input Voltage [V]: 220-240 V or 110-120 V upon request
Max Power [W]: 20 W
Light colour [K]: 3000 K or 2700 K upon request
Flux [lm]: 2700 K - 2600 lm / 3000 K - 2960 lm**
CRI: >90
Dimming: Push / Phase cut / 0-10 V / 1-10 V / DMX / DALI-2 dimmable

Floyd Lamp Ø39

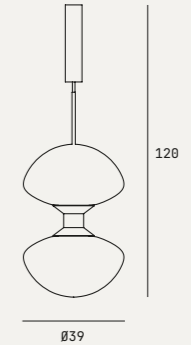

TECHNICAL DATA

Net Weight: 15 kg
Light source: COB LED 24 V
Input Voltage [V]: 220-240 V or 110-120 V upon request
Max Power [W]: 20 W
Light colour [K]: 3000 K or 2700 K upon request
Flux [lm]: 2700 K - 2600 lm / 3000 K - 2960 lm**
CRI: >90
Dimming: Push / Phase cut / 0-10 V / 1-10 V / DMX / DALI-2 dimmable

Floyd Lamp Ø50

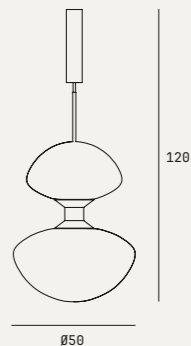

**Output of led inside the lamp. Losses due to diffusor and reflectors are not considered. Values are indicative, ambient temperature, height and position of the lamp may vary the values.
**Emissione del LED all'interno della lampada. Le perdite dovute a diffusore e riflettori non sono considerate. I valori sono indicativi: temperatura ambiente, altezza e posizione della lampada possono influenzare i valori.

TECHNICAL DATA

Net Weight: 105 kg
 Light source: COB LED 24 V
 Input Voltage [V]: 220-240 V or 110-120 V upon request
 Max Power [W]: 145 W
 Light colour [K]: 3000 K or 2700 K upon request
 Flux [lm]: 2700 K - 18200 lm / 3000 K - 20720 lm**
 CRI: >90
 Dimming: Push / Phase cut / 0-10 V / 1-10 V / DMX / DALI-2 dimmable

Floyd
Lamp Ø119

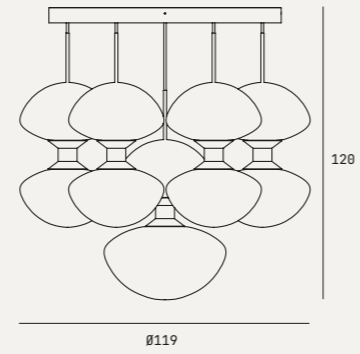

TECHNICAL DATA

Net Weight: 170 kg
 Light source: COB LED 24 V
 Input Voltage [V]: 220-240 V or 110-120 V upon request
 Max Power [W]: 270 W
 Light colour [K]: 3000 K or 2700 K upon request
 Flux [lm]: 2700 K - 33800 lm / 3000 K - 38480 lm**
 CRI: >90
 Dimming: Push / Phase cut / 0-10 V / 1-10 V / DMX / DALI-2 dimmable

Floyd
Lamp Ø150

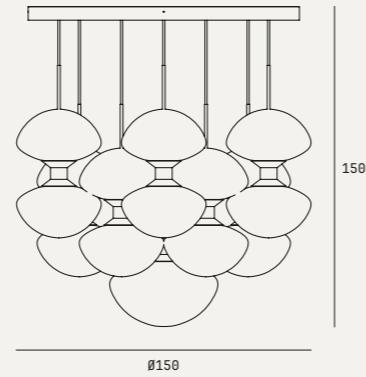



FLOYD SEVEN

LAMPS/CHANDELIERS



A copious, eye-catching fall of generous blown glasses, bearing pure sinuous shapes, grouped at different, well-balanced lengths, creates the tuneful cohesive ensemble of FLOYD SEVEN, an ode to impeccable artistry and to innovative, creative design. Protagonist of the scene, the piece confers identity to the context with its burst of boundless vitality.

Una copiosa, accattivante cascata di generosi vetri soffiati, dalle forme pure e sinuose, sospesi a diverse altezze, ben bilanciate tra loro, crea il melodioso insieme di FLOYD SEVEN, un'ode ad una maestria artigianale d'eccellenza e al design creativo, innovativo. Protagonista della scena, il pezzo conferisce identità al contesto con la sua incontenibile esplosione di vitalità.

DESIGNER
Ugo Cacciatori

DETAILS

- Murano blown glass.
- Grey Glass finish or transparent.
- Ceiling canopy in black burnished steel.
- Joints in Burnished Titanio or Pale Gold Patina
- Dimming function. (DALI, DMX, 1-10V, 0-10 or Phase cut)

LIGHT SOURCE

- COB LED 24V (included), warm white 3000K, CRI > 90.

DETTAGLI

- Vetro soffiato da Murano.
- Finitura vetro Grey o trasparente.
- Rosone a soffitto in Acciaio brunito nero.
- Giunti in Titanio brunito o Pale Gold Patina
- Funzione dimmer. (DALI, DMX, 1-10V, 0-10 o Taglio di fase)

FONTE LUMINOSA

- COB LED 360° 24V (inclusa), luce bianca calda 3000K, CRI > 90.

CONSTRUCTION SPECIFICATION

Weight: 55-85 kg
Material: Burnished Titanio with light source in Murano Blown Glass
Finish: Grey Glass finish or Transparent - Joints in Burnished Titanio or Pale Gold Patina
Fixing type: Standard

Certified Product
Prodotto certificato **CE EAC IP20**

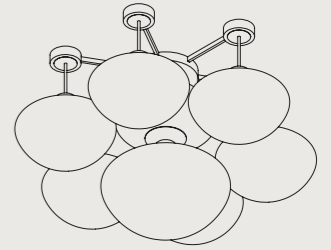

TECHNICAL DATA

Net Weight: 55 kg
Light source: COB LED 24 V
Input Voltage [V]: 220-240 V or 110-120 V upon request
Max Power [W]: 72 W
Light colour [K]: 3000 K or 2700 K upon request
Flux [lm]: 2700 K - 9100 lm / 3000 K - 10360 lm**
CRI: >90
Dimming: Push / Phase cut / 0-10 V / 1-10 V / DMX / DALI-2 dimmable

Floyd Seven
7 lights

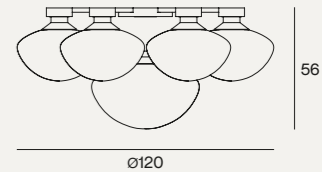

TECHNICAL DATA

Net Weight: 60 kg
Light source: COB LED 24 V
Input Voltage [V]: 220-240 V or 110-120 V upon request
Max Power [W]: 83 W
Light colour [K]: 3000 K or 2700 K upon request
Flux [lm]: 2700 K - 10400 lm / 3000 K - 11840 lm**
CRI: >90
Dimming: Push / Phase cut / 0-10 V / 1-10 V / DMX / DALI-2 dimmable

Floyd Seven
8 lights

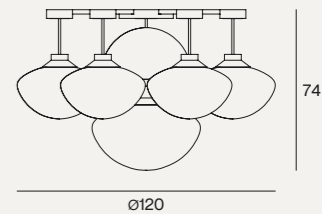

TECHNICAL DATA

Net Weight: 85 kg
Light source: COB LED 24 V
Input Voltage [V]: 220-240 V or 110-120 V upon request
Max Power [W]: 145 W
Light colour [K]: 3000 K or 2700 K upon request
Flux [lm]: 2700 K - 18200 lm / 3000 K - 20720 lm**
CRI: >90
Dimming: Push / Phase cut / 0-10 V / 1-10 V / DMX / DALI DALI-2 dimmable

Floyd Seven
14 lights

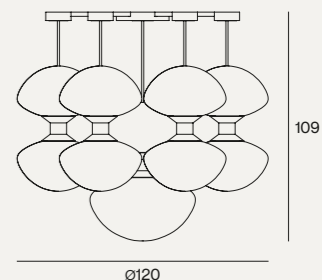

**Output of led inside the lamp. Losses due to diffusor and reflectors are not considered. Values are indicative, ambient temperature, height and position of the lamp may vary the values.
**Emissione del LED all'interno della lampada. Le perdite dovute a diffusore e riflettori non sono considerate. I valori sono indicativi: temperatura ambiente, altezza e posizione della lampada possono influenzare i valori.





GATSBY

CHANDELIERS



A copious, irregular fall of glass cylinders, disposed without hierarchical order around a luminous heart, diffuses a stunning, powerful symphony of intriguing shadows and refractions. The pattern of Gatsby chandelier provokes experiential enchantment, evoking the atmosphere of mythical glamour surrounding the homonymous legendary character.

Una copiosa, irregolare caduta di cilindri di vetro, disposti senza ordine gerarchico attorno a un cuore luminoso, diffonde una stupefacente, potente sinfonia di ombre e rifrazioni intriganti. Il motivo del lampadario Gatsby provoca incanto esperienziale, evocando l'atmosfera di fascino mitico che circonda l'omonimo personaggio leggendario.

DESIGNER
Massimo Castagna

DETAILS

- Cylindrical blown glass.
- Lustrò Grey Glass finish.
- Available in 2 different sizes: standard 37 cylinders, large 61 cylinders.
- Pendant energy-saving LED light (Energy efficiency index A).
- Transformers included in the ceiling rosette.
- Low voltage power supplied through suspension cable.
- Standard total height cm 180h.

LIGHT SOURCE

- 360° Neon strip LED 24V (included), warm white 3000K, CRI > 90.
- Upon request available with extra warm light 2700K.
- Available 110V upon request.
- Dimming function included.

DETTAGLI

- Vetro soffiato cilindrico.
- Finitura vetro Lustrò Grey.
- Disponibile in 2 diverse misure: standard 37 cilindri, large 61 cilindri.
- Sospensione a led a risparmio energetico (Indice di efficienza energetica A).
- Alimentazione a bassa tensione fornita tramite cavo di sospensione.
- Trasformatore incorporato nel rosone a soffitto.
- Altezza totale standard cm 180h.

FONTE LUMINOSA

- Striscia neon LED 360° 24V (inclusa), luce bianca calda 3000K, CRI > 90.
- Su richiesta disponibile con luce extra calda a 2700K.
- Disponibile 110V su richiesta.
- Dimmerabile

CONSTRUCTION SPECIFICATION

Weight: 33.4-54.7 kg
Material: Metal and glass
Finish: • Black Burnished Steel
• Lustrò Grey Glass finish

Certified Product
Prodotto certificato

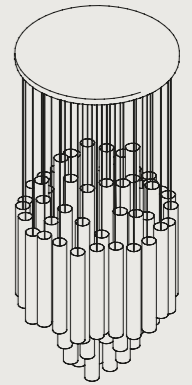
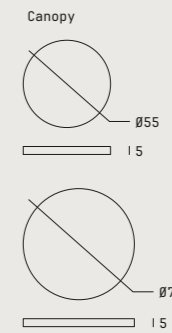

TECHNICAL DATA

Net Weight: 33.4 kg
Light source: 360° Neon strip LED
Input Voltage [V]: 220-240 V or 110-120 V upon request
Max Power [W]: 43 W
Light colour [K]: 3000 K or 2700 K upon request
Flux [lm]: 4105 lm**
CRI: >90
Dimming: Push/Phase cut/0-10 V/1-10 V/DMX / DALI-2 dimmable
Minimum height: Not less than 110cm

Gatsby Ø55

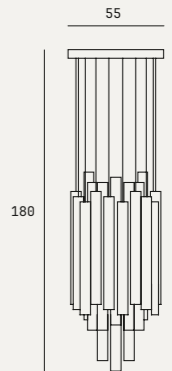

TECHNICAL DATA

Net Weight: 54.7 kg
Light source: 360° Neon strip LED
Input Voltage [V]: 220-240 V or 110-120 V upon request
Max Power [W]: 43 W
Light colour [K]: 3000 K or 2700 K upon request
Flux [lm]: 4105 lm**
CRI: >90
Dimming: Push/Phase cut/0-10 V/1-10 V/DMX / DALI-2 dimmable
Minimum height: Not less than 120cm

Gatsby Ø70

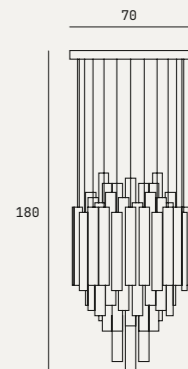

**Output of led inside the lamp. Losses due to diffusor and reflectors are not considered. Values are indicative, ambient temperature, height and position of the lamp may vary the values.
**Emissione del LED all'interno della lampada. Le perdite dovute a diffusore e riflettori non sono considerate. I valori sono indicativi: temperatura ambiente, altezza e posizione della lampada possono influenzare i valori.





GHOST

CHANDELIERS



A central cylindrical body in resin, matched with hand-brushed metals, becomes a vivid and intense note that fascinates with the unexpected possibilities of chromatic transformations provoked by the light. Its totemic presence, on a table or pendant, single or replicated, confers to any interior special accents of identity.

Un corpo cilindrico centrale in resina, abbinato a metalli bruniti a mano, diventa una nota vivida e intensa che affascina per le inaspettate possibilità di trasformazioni cromatiche provocate dalla luce. La sua presenza totemica, su un tavolo o pendente, singolo o replicato, conferisce a qualsiasi interno speciali accenti di identità.

DESIGNER
Massimo Castagna

DETAILS

- Central component made of transparent or grey resin, Ø9 cm.
- The metal lamp shade can be personalized.
- Pendant energy-saving LED light (Energy efficiency index A).
- Standard total height cm 180h.

LIGHT SOURCE

- GU10 10 LED bulb
- Upon request available with extra warm light 2700 K.
- Available 110 V upon request, bulbs not included.
- Phase cut dimmable.

DETTAGLI

- Componente centrale in resina trasparente o grigia, Ø9 cm.
- Il paralume in metallo è personalizzabile.
- Lampada a sospensione a LED a risparmio energetico (Indice di efficienza energetica A).
- Altezza totale standard cm 180h.

FONTE LUMINOSA

- Lampadina GU10 10 LED
- Su richiesta disponibile con luce extra calda 2700 K.
- Disponibile 110 V su richiesta, lampadine non incluse.
- Dimmerabile a taglio di fase.

CONSTRUCTION SPECIFICATION

Weight: 5.5-7.3 kg
 Material: • Light diffuser in metal
 • Central element in resin, in transparent and grey colour
 Finish: Black Burnished Steel, Burnished Platino, Burnished Titanio, Burnished Brass, Black Burnished Brass, H-Silver, H-Silver Black

Certified Product
 Prodotto certificato

CE ENEC IP20

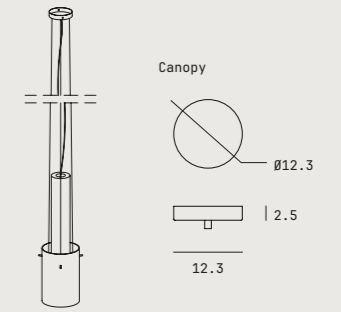

TECHNICAL DATA

Net Weight: 7.2 kg
 Light source: GU10 led bulb
 Input Voltage [V]: 220-240 V or 110-120 V upon request
 Max Power [W]: 6 W
 Light colour [K]: 3000 K or 2700 K upon request
 Flux [lm]: 700 lm**
 CRI: >80
 Dimming: Phase-cut dimmable

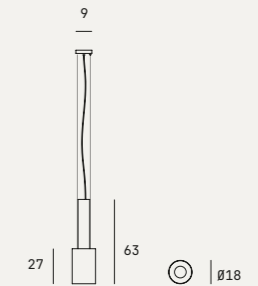

TECHNICAL DATA

Net Weight: 5.5 kg
 Light source: GU10 led bulb
 Input Voltage [V]: 220-240 V or 110-120 V upon request
 Max Power [W]: 6 W
 Light colour [K]: 3000 K or 2700 K upon request
 Flux [lm]: 700 lm**
 CRI: >80
 Dimming: Phase-cut dimmable

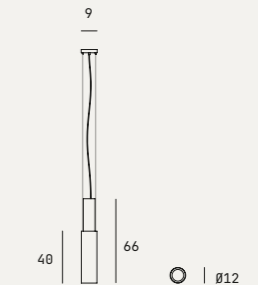

TECHNICAL DATA

Net Weight: 7.3 kg
 Light source: GU10 led bulb
 Input Voltage [V]: 220-240 V or 110-120 V upon request
 Max Power [W]: 6 W
 Light colour [K]: 3000 K or 2700 K upon request
 Flux [lm]: 700 lm**
 CRI: >80
 Dimming: Phase-cut dimmable

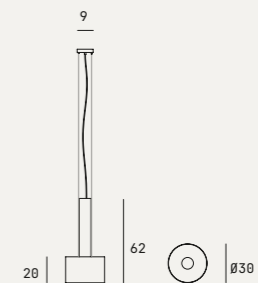

**Output of led inside the lamp. Losses due to diffusor and reflectors are not considered. Values are indicative, ambient temperature, height and position of the lamp may vary the values.
 **Emissione del LED all'interno della lampada. Le perdite dovute a diffusore e riflettori non sono considerate. I valori sono indicativi: temperatura ambiente, altezza e posizione della lampada possono influenzare i valori.





GO GO GO

LAMPS/CHANDELIERS



Disconnected from specific references, Go-go-go explores and reveals the hidden fascination of light. A minimalist, playful sequence-fall of fumé glass 'boxes', artfully held by thin brass joints, lets a beam of light through, projecting on the floor the poetry of the invisible.

Disconnesso da riferimenti specifici, Go-go-go esplora e rivela il fascino nascosto della luce. Una minimalista, giocosa sequenza-caduta di 'scatole' in vetro fumé, sostenute ad arte da sottili giunti in ottone, lascia passare un fascio di luce, proiettando sul pavimento la poesia dell'invisibile.

DESIGNER
Johanna Grawunder

DETAILS

- Murano float glass 10 mm thick.
- Finished with an elegant Fumè or Bronze color.
- Rosette made of Black Burnished Steel.
- Support rods made of Brass Patina.
- Available in 2 different configurations.
- Total height 216 cm or 132 cm.

LIGHT SOURCE

- Energy-saving with warm COB LED light (energy efficiency index A).
- Dimming function. (DALI, DMX, 1-10V, 0-10 or Pase cut). Available upon request.
- Optional led bulb 2700 K.
- Available upon request 110V.

DETTAGLI

- Cilindri in Ottone Brunito, Platino Brunito o Titanio.
- Sospensione a led a risparmio energetico (Indice di efficienza energetica A).
- Alimentazione a bassa tensione fornita tramite il tubo di sospensione.
- Altezza totale standard 250 cm.

FONTE LUMINOSA

- Lampadine LED GU10 3000K.
- Su richiesta disponibile con luce extra calda a 2700K.
- Disponibile 110V su richiesta, lampadine non incluse.
- Dimmerabile taglio di fase.

CONSTRUCTION SPECIFICATION

Weight: 25-40 kg
Material: Metal, Glass
Finish: Fumè or Bronze Glass

Certified Product
Prodotto certificato **CE EAC** IP20

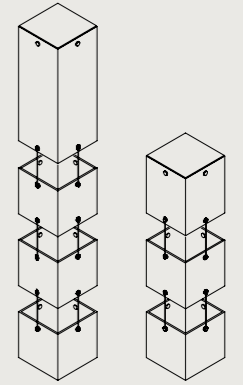

TECHNICAL DATA

Net Weight: 25 kg
Light source: Strip LED 24 V
Input Voltage [V]: 220-240 V or 110-120 V upon request
Max Power [W]: 19 W
Light colour [K]: 3000 K or 2700 K upon request
Flux [lm]: 2700 K - 2490 lm / 3000 K - 2645 lm**
CRI: >90
Dimming: Push / Phase cut / 0-10 V / 1-10 V
DMX / DALI-2 dimmable

Go Go Go
132h

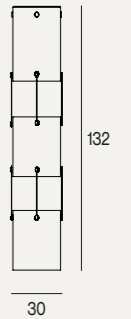

TECHNICAL DATA

Net Weight: 40 kg
Light source: Strip LED 24 V
Input Voltage [V]: 220-240 V or 110-120 V upon request
Max Power [W]: 19 W
Light colour [K]: 3000 K or 2700 K upon request
Flux [lm]: 2700 K - 2490 lm / 3000 K - 2645 lm**
CRI: >90
Dimming: Push / Phase cut / 0-10 V / 1-10 V
DMX / DALI-2 dimmable

Go Go Go
216h

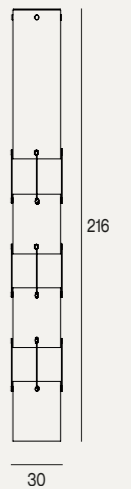

**Output of led inside the lamp. Losses due to diffusor and reflectors are not considered. Values are indicative, ambient temperature, height and position of the lamp may vary the values.
**Emissione del LED all'interno della lampada. Le perdite dovute a diffusore e riflettori non sono considerate. I valori sono indicativi: temperatura ambiente, altezza e posizione della lampada possono influenzare i valori.



HELIX

LAMPS/CHANDELIERS



The austere alphabet of taut, segmented angular lines expresses the radical approach of HELIX, a paradigm of minimalist contemporary sculptural beauty, exalted by a rigorous, elegant black dress code.

Un austero alfabeto di linee tese e segmentate esprime l'approccio radicale di HELIX, un paradigma di bellezza scultorea minimalista contemporanea, enfatizzato dal rigoroso ed elegante dress code nero.

DESIGNER
Massimo Castagna

DETAILS

- Each element is made of cylinders Ø 5,8, 7, 8,5 joint by a metal bar.
- Tube holder made of Sand Cast Peltro
- Options available in Burnished Brass, Burnished Platino, or Titanio.
- Warm led light GU10 with energy efficiency index A.
- Dimming function included (phase cut).
- Standard total height 130 cm.
- Upon request available with extra warm light 2700K.
- Upon request available 110V, bulbs not included.

DETTAGLI

- Ogni elemento è composto da cilindri Ø 5,8, 7 e 8,5 uniti da un tubo in metallo.
- Raccordo reggitubo in fusione Peltro
- Opzioni disponibili in ottone brunito, platino brunito o titanio.
- Luce led calda GU10 con indice di efficienza energetica A.
- Funzione dimmer inclusa (taglio di fase).
- Altezza totale standard 130 cm.
- A richiesta disponibile con luce extra calda 2700K.
- Su richiesta disponibile 110V, luci non incluse.



CONSTRUCTION SPECIFICATION

Weight: 55-85 kg
Material: Burnished Titanio with light source in Murano Blown Glass
Finish: Grey Glass finish or Transparent - Joints in Burnished Titanio or Pale Gold Patina
Fixing type: Standard

Certified Product
Prodotto certificato **CE ENEC** IP20

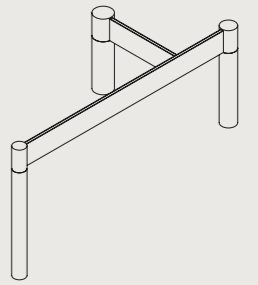

TECHNICAL DATA

Net Weight: 7.6 kg
Light source: GU 10
Input Voltage [V]: 220-240 V or 110-120 V upon request
Max Power [W]: 9 W
Light colour [K]: 3000 K or 2700 K upon request
Flux [lm]: 2700 K - 700 lm / 3000 K - 700 lm**
CRI: >90
Dimming: Push / Phase cut / 0-10 V / 1-10 V / DMX / DALI-2 dimmable

Helix
2 Spots

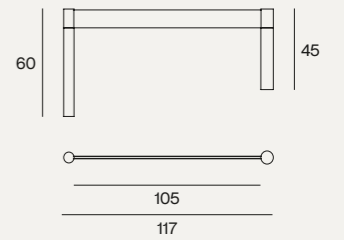

TECHNICAL DATA

Net Weight: 12.1 kg
Light source: GU 10
Input Voltage [V]: 220-240 V or 110-120 V upon request
Max Power [W]: 13.5 W
Light colour [K]: 3000 K or 2700 K upon request
Flux [lm]: 2700 K - 1050 lm / 3000 K - 1050 lm**
CRI: >90
Dimming: Push / Phase cut / 0-10 V / 1-10 V / DMX / DALI-2 dimmable

Helix
3 Spots A

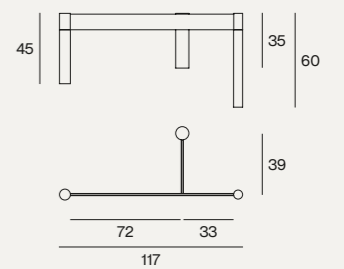

TECHNICAL DATA

Net Weight: 12.1 kg
Light source: GU 10
Input Voltage [V]: 220-240 V or 110-120 V upon request
Max Power [W]: 13.5 W
Light colour [K]: 3000 K or 2700 K upon request
Flux [lm]: 2700 K - 1050 lm / 3000 K - 1050 lm**
CRI: >90
Dimming: Push / Phase cut / 0-10 V / 1-10 V / DMX / DALI-2 dimmable

Helix
3 Spots B

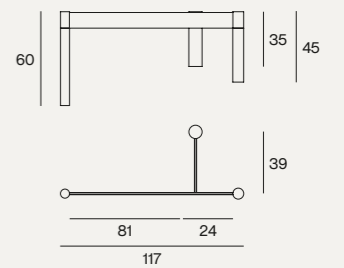

TECHNICAL DATA

Net Weight: 12.1 kg
Light source: GU 10
Input Voltage [V]: 220-240 V or 110-120 V upon request
Max Power [W]: 13.5 W
Light colour [K]: 3000 K or 2700 K upon request
Flux [lm]: 2700 K - 1050 lm / 3000 K - 1050 lm**
CRI: >90
Dimming: Push / Phase cut / 0-10 V / 1-10 V / DMX / DALI-2 dimmable

Helix
3 Spots C

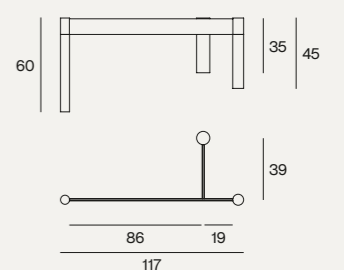

**Output of led inside the lamp. Losses due to diffusor and reflectors are not considered. Values are indicative, ambient temperature, height and position of the lamp may vary the values.
**Emissione del LED all'interno della lampada. Le perdite dovute a diffusore e riflettori non sono considerate. I valori sono indicativi: temperatura ambiente, altezza e posizione della lampada possono influenzare i valori.



LIGHT RING

CHANDELIERS



Concentric rings, in sequence or overlapping, wall-mounted or suspended, develop archetypal visual codes inspired by the beauty and purity that the circle synthesizes in its perfect symbolic form. An idea realized with important hand-crafted materials that diffuse a warm and intriguing light.

Anelli concentrici, in sequenza o sovrapposti, a parete o sospesi, sviluppano codici visivi archetipici ispirati alla bellezza e alla purezza che il cerchio sintetizza nella sua perfetta forma simbolica. Un'idea realizzata con importanti materiali lavorati a mano che diffondono una luce calda e intrigante.

DESIGNER
Massimo Castagna

DETAILS

- Metal pendant lights with rings of different sizes.
- Light source downward or inward facing.
- Pendant energy-saving LED light (Energy efficiency index A).
- Low voltage power supplied through suspension cable.
- Transformer integrated into the ceiling rosette.

LIGHT SOURCE

- LED 24V 3000K.
- Upon request available with extra warm light 2700K or 4000K.
- Available 110V upon request.
- Dimming function included.

DETTAGLI

- Lampade a sospensione in metallo con anelli di dimensioni diverse.
- Sorgente luminosa rivolta verso il basso o verso l'interno.
- Sospensione a led a risparmio energetico (Indice di efficienza energetica A).
- Alimentazione a bassa tensione fornita tramite cavo di sospensione.
- Trasformatore incorporato nel rosone a soffitto.

FONTE LUMINOSA

- LED 24V 3000K.
- Su richiesta disponibile con luce extra calda a 2700K o 4000K.
- Disponibile 110V su richiesta.
- Dimmerabile.

CONSTRUCTION SPECIFICATION

Weight: 10 kg-58 kg
Material: Brass or steel profile with mehakrylate diffuser
Finish: Black Burnished Steel, Burnished Titano, Burnished Platino, Burnished Brass, Black Burnished Brass, H-Silver, H-Silver Black

Certified Product
 Prodotto certificato

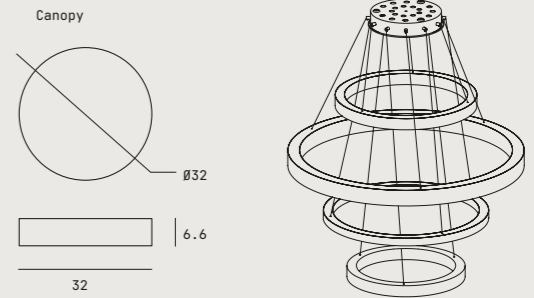

TECHNICAL DATA

Net Weight: 10 kg
Light source: strip LED 24 V
Input Voltage [V]: 220-240 V or 110-120 V upon request
Max Power [W]: 50,88 W
 79 W for upgraded version
Light colour [K]: 3000 K or 2700 K upon request
Flux [lm]: 2700 K - 6625 lm / 3000 K - 7076 lm**
 10600 lm for upgraded version
CRI: >90
Dimming: Push / Phase cut / 0-10 V / 1-10 V / DMX / DALI-2 dimmable

3 Rings
 Composition

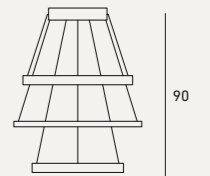

TECHNICAL DATA

Net Weight: 18 kg
Light source: strip LED 24 V
Input Voltage [V]: 220-240 V or 110-120 V upon request
Max Power [W]: 50.88 W
 79 W for upgraded version
Light colour [K]: 3000 K or 2700 K upon request
Flux [lm]: 2700 K - 6625 lm / 3000 K - 7076 lm**
 10600 lm for upgraded version
CRI: >90
Dimming: Push / Phase cut / 0-10 V / 1-10 V / DMX / DALI-2 dimmable

4 Rings
 Composition

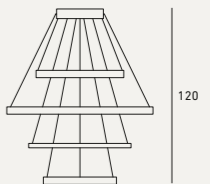

Ring Ø100 without LED

TECHNICAL DATA

Net Weight: 18 kg
Light source: strip LED 24 V
Input Voltage [V]: 220-240 V or 110-120 V upon request
Max Power [W]: 77.90 W
 121 W for upgraded version
Light colour [K]: 3000 K or 2700 K upon request
Flux [lm]: 2700 K - 10250 lm / 3000 K - 10947 lm**
 16200 lm for upgraded version
CRI: >90
Dimming: Push / Phase cut / 0-10 V / 1-10 V / DMX / DALI-2 dimmable

4 Rings
 Composition

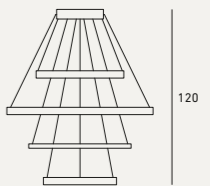

Ring Ø100 with LED



TECHNICAL DATA

Net Weight: 35 kg
 Light source: strip LED 24 V
 Input Voltage [V]: 220-240 V or 110-120 V upon request
 Max Power [W]: 104.64 W
 144 W for upgraded version
 Light colour [K]: 3000 K or 2700 K upon request
 Flux [lm]: 2700 K - 13625 lm / 3000 K - 14552 lm**
 18050 lm for upgraded version
 CRI: >90
 Dimming: Push / Phase cut / 0-10 V / 1-10 V / DMX / DALI-2 dimmable

8 Rings
 Composition

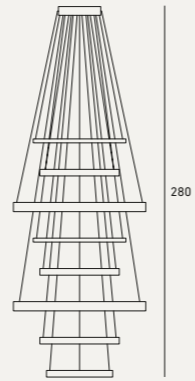

Rings Ø100 without LED

TECHNICAL DATA

Net Weight: 25 kg
 Light source: strip LED 24 V
 Input Voltage [V]: 220-240 V or 110-120 V upon request
 Max Power [W]: 112.32 W
 175 W for upgraded version
 Light colour [K]: 3000 K or 2700 K upon request
 Flux [lm]: 2700 K - 14625 lm / 3000 K - 15620 lm**
 23400 lm for upgraded version
 CRI: >90
 Dimming: Push / Phase cut / 0-10 V / 1-10 V / DMX / DALI-2 dimmable

7 Rings
 Composition

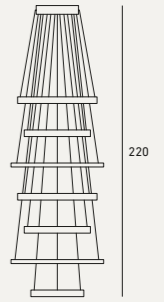

TECHNICAL DATA

Net Weight: 35 kg
 Light source: strip LED 24 V
 Input Voltage [V]: 220-240 V or 110-120 V upon request
 Max Power [W]: 160.32 W
 247 W for upgraded version
 Light colour [K]: 3000 K or 2700 K upon request
 Flux [lm]: 2700 K - 20875 lm / 3000 K - 22295 lm**
 33000 lm for upgraded version
 CRI: >90
 Dimming: Push / Phase cut / 0-10 V / 1-10 V / DMX / DALI-2 dimmable

8 Rings
 Composition

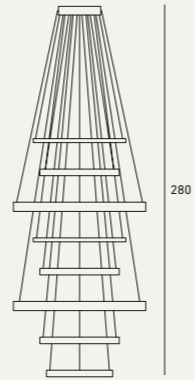

Rings Ø100 with LED

TECHNICAL DATA

Net Weight: 58 kg
 Light source: strip LED 24 V
 Input Voltage [V]: 220-240 V or 110-120 V upon request
 Max Power [W]: 246.72 W
 381 W for upgraded version
 Light colour [K]: 3000 K or 2700 K upon request
 Flux [lm]: 2700 K - 32125 lm / 3000 K - 34310 lm**
 50800 lm for upgraded version
 CRI: >90
 Dimming: Push / Phase cut / 0-10 V / 1-10 V / DMX / DALI-2 dimmable

12 Rings
 Composition

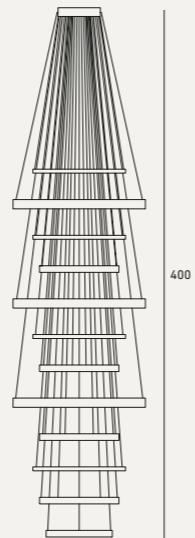

**Output of led inside the lamp. Losses due to diffusor and reflectors are not considered. Values are indicative, ambient temperature, height and position of the lamp may vary the values.
 **Emissione del LED all'interno della lampada. Le perdite dovute a diffusore e riflettori non sono considerate. I valori sono indicativi: temperatura ambiente, altezza e posizione della lampada possono influenzare i valori.

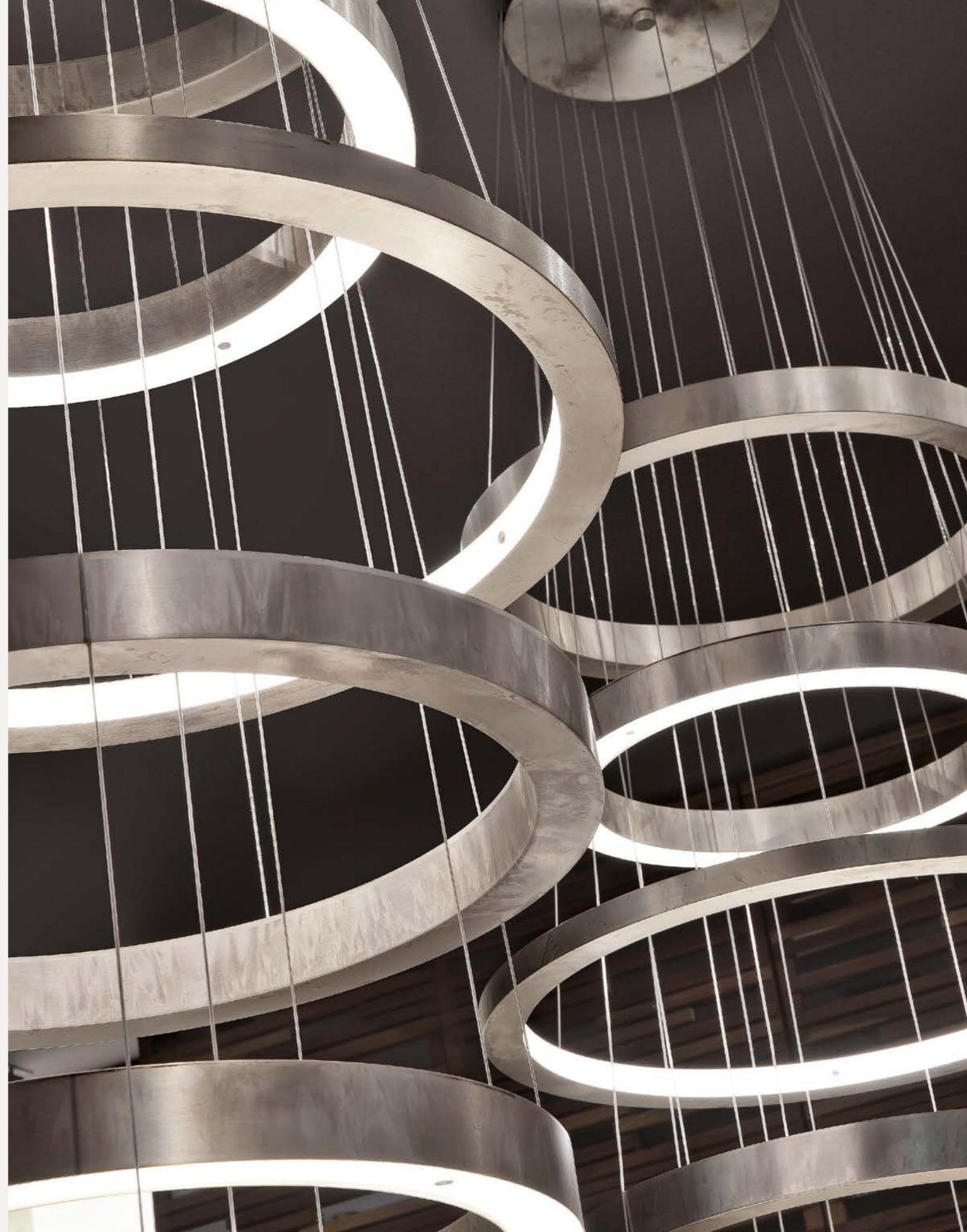

LIGHT RING HORIZONTAL

CHANDELIERS



Concentric rings, in sequence or overlapping, wall-mounted or suspended, develop archetypal visual codes inspired by the beauty and purity that the circle synthesizes in its perfect symbolic form. An idea realized with important hand-crafted materials that diffuse a warm and intriguing light.

Anelli concentrici, in sequenza o sovrapposti, a parete o sospesi, sviluppano codici visivi archetipici ispirati alla bellezza e alla purezza che il cerchio sintetizza nella sua perfetta forma simbolica. Un'idea realizzata con importanti materiali lavorati a mano che diffondono una luce calda e intrigante.

DESIGNER
Massimo Castagna

DETAILS

- Metal pendant lights with rings of different sizes.
- Light source downward or inward facing.
- Energy-saving LED light (energy efficiency index A).
- Transformer integrated into the ceiling rosette.
- Alternative mounting system with a remote transformer.
- Low voltage power supplied through suspension cables.
- Standard total height 180 cm.

LIGHT SOURCE

- LED 24V 3000K.
- Upon request available with extra warm light 2700K or 4000K.
- Available 110V upon request.
- Dimming function included.

DETTAGLI

- Lampade a sospensione in metallo con anelli di dimensioni diverse.
- Sorgente luminosa rivolta verso il basso o verso l'interno.
- Sospensione a led a risparmio energetico (Indice di efficienza energetica A).
- Trasformatore integrato nel rosone a soffitto.
- Sistema di montaggio alternativo con trasformatore remoto.
- Alimentazione a bassa tensione fornita tramite cavi di sospensione.
- Altezza totale standard 180 cm.

FONTE LUMINOSA

- LED 24V 3000K.
- Su richiesta disponibile con luce extra calda a 2700K o 4000K.
- Disponibile 110V su richiesta.
- Dimmerabile.

CONSTRUCTION SPECIFICATION

Weight: 5 kg-22 kg
Material: Brass or steel profile with mehakrylate diffuser
Overall height: 180 cm adjustable
Finish: Burnished Steel, Burnished Titanio, Burnished Platino, Burnished Brass, Black Burnished Brass, H-Silver, H-Silver Black

Certified Product
Prodotto certificato

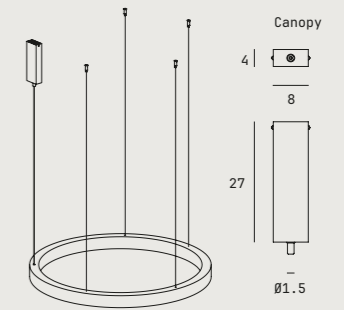

TECHNICAL DATA

Net Weight: 5 kg
Light source: strip LED 24 V
Input Voltage [V]: 220-240 V or 110-120 V upon request
Max Power [W]: 12.48 W
 19 W for upgraded version
Light colour [K]: 3000 K or 2700 K upon request
Flux [lm]: 2700 K - 1625 lm / 3000 K - 1736 lm**
 2600 lm for upgraded version
CRI: >90
Dimming: Push / Phase cut / 0-10 V / 1-10 V / DMX / DALI-2 dimmable

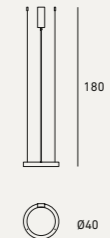

TECHNICAL DATA

Net Weight: 6 kg
Light source: strip LED 24 V
Input Voltage [V]: 220-240 V or 110-120 V upon request
Max Power [W]: 15.36 W
 24 W for upgraded version
Light colour [K]: 3000 K or 2700 K upon request
Flux [lm]: 2700 K - 2000 lm / 3000 K - 2136 lm**
 3200 lm for upgraded version
CRI: >90
Dimming: Push / Phase cut / 0-10 V / 1-10 V / DMX / DALI-2 dimmable

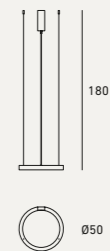

TECHNICAL DATA

Net Weight: 7 kg
Light source: strip LED 24 V
Input Voltage [V]: 220-240 V or 110-120 V upon request
Max Power [W]: 18.24 W
 28 W for upgraded version
Light colour [K]: 3000 K or 2700 K upon request
Flux [lm]: 2700 K - 2375 lm / 3000 K - 2537 lm**
 3800 lm for upgraded version
CRI: >90
Dimming: Push / Phase cut / 0-10 V / 1-10 V / DMX / DALI-2 dimmable

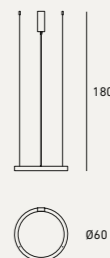

TECHNICAL DATA

Net Weight: 8 kg
 Light source: strip LED 24 V
 Input Voltage [V]: 220-240 V or 110-120 V upon request
 Max Power [W]: 21.12 W
 33 W for upgraded version
 Light colour [K]: 3000 K or 2700 K upon request
 Flux [lm]: 2700 K - 2750 lm / 3000 K - 2937 lm**
 4400 lm for upgraded version
 CRI: >90
 Dimming: Push / Phase cut / 0-10 V / 1-10 V / DMX / DALI-2 dimmable

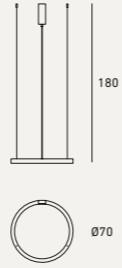

TECHNICAL DATA

Net Weight: 10 kg
 Light source: strip LED 24 V
 Input Voltage [V]: 220-240 V or 110-120 V upon request
 Max Power [W]: 29.76 W
 46 W for upgraded version
 Light colour [K]: 3000 K or 2700 K upon request
 Flux [lm]: 2700 K - 3875 lm / 3000 K - 4139 lm**
 6200 lm for upgraded version
 CRI: >90
 Dimming: Push / Phase cut / 0-10 V / 1-10 V / DMX / DALI-2 dimmable

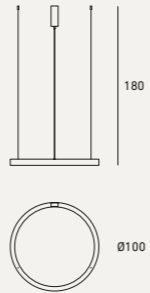

TECHNICAL DATA

Net Weight: 12 kg
 Light source: strip LED 24 V
 Input Voltage [V]: 220-240 V or 110-120 V upon request
 Max Power [W]: 36.48 W
 55 W for upgraded version
 Light colour [K]: 3000 K or 2700 K upon request
 Flux [lm]: 2700 K - 4750 lm / 3000 K - 5073 lm**
 7400 lm for upgraded version
 CRI: >90
 Dimming: Push / Phase cut / 0-10 V / 1-10 V / DMX / DALI-2 dimmable

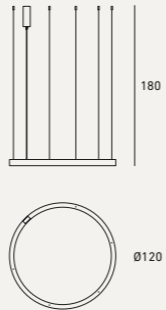

TECHNICAL DATA

Net Weight: 16 kg
 Light source: strip LED 24 V
 Input Voltage [V]: 220-240 V or 110-120 V upon request
 Max Power [W]: 43.20 W
 67 W for upgraded version
 Light colour [K]: 3000 K or 2700 K upon request
 Flux [lm]: 2700 K - 5625 lm / 3000 K - 6008 lm**
 9000 lm for upgraded version
 CRI: >90
 Dimming: Push / Phase cut / 0-10 V / 1-10 V / DMX / DALI-2 dimmable

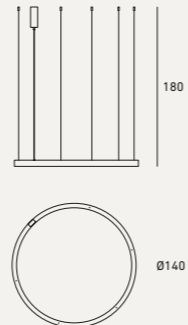

TECHNICAL DATA

Net Weight: 19 kg
 Light source: strip LED 24 V
 Input Voltage [V]: 220-240 V or 110-120 V upon request
 Max Power [W]: 48.96 W
 76 W for upgraded version
 Light colour [K]: 3000 K or 2700 K upon request
 Flux [lm]: 2700 K - 6375 lm / 3000 K - 6809 lm**
 10200 lm for upgraded version
 CRI: >90
 Dimming: Push / Phase cut / 0-10 V / 1-10 V / DMX / DALI-2 dimmable

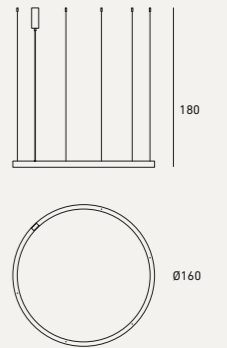

TECHNICAL DATA

Net Weight: 22 kg
 Light source: strip LED 24 V
 Input Voltage [V]: 220-240 V or 110-120 V upon request
 Max Power [W]: 54.72 W
 85 W for upgraded version
 Light colour [K]: 3000 K or 2700 K upon request
 Flux [lm]: 2700 K - 7125 lm / 3000 K - 7610 lm**
 11400 lm for upgraded version
 CRI: >90
 Dimming: Push / Phase cut / 0-10 V / 1-10 V / DMX / DALI-2 dimmable

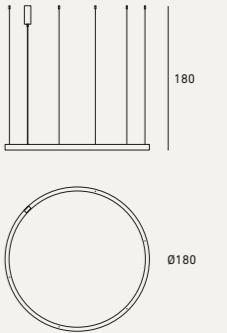





LIGHT RING HORIZONTAL XS

CHANDELIERS



Metal cylinders in different finishes and sizes, supported by metal cables, combined and concerted with total creative freedom, draw dynamic and vibrant luminous graphisms.

Cilindri metallici in diverse finiture e dimensioni, sorretti da cavi metallici, accostati e concertati in totale libertà creativa, disegnano grafismi luminosi dinamici e vibranti.

DESIGNER
Massimo Castagna

DETAILS

- Metal pendant lights with rings of different sizes.
- Energy-saving LED light (energy efficiency index A).
- Transformer integrated into the ceiling rosette.
- Alternative mounting system with a remote transformer.
- Low voltage power supplied through suspension cables.
- Standard total height 180 cm.

LIGHT SOURCE

- COB LED 24V 3000K.
- Upon request available with extra warm light 2700K.
- Available 110V upon request.
- Dimming function included.

DETTAGLI

- Lampade a sospensione in metallo con anelli di dimensioni diverse.
- Sospensione a led a risparmio energetico (Indice di efficienza energetica A).
- Trasformatore integrato nel rosone a soffitto.
- Sistema di montaggio alternativo con trasformatore remoto.
- Alimentazione a bassa tensione fornita tramite cavi di sospensione.
- Altezza totale standard 180 cm.

FONTE LUMINOSA

- COB LED 24V 3000K.
- Su richiesta disponibile con luce extra calda a 2700K.
- Disponibile 110V su richiesta.
- Dimmerabile.

CONSTRUCTION SPECIFICATION

Weight: 2,70 kg-5,40 kg
Material: Brass or steel profile with mehakrylate diffuser
Overall height: 180 cm adjustable
Finish: Black Burnished Steel, Burnished Titano, Burnished Platino, Burnished Brass, Black Burnished Brass, H-Silver, H-Silver Black

Certified Product
Prodotto certificato

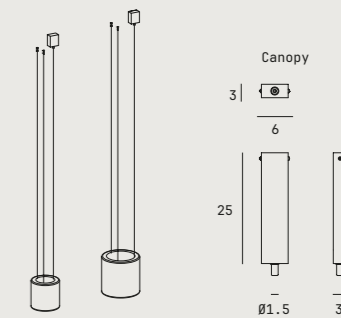

TECHNICAL DATA

Net Weight: 2,70 kg
Light source: strip LED 24V
Input Voltage [V]: 220-240 V or 110-120 V upon request
Max Power [W]: 15 W
Light colour [K]: 3000K or 2700 K upon request
Flux [lm]: 2250 lm**
CRI: >80
Dimming: Push/Phase cut/0-10 V/1-10 V/DMX/DALI-2 dimmable

3 Rings Composition

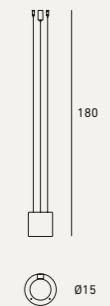

TECHNICAL DATA

Net Weight: 5,40 kg
Light source: strip LED 24V
Input Voltage [V]: 220-240 V or 110-120 V upon request
Max Power [W]: 22,5 W
Light colour [K]: 3000K or 2700 K upon request
Flux [lm]: 3375 lm**
CRI: >80
Dimming: Push/Phase cut/0-10 V/1-10 V/DMX/DALI-2 dimmable

4 Rings Composition

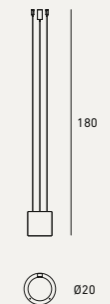

**Output of led inside the lamp. Losses due to diffusor and reflectors are not considered. Values are indicative, ambient temperature, height and position of the lamp may vary the values.
**Emissione del LED all'interno della lampada. Le perdite dovute a diffusore e riflettori non sono considerate. I valori sono indicativi: temperatura ambiente, altezza e posizione della lampada possono influenzare i valori.







LIGHT RING HORIZONTAL POLYGONAL

CHANDELIERS

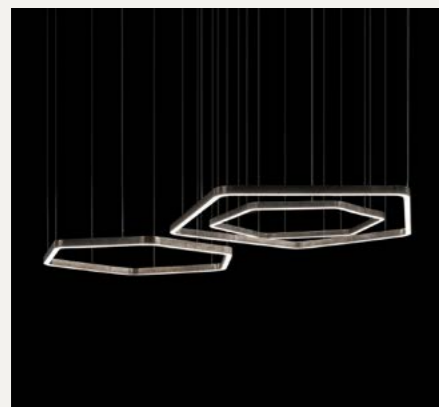

Oversized polygonal silhouettes, reiterate a vocabulary of symmetries and assonances, elaborating an unedited, pure, and complex luminous language of powerful expressive eloquence.

Sagome poligonali sovradimensionate, ribadiscono un vocabolario di simmetrie e assonanze, elaborando un inedito, puro e complesso linguaggio luminoso di potente eloquenza espressiva.

DESIGNER
Massimo Castagna

DETAILS

- Metal pendant lights with rings of different sizes.
- Light source downward.
- Energy-saving LED light (energy efficiency index A).
- Transformer integrated into the ceiling rosette.
- Alternative mounting system with a remote transformer.
- Low voltage power supplied through suspension cables.
- Standard total height 180 cm.

LIGHT SOURCE

- LED 24V 3000K.
- Upon request available with extra warm light 2700K or 4000K.
- Available 110V upon request.
- Dimming function included.

DETTAGLI

- Lampade a sospensione in metallo con anelli di dimensioni diverse.
- Sorgente luminosa rivolta verso il basso.
- Sospensione a led a risparmio energetico (Indice di efficienza energetica A).
- Trasformatore integrato nel rosone a soffitto.
- Sistema di montaggio alternativo con trasformatore remoto.
- Alimentazione a bassa tensione fornita tramite cavi di sospensione.
- Altezza totale standard 180 cm.

FONTE LUMINOSA

- LED 24V 3000K.
- Su richiesta disponibile con luce extra calda a 2700K o 4000K.
- Disponibile 110V su richiesta.
- Dimmerabile.

CONSTRUCTION SPECIFICATION

Weight: 3,30 kg-35 kg
Material: Brass or steel profile with mehcrylate diffuser
Overall height: 180 cm adjustable
Finish: Black Burnished Steel, Burnished Titanio, Burnished Platino, Burnished Brass, Black Burnished Brass, H-Silver, H-Silver Black

Certified Product
Prodotto certificato

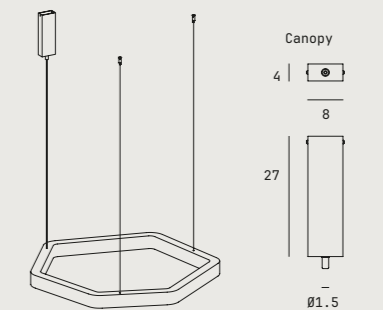

TECHNICAL DATA

Net Weight: 3.3 kg
Light source: strip LED 24 V
Input Voltage [V]: 220-240 V or 110-120 V upon request
Max Power [W]: 12.48 W
Light colour [K]: 3000 K or 2700 K upon request
Flux [lm]: 2700 K - 1625 lm / 3000 K - 1736 lm**
CRI: >90
Dimming: Push / Phase cut / 0-10 V / 1-10 V / DMX / DALI-2 dimmable



TECHNICAL DATA

Net Weight: 4.1 kg
Light source: strip LED 24 V
Input Voltage [V]: 220-240 V or 110-120 V upon request
Max Power [W]: 16.32 W
Light colour [K]: 3000 K or 2700 K upon request
Flux [lm]: 2700 K - 2125 lm / 3000 K - 2270 lm**
CRI: >90
Dimming: Push / Phase cut / 0-10 V / 1-10 V / DMX / DALI-2 dimmable



TECHNICAL DATA

Net Weight: 4.8 kg
Light source: strip LED 24 V
Input Voltage [V]: 220-240 V or 110-120 V upon request
Max Power [W]: 20.16 W
Light colour [K]: 3000K or 2700K upon request
Flux [lm]: 2700 K - 2625 lm / 3000 K - 2804 lm**
CRI: >90
Dimming: Push / Phase cut / 0-10 V / 1-10 V / DMX / DALI-2 dimmable



TECHNICAL DATA

Net Weight: 8 kg
Light source: strip LED 24 V
Input Voltage [V]: 220-240 V or 110-120 V upon request
Max Power [W]: 27.84 W
Light colour [K]: 3000 K or 2700 K upon request
Flux [lm]: 2700 K - 3625 lm / 3000 K - 3872 lm**
CRI: >90
Dimming: Push / Phase cut / 0-10 V / 1-10 V / DMX / DALI-2 dimmable

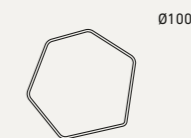

TECHNICAL DATA

Net Weight: 10 kg
 Light source: strip LED 24 V
 Input Voltage [V]: 220-240 V or 110-120 V upon request
 Max Power [W]: 32.64 W
 Light colour [K]: 3000 K or 2700 K upon request
 Flux [lm]: 2700 K - 4250 lm / 3000 K - 4539 lm**
 CRI: >90
 Dimming: Push / Phase cut / 0-10 V / 1-10 V / DMX / DALI-2 dimmable

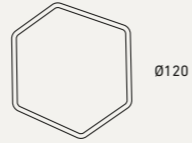

Ø120

TECHNICAL DATA

Net Weight: 12 kg
 Light source: strip LED 24V
 Input Voltage [V]: 220-240 V or 110-120 V upon request
 Max Power [W]: 37 W
 Light colour [K]: 3000K or 2700 K upon request
 Flux [lm]: 2700-3774 lm; 3000 K-4080 lm**
 CRI: >80; >90 upon request
 Dimming: Push/Phase cut/0-10 V/1-10 V/DMX / DALI-2 dimmable



Ø140

TECHNICAL DATA

Net Weight: 19 kg
 Light source: strip LED 24 V
 Input Voltage [V]: 220-240 V or 110-120 V upon request
 Max Power [W]: 44.16 W
 Light colour [K]: 3000 K or 2700 K upon request
 Flux [lm]: 2700 K - 5750 lm / 3000 K - 6141 lm**
 CRI: >90
 Dimming: Push / Phase cut / 0-10 V / 1-10 V / DMX / DALI-2 dimmable



Ø160

TECHNICAL DATA

Net Weight: 22 kg
 Light source: strip LED 24 V
 Input Voltage [V]: 220-240 V or 110-120 V upon request
 Max Power [W]: 48.96 W
 Light colour [K]: 3000 K or 2700 K upon request
 Flux [lm]: 2700 K - 6375 lm / 3000 K - 6809 lm**
 CRI: >90
 Dimming: Push / Phase cut / 0-10 V / 1-10 V / DMX / DALI-2 dimmable

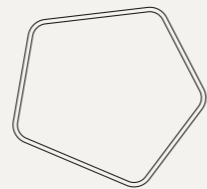

Ø180

TECHNICAL DATA

Net Weight: 25 kg
 Light source: strip LED 24 V
 Input Voltage [V]: 220-240 V or 110-120 V upon request
 Max Power [W]: 56.64 W
 Light colour [K]: 3000 K or 2700 K upon request
 Flux [lm]: 2700 K - 7375 lm / 3000 K- 7877 lm**
 CRI: >90
 Dimming: Push / Phase cut / 0-10 V / 1-10 V / DMX / DALI-2 dimmable

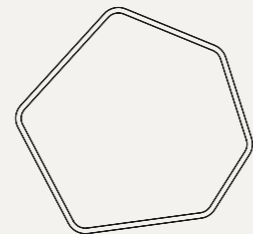

Ø220

TECHNICAL DATA

Net Weight: 30 kg
 Light source: strip LED 24 V
 Input Voltage [V]: 220-240 V or 110-120 V upon request
 Max Power [W]: 76.80 W
 Light colour [K]: 3000 K or 2700 K upon request
 Flux [lm]: 2700 K - 10000 lm / 3000 K - 10680 lm**
 CRI: >90
 Dimming: Push / Phase cut / 0-10 V / 1-10 V / DMX / DALI-2 dimmable

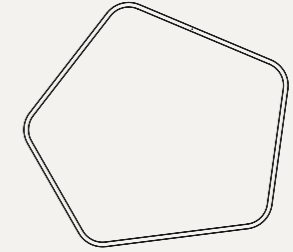

Ø280

TECHNICAL DATA

Net Weight: 35 kg
 Light source: strip LED 24 V
 Input Voltage [V]: 220-240 V or 110-120 V upon request
 Max Power [W]: 84.48 W
 Light colour [K]: 3000 K or 2700 K upon request
 Flux [lm]: 2700 K - 11000 lm / 3000 K - 11748 lm**
 CRI: >90
 Dimming: Push / Phase cut / 0-10 V / 1-10 V / DMX / DALI-2 dimmable

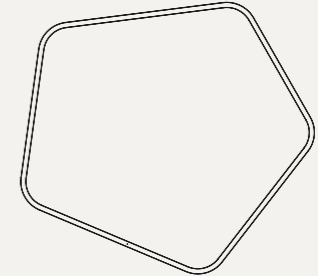

Ø300



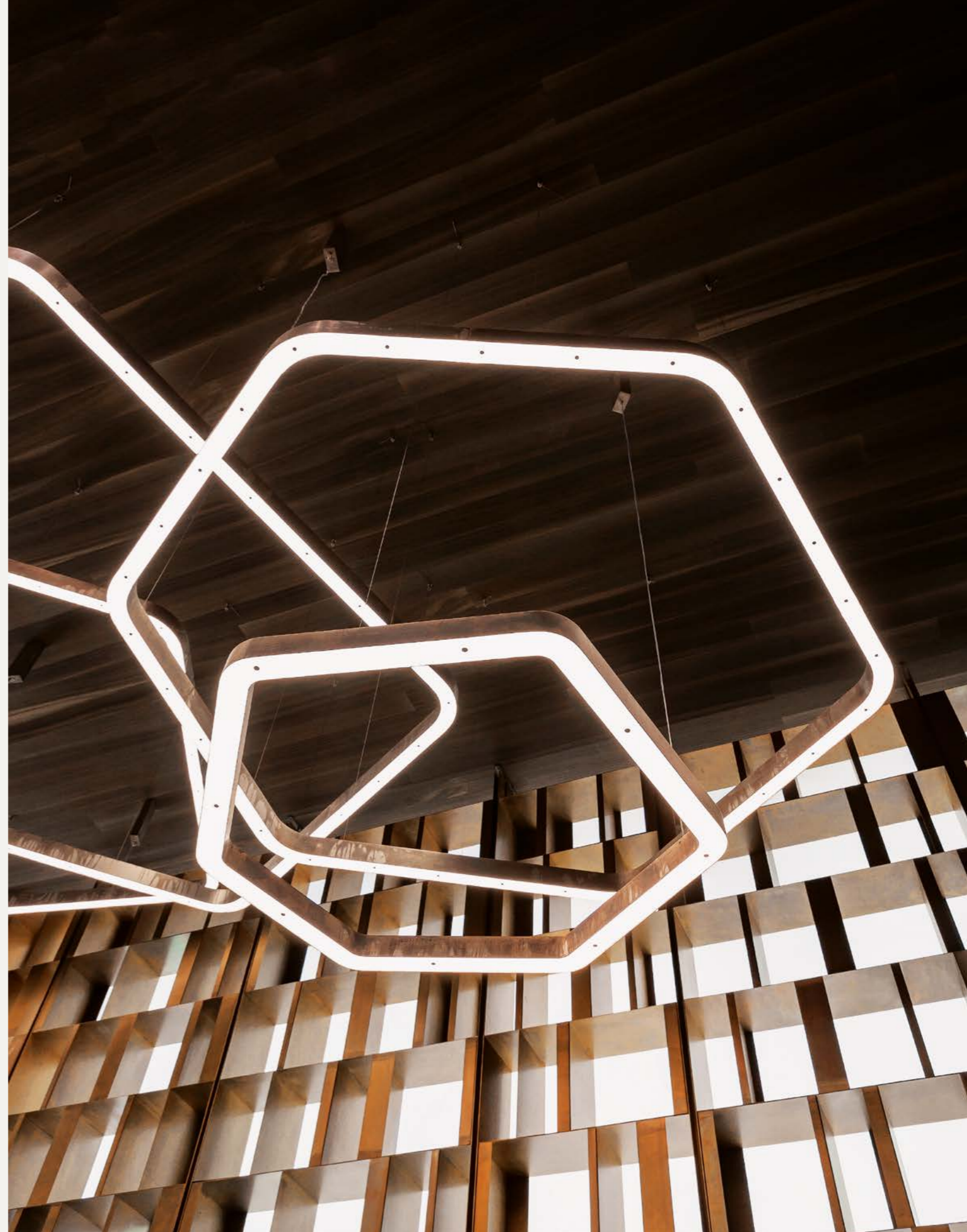

LIGHT RING POLYGONAL EVO

CHANDELIERS



New irregular shapes for the iconic Light Ring Polygonal Evo, paired with an overall language of repeating, iterative configurations, create bespoke constellations. Rhythmic cadences punctuate the space weaving gorgeous narratives that tantalize with a sense of wonderment.

Nuove forme irregolari per l'iconico anello luminoso poligonale EVO, abbinato a un linguaggio di continue configurazioni iterative che creano delle costellazioni su misura. Cadenze ritmiche punteggiano lo spazio intrecciando splendide narrazioni che stuzzicano con un senso di meraviglia.

DESIGNER
Massimo Castagna

DETAILS

- Metal pendant lights with rings of different sizes.
- Energy-saving LED light (energy efficiency index A).
- Transformer integrated into the ceiling rosette.
- Alternative mounting system with a remote transformer.
- Low voltage power supplied through suspension cables.
- Standard total height 180 cm.

LIGHT SOURCE

- COB LED 24V 3000K.
- Upon request available with extra warm light 2700K or 4000K.
- Available 110V upon request.
- Dimming function included.

DETTAGLI

- Lampade a sospensione in metallo con anelli di dimensioni diverse.
- Sorgente luminosa rivolta verso il basso o verso l'interno.
- Sospensione a led a risparmio energetico (Indice di efficienza energetica A).
- Trasformatore integrato nel rosone a soffitto.
- Sistema di montaggio alternativo con trasformatore remoto.
- Alimentazione a bassa tensione fornita tramite cavi di sospensione.
- Altezza totale standard 180 cm.

FONTE LUMINOSA

- LED 24V 3000K.
- Su richiesta disponibile con luce extra calda a 2700K o 4000K.
- Disponibile 110V su richiesta.
- Dimmerabile.

CONSTRUCTION SPECIFICATION

Weight: 8,60 kg-9,60 kg
Material: Brass or steel profile with mehakrylate diffuser
Overall height: 180 cm adjustable
Finish: Burnished Brass, Black Burnished Brass, Black Burnished Steel

Certified Product
Prodotto certificato **CE ENEC** IP20

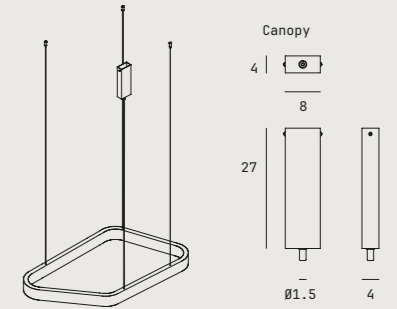

TECHNICAL DATA

Net Weight: 8.6 kg
Light source: strip LED 24 V
Input Voltage [V]: 220-240 V or 110-120 V upon request
Max Power [W]: 26.88 W
Light colour [K]: 3000 K or 2700 K upon request
Flux [lm]: 2700 K - 3500 lm / 3000 K - 3738 lm**
CRI: >90
Dimming: Push / Phase cut / 0-10 V / 1-10 V / DMX / DALI-2 dimmable

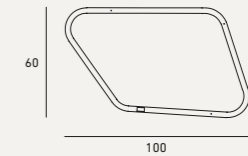

Downward-facing LED

TECHNICAL DATA

Net Weight: 9.8 kg
Light source: strip LED 24 V
Input Voltage [V]: 220-240 V or 110-120 V upon request
Max Power [W]: 35.52 W
Light colour [K]: 3000 K or 2700 K upon request
Flux [lm]: 2700 K - 4625 lm / 3000 K - 4940 lm**
CRI: >90
Dimming: Push / Phase cut / 0-10 V / 1-10 V / DMX / DALI-2 dimmable

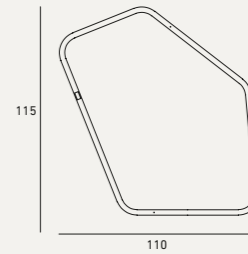

Downward-facing LED

TECHNICAL DATA

Net Weight: 8.7 kg
Light source: strip LED 24 V
Input Voltage [V]: 220-240 V or 110-120 V upon request
Max Power [W]: 26.88 W
Light colour [K]: 3000 K or 2700 K upon request
Flux [lm]: 2700 K - 3500 lm / 3000 K - 3738 lm**
CRI: >90
Dimming: Push / Phase cut / 0-10 V / 1-10 V / DMX / DALI-2 dimmable

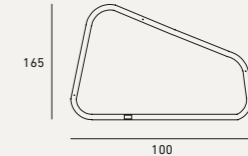

Downward-facing LED

TECHNICAL DATA

Net Weight: 8.6 kg
Light source: strip LED 24 V
Input Voltage [V]: 220-240 V or 110-120 V upon request
Max Power [W]: 77.76 W
Light colour [K]: 3000 K or 2700 K upon request
Flux [lm]: 2700 K - 10125 lm / 3000 K - 10814 lm**
CRI: >90
Dimming: Push / Phase cut / 0-10 V / 1-10 V / DMX / DALI-2 dimmable

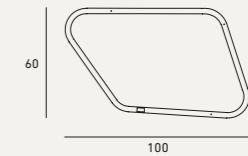

Inward-facing LED



TECHNICAL DATA

Net Weight:	9.8 kg
Light source:	strip LED 24 V
Input Voltage [V]:	220-240 V or 110-120 V upon request
Max Power [W]:	106.56 W
Light colour [K]:	3000 K or 2700 K upon request
Flux [lm]:	2700K - 13875 lm / 3000 K - 14819 lm**
CRI:	>90
Dimming:	Push / Phase cut / 0-10 V / 1-10 V / DMX / DALI-2 dimmable

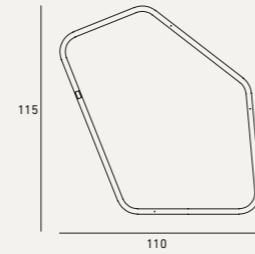

Inward-facing LED

TECHNICAL DATA

Net Weight:	8.7 kg
Light source:	strip LED 24 V
Input Voltage [V]:	220-240 V or 110-120 V upon request
Max Power [W]:	74.88 W
Light colour [K]:	3000 K or 2700 K upon request
Flux [lm]:	2700 K - 9750 lm / 3000 K - 10413 lm**
CRI:	>90
Dimming:	Push / Phase cut / 0-10 V / 1-10 V / DMX / DALI-2 dimmable

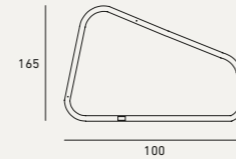

Inward-facing LED



**Output of led inside the lamp. Losses due to diffusor and reflectors are not considered. Values are indicative, ambient temperature, height and position of the lamp may vary the values.
 **Emissione del LED all'interno della lampada. Le perdite dovute a diffusore e riflettori non sono considerate. I valori sono indicativi: temperatura ambiente, altezza e posizione della lampada possono influenzare i valori.



LIGHT 5 RING MULTIMATERIC

CHANDELIERS



Concentric rings, in sequence or overlapping, wall-mounted or suspended, develop archetypal visual codes inspired by the beauty and purity that the circle synthesizes in its perfect symbolic form. An idea realized with important hand-crafted materials that diffuse a warm and intriguing light.

Anelli concentrici, in sequenza o sovrapposti, a parete o sospesi, sviluppano codici visivi archetipici ispirati alla bellezza e alla purezza che il cerchio sintetizza nella sua perfetta forma simbolica. Un'idea realizzata con importanti materiali lavorati a mano che diffondono una luce calda e intrigante.

DESIGNER
Massimo Castagna

DETAILS

- 5 rings made of different materials.
- Unfinished canopy \varnothing 115 cm H6 (to be painted locally)
- Pendant energy-saving LED light (Energy efficiency index A).
- Low voltage power supplied through suspension cable.
- Transformer integrated into the ceiling rosette.
- Standard minimum total height cm 130h.

LIGHT SOURCE

- LED 24V 3000K.
- Upon request available with extra warm light 2700K or 4000K.
- Available 110V upon request.
- Dimming function included.

DETTAGLI



- 5 anelli composti da materiali diversi.
- Rosone grezzo \varnothing 115 cm H6 (da dipingere in loco)
- Sospensione a led a risparmio energetico (Indice di efficienza energetica A).
- Alimentazione a bassa tensione fornita tramite cavo di sospensione.
- Trasformatore incorporato nel rosone a soffitto.
- Altezza totale standard minima cm 130h.

FONTE LUMINOSA

- LED 24V 3000K.
- Su richiesta disponibile con luce extra calda a 2700K o 4000K.
- Disponibile 110V su richiesta.
- Dimmerabile.

CONSTRUCTION SPECIFICATION

Weight: 48 kg
Material: Brass or steel profile with mehakrylate diffuser
Overall height: 130 cm adjustable
Finish: Burnished Brass, Black Burnished Brass, Brass Patina

Certified Product
Prodotto certificato   IP20

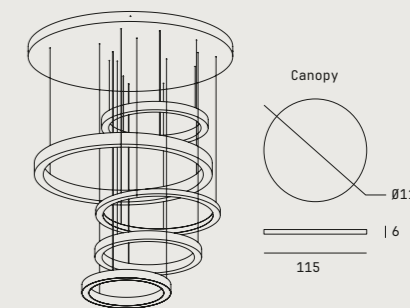

TECHNICAL DATA

Net Weight: 48 kg
Light source: strip LED 24V
Input Voltage [V]: 220-240 V or 110-120 V upon request
Max Power [W]: 86 W
Light colour [K]: 3000 K or 2700 K upon request
Flux [lm]: 2700 K-10260 lm; 3000 K-10830 lm**
CRI: >80/>90 upon request
Dimming: Push/Phase cut/0-10 V/1-10 V/DMX/DALI-2 dimmable

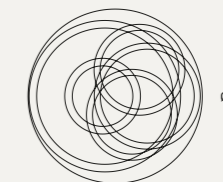
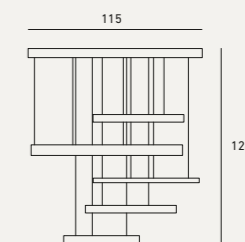

**Output of led inside the lamp. Losses due to diffusor and reflectors are not considered. Values are indicative, ambient temperature, height and position of the lamp may vary the values.
**Emissione del LED all'interno della lampada. Le perdite dovute a diffusore e riflettori non sono considerate. I valori sono indicativi: temperatura ambiente, altezza e posizione della lampada possono influenzare i valori.



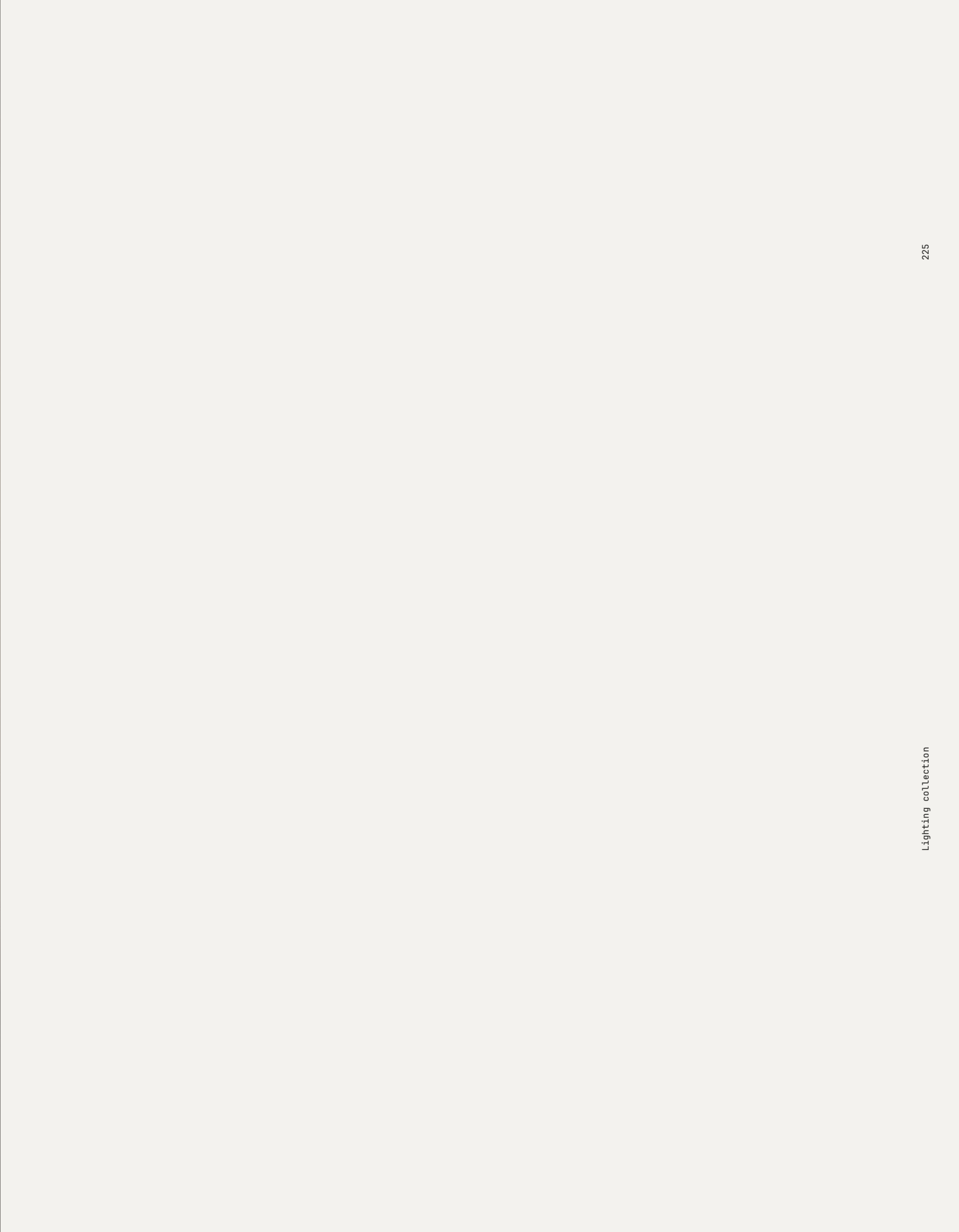

MAPLE

CHANDELIERS



Like the seeds of the Maple tree, Maple, pendant light, expands its stems in black burnished brass, germinating with unusual and charismatic organic buds in blown glass.

Come i semi dell'albero di acero, Maple, lampada a sospensione, espande i suoi steli in ottone brunito nero, germinando con insoliti e carismatici boccioli organici in vetro soffiato.

DESIGNER
Yabu Pushelberg

DETAILS

- Low consumption suspension LED light with brass stems and central Y-shaped body in Sand Cast Bronze (or Brass).
- Lustrò Grey or frosted glass available.
- Pendant energy-saving LED light (Energy efficiency index A).
- Transformer integrated into the ceiling rosette.

LIGHT SOURCE

- Henge LED bulb 24V 3000K.
- Upon request available with extra warm light 2700K.
- Available 110V upon request.
- Dimming function included.

DETTAGLI

- Lampada LED a sospensione a basso consumo con steli in ottone e corpo centrale a Y in fusione di Bronzo (o Ottone).
- Disponibile vetro Lustrò Grey o satinato.
- Sospensione a led a risparmio energetico (Indice di efficienza energetica A).
- Trasformatore integrato nel rosone a soffitto.

FONTE LUMINOSA

- Lampadina LED Henge
- Su richiesta disponibile con luce extra calda a 2700K.
- Disponibile 110V su richiesta.
- Dimmerabile.

CONSTRUCTION SPECIFICATION

Weight: 3.5-3.6 kg
Material: Y-shaped central body in Sand Cast Bronze or Brass. Lighting body in brass with blown glass diffuser Standard 110 cm
Finish:

- Central body-Sand Cast Brass, Sand Cast Bronze,
- Lighting body-Burnished Brass, Black Burnished Brass
- Frosted Glass, Lustrò grey

Certified Product
Prodotto certificato

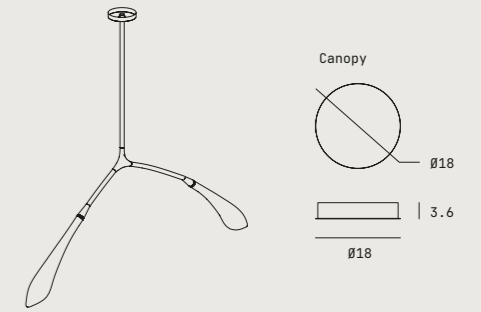

TECHNICAL DATA

Net Weight: 3.5 kg
Light source: LED curved bulb G4-24 V
Input Voltage [V]: 220-240 V or 110-120 V upon request
Max Power [W]: 8 W
Light colour [K]: 3000K or 2700 K upon request
Flux [lm]: 1280 lm**
CRI: >90
Dimming: Push/Phase cut/0-10 V/1-10 V/DMX/DALI-2 dimmable

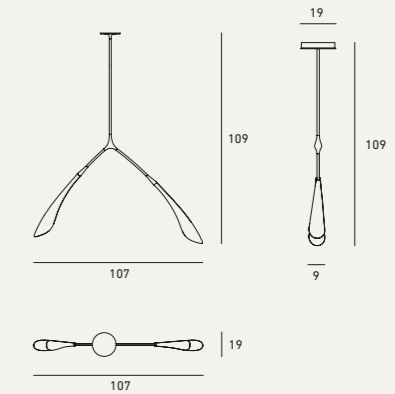

TECHNICAL DATA

Net Weight: 3.6 kg
Light source: LED curved bulb G4-24 V
Input Voltage [V]: 220-240 V or 110-120 V upon request
Max Power [W]: 8 W
Light colour [K]: 3000 K or 2700 K upon request
Flux [lm]: 1280 lm**
CRI: >90
Dimming: Push/Phase cut/0-10 V/1-10 V/DMX/DALI-2 dimmable

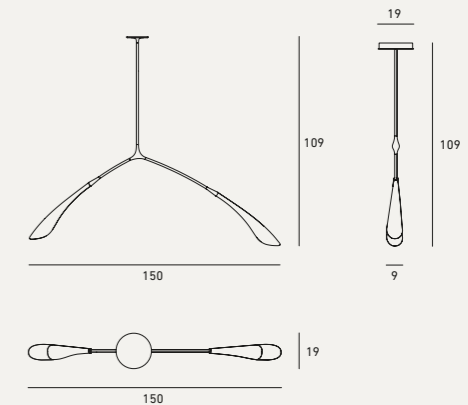

**Output of led inside the lamp. Losses due to diffusor and reflectors are not considered. Values are indicative, ambient temperature, height and position of the lamp may vary the values.
 **Emissione del LED all'interno della lampada. Le perdite dovute a diffusore e riflettori non sono considerate. I valori sono indicativi: temperatura ambiente, altezza e posizione della lampada possono influenzare i valori.





PIPE S

CHANDELIERS



Flexible and slender, easily adjustable, Pipe Light, pendant, in burnished brass, celebrates with a contemporary spirit a minimalist aesthetic with an industrial flavor, characterized by evocative signs of the past.

Flessibile e slanciata, facilmente orientabile, Pipe Light, a sospensione, in ottone brunito, celebra con spirito contemporaneo un'estetica minimalista dal sapore industriale, caratterizzata da suggestivi segni del passato.

DESIGNER
Massimo Castagna

DETAILS

- Pendant light made of burnished brass.
- Ø 4.5 cm.
- Light Inclination adjustable.
- Steel wire suspension.
- Power supply cable coated with red silk.
- Standard overall height 250 cm.

LIGHT SOURCE

- Light bulb E 27 tungsten, warm light 3000K, blown glass ampoule with visible filament shaped like an old carbon light.
- Upon request available with extra warm light 2700K.
- Available 110V upon request.
- Phase cut dimmable.

DETTAGLI

- Lampada a sospensione in ottone brunito.
- Ø 4,5 cm.
- Inclinazione della luce regolabile.
- Sospensione in filo d'acciaio.
- Cavo di alimentazione rivestito di seta rossa.
- Altezza complessiva standard 250 cm.
- Su richiesta disponibile 110V.

FONTE LUMINOSA

- Lampadina E 27 tungsteno, luce calda, ampolla in vetro soffiato con filamento visibile a forma di vecchia luce al carbonio.
- Su richiesta disponibile con luce extra calda a 2700K.
- Disponibile 110V su richiesta.
- Dimmerabile taglio di fase.

CONSTRUCTION SPECIFICATION

Weight: 0,80 kg-1,60 kg
Material: Brass with blown glass bulb
Finish: Red Silk power lead cover
Burnished Brass

Certified Product
Prodotto certificato

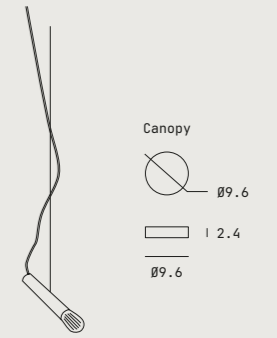

TECHNICAL DATA

Net Weight: 1.6 kg for 2 pieces
Light source: E 27 tungsten light bulb
Input Voltage [V]: 220-240 V or 110-120 V upon request
Max Power [W]: 60 W
Light colour [K]: 3000 K
FLux [lm]: 350 lm**
CRI: -
Dimming: Phase cut

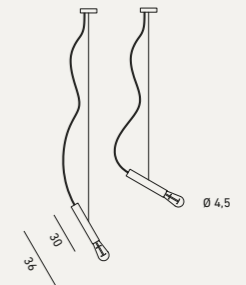

**Output of led inside the lamp. Losses due to diffusor and reflectors are not considered. Values are indicative, ambient temperature, height and position of the lamp may vary the values.
**Emissione del LED all'interno della lampada. Le perdite dovute a diffusore e riflettori non sono considerate. I valori sono indicativi: temperatura ambiente, altezza e posizione della lampada possono influenzare i valori.





SKYFALL

CHANDELIERS



A generous cascade of etched glass and brass drops synchronizes solos and multi-voice modulations with cadences, inflections, and variations in intensity that propagate the assonances and vibrations of a sublime choral vocalism.

Una generosa cascata di vetro acidato e gocce di ottone sincronizza assoli e modulazioni a più voci con cadenze, inflessioni e variazioni di intensità che propagano le assonanze e le vibrazioni di una sublime vocalità corale.

CONSTRUCTION SPECIFICATION

Weight: 0,70 kg-3,40 kg
 Material: Brass
 Finish: Brass and Glass
 Burnished Brass, Black Burnished Brass, H-Silver, H-Silver Black

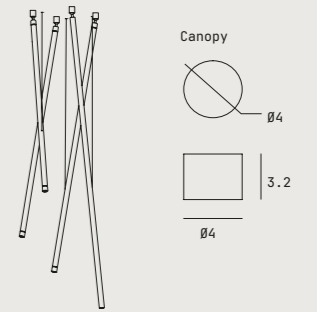

Certified Product
 Prodotto certificato



TECHNICAL DATA

Net Weight: 1,10 kg-3,40 kg
 Light source: 700 mA CC led module
 Input Voltage [V]: 220-240 V or 110-120 upon request
 Max Power [W]: 2,2 W
 Light colour [K]: 3000 K or 2700 K upon request
 Flux [lm]: 2700 K-203 lm; 3000 K-218 lm**
 CRI: >90
 Dimming: Push/Phase cut/0-10 V/1-10 V/DMX/DALI-2 dimmable

DESIGNER
 Massimo Castagna

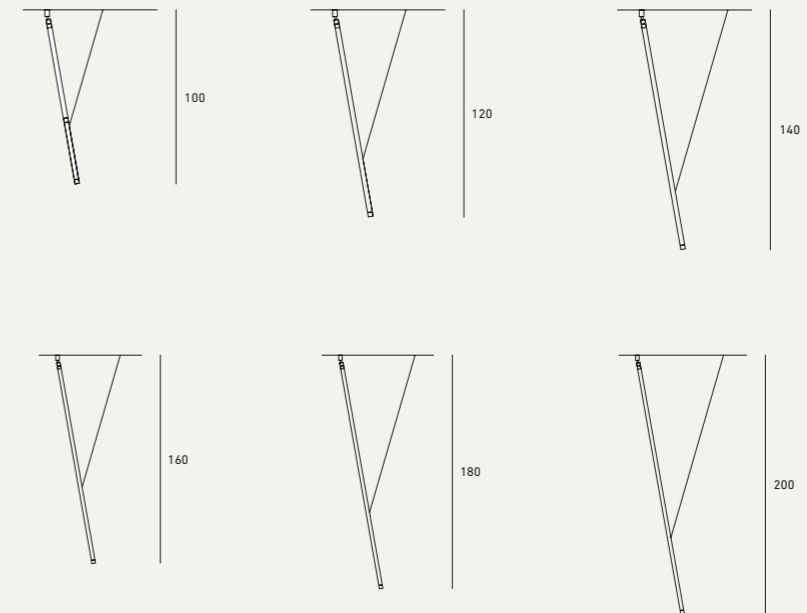

DETAILS

- Pendant light made of metal or metal and glass.
- In the metal option the light is down-pointing. In the metal and glass option, the light points in both directions.
- Ø 2.8 cm.
- Light Inclination adjustable.
- Energy-saving LED light (Energy efficiency index A).
- Transformer must be placed remotely.
- Alternative mounting system with a remote transformer.
- Low voltage power supplied through suspension cable.

LIGHT SOURCE

- COB LED 24V 3000K.
- Upon request available with extra warm light 2700K.
- Available 110V upon request.
- Dimming function included.

DETTAGLI

- Lampada a sospensione in metallo o metallo e vetro.
- Nell'opzione metallo la luce è rivolta verso il basso. Nell'opzione metallo e vetro la luce può puntare in entrambe le direzioni.
- Ø 2,8 cm.
- Inclinazione della luce regolabile.
- Sospensione a led a risparmio energetico (Indice di efficienza energetica A).
- Il trasformatore deve essere posizionato a remoto.
- Sistema di montaggio alternativo con trasformatore remoto.
- Alimentazione a bassa tensione fornita tramite cavi di sospensione.

FONTE LUMINOSA

- Lampadina COB LED 24V 3000K.
- Su richiesta disponibile con luce extra calda a 2700K.
- Disponibile 110V su richiesta.
- Dimmerabile.

**Output of led inside the lamp. Losses due to diffusor and reflectors are not considered. Values are indicative, ambient temperature, height and position of the lamp may vary the values.
 **Emissione del LED all'interno della lampada. Le perdite dovute a diffusore e riflettori non sono considerate. I valori sono indicativi: temperatura ambiente, altezza e posizione della lampada possono influenzare i valori.







SPYDER X

CHANDELIERS



The suspension lamp, Spyder X, an ensemble of slender, fluted, borosilicate glass cylinders, exquisitely finished at each end with rounded burnished brass protuberances, horizontally and vertically arranged and connected in balanced symmetry, interprets a performance of lightness and elegance.

La lampada a sospensione Spyder X, un insieme di esili cilindri in vetro borosilicato scanalato, finemente rifiniti alle estremità da protuberanze arrotondate in ottone brunito, disposti orizzontalmente e verticalmente e collegati in equilibrata simmetria, interpreta una performance di leggerezza ed eleganza.

CONSTRUCTION SPECIFICATION

Weight: 2.5-3.8 kg
Material: Brass with light source in borosilicate glass
Finish: Burnished Brass, Black Burnished Brass, Burnished Titanio, Burnished Platino, Brass Patina, H-Silver Patina, H-Pale Gold
Fixing type: Standard-Canopy dimensions Cm Ø5x33h-Cm Remote transformer with fixing type A-B-C

Certified Product
 Prodotto certificato



TECHNICAL DATA

Net Weight: 2.5 kg
Light source: Strip led 24 V
Input Voltage [V]: 220-240 V or 110-120 V upon request
Max Power [W]: 25 W
Light colour [K]: 3000 K or 2700 K upon request
Flux [lm]: 2700 K-1886 lm/3000 K-2070 lm**
CRI: >90
Dimming: Push/Phase cut/0-10 V/1-10 V/DMX/DALI-2 dimmable

Vertical
70h

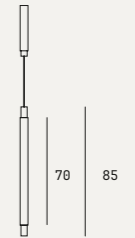

DESIGNER
 Massimo Castagna

TECHNICAL DATA

Net Weight: 2,70 kg
Light source: Strip led 24V
Input Voltage [V]: 220-240 V or 110-120 upon request
Max Power [W]: 29 W
Light colour [K]: 3000 K or 2700 K upon request
Flux [lm]: 2700 K-2173 lm; 3000 K-2385 lm**
CRI: >90
Dimming: Push/Phase cut/0-10 V/1-10 V/DMX/DALI-2 dimmable

Vertical
100h

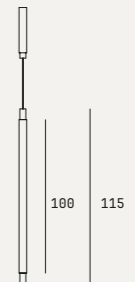

TECHNICAL DATA

Net Weight: 3,80 kg
Light source: Strip led 24V
Input Voltage [V]: 220-240 V or 110-120 upon request
Max Power [W]: 46 W
Light colour [K]: 3000 K or 2700 K upon request
Flux [lm]: 2700 K-3444 lm; 3000 K-3780 lm**
CRI: >90
Dimming: Push/Phase cut/0-10 V/1-10 V/DMX/DALI-2 dimmable

Vertical
150h

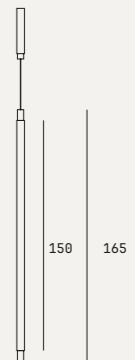

DETAILS

- Light source incorporated in a borosilicate cylindrical glass.
- Energy-saving LED light (Energy efficiency index A).
- Transformer incorporated in the ceiling rosette.
- Alternative mounting system with a remote transformer.
- Low voltage power supplied through suspension cables.
- Standard total height 180 cm.

LIGHT SOURCE

- LED 24V 3000K.
- Upon request available with extra warm light 2700K.
- Available 110V upon request.
- Dimming function included.

DETTAGLI

- Sorgente luminosa incorporata in vetro cilindrico borosilicato.
- Sospensione a led a risparmio energetico (Indice di efficienza energetica A).
- Trasformatore incorporato nel rosone a soffitto.
- Sistema di montaggio alternativo con trasformatore remoto.
- Alimentazione a bassa tensione fornita tramite cavi di sospensione.
- Altezza totale standard 180 cm.

FONTE LUMINOSA

- Strip LED 24V 3000K.
- Su richiesta disponibile con luce extra calda a 2700K.
- Disponibile 110V su richiesta.
- Dimmerabile.



CONSTRUCTION
SPECIFICATION

Weight:	2.5-3.8 kg
Material:	Brass with light source in borosilicate glass
Finish:	Burnished Brass, Black Burnished Brass, Burnished Titanio, Burnished Platino, Brass Patina, H-Silver Patina, H-Pale Gold Standard-Canopy dimensions
Fixing type:	Cm Ø5x33h-Cm Remote transformer with fixing type A-B-C

Certified Product
Prodotto certificato 

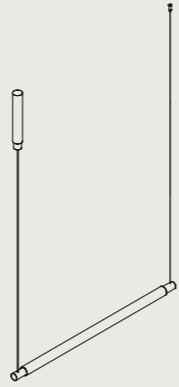

TECHNICAL DATA

Net Weight:	2.5 kg
Light source:	Strip led 24 V
Input Voltage [V]:	220-240 V or 110-120 V upon request
Max Power [W]:	25 W
Light colour [K]:	3000 K or 2700 K upon request
Flux [lm]:	2700 K-1886 lm/3000 K-2070 lm**
CRI:	>90
Dimming:	Push/Phase cut/0-10 V/1-10 V/DMX/DALI-2 dimmable

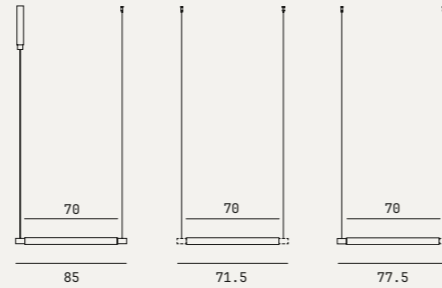

Horizontal Single element/ Central element/ End element

TECHNICAL DATA

Net Weight:	2.7 kg
Light source:	Strip led 24 V
Input Voltage [V]:	220-240 V or 110-120 V upon request
Max Power [W]:	29 W
Light colour [K]:	3000 K or 2700 K upon request
Flux [lm]:	2700 K-2173 lm/3000 K-2385 lm**
CRI:	>90
Dimming:	Push/Phase cut/0-10 V/1-10 V/DMX/DALI-2 dimmable

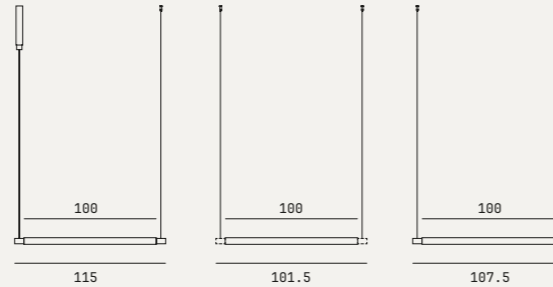

Horizontal Single element / Central element/ End element

TECHNICAL DATA

Net Weight:	3.8 kg
Light source:	Strip led 24 V
Input Voltage [V]:	220-240 V or 110-120 V upon request
Max Power [W]:	46 W
Light colour [K]:	3000 K or 2700 K upon request
Flux [lm]:	2700 K-3444 lm/3000 K-3780 lm**
CRI:	>90
Dimming:	Push/Phase cut/0-10 V/1-10 V/DMX/DALI-2 dimmable

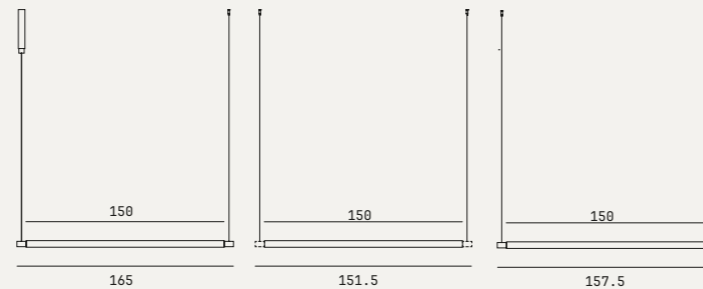

Horizontal Single element / Central element / End element

**Output of led inside the lamp. Losses due to diffusor and reflectors are not considered. Values are indicative, ambient temperature, height and position of the lamp may vary the values.
**Emissione del LED all'interno della lampada. Le perdite dovute a diffusore e riflettori non sono considerate. I valori sono indicativi: temperatura ambiente, altezza e posizione della lampada possono influenzare i valori.





SPYDER 80

LAMPS/CHANDELIERS



A vintage industrial vocabulary, manipulated in its aesthetic presence, proposes SPYDER 80, a refined modular trilogy of pendant sleek glass cylinders, elevated to an emotional dimension.

Un vocabolario industriale vintage, manipolato nella sua presenza estetica, propone SPYDER 80, una raffinata trilogia modulare di eleganti cilindri sospesi in vetro, elevati ad una dimensione emozionale.

DESIGNER
Massimo Castagna

DETAILS

- Light source incorporated in a borosilicate cylindrical glass Ø8
- Energy efficiency index A
- Dimming function (DALI, DMX, 1-10 V, 0-10 V or Phase cut)

LIGHT SOURCE

- Strip LED 24 V warm white 3000 K, CRI >90
- Voltage 240 V or 120 V available upon request
- Available upon request extra warm light 2700 K (no extra cost).

DETTAGLI

- Sorgente luminosa incorporata in un vetro cilindrico in borosilicato Ø8
- Indice di efficienza energetica A
- Funzione dimmer (DALI, DMX, 1-10 V, 0-10 V o taglio di fase)

FONTE LUMINOSA

- Strip LED 24 V bianco caldo 3000 K, CRI >90
- Tensione 240 V o 120 V disponibile su richiesta
- Disponibile su richiesta luce extra calda 2700 K (senza costi aggiuntivi).

CONSTRUCTION SPECIFICATION

Weight: 8.6-17.2 kg
 Material: Brass with light source in Borosilicate Glass
 Finish: Burnished Brass, Burnished Titanio, Burnished Platino
 Fixing type: Standard - Canopy dimensions Cm Ø5x33h
 Remote transformer with fixing type A - B - C

Certified Product
 Prodotto certificato

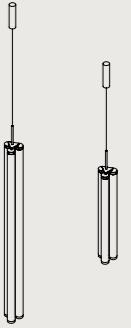

TECHNICAL DATA

Net Weight: 13 kg
 Light source: Strip led 24 V
 Input Voltage [V]: 220-240 V or 110-120 V upon request
 Max Power [W]: 85 W
 Light colour [K]: 3000 K or 2700 K upon request
 Flux [lm]: 2700 K - 7990 lm / 3000 K - 8500 lm**
 CRI: >90
 Dimming: Push / Phase cut / 0-10 V / 1-10 V / DMX / DALI-2 dimmable

Spyder 80
75h

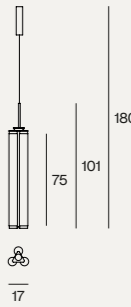

TECHNICAL DATA

Net Weight: 18 kg
 Light source: Strip led 24 V
 Input Voltage [V]: 220-240 V or 110-120 V upon request
 Max Power [W]: 126 W
 Light colour [K]: 3000 K or 2700 K upon request
 Flux [lm]: 2700 K - 11844 lm / 3000 K - 12600 lm**
 CRI: >90
 Dimming: Push / Phase cut / 0-10 V / 1-10 V / DMX / DALI-2 dimmable

Spyder 80
150h

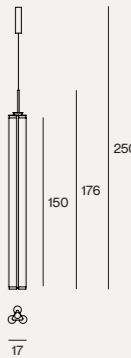

**Output of led inside the lamp. Losses due to diffusor and reflectors are not considered. Values are indicative, ambient temperature, height and position of the lamp may vary the values.

**Emissione del LED all'interno della lampada. Le perdite dovute a diffusore e riflettori non sono considerate. I valori sono indicativi: temperatura ambiente, altezza e posizione della lampada possono influenzare i valori.





SPYDER XS

LAMPS/CHANDELIERS



The suspension lamp, Spyder XS, an ensemble of slender, fluted, borosilicate glass cylinders, exquisitely finished at each end with rounded burnished brass protuberances, horizontally and vertically arranged and connected in balanced symmetry, interprets a performance of lightness and elegance.

La lampada a sospensione Spyder XS, un insieme di esili cilindri in vetro borosilicato scanalato, finemente rifiniti alle estremità da protuberanze arrotondate in ottone brunito, disposti orizzontalmente e verticalmente e collegati in equilibrata simmetria, interpreta una performance di leggerezza ed eleganza.

DESIGNER
Massimo Castagna

DETAILS

- Light source incorporated in a borosilicate cylindrical glass Ø 3 cm.
- Energy efficiency index A.
- Dimming function. (DALI, DMX, 1-10V, 0-10 or Phase cut)

LIGHT SOURCE

- Strip LED 24V warm white 3000K, CRI > 90.
- Voltage: 240V or 120V available upon request.
- Available upon request extra warm light 2700K (no extra cost)

DETTAGLI

- Sorgente luminosa incorporata in vetro cilindrico borosilicato Ø 3 cm.
- Indice di efficienza energetica A.
- Funzione dimmer. (DALI, DMX, 1-10V, 0-10 o Taglio di fase)

FONTE LUMINOSA

- Strip LED 24V bianco caldo 3000K, CRI > 90.
- Voltaggio: 240V o 120V disponibile su richiesta.
- Disponibile su richiesta luce extra calda 2700K (senza sovrapprezzo)

CONSTRUCTION SPECIFICATION

Weight: 2-3.2 kg
Material: Brass with light source in borosilicate glass.
Finish: Burnished Brass, Black Burnished Brass, Burnished Titanio, Burnished Platino, Brass Patina, H-Silver Patina, H-Pale Gold
Fixing type: Standard - Canopy dimensions Ø5x33h cm
 Remote transformer with fixing type A - B - C

Certified Product
 Prodotto certificato

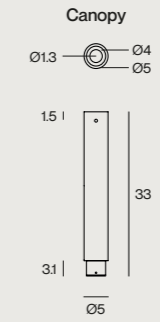

TECHNICAL DATA

Net Weight: 2 kg
Light source: Strip LED 24 V
Input Voltage [V]: 220-240 V or 110-120 V upon request
Max Power [W]: 25 W
Light colour [K]: 3000 K or 2700 K upon request
Flux [lm]: 2700 K - 1886 lm / 3000 K - 2070 lm**
CRI: >90
Dimming: Push / Phase cut / 0-10 V / 1-10 V / DMX / DALI-2 dimmable

Spyder XS - Vertical
70h



TECHNICAL DATA

Net Weight: 2.2 kg
Light source: Strip LED 24 V
Input Voltage [V]: 220-240 V or 110-120 V upon request
Max Power [W]: 29 W
Light colour [K]: 3000 K or 2700 K upon request
Flux [lm]: 2700 K - 2173 lm / 3000 K - 2385 lm**
CRI: >90
Dimming: Push / Phase cut / 0-10 V / 1-10 V / DMX / DALI-2 dimmable

Spyder XS - Vertical
100h



TECHNICAL DATA

Net Weight: 3.2 kg
Light source: Strip LED 24 V
Input Voltage [V]: 220-240 V or 110-120 V upon request
Max Power [W]: 46 W
Light colour [K]: 3000 K or 2700 K upon request
Flux [lm]: 2700 K - 3444 lm / 3000 K - 3780 lm**
CRI: >90
Dimming: Push / Phase cut / 0-10 V / 1-10 V / DMX / DALI-2 dimmable

Spyder XS - Vertical
150h



**Output of led inside the lamp. Losses due to diffusor and reflectors are not considered. Values are indicative, ambient temperature, height and position of the lamp may vary the values.
 **Emissione del LED all'interno della lampada. Le perdite dovute a diffusore e riflettori non sono considerate. I valori sono indicativi: temperatura ambiente, altezza e posizione della lampada possono influenzare i valori.



CONSTRUCTION SPECIFICATION

Weight: 2-3.2 kg
 Material: Brass with light source in borosilicate glass
 Finish: Burnished Brass, Black Burnished Brass, Burnished Titano, Burnished Platino, Brass Patina, H-Silver Patina, H-Pale Gold
 Fixing type: Standard - Canopy dimensions Cm Ø5x33h
 Remote transformer with fixing type A - B - C

Certified Product
 Prodotto certificato **CE ENEC** IP20

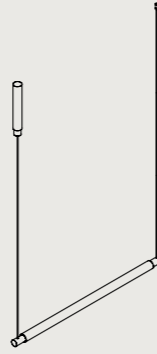
TECHNICAL DATA

Net Weight: 2 kg
 Light source: Strip LED 24 V
 Input Voltage [V]: 220-240 V or 110-120 V upon request
 Max Power [W]: 25 W
 Light colour [K]: 3000 K or 2700 K upon request
 Flux [lm]: 2700 K - 1886 lm / 3000 K - 2070 lm**
 CRI: >90
 Dimming: Push / Phase cut / 0-10 V / 1-10 V / DMX / DALI-2 dimmable

Spyder XS - Horizontal
 Single element

TECHNICAL DATA

Net Weight: 2 kg
 Light source: Strip LED 24 V
 Input Voltage [V]: 220-240 V or 110-120 V upon request
 Max Power [W]: 25 W
 Light colour [K]: 3000 K or 2700 K upon request
 Flux [lm]: 2700 K - 1886 lm / 3000 K - 2070 lm**
 CRI: >90
 Dimming: Push / Phase cut / 0-10 V / 1-10 V / DMX / DALI-2 dimmable

Spyder XS - Horizontal
 Central element

TECHNICAL DATA

Net Weight: 2 kg
 Light source: Strip LED 24 V
 Input Voltage [V]: 220-240 V or 110-120 V upon request
 Max Power [W]: 25 W
 Light colour [K]: 3000 K or 2700 K upon request
 Flux [lm]: 2700 K - 1886 lm / 3000 K - 2070 lm**
 CRI: >90
 Dimming: Push / Phase cut / 0-10 V / 1-10 V / DMX / DALI-2 dimmable

Spyder XS - Horizontal
 End element

TECHNICAL DATA

Net Weight: 2.2 kg
 Light source: Strip LED 24 V
 Input Voltage [V]: 220-240 V or 110-120 V upon request
 Max Power [W]: 29 W
 Light colour [K]: 3000 K or 2700 K upon request
 Flux [lm]: 2700 K - 2173 lm / 3000 K - 2385 lm**
 CRI: >90
 Dimming: Push / Phase cut / 0-10 V / 1-10 V / DMX / DALI-2 dimmable

Spyder XS - Horizontal
 Single element

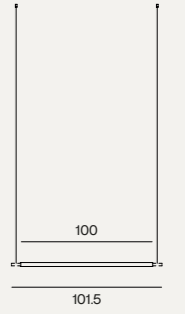
TECHNICAL DATA

Net Weight: 2.2 kg
 Light source: Strip LED 24 V
 Input Voltage [V]: 220-240 V or 110-120 V upon request
 Max Power [W]: 29 W
 Light colour [K]: 3000 K or 2700 K upon request
 Flux [lm]: 2700 K - 2173 lm / 3000 K - 2385 lm**
 CRI: >90
 Dimming: Push / Phase cut / 0-10 V / 1-10 V / DMX / DALI-2 dimmable

Spyder XS - Horizontal
 Central element

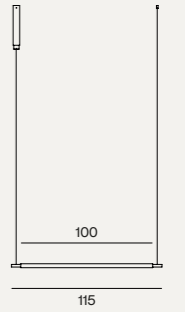
TECHNICAL DATA

Net Weight: 2.2 kg
 Light source: Strip LED 24 V
 Input Voltage [V]: 220-240 V or 110-120 V upon request
 Max Power [W]: 29 W
 Light colour [K]: 3000 K or 2700 K upon request
 Flux [lm]: 2700 K - 2173 lm / 3000 K - 2385 lm**
 CRI: >90
 Dimming: Push / Phase cut / 0-10 V / 1-10 V / DMX / DALI-2 dimmable

Spyder XS - Horizontal
 End element

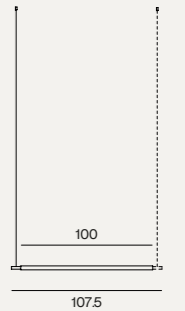
TECHNICAL DATA

Net Weight: 3.2 kg
 Light source: Strip LED 24 V
 Input Voltage [V]: 220-240 V or 110-120 V upon request
 Max Power [W]: 46 W
 Light colour [K]: 3000 K or 2700 K upon request
 Flux [lm]: 2700 K - 3444 lm / 3000 K - 3780 lm**
 CRI: >90
 Dimming: Push / Phase cut / 0-10 V / 1-10 V / DMX / DALI-2 dimmable

Spyder XS
 Single element

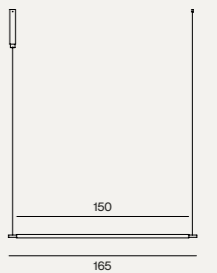

**Output of led inside the lamp. Losses due to diffusor and reflectors are not considered. Values are indicative, ambient temperature, height and position of the lamp may vary the values.
 **Emissione del LED all'interno della lampada. Le perdite dovute a diffusore e riflettori non sono considerate. I valori sono indicativi: temperatura ambiente, altezza e posizione della lampada possono influenzare i valori.

**Output of led inside the lamp. Losses due to diffusor and reflectors are not considered. Values are indicative, ambient temperature, height and position of the lamp may vary the values.
 **Emissione del LED all'interno della lampada. Le perdite dovute a diffusore e riflettori non sono considerate. I valori sono indicativi: temperatura ambiente, altezza e posizione della lampada possono influenzare i valori.

TECHNICAL DATA

Net Weight: 3.2 kg
 Light source: Strip LED 24 V
 Input Voltage [V]: 220-240 V or 110-120 V upon request
 Max Power [W]: 46 W
 Light colour [K]: 3000 K or 2700 K upon request
 Flux [lm]: 2700 K - 3444 lm / 3000 K - 3780 lm**
 CRI: >90
 Dimming: Push / Phase cut / 0-10 V / 1-10 V / DMX / DALI-2 dimmable

Spyder XS - Horizontal
 Central element

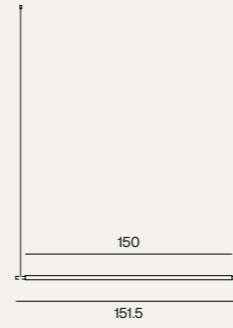

TECHNICAL DATA

Net Weight: 3.2 kg
 Light source: Strip LED 24 V
 Input Voltage [V]: 220-240 V or 110-120 V upon request
 Max Power [W]: 46 W
 Light colour [K]: 3000 K or 2700 K upon request
 Flux [lm]: 2700 K - 3444 lm / 3000 K - 3780 lm**
 CRI: >90
 Dimming: Push / Phase cut / 0-10 V / 1-10 V / DMX / DALI-2 dimmable

Spyder XS - Horizontal
 End element

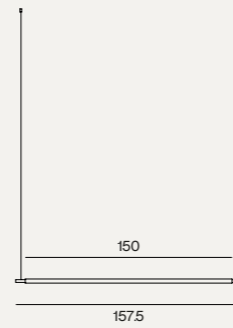

**Output of led inside the lamp. Losses due to diffusor and reflectors are not considered. Values are indicative, ambient temperature, height and position of the lamp may vary the values.
 **Emissione del LED all'interno della lampada. Le perdite dovute a diffusore e riflettori non sono considerate. I valori sono indicativi: temperatura ambiente, altezza e posizione della lampada possono influenzare i valori.

STARLIGHT

CHANDELIERS

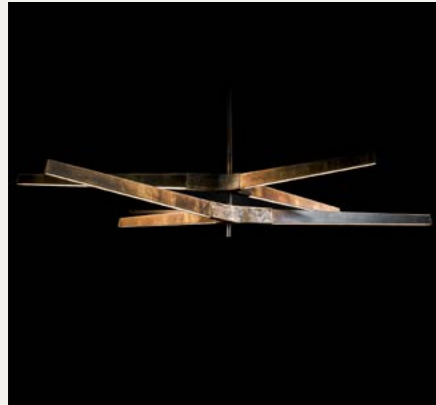

Emblematic pieces between art and design, sculptural ramifications of great purity and size that combine essentiality and refined treatment of materials, extraordinary encounters of bold geometries that trace extensive, eclectic suspended lightscapes.

Pezzi emblematici tra arte e design, ramificazioni scultoree di grande purezza e dimensione che uniscono essenzialità e raffinato trattamento dei materiali, straordinari incontri di ardite geometrie che tracciano ampi ed eclettici lightscapes sospesi.

DESIGNER
Massimo Castagna

DETAILS

- Pendant lights made with metal blades and a Y-shaped sand-cast core.
- Energy-saving LED light (Energy efficiency index A).
- Transformer incorporated in the ceiling rosette.
- Low voltage power supplied through suspension tube.
- Standard total height 100 cm.

LIGHT SOURCE

- LED 24V 3000K.
- Upon request available with extra warm light 2700K.
- Available 110V upon request.
- Dimming function included.

DETTAGLI

- Lampade a sospensione realizzate con lame metalliche e anima in fusione di sabbia a forma di Y.
- Sospensione a led a risparmio energetico (Indice di efficienza energetica A).
- Trasformatore incorporato nel rosone a soffitto.
- Alimentazione a bassa tensione fornita tramite il tubo di sospensione.
- Altezza totale standard 100 cm.

FONTE LUMINOSA

- Strip LED 24V 3000K.
- Su richiesta disponibile con luce extra calda a 2700K.
- Disponibile 110V su richiesta.
- Dimmerabile.

CONSTRUCTION SPECIFICATION

Weight: 16 kg-19,50 kg
Material: Y-shaped central body in sand cast metals
Arms in brass or silver
Finish: Sand Cast Brass, Sand Cast Bronze, Sand Cast Silver
Burnished Brass, Black Burnished Brass, H-Silver

Certified Product
Prodotto certificato

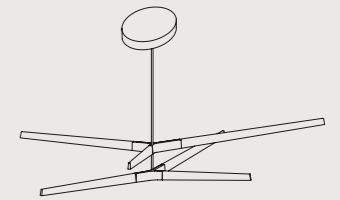

TECHNICAL DATA

Net Weight: 16 kg
Light source: Strip led 24 V
Input Voltage [V]: 220-240 V or 110-120 V upon request
Max Power [W]: 60.48 W
Light colour [K]: 3000 K or 2700 K upon request
Flux [lm]: 2700 K - 15588 lm / 3000 K - 16452 lm**
CRI: >90
Dimming: Push / Phase cut / 0-10 V / 1-10 V / DMX / DALI-2 dimmable

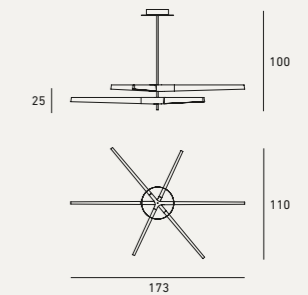

Starlight A

TECHNICAL DATA

Net Weight: 16 kg
Light source: Strip led 24 V
Input Voltage [V]: 220-240 V or 110-120 V upon request
Max Power [W]: 60.48 W
Light colour [K]: 3000 K or 2700 K upon request
Flux [lm]: 2700 K - 15588 lm / 3000 K - 16452 lm**
CRI: >90
Dimming: Push / Phase cut / 0-10 V / 1-10 V / DMX / DALI-2 dimmable

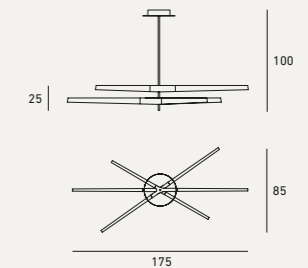

Starlight B

TECHNICAL DATA

Net Weight: 19 kg
Light source: Strip led 24 V
Input Voltage [V]: 220-240 V or 110-120 V upon request
Max Power [W]: 102.48 W
Light colour [K]: 3000 K or 2700 K upon request
Flux [lm]: 2700 K - 26413 lm / 3000 K - 27877 lm**
CRI: >90
Dimming: Push / Phase cut / 0-10 V / 1-10 V / DMX / DALI-2 dimmable

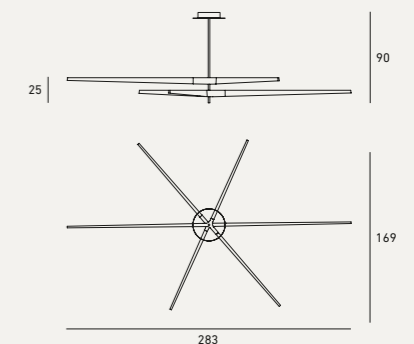

Starlight A MAXI



TECHNICAL DATA

Net Weight:	19 kg
Light source:	Strip led 24 V
Input Voltage [V]:	220-240 V or 110-120 V upon request
Max Power [W]:	90.72 W
Light colour [K]:	3000 K or 2700 K upon request
Flux [lm]:	2700 K - 23382 lm / 3000 K - 24678 lm**
CRI:	>90
Dimming:	Push / Phase cut / 0-10 V / 1-10 V / DMX / DALI-2 dimmable

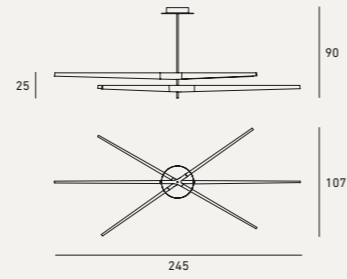

Starlight B MAXI

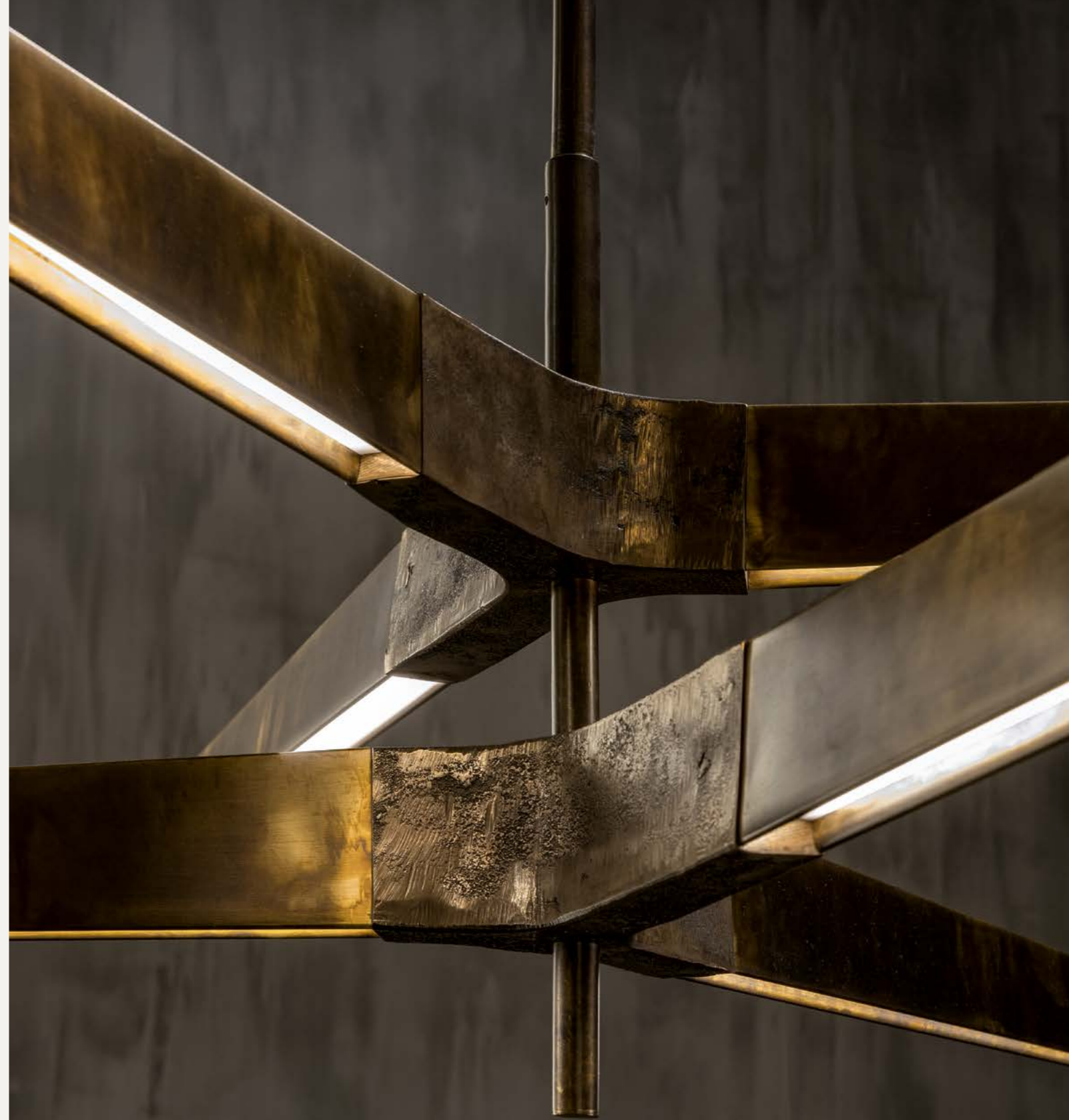

**Output of led inside the lamp. Losses due to diffusor and reflectors are not considered. Values are indicative, ambient temperature, height and position of the lamp may vary the values.
 **Emissione del LED all'interno della lampada. Le perdite dovute a diffusore e riflettori non sono considerate. I valori sono indicativi: temperatura ambiente, altezza e posizione della lampada possono influenzare i valori.



STARLIGHT HORIZONTAL

CHANDELIERS



Emblematic pieces between art and design, sculptural ramifications of great purity and size that combine essentiality and refined treatment of materials, extraordinary encounters of bold geometries that trace extensive, eclectic suspended lightscapes.

Pezzi emblematici tra arte e design, ramificazioni scultoree di grande purezza e dimensione che uniscono essenzialità e raffinato trattamento dei materiali, straordinari incontri di ardite geometrie che tracciano ampi ed eclettici lightscapes sospesi.

DESIGNER
Massimo Castagna

DETAILS

- Pendant lights made with metal blades and a Y-shaped sand-cast core.
- Energy-saving LED light (Energy efficiency index A).
- Transformer incorporated in the ceiling rosette.
- Alternative mounting system with a remote transformer.
- Low voltage power supplied through suspension cables.
- Standard total height 180 cm.

LIGHT SOURCE

- LED 24V 3000K.
- Upon request available with extra warm light 2700K.
- Available 110V upon request.
- Dimming function included.

DETTAGLI

- Lampade a sospensione realizzate con lame metalliche e anima in fusione di sabbia a forma di Y.
- Sospensione a led a risparmio energetico (Indice di efficienza energetica A).
- Trasformatore incorporato nel rosone a soffitto.
- Sistema di montaggio alternativo con trasformatore remoto.
- Alimentazione a bassa tensione fornita tramite cavi di sospensione.
- Altezza totale standard 180 cm.

FONTE LUMINOSA

- Strip LED 24V 3000K.
- Su richiesta disponibile con luce extra calda a 2700K.
- Disponibile 110V su richiesta.
- Dimmerabile.

CONSTRUCTION SPECIFICATION

Weight: 8 kg-22,80 kg
Material: Y-shaped central body in sand cast metals Arms in brass or silver
Overall height: 180 cm adjustable
Finish: Sand Cast Brass, Sand Cast Bronze, Sand Cast Silver Burnished Brass, Black Burnished Brass, H-Silver

Certified Product
Prodotto certificato

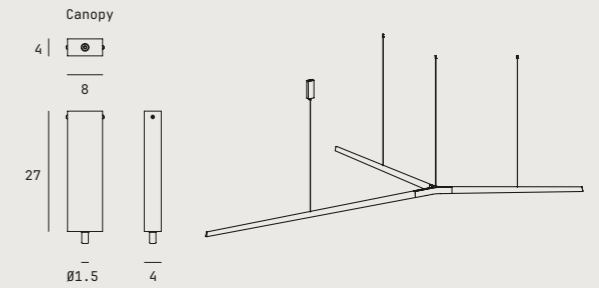

TECHNICAL DATA

Net Weight: 8 kg
Light source: strip LED 24 V
Input Voltage [V]: 220-240 V or 110-120 V upon request
Max Power [W]: 30.24 W
Light colour [K]: 3000 K or 2700 K upon request
Flux [lm]: 2700 K - 7794 lm / 3000 K - 8226 lm**
CRI: >90
Dimming: Push / Phase cut / 0-10 V / 1-10 V / DMX / DALI-2 dimmable

Starlight Horizontal
A

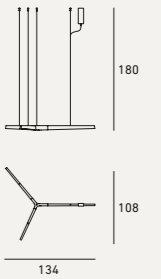

TECHNICAL DATA

Net Weight: 8 kg
Light source: strip LED 24 V
Input Voltage [V]: 220-240 V or 110-120 V upon request
Max Power [W]: 30.24 W
Light colour [K]: 3000 K or 2700 K upon request
Flux [lm]: 2700 K - 7794 lm / 3000 K - 8226 lm**
CRI: >90
Dimming: Push / Phase cut / 0-10 V / 1-10 V / DMX / DALI-2 dimmable

Starlight Horizontal
B

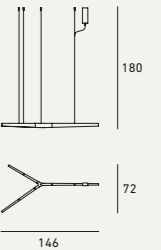

TECHNICAL DATA

Net Weight: 8 kg
Light source: strip LED 24 V
Input Voltage [V]: 220-240 V or 110-120 V upon request
Max Power [W]: 30.24 W
Light colour [K]: 3000 K or 2700 K upon request
Flux [lm]: 2700 K - 7794 lm / 3000 K - 8226 lm**
CRI: >90
Dimming: Push / Phase cut / 0-10 V / 1-10 V / DMX / DALI-2 dimmable

Starlight Horizontal
C

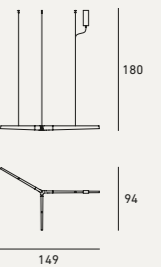

TECHNICAL DATA

Net Weight: 10.5 kg
Light source: strip LED 24 V
Input Voltage [V]: 220-240 V or 110-120 V upon request
Max Power [W]: 53.76 W
Light colour [K]: 3000 K or 2700 K upon request
Flux [lm]: 2700 K - 13856 lm / 3000 K - 14624 lm**
CRI: >90
Dimming: Push / Phase cut / 0-10 V / 1-10 V / DMX / DALI-2 dimmable

Starlight Horizontal
A MAXI

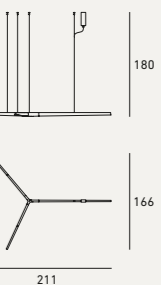

TECHNICAL DATA

Net Weight: 9.6 kg
 Light source: strip LED 24 V
 Input Voltage [V]: 220-240 V or 110-120 V upon request
 Max Power [W]: 47.04 W
 Light colour [K]: 3000 K or 2700 K upon request
 Flux [lm]: 2700 K - 12124 lm / 3000 K - 12796 lm**
 CRI: >90
 Dimming: Push / Phase cut / 0-10 V / 1-10 V / DMX / DALI-2 dimmable

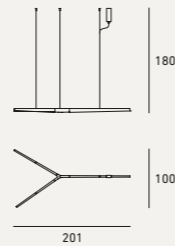
Starlight Horizontal
B MAXI

TECHNICAL DATA

Net Weight: 18 kg
 Light source: strip LED 24 V
 Input Voltage [V]: 220-240 V or 110-120 V upon request
 Max Power [W]: 58.8 W
 Light colour [K]: 3000 K or 2700 K upon request
 Flux [lm]: 2700 K - 15155 lm / 3000 K - 15995 lm**
 CRI: >90
 Dimming: Push / Phase cut / 0-10 V / 1-10 V / DMX / DALI-2 dimmable

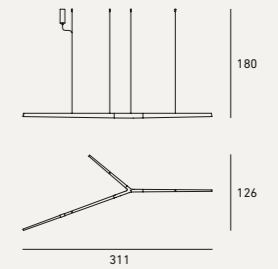
Starlight Horizontal
XL C

TECHNICAL DATA

Net Weight: 10.1 kg
 Light source: strip LED 24 V
 Input Voltage [V]: 220-240 V or 110-120 V upon request
 Max Power [W]: 50.4 W
 Light colour [K]: 3000 K or 2700 K upon request
 Flux [lm]: 2700 K - 12990 lm / 3000 K - 13710 lm**
 CRI: >90
 Dimming: Push / Phase cut / 0-10 V / 1-10 V / DMX / DALI-2 dimmable

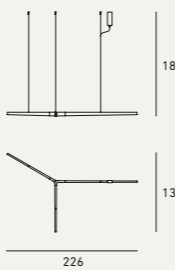
Starlight Horizontal
C MAXI

TECHNICAL DATA

Net Weight: 23 kg
 Light source: strip LED 24 V
 Input Voltage [V]: 220-240 V or 110-120 V upon request
 Max Power [W]: 94.08 W
 Light colour [K]: 3000 K or 2700 K upon request
 Flux [lm]: 2700 K - 24248 lm / 3000 K - 25592 lm**
 CRI: >90
 Dimming: Push / Phase cut / 0-10 V / 1-10 V / DMX / DALI-2 dimmable

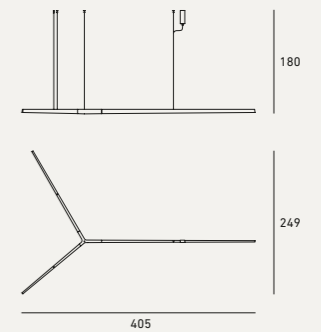
Starlight Horizontal
XL A MAXI

TECHNICAL DATA

Net Weight: 18 kg
 Light source: strip LED 24 V
 Input Voltage [V]: 220-240 V or 110-120 V upon request
 Max Power [W]: 58.8 W
 Light colour [K]: 3000 K or 2700 K upon request
 Flux [lm]: 2700 K - 15155 lm / 3000 K - 15995 lm**
 CRI: >90
 Dimming: Push / Phase cut / 0-10 V / 1-10 V / DMX / DALI-2 dimmable

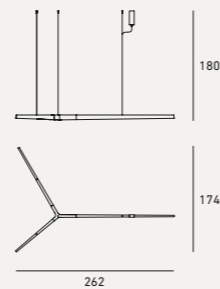
Starlight Horizontal
XL A

TECHNICAL DATA

Net Weight: 24.7 kg
 Light source: strip LED 24 V
 Input Voltage [V]: 220-240 V or 110-120 V upon request
 Max Power [W]: 107.52 W
 Light colour [K]: 3000 K or 2700 K upon request
 Flux [lm]: 2700 K - 27712 lm / 3000 K - 29248 lm**
 CRI: >90
 Dimming: Push / Phase cut / 0-10 V / 1-10 V / DMX / DALI-2 dimmable

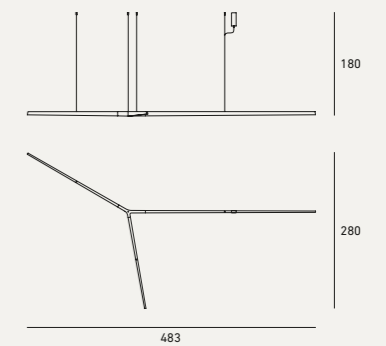
Starlight Horizontal
XL B MAXI

TECHNICAL DATA

Net Weight: 18 kg
 Light source: strip LED 24 V
 Input Voltage [V]: 220-240 V or 110-120 V upon request
 Max Power [W]: 58.8 W
 Light colour [K]: 3000 K or 2700 K upon request
 Flux [lm]: 2700 K - 15155 lm / 3000 K - 15995 lm**
 CRI: >90
 Dimming: Push / Phase cut / 0-10 V / 1-10 V / DMX / DALI-2 dimmable

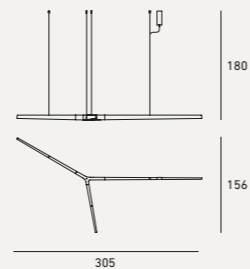
Starlight Horizontal
XL B

TECHNICAL DATA

Net Weight: 22.2 kg
 Light source: strip LED 24 V
 Input Voltage [V]: 220-240 V or 110-120 V upon request
 Max Power [W]: 101.64 W
 Light colour [K]: 3000 K or 2700 K upon request
 Flux [lm]: 2700 K - 26196.5 lm / 3000 K - 27648.5 lm**
 CRI: >90
 Dimming: Push / Phase cut / 0-10 V / 1-10 V / DMX / DALI-2 dimmable

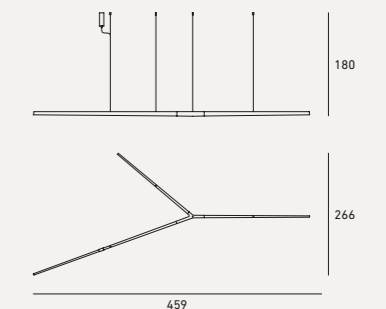
Starlight Horizontal
XL C MAXI



SUPERB-ALL

CHANDELIERS



Iconic and eccentric fiberglass spheres of varying sizes, suspended with daring narcissism from long, tapered burnished brass and metal stems, in an intersection between geometry and gravity, whimsically weave virtuous narratives, extravagantly emphasizing a metaphorical interplay.

Iconiche ed eccentriche sfere in vetroresina di varie dimensioni, sospese con audace narcisismo a lunghi e affusolati steli in ottone brunito e metallo, in un incrocio tra geometria e gravità, intrecciano capricciosamente narrazioni virtuose, enfatizzando stravagantemente un gioco metaforico.

DESIGNER
Massimo Castagna

DETAILS

- Spherical pendant lights made with grey fiberglass are available in different sizes.
- Energy-saving LED light (Energy efficiency index A).
- Transformer incorporated in the ceiling rosette.
- Low voltage power supplied through suspension tube.
- Standard total height 200 cm.

LIGHT SOURCE

- LED 24V 3000K.
- Upon request available with extra warm light 2700K.
- Available 110V upon request.
- Dimming function included.

DETTAGLI

- Lampade a sospensione sferiche realizzate con fibra di vetro grigia disponibile in diverse dimensioni.
- Sospensione a led a risparmio energetico (Indice di efficienza energetica A).
- Trasformatore incorporato nel rosone a soffitto.
- Alimentazione a bassa tensione fornita tramite il tubo di sospensione.
- Altezza totale standard 200 cm.

FONTE LUMINOSA

- Strip LED 24V 3000K.
- Su richiesta disponibile con luce extra calda a 2700K.
- Disponibile 110V su richiesta.
- Dimmerabile.

CONSTRUCTION SPECIFICATION

Weight: 3 kg-8 kg
Material: Lamp metal frame in brass or steel
 Diffuser in grey fiberglass
Overall height: 200 cm adjustable
Finish: Burnished Brass, Black Burnished Brass, Black Burnished Steel, Burnished Titanio, Burnished Platino

Certified Product
 Prodotto certificato

CE ENEC IP20

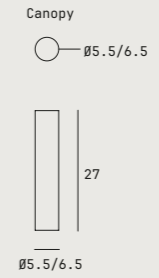

TECHNICAL DATA

Net Weight: 3 kg
Light source: Strip led 24V
Input Voltage [V]: 220-240 V or 110-120 upon request
Max Power [W]: 7 W
Light colour [K]: 3000 K or 2700 K upon request
Flux [lm]: 1050 lm**
CRI: >90
Dimming: Push/Phase cut/0-10 V/1-10 V/DMX/DALI-2 dimmable
Minimum Height: Not less than 70cm

Superb-ALL
 Ø20

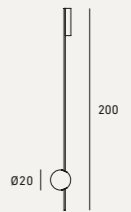

TECHNICAL DATA

Net Weight: 3,50 kg
Light source: Strip led 24V
Input Voltage [V]: 220-240 V or 110-120 upon request
Max Power [W]: 11 W
Light colour [K]: 3000 K or 2700 K upon request
Flux [lm]: 1680 lm**
CRI: >90
Dimming: Push/Phase cut/0-10 V/1-10 V/DMX/DALI-2 dimmable
Minimum Height: Not less than 80cm

Superb-ALL
 Ø30

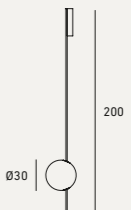

TECHNICAL DATA

Net Weight: 4,50 kg
Light source: Strip led 24V
Input Voltage [V]: 220-240 V or 110-120 upon request
Max Power [W]: 16 W
Light colour [K]: 3000 K or 2700 K upon request
Flux [lm]: 2394 lm**
CRI: >90
Dimming: Push/Phase cut/0-10 V/1-10 V/DMX/DALI-2 dimmable
Minimum Height: Not less than 90cm

Superb-ALL
 Ø40

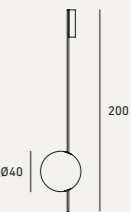

TECHNICAL DATA

Net Weight:	6 kg
Light source:	Strip led 24V
Input Voltage [V]:	220-240 V or 110-120 upon request
Max Power [W]:	27 W
Light colour [K]:	3000 K or 2700 K upon request
Flux [lm]:	4074 lm**
CRI:	>90
Dimming:	Push/Phase cut/0-10 V/1-10 V/DMX/DALI-2 dimmable
Minimum Height:	Not less than 110cm

Superb-all
Ø60

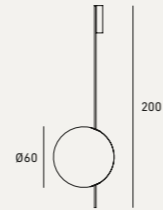

TECHNICAL DATA

Net Weight:	8 kg
Light source:	Strip led 24V
Input Voltage [V]:	220-240 V or 110-120 upon request
Max Power [W]:	36 W
Light colour [K]:	3000 K or 2700 K upon request
Flux [lm]:	5460 lm**
CRI:	>90
Dimming:	Push/Phase cut/0-10 V/1-10 V/DMX/DALI-2 dimmable
Minimum Height:	Not less than 130cm

Superb-all
Ø80

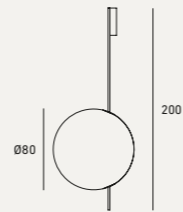

**Output of led inside the lamp. Losses due to diffusor and reflectors are not considered. Values are indicative, ambient temperature, height and position of the lamp may vary the values.
**Emissione del LED all'interno della lampada. Le perdite dovute a diffusore e riflettori non sono considerate. I valori sono indicativi: temperatura ambiente, altezza e posizione della lampada possono influenzare i valori.



SUPERB-ALL HORIZONTAL

CHANDELIERS



Iconic and eccentric fiberglass spheres of varying sizes, suspended with daring narcissism from long, tapered burnished brass and metal stems, in an intersection between geometry and gravity, whimsically weave virtuous narratives, extravagantly emphasizing a metaphorical interplay.

Iconiche ed eccentriche sfere in vetroresina di varie dimensioni, sospese con audace narcisismo a lunghi e affusolati steli in ottone brunito e metallo, in un incrocio tra geometria e gravità, intrecciano capricciosamente narrazioni virtuose, enfatizzando stravagantemente un gioco metaforico.

DESIGNER
Massimo Castagna

DETAILS

- Spherical pendant lights made with grey fiberglass are available in different sizes.
- Spheres are placed in line in the horizontal suspension tube.
- Energy-saving LED light (Energy efficiency index A).
- Transformer incorporated in the ceiling rosette.
- Alternative mounting system with a remote transformer.
- Low voltage power supplied through suspension cables.
- Power supply cable coated with metal cord.
- Standard total height 180 cm.

LIGHT SOURCE

- LED 24V 3000K.
- Upon request available with extra warm light 2700K.
- Available 110V upon request.
- Dimming function included.

DETTAGLI

- Lampade a sospensione sferiche realizzate con fibra di vetro grigia disponibile in diverse dimensioni.
- Le sfere sono posizionate in linea nel tubo di sospensione orizzontale.
- Sospensione a led a risparmio energetico (Indice di efficienza energetica A).
- Trasformatore incorporato nel rosone a soffitto.
- Sistema di montaggio alternativo con trasformatore remoto.
- Alimentazione a bassa tensione fornita tramite cavi di sospensione.
- Cavo elettrico rivestito in metallo.
- Altezza totale standard 180 cm.

FONTE LUMINOSA

- Strip LED 24V 3000K.
- Su richiesta disponibile con luce extra calda a 2700K.
- Disponibile 110V su richiesta.
- Dimmerabile.

CONSTRUCTION SPECIFICATION

Weight: 2,50 kg-7,50 kg
Material: Lamp metal frame in brass or steel
Diffuser in grey fiberglass
Overall height: 180 cm adjustable-not less than 100 cm
Finish: Burnished Brass, Black Burnished Brass, Black Burnished Steel, Burnished Titano, Burnished Platino

Certified Product
Prodotto certificato

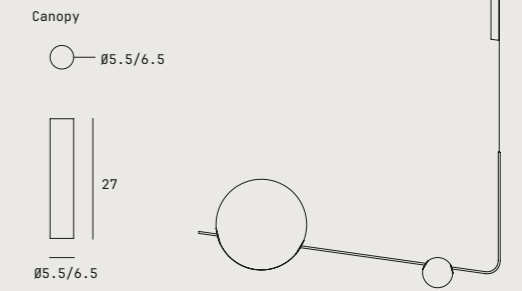

TECHNICAL DATA

Net Weight: 2.4 kg
Light source: Strip LED 24 V
Input Voltage [V]: 220-240 V or 110-120 V upon request
Max Power [W]: 7 W
Light colour [K]: 3000 K or 2700 K upon request
Flux [lm]: 1050 lm**
CRI: >90
Dimming: Push/Phase cut/0-10 V/1-10 V/ DMX/DALI-2 dimmable

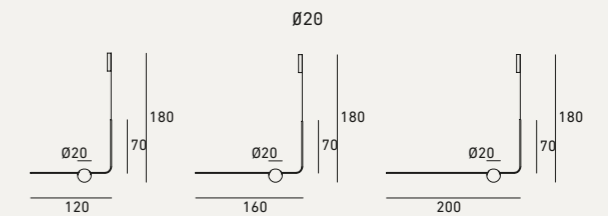

TECHNICAL DATA

Net Weight: 3.2 kg
Light source: Strip LED 24 V
Input Voltage [V]: 220-240 V or 110-120 V upon request
Max Power [W]: 16 W
Light colour [K]: 3000 K or 2700 K upon request
Flux [lm]: 2394 lm**
CRI: >90
Dimming: Push/Phase cut/0-10 V/1-10 V/ DMX/DALI-2 dimmable

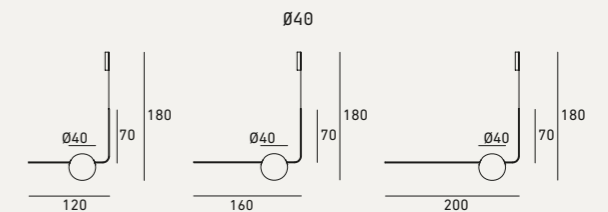

TECHNICAL DATA

Net Weight: 5 kg
Light source: Strip LED 24 V
Input Voltage [V]: 220-240 V or 110-120 V upon request
Max Power [W]: 27 W
Light colour [K]: 3000 K or 2700 K upon request
Flux [lm]: 4074 lm**
CRI: >90
Dimming: Push/Phase cut/0-10 V/1-10 V/ DMX/DALI-2 dimmable

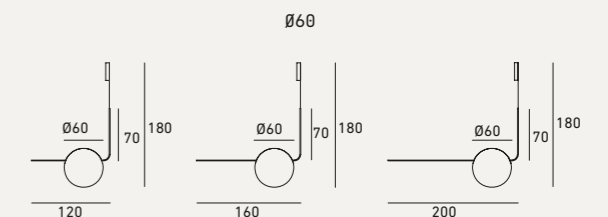

TECHNICAL DATA

Net Weight: 4.6 kg
 Light source: Strip LED 24 V
 Input Voltage [V]: 220-240 V or 110-120 V upon request
 Max Power [W]: request
 Light colour [K]: 23 W
 Flux [lm]: 3000 K or 2700 K upon request
 CRI: 3444 lm**
 Dimming: >90
 Push/Phase cut/0-10 V/1-10 V/
 DMX/DALI-2 dimmable

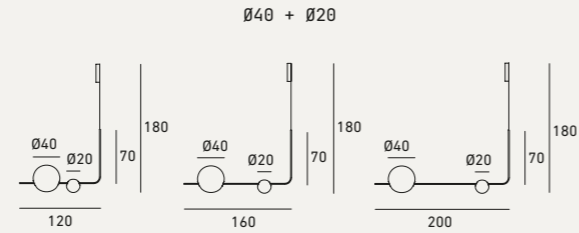

TECHNICAL DATA

Net Weight: 4.9 kg
 Light source: Strip LED 24 V
 Input Voltage [V]: 220-240 V or 110-120 V upon request
 Max Power [W]: request
 Light colour [K]: 27 W
 Flux [lm]: 3000 K or 2700 K upon request
 CRI: 4074 lm**
 Dimming: >90
 Push/Phase cut/0-10 V/1-10 V/
 DMX /
 DALI-2 dimmable

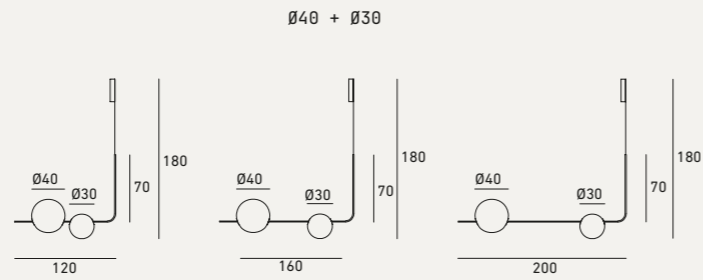

TECHNICAL DATA

Net Weight: 6.3 kg
 Light source: Strip LED 24 V
 Input Voltage [V]: 220-240 V or 110-120 V upon request
 Max Power [W]: request
 Light colour [K]: 34 W
 Flux [lm]: 3000 K or 2700 K upon request
 CRI: 5124 lm**
 Dimming: >90
 Push/Phase cut/0-10 V/
 1-10 V/DMX/DALI-2 dimmable

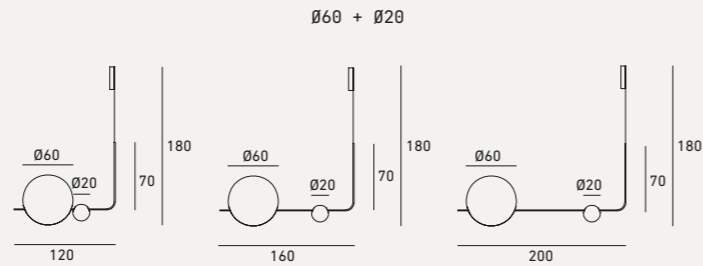

TECHNICAL DATA

Net Weight: 6.7 kg
 Light source: Strip LED 24 V
 Input Voltage [V]: 220-240 V or 110-120 V upon request
 Max Power [W]: request
 Light colour [K]: 38 W
 Flux [lm]: 3000 K or 2700 K upon request
 CRI: 5754 lm**
 Dimming: >90
 Push/Phase cut/0-10 V/
 1-10 V/DMX/DALI-2 dimmable

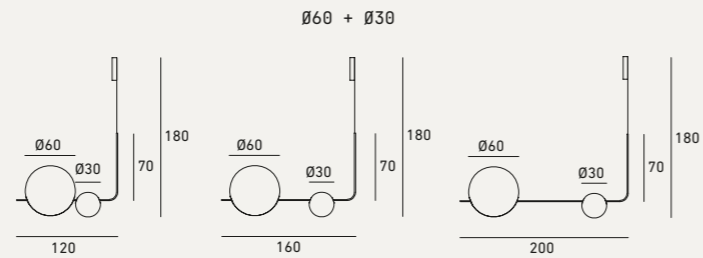

**Output of led inside the lamp. Losses due to diffusor and reflectors are not considered. Values are indicative, ambient temperature, height and position of the lamp may vary the values.
 **Emissione del LED all'interno della lampada. Le perdite dovute a diffusore e riflettori non sono considerate. I valori sono indicativi: temperatura ambiente, altezza e posizione della lampada possono influenzare i valori.



SUPERB-ALL HORIZONTAL EVO

CHANDELIERS



Iconic and eccentric fiberglass spheres of varying sizes, suspended with daring narcissism from long, tapered burnished brass and metal stems, in an intersection between geometry and gravity, whimsically weave virtuous narratives, extravagantly emphasizing a metaphorical interplay.

Iconiche ed eccentriche sfere in vetroresina di varie dimensioni, sospese con audace narcisismo a lunghi e affusolati steli in ottone brunito e metallo, in un incrocio tra geometria e gravità, intrecciano capricciosamente narrazioni virtuose, enfatizzando stravagantemente un gioco metaforico.

DESIGNER
Massimo Castagna

DETAILS

- Spherical pendant lights made with grey fiberglass are available in different sizes.
- Spheres are placed on the horizontal and on the vertical tubes (1 on each tube).
- Energy-saving LED light (Energy efficiency index A).
- Transformer incorporated in the ceiling rosette.
- Alternative mounting system with a remote transformer.
- Low voltage power supplied through suspension cables.
- Power supply cable coated with metal cord.
- Standard total height 180 cm.

LIGHT SOURCE

- LED 24V 3000K.
- Upon request available with extra warm light 2700K.
- Available 110V upon request.
- Dimming function included.

DETTAGLI

- Lampade a sospensione sferiche realizzate con fibra di vetro grigia disponibile in diverse dimensioni.
- Le sfere sono posizionate sui tubi orizzontali e verticali (1 su ciascun tubo).
- Sospensione a led a risparmio energetico (Indice di efficienza energetica A).
- Trasformatore incorporato nel rosone a soffitto.
- Sistema di montaggio alternativo con trasformatore remoto.
- Alimentazione a bassa tensione fornita tramite cavi di sospensione.
- Cavo elettrico rivestito in metallo.
- Altezza totale standard 180 cm.

FONTE LUMINOSA

- Strip LED 24V 3000K.
- Su richiesta disponibile con luce extra calda a 2700K.
- Disponibile 110V su richiesta.
- Dimmerabile.

CONSTRUCTION SPECIFICATION

Weight: 4.6-8 kg
Material: Lamp metal frame in brass or steel
Diffuser in grey fiberglass
Overall height: 180 cm adjustable-not less than 150 cm
Finish: Burnished Brass, Black Burnished Brass, Black Burnished Steel, Burnished Titanium, Burnished Platino

Certified Product
Prodotto certificato

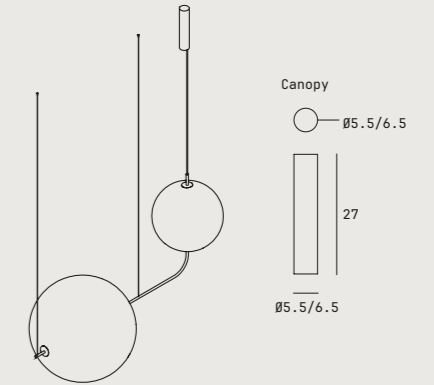

TECHNICAL DATA

Net Weight: 4.6 kg
Light source: Strip LED 24 V
Input Voltage [V]: 220-240 V or 110-120 V upon request
Max Power [W]: 23 W
Light colour [K]: 3000K or 2700 K upon request
Flux [lm]: 3444 lm
CRI: >90
Dimming: Push/Phase cut/0-10 V/1-10 V / DMX/DALI-2 dimmable

Ø40 + Ø20-Up

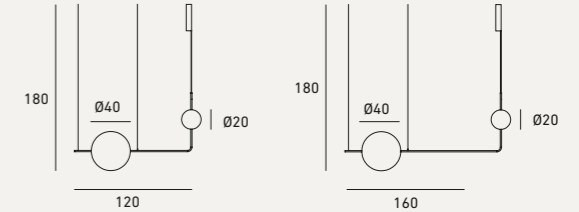

TECHNICAL DATA

Net Weight: 4.6 kg
Light source: Strip LED 24 V
Input Voltage [V]: 220-240 V or 110-120 V upon request
Max Power [W]: 23 W
Light colour [K]: 3000 K or 2700 K upon request
Flux [lm]: 3444 lm
CRI: >90
Dimming: Push/Phase cut/0-10 V/1-10 V / DMX/DALI-2 dimmable

Ø40 + Ø20-Down

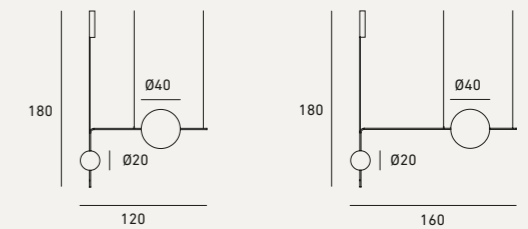

TECHNICAL DATA

Net Weight: 7.2 kg
Light source: Strip LED 24 V
Input Voltage [V]: 220-240 V or 110-120 V upon request
Max Power [W]: 43 W
Light colour [K]: 3000 K or 2700 K upon request
Flux [lm]: 6468 lm**
CRI: >90
Dimming: Push/Phase cut/0-10 V/1-10 V / DMX/DALI-2 dimmable

Ø60 + Ø40-Up

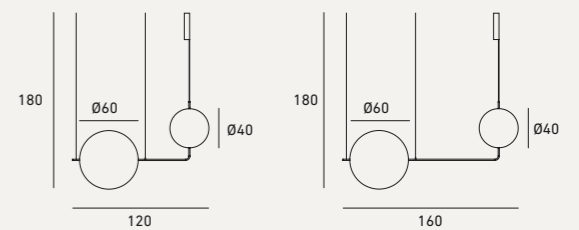

TECHNICAL DATA

Net Weight:	7.2 kg
Light source:	Strip LED 24 V
Input Voltage [V]:	220-240 V or 110-120 V upon request
Max Power [W]:	43 W
Light colour [K]:	3000 K or 2700 K upon request
Flux [lm]:	6468 lm**
CRI:	>90
Dimming:	Push/Phase cut/0-10 V/1-10 V/DMX/ DALI-2 dimmable

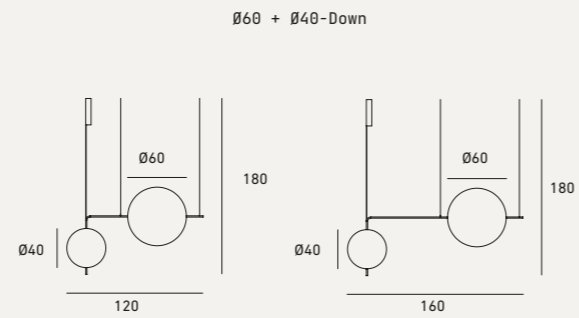

TECHNICAL DATA

Net Weight:	8 kg
Light source:	Strip LED 24 V
Input Voltage [V]:	220-240 V or 110-120 V upon request
Max Power [W]:	47 W
Light colour [K]:	3000 K or 2700 K upon request
Flux [lm]:	7140 lm**
CRI:	>90
Dimming:	Push/Phase cut/0-10 V/1-10 V/DMX / DALI-2 dimmable

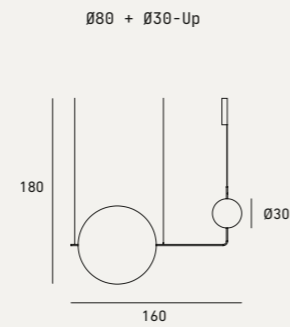

TECHNICAL DATA

Net Weight:	8 kg
Light source:	Strip LED 24 V
Input Voltage [V]:	220-240 V or 110-120 V upon request
Max Power [W]:	47 W
Light colour [K]:	3000 K or 2700 K upon request
Flux [lm]:	7140 lm**
CRI:	>90
Dimming:	Push/Phase cut/0-10 V/1-10 V/DMX / DALI-2 dimmable

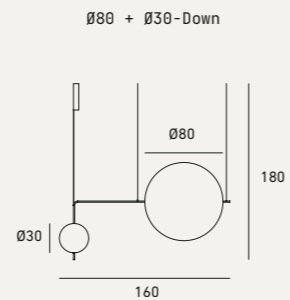

TAPE

CHANDELIERS

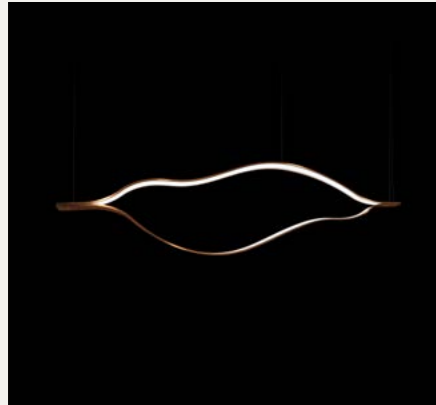

Delicate, sinuous organic forms generate with exuberant, explosive dynamism multiple sequences of harmonious, fluid complexity. Luminous ribbons lightly meander, rhythmically enhancing floating seductive, ethereal textures

Forme organiche delicate e sinuose generano con dinamismo esuberante ed esplosivo molteplici sequenze di complessità armonica e fluida. Nastri luminosi serpeggiano leggermente, esaltando ritmicamente trame fluttuanti, seducenti ed eteree.

DESIGNER
Massimo Castagna

DETAILS

- Pendant lights made with hand-carved metal bars of various sizes and configurations.
- Energy-saving LED light (Energy efficiency index A).
- Transformer incorporated in the ceiling rosette.
- Alternative mounting system with a remote transformer.
- Low voltage power supplied through suspension cables.
- Standard total height 180 cm.

LIGHT SOURCE

- LED 24V 3000K.
- Upon request available with extra warm light 2700K.
- Available 110V upon request.
- Dimming function included.

DETTAGLI

- Lampade a sospensione realizzate con barre metalliche curvate a mano di varie dimensioni e configurazioni.
- Sospensione a led a risparmio energetico (Indice di efficienza energetica A).
- Trasformatore incorporato nel rosone a soffitto.
- Sistema di montaggio alternativo con trasformatore remoto.
- Alimentazione a bassa tensione fornita tramite cavi di sospensione.
- Altezza totale standard 180 cm.

FONTE LUMINOSA

- Strip LED 24V 3000K.
- Su richiesta disponibile con luce extra calda a 2700K.
- Disponibile 110V su richiesta.
- Dimmerabile.

CONSTRUCTION SPECIFICATION

Weight: 3,90 kg-8,50 kg
Material: Brass profile with polycarbonate diffuser
Overall height: 180 cm adjustable
Finish: Burnished Brass, Black Burnished Brass, Burnished Titanio, Burnished Platino, H-Silver, H-Silver Black

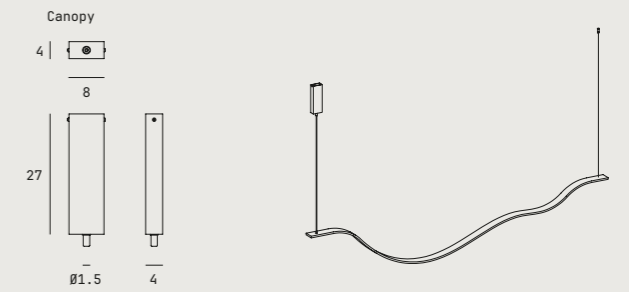

Certified Product
Prodotto certificato



TECHNICAL DATA

Net Weight: 3.9 kg
Light source: Strip led 24 V
Input Voltage [V]: 220-240 V or 110-120 V upon request
Max Power [W]: 14 W
Light colour [K]: 3000 K or 2700 K upon request
Flux [lm]: 2700 K-1728 lm/3000 K-1984 lm**
CRI: >80
Dimming: Push/Phase cut/0-10 V/1-10 V / DMX/DALI-2 dimmable

Single A

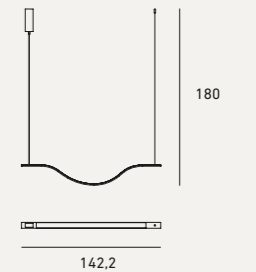

TECHNICAL DATA

Net Weight: 4.3 kg
Light source: Strip led 24 V
Input Voltage [V]: 220-240 V or 110-120 V upon request
Max Power [W]: 14 W
Light colour [K]: 3000 K or 2700 K upon request
Flux [lm]: 2700 K-1728 lm/3000 K-1488 lm**
CRI: >80
Dimming: Push/Phase cut/0-10 V/1-10 V / DMX/DALI-2 dimmable

Single B

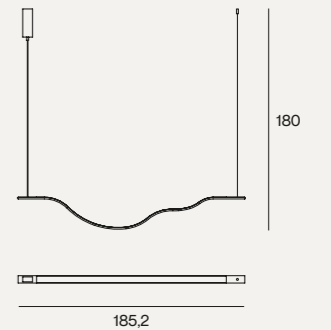

TECHNICAL DATA

Net Weight: 5.2 kg
Light source: Strip led 24 V
Input Voltage [V]: 220-240 V or 110-120 V upon request
Max Power [W]: 17 W
Light colour [K]: 3000 K or 2700 K upon request
Flux [lm]: 2700 K-2052 lm/3000 K-2356 lm**
CRI: >80
Dimming: Push/Phase cut/0-10 V/1-10 V / DMX/DALI-2 dimmable

Single C

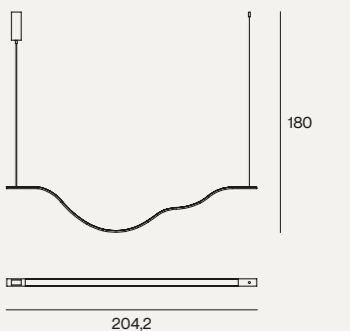

TECHNICAL DATA

Net Weight: 6.3 kg
 Light source: Strip led 24 V
 Input Voltage [V]: 220-240 V or 110-120 V upon request
 Max Power [W]: 21 W
 Light colour [K]: 3000 K or 2700 K upon request
 Flux [lm]: 2700 K-2592 lm/3000 K-2976 lm**
 CRI: >80
 Dimming: Push/Phase cut/0-10 V/1-10 V/DMX/DALI-2 dimmable

Pair A

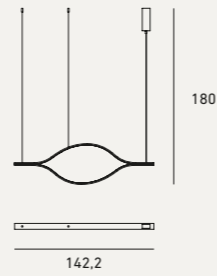

TECHNICAL DATA

Net Weight: 8.3 kg
 Light source: Strip led 24 V
 Input Voltage [V]: 220-240 V or 110-120 V upon request
 Max Power [W]: 28 W
 Light colour [K]: 3000 K or 2700 K upon request
 Flux [lm]: 2700 K-3456 lm/3000 K-3968 lm**
 CRI: >80
 Dimming: Push/Phase cut/0-10 V/1-10 V/DMX/DALI-2 dimmable

Pair B

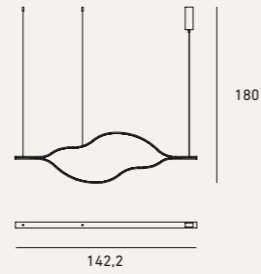

TECHNICAL DATA

Net Weight: 8.5 kg
 Light source: Strip led 24 V
 Input Voltage [V]: 220-240 V or 110-120 V upon request
 Max Power [W]: 34 W
 Light colour [K]: 3000 K or 2700 K upon request
 Flux [lm]: 2700 K-4104 lm/3000 K-4712 lm**
 CRI: >80
 Dimming: Push/Phase cut/0-10 V/1-10 V/DMX/DALI-2 dimmable

Pair C

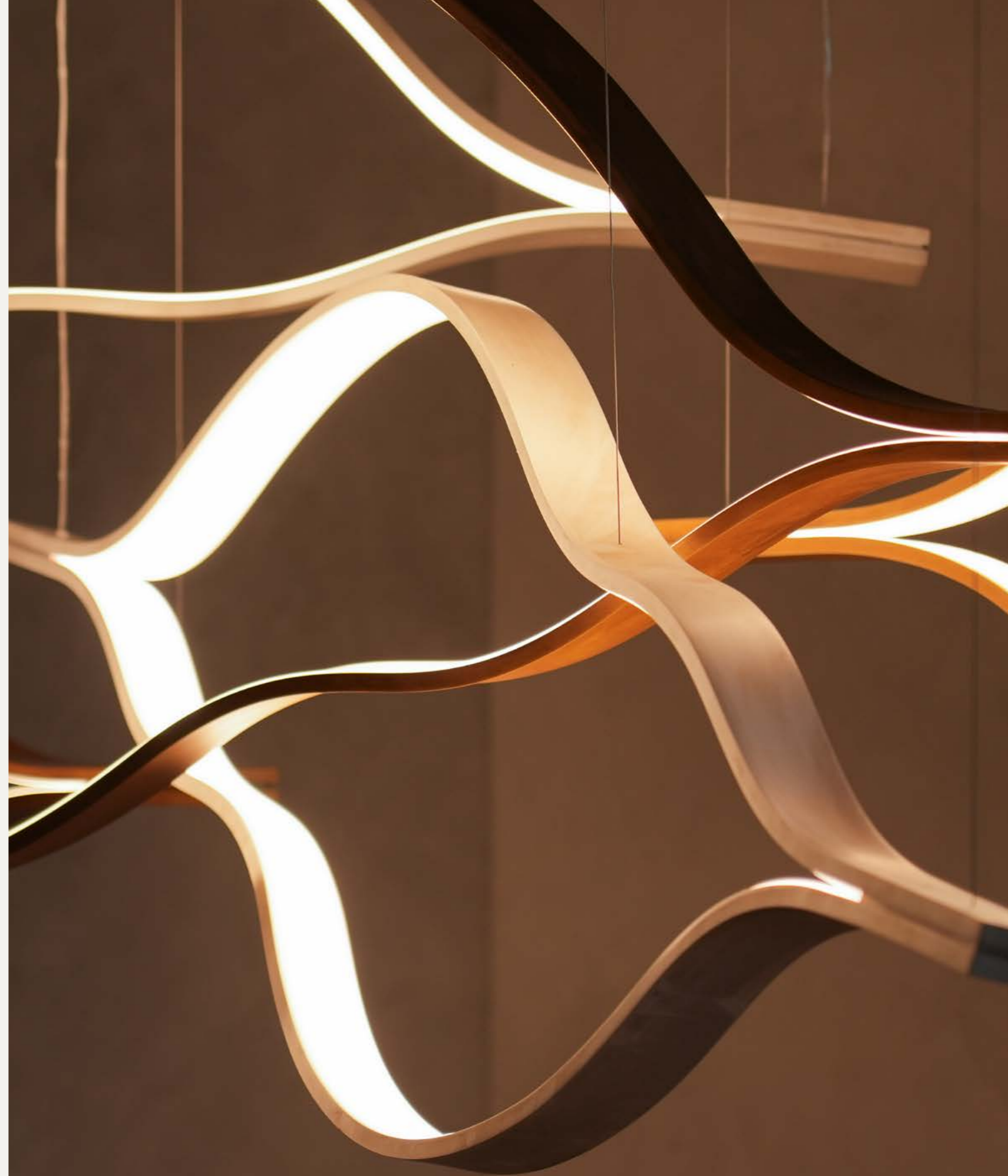
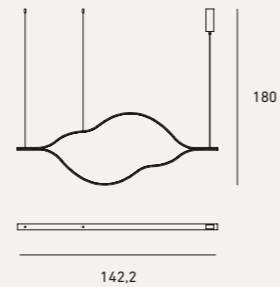





Compact cylindrical bodies, and pure geometries, resonate with accents of strong personality. Minimalism and sophistication, enhanced by special, refined finishes, express Tele Light, an intriguing micro-sculpture, in single or grouped presence.

Corpi cilindrici compatti, e geometrie pure, risuonano di accenti di forte personalità. Minimalismo e raffinatezza, esaltati da particolari e raffinate finiture, esprimono Tele Light, un'intrigante micro-scultura, in presenza singola o in gruppo.

CONSTRUCTION SPECIFICATION

Weight: 2.1-2.5 kg
 Material: Brass cylinder
 Finish: Burnished Brass, Black Burnished Brass, Burnished Titano, Burnished Platino

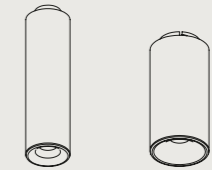

Certified Product
 Prodotto certificato



TECHNICAL DATA

Net Weight: 2.5 kg
 Light source: COB led 240 mA
 Input Voltage [V]: 220-240 V or 110-120 upon request
 Max Power [W]: 9 W
 Light colour [K]: 3000 K or 2700 K upon request
 Flux [lm]: 2700 K-1188 lm; 3000 K-1217 lm**
 CRI: >80/>90 upon request
 Dimming: Push/Phase cut/0-10 V/1-10 V/ DMX/DALI-2 dimmable



DESIGNER
 Massimo Castagna

TECHNICAL DATA

Net Weight: 2.1 kg
 Light source: COB led 240 mA
 Input Voltage [V]: 220-240 V or 110-120 upon request
 Max Power [W]: 9 W
 Light colour [K]: 3000 K or 2700 K upon request
 Flux [lm]: 2700 K-1188 lm; 3000 K-1217 lm**
 CRI: >80/>90 upon request
 Dimming: Push/Phase cut/0-10 V/1-10 V/ DMX/DALI-2 dimmable



DETAILS

- Ceiling led light made of Burnished Brass.
- Energy-saving LED light (energy efficiency index A).
- Transformer incorporated in the lamp.

LIGHT SOURCE

- COB LED 24V 3000K.
- Upon request available with extra warm light 2700K.
- Available 110V upon request.
- Dimming function included.

DETTAGLI

- Lampada a soffitto a led realizzata in Ottone Brunito.
- Led a risparmio energetico (Indice di efficienza energetica A).
- Trasformatore incorporato

FONTE LUMINOSA

- COB LED 24V 3000K.
- Su richiesta disponibile con luce extra calda a 2700K.
- Disponibile 110V su richiesta.
- Dimmerabile.



**Output of led inside the lamp. Losses due to diffusor and reflectors are not considered. Values are indicative, ambient temperature, height and position of the lamp may vary the values.
 **Emissione del LED all'interno della lampada. Le perdite dovute a diffusore e riflettori non sono considerate. I valori sono indicativi: temperatura ambiente, altezza e posizione della lampada possono influenzare i valori.



TUBULAR SOLO VERSION

CHANDELIERS



Slender cylindrical suspended bodies, anchored to branched brass structures, create geometrically calibrated and intriguing compositions.

Esili corpi cilindrici sospesi, ancorati a strutture ramificate in ottone, creano composizioni geometricamente calibrate e intriganti.

DESIGNER
Massimo Castagna

DETAILS

- Cylinders made of Burnished Brass, Burnished Platino, or Titanio.
- Energy-saving LED light (Energy efficiency index A).
- Power supply cable coated with red silk.
- Standard total height 180 cm.

LIGHT SOURCE

- GU10 10 LED bulb.
- Upon request available with extra warm light 2700K.
- Available 110V upon request, bulbs not included.
- Phase cut dimmable.

DETTAGLI

- Cilindri in Ottone Brunito, Platino Brunito o Titanio.
- Sospensione a led a risparmio energetico (Indice di efficienza energetica A).
- Cavo elettrico rivestito di seta rossa.
- Altezza totale standard 250 cm.

FONTE LUMINOSA

- Lampadine LED GU10 3000K.
- Su richiesta disponibile con luce extra calda a 2700K.
- Disponibile 110V su richiesta, lampadine non incluse.
- Dimmerabile taglio di fase.

CONSTRUCTION SPECIFICATION

Weight: 1,15 kg-2 kg
Material: Brass tube
Overall height: 180 cm adjustable
Finish: Burnished Brass, Black Burnished Brass, Burnished Titanio, Burnished Platino

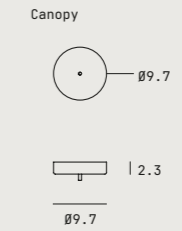

Certified Product
Prodotto certificato **CE**

TECHNICAL DATA

Net Weight: 1,15 kg
Light source: GU10 led bulb 24V
Input Voltage [V]: 220-240 V or 110-120 upon request
Max Power [W]: 5,90 W
Light colour [K]: 3000 K or 2700 K upon request
FLux [lm]: 350 lm**
CRI: >80
Dimming: Phase cut dimmable

Tubular Single
Ø5.5

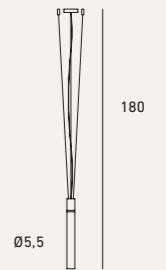

TECHNICAL DATA

Net Weight: 1,50 kg
Light source: GU10 led bulb 24V
Input Voltage [V]: 220-240 V or 110-120 upon request
Max Power [W]: 5,90 W
Light colour [K]: 3000 K or 2700 K upon request
FLux [lm]: 350 lm**
CRI: >80
Dimming: Phase cut dimmable

Tubular Single
Ø7

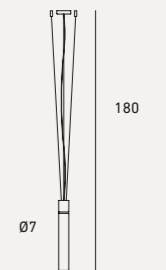

TECHNICAL DATA

Net Weight: 2 kg
Light source: GU10 led bulb 24V
Input Voltage [V]: 220-240 V or 110-120 upon request
Max Power [W]: 5,90 W
Light colour [K]: 3000 K or 2700 K upon request
FLux [lm]: 350 lm**
CRI: >80
Dimming: Phase cut dimmable

Tubular Single
Ø10

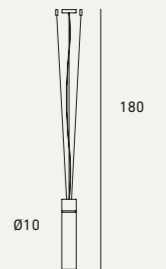

**Output of led inside the lamp. Losses due to diffusor and reflectors are not considered. Values are indicative, ambient temperature, height and position of the lamp may vary the values.
**Emissione del LED all'interno della lampada. Le perdite dovute a diffusore e riflettori non sono considerate. I valori sono indicativi: temperatura ambiente, altezza e posizione della lampada possono influenzare i valori.

TUBULAR

CHANDELIERS



Slender cylindrical suspended bodies, anchored to branched brass structures, create geometrically calibrated and intriguing compositions.

Esili corpi cilindrici sospesi, ancorati a strutture ramificate in ottone, creano composizioni geometricamente calibrate e intriganti.

DESIGNER
Massimo Castagna

DETAILS

- Cylinders made of Burnished Brass, Burnished Platino, or Titanio.
- Energy-saving LED light (Energy efficiency index A).
- Power supplied through suspension tube.
- Standard total height 130 cm.

LIGHT SOURCE

- GU10 10 LED bulb
- Upon request available with extra warm light 2700K.
- Available 110V upon request, bulbs not included.
- Phase cut dimmable.

DETTAGLI

- Cilindri in Ottone Brunito, Platino Brunito o Titanio.
- Sospensione a led a risparmio energetico (Indice di efficienza energetica A).
- Alimentazione fornita tramite il tubo di sospensione.
- Altezza totale standard 130 cm.

FONTE LUMINOSA

- Lampadine LED GU10 3000K.
- Su richiesta disponibile con luce extra calda a 2700K.
- Disponibile 110V su richiesta, lampadine non incluse.
- Dimmerabile taglio di fase.

CONSTRUCTION SPECIFICATION

Weight: 1,15 kg-2 kg
Material: Brass tube
Overall height: 180 cm adjustable
Finish: Burnished Brass, Black Burnished Brass, Burnished Titanio, Burnished Platino

Certified Product
Prodotto certificato

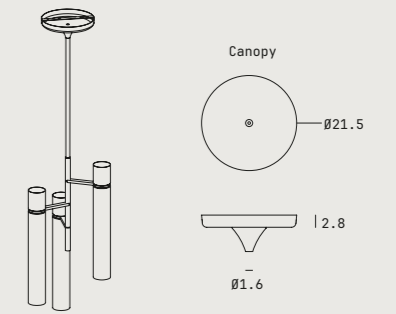

TECHNICAL DATA

Net Weight: 10 kg
Light source: GU10 led bulb 24V
Input Voltage [V]: 220-240 V or 110-120 upon request
Max Power [W]: 27,6 W
Light colour [K]: 3000 K or 2700 K upon request
Flux [lm]: 2100 lm**
CRI: >80
Dimming: Phase cut dimmable

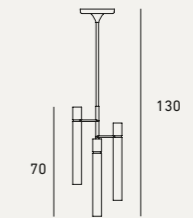

3 Identical Elements-Ø5,5

TECHNICAL DATA

Net Weight: 11 kg
Light source: GU10 led bulb 24V
Input Voltage [V]: 220-240 V or 110-120 upon request
Max Power [W]: 27,6 W
Light colour [K]: 3000 K or 2700 K upon request
Flux [lm]: 2100 lm**
CRI: >80
Dimming: Phase cut dimmable

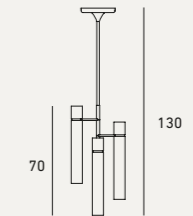

3 Identical Elements-Ø7

TECHNICAL DATA

Net Weight: 13 kg
Light source: GU10 led bulb 24V
Input Voltage [V]: 220-240 V or 110-120 upon request
Max Power [W]: 46 W
Light colour [K]: 3000 K or 2700 K upon request
Flux [lm]: 3500 lm**
CRI: >80
Dimming: Phase cut dimmable

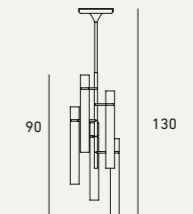

5 Identical Elements-Ø5,5



TECHNICAL DATA

Net Weight: 15 kg
 Light source: Strip led 24V
 Input Voltage [V]: 220-240 V or 110-120 upon request
 Max Power [W]: 46 W
 Light colour [K]: 3000 K or 2700 K upon request
 Flux [lm]: 3500 lm**
 CRI: >80
 Dimming: Phase cut dimmable

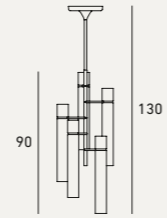

5 Identical Elements-Ø7

TECHNICAL DATA

Net Weight: 15 kg
 Light source: Strip led 24V
 Input Voltage [V]: 220-240 V or 110-120 upon request
 Max Power [W]: 46 W
 Light colour [K]: 3000 K or 2700 K upon request
 Flux [lm]: 3500 lm**
 CRI: >80
 Dimming: Phase cut dimmable

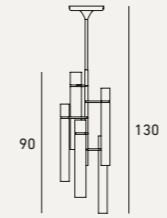
5 Different Elements:
3 Cylinders-Ø5,5
2 Cylinders-Ø7

TECHNICAL DATA

Net Weight: 15 kg
 Light source: Strip led 24V
 Input Voltage [V]: 220-240 V or 110-120 upon request
 Max Power [W]: 46 W
 Light colour [K]: 3000 K or 2700 K upon request
 Flux [lm]: 3500 lm**
 CRI: >80
 Dimming: Phase cut dimmable

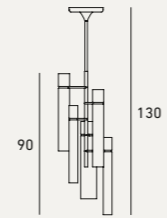
5 Different Elements:
2 Cylinders-Ø5,5
2 Cylinders-Ø7
1 Cylinder-Ø10

TECHNICAL DATA

Net Weight: 15 kg
 Light source: Strip led 24V
 Input Voltage [V]: 220-240 V or 110-120 upon request
 Max Power [W]: 46 W
 Light colour [K]: 3000 K or 2700 K upon request
 Flux [lm]: 3500 lm**
 CRI: >80
 Dimming: Phase cut dimmable

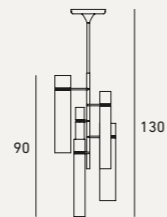
5 Different Elements:
1 Cylinder-Ø5,5
2 Cylinders-Ø7
2 Cylinders-Ø10

TUBULAR HORIZONTAL/MAXI

CHANDELIERS



Slender cylindrical suspended bodies, anchored to branched brass structures, create geometrically calibrated and intriguing compositions.

Esili corpi cilindrici sospesi, ancorati a strutture ramificate in ottone, creano composizioni geometricamente calibrate e intriganti.

DESIGNER
Massimo Castagna

DETAILS

- Cylinders made of Burnished Brass, Burnished Platino, or Titanio.
- Energy-saving LED light (Energy efficiency index A).
- Power supplied through suspension cables.
- Standard total height 180 cm.

LIGHT SOURCE

- GU10 10 LED bulb
- Upon request available with extra warm light 2700K.
- Available 110V upon request, bulbs not included.
- Phase cut dimmable.

DETTAGLI

- Cilindri in Ottone Brunito, Platino Brunito o Titanio.
- Sospensione a led a risparmio energetico (Indice di efficienza energetica A).
- Alimentazione fornita tramite cavi di sospensione.
- Altezza totale standard 180 cm.

FONTE LUMINOSA

- Lampadine LED GU10 3000K.
- Su richiesta disponibile con luce extra calda a 2700K.
- Disponibile 110V su richiesta, lampadine non incluse.
- Dimmerabile taglio di fase.

CONSTRUCTION SPECIFICATION

Weight: 2,50 kg-7 kg
Material: Brass tubes
Overall height: 180 cm adjustable
Finish: Burnished Brass, Black Burnished Brass, Burnished Titanio, Burnished Platino

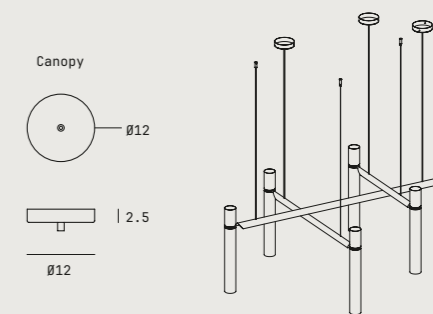

Certified Product
Prodotto certificato



TECHNICAL DATA

Net Weight: 2,50 kg-3,50 kg
Light source: GU10 led bulb 24V
Input Voltage [V]: 220-240 V or 110-120 upon request
Max Power [W]: 18,8 W
Light colour [K]: 3000 K or 2700 K upon request
Flux [lm]: 1400 lm**
CRI: >80
Dimming: Phase cut dimmable

Tubular Horizontal
Cylinder-Ø7

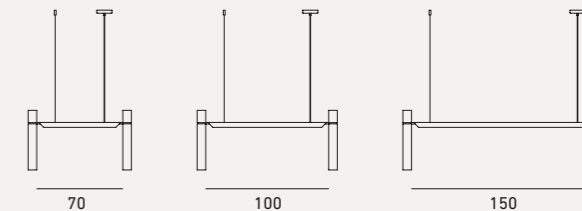

TECHNICAL DATA

Net Weight: 4 kg-5 kg
Light source: GU10 led bulb 24V
Input Voltage [V]: 220-240 V or 110-120 upon request
Max Power [W]: 18,8 W
Light colour [K]: 3000 K or 2700 K upon request
Flux [lm]: 1400 lm**
CRI: >80
Dimming: Phase cut dimmable

Tubular Horizontal
Cylinder-Ø10

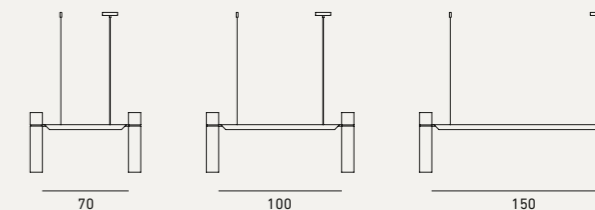

TECHNICAL DATA

Net Weight: 5 kg-6 kg
 Light source: GU10 led bulb 24V
 Input Voltage [V]: 220-240 V or 110-120 upon request
 Max Power [W]: 18,8 W
 Light colour [K]: 3000 K or 2700 K upon request
 Flux [lm]: 1400 lm**
 CRI: >80
 Dimming: Phase cut dimmable

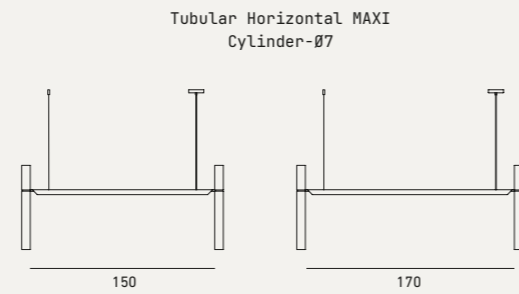

TECHNICAL DATA

Net Weight: 6,50 kg-7 kg
 Light source: GU10 led bulb 24V
 Input Voltage [V]: 220-240 V or 110-120 upon request
 Max Power [W]: 18,8 W
 Light colour [K]: 3000 K or 2700 K upon request
 Flux [lm]: 1400lm**
 CRI: >80
 Dimming: Phase cut dimmable

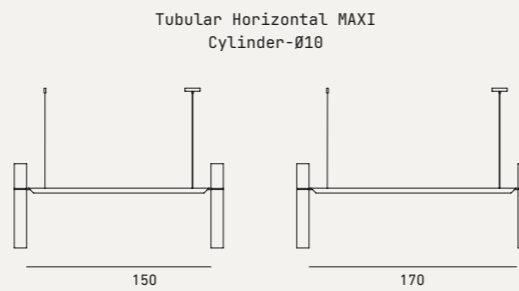

**Output of led inside the lamp. Losses due to diffusor and reflectors are not considered. Values are indicative, ambient temperature, height and position of the lamp may vary the values.
 **Emissione del LED all'interno della lampada. Le perdite dovute a diffusore e riflettori non sono considerate. I valori sono indicativi: temperatura ambiente, altezza e posizione della lampada possono influenzare i valori.

TUBULAR FLOOR TO CEILING

LAMPS/CHANDELIERS



Slender cylindrical suspended bodies, anchored to branched brass structures, create geometrically calibrated and intriguing compositions.

Esili corpi cilindrici sospesi, ancorati a strutture ramificate in ottone, creano composizioni geometricamente calibrate e intriganti.

DESIGNER
Massimo Castagna

DETAILS

- Cylinders made of Burnished Brass, Burnished Platino, or Titanio.
- Energy-saving LED light (Energy efficiency index A).
- Low voltage power supplied through suspension tube.
- Standard total height 250 cm.

LIGHT SOURCE

- GU10 10 LED bulb
- Upon request available with extra warm light 2700K.
- Available 110V upon request, bulbs not included.
- Phase cut dimmable.

DETTAGLI

- Cilindri in Ottone Brunito, Platino Brunito o Titanio.
- Sospensione a led a risparmio energetico (Indice di efficienza energetica A).
- Alimentazione a bassa tensione fornita tramite il tubo di sospensione.
- Altezza totale standard 250 cm.

FONTE LUMINOSA

- Lampadine LED GU10 3000K.
- Su richiesta disponibile con luce extra calda a 2700K.
- Disponibile 110V su richiesta, lampadine non incluse.
- Dimmerabile taglio di fase.

CONSTRUCTION SPECIFICATION

Weight: 14 kg-17 kg
Material: Brass tube
Overall height: 250 cm adjustable
Finish: Burnished Brass, Black Burnished Brass, Burnished Titanio, Burnished Platino

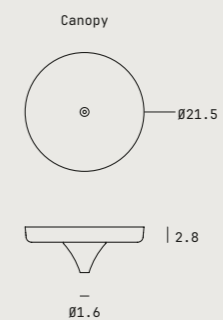

Certified Product
Prodotto certificato

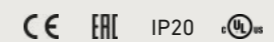

TECHNICAL DATA

Net Weight: 17 kg
Light source: GU10 led bulb 24V
Input Voltage [V]: 220-240 V or 110-120 upon request
Max Power [W]: 55,2 W
Light colour [K]: 3000 K or 2700 K upon request
Flux [lm]: 4200 lm**
CRI: >80
Dimming: Phase cut dimmable

Tubular Ceiling-Floor
6 Identical Elements-Ø5.5

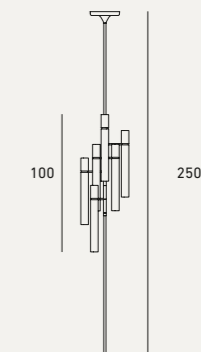

TECHNICAL DATA

Net Weight: 14 kg
Light source: GU10 led bulb 24V
Input Voltage [V]: 220-240 V or 110-120 upon request
Max Power [W]: 27,6 W
Light colour [K]: 3000 K or 2700 K upon request
Flux [lm]: 2100 lm**
CRI: >80
Dimming: Phase cut dimmable

Tubular Ceiling-Floor
3 Identical Elements-Ø7

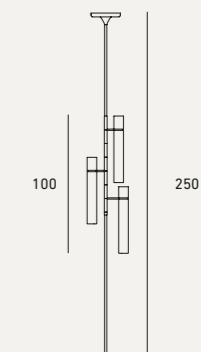

**Output of led inside the lamp. Losses due to diffusor and reflectors are not considered. Values are indicative, ambient temperature, height and position of the lamp may vary the values.
**Emissione del LED all'interno della lampada. Le perdite dovute a diffusore e riflettori non sono considerate. I valori sono indicativi: temperatura ambiente, altezza e posizione della lampada possono influenzare i valori.



OPTIONAL FIXING SYSTEMS

The fixing systems outlined in this document can be selected as an option for remote transformers when used with the following lamps:

Crystal (wall to wall)
Crystal XL
Crystal Metal
Light Ring Horizontal
Light Ring Horizontal Polygonal
Light Ring Horizontal XS
Skyfall
Starlight Horizontal
Tape
Tubular Horizontal
Spyder X
Legacy
Superb-All Horizontal

FIXING TYPE A

312

Lighting collection

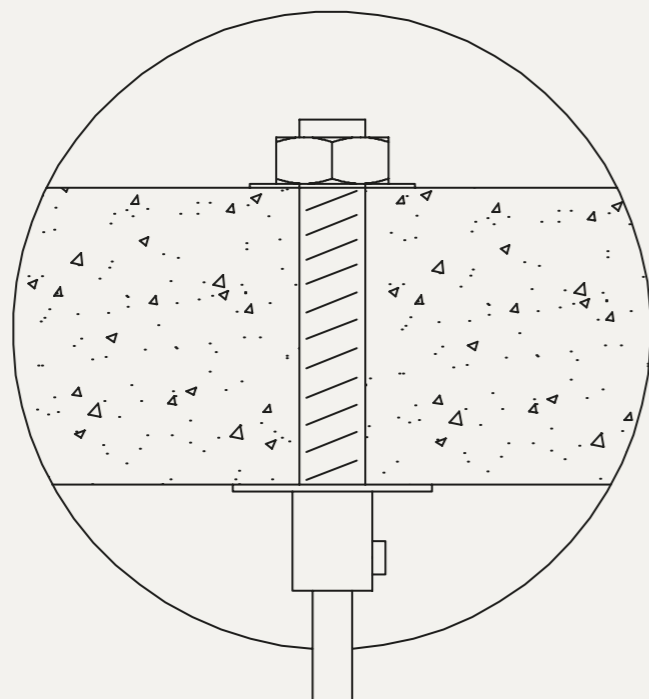

CEILING BRASS ATTACHMENTS TYPE A

The cable and wire fixing system uses rosettes with a diameter of 3 cm. However, these pins must be secured with a nut from above or inside the ceiling, making this option suitable only if you have a false ceiling that allows access to all fixing points from within. When placing an order, please specify the distance at which the transformer will be located to ensure it receives adequate power.

KIT DI MONTAGGIO TIPO A

Il sistema di fissaggio di cavi e fili utilizza rosette di diametro di 3 cm. Tuttavia, questi perni devono essere fissati con un dado sopra o all'interno del soffitto, rendendo questa opzione adatta solo se tu avere un controsoffitto che consenta l'accesso a tutti i punti di fissaggio entro. Quando si effettua un ordine, si prega di specificare la distanza alla quale il il trasformatore sarà posizionato in modo da garantire che riceva un'alimentazione adeguata.

FIXING OPTION

ATTACHMENTS TYPE A

Pins for electricity wire type A

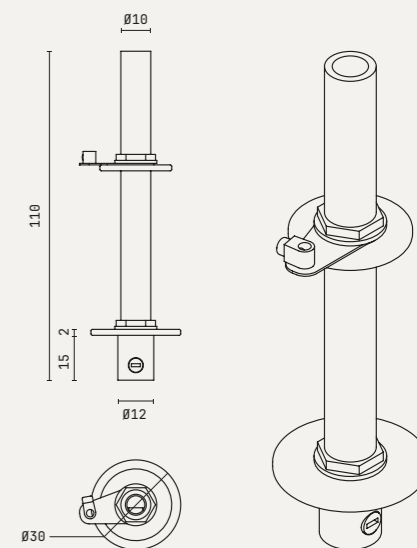

Pins for suspension cables type A

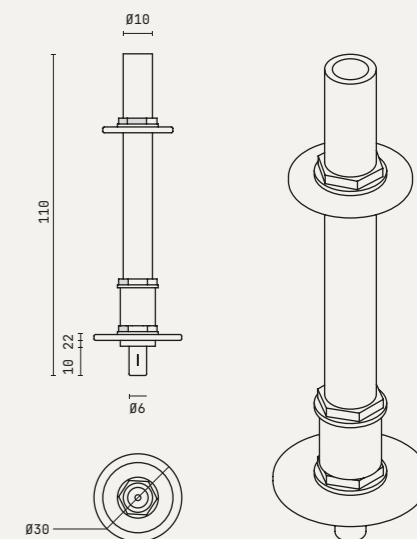

313

Lighting collection

FIXING TYPE B

314

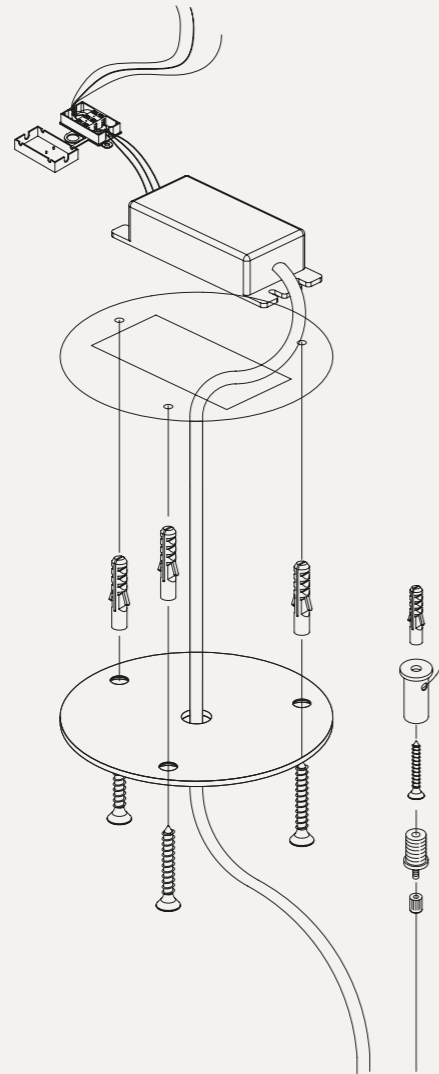

MOUNTING KIT - TYPE B

If the false ceiling is not accessible, a hole will need to be made in the ceiling to insert the transformer(s). The hole will then be covered by a rosette, which will be secured to the ceiling using three screws, as shown in the photos. For electrical cables, the fixing system provides different rosette sizes:

- 9 cm \varnothing for standard cables;
- 13 cm \varnothing when a single transformer is needed for multiple rings;
- 5 cm \varnothing when no holes are required to pass through the transformer in the ceiling.

Suspension wires connected with standard pins. When placing an order, please specify the distance at which the transformer will be located to ensure it receives adequate power.

KIT DI MONTAGGIO - Tipo B

Se il controsoffitto non è accessibile sarà necessario realizzare un foro nel soffitto per inserire il/i trasformatore/i. Il foro verrà poi coperto da un rosone, che andrà fissato al soffitto tramite tre viti, come visibile nelle foto. Per i cavi elettrici il sistema di fissaggio prevede diverse dimensioni di rosone:

- 9 cm \varnothing per cavi standard;
- 13 cm \varnothing quando occorre un unico trasformatore per più anelli;
- 5 cm \varnothing quando non sono necessari fori per il passaggio del trasformatore nel soffitto.

Cavi di sospensione collegati con perni standard. Quando si effettua un ordine, specificare la distanza alla quale verrà posizionato il trasformatore per garantire che riceva un'alimentazione adeguata.

FIXING OPTION

ATTACHMENTS TYPE B

Pins for electricity wire type B

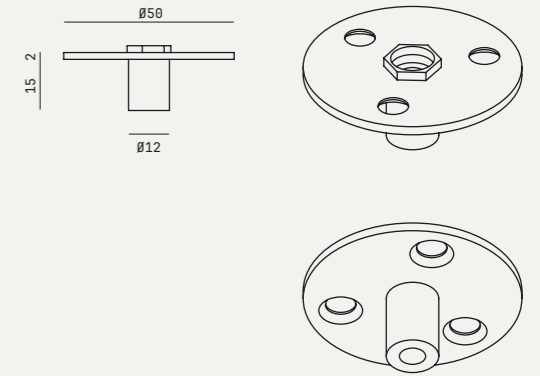

Rosette-Ø 50

Rosette-Ø 90

Rosette-Ø 130

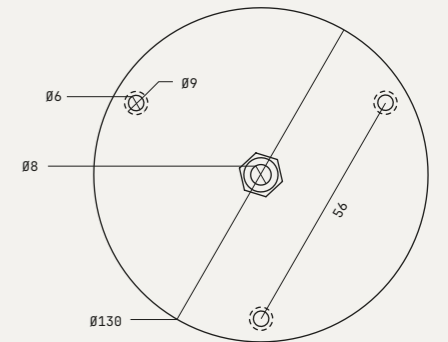
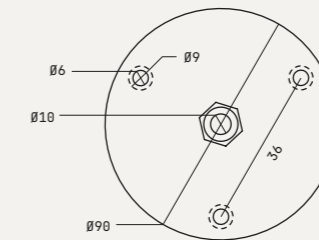
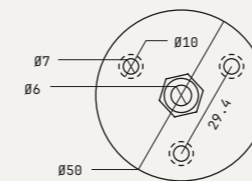

Pins for suspension cables type B

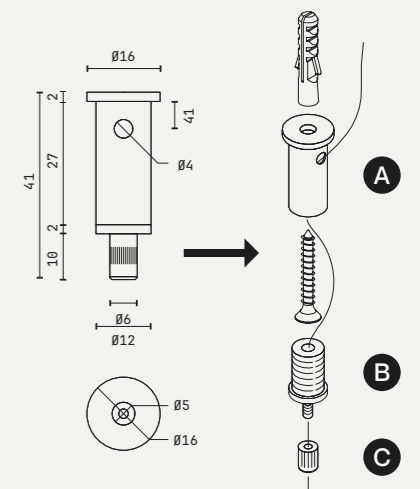

Lighting collection

Lighting collection

315

FIXING TYPE C

316

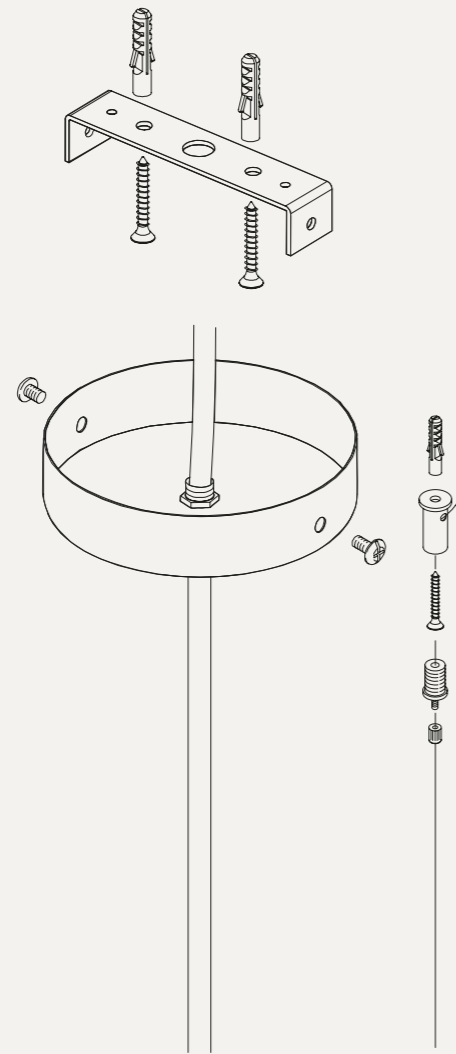

MOUNTING KIT - TYPE C

This system also supports remote transformers, particularly when the ceiling is made of concrete. In such cases, For electrical cables, the fixing system provides different rosette sizes:

- \varnothing 5 x 2 cm h
- \varnothing 10 x 2 cm h
- \varnothing 12 x 2 cm h

along with standard pins for suspension wires.

When placing an order, please specify the distance at which the transformer will be located to ensure it receives adequate power.

ALLEGATI TIPO C

Questo sistema supporta anche trasformatori remoti, in particolare quando il soffitto è in cemento. In questi casi, per i cavi elettrici, il sistema di fissaggio prevede rosette di diverse dimensioni:

- \varnothing 5 x 2 cm h
- \varnothing 10 x 2 cm h
- \varnothing 12 x 2 cm h

insieme ai perni standard per i cavi di sospensione.

Quando si effettua un ordine, specificare la distanza alla quale verrà posizionato il trasformatore per garantire che riceva un'alimentazione adeguata.

FIXING OPTION

ATTACHMENTS TYPE C

Pins for electricity wire Type C

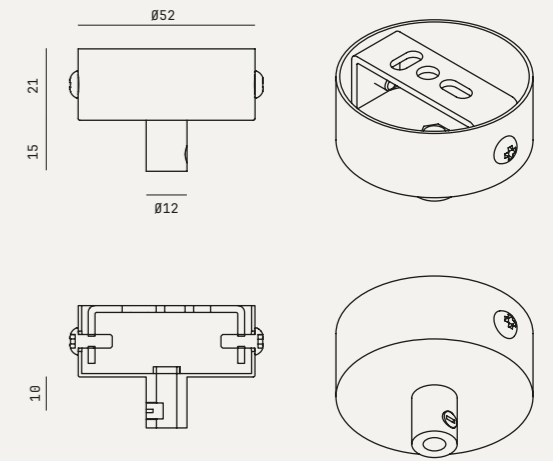

Rosette- \varnothing 50

Rosette- \varnothing 100

Rosette- \varnothing 120

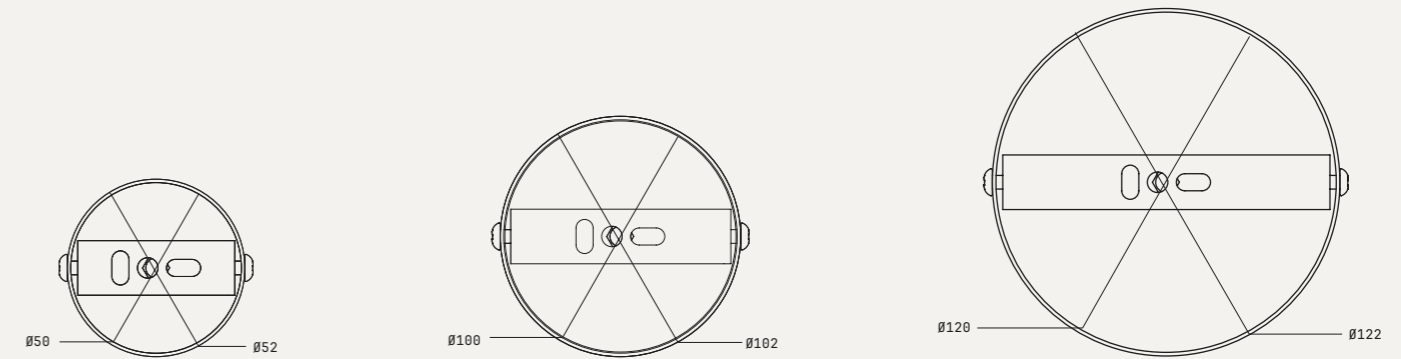

\varnothing 50 \varnothing 52

\varnothing 100 \varnothing 102

\varnothing 120 \varnothing 122

Pins for suspension cables type C

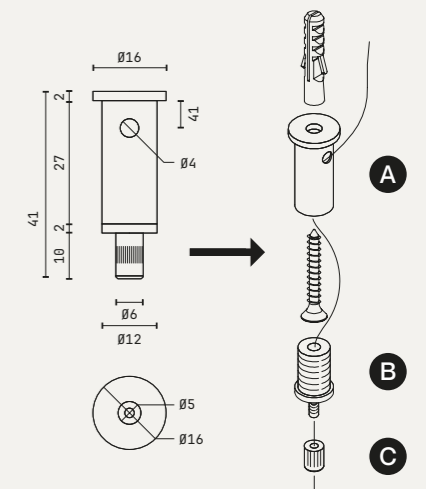

317

Lighting collection

Lighting collection

SPECIAL CUSTOM CEILING CANOPY

FIXING OPTION

318

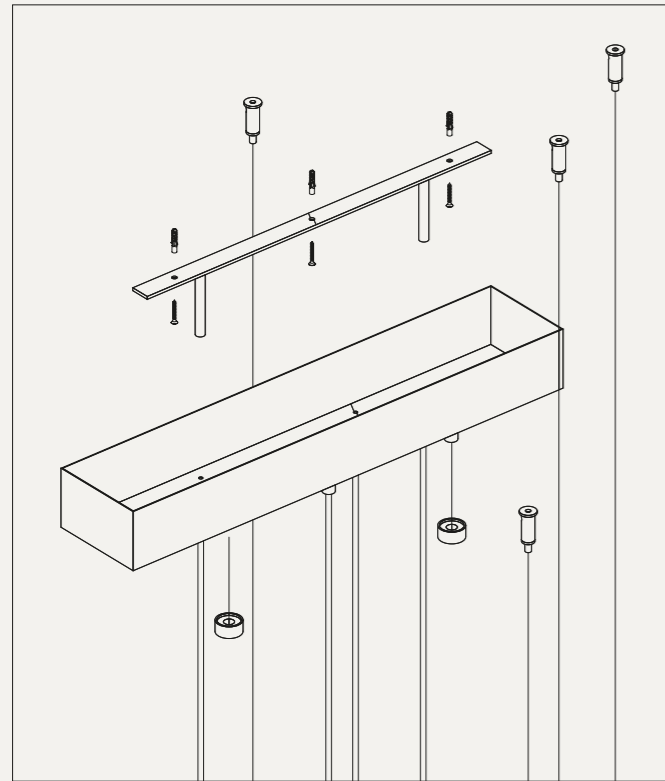

RECTANGULAR CANOPY

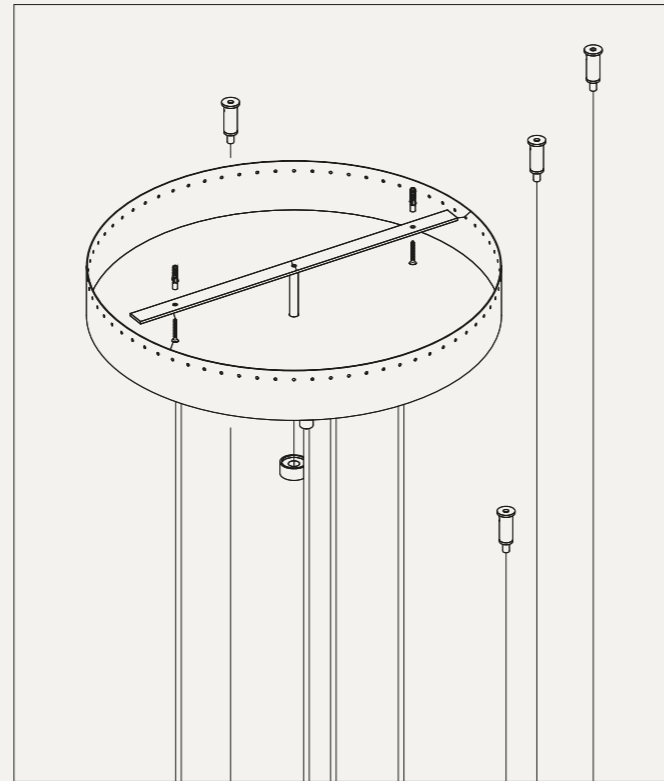

ROUND CANOPY

Lighting collection

MOUNTING KIT-CUSTOM

A canopy matching the lamp's finish will be custom-made and mounted on the ceiling. The size and shape of the canopy, whether round or rectangular, will depend on the overall design-pricing available upon request. Standard pins are provided for supporting the cables.

KIT DI MONTAGGIO-PERSONALIZZATO

Un rosone in tinta con la finitura della lampada verrà realizzato su misura e montato a soffitto. Le dimensioni e la forma del baldacchino, rotondo o rettangolare, dipenderanno dal prezzo complessivo del progetto disponibile su richiesta. Sono forniti perni standard per supportare i cavi.

Pins for suspension cables

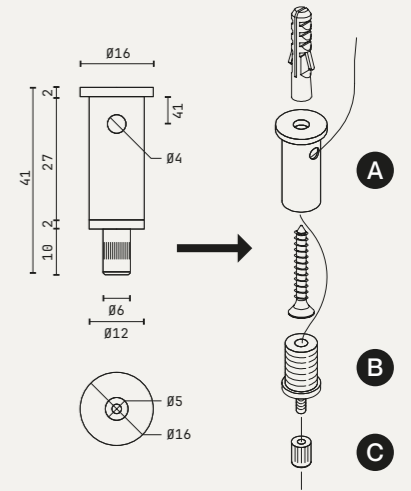

319

Lighting collection

MATERIALS

FINISHES



METAL



Black Burnished Steel



Burnished Titanium

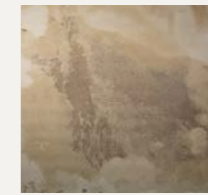

Burnished Platinum

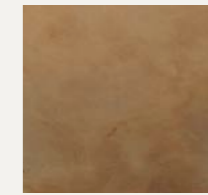

Burnished Brass



Black Burnished Brass



Brass Patina



H-Silver



H-Silver Black

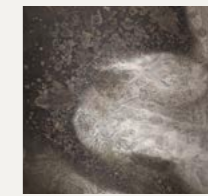

Silver Patina



H-Pale gold

SAND CAST METALS



Sand Cast Peltro



Sand Cast Brass



Sand Cast Bronze



Sand Cast Silver

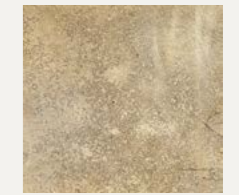

Sand Cast Gold

GLASSES



Floyd/Venini Glass

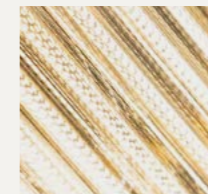

Spyder Glass

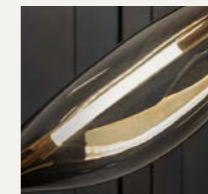

Maple Glass

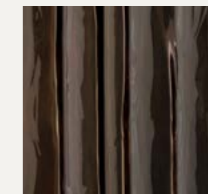

Vibe Glass



Gatsby/Legacy Glass

CARE AND MAINTENANCE

CARE AND MAINTENANCE OF MARBLE

Marble is crystalline limestone rock composed primarily of calcium carbonate. As a natural material, colour variations, whether overall or in the veins and marks even within the same slab, are considered characteristic. The product may change by itself, acquiring an appearance that makes it all the more prized and unique the more it shows signs of age. Over time, such surfaces may deteriorate and/or mark (marks bring more noticeable with a pale colour). It is therefore advisable to avoid leaving cleaning products or household liquids (oil, red wine, vinegar, etc.) on the surface. In particular, products that contain citric acid (present for example in fruit, citrus fruit and tomatoes) act on contact with the treated surface, removing its original sheen.

Always clean stains on surfaces while they are still fresh. To reduce risk, we treat the marble according to the most advanced waterproofing technology. Yet even the best waterproofing treatment, such as the one we apply, becomes less effective normally after two or three months, depending on your use of the surface. Therefore it is very important to renew the treatment regularly using the recommended product supplied. To apply this, carefully follow the instructions printed on the package, bearing in mind however, that the treatment does not make the surface immune to the effects of acidic substances (such as lemon juice).

For routine maintenance use a microfiber cloth with a neutral pH detergent (water alone is enough for flamed finishes). Do not use products containing acids or limescale removing substances. Specific cleaner and care kit for our stones, including specific products and accessories is available upon request.

CARE AND MAINTENANCE OF STEEL MESH TWEED PATTERN

Avoid leaving household liquids (oil, red wine, vinegar, etc.) on the surface. In particular, products that contain citric acid (present for example in fruit, citrus fruit and tomatoes) act on contact with the treated surface, removing its original sheen. Always clean stains on surfaces while they are still fresh. For routine maintenance use a microfiber cloth with a neutral pH detergent for glass (alcohol free). Do not use products containing acids or limescale removing substances.

CARE AND MAINTENANCE OF METALS

Avoid leaving household liquids (oil, red wine, vinegar, etc.) on the surface. In particular, products that contain citric acid (present for example in fruit, citrus fruit and tomatoes) act on contact with the treated surface, removing its original sheen. Always clean stains while they are still fresh. For routine maintenance use a microfiber cloth and water. Do not use products containing acids, limescale removing substances or alcohol.



AMMAN AMSTERDAM ATHENS AUCKLAND BANGALORE BANGKOK BARCELONA BEIJING BEIRUT BERLIN BOSTON
BRUXELLES BUDAPEST CANNES CASABLANCA CHRISTCHURCH COLOGNE COPENHAGEN CYPRUS DOHA DUBAI DÜSSELDORF
FRANKFURT GENT HAMBURG HONG KONG HOUSTON ISTANBUL JAKARTA JOHANNESBURG KITZBUHEL LINZ LONDON LOS
ANGELES MADRID MANILA MANAMA MARBELLA MELBOURNE MEXICO CITY MIAMI MILAN MONTECARLO MOSCOW MUMBAI
MUNICH NEW YORK CITY NICE OSLO PALMA DE MALLORCA PANAMA CITY PARIS PRAGUE SALZBURG SAINT PETERSBURG
SANTO DOMINGO SEATTLE SHANGHAI SHENZHEN SOFIA STUTTGART TAIPEI TEL AVIV THUN TORONTO WARSAW ZURICH

HENGE
MADE IN ITALY

Henge Headquarters
Via Fossa 1
31051 Follina (TV) — Italy

www.henge07.com

Via della Spiga 34
20121 Milano (MI) — Italy
T +39 0438 1710600

atelier@henge07.com
Open by appointment

GLOW

PRODUCT DESIGN BY
Massimo Castagna, Ugo Cacciatori
Yabu Pushelberg, Davide Nascimbeni

GRAPHIC DESIGN
Studiogusto

PRINTED BY
Grafiche Antiga

