

**DRAFT**

**HENGE**

DRAFT

SPREADING BEAUTY IN EVERY CORNER OF THE WORLD

HENGE



Welcome to the world of Henge, where design transcends the ordinary and reaches new heights of sophistication. This book is a celebration of the most exquisite interior design projects from around the globe, each graced by the presence of Henge's unique products.

It is intended to serve as a beacon of inspiration for architects, interior designers, and anyone passionate about interiors, guiding them toward new heights of innovation and elegance in their work.



At Henge, we believe that furniture is not merely functional; it is a vital component of the living environment that shapes our experiences and emotions. Our commitment to quality, craftsmanship, and design excellence is evident in every piece we create. Each project featured in this book stands as a testament to our philosophy: to blend the highest standards of Italian craftsmanship with cutting-edge design, resulting in spaces that are as unique as they are beautiful.

Customization and personalization are at the heart of what we do at Henge. Many products showcased on these pages have been completely personalized to achieve the best outcome for our customers' needs.





We are always available to find suitable solutions for our clients, ensuring that each piece not only fits perfectly within the design but also reflects the individuality and vision of those who live and work in these spaces.

As you turn these pages, you will discover a collection of spaces that reveal the full versatility and sophistication of Henge's creations. From contemporary urban lofts to serene countryside retreats, each project illustrates how Henge furniture integrates effortlessly into diverse contexts, enriching them both aesthetically and functionally.



Every image in this book is more than just a photograph; it is a story of collaboration between visionary designers and our skilled artisans. These projects are the culmination of meticulous planning, innovative thinking, and a passion for creating spaces that inspire. Each piece of furniture featured here carries a unique narrative, meticulously crafted to evoke a sense of place and purpose.

To provide a deeper connection to the products that make these designs possible, we have integrated QR codes linked to each piece of furniture. By scanning these codes, you will be directed to dedicated landing pages where you can explore extra images, the details, and the craftsmanship behind each product. This seamless integration of print and digital media offers a comprehensive understanding of how our furniture can transform any space.



Let the creativity and innovation displayed here inspire your projects. At Henge, we are committed to pushing the boundaries of design and craftsmanship, and we hope this book serves as a valuable resource in your quest to create extraordinary spaces.

Thank you for joining us on this journey.

The Henge Team

## INDEX

VILLA CÔTE D'AZUR	CANNES	p. 18
HORIZON PENTHOUSE	FRANKFURT	p. 36
LA SERENISSIMA	VENICE	p. 52
HENGE CHALET	CORTINA	p. 74
CHALET EDELWEISS	KITZBUHEL	p. 92
HILL SIDE	LOS ANGELES	p. 108
PRANA MANSION	ASIA	p. 124
H ISTRRA	EUROPE	p. 168



## VILLA CÔTE D'AZUR

Cannes, FR

Villa Côte d'Azur: A jewel of design in the hills of Cannes exploring one of the latest interior design projects signed by Nembo Design Studio, in collaboration with Henge.

The design philosophy behind this residence, which enjoys a panoramic position with breathtaking views of the bay, pursued the goal of creating an authentic connection between indoor and outdoor spaces. Large, minimalist-framed windows ensure the view can be enjoyed year-round, removing any barrier and establishing a genuine connection with the outdoors.

The panoramic view of Cannes provides the property's most stunning scenery. The large windows and 5-meter-high ceiling allow for extraordinary brightness and convey a sense of exceptional volume, maintaining a feeling of spaciousness and expansive open spaces. The staircase features a glass parapet and steps made of "Briccola Wood", which are wooden poles from the Venetian lagoon that were traditionally used for navigation by sailors. This staircase was custom-made for the project and designed to allow natural light to flood the surrounding spaces with its transparency.

### CREDITS

Project Francesco Bortolato, Nembo Design Studio  
 Development Rosengart Real Estate Group  
 Photography Andrea Pancino

CHAIRS AND STOOLS	Hexagon Stool Ex-Tra
TABLES	Synapse
LIGHTING	Light Ring Polygonal Evo Light Ring Horizontal XS Abaco Flat Tele Light
BOOKCASES	Bistrot Loom System
COFFEE TABLES	SR Primitive Pebble
SOFAS AND ARMCHAIRS	Vertigo Opus S Perla
NIGHT COLLECTION	Noctis Bed
ARCHITECTURAL SYSTEM	Linejust



Some of the pieces shown are from past collections or custom creations. Only current designs include a QR code for further information.





---

SYNAPSE STR Onyx



---

EX-TRA Black eucalyptus, Symba 10





OPUS Black Burnished Steel,  
Nabuck Slate 90

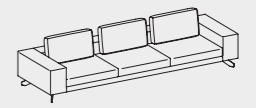

VERTIGO Sand Cast Titano,  
Nabuk Tuber

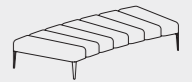

PEBBLE Gres Silver

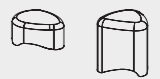

SR Burnished Platino, Web Grey

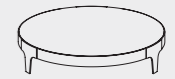

PRIMITIVE Black Burnished Steel,  
White Ostuni.



This master bedroom's front wall is a stunning example of Henge's dedication to personalization and collaboration. To optimize both space and aesthetics, the architect worked closely with our design and technical teams to create a bespoke solution.

The centerpiece is a custom Bistrot bookcase, designed to seamlessly integrate with the room's style. Flanking the entrance to the en-suite bathroom, we installed wardrobes with wooden doors luxuriously covered in leather, providing both elegance and functionality.

This room exemplifies the extensive customization capabilities of Henge, tailored to meet the unique needs of our clients.

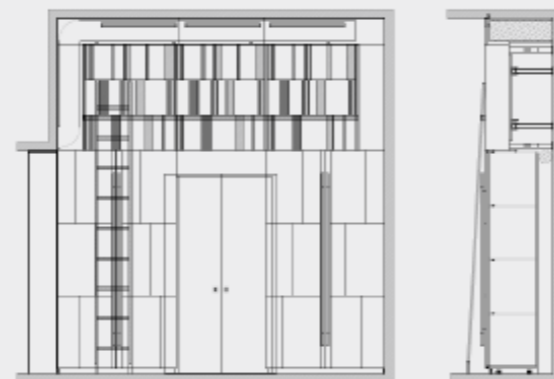



ABACO Burnished Platino, Burnished Titanio,  
Black Burnished Brass, White Crystal.



LIGHT RING POLYGONAL H-Silver.

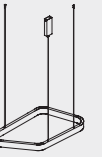

LIGHT RING POLYGONAL H-Silver.

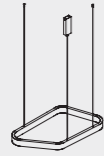

FLAT H-Silver.

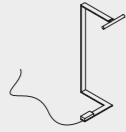

NOCTIS BED Nabuk Blue 84,  
Burnished Brass.

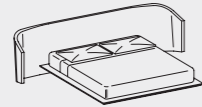

LINE JUST  
Burnished Brass.

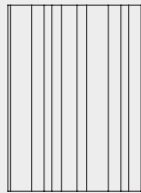



GELLY POUF Leather Sense Nero 01,  
Burnished Titano.



MUSHROOMS Sand Cast Bronze.

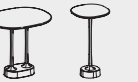

TELE LIGHT Sand Cast Bronze.



S-PERLA



# PRODUCTS OVERVIEW

Synapse



Ex-Tra



Opus



Vertigo



Pebble



Primitive



SR



Light Ring  
Polygonal Evo

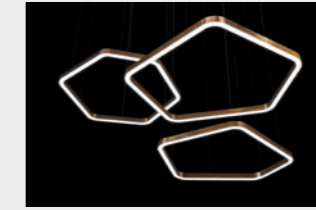

Flat

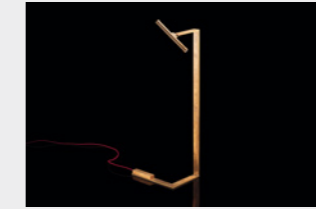

Light Ring  
Horizontal XS

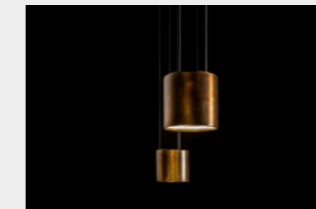

S-Perla



Hexagon Stool

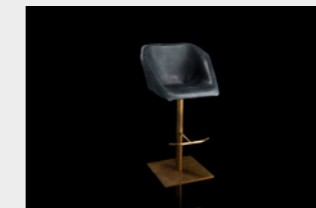

Abaco

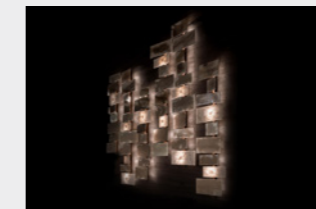

Noctis Bed



Tele





## HORIZON PENTHOUSE

Frankfurt, DE

Perched above the skyline, this remarkable Frankfurt penthouse captures the essence of contemporary refinement through a seamless dialogue between architecture, light, and material. Designed by PurPur Interior Concepts, the Frankfurt-based interior design firm renowned for its meticulously balanced interiors, the project reflects their philosophy of uniting precision, emotion, and spatial harmony.

Every element—every finish, proportion, and glow—has been orchestrated to create an environment that feels both composed and alive. At the heart of the residence, envisioned as its luminous centerpiece, stands the Oneon kitchen island in Ice Onyx. Under PurPur's direction, this sculptural piece transcends functionality: the translucent stone, backlit to reveal its intricate veining, becomes a glowing focal point that anchors the open living space. Surrounding kitchen units finished in H-Pale Gold with recessed doors continue the studio's pursuit of refined restraint—where minimal gestures and immaculate craftsmanship speak louder than ornament.

A custom winery partition, another key intervention by PurPur, exemplifies their ability to merge utility with narrative design. Integrating a wine cellar and a backlit Ice Onyx backrest, it acts as both divider and centerpiece—softly illuminating the space and guiding the gaze through its layers. The subtle interplay between warm metallic tones, the gentle radiance of onyx, and the expansive city views creates an atmosphere that is at once grounded and ethereal. In collaboration with Henge, the project becomes a statement of shared values: timeless design, material honesty, and the pursuit of bespoke beauty.

### CREDITS

Interior Design PurPur Interior Concepts, Frankfurt  
Photography Andrea Pancino

TABLES	Time Synapse
BOOKCASES	Cage B
LIGHTING	Superb-All Tape
KITCHEN & KITCHEN UNITS	Oneon Quadrant Tall Units Loom system Winery
ARCHITECTURAL SYSTEM	Checkmate

Some of the pieces shown are from past collections or custom creations. Only current designs include a QR code for further information.



ONEON Ice Onyx

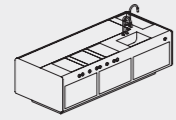

QUADRANT KITCHEN UNIT H-Pale Gold

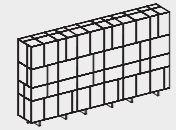

LOOM SYSTEM WINERY (CUSTOM VERSION) Backlit Ice Onyx

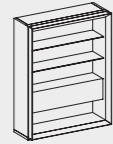

TAPE Burnished Titano

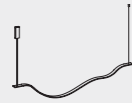

SYNAPSE Apuan Black







TIME H Pale Gold.



CAGE B Burnished Titano,  
Oak Thermowood.

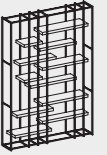

CHECKMATE ARCHITECTURAL SYSTEM  
Apuan Black

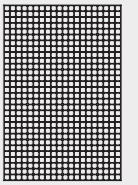

SUPERB-ALL Fiberglass, Burnished  
Brass and metal stems.



SYNAPSE Swamp Oak.





# PRODUCTS OVERVIEW

Time



Synapse



Cage B



Oneon



Superb-All



Tape

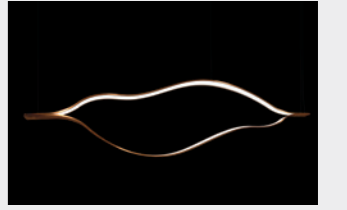

Quadrant Tall Units



Loom System Winery



Checkmate





## LA SERENISSIMA

Venice, IT

Venice has a way of holding history in its breath. Tucked within a noble residence dating back to the 1600s, this project reveals what happens when contemporary design is allowed to live gracefully within the poetry of the past.

The space is a testament to layered beauty. Ornate ceilings, faded af-freschi, and the patina of centuries set the tone. Our pieces enter not as intrusions but as counterparts, quietly powerful forms that honour the heritage while asserting their own presence. In this dialogue between eras, the furniture doesn't compete. It resonates.

Here, modern craftsmanship meets time-worn splendour in a rare, fluid harmony. It is not about contrast. It is about coherence, the kind that only emerges when design knows where it comes from and dares to imagine where it can go.

### CREDITS

Architect Isabella Genovese

Photography Andrea Pancino

COFFEE TABLES	SR Big Bang Twistable
TABLES	Ted Zenith Shift LY
LIGHTING	Light Ring Polygonal Evo Flat Pipe
CHAIRS	Ketch Hexagon
SOFAS	Downtown
NIGHT COLLECTION	Noctis Bed
SIDEBOARDS	Slim Side Upperside
BOOKCASES	Cage Layer Bistrot Horizontal

Some of the pieces shown are from past collections or custom creations. Only current designs include a QR code for further information.



LIGHT RING POLYGONAL H Silver Black.

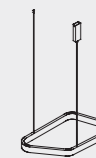

TED Sand Cast Peltro, Black Pearl, Burnished Titanio.

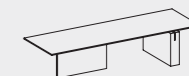

KETCH Leather E-Type Nero 3416.

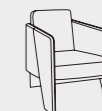

DOWNTOWN Leather Phantom Nero,  
Burnished Titanio.

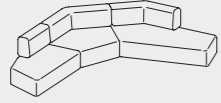

SR Small - H Piuma, Silver Patina  
Large - Black Pearl, Silver Patina



CAGE LAYER Oak Thermo Wood, Black  
Burnished Steel.

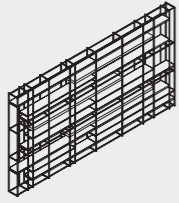



KETCH Leather E-Type Nero 3416.



SHIFT Black Fantasy, Burnished Titanio.



DOWNTOWN Nabuk Blue 84, Burnished Titanio.

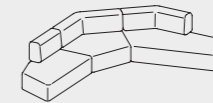

BIG BANG STR Onyx, Sand Cast Peltro



NETWORK STR Onyx, Burnished Titanio.

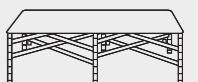

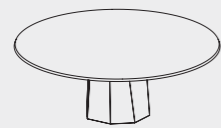



TED Sand Cast Peltro, Black Pearl,  
Burnished Titanio.

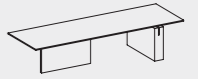

KETCH Leather E-Type Nero 3416.





SLIM SIDE H Pale Gold.

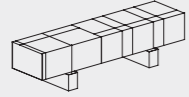

HEXAGON Burnished Titanio, Camoscio  
Natural 31.

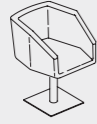

LY Silver Brown Wave.

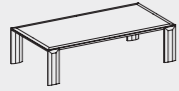

BISTROT HORIZONTAL Burnished  
Titanio

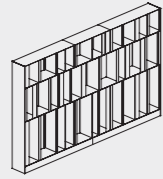



NOCTIS BED Leather Nabuck Blue 84,  
Burnished Titano.

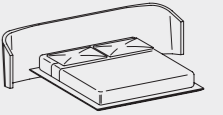

TWISTABLE Sand Cast Bronze,  
Burnished Titano.



PIPE FLOOR LIGHT Burnished Brass,  
SBW Stone.



FLAT Burnished Brass.

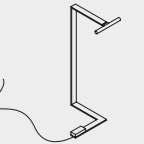

# PRODUCTS OVERVIEW

Light Ring  
Polygonal Evo

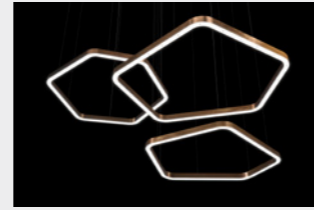

SR



Big Bang



Twistable



Ted

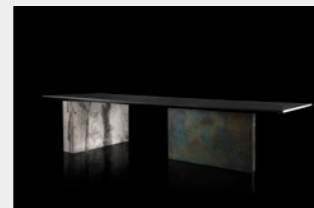

Zenith

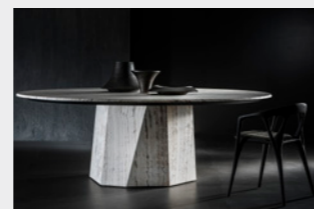

Shift



Pipe



Ketch



Downtown

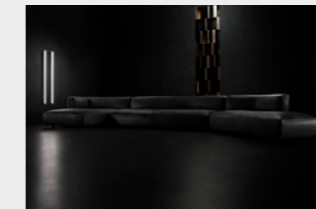

Noctis Bed



Slim Side



Upper Side High

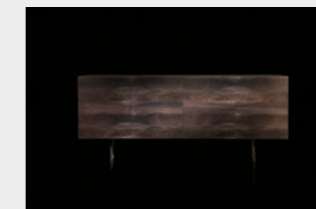

Cage Layer

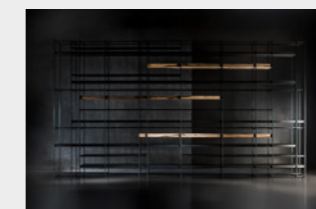

Flat

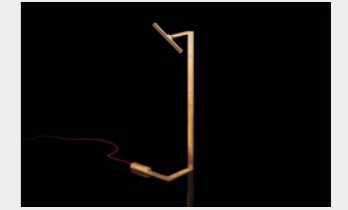



## HENGE CHALET

Cortina d'Ampezzo, IT

Cortina is a place where tradition meets innovation — a timeless symbol of Italian elegance and aspiration.

Since the early 1900s, it has embodied a lifestyle rich in possibility and charm. A winter retreat, a burst of color in the warmer months, and a breathtaking stage during the foliage season, Cortina is an open-air sanctuary. Through sport, cinema, art, and design, it has become an international icon that reflects the contemporary spirit of the Dolomites.

Chalet Henge is the private retreat of Paolo Tormena and Isabella Genovese — a space that seamlessly blends Henge's design ethos with the natural and cultural uniqueness of its setting.

Just beyond the vibrant heart of Cortina and its lively social scene, the chalet is nestled among fir trees, with sweeping views of the Tofane, Cinque Torri, and Cristallo mountain ranges.

Located within an exclusive private compound, the chalet is clad in larch wood reclaimed from historic local barns — the *tabià* — a material chosen for both the façade and interiors. Architect Isabella Genovese embraced this element, preserving the wood's authenticity and visual integrity throughout her intervention.

Bathed in the natural light of the Dolomites through expansive windows and glass openings, the chalet's layout is built around the themes of conviviality and comfort.

The thoughtful separation of day and night zones forms the heart of the project — a functional, welcoming retreat where design and landscape exist in quiet harmony.

### CREDITS

Architect Isabella Genovese  
Photography Andrea Pancino

CHAIRS AND STOOLS	Strip
TABLES	Sisma Gotham
LIGHTING	Test-One Crystal
COFFEE TABLES	Origami SR
SOFAS AND ARMCHAIRS	Downtown Bug Gelly Pouf Tambourine
ACCESSORIES	Himalaya



Some of the pieces shown are from past collections or custom creations. Only current designs include a QR code for further information.



In this image, the Gotham table has been masterfully reimagined to fit the specific requirements of a cozy chalet space.

By rounding and reducing its size, Henge has transformed the Gotham table into a bespoke piece that perfectly complements the intimate and warm atmosphere of the chalet.

GELLY POUF Ghost Polvere, Burnished Titanio.



GOTHAM Rapolano VS, Black Burnished Steel.

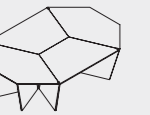

CRYSTAL White Crystal.

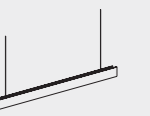

TEST-ONE Paonazzo Marble.





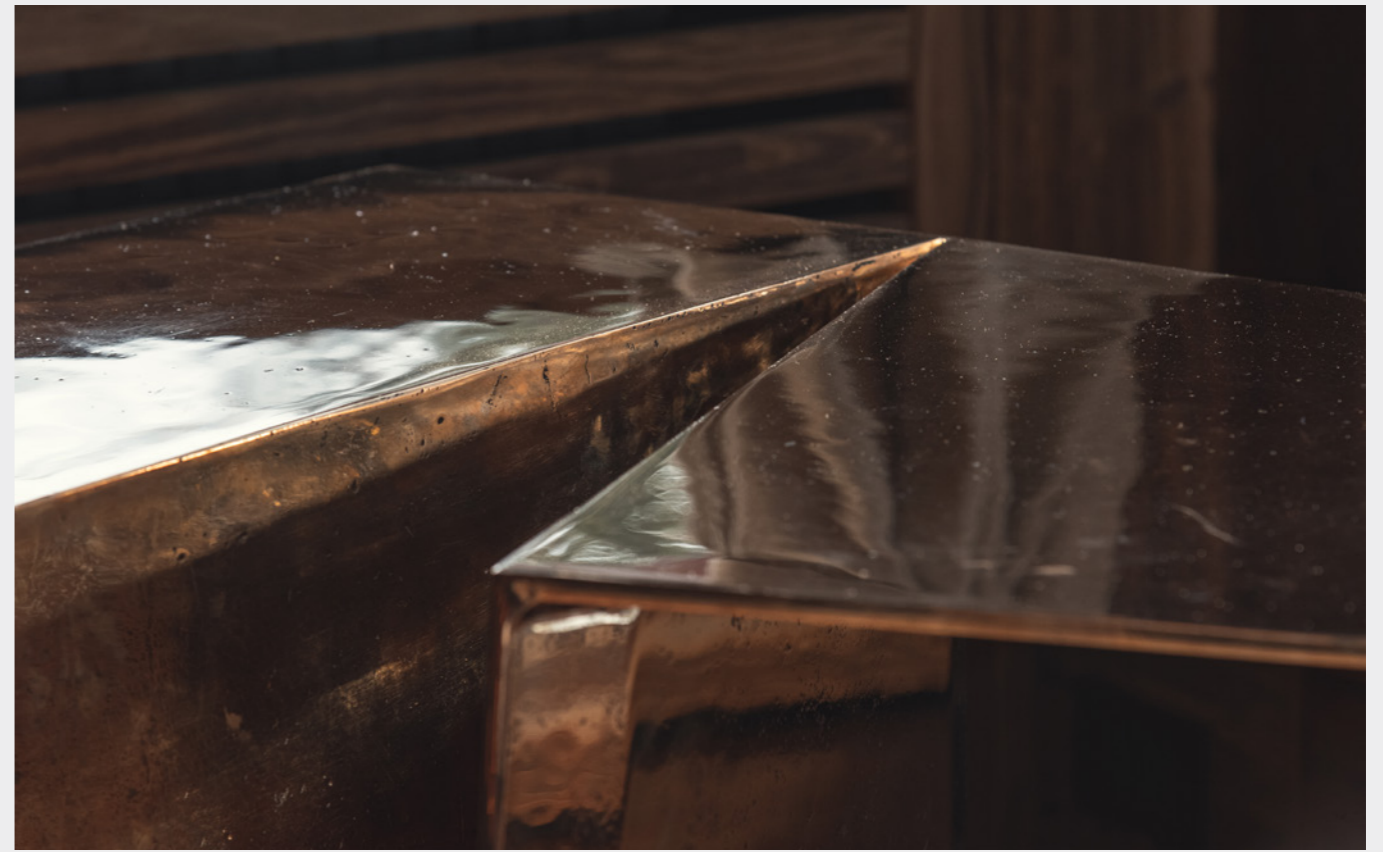

ORIGAMI Sand Cast Bronze.

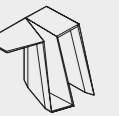

In this image, the Origami coffee table has been ingeniously transformed into a console table, standing at 82 cm high and crafted from stunning Sand Cast Bronze.

This reimagined Origami console table not only enhances the room's functionality but also elevates its overall aesthetic, demonstrating Henge's commitment to delivering personalized, high-end furniture solutions tailored to their clients' unique visions.



BUG Phantom Nero, Pelliccia Kalgan  
Tortora, Burnished Titano.



TAMBOURINE Ghost Polvere, Sand  
Cast Peltr.



HIMALAYA Himalayan Wool 05

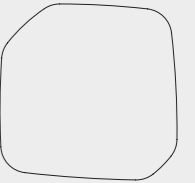

STRIP Phantom Black,  
Burnished Titanio.



CRYSTAL White Crystal Stone.

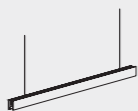

SISMA Sand Cast Peltro, Travertino

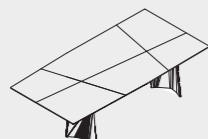



DOWNTOWN Ghost Antracite, Black  
Burnished Steel.

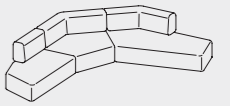

SR Burnished Titanio, Ice Onyx

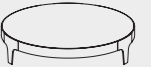

# PRODUCTS OVERVIEW

Strip

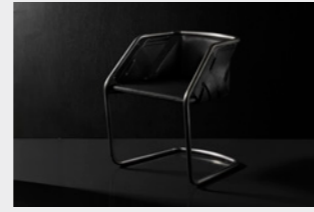

Sisma



Test-One



Crystal

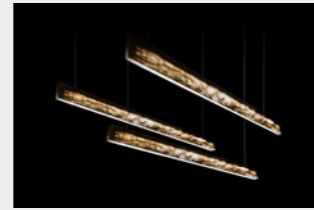

Origami



SR



Downtown

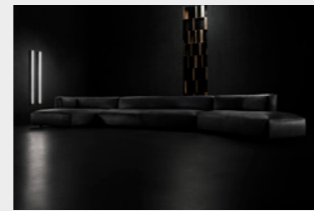

Tambourine



Bug



Gelly Pouf

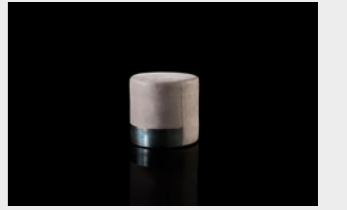

Gotham



Himalaya





## CHALET EDELWEISS

Kitzbühel, AUT

In the picturesque setting of Kitzbühel, Tyrol, Austria, Chalet Edelweiss sits on a gentle hill, offering breathtaking panoramic views of the valley and mountains. This three-story chalet combines modern design with traditional Alpine architecture, creating a luxurious and harmonious living space. Designed by Philicima Design Studios and Sublime Group, and developed by Prime Properties Group, Chalet Edelweiss aims to provide a genuine sense of home and a close connection with nature. Its open layout on the top level seamlessly integrates with the lush surroundings.

### CREDITS

Design Philicima Design Studios

Developer Prime Properties Group

Photographer Jamie McGregor Smith



Some of the pieces shown are from past collections or custom creations. Only current designs include a QR code for further information.

#### CHAIRS AND STOOLS

Strip  
Ex-Tra

#### LIGHTING

Tubular (Solo Version)  
Flat  
Flat Table  
Starlight

#### COFFEE TABLES

Primitive  
Be Mine  
Twistable

#### SOFAS AND ARMCHAIRS

RF  
Lailand  
Gelly Pouf

#### CABINETS

Slim Side Vertical



FLAT Burnished Platino.

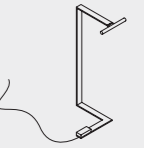

RF A. Seat and backrest: padding made of Axum 23; Backrest: Leather Sense Nero 01  
B. Seat and backrest: padding made of Axum 03; Backrest: Leather Nabuk Moss 23.

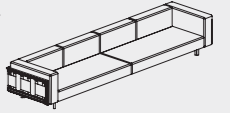

PRIMITIVE White Ostuni;  
Burnished Titanio.





LAILAND Seat: Fabric Axum 23,  
Backrest Leather Sense Nero 01,  
Feet: Sand Cast Bronze.

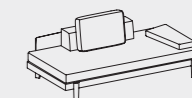

TUBULAR Burnished Brass.



BE MINE Sandcasting Brass,  
Top: Shine Brass.



RF A. Seat and backrest: padding made of Axum 23; Backrest: Leather Sense Nero 01  
B. Seat and backrest: padding made of Axum 03; Backrest: Leather Nabuk Moss 23.

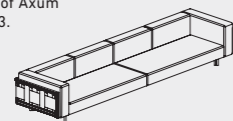

PRIMITIVE White Ostuni;  
Burnished Titanio.





STARLIGHT Black Burnished Brass.

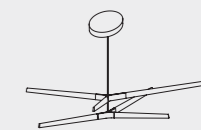

EX-TRA Nabuk Moss 23.



STRIP Burnished Platino, E-Type Testa di Moro 3436.





TUBULAR (SOLO VERSION) Burnished Brass



FLAT TABLE Burnished Platino.



TUBULAR (SOLO VERSION) Burnished Brass



SLIM SIDE VERTICAL Burnished Platino



# PRODUCTS OVERVIEW

RF



Primitive



Starlight



Tubular

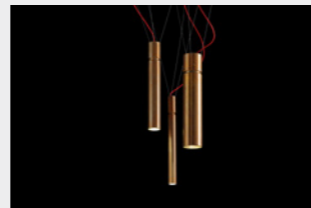

Lailand



Be Mine

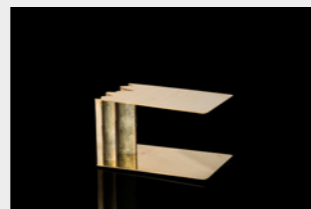

Gelly Pouf



Strip

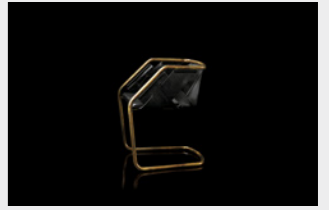

Ex-Tra



Flat

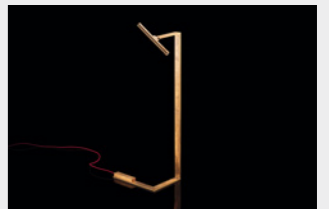

Flat Table

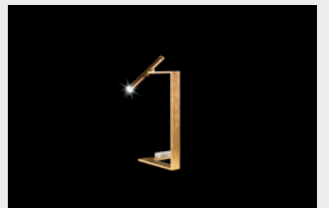

Slim Side Vertical

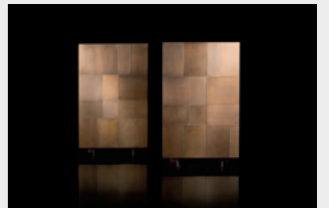

Twistable





## HILLSIDE

Los Angeles, US

Henge Furnishes an Architectural Masterpiece in the Hollywood Hills. Set high in the Hollywood Hills, this 22,216 square foot residence is a bold expression of contemporary architecture by SAOTA—the internationally acclaimed firm known for redefining luxury living through dramatic forms, seamless indoor-outdoor transitions, and breathtaking site integration.

The interiors were curated by Henge in collaboration with MASS Beverly, resulting in a space that balances architectural power with refined materiality. The home features a striking composition of fire and water, including a 12-foot indoor cascading waterfall. Its expansive design includes a 163-foot wraparound infinity pool, bar, and lounge with fire pit, along with a rooftop terrace offering a dining area, bar, spa, and lounge with panoramic views stretching from the San Gabriel Mountains and Downtown Los Angeles to Santa Monica and Catalina Island.

Henge's pieces bring a sculptural presence to the interiors—rich in texture, bold in character, and crafted with extraordinary attention to detail. The collections elevate each space with a quiet yet unmistakable strength, defined by noble materials and exceptional craftsmanship. This landmark project affirms Henge's role as a trusted choice for furnishing visionary residences around the world.

### CREDITS

Jeff Thomas, Owner of 8408 Hillside; Mark Bullivant, SAOTA  
Isabella Genovese, Henge Interior Dept.; Lars Hypko, MASS Beverly;  
Seth Matheson, MASS Beverly; Damian O'Hara, Parklane Projects Fortis

Development Woods + Dangaran; Lux Populi; Chris Sosa; Oppenheim Group; Bond Street Partners

WORKS OF ART COURTESY OF  
Brian Ludlow of Creative Art Partners

CHAIRS AND STOOLS	Rio Stool Strip Ex-Tra
TABLES	K-Table Soprano
LIGHTING	Light Ring Polygonal Starlight Horizontal Tape Tubular Horizontal
BOOKCASES	Cage B
COFFEE TABLES	D-Code Mushrooms Touch
SOFAS AND ARMCHAIRS	Lailand Radical
CABINETS	B-Side



Some of the pieces shown are from past collections or custom creations. Only current designs include a QR code for further information.



D-CODE (Discontinued)  
Black Burnished Brass.



STARLIGHT HORIZONTAL Black  
Burnished Brass, Sand Cast Bronze.

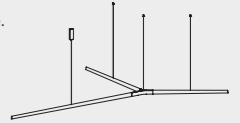

HUMAN Fabric Fauna 168,  
Black Burnished Steel.

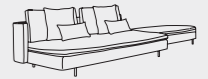

LIGHT RING POLYGONAL  
Black Burnished Brass.



MUSHROOMS Sand Cast Brass.

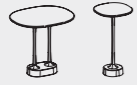

D-CODE (Discontinued)  
Black Burnished Brass.





RIO Leather E-Type Natural 3451, Swamp Elm, Black Burnished Steel.

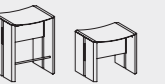

TUBULAR HORIZONTAL Burnished Brass

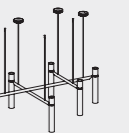

EX-TRA Camoscio Natural 31.



TAPE Burnished Brass.

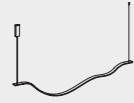

B-SIDE Swamp Oak, Burnished Brass.

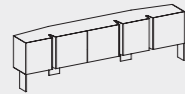

SOPRANO Cappuccino Marble,  
Leather Shine Moss 03.

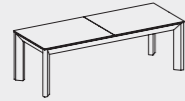



RADICAL Leather Camoscio Natural 31

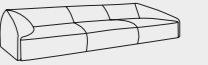

BE MINE Sandcasting Brass,  
Top: Shine Brass.



TOUCH Oak Thermo Wood, Black  
Burnished Brass.



SR Ice Onyx, Burnished Titanio.





CAGE-B Eucalyptus Thermo Wood,  
Burnished Brass.

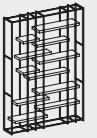

STRIP Leather E-Type Natural 3451,  
Black Burnished Brass.



K-TABLE Eucalyptus Thermo Wood.



# PRODUCTS OVERVIEW

Strip



Rio



Ex-Tra

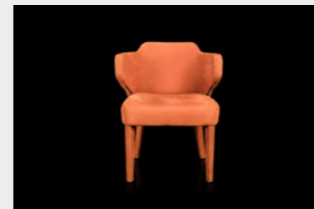

Soprano



K-Table

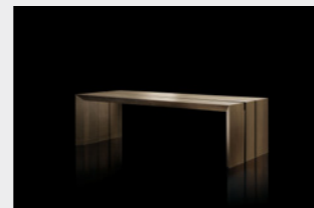

Tape

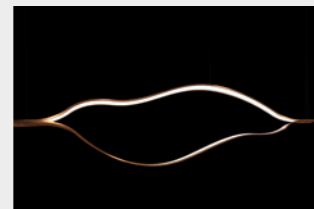

Light Ring Horizontal  
Polygonal

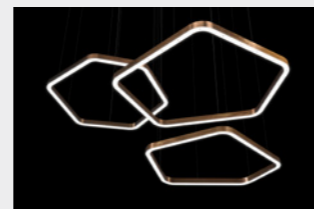

Starlight Horizontal



Tubular Horizontal



Lailand



Radical



B-Side



Mushroom



D-Code



Cage B

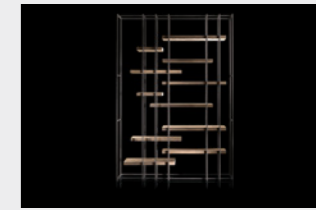

Touch





## PRANA MANSION

Asia

A project of rare vision and refined execution, The Mansion is a private residence where architecture and interior design converge to create an extraordinary living experience. The interior design, conceived by Isabella Genovese in collaboration with ARYS, finds its perfect counterpart in Henge's full-house intervention—an immersive project that redefines the boundaries between furniture, space, and bespoke design.

From the earliest brief, the client expressed a desire for tactile richness and architectural character, with brass and burnished brass setting the material tone. Henge responded with a curated ensemble of signature pieces and entirely custom-designed elements, conceived to integrate seamlessly into the home's unique architectural language. Among the most remarkable interventions is a five-metre-high pivot door, a bold sculptural feature that balances monumental scale with precise detailing. Throughout the villa, hidden doors and integrated storage solutions are elegantly embedded into architectural volumes, maintaining a clean aesthetic while maximizing functionality.

Custom furniture and architectural elements have been developed not only to fulfil the client's requirements but to enhance the soul of the space, celebrating contrasts, materials, and the quiet power of design.

### CREDITS

Interior design Isabella Genovese

ARYS

Photography Andrea Pancino

COFFEE TABLES	Blown Out Be Mine Big Bang Mushroom	MonoLith SR Twistable
TABLES	Synapse Ted Shift Lounge Table Time	
LIGHTING	Spyder Spyder X Tape Tele Tubular Light Flat Lamp Gladio	Test-One Test-Two Light Ring Horizontal Light Ring Horizontal Polygonal Light Ring Horizontal
CHAIRS	Ketch Ketch Armchair Hexagon Stool	Hexagon Jill Stool Strip Lounge Chair
SIDEBOARDS	Teke	
BOOKSHELVES	Cage C Bistrot	
SOFAS	Lailand	
KITCHENS	Ozone Ice Onyx Backlit Custom Bar	

Some of the pieces shown are from past collections or custom creations. Only current designs include a QR code for further information.

CRYSTAL EVO White Crystal

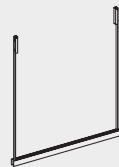

TIME Burnished Brass

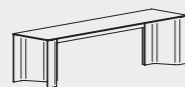

CAGE C Burnished Brass

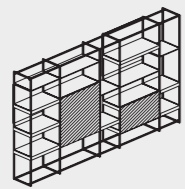

HEXAGON Seat made of Nabuck Mud 93, base made of Burnished Brass

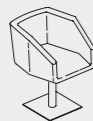

NOCE Nabuck Mud 93





OZONE Black Lake.

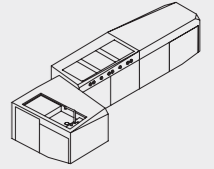

HEXAGON STOOL Seat made of E-Type Nero 3416, base made of Burnished Brass.



TEST-ONE Paonazzo Stone.



TEST-TWO Paonazzo Stone.



Custom Great Hall

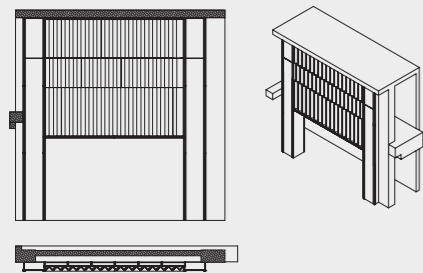

This image captures a breathtaking architectural installation entirely developed by Henge, rising nearly six meters in height and setting the tone for the entire space. The wall features a custom composition of vertical elements in Burnished Brass, precisely arranged to create a rhythm of volume, texture, and light.

Integrated lighting LED strips accentuate the geometry and materiality, adding depth and atmosphere to the room. Below, the transition opens onto a mirrored wall and a sculptural bar, framing the space with both elegance and functionality.

This dramatic feature wall is a perfect example of Henge's bespoke capabilities—where technical expertise, material mastery, and aesthetic vision come together to create unique, made-to-measure solutions that respond to the client's architectural and lifestyle needs.





STARLIGHT HORIZONTAL Black  
Burnished Brass, Sand Cast Bronze.

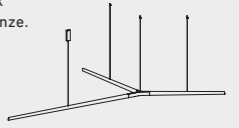

TWISTABLE Sand Cast Bronze,  
Burnished Titano.

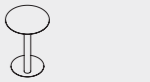

BE MINE Sandcasting Brass,  
Top: Shine Brass.



SR Brass Patina and Wild Onyx Stone.

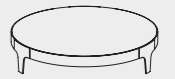

MUSHROOM Sand Cast Brass.

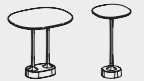

BLOWN OUT H-Piuma.

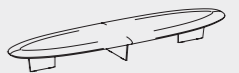



SPYDER X Burnished Brass, Black  
Burnished Brass.



SYNAPSE STR Onyx.



KETCH E-Type Natural 3451  
E-Type Gesso 3441.



Boiserie Custom  
(previous page)

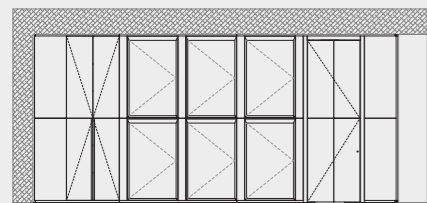

Picture on page 134-135.

This sophisticated installation demonstrates the seamless integration of Henge's architectural vision and functional design. Entirely developed by Henge, the wall system in burnished brass acts as a sculptural partition within the living space, concealing a discreet transition into a private wing of the residence. Hidden within its geometric rhythm is a pivot door that leads to a guest suite and bathroom, maintaining visual continuity while offering complete discretion.

To the left, the mirrored elements are part of a custom configuration of our Loom System, elegantly adapted for storage use. This intelligent integration not only enhances functionality but elevates the visual language of the space with reflective depth and compositional balance.





OZONE Cappuccino Marble.

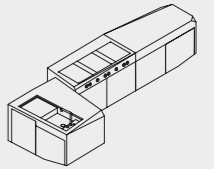

LIGHT RING HORIZONTAL Burnished Brass.

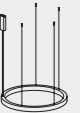

TED Top made of Forest Fusion  
Legs made of Cappuccino Marble with  
inserts in Burnished Brass.

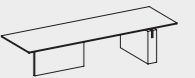

HEXAGON Nabuck Terra 91,  
Base in Burnished Brass.



A fully custom-designed kitchen wall unit developed by Henge, where material richness and architectural precision come together in perfect balance. The entire vertical system, crafted in burnished brass and integrated with reflective smoked glass panels, was conceived to offer both high functionality and a strong visual identity, seamlessly aligning with the design language of the surrounding interiors.

Behind the reflective surface, bespoke storage elements and display shelving have been carefully configured to meet the client's exact needs. The composition is punctuated by high-end appliances and a backlit preparation area, adding both utility and a refined glow that enhances the spatial atmosphere.

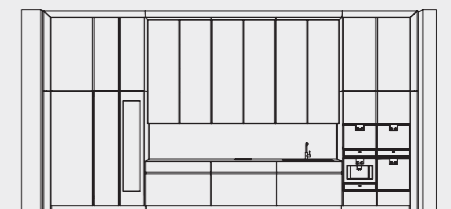

LIGHT RING HORIZONTAL POLYGONAL  
Burnished Brass.

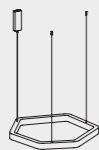

SCULPTURE Burnished Brass.

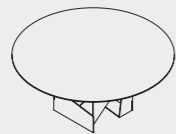

LINE JUST Burnished Brass.

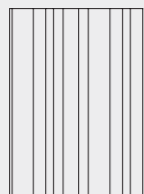

This image features a custom-made table designed and crafted by Henge to complement the refined architecture and material palette of its surroundings. The sculptural base, executed in burnished brass, forms a bold and geometric foundation that anchors the piece within the space, while the round tabletop, characterized by its tactile surface and subtle irregularity, adds depth and artisanal character.







SPYDER Borosilicate Glass, Metal  
parts made of Burnished Brass.



## Custom Door

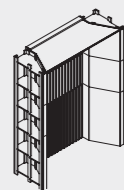
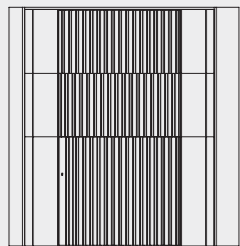

Bold in scale yet discreet in appearance, this 3.5-meter-high, 1.6-meter-wide pivot door is a striking example of how Henge reimagines architectural transitions. Entirely custom-made in burnished brass, its vertical composition is punctuated by integrated lighting elements that echo the rhythm of the surrounding wall system, allowing it to visually dissolve into the architecture when closed.

More than a visual statement, the door features a precision-engineered soft opening and closing mechanism, ensuring a seamless and silent user experience. Despite its generous dimensions, the motion is fluid and effortless, underscoring the balance between technical performance and refined design.



BIG BANG Sand Cast Bronze.



TEST-ONE Ice Onyx, Rapolano Stone



TEKE EVO Wild Onyx with Burnished Brass inserts.

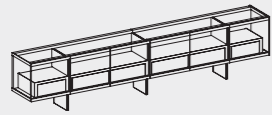

Spanning 6 meters in length and 3 meters in height, this custom wall installation by Henge defines the atmosphere of the master bedroom with quiet intensity and sculptural presence. Clad in Ice Onyx marble and framed with slim burnished brass profiles, the surface reveals the natural depth and tonal richness of the stone, elevated by an integrated backlighting system.

Fully dimmable, the light behind the marble allows for complete control of the mood, shifting from soft ambient tones to more dramatic highlights depending on the moment. Designed and engineered entirely by Henge, this wall is a clear expression of our approach to architectural integration, where material, proportion, and atmosphere come together in a solution tailored precisely to the space.

#### Custom TV Wall Master Bedroom

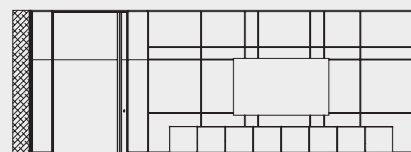





Designed specifically for the master bathroom, this custom-made double sink unit showcases Henge's ability to elevate functional elements into fully architectural features. Crafted in marble with a burnished brass base, the piece integrates discreetly into the surrounding space while anchoring it with material strength and elegance.

Above, a tailored metal structure in Burnished Brass supports two vertical mirrors, each framed by integrated lighting that provides both clarity and warmth.

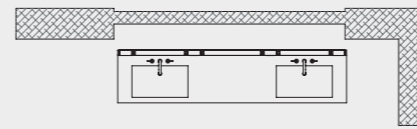
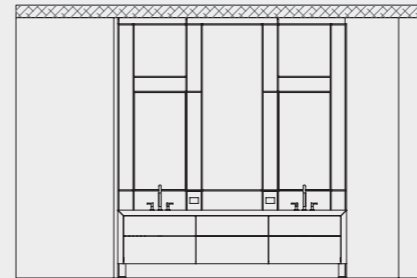

In this image, Henge's Edge Mirror, typically conceived as a decorative wall piece, has been reinterpreted and custom-engineered as a pivot door, demonstrating the brand's deep flexibility in adapting design icons to architectural needs.

Framed in burnished brass, the mirror retains its signature diagonal cuts and polished surfaces, offering both visual intrigue and functional clarity. Here, it becomes a concealed passage to the master bedroom dressing cabinet, merging seamlessly with the surrounding layout while adding a refined reflective element to the space.



At the center of the walk-in closet, this custom island unit serves as both a functional core and a sculptural anchor for the space. Crafted entirely in burnished brass, the piece exudes a warm, tactile richness that contrasts beautifully with the surrounding materials.

Thoughtfully designed for everyday use, the island offers multiple storage solutions, including two upper drawers with transparent glass tops, allowing curated visibility of accessories such as watches, ties, fragrances, and jewelry. Below, additional compartments provide versatile organization for other personal items.

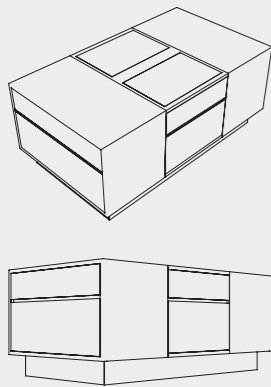



This custom vanity is a quiet celebration of personal ritual, bringing elegance and intention into the walk-in wardrobe. Built entirely in burnished brass, its geometric form anchors the space with understated strength, while offering thoughtful functionality through multiple drawers and compartments.

At the center, a trifold mirror with integrated vertical lighting ensures optimal visibility and atmosphere. Every element, from the proportions to the choice of materials, has been tailored to support daily gestures with grace and simplicity.

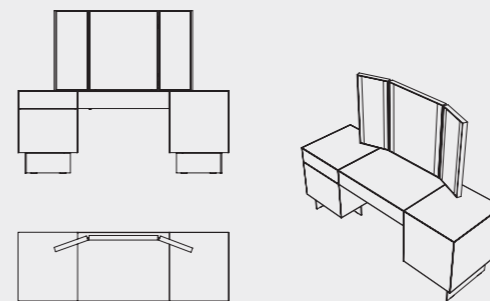

TAPE Burnished Brass.

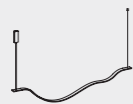



K-TABLE Eucalyptus Thermo Wood.

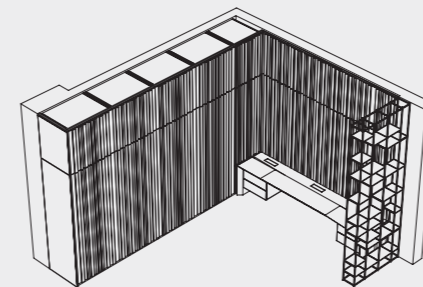
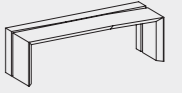

This bespoke installation exemplifies the seamless integration of architectural systems and refined furnishings. The K-Table, enhanced by a Bordeaux 35 leather writing pad, anchors the space with functionality and tactile elegance.

Surrounding it, custom cabinetry entirely clad in Shiny Copper and inserts in Oak Thermowood creates a bold yet harmonious visual language. The architectural structure, developed to fit the room's exact dimensions, incorporates a Cage Bookcase, adding depth and rhythm while optimizing vertical space.

The result is a fully immersive environment where storage, surfaces, and atmosphere converge into a unified, made-to-measure solution.



This private entertainment room was entirely developed by Henge, showcasing a complete architectural solution tailored to the client's vision of a space dedicated to cinema, games, and social moments. From the burnished brass ceiling to the Ice Onyx bar counter, every element has been crafted with precision and intention.

The architectural system includes a series of tall storage units behind the bar, fully clad in backlit Ice Onyx, forming a dramatic and luminous backdrop that enhances the depth and atmosphere of the space. This extraordinary level of customization reflects Henge's ability to push beyond conventional limits, transforming materials, proportions, and functions into made-to-measure environments where every detail is engineered to perfection.

JILL STOOL Sand cast Peltro, Mohair Gelso.



TELE Burnished Brass.

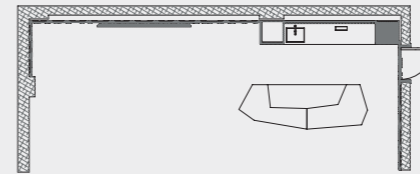
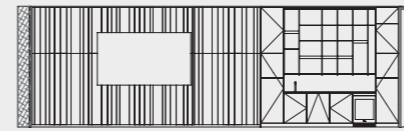



# PRODUCTS OVERVIEW

Be Mine

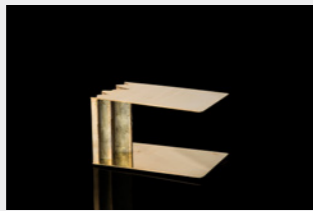

Jill Stool



Big Bang



Ketch

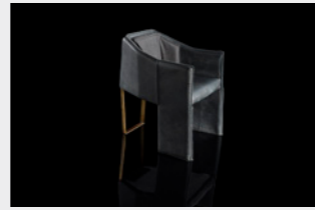

Blown Out



Light Ring Horizontal

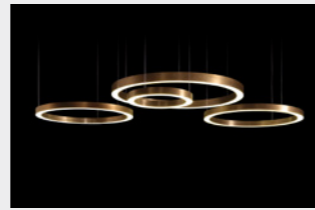

Hexagon

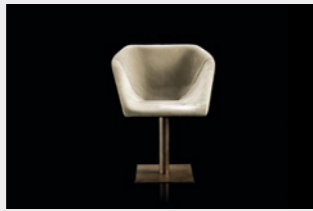

Light Ring Horizontal Polygonal

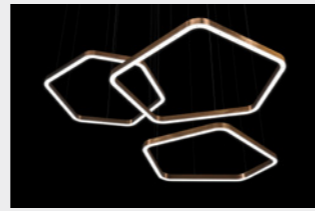

Hexagon Stool



Mushroom



Ozone



Ted

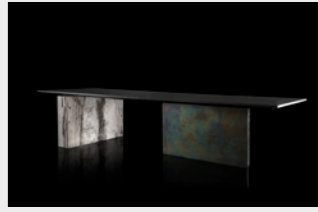

Spyder

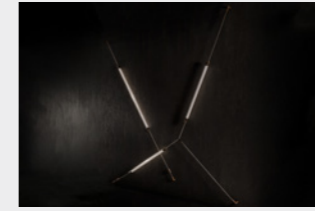

Teke Evo



Spyder X



Tele

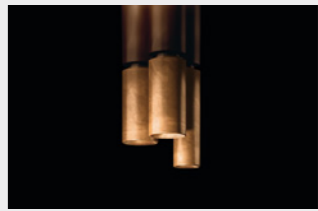

SR



Test-One



Starlight Horizontal

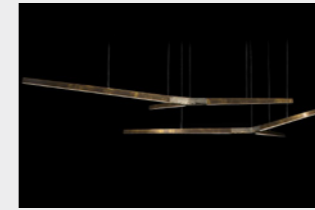

Test-Two

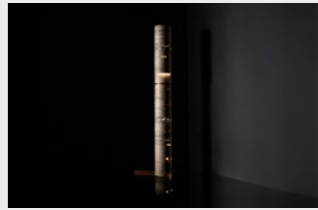

Synapse



Twistable

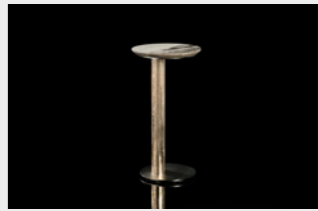

Tape

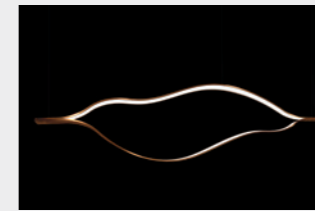



## H ISTRA

Europe

Set within a dense natural landscape, this private residence is conceived as a calm dialogue between architecture, interior design, and the surrounding forest. Contemporary volumes and tactile materials create spaces that feel grounded and intimate, with full-height glazing dissolving the boundary between indoors and outdoors.

Inside, a restrained palette is shaped by custom architectural elements and refined furnishings, where materiality and proportion define the atmosphere. Sculptural ceiling lighting traces the geometry of the rooms, while integrated shelving and storage systems add rhythm and depth without interrupting the clarity of the space.

Living areas unfold around low-profile seating and custom tables, framed by generous views into the trees. In the private zones, bedrooms and bathrooms follow the same philosophy: tailored compositions of stone, wood, upholstery, and integrated light, designed to enhance comfort while preserving architectural precision.

The result is a coherent, timeless environment where every detail contributes to a quiet sense of presence and balance.

### CREDITS

Arch Olga Stupenko

COFFEE TABLES	SR Monolith Puddle Twistable High
TABLES	K-Table
LIGHTING	Light Ring Horizontal Polygonal Skyfall Crystal Evo Starlight Horizontal Wall Clips
CHAIRS	Zagg
SIDEBOARDS	Teke Evo Loom FR
BOOKSHELVES	Cage Layer Style Set Bistrot
SOFAS	Radical Opus Radical Armchair
KITCHENS	Ozone

Some of the pieces shown are from past collections or custom creations. Only current designs include a QR code for further information.



LIGHT RING HORIZONTAL POLYGONAL  
Black Burnished Steel

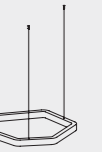

SR Brass Patina - Black Lake top

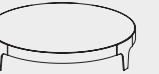

TWISTABLE HIGH Burnished Platino  
Sand Cast Bronze

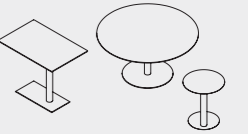

OPUS Camoscio Natural leather color 31

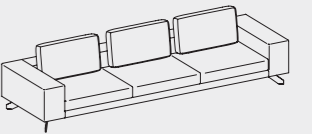

BISTROT Burnished Platino

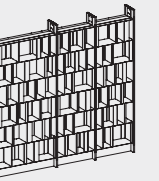



RADICAL E-Type leather. Color Black 3416.

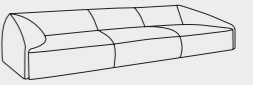

CAGE B Frame made of Burnished Brass  
Shelving made of Eucalyptus Thermowood

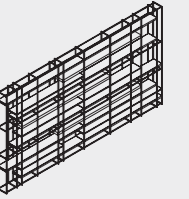

MONOLITH Burnished Brass

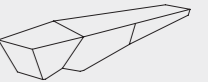

TEKE Frame made of Black Burnished Steel  
SBW Stone drawers.

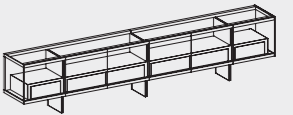

STARLIGHT HORIZONTAL Burnished Brass  
Sand Cast Brass

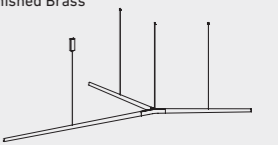

TWISTABLE Burnished Titano  
Sand Cast Bronze  
Top in Black Lake marble

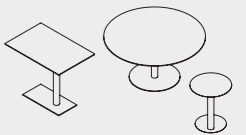

RADICAL E-Type leather. Color Black 3416.

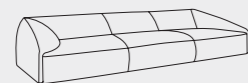

CAGE B Frame made of Burnished Brass  
Shelving made of Eucalyptus Thermowood

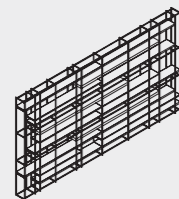

MONOLITH Burnished Brass



OZONE Black Lake Marble

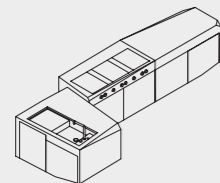

SKYFALL



ZAGG Camoscio Natural Leather Color 31

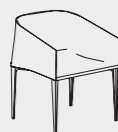

CRYSTAL White Crystal

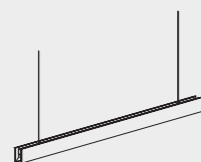

K-TABLE Eucalyptus Thermowood

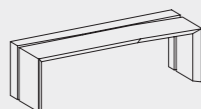

CUSTOM TALL UNIT Burnished Brass  
Top in Black Lake Marble

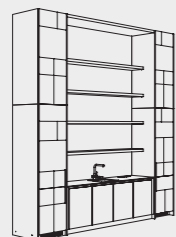



CRYSTAL White Crystal

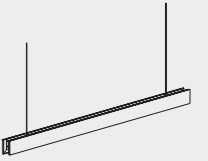

ZAGG Camoscio Natural Leather Color 31



K-TABLE Eucalyptus Thermowood



LOOM SYSTEM Structure made of Eucalyptus Thermowood  
Frontal frame made of Burnished Brass

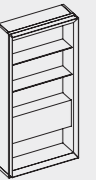



LIGHT RING HORIZONTAL POLYGONAL  
Black Burnished Steel

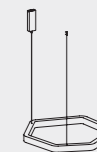

SR Brass Patina - Black Lake top

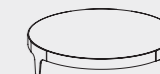

OPUS Camoscio Natural leather color 31

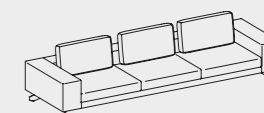

BISTR0T Burnished Platino

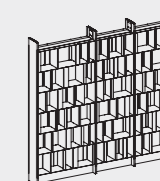

RADICAL ARMCHAIR E-type leather  
color black 3416

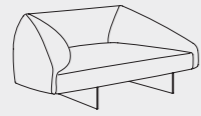

MONOLITH Burnished Brass



STARLIGHT HORIZONTAL  
Burnished Brass - Sand Cast Brass

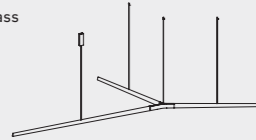



WALL CLIPS Silver Patina

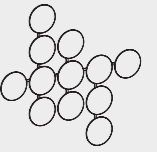

PUDDLE Sand Cast Brass

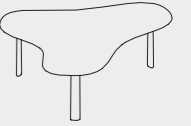

STYLE SET Black Eucalyptus Thermowood  
Partitions made of Burnished Platino  
and Silver Patina

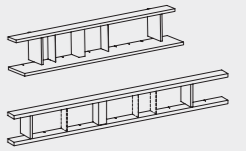

Custom Master Bed  
Made of Phantom Black with inserts  
in Burnished Titano





CAGE C  
Custom Cage C adapted for wardrobe  
Burnished Brass - Shelving and storage made of  
Eucalyptus Thermowood

BAT  
Burnished Brass





PRODUCTS OVERVIEW

SR



Light Ring Horizontal Polygonal



Skyfall

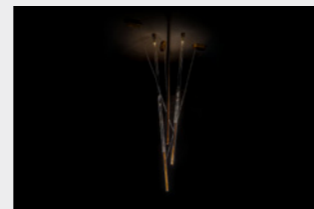

Cage Layer

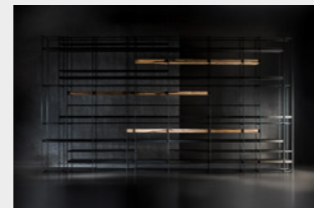

Puddle



Teke Evo

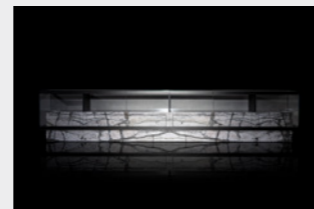

Monolith

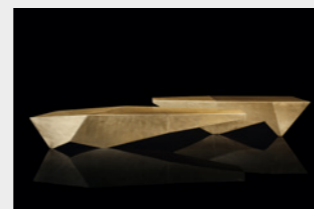

Style Set



Bistrot



Crystal Evo



Loom FR

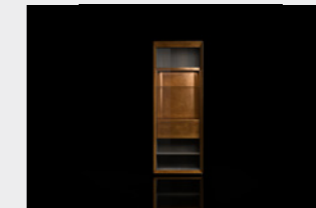

Starlight Horizontal



Opus



K-Table



Twistable High



Ozone

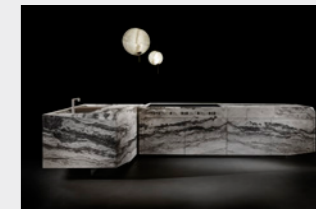

Zagg

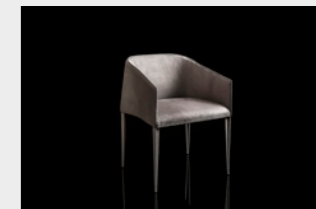

Radical Armchair



Wall Clips

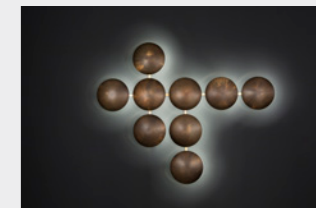

Radical



## PROJECTS OVERVIEW

## PROJECTS OVERVIEW



### VILLA CÔTE D'AZUR

Cannes, FR

p. 18



### HORIZON PENTHOUSE

Frankfurt, DE

p. 36



### LA SERENISSIMA

Venice, IT

p. 52



### HENGE CHALET

Cortina, IT

p. 74



CHAIRS AND STOOLS	Hexagon Stool Ex-Tra
TABLES	Synapse
LIGHTING	Light Ring Polygonal Evo Light Ring Horizontal XS Abaco Tubular (Solo Version) Flat Tele Light
BOOKCASES	Bistrot Loom System
COFFEE TABLES	SR Primitive Pebble
SOFAS AND ARMCHAIRS	Vertigo Opus S Perla
NIGHT COLLECTION	Noctis Bed
ARCHITECTURAL SYSTEM	Linejust

TABLES	Time Synapse
BOOKCASES	Cage B
LIGHTING	Superb-All Tape
KITCHEN & KITCHEN UNITS	Oneon Quadrant Tall Units Loom System Winery
ARCHITECTURAL SYSTEM	Checkmate

COFFEE TABLES	SR Big Bang Twistable
TABLES	Ted Zenith Shift LY
LIGHTING	Light Ring Polygonal Evo Flat Pipe
CHAIRS	Ketch Hexagon
SOFAS	Downtown
NIGHT COLLECTION	Noctis Bed
SIDEBOARDS	Slim Side Upperside
BOOKCASES	Cage Layer Bistrot Horizontal

CHAIRS AND STOOLS	Strip
TABLES	Sisma Gotham
LIGHTING	Test One Crystal
COFFEE TABLES	Origami SR
SOFAS AND ARMCHAIRS	Downtown Bug Gelly Pouf Tambourine
ACCESSORIES	Himalaya

## PROJECTS OVERVIEW



### CHALET EDELWEISS

Kitzbühel, AUT

p. 92



### HILLSIDE

Los Angeles, US

p. 108



### PRANA MANSION

Asia

p. 124



### H ISTR A

Europe

p. 168

CHAIRS AND STOOLS	Strip Ex-Tra
LIGHTING	Tubular (Solo Version) Flat Flat Table Starlight
COFFEE TABLES	Primitive Be Mine Twistable
SOFAS AND ARMCHAIRS	RF Lailand Gelly Pouf
CABINETS	Slim Side Vertical

CHAIRS AND STOOLS	Rio Stool Strip Ex-Tra
TABLES	K-Table Soprano
LIGHTING	Light Ring Polygonal Starlight Horizontal Tape Tubular Horizontal
BOOKCASES	Cage B
COFFEE TABLES	D-Code Mushrooms Touch
SOFAS AND ARMCHAIRS	Lailand Radical
CABINETS	B-Side

COFFEE TABLES	Blown Out Be Mine Big Bang Mushroom	Monolith SR Twistable
TABLES	Synapse Ted Shift Lounge Table Time	
LIGHTING	Spyder Spyder X Tape Tele Tubular Light Flat Lamp Gladio	Test-One Test-Two Light Ring Horizontal Light Ring Horizontal Polygonal Starlight Horizontal
CHAIRS	Ketch Ketch Armchair Hexagon Stool	Hexagon Jill Stool Strip Lounge Chair
SIDEBOARDS	Teke	
BOOKSHELVES	Cage C Bistrot	
SOFAS	Lailand	
KITCHENS	Ozone Ice Onyx Backlit Custom Bar	

COFFEE TABLES	SR Monolith Puddle Twistable High
TABLES	K-Table
LIGHTING	Light Ring Horizontal Polygonal Skyfall Crystal Evo Starlight Horizontal Wall Clips
CHAIRS	Zagg
SIDEBOARDS	Teke Evo Loom FR
BOOKSHELVES	Cage Layer Style Set Bistrot
SOFAS	Radical Opus Radical Armchair
KITCHENS	Ozone

ARCHITECTURE BEGINS WITH VISION.  
DESIGN GIVES IT SHAPE.  
MATERIAL GIVES IT PRESENCE.

FOR ARCHITECTS AND DESIGNERS WHO BELIEVE  
IN PROJECTS THAT LEAVE A MARK,  
THE NEXT SPACE IS READY TO TAKE FORM.

# HENGE

Henge Headquarters  
Via Fossa 1  
31051 Follina (TV) — Italy

[www.henge07.com](http://www.henge07.com)

HENGE MILAN  
Via della Spiga 34  
20121 Milano (MI) — Italy

T +39 0438 1710600  
[atelier@henge07.com](mailto:atelier@henge07.com)

HENGE LONDON  
254 Brompton Rd, South  
Kensington, London SW3 2AS,  
United Kingdom

+44 20 3514 9530  
[hengelondon@hengeuk.co.uk](mailto:hengelondon@hengeuk.co.uk)

HENGE DUBAI  
831 Jumeira Street  
Dubai, United Arab Emirates

+971 4 393 4733  
[hengedubai@internionline.it](mailto:hengedubai@internionline.it)

HENGE MIAMI  
4141 NE 2nd Avenue Suite 99  
Miami, Florida, United States

+1 305 546 0646  
[info@hengemiami.com](mailto:info@hengemiami.com)

HENGE SHENZHEN  
Domus Tiandi  
Room S223/S315/S218, Number  
5001 Huanggang Road  
Upper Hills District, Shenzhen  
China

+86 0755 8899 9995  
[info@domustiandi.com](mailto:info@domustiandi.com)

# DRAFT

HENGE SUITE  
By Treutlein

Breidenbacher Hof  
Königsallee 11, 40212  
Düsseldorf, Germany

+49 (211) 838 686 28  
[showroom@patrick-treutlein.de](mailto:showroom@patrick-treutlein.de)

HENGE SUITE  
Rosapetra SPA Resort

Località Zuel di Sopra, 1, 32043  
Cortina d'Ampezzo BL

PRODUCT DESIGN BY  
Massimo Castagna  
Ugo Cacciatori  
Isabella Genovese  
Yabu Pushelberg  
Davide Nascimbeni

GRAPHIC DESIGN  
Studiogusto

PRINTED BY  
Grafiche Antiga

AMSTERDAM ATHENS AUCKLAND BANGKOK BARCELONA BEIJING BEIRUT BERLIN BOSTON BRUXELLES BUDAPEST CANNES  
CASABLANCA CHICAGO COLOGNE COPENHAGEN CYPRUS DOHA DUBAI DÜSSELDORF FRANKFURT HOUSTON ISTANBUL JAKARTA  
JOHANNESBURG KITZBUHEL LINZ LONDON LOS ANGELES MADRID MANILA MARBELLA MELBOURNE MEXICO CITY MIAMI MILAN  
MONTECARLO MOSCOW MUMBAI MUNICH NEW YORK CITY PALMA DE MALLORCA PANAMA CITY PARIS PRAGUE ROME SALZBURG SAINT  
PETERSBURG SEATTLE SEOUL SHANGHAI SHENZHEN SOFIA STUTTGART TAIPEI TEL AVIV TOKYO TORONTO VENICE WARSAW ZURICH

