

THE COLLECTION

TUFTY-TIME 20,
METROPOLITAN RELAX,

CHARLES,
JACK.



Sofas, Seating systems, Chaise longue,
Armchairs, Ottomans, Tables, Chairs,
Small tables and Complements.

B&B
ITALIA

Le collezioni di B&B Italia sono interpretate
attraverso il racconto di uno stile di vita
contemporaneo.

The B&B Italia collections are interpreted
through the story of a contemporary lifestyle.

B&B
ITALIA

- 006 **Tufty-Time 20**
design Patricia Urquiola
- 008 **Tufty-Time 20, Composition 1**
divano componibile /modular sofa,
tavolo basso /low table
Fat-Fat tavolino /small table
Frank pouf /ottoman
J.J. poltrona /armchair
Landscape chaise longue
- 014 **Tufty-Time 20, Composition 2**
divano componibile /modular sofa,
pouf /ottoman, tavolino /small table
Metropolitan Relax
poltrona /armchair
Fat-Fat & Lady-Fat
tavolino /small table
- 020 **Tufty-Time 20, Composition 3**
divano componibile /modular sofa,
pouf /ottoman
Grande Papilio poltrona /armchair,
pouf /ottoman
Surface tavolino /small table
Hive pouf /ottoman
Spool tavolino /small table
Allure O' tavolo /table
Flair O' sedia /chair
- 024 **Tufty-Time 20, Composition 4**
divano componibile /modular sofa
Alanda '18 tavolo basso /low table
Harbor poltrona /armchair,
pouf /ottoman
Spool tavolino /small table
Husk Outdoor tavolino /small table
Mirto Indoor consolle /console

- 032 **Charles**
design Antonio Citterio
- 034 **Charles, Composition 1**
divano componibile /modular sofa,
dormeuse, consolle /console
Diesis tavolo basso /low table
Frank pouf /ottoman
Mart poltrona /armchair
Frank tavolino /small table
Cozy tavolino /small table
Spool tavolino /small table
Harry Large pouf /ottoman
Jack libreria /bookcase
- 040 **Charles, Composition 2**
chaise longue, dormeuse
Diesis tavolo basso /low table
Frank '12 elemento di servizio
/service element
Eileen tavolino /small table
Frank tavolino /small table
Mera tavolino /small table
- 048 **Charles, Composition 3**
divano componibile /modular sofa,
chaise longue
Diesis tavolo basso /low table
Clio (Maxalto) poltrona /armchair
Mirto Indoor tavolino /small table
Mera tavolino /small table
Loto (Maxalto) tavolino /small table
Chinotto (Azucena) poltroncina
/small armchair
Monachella (Azucena) lampada /lamp
- 052 **Charles, Composition 4**
divano componibile /modular sofa,
panca /bench, consolle /console
Mart poltrona /armchair
Cilindro (Azucena) pouf /ottoman
Mera tavolino /small table
Lithos (Maxalto) tavolino /small table
Jack libreria /bookcase
Fat-Fat vassoio /tray
Imbuto (Azucena) lampada /lamp
- 058 **Charles, Composition 5**
divano componibile /modular sofa,
panca /bench, console
Beverly '14 poltrona /armchair
Frank tavolino /small table
Andy '13 pouf /ottoman
Imbuto (Azucena) lampada /lamp

- 062 **Charles, Composition 6**
Charles Carré divano /sofa
Charles panca /bench
Diesis tavolo basso /low table
Frank pouf /ottoman
Eileen tavolino /small table
Jack libreria /bookcase
Mida (Maxalto) contenitore
/storage unit
- 076 **Metropolitan Relax**
design Jeffrey Bennett
- 078 **Metropolitan Relax**
poltrona /armchair
Fat-Fat tavolino /small table
- 082 **Jack**
design Michael Anastassiades
- 084 **Jack, Composition 1**
libreria /bookcase
Alex tavolo /table
Jens sedia /chair
Charles divano componibile
/modular sofa
- 088 **Jack, Composition 2**
libreria /bookcase
Charles divano componibile
/modular sofa
Harry Large pouf /ottoman
- 092 **Jack, Composition 3**
libreria /bookcase
Charles Large Carré divano /sofa
Mida (Maxalto) contenitore
/storage unit

Technical reference

- 028 **Tufty-Time 20**
068 **Charles**
070 **Charles Carré**
072 **Charles Large**
073 **Charles Large Carré**
081 **Metropolitan Relax**
093 **Jack**

La casa come un sistema di relazioni e proporzioni
che rispecchiano un ideale di armonia.

The home as a system of relationships and
proportions that reflect an ideal of harmony.

Tufty-Time 20 – Patricia Urquiola

Tufty-Time 20 rappresenta l'evoluzione contemporanea di Tufty-Time, l'iconico sistema di divani disegnato da Patricia Urquiola nel 2005. A vent'anni dal lancio, il sistema è stato reinterpretato mantenendo le caratteristiche essenziali che ne hanno decretato il grande successo, tra cui modularità, comfort avvolgente e flessibilità compositiva. I volumi, le imbottiture e l'altezza della seduta sono stati riprogettati per offrire un comfort ancora maggiore, mentre l'introduzione di un modulo curvo amplia il potenziale del sistema, dando vita a configurazioni ancora più fluide e conviviali, ideali sia per ambienti residenziali che per spazi contract. Un'attenzione particolare è stata riservata al tema della circolarità. Tufty-Time 20 è infatti completamente disassemblabile così che tutti i suoi componenti possano essere recuperati alla fine del ciclo di vita del prodotto.

Tufty-Time 20 represents the contemporary evolution of Tufty-Time, the iconic sofa system designed by Patricia Urquiola in 2005. Twenty years after its launch, the system has been reinterpreted while maintaining the essential characteristics that have decreed its great success, including modularity, enveloping comfort and compositional flexibility. The volumes, upholstery and seat height have been redesigned to offer even greater comfort, while the introduction of a curved module expands the system's potential, creating even more fluid and convivial configurations, ideal for both residential and contract spaces. Special attention has been paid to the theme of circularity. Tufty-Time 20 is in fact completely disassemblable so that all its components can be recovered at the end of the product's life cycle.



Composition 1

divano componibile / modular sofa, tavolino / small table **Tufty-Time 20**
tavolino / small table **Fat-Fat** – pouf / ottoman **Frank**
poltrona / armchair **J.J.** – chaise longue **Landscape**



Composition 1 / Tufty-Time 20

- 1. Elemento angolare sinistro con bracciolo alto TY115_3S
- 2. Elemento di servizio TY60L
- 3. Elemento centrale curvo TY140CV_3
- 4. Pouf curvo TY140PV_3
- 5. Tavolino TYT110QL
- 6. Tavolino TYT70Q_AL
- 7. Tavolino TYT70Q_A

- 1. Left corner element with high armrest TY115_3S
- 2. Service element TY60L
- 3. Curved central element TY140CV_3
- 4. Curved ottoman TY140PV_3
- 5. Small table TYT110QL
- 6. Small table TYT70Q_AL
- 7. Small table TYT70Q_A

30 mq – 322,92 sq ft

500 cm – 196 7/8"

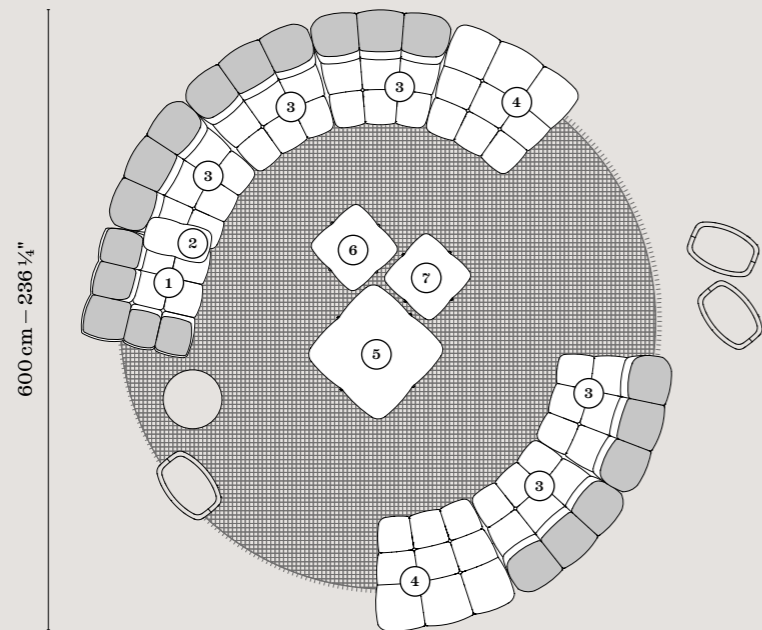



012

The Collection

divano componibile / modular sofa, tavolino / small table **Tufty-Time 20**
tavolino / small table **Fat-Fat** - pouf / ottoman **Frank**



013

Tufty-Time 20

Composition 2

divano componibile / modular sofa, pouf / ottoman, tavolino / small table **Tufty-Time 20**
poltrona / armchair **Metropolitan Relax** – tavolino / small table **Fat-Fat & Lady-Fat**



Composition 2 / Tufty-Time 20

1. Elemento terminale sinistro con bracciolo basso TY149BS_4
2. Elemento centrale TY108C_3
3. Elemento di servizio TY60_AL
4. Elemento centrale curvo TY140CV_3
5. Elemento terminale destro con bracciolo basso TY115BD_3
6. Elemento terminale-pouf destro TY115TPD_3
7. Elemento terminale-pouf sinistro TY115TPS_3
8. Tavolino TYT60_A
9. Pouf TY108P_3

1. Left terminal element with low armrest TY149BS_4
2. Central element TY108C_3
3. Service element TY60_AL
4. Curved central element TY140CV_3
5. Right end element with low armrest TY115BD_3
6. Right ottoman-terminal element TY115TPD_3
7. Left ottoman-terminal element TY115TPS_3
8. Small table TYT60_A
9. Ottoman TY108P_3

35 mq – 376,74 sq ft

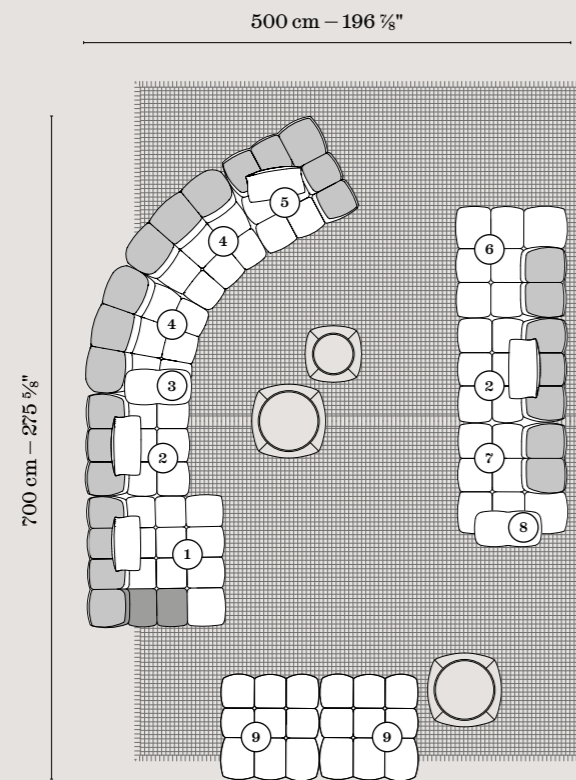

Ogni progetto custodisce l'intento di restituire
bellezza e misura al mondo in cui viviamo.

Every project aims to restore beauty and balance
to the world we live in.



Composition 3

divano componibile / modular sofa, pouf / ottoman **Tufty-Time 20**
poltrona / armchair, pouf / ottoman **Grande Papilio**
tavolino / small table **Surface** – pouf / ottoman **Hive** – tavolino / small table **Spool**
tavolo / table **Allure O'** – sedia / chair **Flair O'**



Composition 3 / Tufty-Time 20

1. Elemento terminale sinistro con bracciolo basso TY183BS_3
2. Elemento terminale destro con bracciolo basso TY183BD_3
3. Elemento terminale-pouf destro TY115TPD_3
4. Elemento di servizio TY60
5. Elemento centrale TY108C_3
6. Elemento terminale-pouf sinistro TY115TPS_3
7. Pouf TY108P_3

1. Left terminal element with low armrest TY183BS_3
2. Right terminal element with low armrest TY183BD_3
3. Right ottoman-terminal element TY115TPD_3
4. Service element TY60
5. Central element TY108C_3
6. Left ottoman-terminal element TY115TPS_3
7. Ottoman TY108P_3

25 mq – 269,1 sq ft

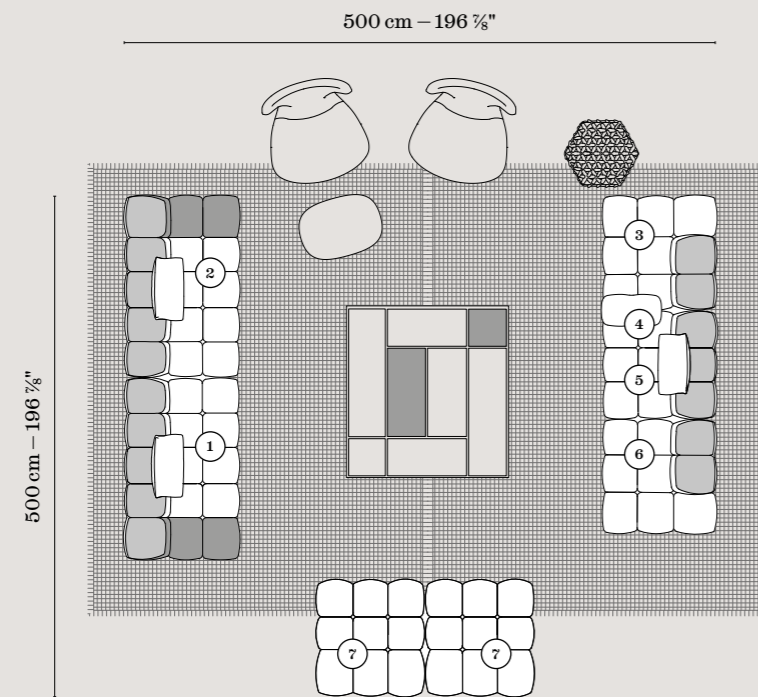

Composition 4

divano componibile / modular sofa **Tufty-Time 20**
tavolo basso / low table **Alanda '18** – poltrona / armchair, pouf / ottoman **Harbor**
tavolino / small table **Spool** – tavolino / small table **Husk Outdoor**
consolle / console **Mirto Indoor**



Composition 4 / Tufty-Time 20

- 1. Elemento terminale destro con bracciolo basso TY149BD_4
- 2. Elemento centrale TY108C_3
- 3. Elemento terminale-pouf destro TY115TPD_3
- 4. Pouf TY108P_3
- 5. Elemento terminale-pouf sinistro TY115TPS_3

- 1. Right end element with low armrest TY149BD_4
- 2. Central element TY108C_3
- 3. Right ottoman-terminal element TY115TPD_3
- 4. Ottoman TY108P_3
- 5. Left ottoman-terminal element TY115TPS_3

17,5 mq – 188,37 sq ft

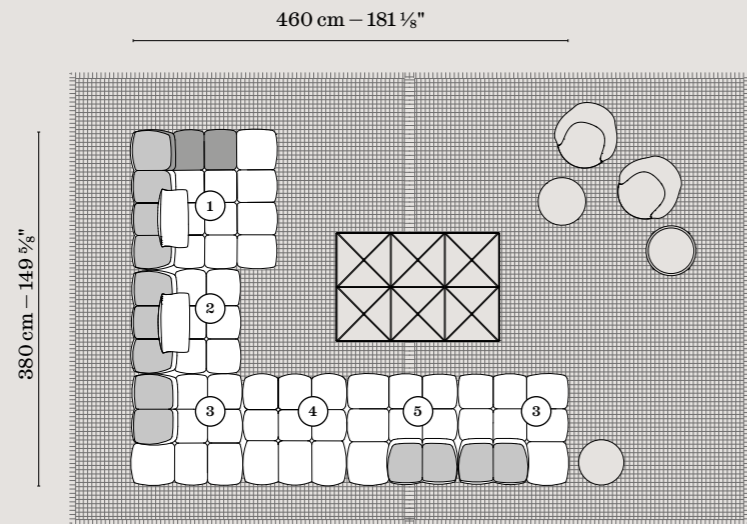

TY108C_3

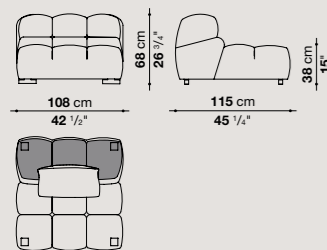

TY115_3S / TY115_3D

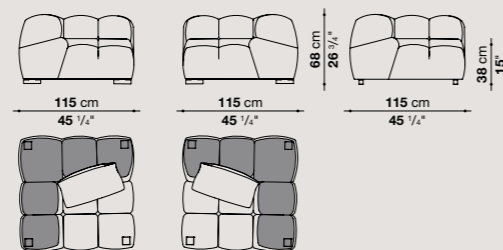

TY60

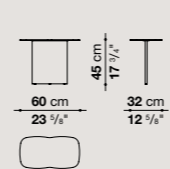

TY60L

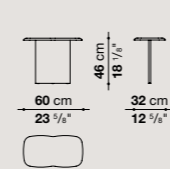

TYT60_A

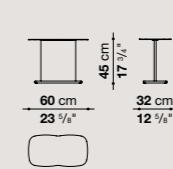

TYT60_AL

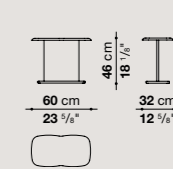

TY115BS_3 / TY115BD_3

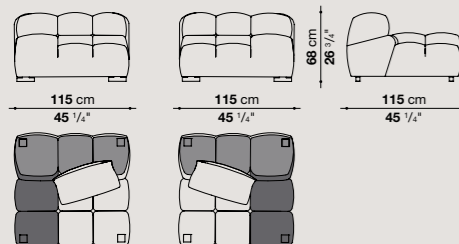

TY115TPS_3 / TY115TPD_3

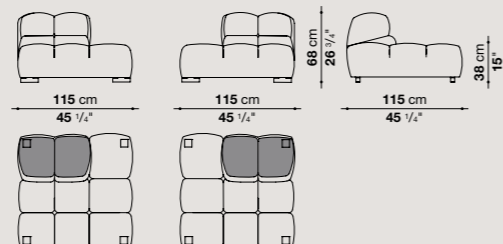

TYT70Q_A

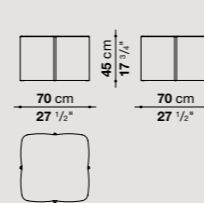

TYT70Q_AL

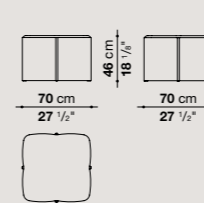

TYT70Q_B

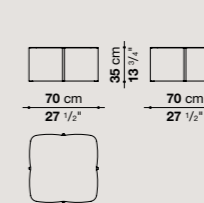

TYT70Q_BL

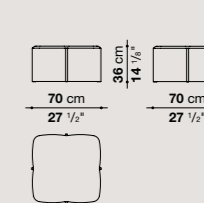

TY149BS_4 / TY149BD_4

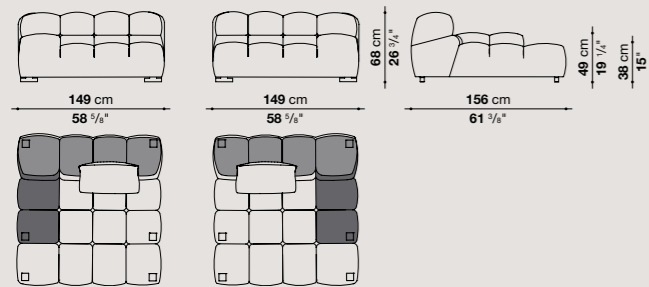

TY183BS_3 / TY183BD_3

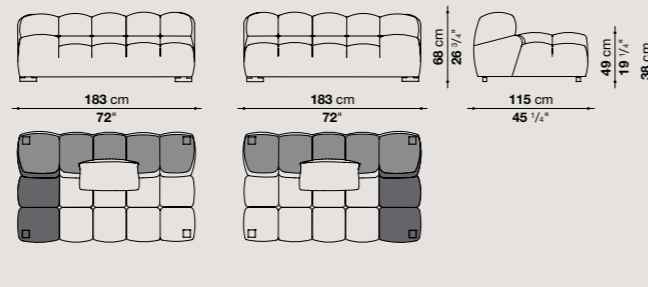

TYT110Q

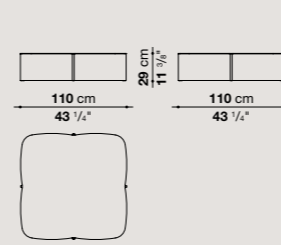

TYT110QL

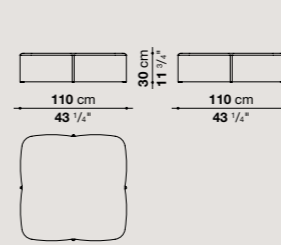

TY140CV_3

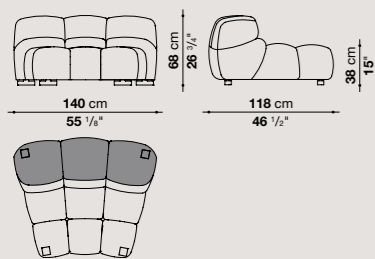

TY140PV_3

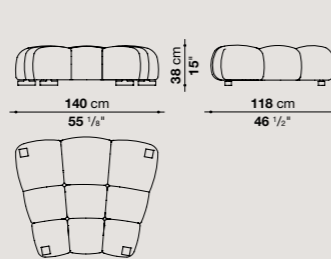

TY108P_3

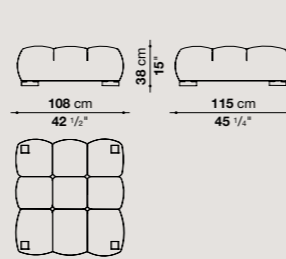

Una narrazione che non si pronuncia, ma si percepisce: lungo le linee, sulle superfici, negli istanti che separano le forme.

A narrative that is not spoken, but perceived along the lines, on the surfaces, in the moments that separate the shapes.

Charles – Antonio Citterio

Icona del design contemporaneo, il divano Charles si contraddistingue per l'immagine leggera accentuata dal disegno essenziale dei piedini a forma di "L" rovesciata in pressofusione di alluminio che, insieme al disegno del bracciolo, al cuscino unico del sedile e a quelli liberi appoggiati allo schienale, è l'elemento distintivo della linea. La sua forma aerea e il segno semplicissimo lo rendono, quasi per contrapposto, estremamente ricco e innovativo sotto il profilo spaziale: un sistema con cui creare sempre nuove composizioni, dal divano lineare due o tre posti seduto al divano con chaise longue al divano angolare. Charles svela una grande eleganza formale che va al di là del tempo e delle mode. Una proposta in grado di rispondere a qualsiasi richiesta arredativa, per un comfort a propria misura, grazie al vasto numero di elementi che compongono la famiglia. Il rivestimento è in tessuto o pelle.

An icon of contemporary design, the Charles sofa is distinguished by its light image accentuated by the essential design of the upside-down "L" shaped feet in die-cast aluminium which, together with the design of the armrest, the single seat cushion and the free cushions resting on the backrest, is the distinctive element of the line. Its aerial shape and very simple sign make it, almost by contrast, extremely rich and innovative from a spatial point of view: a system with which to create ever new compositions, from the linear two or three-seater sofa to the sofa with chaise longue to the corner sofa. Charles reveals a great formal elegance that transcends time and fashion. A proposal capable of responding to any furnishing request, for comfort to your own measure, thanks to the vast number of elements that make up the family. Upholstery is in fabric or leather.



Composition 1

divano componibile / modular sofa, dormeuse,
consolle / console **Charles, Charles Large**
tavolo basso / low table **Diesis** – pouf / ottoman **Frank**
poltrona / armchair **Mart** – tavolino / small table **Frank**
tavolino / small table **Cozy** – tavolino / small table **Spool**
pouf / ottoman **Harry Large** – libreria / bookcase **Jack**



Composition 1 / Charles, Charles Large

- 1. Dormeuse CH180L
- 2. Chaise longue destra CHL135LS
- 3. Tavolo basso TCH228
- 4. Chaise longue CH228L
- 5. Elemento terminale-pouf sinistro CH228TPS
- 6. Panca CH228P
- 7. Elemento terminale destro CH156D
- 8. Consolle CHC156

- 1. Dormeuse CH180L
- 2. Right chaise longue CHL135LS
- 3. Low table TCH228
- 4. Chaise longue CH228L
- 5. Left ottoman-terminal element CH228TPS
- 6. Bench CH228P
- 7. Right terminal element CH156D
- 8. Console CHC156

35 mq – 376,74 sq ft

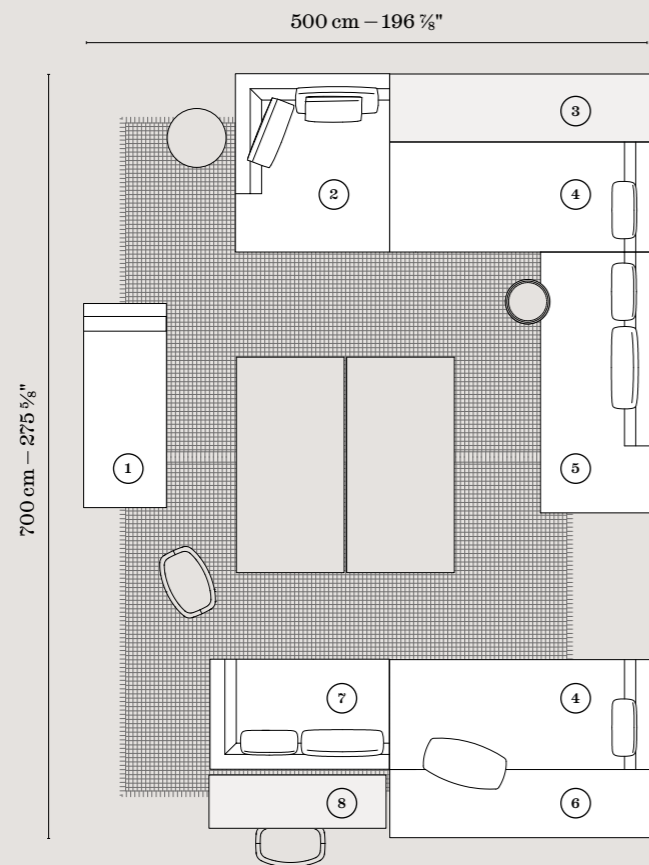



038

The Collection

divano componibile / modular sofa **Charles, Charles Large**
consolle / console **Charles** – tavolo basso / low table **Charles**



039

Charles

Composition 2

chaise longue **Charles Large** – dormeuse **Charles**
tavolo basso / low table **Diesis** – tavolino / small table **Eileen**
elemento di servizio / service element **Frank '12**
tavolino / small table **Frank** – tavolino / small table **Mera**



Composition 2 / Charles, Charles Large

- 1. Chaise longue sinistra CHL247LS_1
- 2. Dormeuse CH180L
- 3. Chaise longue destra CHL247LD_1

- 1. Left chaise longue CHL247LS_1
- 2. Dormeuse CH180L
- 3. Right chaise longue CHL247LD_1

20 mq – 215,28 sq ft

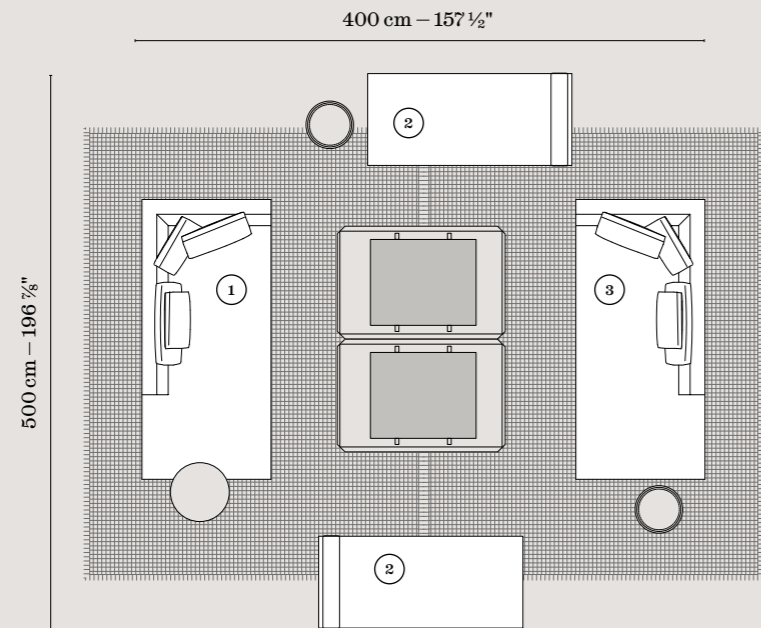



Una filosofia dell'abitare che lascia spazio alla trasparenza, alla leggerezza, all'immaginazione.

A philosophy of living that leaves room for transparency, lightness and imagination.



Composition 3

divano componibile / modular sofa **Charles, Charles Large**
chaise longue **Charles** – tavolo basso / low table **Diesis**
poltrona / armchair **Clio** (Maxalto) – tavolino / small table **Mirto Indoor**
tavolino / small table **Mera** – tavolino / small table **Loto** (Maxalto)
poltroncina / small armchair **Chinotto** (Azucena)
lampada / lamp **Monachella** (Azucena)



Composition 3 / Charles, Charles Large

- 1. Chaise longue destra CH228LD
- 2. Chaise longue destra CHL135LD
- 3. Chaise longue CH228L

- 1. Right chaise longue CH228LD
- 2. Right chaise longue CHL135LD
- 3. Chaise longue CH228L

11 mq – 118,4 sq ft

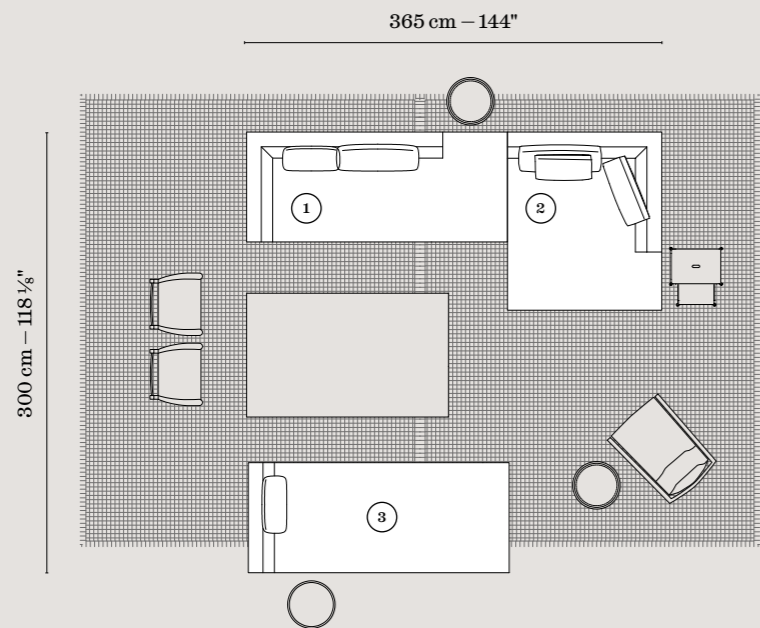

Composition 4

divano componibile / modular sofa **Charles, Charles Large**
panca / bench **Charles** – consolle / console **Charles** – poltrona / armchair **Mart**
pouf / ottoman **Cilindro** (Azucena) – tavolino / small table **Mera**
tavolino / small table **Lithos** (Maxalto) – libreria / bookcase **Jack**
vassoio / tray **Fat-Fat** – lampada / lamp **Imbuto** (Azucena)



Composition 4 / Charles, Charles Large

- 1. Chaise longue sinistra CHL247LS_1
- 2. Elemento terminale destro CHL247D_1
- 3. Panca CH228P
- 4. Consolle CHC156

- 1. Left chaise longue CHL247LS_1
- 2. Right terminal element CHL247D_1
- 3. Bench CH228P
- 4. Console CHC156

14 mq – 150,69 sq ft

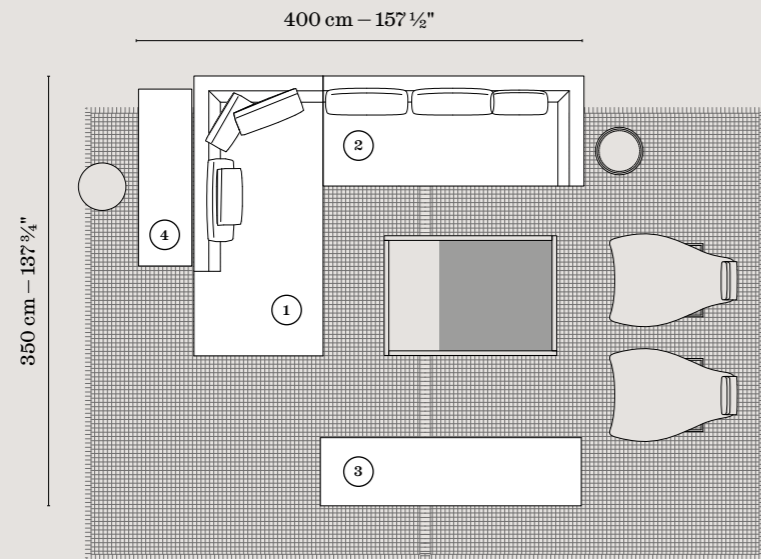

Dietro l'essenzialità si rivela la profondità del pensiero, la ricerca di un equilibrio ideale.

Behind the simplicity lies the depth of thought, the search for an ideal balance.



Composition 5

divano componibile / modular sofa **Charles, Charles Large**
panca / bench **Charles** – poltrona / armchair **Beverly '14**
tavolino / small table **Frank** – pouf / ottoman **Andy '13**
lampada / lamp **Imbuto** (Azucena)



Composition 5 / Charles, Charles Large

- 1. Chaise longue sinistra CHL247LS_1
- 2. Elemento centrale CH228C
- 3. Chaise longue destra CHL247LD_1
- 4. Panca CH228P
- 5. Consolle CHC228

- 1. Left chaise longue CHL247LS_1
- 2. Central element CH228C
- 3. Right chaise longue CHL247LD_1
- 4. Bench CH228P
- 5. Console CHC228

18 mq – 193,75 sq ft

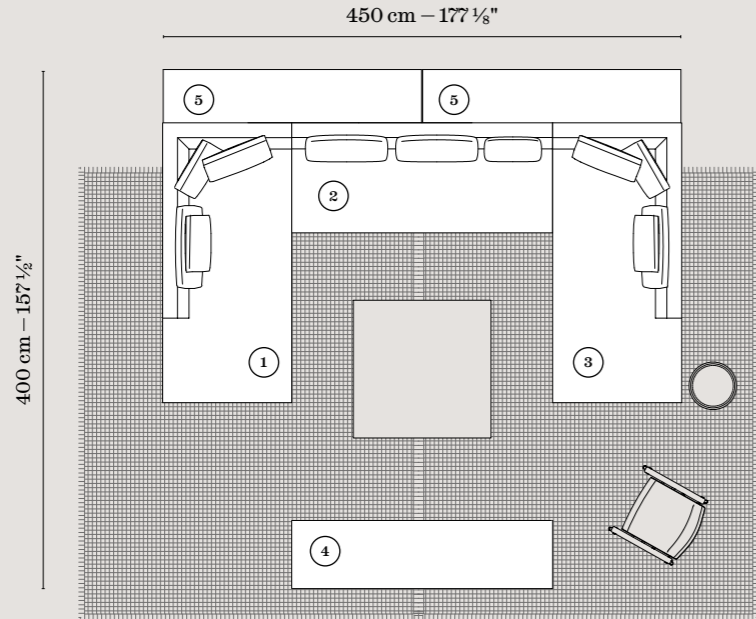

Composition 6

divano /sofa **Charles Large Carré** – panca /bench **Charles**
tavolo basso /low table **Diesis** – pouf /ottoman **Frank**
tavolino /small table **Eileen** – libreria /bookcase **Jack**
contenitore /storage unit **Mida** (Maxalto)



Composition 6 / Charles Large Carré, Charles

- 1. Divano CHL270B_1Q
- 2. Elemento terminale sinistro CH156S_Q
- 3. Elemento terminale destro CH156D_Q
- 4. Panca CH228P

- 1. Sofa CHL270B_1Q
- 2. Left terminal element CH156S_Q
- 3. Right terminal element CH156D_Q
- 4. Bench CH228P

33 mq – 355,21 sq ft

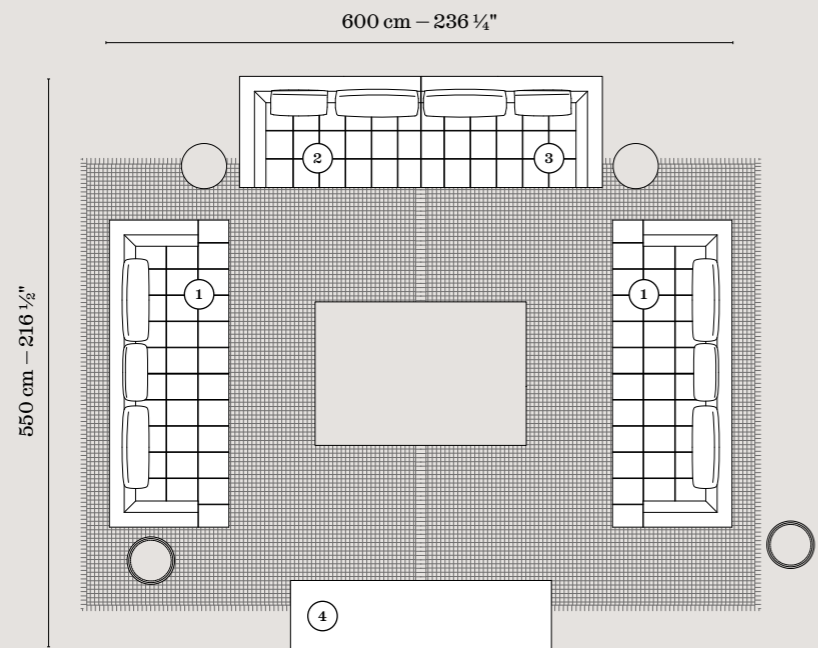

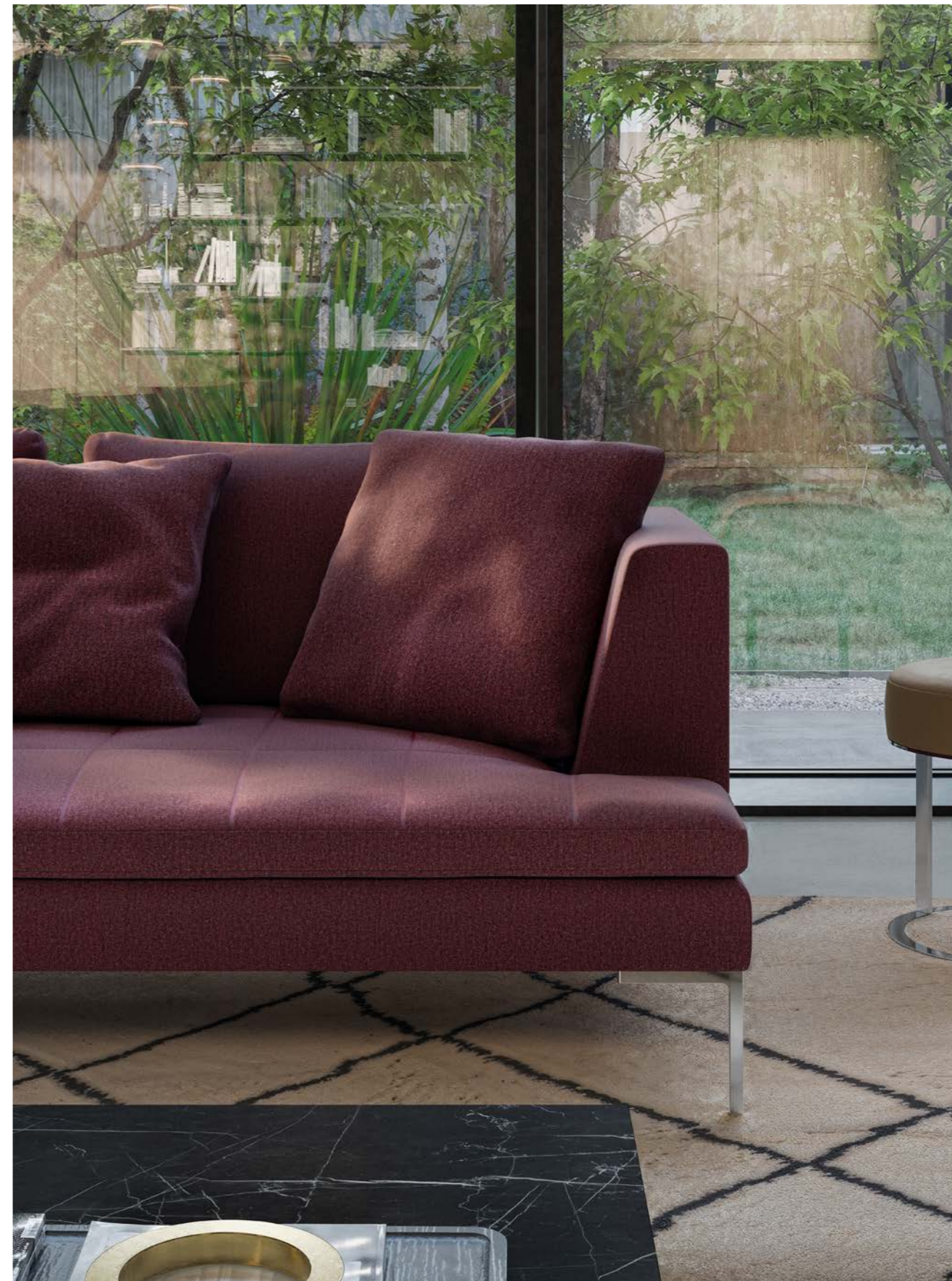

066

The Collection

divano/sofa **Charles Large Carré** – tavolo basso/low table **Diesis**
pouf/ottoman **Frank**

067

Charles

CH228

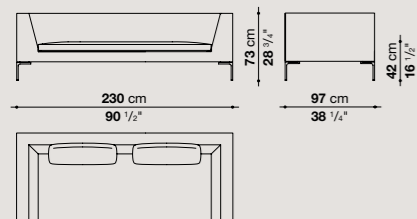

CH180L

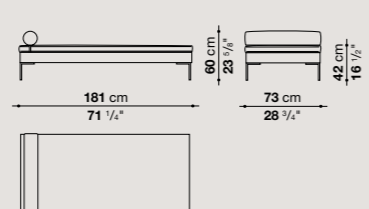

CH156TPS / CH156TPD

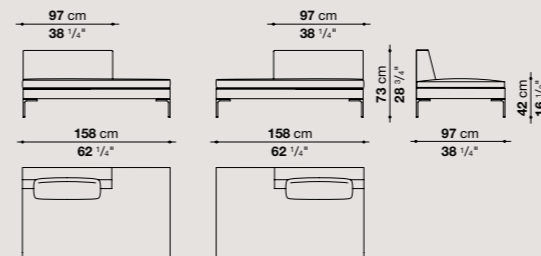

CH228TPS / CH228TPD

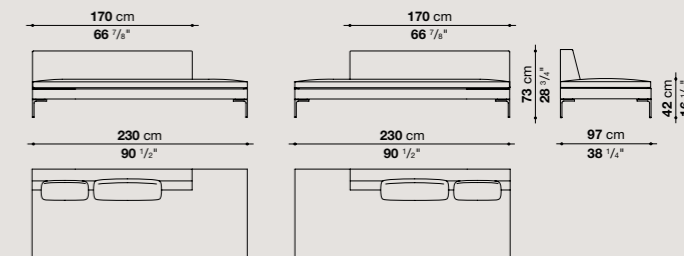

CH156S / CH156D

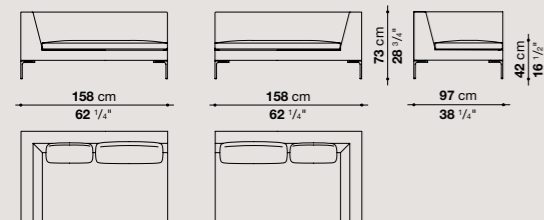

CH228S / CH228D

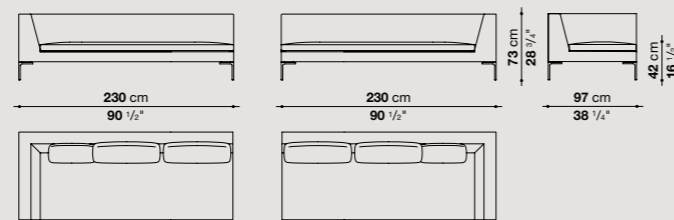

CH156L

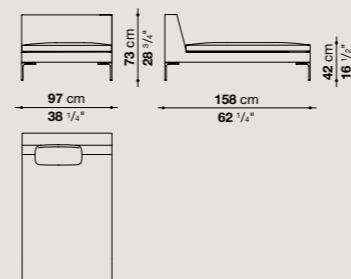

CH228L

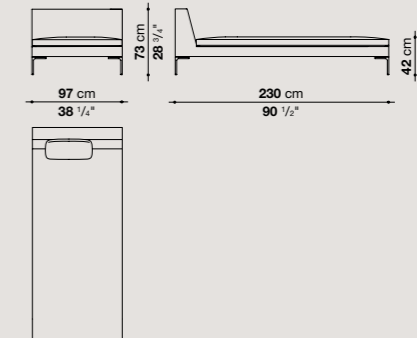

CH156LS / CH156LD

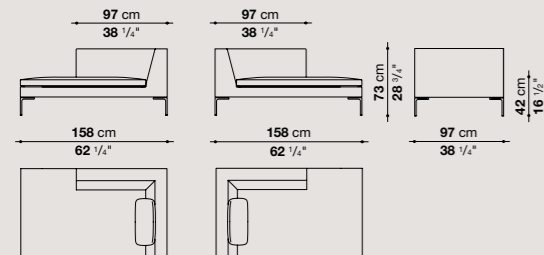

CH228LS / CH228LD

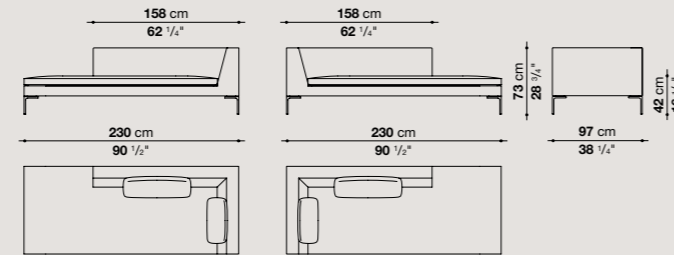

CHP

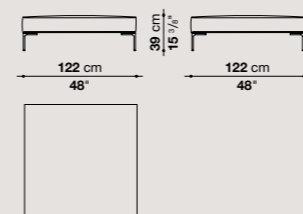

CH150P

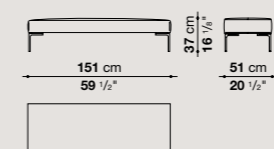

CH156P

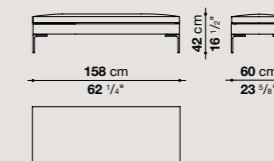

CH228P

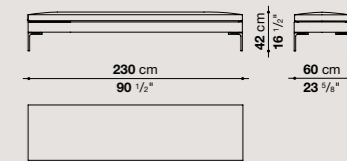

CH156C

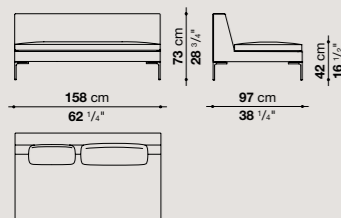

CH228C

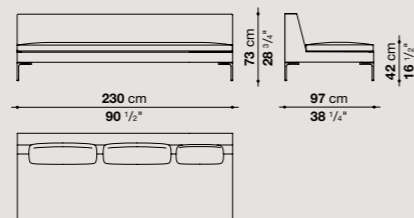

CHC156

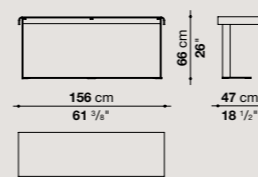

CHC228

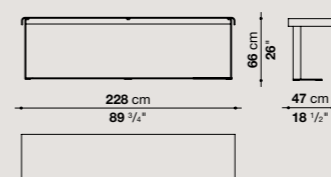

TCH156

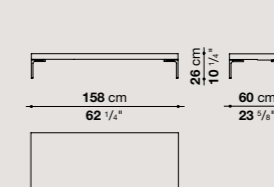

TCH228

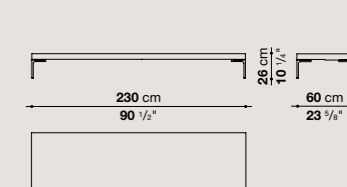

CH228_Q

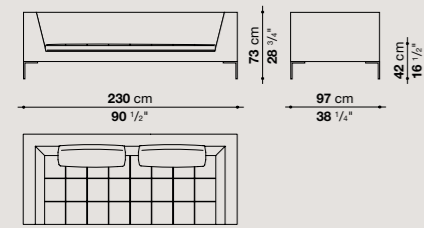

CH180L_Q

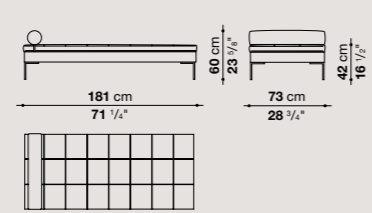

CH156C_Q

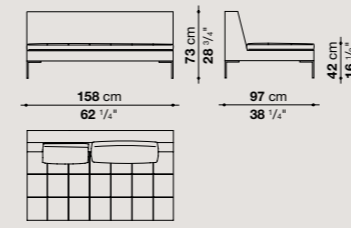

CH228C_Q

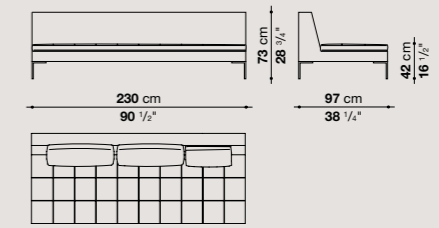

CH156S_Q/CH156D_Q

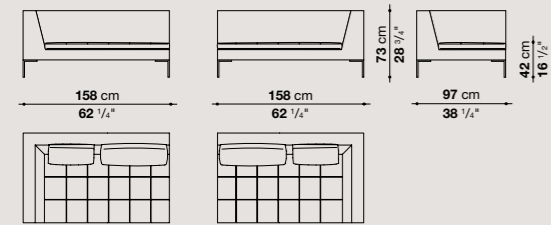

CH228S_Q/CH228D_Q

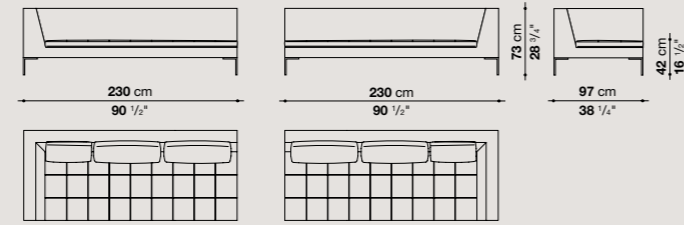

CH156TPS_Q/CH156TPD_Q

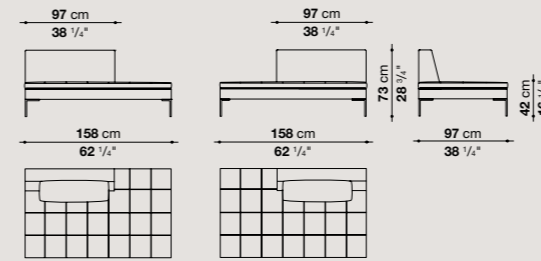

CH156LS_Q/CH156LD_Q

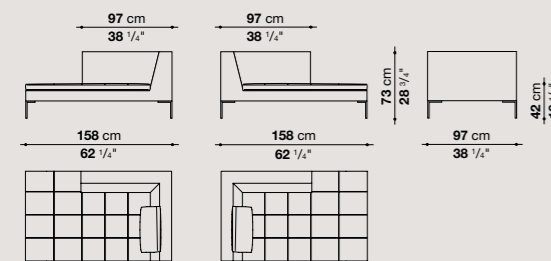

CH228LS_Q/CH228LD_Q

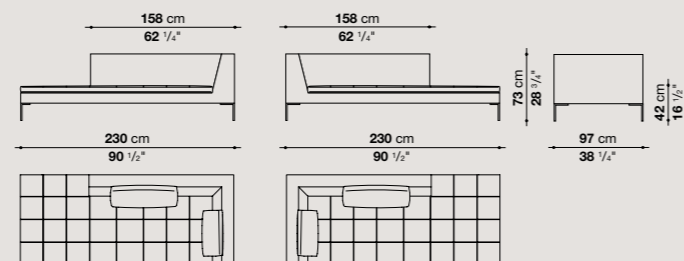

CHP_Q

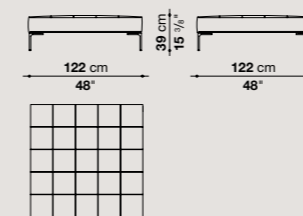

CH150P_Q

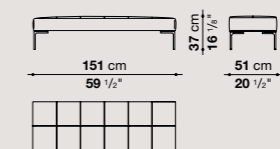

CHL270

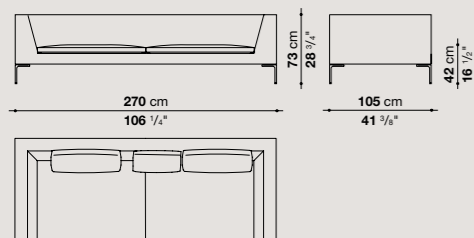

CHL270_1

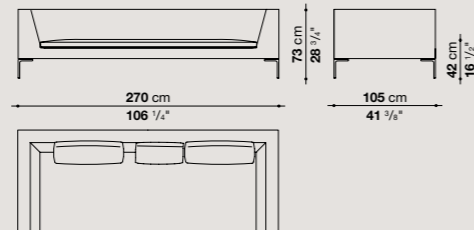

CHL270_1Q

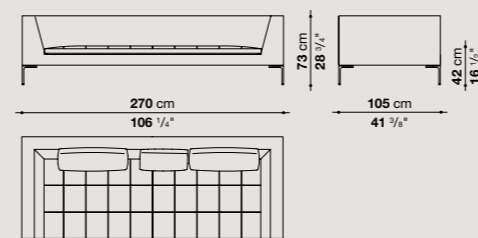

CHL270B_1Q

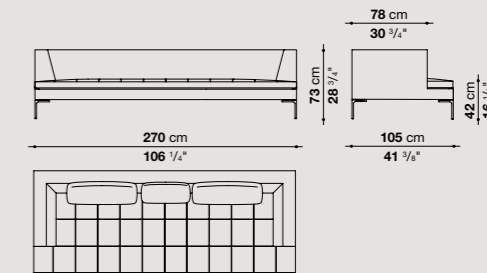

CHL270B_1

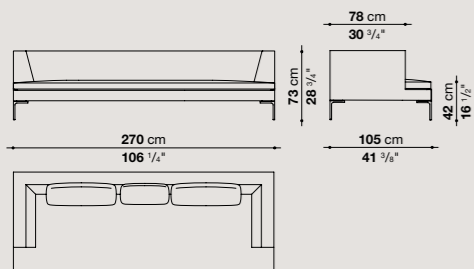

CHL158S / CHL158D

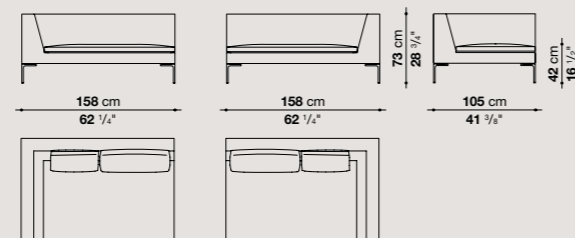

CHL158S_Q / CHL158D_Q

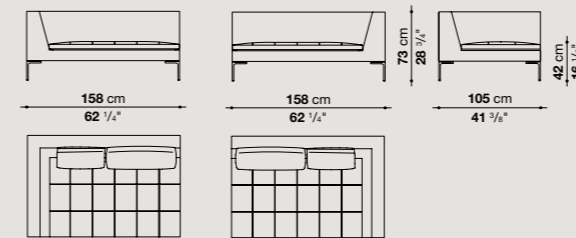

CHL247S_1Q / CHL247D_1Q

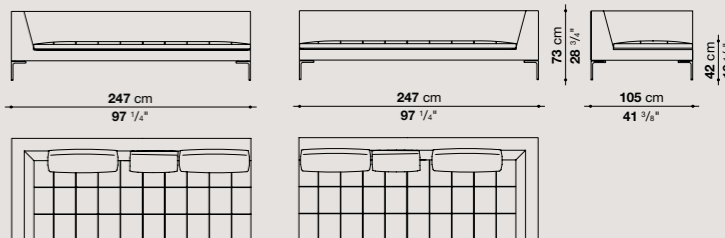

CHL247S / CHL247D

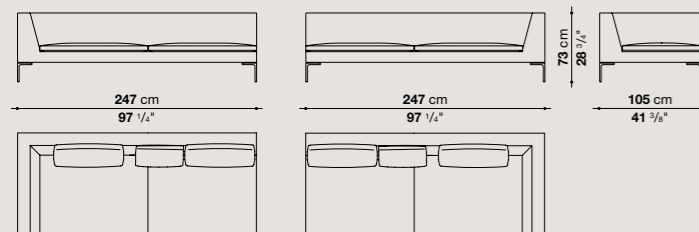

CHL247S_1 / CHL247D_1

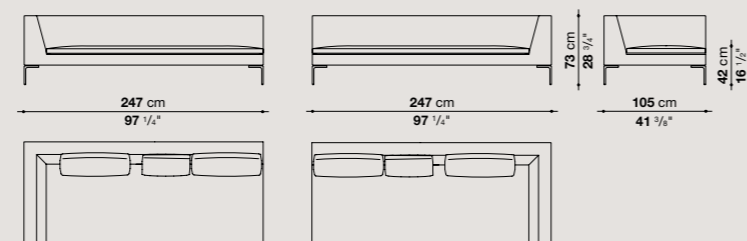

CHL135LS_Q / CHL135LD_Q

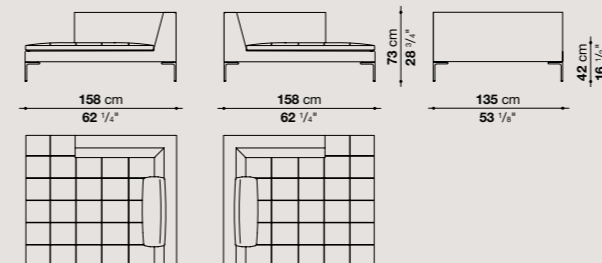

CHL247LS_1Q / CHL247LD_1Q

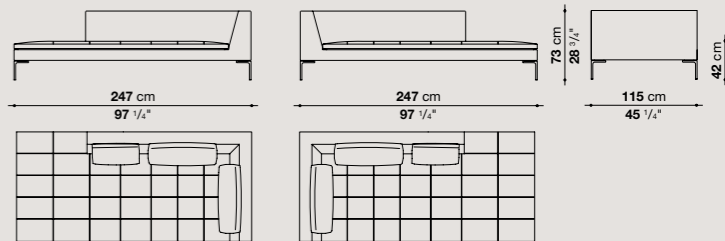

CHL135LS / CHL135LD

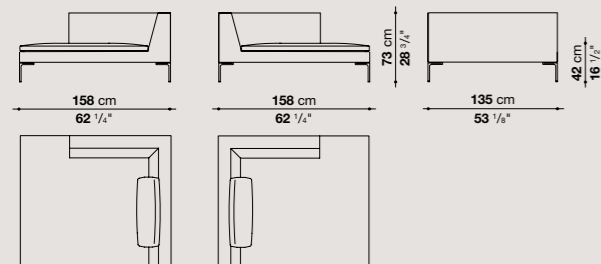

CHL247LS_1 / CHL247LD_1

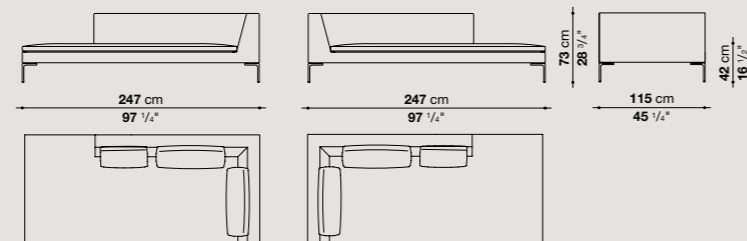

L'arte di progettare è un'eredità viva: cambia con il tempo ma conserva la propria identità.

The art of design is a living legacy: it changes with time but retains its identity.

Metropolitan Relax – Jeffrey Bernett

Dal 2002, la serie di poltrone Metropolitan rappresenta l'eccellenza nel design delle sedute lounge, evolvendosi nel tempo per offrire soluzioni complementari e innovative. Ogni nuova versione nasce con uno scopo preciso: ampliare l'esperienza di seduta, adattandosi alle esigenze contemporanee di comfort e funzionalità. Metropolitan Relax è l'ultima evoluzione di questa iconica famiglia, progettata per offrire un nuovo livello di benessere e adattabilità. Grazie al meccanismo oscillante e al basamento girevole, la poltrona segue in modo fluido i movimenti del corpo, garantendo un sostegno impeccabile in qualsiasi posizione. Il nuovo design della parte superiore dello schienale/poggiatesta offre un supporto ottimale alla testa e alla parte superiore del corpo, favorendo ogni momento di relax. Con struttura in alluminio in due finiture e rivestita in un'ampia selezione di tessuti e pelli, Metropolitan Relax si inserisce perfettamente sia in ambienti residenziali che in spazi hospitality e uffici.

Since 2002, the series of Metropolitan armchairs has represented excellence in lounge seating design, evolving over time to offer complementary and innovative solutions. Each new version is created with a precise aim: to expand the seating experience, adapting to contemporary needs for comfort and functionality. Metropolitan Relax is the latest evolution of this iconic family, designed to offer a new level of well-being and adaptability. Thanks to its oscillating mechanism and swivel base, the armchair smoothly follows the body's movements, ensuring flawless support in any position. The new design of the upper backrest/headrest offers optimal support for the head and upper body, facilitating every moment of relaxation. With an aluminum frame in two finishes and upholstered in a wide selection of fabrics and leathers, Metropolitan Relax fits perfectly in residential as well as hospitality and office environments.





078

The Collection

poltrona / armchair **Metropolitan Relax**
tavolino / small table **Fat-Fat**

079

Metropolitan Relax



Metropolitan Relax / design Jeffrey Bennett

MER100_1

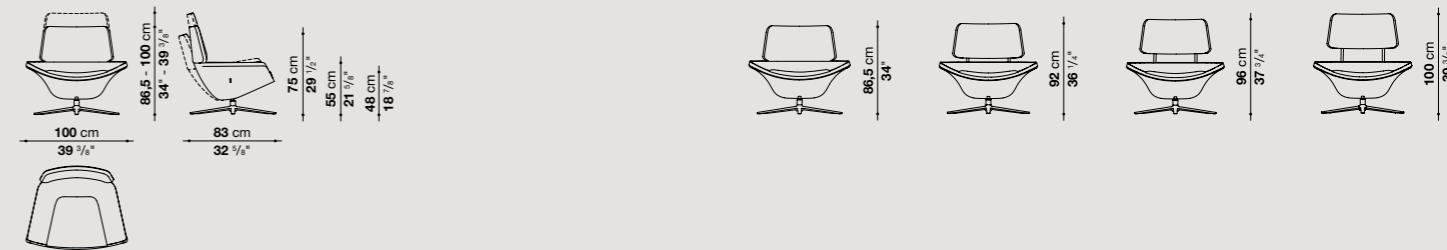

Jack – Michael Anastassiades

Classico contemporaneo, essenziale nella sua configurazione, ma estremamente flessibile, il sistema Jack è proposto in due versioni - con montanti verticali da pavimento a soffitto o con aste da fissate a muro - che consentono di realizzare librerie divisorie a centro stanza o accostate a parete. I montanti in alluminio, l'esclusivo sistema di aggancio e la regolazione telescopica per il fissaggio garantiscono la massima solidità strutturale e purezza formale. La modularità e le discrete soluzioni tecniche alla base del progetto consentono di disegnare composizioni in grado di abitare ogni ambiente e contesto d'arredo. Il sistema presenta numerosi elementi che ne arricchiscono la funzionalità: elementi contenitori con cassetti, con anta a ribalta o ante a battente e ripiani con o senza luce. Dal punto di vista estetico, tutti gli elementi strutturali sono previsti in due finiture, a cui si aggiungono il noce canaletto e quattro varianti di rovere per i ripiani e i contenitori.

A contemporary classic, essential in its configuration, yet extremely flexible, the Jack system is offered in two versions - with vertical floor-to-ceiling uprights or with rods to be fixed to the wall - to create bookcases that act as room dividers or to be placed alongside the wall. The aluminum uprights, the exclusive joining system and the telescopic adjustment for fixing ensure the maximum strength and formal pureness. The modularity and discrete technical solutions underlying the project make it possible to create compositions for every room and furnishing context. The system features numerous elements that enhance its functionality: storage units with drawers, with flap door or hinged doors, and shelves with or without light. From an aesthetic point of view, all the structural elements are available in two finishes, in addition to Canaletto walnut and four oak variants for the shelves and storage units.



Composition 1

libreria /bookcase **Jack** – tavolo /table **Alex**
sedia /chair **Jens** – divano componibile /modular sofa **Charles**





086

The Collection

libreria/bookcase **Jack**



087

Jack

Composition 2

libreria / bookcase **Jack**
divano componibile / modular sofa **Charles**
pouf / ottoman **Harry Large**



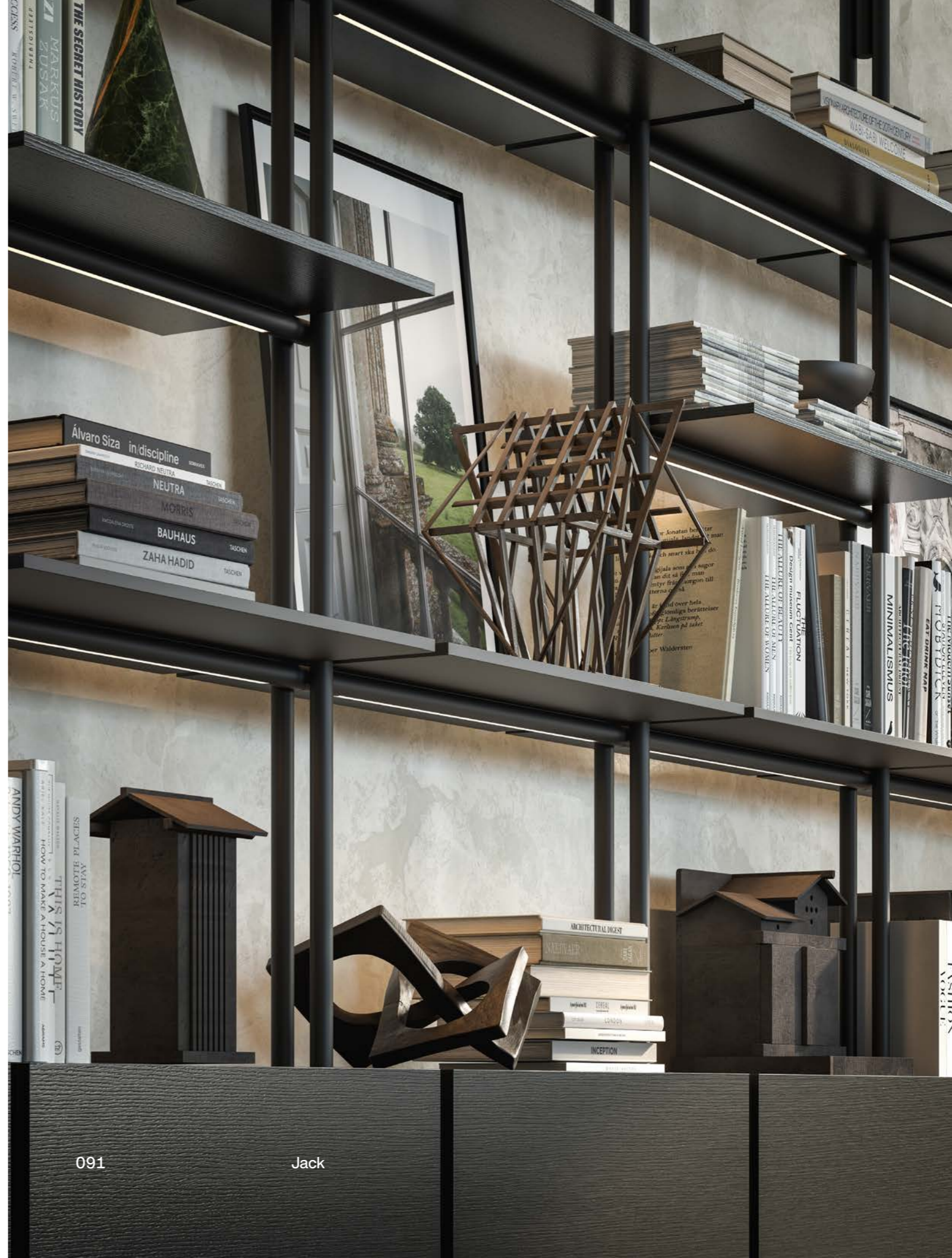

Composition 3

libreria / bookcase Jack
divano / sofa Charles Large Carré
contenitore / storage unit Mida (Maxalto)



Jack / design Michael Anastassiades

Composition 1

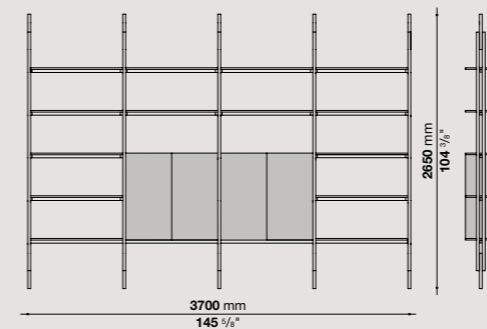

Composition 2

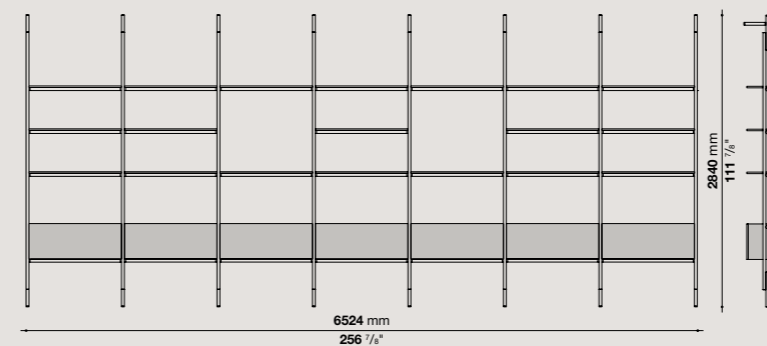

Composition 3

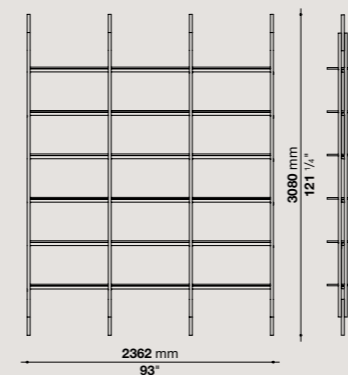

Ogni istante ha un architetto invisibile che ne modella l'essenza e ne definisce il respiro.

Every moment has an invisible architect who shapes its essence and defines its breath.



B&B Italia Spa

Strada Provinciale 32
22060 Novedrate /CO
Italy
T. + 39 031795 111
F. + 39 031791 592

www.bebitalia.com
www.maxalto.it
www.azucena.it
info@bebitalia.com
Italia
numero verde
800 018 370

USA
toll free number
800 872 1697

All other countries
T. + 39 031795 213
F. + 39 031791 592

Credits

Art direction
and Graphic Design
Artemio Croatto, Designwork
Images production
Nudesign
Director of Photography
Federico Cedrone
Concept and styling
vandersandestudio
Copywriting
Daniele Varelli

Copyright
B&B Italia Spa
December 2025
Printing
Nava Press
Rotolito Spa

Descriptions and pictures of
products included in this
catalogue have an indicative
value only and are not binding
for products' use.
B&B Italia reserves the right
to modify their products
without prior notification.
For further technical
information of the products,
please contact the authorised
dealer closest to you
(see www.bebitalia.com).

La descrizione e le immagini
dei prodotti del presente
catalogo sono puramente
indicative e non possono
essere considerate vincolati
ai fini del loro utilizzo.
B&B Italia si riserva di
apportare ai prodotti le
modifiche che ritiene più
opportune, in qualsiasi
momento e senza preavviso.
Per ulteriori informazioni
sulle caratteristiche tecniche
dei prodotti, invitiamo a
consultare il sito
www.bebitalia.com dove
troverete l'elenco dei
rivenditori autorizzati a cui
rivolgervi.

Thanks to

Altai Gallery
Atelier Février
Danke Gallery
Gillistra Japanese Art
imperfettolab
studionudo

V9085159



