

francoferri
ITALIA

Volume I

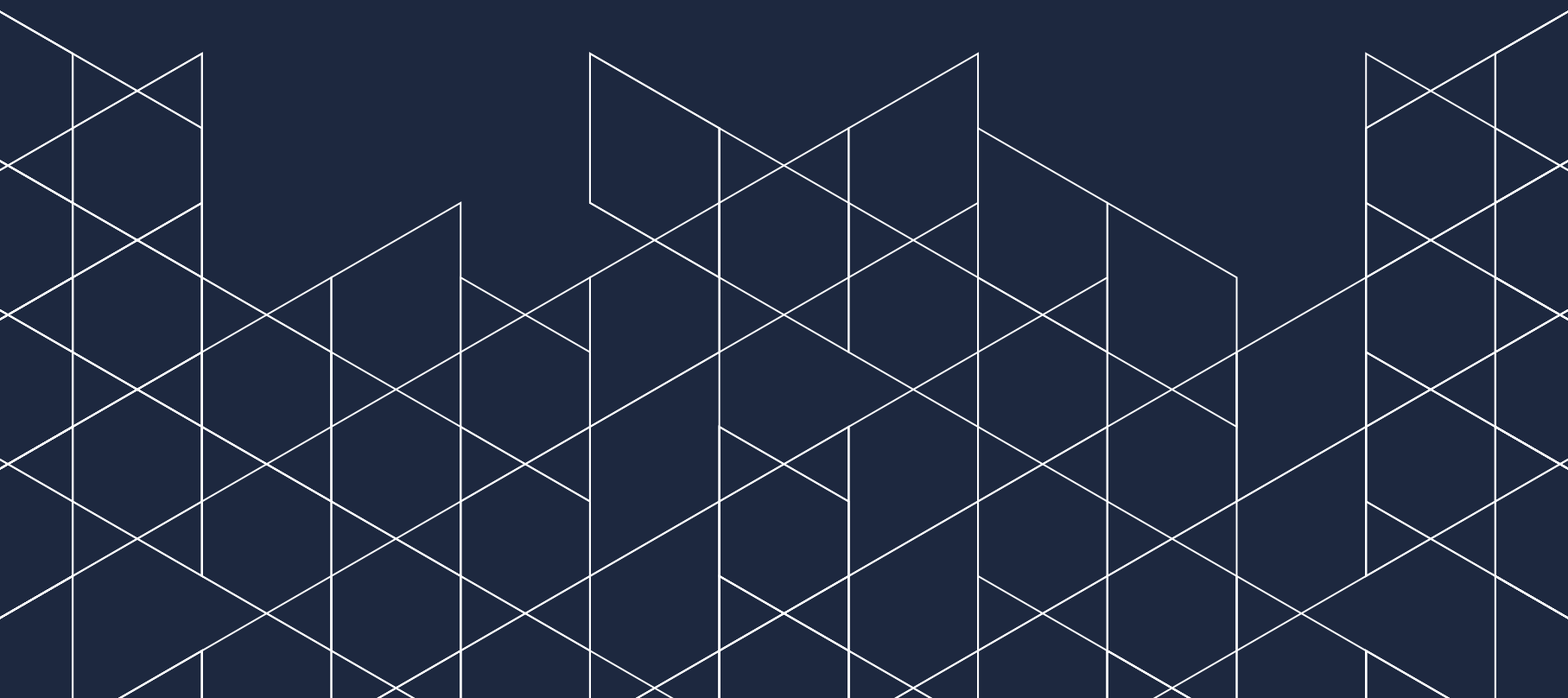



Franco Ferri Italia

Oltre 60 anni di storia

Da una lunga esperienza artigianale, fatta di passione e cura per i dettagli nasce **FRANCO FERRI ITALIA**, un marchio di qualità del "Modern Living" con modelli di forte carattere estetico che si identificano per forma, rivestimenti e accessori coordinati.

FRANCO FERRI ITALIA si propone offrendo la sua capacità di coniugare tradizione ed innovazione. Una magica alchimia, fatta di artigianato declinato nelle moderne tecnologie, da cui nasce il confortevole design by **FRANCO FERRI ITALIA**.

FRANCO FERRI ITALIA was born from a long history of craftsmanship, made of passion and care for details; a quality brand for "Modern Living" with models of strong aesthetic character made of original shape, coverings and coordinated accessories. **FRANCO FERRI ITALIA** offers a unique mix of tradition and innovation: a fascinating chemistry of craftsmanship and modern technology, resulting in the superb comfortable **FRANCO FERRI ITALIA** design.

D'une longue histoire d'artisanat, faite de passion et de soin du détail, est née **FRANCO FERRI ITALIA**, une marque de qualité dans le "Modern Living". Elle propose des modèles à l'esthétique affirmée, qui se distinguent par leurs lignes, leurs revêtements et leurs accessoires coordonnés. L'offre de **FRANCO FERRI ITALIA** relève d'une alchimie subtile entre tradition et modernité qui marie savoir-faire artisanal et technologies de pointe au service du confort et du design.



Borg
6



Stupore
26



Capitolo
34



Santorini
42



Miami
48



Vanoni
54



Merlot
62



Aladine
68



Sonya
74



Eliot / Dadaumpa
84



Noto
92



Via Gluck
100



Lennon
106



Nicole
114



Fontana
122



Nazaro
130



Alicudi
136



Filicudi
144



Lipari
148



Gerard
152



Alfa
156



Beta
160



Living
164

Borg

BORG è la giusta sintesi tra confort e fascino. All'eleganza geometrica delle cuciture, si aggiunge la sua eclettica funzione relax fruibile attraverso le multi posizioni dei suoi braccioli e dei poggiatesta lift. Questo divano raffinato e componibile sarà in grado di offrirvi momenti di spensieratezza assoluta.

BORG is the right combination of charm and comfort. Its eclectic multi-positions reclining function is enhanced by the geometric elegance of the quilted seaming. This refined and modular sofa will be able to offer you moments of absolute carefree.

BORG est la bonne combinaison entre le confort et le charme. L'élégance géométrique des coutures, se double d'une fonction de relaxation éclectique qui peut être utilisée grâce aux positions multiples de ses accoudoirs et de ses appui-têtes lift électriques. Ce canapé raffiné et modulable saura vous offrir des moments d'insouciance absolue.



Borg



Borg



Borg



Borg



Borg



Borg



Borg



Borg



Borg

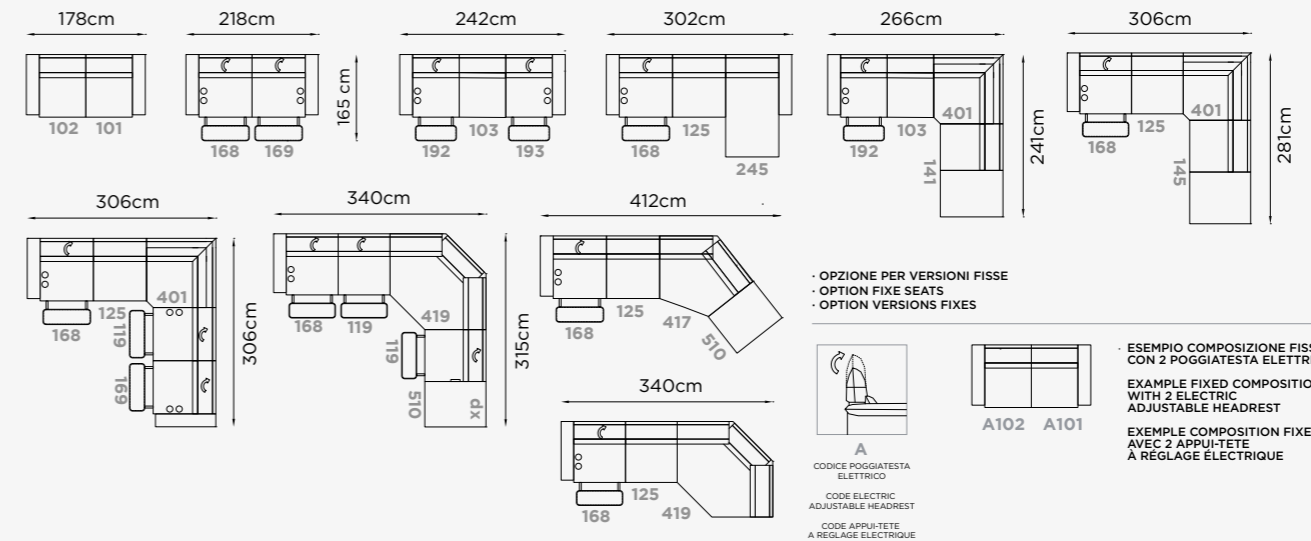
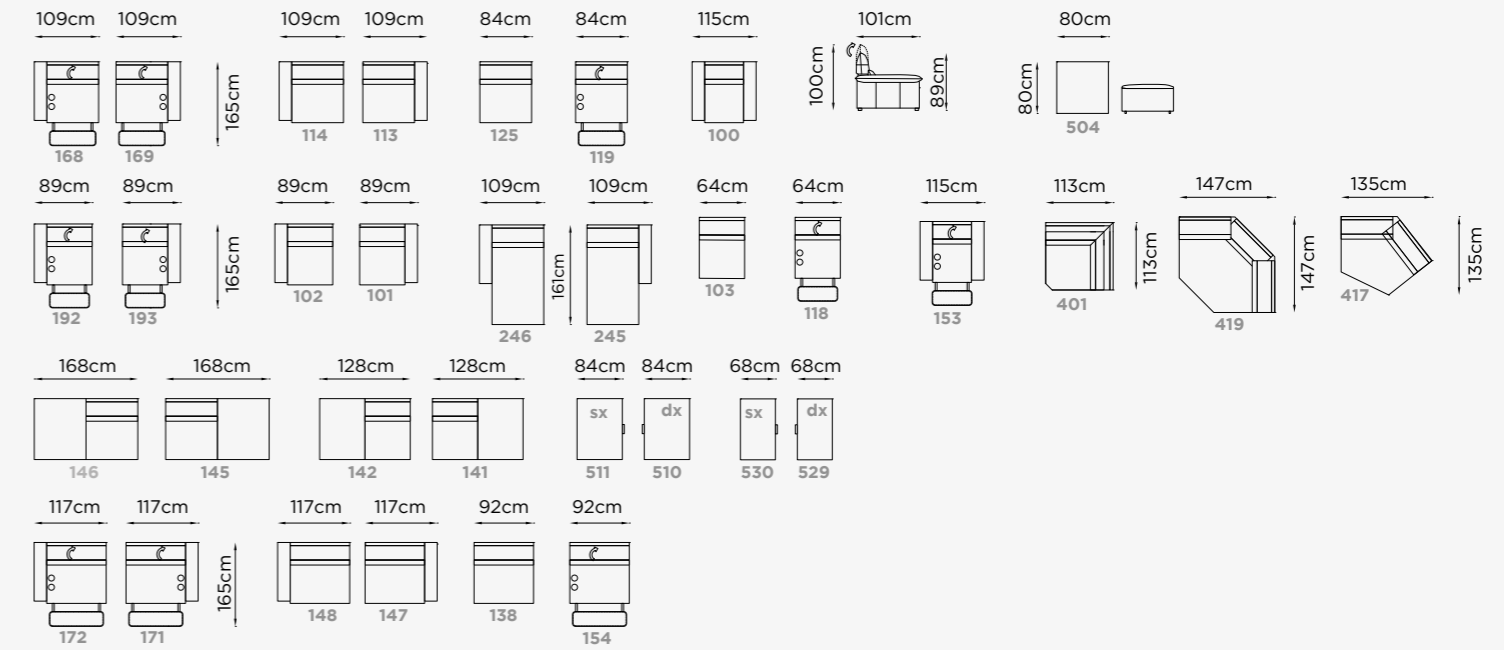
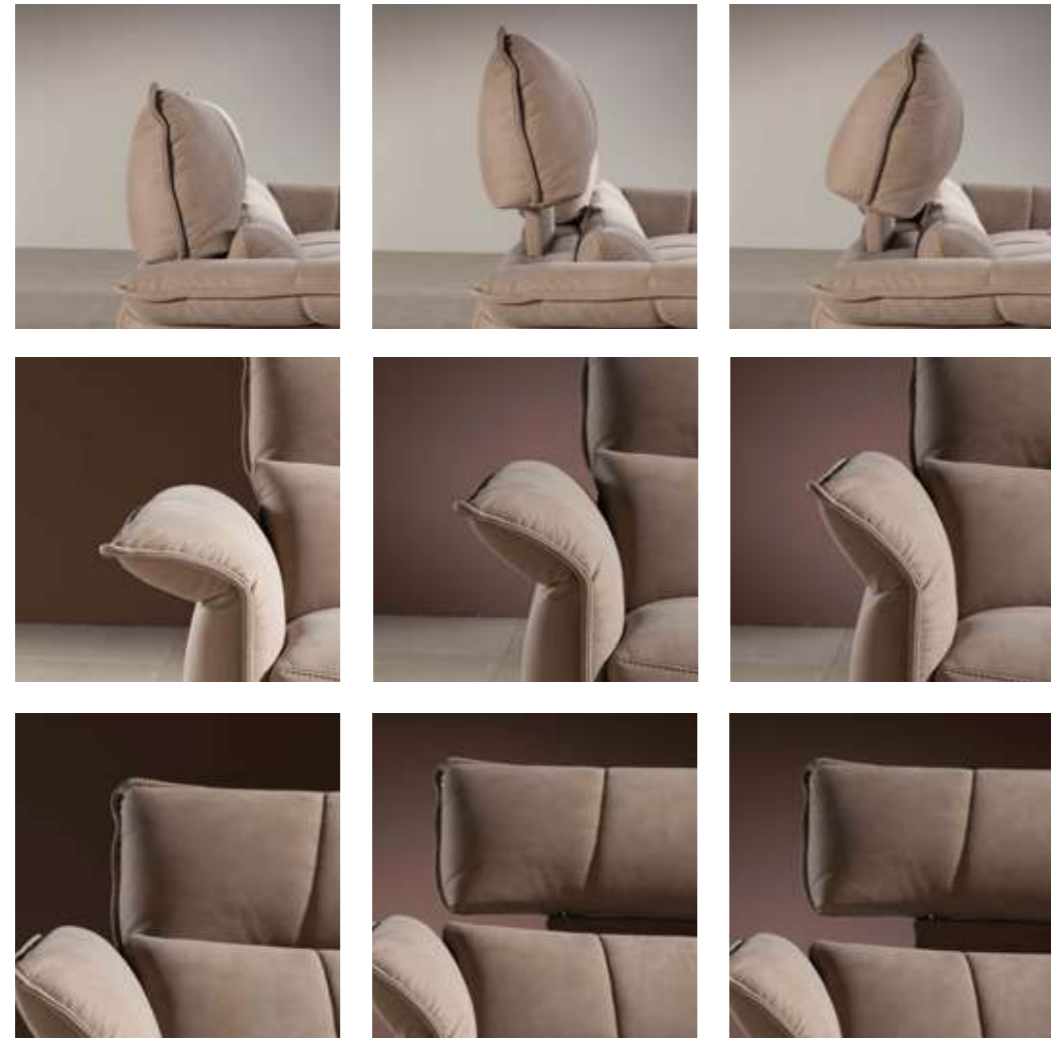

Profondità Depth Profondeur	101/165 cm
Altezza Height Hauteur	89/100 cm
Profondità seduta Seat Depth Profondeur d'assise	60 cm
Altezza bracciolo Arms height Hauteur d'accoudoir	58/66 cm
Altezza seduta Seat height Hauteur d'assise	42 cm
Altezza piede Leg height Hauteur pied	4 cm

RIVESTIMENTO	COVERING	REVETEMENTS						
• Pelle • Tessuto	• Leather • Soft cover	• Cuir • Tissu						
PIEDI	LEGS	PIÈTEMENT						
• Plastica	• Plastic	• Plastique						
IMBOTTITURA	FILLING	REMBOURRAGE						
BRACCIOLO	CUSCINO SEDUTA	CUSCINO SPALLIERA	ARMS	SEAT CUSHION	BACK CUSHION	ACCOUDOIR	COUSSIN D'ASSISE	COUSSIN DE DOSSIER
• Gomma	• Gomma	• Gomma	• Foam	• Foam	• Foam	• Mousse	• Mousse	• Mousse
COMFORT	COMFORT	CONFORT						
• Standard	• Standard	• Standard						
FUNZIONE	FUNCTION	FONCTION						
• Sistema reclinare elettrico doppio motore • Braccio regolabile tipo manuale • Poggiatesta regolabile elettrico	• Electric recliner system dual motor • Manually adjustable arm • Electric adjustable headrest	• Système relax électrique bi-moteur • Accoudoir à réglage manuel • Appui-tête à réglage électrique						
OPZIONI	OPTION	OPTION						
• Cuciture a contrasto • Tessuto non sfoderabile • Poggiatesta regolabile elettrico nelle versioni fisse	• Contrast stitching • Not removable cover • Electric adjustable headrest on fixe seats	• Coutures contrastées • Non déhoussable en tissu • Appui-tête à réglage électrique dans les versions fixes						

Stupore

Gli schienali reclinabili ti aiutano a schiarirti le idee, i poggiatesta rimovibili sono lì per adattarsi al tuo bisogno di benessere.

Non fermarti alla prima opzione, alla scelta più facile. Scopri STUPORE e lasciati sorprendere dalle sue forme lineari e semplici, come le migliori idee.

The reclining backrests help you to rest your body and your mind, the movable backrests are there to adapt to your well-being.

Do not stop at the easiest choice. Discover STUPORE and be surprised by its cutting-edge, comfortable shapes.

Les dossiers inclinables qui vous aident à alléger les idées, le cale reins amovible sont là pour répondre à votre besoin de bien-être. Ne vous arrêtez pas à la première option, au choix le plus facile.

Découvrez STUPORE et laissez vous surprendre par ses formes linéaires et simples, comme les meilleures idées.



Stupore



Stupore



Stupore

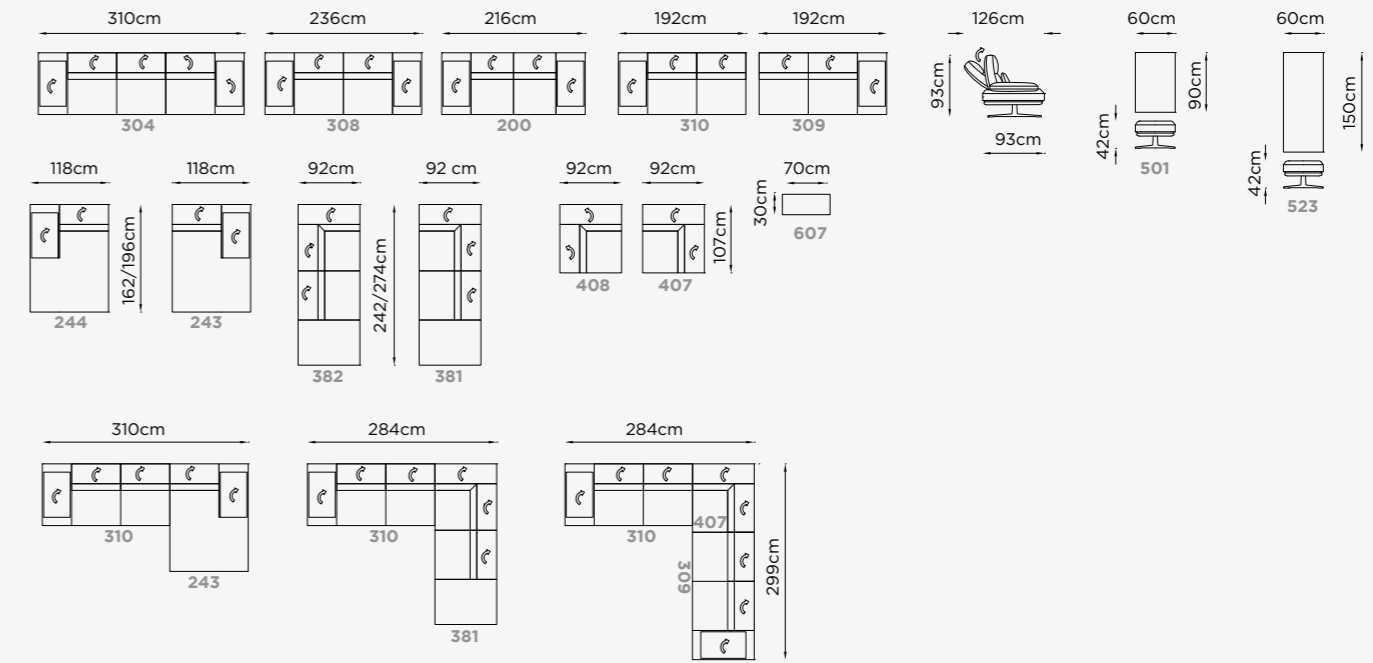

Profondità Depth Profondeur	93/126 cm
Altezza Height Hauteur	93 cm
Profondità seduta Seat Depth Profondeur d'assise	62 cm
Altezza bracciolo Arms height Hauteur d'accoudoir	49/64 cm
Altezza seduta Seat height Hauteur d'assise	42 cm
Altezza piede Leg height Hauteur pied	20 cm

RIVESTIMENTO	COVERING	REVETEMENTS
• Pelle • Tessuto	• Leather • Soft cover	• Cuir • Tissu
PIEDI	LEGS	PIETEMENT
• Metallo 11/26/37/42/46/47/48	• Metal 11/26/37/42/46/47/48	• Métal 11/26/37/42/46/47/48
IMBOTTITURA	FILLING	REMBOURRAGE
BRACCIOLO CUSCINO SEDUTA CUSCINO SPALLIERA	ARMS SEAT CUSHION BACK CUSHION	ACCOUDOIR COUSSIN D'ASSISE COUSSIN DE DOSSIER
• Gomma • Gomma • Gomma	• Foam • Foam • Foam	• Mousse • Mousse • Mousse
COMFORT	COMFORT	CONFORT
• Standard	• Standard	• Standard
FUNZIONE	FUNCTION	FONCTION
• Braccio regolabile tipo manuale • Spalliera regolabile tipo manuale	• Manually adjustable arm • Manually adjustable back cushion	• Accoudoir à réglage manuel • Coussin de dossier à réglage manuel
OPZIONI	OPTION	OPTION
• Cuciture a contrasto • Tessuto non sfoderabile	• Contrast stitching • Not removable cover	• Coutures contrastées • Non déhoussable en tissu

Capitolo

È ora di voltare pagina, ma non siamo ancora al finale.

È l'inizio di un nuovo CAPITOLO da scoprire passo dopo passo, su un divano moderno e componibile.

Leggi le prossime pagine della tua storia su morbide sedute eleganti e accoglienti in ogni punto, grazie anche ai suoi schienali reclinabili in grado di seguire ogni possibile risvolto della trama più avvincente che c'è...la tua.

It is the beginning of a new chapter to be discovered step by step on this modern and modular sofa. Page by page enjoy its elegant and comfortable seats, with its reclining back cushions that can follow every possible aspect of your most compelling storyline.

Il est temps de tourner la page, mais nous ne sommes pas encore à la fin de l'histoire. C'est le début d'un nouveau chapitre à découvrir étape par étape, sur un sofa moderne et composable. Lisez les pages suivantes de votre histoire sur des assises douces et élégantes, confortables en tous point, grâce à ses coussins inclinables qui s'adapteront à chaque revers de l'intrigue, le plus irrésistible qu'il n'y en a... le vôtre.



Capitolo



Capitolo



Capitolo

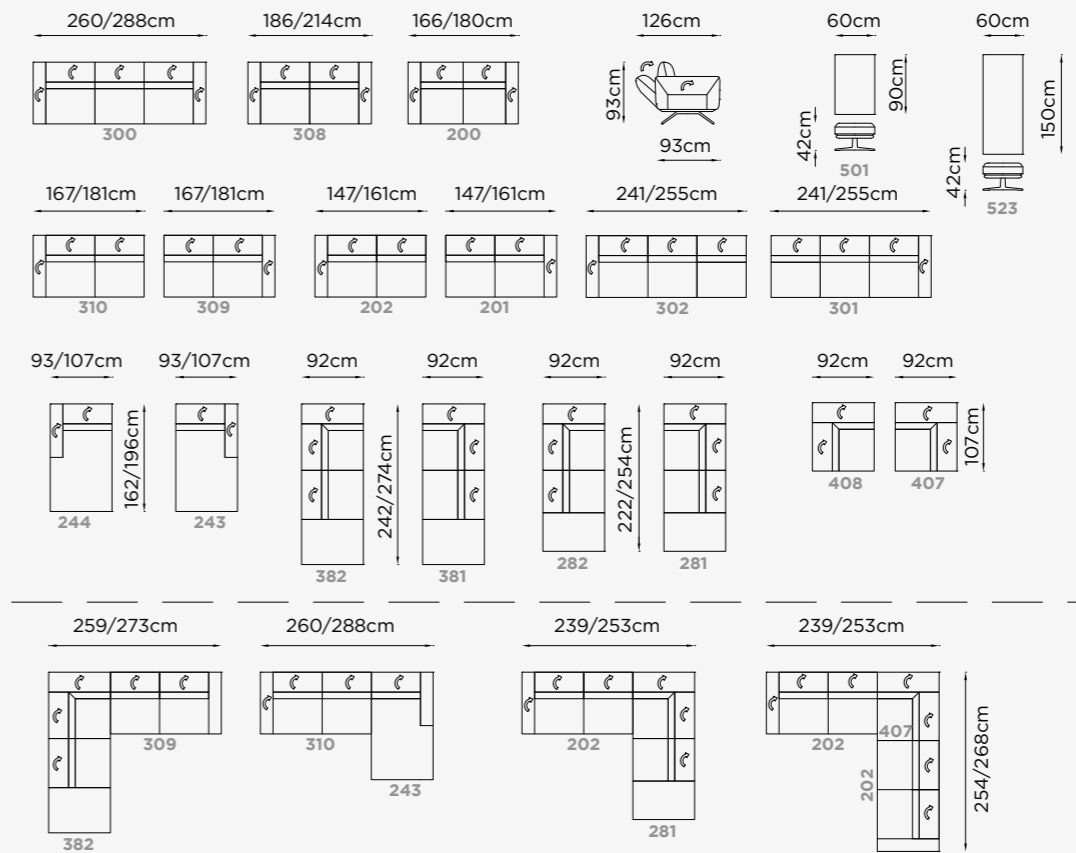

Profondità Depth Profondeur	93/126 cm
Altezza Height Hauteur	93 cm
Profondità seduta Seat Depth Profondeur d'assise	62 cm
Altezza bracciolo Arms height Hauteur d'accoudoir	72 cm
Altezza seduta Seat height Hauteur d'assise	42 cm
Altezza piede Leg height Hauteur pied	20 cm

RIVESTIMENTO	COVERING	REVETEMENTS
• Pelle • Tessuto	• Leather • Soft cover	• Cuir • Tissu
PIEDI	LEGS	PIETEMENT
• Metallo 11/26/37/42/46/47/48	• Metal 11/26/37/42/46/47/48	• Métal 11/26/37/42/46/47/48
IMBOTTITURA	FILLING	REMBOURRAGE
BRACCIOLO CUSCINO SEDUTA CUSCINO SPALLIERA	ARMS SEAT CUSHION BACK CUSHION	ACCOUDOIR COUSSIN D'ASSISE COUSSIN DE DOSSIER
• Gomma • Gomma • Gomma	• Foam • Foam • Foam	• Mousse • Mousse • Mousse
COMFORT	COMFORT	CONFORT
• Standard	• Standard	• Standard
FUNZIONE	FUNCTION	FONCTION
• Braccio regolabile tipo manuale • Spalliera regolabile tipo manuale	• Manually adjustable arm • Manually adjustable back cushion	• Accoudoir à réglage manuel • Coussin de dossier à réglage manuel
OPZIONI	OPTION	OPTION
• Cuciture a contrasto • Tessuto non sfoderabile	• Contrast stitching • Not removable cover	• Coutures contrastées • Non déhoussable en tissu

Santorini

Schienali leggeri come una piuma accompagnati da braccioli multiposizione, per personalizzare la vostra idea di confort affinché, nella soffice isola immersa nel vostro salotto, non manchi nulla.

In this soft island immersed in your living room, nothing is missing: lightweight goose down backs accompanied by multi-position armrests customize your idea of comfort.

Dossiers légers comme une plume accompagnés d'accoudoirs multi-position, pour personnaliser votre idée de confort afin que, dans l'île de douceur posée dans votre salon, vous ne manquiez de rien.



Santorini



Santorini

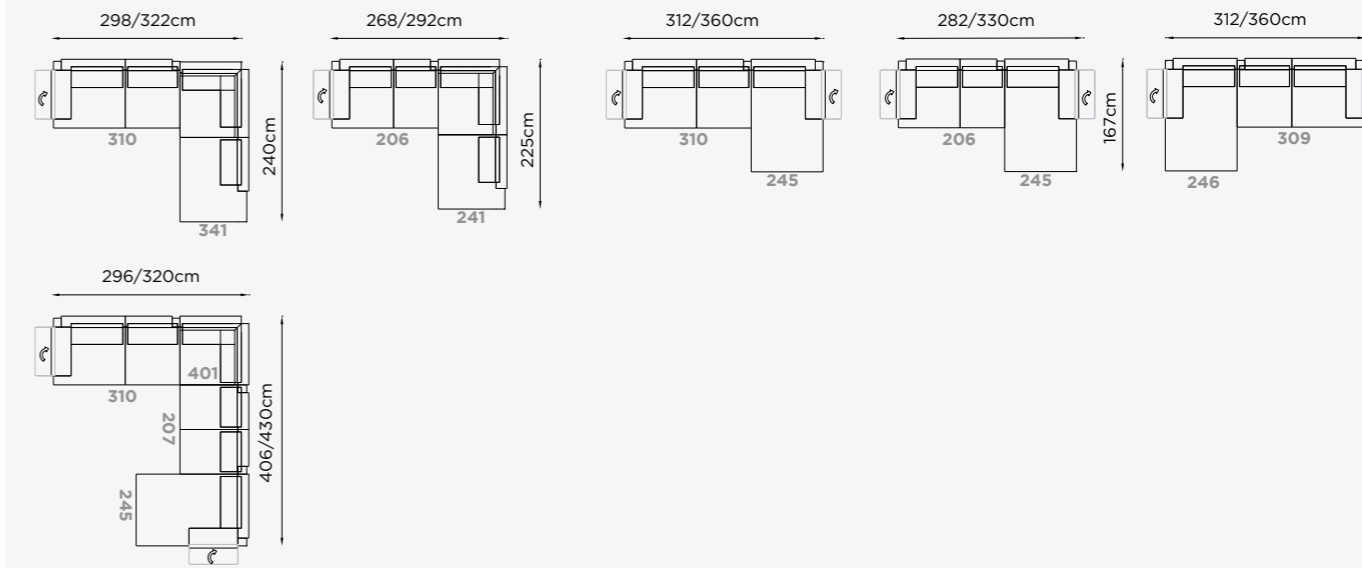
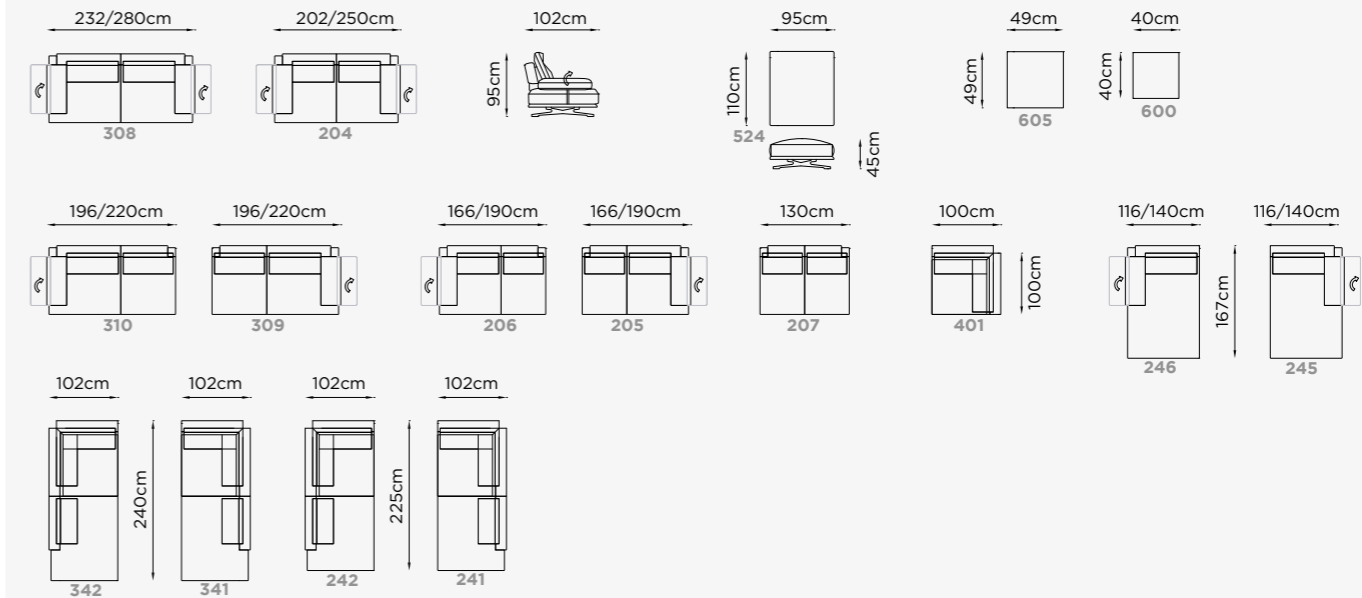

Profondità Depth Profondeur	102 cm
Altezza Height Hauteur	95 cm
Profondità seduta Seat Depth Profondeur d'assise	60 cm
Altezza bracciolo Arms height Hauteur d'accoudoir	57 cm
Altezza seduta Seat height Hauteur d'assise	45 cm
Altezza piede Leg height Hauteur pied	17 cm

RIVESTIMENTO	COVERING	REVETEMENTS						
• Pelle • Tessuto	• Leather • Soft cover	• Cuir • Tissu						
PIEDI	LEGS	PIETEMET						
• Metallo 10/11/26/37/42	• Metal 10/11/26/37/42	• Métal 10/11/26/37/42						
IMBOTTITURA	FILLING	REMBOURRAGE						
BRACCIOLO	CUSCINO SEDUTA	CUSCINO SPALLIERA	ARMS	SEAT CUSHION	BACK CUSHION	ACCOUDOIR	COUSSIN D'ASSISE	COUSSIN DE DOSSIER
• Gomma	• Gomma • Memory foam	• Piuma	• Foam	• Foam • Memory foam	• Feather	• Mousse	• Mousse • Memory foam	• Plume
COMFORT	COMFORT	COMFORT						
• Standard	• Standard	• Standard						
OPZIONI	OPTION	OPTION						
• Cuciture a contrasto • Tessuto parzialmente sfoderabile	• Contrast stitching • Partially removable cover	• Coutures contrastées • Tissu partiellement amovible						

Miami

Non tutte le isole vanno navigate, alcune sono lì semplicemente per servirvi e coccolarvi dopo una giornata stressante o per cominciarla al meglio. Dai piedi in metallo al rivestimento personalizzabile in pelle, tessuto e microfibra, passando per gli schienali con poggiatesta, fino all'anima invisibile che tiene tutto assieme: la struttura in legno. Perché scegliere tra comodità e stabilità? Scoprite MIAMI.

Not all the islands are to be sailed, some are there simply to serve you, maybe to cuddle after a stressful day or to start it to the fullest. From the metal feet to the customizable upholstery in leather, fabric and microfibre, through the backrests with lumbar support, to the invisible core that holds everything together: the wooden structure. Why choose between comfort and stability? Discover MIAMI.

Toutes les îles n'ont pas à être abordées par la mer, certaines ne sont là que pour vous câliner après une journée stressante ou pour vous ressourcer afin d'en revivre une nouvelle le soir venu. Des pieds en métal, un revêtement personnalisable en cuir, tissu et microfibre, ainsi que des dossiers avec support lombaire, tenus en place par une âme invisible: sa structure en bois. Pourquoi choisir entre confort et stabilité? Découvrez MIAMI.



Miami



Vanoni

VANONI è il porto sicuro a cui approdare dopo lunghe e stancanti giornate.

La stabilità della base metallica è fatta per garantire un sostegno solido e un confort adattabile, grazie agli schienali basculanti e alla sua funzione componibile.

VANONI is the safe harbor to land after long and tiring days.

The stability of the metal base is made to guarantee solid support and adaptable comfort thanks to the tilting backrests and its modular function.

VANONI est le havre de paix où accoster après une longue et fatigante journée.

La stabilité de la base en métal garantit un support solide et un confort adaptable grâce aux dossiers basculants et à sa fonction composable.



Vanoni



Vanoni



Vanoni

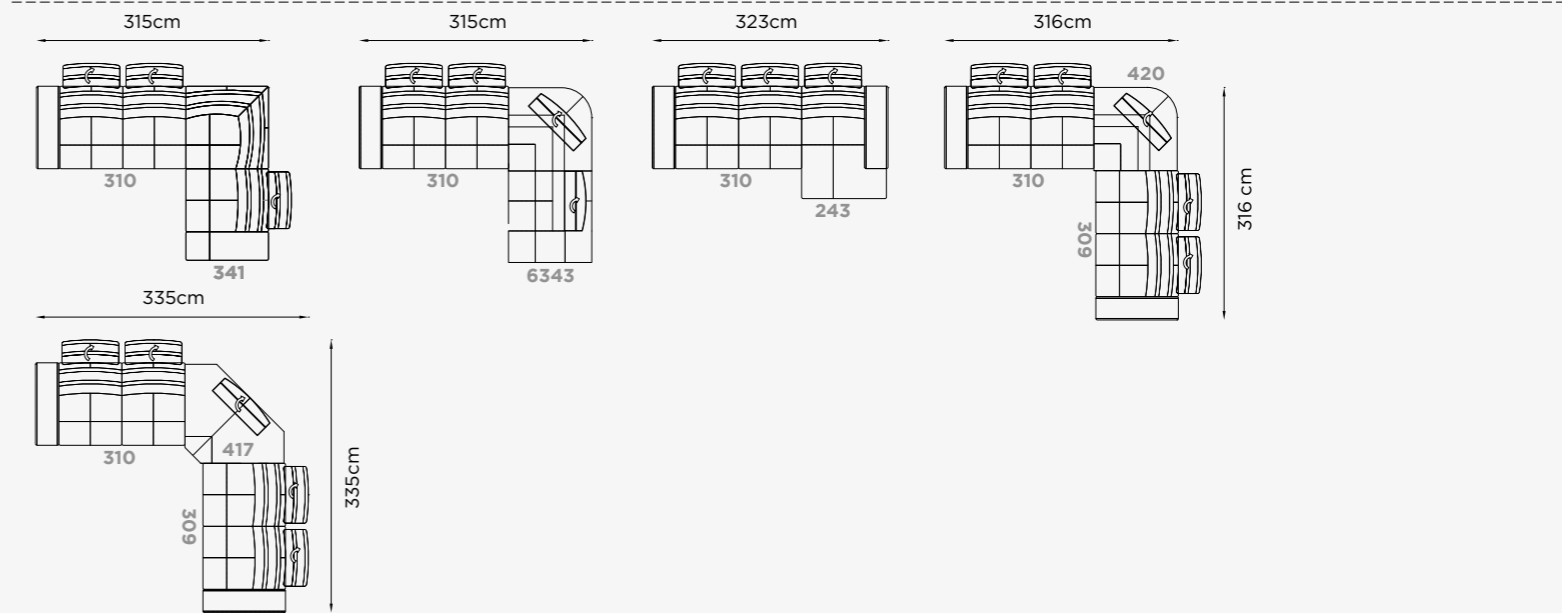
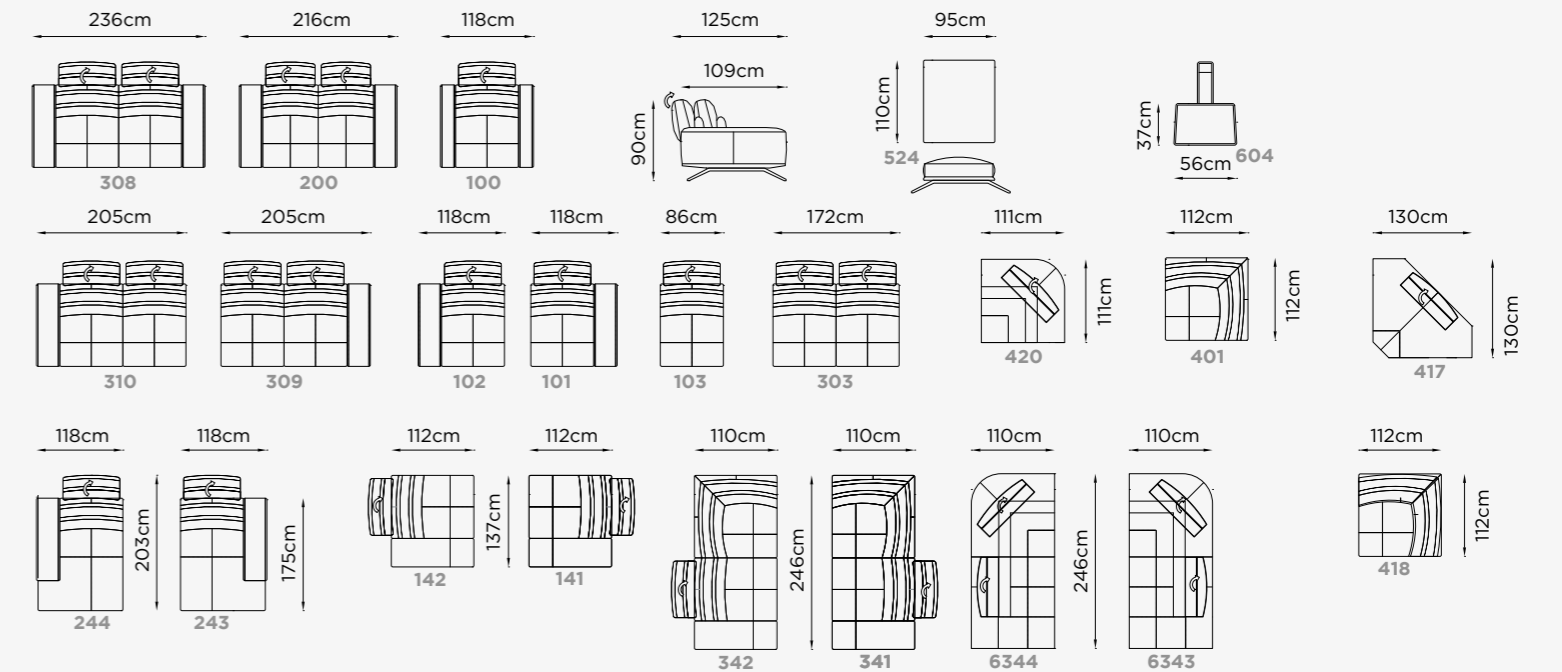

Profondità Depth Profondeur	109/125 cm
Altezza Height Hauteur	90 cm
Profondità seduta Seat Depth Profondeur d'assise	83/59 cm
Altezza bracciolo Arms height Hauteur d'accoudoir	57 cm
Altezza seduta Seat height Hauteur d'assise	43 cm
Altezza piede Leg height Hauteur pied	15 cm

RIVESTIMENTO	COVERING	REVETEMENTS						
• Pelle • Tessuto	• Leather • Soft cover	• Cuir • Tissu						
PIEDI	LEGS	PIETEMENT						
• Metallo 11/26/37/42/46/47/48	• Metal 11/26/37/42/46/47/48	• Métal 11/26/37/42/46/47/48						
IMBOTTITURA	FILLING	REMBOURRAGE						
BRACCIOLO	CUSCINO SEDUTA	CUSCINO SPALLIERA	ARMS	SEAT CUSHION	BACK CUSHION	ACCOUDOIR	COUSSIN D'ASSISE	COUSSIN DE DOSSIER
• Gomma	• Gomma • Memory foam	• Gomma	• Foam	• Foam • Memory foam	• Foam	• Mousse	• Mousse • Memory foam	• Mousse
COMFORT	COMFORT	COMFORT						
• Standard	• Standard	• Standard						
FUNZIONE	FUNCTION	FONCTION						
• Schienale regolabile tipo manuale	• Manually adjustable back cushion	• Coussin de dossier à réglage manuel						
OPZIONI	OPTION	OPTION						
• Cuciture a contrasto • Tessuto non sfoderabile	• Contrast stitching • Not removable cover	• Coutures contrastées • Non déhoussable en tissu						

Merlot

Accomodatevi e lasciatevi inebriare dall'energia di uno stile moderno e coinvolgente, con rivestimenti in pelle, tessuto e microfibra. MERLOT non si lascia andare ad eccessi e vi accoglie con le sue linee essenziali e sinuose.

Sit back and let yourself be inebriated by the energy of a modern and engaging style, with fabric and microfibre leather upholstery. MERLOT does not like excesses but welcomes you in its essential and sinuous lines, as in a decisive and warming embrace.

Asseyez-vous et laissez-vous vous enivrer par l'énergie d'un style moderne et engageant, avec un revêtement en cuir, tissu ou microfibre. MERLOT ne sombre pas dans l'excès et vous accueille tel un grand cru dans l'écrin de ses courbes épurées.



Merlot



Merlot

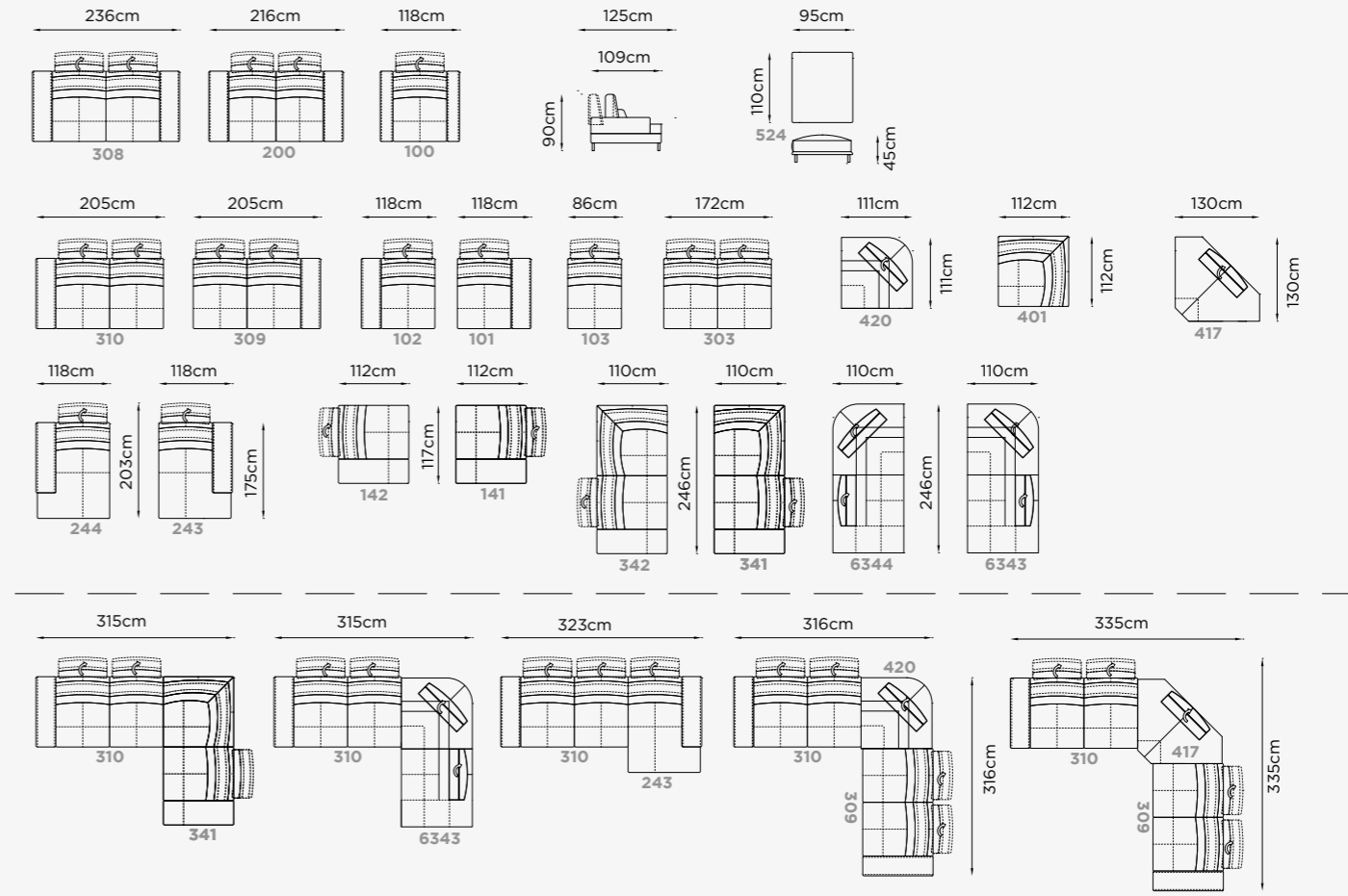

Profondità Depth Profondeur	109/125 cm
Altezza Height Hauteur	90 cm
Profondità seduta Seat Depth Profondeur d'assise	83/59 cm
Altezza bracciolo Arms height Hauteur d'accoudoir	57 cm
Altezza seduta Seat height Hauteur d'assise	43 cm
Altezza piede Leg height Hauteur pied	15 cm

RIVESTIMENTO	COVERING	REVETEMENTS
• Pelle • Tessuto	• Leather • Soft cover	• Cuir • Tissu
PIEDI	LEGS	PIETEMENT
• Metallo 11/26/37/42/46/47/48	• Metal 11/26/37/42/46/47/48	• Métal 11/26/37/42/46/47/48
IMBOTTITURA	FILLING	REMBOURRAGE
BRACCIOLO	ARMS	ACCOUDOIR
CUSCINO SEDUTA	SEAT CUSHION	COUSSIN D'ASSISE
CUSCINO SPALLIERA	BACK CUSHION	COUSSIN DE DOSSIER
• Gomma	• Foam	• Mousse
• Gomma	• Foam	• Mousse
• Memory foam	• Memory foam	• Memory foam
COMFORT	COMFORT	CONFORT
• Standard	• Standard	• Standard
FUNZIONE	FUNCTION	FONCTION
• Schienale regolabile tipo manuale	• Manually adjustable back cushion	• Coussin de dossier à réglage manuel
OPZIONI	OPTION	OPTION
• Cuciture a contrasto	• Contrast stitching	• Coutures contrastées
• Tessuto non sfoderabile	• Not removable cover	• Non déhoussable en tissu

Aladine

Cercare l'essenza della comodità a volte è facile, basta accomodarsi e sfregare una lampada magica. Questo divano caratterizzato dall'imbottitura con memory foam, avvolge confortevolmente grazie anche ai suoi schienali flessibili e basculanti. Scopri ALADINE, il divano geniale, moderno e componibile.

Looking for the essence of comfort is sometimes easy, just sit down and rub a magic lamp. This sofa, characterized by a memory foam padding, will comfortably wrap you up thanks to its flexible and tilting backrests. Discover ALADINE, the ingenious, modern and modular sofa.

Il est parfois facile de rechercher l'essence du confort. Asseyez-vous et frottez une lampe magique. Ce canapé, caractérisé par un rembourrage en mousse à mémoire de forme, enveloppe confortablement grâce à ses dossiers flexibles et basculants. Découvrez ALADINE, le canapé ingénieux, moderne et modulable.



Aladine



Aladine

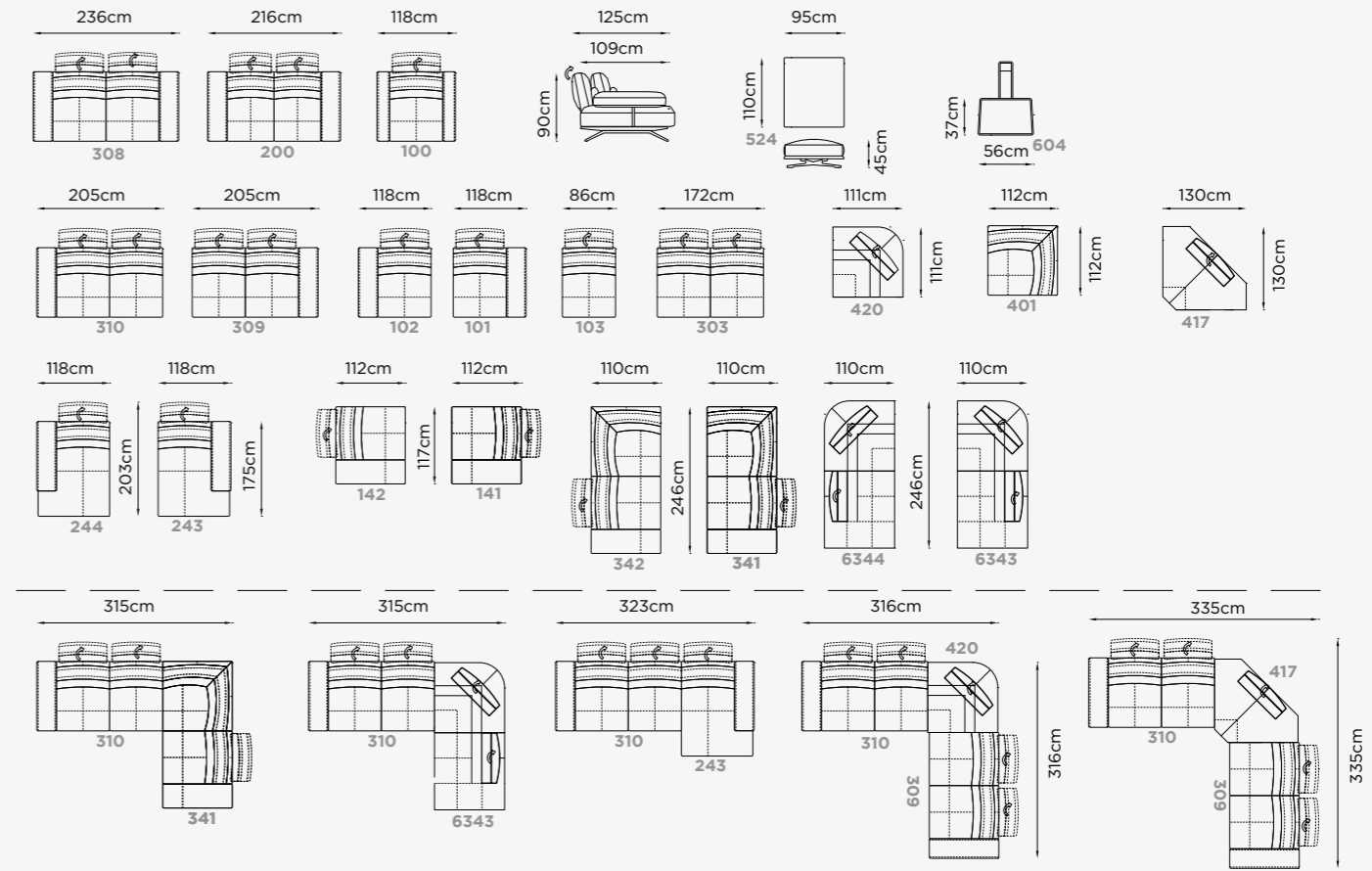

Profondità Depth Profondeur	109/125 cm
Altezza Height Hauteur	90 cm
Profondità seduta Seat Depth Profondeur d'assise	83/59 cm
Altezza bracciolo Arms height Hauteur d'accoudoir	57 cm
Altezza seduta Seat height Hauteur d'assise	43 cm
Altezza piede Leg height Hauteur pied	15 cm

RIVESTIMENTO	COVERING	REVETEMENTS
• Pelle • Tessuto	• Leather • Soft cover	• Cuir • Tissu
PIEDI	LEGS	PIETEMENT
• Metallo 11/26/37/42/46/47/48	• Metal 11/26/37/42/46/47/48	• Métal 11/26/37/42/46/47/48
IMBOTTITURA	FILLING	REMBOURRAGE
BRACCIOLO	ARMS	ACCOUDOIR
CUSCINO SEDUTA	SEAT CUSHION	COUSSIN D'ASSISE
CUSCINO SPALLIERA	BACK CUSHION	COUSSIN DE DOSSIER
• Gomma	• Foam	• Mousse
• Gomma	• Foam	• Mousse
• Gomma	• Memory foam	• Mousse
• Memory foam		
COMFORT	COMFORT	CONFORT
• Standard	• Standard	• Standard
FUNZIONE	FUNCTION	FONCTION
• Schienale regolabile tipo manuale	• Manually adjustable back cushion	• Coussin de dossier à réglage manuel
• Bracciolo regolabile tipo manuale	• Manually adjustable arm	• Accoudoir à réglage manuel
OPZIONI	OPTION	OPTION
• Cuciture a contrasto	• Contrast stitching	• Coutures contrastées
• Tessuto non sfoderabile	• Not removable cover	• Non déhoussable en tissu

Sonya

Bello far festa e condividere il divertimento, ma nulla potrà eguagliare quel momento in cui ci si lascia finalmente andare sul divano di casa. Dona confort alle tue giornate con la funzione relax e goditi una identità piena di estro. SONYA è un divano modulare che non annoia mai, grazie alla sua vasta gamma di colori e rivestimenti.

Share the fun with your friends; however nothing can match that moment when you finally let yourself sink on the couch at home. SONYA is the modular sofa that thanks to its function provides you with extra comfort to your long days.

Sympa de faire la fête et de partager du plaisir, mais rien ne peut rivaliser avec ce moment où vous vous laissez finalement aller sur le canapé à la maison. Donnez du confort à vos journées avec la fonction relax et profitez d'une personnalité pleine d'inspiration. SONYA est un canapé modulaire qui ne s'ennuie jamais, grâce à sa large gamme de couleurs et de revêtements.



Sonya



Sonya



Sonya



Sonya

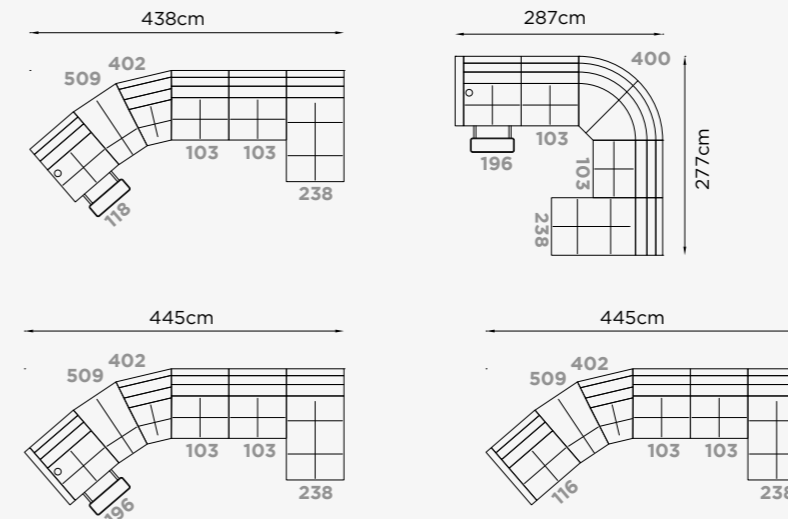
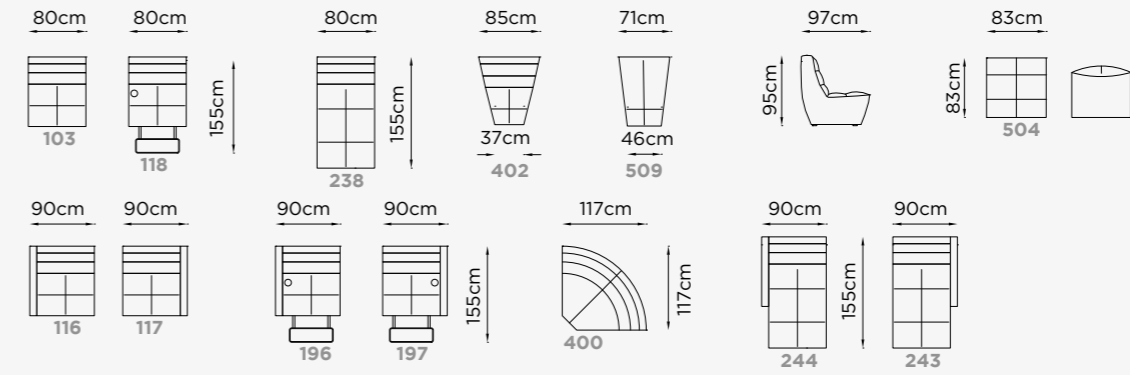

Profondità Depth Profondeur	97 cm
Altezza Height Hauteur	95 cm
Profondità seduta Seat Depth Profondeur d'assise	53 cm
Altezza bracciolo Arms height Hauteur d'accoudoir	58 cm
Altezza seduta Seat height Hauteur d'assise	45 cm
Altezza piede Leg height Hauteur pied	3 cm

RIVESTIMENTO			COVERING			REVETEMENTS		
• Pelle • Tessuto			• Leather • Soft cover			• Cuir • Tissu		
PIEDI			LEGS			PIETEMENT		
• Plastica			• Plastic			• Plastique		
IMBOTTITURA			FILLING			REMBOURRAGE		
BRACCIOLO	CUSCINO SEDUTA	CUSCINO SPALLIERA	ARMS	SEAT CUSHION	BACK CUSHION	ACCOUDOIR	COUSSIN D'ASSISE	COUSSIN DE DOSSIER
• Gomma	• Gomma	• Gomma	• Foam	• Foam	• Foam	• Mousse	• Mousse	• Mousse
COMFORT			COMFORT			CONFORT		
• Standard • Hard			• Standard • Hard			• Standard • Ferme		
FUNZIONE			FUNCTION			FONCTION		
• Seduta recliner elettrica			• Electric recliner system			• Système relax électrique		
OPZIONI			OPTION			OPTION		
• Cuciture a contrasto • Tessuto sfoderabile			• Contrast stitching • Removable cover			• Coutures contrastées • Déhoussable en tissu		

Eliot / Dadaumpa

Elegante come un ballerino, sinuoso come una danzatrice. Dopo l'energia del movimento in musica, la meritata funzione relax per ricaricare le batterie. Poi di nuovo in pista, ma quando vuoi, cambia le regole: sposta i moduli come preferisci per il prossimo ELIOT.

Elegant as a dancer. And after the hectic activity of a busy day, the well-deserved relax function to recharge the batteries. Then again on the track, but when you want, change the rules: move the modules as you prefer for the next ELIOT.

Élégant et sinueux comme un danseur. Après l'énergie du mouvement en musique, la fonction de relaxation vous permettra de recharger les batteries. Puis encore sur la piste, mais quand vous voulez, changez les règles: déplacez les modules comme vous préférez pour le prochain ELIOT.



Eliot / Dadaumpa



Eliot / Dadaumpa



Eliot / Dadaumpa

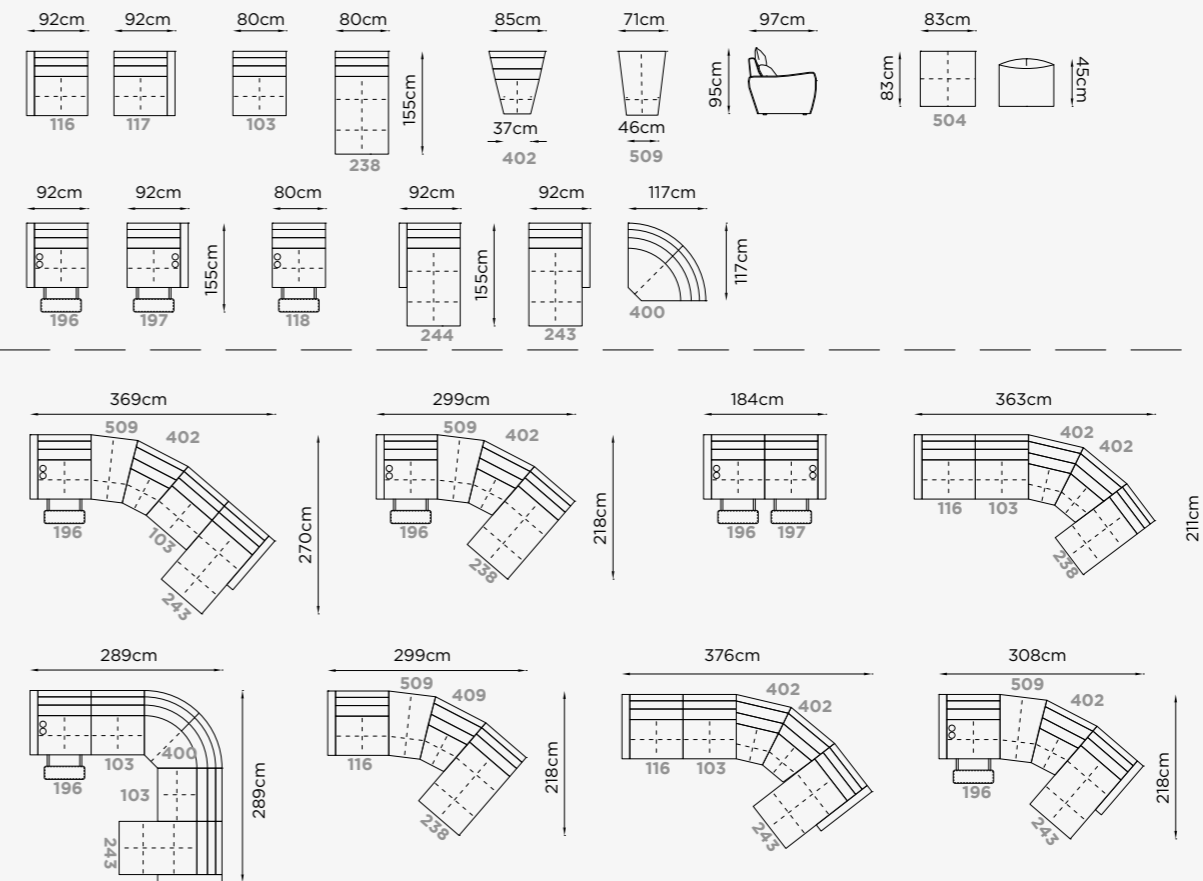

Profondità Depth Profondeur	97 cm
Altezza Height Hauteur	95 cm
Profondità seduta Seat Depth Profondeur d'assise	53 cm
Altezza bracciolo Arms height Hauteur d'accoudoir	58 cm
Altezza seduta Seat height Hauteur d'assise	45 cm
Altezza piede Leg height Hauteur pied	3 cm



RIVESTIMENTO			COVERING			REVETEMENTS		
• Pelle • Tessuto			• Leather • Soft cover			• Cuir • Tissu		
PIEDI			LEGS			PIETEMENT		
• Plastica			• Plastic			• Plastique		
IMBOTTITURA			FILLING			REMBOURRAGE		
BRACCIOLO	CUSCINO SEDUTA	CUSCINO SPALLIERA	ARMS	SEAT CUSHION	BACK CUSHION	ACCOUDOIR	COUSSIN D'ASSISE	COUSSIN DE DOSSIER
• Gomma	• Gomma	• Gomma	• Foam	• Foam	• Foam	• Mousse	• Mousse	• Mousse
COMFORT			COMFORT			CONFORT		
• Standard • Hard			• Standard • Hard			• Standard • Ferme		
FUNZIONE			FUNCTION			FONCTION		
• Seduta recliner elettrica			• Electric recliner system			• Système relax électrique		
OPZIONI			OPTION			OPTION		
• Cuciture a contrasto • Tessuto sfoderabile • Disponibile bracciolo del modello DADAUMPA			• Contrast stitching • Removable cover • DADAUMPA's arm available on this model			• Coutures contrastées • Déhoussable en tissu • L'accoudoir DADAUMPA disponible sus ce produit		

Noto

I morbidi rivestimenti avvolgono un solido fusto in legno con dei piedi a scomparsa, per sostenerti in totale comodità.
NOTO è il divano modulare che unisce creatività a uno stile moderno.

The refined upholstery and soft padding envelop a solid wooden frame, with hidden feet.
NOTO is a modular sofa that combines creativity with a modern style.

Des revêtements souples enveloppent un cadre en bois massif, reposant sur des pieds cachés.
NOTO est le canapé modulaire qui allie créativité et style moderne.



Noto



Noto



Noto

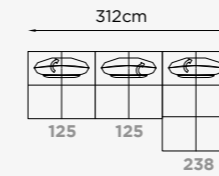
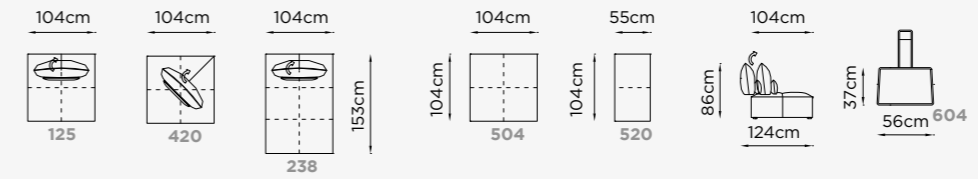

Profondità Depth Profondeur	104/124 cm
Altezza Height Hauteur	86 cm
Profondità seduta Seat Depth Profondeur d'assise	62/87 cm
Altezza seduta Seat height Hauteur d'assise	39 cm
Altezza piede Leg height Hauteur pied	3 cm

RIVESTIMENTO	COVERING	REVETEMENTS
• Pelle • Tessuto	• Leather • Soft cover	• Cuir • Tissu
PIEDI	LEGS	PIETEMENT
• Plastica	• Plastic	• Plastique
IMBOTTITURA	FILLING	REMBOURRAGE
CUSCINO SEDUTA	SEAT CUSHION	COUSSIN D'ASSISE
CUSCINO SPALLIERA	BACK CUSHION	COUSSIN DE DOSSIER
• Gomma • Piuma	• Foam • Feather	• Mousse • Plume
COMFORT	COMFORT	CONFORT
• Standard • Hard	• Standard • Hard	• Standard • Ferme
FUNZIONE	FUNCTION	FONCTION
• Spalliera regolabile tipo manuale	• Manually adjustable back cushion	• Coussin de dossier à réglage manuel
OPZIONI	OPTION	OPTION
• Tessuto non sfoderabile	• Not removable cover	• Non déhoussable en tissu

Via Gluck

Lo stile casual si lascia andare ad una eleganza da vivere tutti i giorni, grazie al suo confort e alla possibilità di distendere corpo e mente con la funzione relax.

The casual style matches well with the everyday comfort of its seating, where the soft padding and the relax function ease your body and mind.

Le style décontracté donne au quotidien une élégance de vie: profitez vous de son confort détendant le corps et l'esprit grâce à la fonction de relaxation.

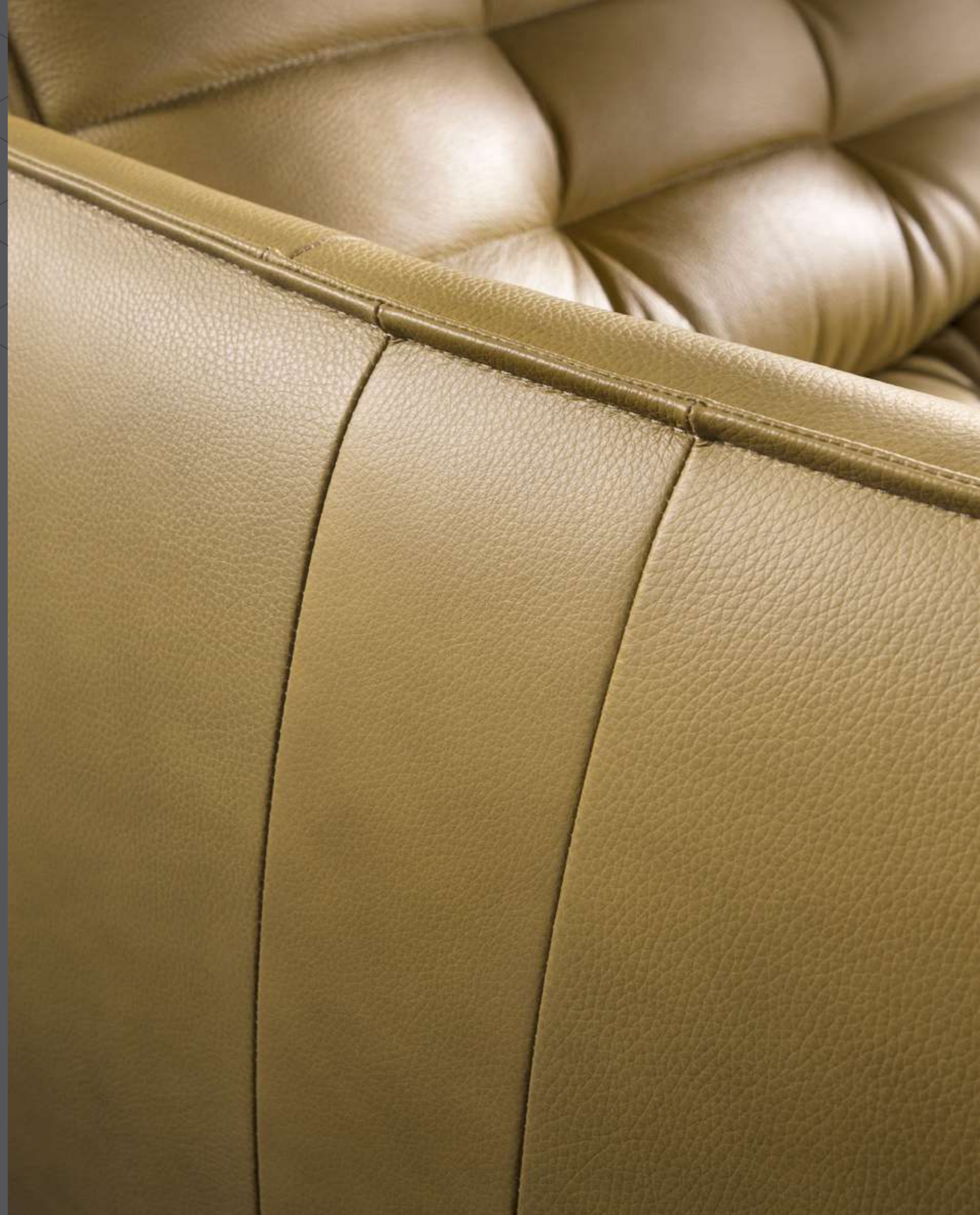

Via Gluck



Via Gluck

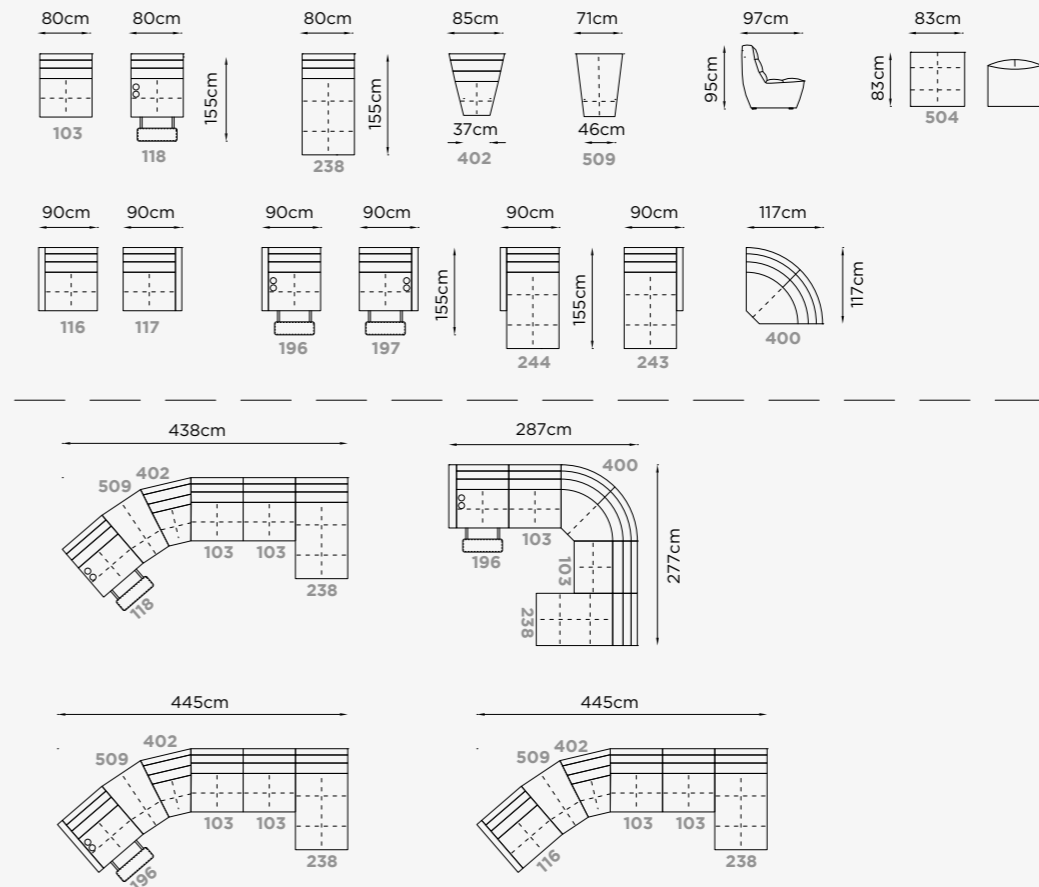

Profondità Depth Profondeur	97 cm
Altezza Height Hauteur	95 cm
Profondità seduta Seat Depth Profondeur d'assise	53 cm
Altezza bracciolo Arms height Hauteur d'accoudoir	56/75 cm
Altezza seduta Seat height Hauteur d'assise	45 cm
Altezza piede Leg height Hauteur pied	3 cm

RIVESTIMENTO			COVERING			REVETEMENTS		
• Pelle • Tessuto			• Leather • Soft cover			• Cuir • Tissu		
PIEDI			LEGS			PIETEMENT		
• Plastica			• Plastic			• Plastique		
IMBOTTITURA			FILLING			REMBOURRAGE		
BRACCIOLO	CUSCINO SEDUTA	CUSCINO SPALLIERA	ARMS	SEAT CUSHION	BACK CUSHION	ACCOUDOIR	COUSSIN D'ASSISE	COUSSIN DE DOSSIER
• Gomma	• Gomma	• Gomma	• Foam	• Foam	• Foam	• Mousse	• Mousse	• Mousse
COMFORT			COMFORT			CONFORT		
• Standard • Hard			• Standard • Hard			• Standard • Ferme		
FUNZIONE			FUNCTION			FONCTION		
• Seduta recliner elettrica			• Electric recliner system			• Système relax électrique		
OPZIONI			OPTION			OPTION		
• Cuciture a contrasto • Tessuto sfoderabile			• Contrast stitching • Removable cover			• Coutures contrastées • Déhoussable en tissu		

Lennon

Immagina un divano che ispiri pace, felicità e comodità. Immagina di non dover più sentire la testa pesante perché una soffice nuvola ti aiuta a tenerla su con dolcezza. Immagina il confort dei poggiatesta per sostenere la tua schiena. Immagina di vivere un divano componibile con schienali basculanti. Immagina LENNON.

Imagine a sofa that inspires peace, happiness and comfort. Imagine not having to feel the heavy head anymore because a soft cloud helps you to hold it up gently. Imagine the comfort of the backrests to support your back. Imagine living a modular sofa with tilting backs. Imagine LENNON.

Imaginez un canapé qui inspire la paix, le bonheur et le confort. Imaginez votre tête reposant sur un nuage léger. Imaginez le confort des dossiers qui soutiennent votre dos. Imaginez-vous en train de vivre dans un canapé modulaire à dossiers basculants. Imaginez LENNON.



Lennon



Lennon



Lennon

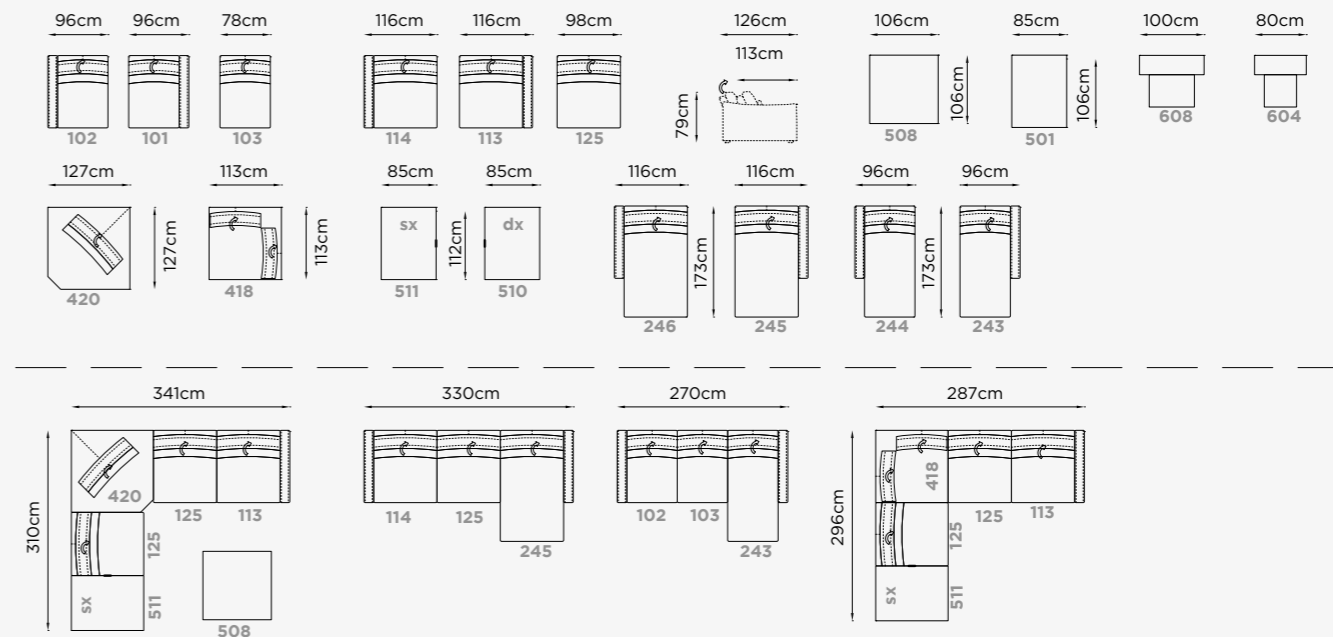

Profondità Depth Profondeur	113/126 cm
Altezza Height Hauteur	79 cm
Profondità seduta Seat Depth Profondeur d'assise	62/88 cm
Altezza bracciolo Arms height Hauteur d'accoudoir	60 cm
Altezza seduta Seat height Hauteur d'assise	41 cm
Altezza piede Leg height Hauteur pied	4 cm

RIVESTIMENTO			COVERING			REVETEMENTS		
• Tessuto			• Soft cover			• Tissu		
PIEDI			LEGS			PIETEMENT		
• Plastica			• Plastic			• Plastique		
IMBOTTITURA			FILLING			REMBOURRAGE		
BRACCIOLO	CUSCINO SEDUTA	CUSCINO SPALLIERA	ARMS	SEAT CUSHION	BACK CUSHION	ACCOUDOIR	COUSSIN D'ASSISE	COUSSIN DE DOSSIER
• Gomma	• Gomma • Molle insachettate	• Gomma	• Foam	• Foam • Pocket Spring	• Foam	• Mousse	• Mousse • Ressorts ensachés	• Mousse
COMFORT			COMFORT			CONFORT		
• Standard			• Standard			• Standard		
FUNZIONE			FUNCTION			FONCTION		
• Spalliera regolabile tipo manuale • Poggiatesta regolabile tipo manuale			• Manually adjustable back cushion • Manually adjustable headrest			• Coussin de dossier à réglage manuel • Appui-tete à réglage manuel		
OPZIONI			OPTION			OPTION		
• Cuciture a contrasto • Tessuto non sfoderabile			• Contrast stitching • Not removable cover			• Coutures contrastées • Non déhoussable en tissu		

Nicole

Imbottiture ancora più morbide, grazie al supporto in memory foam, avvolgono le vostre forme. Gli schienali in piuma invece, rendono il tuo confort soffice e leggero senza rinunciare alla libertà di avere sedute e schienali sfoderabili. L'eleganza di NICOLE sposa alla perfezione funzionalità e comodità.

The soft support of the memory foam padding represents the added value of this corner sofa that with the addition of the feather let you enjoy a comfort that makes you feel light without renouncing to removable backs and seats cushions. NICOLE's elegance fits perfectly with its comfort and functionality.

Rembourrage encore plus doux grâce au support en mousse à mémoire, pour épouser vos formes. Les dossiers en plumes vous attendent pour un confort qui vous permet de vous sentir léger sans renoncer à la liberté d'avoir des assises et des dossiers amovibles. L'élégance de NICOLE marie à la perfection fonctionnalité et confort.



Nicole



Nicole



Nicole

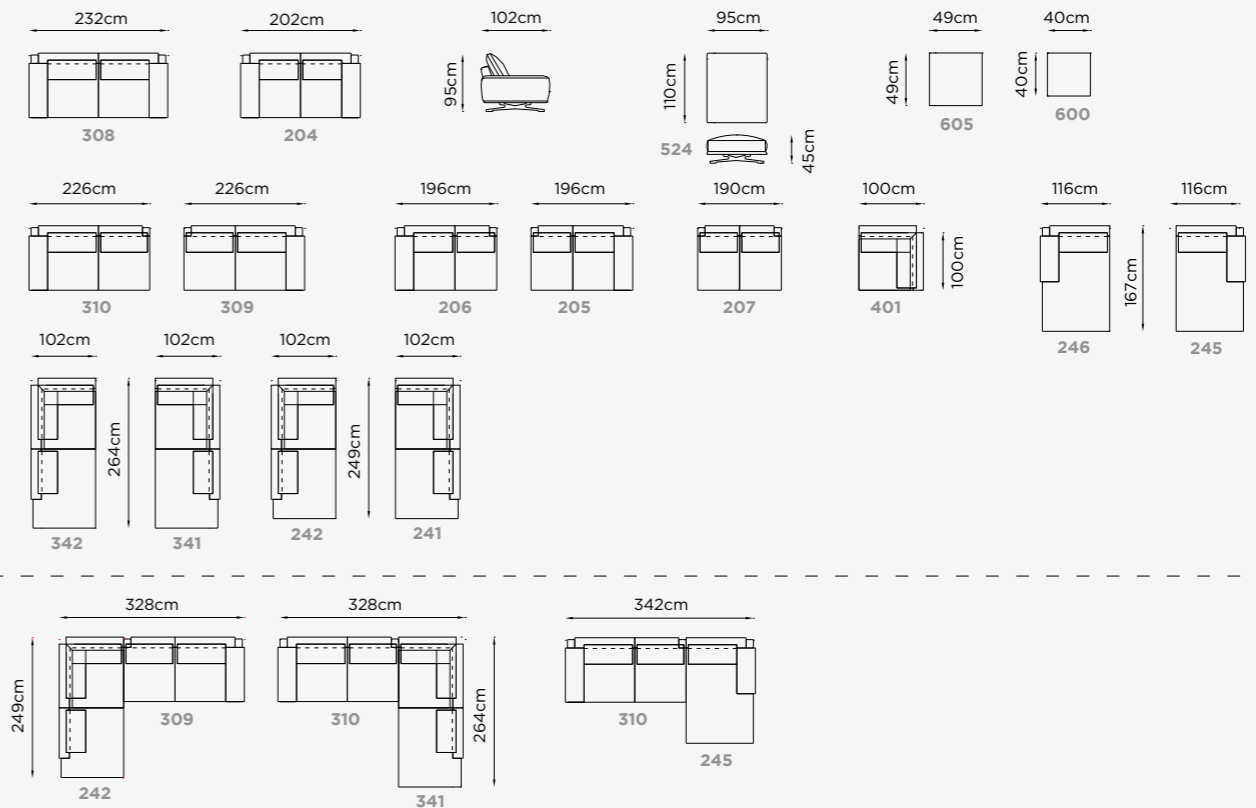

Profondità Depth Profondeur	102 cm
Altezza Height Hauteur	95 cm
Profondità seduta Seat Depth Profondeur d'assise	60 cm
Altezza bracciolo Arms height Hauteur d'accoudoir	61 cm
Altezza seduta Seat height Hauteur d'assise	45 cm
Altezza piede Leg height Hauteur pied	17 cm

RIVESTIMENTO			COVERING			REVETEMENTS		
• Pelle • Tessuto			• Leather • Soft cover			• Cuir • Tissu		
PIEDI			LEGS			PIETEMENT		
• Metallo 10/11/26/37/42			• Metal 10/11/26/37/42			• Métal 10/11/26/37/42		
IMBOTTITURA			FILLING			REMBOURRAGE		
BRACCIOLO	CUSCINO SEDUTA	CUSCINO SPALLIERA	ARMS	SEAT CUSHION	BACK CUSHION	ACCOUDOIR	COUSSIN D'ASSISE	COUSSIN DE DOSSIER
• Gomma	• Gomma • Memory foam	• Gomma	• Foam	• Foam • Memory foam	• Foam	• Mousse	• Mousse • Memory foam	• Mousse
COMFORT			COMFORT			CONFORT		
• Standard			• Standard			• Standard		
OPZIONI			OPTION			OPTION		
• Cuciture a contrasto • Tessuto parzialmente sfoderabile			• Contrast stitching • Partially removable cover			• Coutures contrastées • Tissu partiellement amovible		

Fontana

A volte bisogna risalire all'origine seguendo un filo conduttore, unendo tutti i punti in un tratteggio rappresentativo della realtà. L'incontro tra il confort e la semplicità del modello FONTANA è un po' il risultato di questa ricerca, grazie al suo design compatto moderno e componibile.

Sometimes it is necessary to go back to the origin joining all the points in a representation of the reality. The meeting between the comfort and simplicity of the FONTANA model is a bit the result of this research, thanks to its compact modern and modular design.

Parfois, il est nécessaire de retrouver l'origine en suivant le fil conducteur qui relie les points d'une image pour en dessiner la réalité. La rencontre entre le confort et la simplicité du modèle FONTANA est un peu le résultat de cette quête, grâce à son design compact, moderne et modulaire.





Fontana

Fontana



Fontana

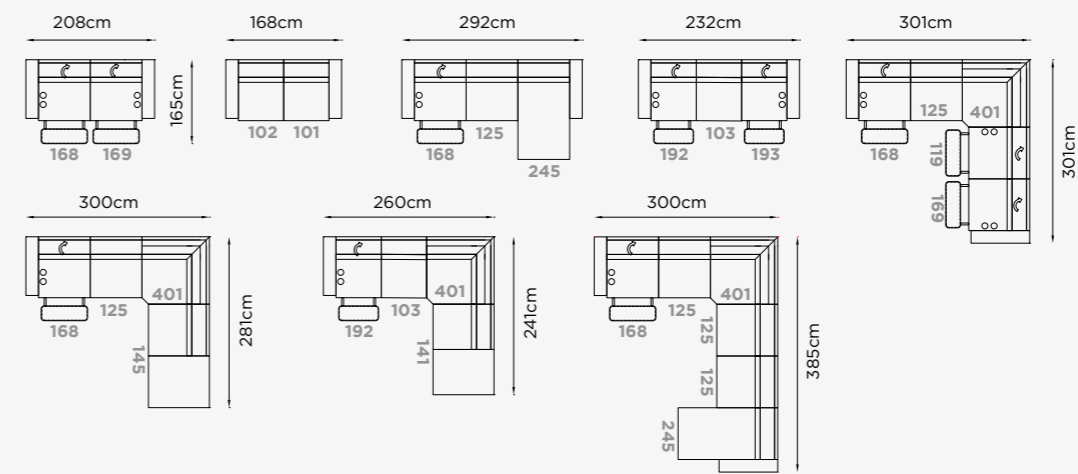
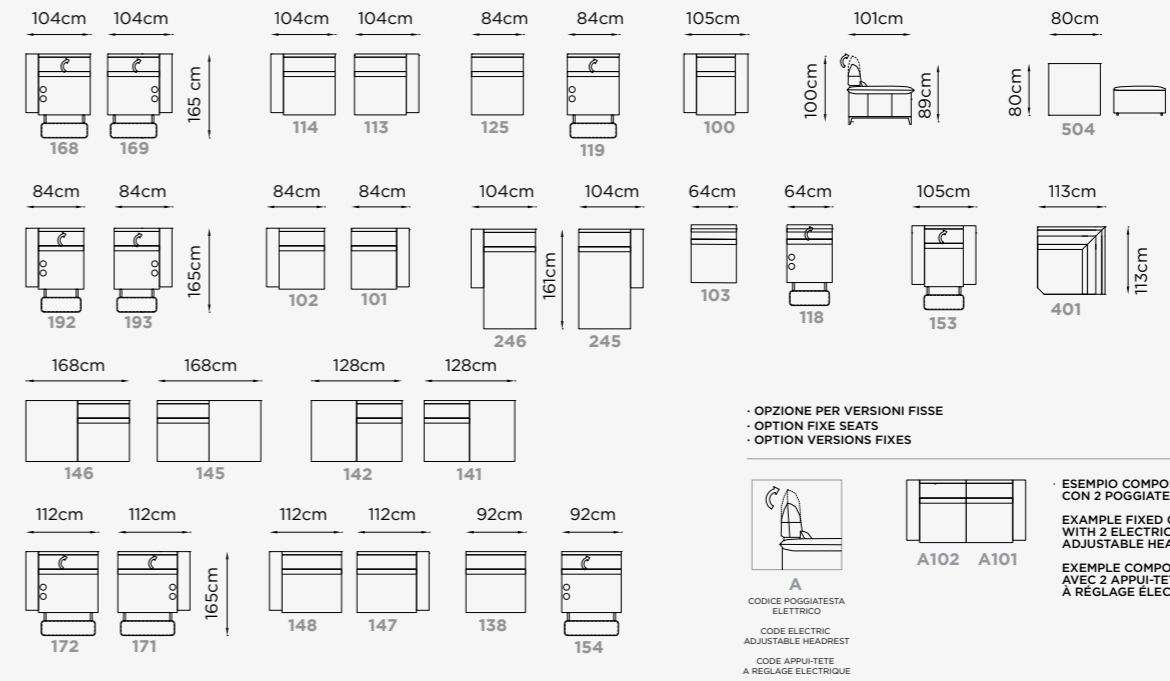

Profondità Depth Profondeur	101/165 cm
Altezza Height Hauteur	89/100 cm
Profondità seduta Seat Depth Profondeur d'assise	60 cm
Altezza bracciolo Arms height Hauteur d'accoudoir	58/66 cm
Altezza seduta Seat height Hauteur d'assise	42 cm
Altezza piede Leg height Hauteur pied	12 cm

RIVESTIMENTO	COVERING	REVETEMENTS
• Pelle • Tessuto	• Leather • Soft cover	• Cuir • Tissu
PIEDI	LEGS	PIETEMENT
• Metallo 11/26/37/42/46/47/48/49	• Metal 11/26/37/42/46/47/48/49	• Métal 11/26/37/42/46/47/48/49
IMBOTTITURA	FILLING	REMBOURRAGE
BRACCIOLO CUSCINO SEDUTA CUSCINO SPALLIERA	ARMS SEAT CUSHION BACK CUSHION	ACCOUDOIR COUSSIN D'ASSISE COUSSIN DE DOSSIER
• Gomma • Gomma • Gomma	• Foam • Foam • Foam	• Mousse • Mousse • Mousse
COMFORT	COMFORT	CONFORT
• Standard	• Standard	• Standard
FUNZIONE	FUNCTION	FONCTION
• Sistema reclinare elettrico doppio motore • Poggiatesta regolabile elettrico	• Electric recliner system dual motor • Electric adjustable headrest	• Système relax électrique bi-moteur • Appui-tete à réglage électrique
OPZIONI	OPTION	OPTION
• Cuciture a contrasto • Tessuto non sfoderabile • Poggiatesta regolabile elettrico nelle versioni fisse	• Contrast stitching • Not removable cover • Electric adjustable headrest on fixe seats	• Coutures contrastées • Non déhoussable en tissu • Appui-tete à réglage électrique dans les versions fixes

Nazaro

Fai scorrere i tuoi pensieri grazie alla funzione poggiatesta con sistema lift che, insieme al cricchetto, regala una nuova esperienza di relax. Le sue linee semplici e regolari sono arricchite dal dettaglio artigianale di un inserto in legno. Con NAZARO, la comodità è un vero sollievo.

Let your thoughts flow thanks to the headrest function with a lift system that, along with the ratchet, offers a new relaxation experience. Its simple and regular lines are enriched by the handcrafted detail of a wooden insert. With NAZARO, comfort is a real relief.

Laissez libre cours à vos pensées grâce à la fonction appui-tête dotée d'un système lift électrique et crémaillère manuelle qui vous offre une nouvelle expérience de relaxation. Ses lignes simples et régulières sont enrichies par le détail artisanal d'un insert en bois. Avec NAZARO, le confort est un réel soulagement.



Nazaro



Nazaro

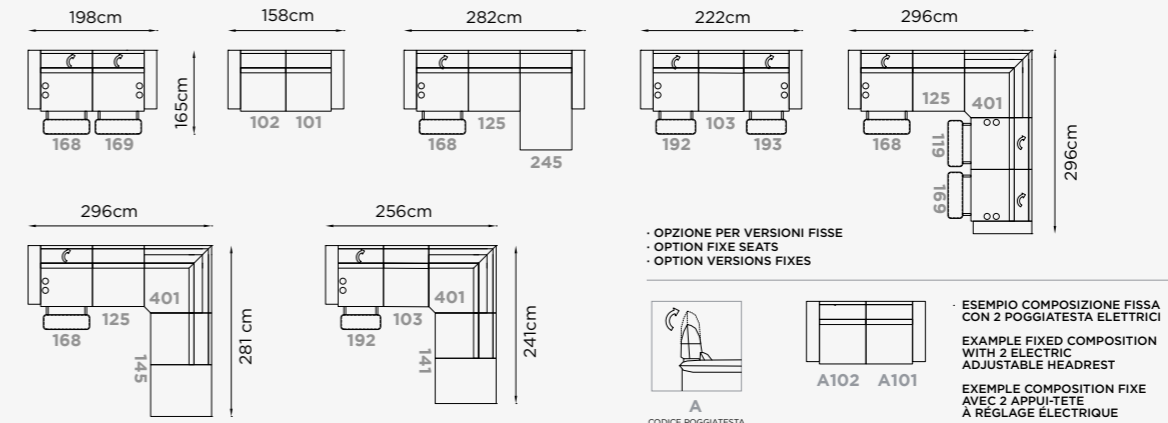
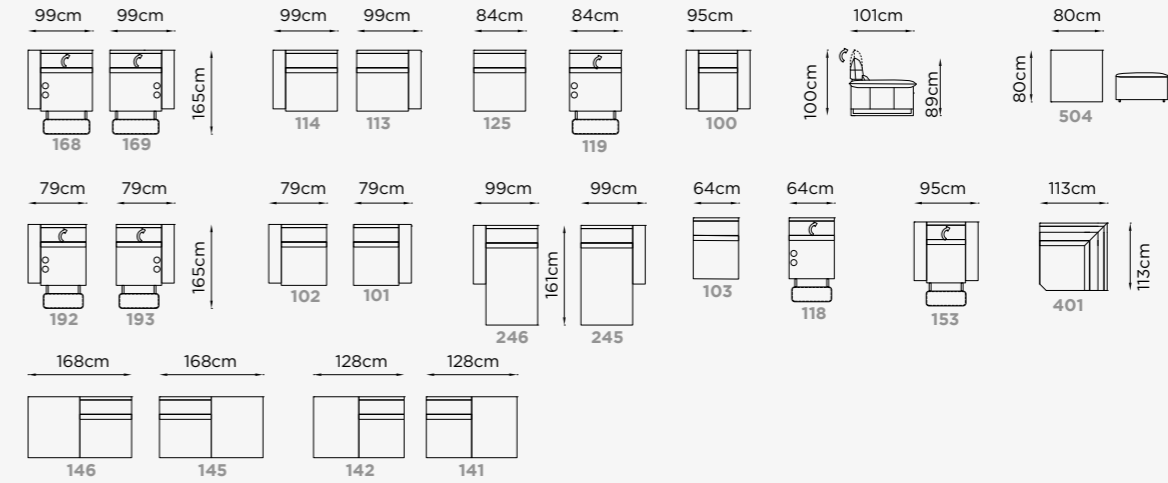

Profondità Depth Profondeur	101/165 cm
Altezza Height Hauteur	89/100 cm
Profondità seduta Seat Depth Profondeur d'assise	60 cm
Altezza bracciolo Arms height Hauteur d'accoudoir	58/66 cm
Altezza seduta Seat height Hauteur d'assise	42 cm
Altezza piede Leg height Hauteur pied	12 cm

RIVESTIMENTO	COVERING	REVETEMENTS
• Pelle • Tessuto	• Leather • Soft cover	• Cuir • Tissu
PIEDI	LEGS	PIETEMENT
• Metallo 11/26/37/42/46/47/48/49	• Metal 11/26/37/42/46/47/48/49	• Métal 11/26/37/42/46/47/48/49
Profilo in legno su braccio	Wood profile arm	Profilo en bois sur l'accoudoir
IMBOTTITURA	FILLING	REMBOURRAGE
BRACCIOLO CUSCINO SEDUTA CUSCINO SPALLIERA	ARMS SEAT CUSHION BACK CUSHION	ACCOUDOIR COUSSIN D'ASSISE COUSSIN DE DOSSIER
• Gomma • Gomma • Gomma	• Foam • Foam • Foam	• Mousse • Mousse • Mousse
COMFORT	COMFORT	CONFORT
• Standard	• Standard	• Standard
FUNZIONE	FUNCTION	FONCTION
• Sistema reclinare elettrico doppio motore • Poggiatesta regolabile elettrico	• Electric recliner system dual motor • Electric adjustable headrest	• Système relax électrique bi-moteur • Appui-tete à réglage électrique
OPZIONI	OPTION	OPTION
• Cuciture a contrasto • Tessuto non sfoderabile • Poggiatesta regolabile elettrico nelle versioni fisse	• Contrast stitching • Not removable cover • Electric adjustable headrest on fixe seats	• Coutures contrastées • Non déhoussable en tissu • Appui-tete à réglage électrique dans les versions fixes

Alicudi

Il design non risponde a regole ma ad esigenze. ALICUDI è una poltrona moderna, con grandi ambizioni grazie al suo pouf che sarà in grado di farti rilassare avvolgendoti con il suo comfort. Disponibile con piedi in metallo, versione girevole o base in legno.

Design is not responsive to rules but to needs. ALICUDI is one modern armchair, with great ambitions thanks to its pouf that will be able to make you relax, wrapping you with its comfort. Available with metal feet, swivel or wooden base.

Le design n'est pas sensible aux règles mais aux besoins. ALICUDI est un fauteuil moderne, avec de grandes ambitions grâce à son pouf qui sera capable de vous offrir la meilleure détente tout en vous enveloppant de son confort. Disponible avec pieds métal, version pivotante ou base en bois.



Alicudi



Alicudi



Alicudi

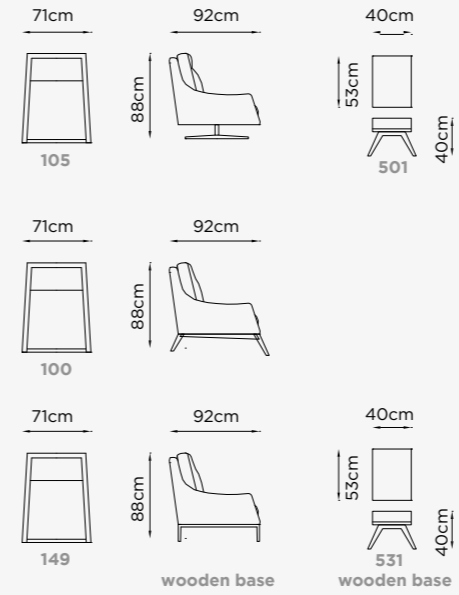

Profondità Depth Profondeur	92 cm
Altezza Height Hauteur	88 cm
Profondità seduta Seat Depth Profondeur d'assise	55 cm
Altezza bracciolo Arms height Hauteur d'accoudoir	52 cm
Altezza seduta Seat height Hauteur d'assise	44 cm
Altezza piede Leg height Hauteur pied	18 cm

RIVESTIMENTO			COVERING			REVETEMENTS		
• Pelle • Tessuto			• Leather • Soft cover			• Cuir • Tissu		
PIEDI			LEGS			PIETEMET		
• Metallo 11/26/37/42/47/49			• Metal 11/26/37/42/47/49			• Métal 11/26/37/42/47/49		
• Legno 04/06/12/18			• Wood 04/06/12/18			• Bois 04/06/12/18		
IMBOTTITURA			FILLING			REMBOURRAGE		
BRACCIOLO	CUSCINO SEDUTA	CUSCINO SPALLIERA	ARMS	SEAT CUSHION	BACK CUSHION	ACCOUDOIR	COUSSIN D'ASSISE	COUSSIN DE DOSSIER
• Gomma	• Gomma	• Gomma	• Foam	• Foam	• Foam	• Mousse	• Mousse	• Mousse
COMFORT			COMFORT			CONFORT		
• Standard			• Standard			• Standard		
OPZIONI			OPTION			OPTION		
• Cuciture a contrasto • Tessuto non sfoderabile			• Contrast stitching • Not removable cover			• Coutures contrastées • Non déhoussable en tissu		

Filicudi

Dalla linee semplici ed eleganti, FILICUDI è una poltrona moderna caratterizzata da un comodo poggiatesta in grado di regalarti il massimo del benessere grazie a suo delicato comfort. Disponibile con piedi in metallo, versione girevole o base in legno.

With simple and elegant lines FILICUDI is a modern armchair equipped with comfortable lumbar support that can give you maximum well-being thanks to its delicate comfort. Available with metal feet, swivel version or wooden base.

Avec des lignes simples et élégantes FILICUDI est un fauteuil moderne caractérisé par un support lombaire confortable qui peut vous apporter un maximum de bien-être grâce à son confort délicat. Disponible avec des pieds en métal, version pivotante ou base en bois.



Filicudi

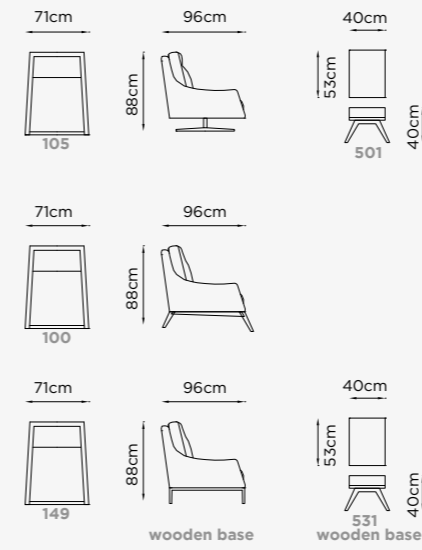

Profondità Depth Profondeur	92 cm
Altezza Height Hauteur	88 cm
Profondità seduta Seat Depth Profondeur d'assise	55 cm
Altezza bracciolo Arms height Hauteur d'accouoir	52 cm
Altezza seduta Seat height Hauteur d'assise	44 cm
Altezza piede Leg height Hauteur pied	18 cm

RIVESTIMENTO			COVERING			REVETEMENTS		
• Pelle • Tessuto			• Leather • Soft cover			• Cuir • Tissu		
PIEDI			LEGS			PIETEMENT		
• Metallo 11/26/37/42/47/49			• Metal 11/26/37/42/47/49			• Métal 11/26/37/42/47/49		
• Legno 04/06/12/18			• Wood 04/06/12/18			• Bois 04/06/12/18		
IMBOTTITURA			FILLING			REMBOURRAGE		
BRACCIOLLO	CUSCINO SEDUTA	CUSCINO SPALLIERA	ARMS	SEAT CUSHION	BACK CUSHION	ACCOUDOIR	COUSSIN D'ASSISE	COUSSIN DE DOSSIER
• Gomma	• Gomma	• Gomma	• Foam	• Foam	• Foam	• Mousse	• Mousse	• Mousse
COMFORT			COMFORT			CONFORT		
• Standard			• Standard			• Standard		
OPZIONI			OPTION			OPTION		
• Cuciture a contrasto • Tessuto non sfoderabile			• Contrast stitching • Not removable cover			• Coutures contrastées • Non déhoussable en tissu		

Lipari

Il confort incontra la sobrietà in questa poltrona semplice ed originale. Disponibile con piedi in metallo, versione girevole o base in legno, LIPARI rappresenta la giusta sintesi tra linearità ed eleganza.

Comfort meets sobriety in this simple and original armchair. Available with metal feet, swivel version or wooden base, LIPARI represents the proper match between linearity and elegance.

Le confort rencontre la sobriété dans ce fauteuil simple et original. Disponible avec des pieds en métal, version pivotante ou base en bois, LIPARI représente la bonne synthèse entre linéarité et élégance.



Lipari

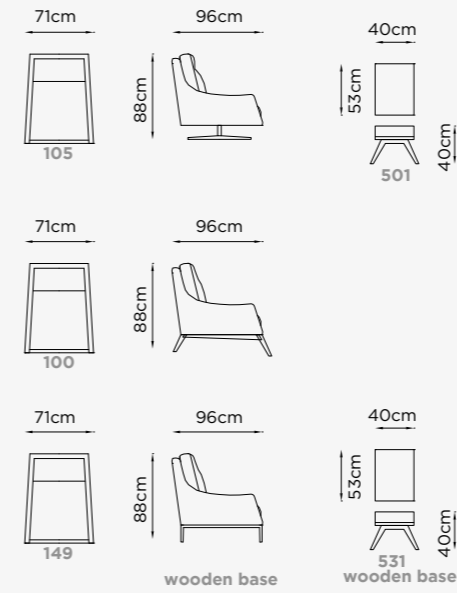

Profondità Depth Profondeur	92 cm
Altezza Height Hauteur	88 cm
Profondità seduta Seat Depth Profondeur d'assise	55 cm
Altezza bracciolo Arms height Hauteur d'accoudoir	52 cm
Altezza seduta Seat height Hauteur d'assise	44 cm
Altezza piede Leg height Hauteur pied	18 cm

RIVESTIMENTO			COVERING			REVETEMENTS		
• Pelle • Tessuto			• Leather • Soft cover			• Cuir • Tissu		
PIEDI			LEGS			PIETEMET		
• Metallo 11/26/37/42/47/49			• Metal 11/26/37/42/47/49			• Métal 11/26/37/42/47/49		
• Legno 04/06/12/18			• Wood 04/06/12/18			• Bois 04/06/12/18		
IMBOTTITURA			FILLING			REMBOURRAGE		
BRACCIOLO	CUSCINO SEDUTA	CUSCINO SPALLIERA	ARMS	SEAT CUSHION	BACK CUSHION	ACCOUDOIR	COUSSIN D'ASSISE	COUSSIN DE DOSSIER
• Gomma	• Gomma	• Gomma	• Foam	• Foam	• Foam	• Mousse	• Mousse	• Mousse
COMFORT			COMFORT			CONFORT		
• Standard			• Standard			• Standard		
OPZIONI			OPTION			OPTION		
• Cuciture a contrasto • Tessuto non sfoderabile			• Contrast stitching • Not removable cover			• Coutures contrastées • Non déhoussable en tissu		

Gerard

La professionalità richiede dedizione e passione, ma anche la capacità di capire quando è il momento giusto per lasciarsi andare. Accomodati, porta indietro le spalle e chiudi gli occhi un momento. GERARD è una poltrona moderna dal gusto leggermente retrò, con grandi ambizioni: far rilassare e al tempo stesso mantenere alta la concentrazione.

Professionalism requires dedication and passion, but also the ability to understand when it is the right time to indulge. Take a seat, bring your shoulders back and close your eyes for a moment. GERARD is a modern armchair with a slightly retro taste to relax and at the same time maintain a high level of concentration.

Le professionnalisme exige dévouement et passion, mais aussi la capacité de savoir se laisser aller. Asseyez-vous, ramenez vos épaules en arrière et fermez les yeux un instant. GERARD est un fauteuil moderne au goût vintage, avec de grandes ambitions: détendre tout en garantissant une concentration élevée.



Gerard

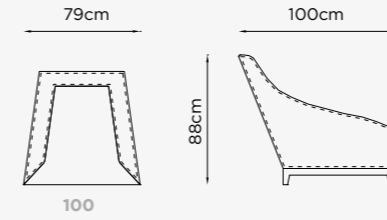

Profondità Depth Profondeur	88 cm
Altezza Height Hauteur	100 cm
Profondità seduta Seat Depth Profondeur d'assise	56 cm
Altezza seduta Seat height Hauteur d'assise	40 cm
Altezza piede Leg height Hauteur pied	11 cm

RIVESTIMENTO			COVERING			REVETEMENTS		
• Pelle • Tessuto			• Leather • Soft cover			• Cuir • Tissu		
PIEDI			LEGS			PIETEMET		
• Metallo 10/11			• Metal 10/11			• Métal 10/11		
IMBOTTITURA			FILLING			REMBOURRAGE		
BRACCIOLO	CUSCINO SEDUTA	CUSCINO SPALLIERA	ARMS	SEAT CUSHION	BACK CUSHION	ACCOUDOIR	COUSSIN D'ASSISE	COUSSIN DE DOSSIER
• Gomma	• Gomma	• Gomma	• Foam	• Foam	• Foam	• Mousse	• Mousse	• Mousse
COMFORT			COMFORT			CONFORT		
• Standard			• Standard			• Standard		
OPZIONI			OPTION			OPTION		
• Cuciture a contrasto • Tessuto non sfoderabile			• Contrast stitching • Not removable cover			• Coutures contrastées • Non déhoussable en tissu		

Alfa

Senza le condizioni giuste, alcune grandi idee non vedrebbero mai la luce. La creatività richiede una buona dose di comodità, sia in casa che a lavoro. Ideale per l'ufficio, perfetta per un appartamento dallo stile moderno, ALFA può essere il punto di partenza di nuove idee, da mettere in circolo con la funzione swivel.

Without the right conditions, many great ideas would never see the light. Creativity requires a good deal of comfort, both at home and at work. Ideal for the office, perfect for a modern style apartment ALFA can be the starting point for new ideas, to circulate through the swivel function.

Sans des conditions adaptées, certaines bonnes idées ne verraient jamais le jour. La créativité exige beaucoup de confort, à la maison comme au travail. ALFA peut être le point de départ de nouvelles idées à mettre en mouvement avec la fonction pivotante.



Alfa

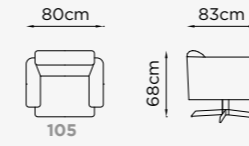

Profondità Depth Profondeur	83 cm
Altezza Height Hauteur	68 cm

RIVESTIMENTO			COVERING			REVETEMENTS		
• Pelle • Tessuto			• Leather • Soft cover			• Cuir • Tissu		
PIEDI			LEGS			PIETEMET		
• Metallo			• Metal			• Métal		
IMBOTTITURA			FILLING			REMBOURRAGE		
BRACCIOLO	CUSCINO SEDUTA	CUSCINO SPALLIERA	ARMS	SEAT CUSHION	BACK CUSHION	ACCOUDOIR	COUSSIN D'ASSISE	COUSSIN DE DOSSIER
• Gomma	• Gomma	• Gomma	• Foam	• Foam	• Foam	• Mousse	• Mousse	• Mousse
COMFORT			COMFORT			CONFORT		
• Standard • Hard			• Standard • Hard			• Standard • Ferme		
OPZIONI			OPTION			OPTION		
• Cuciture a contrasto • Tessuto non sfoderabile			• Contrast stitching • Not removable cover			• Coutures contrastées • Non déhoussable en tissu		

Beta

Guardarsi attorno non è mai stato così elegante. Dopo Alfa, arriva la poltrona BETA per continuare nello stile semplice e dai tratti moderni che non stanca mai. L'occasione per donarsi un elemento di arredo tutto da vivere.

Looking around has never been so exciting. After Alfa, here it comes the BETA armchair as a continuity of the simple and modern style that never tires. The opportunity to possess a piece of furniture that is all to be experienced.

Regarder autour de soi-même n'a jamais été aussi élégant. Après Alfa, le fauteuil BETA arrive pour continuer dans un style simple et moderne dont on ne se lasse jamais. L'occasion de s'offrir un meuble à vivre.



Beta

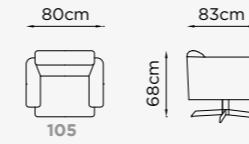

Profondità Depth Profondeur	83 cm
Altezza Height Hauteur	68 cm

RIVESTIMENTO			COVERING			REVETEMENTS		
• Pelle • Tessuto			• Leather • Soft cover			• Cuir • Tissu		
PIEDI			LEGS			PIETEMENT		
• Metallo			• Metal			• Métal		
IMBOTTITURA			FILLING			REMBOURRAGE		
BRACCIOLO	CUSCINO SEDUTA	CUSCINO SPALLIERA	ARMS	SEAT CUSHION	BACK CUSHION	ACCOUDOIR	COUSSIN D'ASSISE	COUSSIN DE DOSSIER
• Gomma	• Gomma	• Gomma	• Foam	• Foam	• Foam	• Mousse	• Mousse	• Mousse
COMFORT			COMFORT			CONFORT		
• Standard • Hard			• Standard • Hard			• Standard • Ferme		
OPZIONI			OPTION			OPTION		
• Cuciture a contrasto • Tessuto non sfoderabile			• Contrast stitching • Not removable cover			• Coutures contrastées • Non déhoussable en tissu		



Living

Cuscini
Pillows /Oreillers



L1033
Cuscino quadrato
66x66 cm



M1033
Cuscino quadrato
66x66 cm



L1036
Cuscino quadrato
60x60 cm



L1006
Cuscino quadrato
45x45 cm



Complementi

CODICE
FF100



VERSIONE
1703
TAVOLO
QUADRATO
GRANDE
80x35x80 cm
42 Grafite
46 Ramato
47 Bronzato



FF103



1701
TAVOLO
ROTONDO
90x35x90 cm
42 Grafite
46 Ramato
47 Bronzato



FF102



1704
TAVOLO
ROTONDO
45x55x45 cm
42 Grafite
46 Ramato
47 Bronzato



FF104



1702
TAVOLO
QUADRATO
45x55x45 cm
42 Grafite
46 Ramato
47 Bronzato



FF105



1711
CONSOLLE
100x100x25 cm
42 Grafite
46 Ramato
47 Bronzato



FF106



1706
TAVOLO
RETTANGOLARE
GRANDE
100x55x25 cm
42 Grafite
46 Ramato
47 Bronzato





Finiture
Finishing /Finition

METALLO / METAL / METAL



10

lucido
chrome
brillant



11

satinato
brushed
mat



26

marrone
dark brown
marron



37

mastice
darke taupe
mastic



38

nero anodico
anodic black
noir anodique

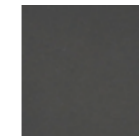

42

grafite
graphite
graphite



46

ramato
copper
cuivré



47

bronzato
bronzed
bronzé



48

sabbiato
sandblasted
sablée



49

antracite
anthracite
anthracite

LEGNO / WOOD / BOIS



01

naturale
natural
naturel



04

noce brunito
dark walnut
noyer foncé



18

noce canaletto
canaletto walnut
noyer canaletto



20

rovere grigio
gray oak
chêne gris



06

wengè
wenge
wengé

I riferimenti dei colori qui riportati sono da considerarsi puramente indicativi.
Color reference shown is only indicative.
La référence coloris mentionnée est purement indicative.

francoferri
ITALIA

Via Ceraso, 1 - 70022 Altamura (BA) - T. +39 080 3165511 F. +39 080 3105005 - info@francoferri.it

STAMPATO IN ITALIA - NOVEMBRE 2018

I colori, disegni e misure dei prodotti presenti nel catalogo sono indicativi.

La Franco Ferri s.r.l. ha la facoltà di eliminare o modificare i modelli delle proprie collezioni senza alcun preavviso.

I prezzi dei modelli standard sono espressi nello specifico listino prezzi fornito dall'azienda. Per quanto riguarda gli articoli su misura il preventivo verrà tempestivamente fornito dalla Franco Ferri s.r.l. dietro richiesta del cliente.

L'acquirente è tenuto a controllare sempre la merce e ad indicare nel DDT la data di ricevimento, la persona che la riceve e il timbro della ditta, nonché le eventuali anomalie del materiale. Franco Ferri s.r.l. accetterà esclusivamente reclami presentati entro 5 (cinque) giorni dal ricevimento della merce.

Gli ordini dovranno essere fatti per iscritto utilizzando i codici, descrizioni e prezzo come da catalogo e listini prezzi relativi.

Alcuni accessori presenti nelle immagini fotografiche non sono prodotti dalla FRANCO FERRI s.r.l.. Il presente catalogo è tutelato dalla legge sui diritti d'Autore (legge 22.4.1941, n° 633 e della legge 14.12.1942, n° 1485); e successive modifiche, di esso è proibita ogni riproduzione, totale o anche parziale in Italia o all'estero.

The colours, drawings and sizes of the products in this catalogue are approximate. Franco Ferri s.r.l. reserves the right to discontinue or change the models in its collections at any time without advance notice.

The prices of the standard models are expressed in the specific price list that Franco Ferri s.r.l. will provide. Concerning customized items the offer will be immediately made and provided by Franco Ferri s.r.l. on-request of the customer.

The purchaser is always required to inspect the goods and indicate on the transport document the date of receipt, the person who received it and the company's stamp, as well as any anomalies found in the material. Franco Ferri s.r.l. will not accept any claims presented more than 5 (five) days after receipt of the goods.

Orders must be in writing using the codes, descriptions and prices shown in the catalogue and price lists.

FRANCO FERRI s.r.l. reserves the right to modify in any moment and without notice the technical characteristics of the elements used in this catalogue. Some dimensions reported in the schematics may be subject to modifications due to manufacturing. Some of the accessories shown in the pictures are not produced by FRANCO FERRI s.r.l.. This catalogue is protected by the law on Author's Rights (law dated 22.04.1941, no. 633 and by the law dated 14.12.1942, no. 1485); and its following modifications. Any reproduction, complete or in part, is forbidden in Italy and abroad.

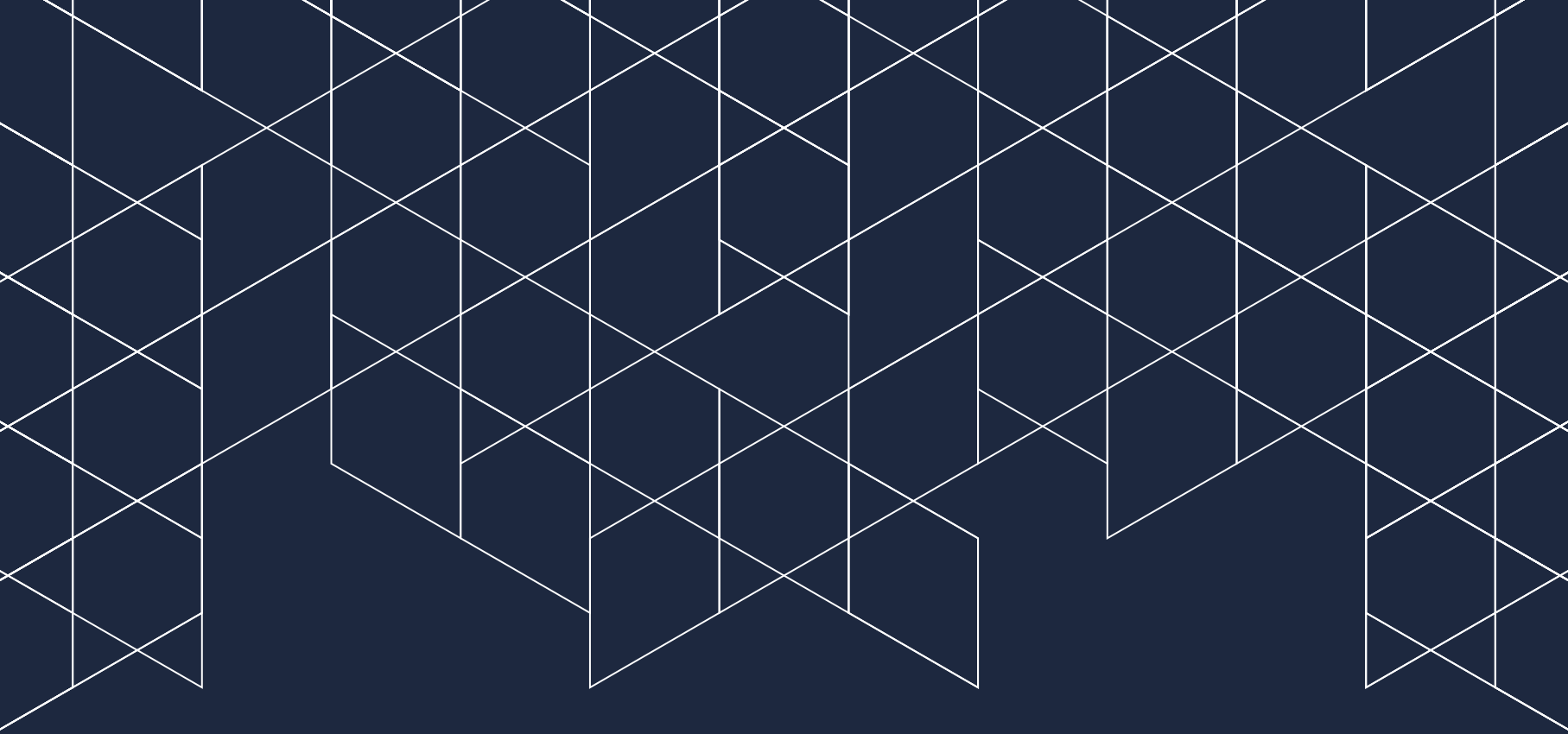

Via Ceraso, 1 - 70022 Altamura (Bari) - Italy
T. + 39 080 3165511 - info@francoferri.it
www.francoferri.it