

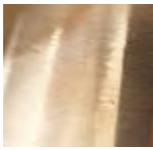









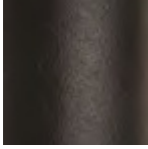

technical solutions 2023

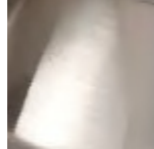

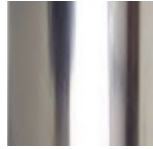
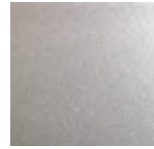

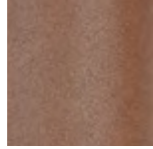
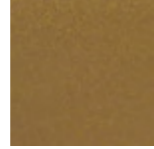
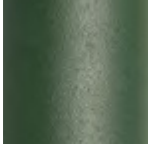
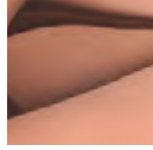
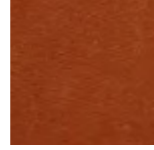
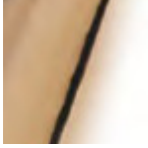
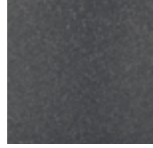
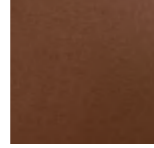
 .00 Trasparente Transparent	 .25 Dorato satinato Satin gold	 .50 Cristallo Crystal
 .01 Bianco White	 .31 Cromato Chromed	 .57 Vetro bianco White glass
 .02 Nero Black	 .32 Nichel satinato Nickel mat	 .32 Nichel satinato Nickel mat
 .03 Grigio Grey	 .33 Acciaio satinato Matt-steel	 .85 Verniciato argento Painted silver finishing
 .05 Rosso Red	 .34 Verniciato corten Painted corten finishing	 .86 Verniciato oro Painted gold finishing
 .06 Verde Green	 .38 Ramato lucido Shiny copper	 .87 Verniciato rame Painted copper finishing
 .21 Dorato lucido Shiny gold	 .39 Verniciato antracite Painted anthracite finishing	 .88 Verniciato bronzo Painted bronze finishing
 .23 Alluminio satinato Satin aluminium	 .45 Alluminio anodizzato Anodized aluminium	

Codice colore luce - Light Color Codes

- /XW** Extra White LED 2700K
- /WW** Warm White LED 3000K
- /W** Natural White LED 4000K
- /CW** Cold White LED 5000K
- /RGB** RGB LED 
- /B** Blue LED

Codice versioni - Option Codes

- /EM** Emergenza Emergency
- /DIM** Dimmerabile Dimming 
- /DALI** Dimmerabile Dimming 
- /ST** Con diffusore satinato Satin diffuser
- /TR** Con diffusore trasparente Transparent diffuser
- /P** Con protezione IP IP protection

I valori di lumen (lm) riportati nel catalogo si riferiscono al flusso luminoso nominale della sorgente LED (lm source), e al flusso della lampada (lm output).
The lumen (lm) values shown in the catalog refer to the flux luminous flux of the LED source (lm source), and the lamp flux (lm output).



Egoluce è nata nel 1978 dalla passione comune di tre amici, Bruno, Mario e Renato, per l'illuminazione e per il design. Quest'anno sono 45 anni, 45 anni di Made in Italy.

Egoluce was born in 1978 from the common passion of three friends, Bruno, Mario and Renato, for lighting and design. This year marks 45 years, 45 years of Made in Italy.



LA NOSTRA MISSIONE: MADE IN ITALY

Da sempre l'Italia è la culla della creatività. Know-how e stile italiano sono identificati e apprezzati ovunque, tanto che il marchio Made in Italy ha sempre costituito un valore aggiunto ricercato in tutto il mondo.

Il prodotto italiano può essere immediatamente riconosciuto grazie ai dettagli, all'attenzione e ai valori estetici che sono da sempre il nostro biglietto da visita.

Sulla scia di questa grande tradizione, dal 1978 EGOLUCE crea prodotti 100% Made in Italy, collaborando principalmente con aziende e artigiani italiani: per offrire ai propri clienti un prodotto di design con i più alti standard tecnologici.

La scelta diligente e attenta dei componenti e dei materiali di migliore qualità e la lavorazione guidata da criteri di qualità totale, ci consente di produrre e offrire ai nostri clienti una vasta gamma di corpi illuminanti per diverse applicazioni.

Le soluzioni di progettazione illuminotecnica qualificate identificano EgoLuce come uno dei più importanti produttori mondiali di illuminazione.

Prodotti 100% Made in Italy.

40 ANNI DI SUCCESSO

EgoLuce: 40 anni di esperienza per la tua illuminazione su misura.

L'evoluzione del prodotto combinato con nuovi materiali, tecnologie e design, sono i reali risultati delle nostre collezioni.

Il know-how e la cura dei dettagli in ogni fase della produzione sono stati una forza costante in questi 40 anni di attività di successo.

La capacità nella risoluzione dei problemi, l'attenzione al cliente e a ogni singola domanda del mercato, sono una missione costante per Tutti noi!

APPROCCIO UMANO

I sistemi di controllo degli apparecchi considerano il bioritmo umano e incidono positivamente sulla salute e sul benessere.

Un'intelligente gestione dell'energia e del colore della luce danno la possibilità di creare nuovi spazi nel vuoto, regalando allo spettatore una diversa visione dello spazio.

Una nuova esperienza sensoriale per la tua anima.

Una luce capace di muoversi e variare nello spazio, in grado di fondersi, di stupire e di appassionare: una luce indimenticabile.

La luce vive nell'ombra perché il suo flusso è regolato da soluzioni accattivanti in ogni versione.

DESIGN

Il design della luce è intrinsecamente funzionalità ed estetica e un approccio progettuale creativo e adattativo.

SUL PERCORSO DELL'INNOVAZIONE

Una luce senza tempo in grado di comprendere i nuovi bisogni umani in un mondo dinamico in continua rapida evoluzione.

EgoLuce propone una luce vissuta come esperienza di vita per lighting designers, architetti, progettisti come partner e interlocutori.

QUALITÀ IN PRIMO LUOGO

Soluzioni di illuminazione che grazie ad un alto livello di CRI, offerta di temperature colore, bianco dinamico e UGR, sono in grado di adattarsi a tutti i progetti di interni ed esterni, fornendo una luce come risposta ai tuoi nuovi progetti architettonici.

Una luce capace di disegnare nuove forme nel vuoto per ottenere una esperienza visiva e sensoriale rinnovata.

LA TUA LUCE

Una concezione orientata alla semplificazione del concetto di design nella vita quotidiana: una luce che sa adattarsi alle esigenze.

Il tempo vola così veloce che la vita si armonizza come la luce per condurre i tuoi sensi in un'unica sinfonia.

ECO/EGO

Il riscaldamento globale e l'urgente necessità di ridurre drasticamente il consumo di energia e le emissioni di CO₂ sono ormai problemi riconosciuti a livello mondiale. In questa nuova era di consapevolezza ognuno ha un ruolo da svolgere, non importa quanto piccolo o grande sia.

EGOLUCE è un'azienda attenta all'ambiente e ha completamente rivisto la sua collezione proponendo nei suoi cataloghi una gamma completa di prodotti a ridotto consumo energetico.

Le scelte eco-compatibili contribuiscono alla sostenibilità ambientale e sono un tema fondamentale per EgoLuce.

OUR MISSION: MADE IN ITALY

Since ever Italy is the cradle of creativity.

An aware production know how and style are identified and commended throughout the world, so much so that the Made in Italy mark has always constituted sought-after an added value.

An Italian product can immediately be recognized: details, attention and the aesthetic values are their business card.

In the wake of this great tradition, since 1978 EGOLUCE has been creating 100% Made in Italy products, mostly collaborating with Italian companies and craftsmen: in order to offer its clients a design product with highest technology standard.

The diligent and careful selection of best quality components and materials and the

processing guided by criteria such as total quality, enable us to produce and offer to our clients a vast range of light fixtures for several applications.

Qualified Lighting design solutions identify EgoLuce as one of the most important player in the worldwide lighting producer.

Products 100% Made in Italy.

40 YEARS OF SUCCESS

EgoLuce 40 years of experiences for your tailored lighting solutions.

Product evolution matches with new material, technologies and design, are actual achievements of Our collections.

Know-how and care in details in every production phases has been a forceful constant in these 40 years of successful activity.

Problem solving liability, customer care and attention to each and every markets demand are a permanent mission for us.

All of us... This steady Blend!

HUMAN APPROACH

Modern lighting controls take account of the human biorhythm and impact positively on health and well-being.

An intelligent energy and colour management of human light creates new spaces in

empty, as only an emotional waterfall can do in You.

A new sensorial experiences for your Soul.

Light artful to Move, to Fly, to Melt itself, to Hit inside, to Engage a simply unforgettable Light.

Light survives in the shadow because its Led glare is shaded by glamour solutions.

DESIGN

Lighting design is both inherently functional and innately aesthetic.

Design approach: generative and adaptive creativities

Conceptual design based on metaphors as a heuristic tool.

ON THE INNOVATION PATH

Timeless light able to figure out new human needs in a dynamic surfers world in constant evolution.

EgoLuce proposes a light lived as a life experience to: Lighting specialist, Designers,

Architects, Specifiers as first partners.

QUALITY FIRST

Lighting solutions that because of: high CRI level, K° offer, dynamic white and UGR

solutions, are able to adjust themselves to every interiors and exteriors projects.

EgoLuce a Light as response to Your new architectural projects, light draws spaces in

several shapes to get your own sensorial experience.

YOUR OWN LIGHT

A new tradition oriented to the contemporary context that simplifies the new design

concept in our daily life: adjusting itself with Your needs.

The time flies by so fast that the life tunes itself with the light to bless your senses in a

symphony.

ECO/EGO

Global warming and the urgent need to drastically cut energy consumption and CO₂

emission are now worldwide recognized problems. In this new era of awareness everyone has a role to play, no matter how

small or big.

EGOLUCE is an environmentally conscious company and has totally revised his collection proposing in its catalogues a full range of low consumption products.

Eco friendly choices contribute to environment sustainability.

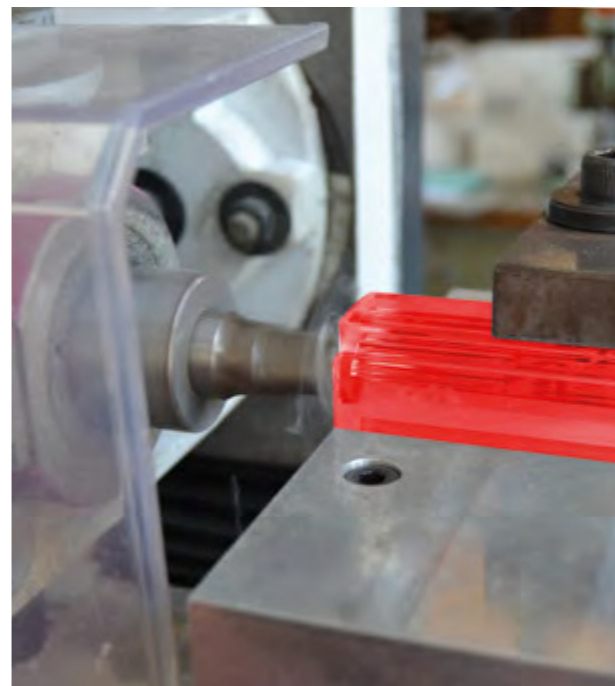

5

5 anni di garanzia.
5 years warranty.



Apparecchio riparabile.
Fixture repairable.

I modelli **EGOLUCE** sono progettati e prodotti attenendosi ai migliori standard qualitativi esistenti sul mercato illuminotecnico seguendo il criterio del "fatto bene" nel pieno rispetto di regole sia qualitative che normative, nei campi di applicazione dei nostri prodotti.

- Cura e precisione della progettazione finalizzata a una produzione di altissima qualità.

- Eccellente qualità nella fabbricazione dei prodotti grazie a: selezione di componenti di alta gamma, cura nelle finiture, assemblaggio preciso e puntuale, imballaggio impeccabile per ogni tipo di spedizione.

- Collaudi severissimi con test di durata e affidabilità, sia sui singoli componenti come sugli apparecchi finiti. Il tutto assicura 5 anni di garanzia sui prodotti e componenti **EGOLUCE** correttamente installati come da fogli d'istruzione.

EGOLUCE models are designed and produced according to the best quality standards existing on the technical lighting market following the "well made" standard: in full compliance with both quality and regulatory rules, in the fields of application of our products.

Care and precision of the design aimed at a production of the highest quality.

Excellent quality in the manufacture of products thanks to: high selection of high-end components, attention to coating, precise and punctual assembly and packaging, perfect for all types of shipping.

Extremely severe durability and reliability tests: both on individual components and on final products.

These targets guarantee 5 years warranty on correctly installed EGOLUCE products and components following the instruction for users.

4 buone ragioni per scegliere **EGOLUCE**

4 good reasons to choose **EGOLUCE**

1 – LED

I prodotti **EGOLUCE** sono dotati di sorgenti LED di ultima generazione. Le diverse tecnologie applicate garantiscono ottime prestazioni:

Eccellente resa luminosa.
Ottimo valore di resa cromatica.
Svariate temperature di colore.
Sorgenti progettate per durare nel tempo.

2 – MATERIALI

Abbiamo selezionato i migliori materiali per apparecchi che devono durare nel tempo:

- ALLUMINIO: duttile ed inalterabile assicura un'ottima dispersione del calore (importante per ottimizzare la vita del LED).
- ACCIAIO INOX: la migliore garanzia per apparecchi che devono resistere ad agenti atmosferici o chimici (sale, cloro etc.).
- CLEAR CRYSTAL: per creare oggetti con effetti e proiezioni di luce unici.
- METACRILATO: per diffondere ed al tempo stesso mascherare la luce puntiforme del LED.

3 – CARATTERISTICHE GENERALI

Piccoli particolari che fanno grande un prodotto:

- Facile sostituzione del LED, la sorgente luminosa può essere rimpiazzata senza problemi come una comune lampadina.
- Presenza di adeguati dissipatori di calore su tutti i prodotti per garantire la durata dei LED.
- Possibilità, per la maggior parte dei prodotti, di essere alimentati sia a 350 mA che a 500 mA
- Ottimizzazione della resa luminosa tramite l'utilizzo di lenti o parabole.

4 – SICUREZZA

Una qualità garantita:

- Tutti i modelli vengono sottoposti a prove termiche e test funzionali.
- Tutti i componenti elettronici proposti in catalogo (driver, dimmer) sono dotati di marchio europeo di qualità (ENEC).
- Il 100% della produzione viene sottoposto a test qualitativi e funzionali prima di essere immesso sul mercato.

1 – LED

EGOLUCE products are equipped with latest generation LED. We use different technologies to grant very good performances:

Excellent luminous efficacy.
Very good colour rendering.
Different light colours.
Designed to last for a very long time.

2 – MATERIALS

We have selected best materials for products that must have long-lasting life:

- ALUMINIUM – ductile and unalterable grants an optimal heat dissipation (important to grant longest operational life of LED).
- STAINLESS STEEL – the best warranty for fixtures that must resist to atmospheric or chemical agents (salt, chlorine, etc.)
- CLEAR CRYSTAL: to create objects with unique light effects and reflections.
- METHACRYLATE: to diffuse and at the same time shade the punctual light of LED.

3- GENERAL FEATURES

Small details that makes a great product:

- LED unit easy to replace, the light source can be replaced as if it were a common lamp.
- Proper heat sink device placed in every product to grant maximum lifetime for the LED.
- Most of the products can be operated both at 350 mA or 500 mA.
- Optimization of the luminous flux obtained by the use of lenses and reflectors.

4 – SAFETY

A granted quality

- All our models undergo rigorous temperature and functional testing.
- All electronic components displayed in our catalogue (drivers, dimmers) are marked with European quality certification (ENEC).
- 100% of our products undergo quality and functional end line test prior to commercialization.

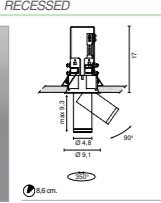
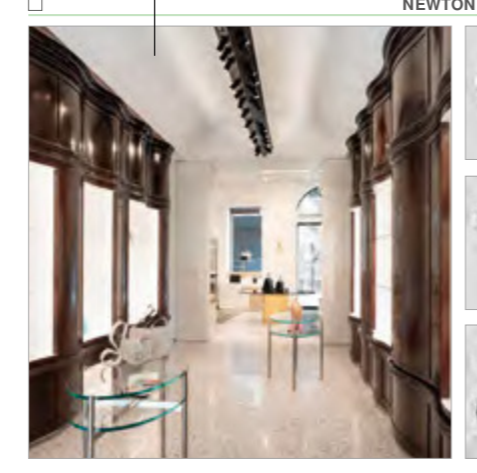
Nome Name	Codice Code	Dati Tecnici Technical Data	Ambientazione Still Life	Capitolo Chapter																																			
<p>NEWTON SPOT RECESSED</p>  <p>6328 Newton Spot recessed .01 Bianco - White .02 Nero - Black</p> <table border="1"> <thead> <tr> <th>Color temperature</th> <th>Optics</th> <th>LED light source</th> <th>lm source</th> <th>lm output</th> </tr> </thead> <tbody> <tr> <td>/W 4000K</td> <td>.24 /38 /58</td> <td>8,7W 17,5V 500m</td> <td>1466lm</td> <td>1150lm</td> </tr> <tr> <td>/W 4000K</td> <td>.ST Satinato - Satin</td> <td>8,7W 17,5V 500m</td> <td>1466lm</td> <td>1099lm</td> </tr> <tr> <td>/WW 3000K</td> <td>.24 /38 /58</td> <td>8,7W 17,5V 500m</td> <td>1424lm</td> <td>1117lm</td> </tr> <tr> <td>/WW 3000K</td> <td>.ST Satinato - Satin</td> <td>8,7W 17,5V 500m</td> <td>1424lm</td> <td>1068lm</td> </tr> <tr> <td>/XW 2700K</td> <td>.24 /38 /58</td> <td>8,7W 17,5V 500m</td> <td>1340lm</td> <td>1051lm</td> </tr> <tr> <td>/XW 2700K</td> <td>.ST Satinato - Satin</td> <td>8,7W 17,5V 500m</td> <td>1340lm</td> <td>1005lm</td> </tr> </tbody> </table> <p>0,80 Kg</p>					Color temperature	Optics	LED light source	lm source	lm output	/W 4000K	.24 /38 /58	8,7W 17,5V 500m	1466lm	1150lm	/W 4000K	.ST Satinato - Satin	8,7W 17,5V 500m	1466lm	1099lm	/WW 3000K	.24 /38 /58	8,7W 17,5V 500m	1424lm	1117lm	/WW 3000K	.ST Satinato - Satin	8,7W 17,5V 500m	1424lm	1068lm	/XW 2700K	.24 /38 /58	8,7W 17,5V 500m	1340lm	1051lm	/XW 2700K	.ST Satinato - Satin	8,7W 17,5V 500m	1340lm	1005lm
Color temperature	Optics	LED light source	lm source	lm output																																			
/W 4000K	.24 /38 /58	8,7W 17,5V 500m	1466lm	1150lm																																			
/W 4000K	.ST Satinato - Satin	8,7W 17,5V 500m	1466lm	1099lm																																			
/WW 3000K	.24 /38 /58	8,7W 17,5V 500m	1424lm	1117lm																																			
/WW 3000K	.ST Satinato - Satin	8,7W 17,5V 500m	1424lm	1068lm																																			
/XW 2700K	.24 /38 /58	8,7W 17,5V 500m	1340lm	1051lm																																			
/XW 2700K	.ST Satinato - Satin	8,7W 17,5V 500m	1340lm	1005lm																																			
<p>NEWTON SPOT EASY RECESSED 230V - GU10</p>  <p>6326 Newton Easy 230V - GU10 .01 Bianco - White .02 Nero - Black .02.01 Snodo nero, corpo dorato satinato - Black articulated joint, satin gold body .02.02 Snodo nero, corpo nickel satinato - Black articulated joint, nickel mat body</p> <p>Light sources TW GU10 LED DIM (out. 0104...) TW GU10 LED (out. 0084...)</p> <p>0,80 Kg</p>																																							
<p>Accessori - Accessories</p> <p>0267 Frangluce / Lenses .01 Bianco - White .02 Nero - Black</p> <p>0274 Schemo antiabbagliamento / Anti-glare screen .01 Bianco - White .02 Nero - Black</p> <p>Optiche Disponibili - Available Optics</p> <table border="1"> <thead> <tr> <th>Optics</th> <th>Optics</th> <th>Optics</th> <th>Optics</th> </tr> </thead> <tbody> <tr> <td>.04 Ottica fascio stretto per luce d'accento / Narrow beam optic for accent lighting</td> <td>.05 Ottica fascio medio / Medium beam optic</td> <td>.06 Ottica fascio largo / Wide beam optic</td> <td>.07 Ottica fascio diffuso per illuminazione generale / Diffused light optic for general lighting</td> </tr> </tbody> </table> <p>Drivers</p> <table border="1"> <thead> <tr> <th>Drivers ON/OFF</th> <th>DIMMABLE drivers</th> <th>Casambi</th> <th>LED emergency unit</th> </tr> </thead> <tbody> <tr> <td>Cod. 0147COB 500mA / 0148COB 500mA</td> <td>0141DIM 1-2 / 0141DALI 1-2 / 0141DALI 1-3 / 0141DALI 1-3 / 0146 DIM FASE OUT 1-3</td> <td>0145CASA 1-3</td> <td>0115EM Inverter + Battery + LED indicator 1</td> </tr> </tbody> </table> <p>Solo collegamento in serie - Only serial connection</p>					Optics	Optics	Optics	Optics	.04 Ottica fascio stretto per luce d'accento / Narrow beam optic for accent lighting	.05 Ottica fascio medio / Medium beam optic	.06 Ottica fascio largo / Wide beam optic	.07 Ottica fascio diffuso per illuminazione generale / Diffused light optic for general lighting	Drivers ON/OFF	DIMMABLE drivers	Casambi	LED emergency unit	Cod. 0147COB 500mA / 0148COB 500mA	0141DIM 1-2 / 0141DALI 1-2 / 0141DALI 1-3 / 0141DALI 1-3 / 0146 DIM FASE OUT 1-3	0145CASA 1-3	0115EM Inverter + Battery + LED indicator 1																			
Optics	Optics	Optics	Optics																																				
.04 Ottica fascio stretto per luce d'accento / Narrow beam optic for accent lighting	.05 Ottica fascio medio / Medium beam optic	.06 Ottica fascio largo / Wide beam optic	.07 Ottica fascio diffuso per illuminazione generale / Diffused light optic for general lighting																																				
Drivers ON/OFF	DIMMABLE drivers	Casambi	LED emergency unit																																				
Cod. 0147COB 500mA / 0148COB 500mA	0141DIM 1-2 / 0141DALI 1-2 / 0141DALI 1-3 / 0141DALI 1-3 / 0146 DIM FASE OUT 1-3	0145CASA 1-3	0115EM Inverter + Battery + LED indicator 1																																				
<p>Accessori Accessories</p> <p>Alimentatori Drivers</p> <p>Foto Picture</p> <p>Disegno Tecnico Technical Drawing</p>																																							

I caratteri in rosso sono utilizzati per il codice e le specifiche che concorrono alla definizione del prodotto da indicare negli ordini.

Red characters are used for code and specifications needed to identify the product code to be indicated in orders.

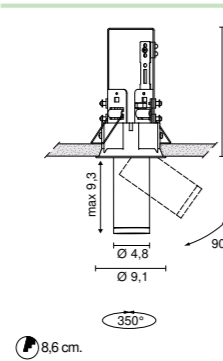
Finitura Finish	Prodotto Product	Lumen output Lumen output	Lumen sorgente Lumen source																																			
 <p>6328 Newton Spot recessed .01 Bianco - White .02 Nero - Black</p> <table border="1"> <thead> <tr> <th>Color temperature</th> <th>Optics</th> <th>LED light source</th> <th>lm source</th> <th>lm output</th> </tr> </thead> <tbody> <tr> <td>/W 4000K</td> <td>.24 /38 /58</td> <td>8,7W 17,5V 500m</td> <td>1466lm</td> <td>1150lm</td> </tr> <tr> <td>/W 4000K</td> <td>.ST Satinato - Satin</td> <td>8,7W 17,5V 500m</td> <td>1466lm</td> <td>1099lm</td> </tr> <tr> <td>/WW 3000K</td> <td>.24 /38 /58</td> <td>8,7W 17,5V 500m</td> <td>1424lm</td> <td>1117lm</td> </tr> <tr> <td>/WW 3000K</td> <td>.ST Satinato - Satin</td> <td>8,7W 17,5V 500m</td> <td>1424lm</td> <td>1068lm</td> </tr> <tr> <td>/XW 2700K</td> <td>.24 /38 /58</td> <td>8,7W 17,5V 500m</td> <td>1340lm</td> <td>1051lm</td> </tr> <tr> <td>/XW 2700K</td> <td>.ST Satinato - Satin</td> <td>8,7W 17,5V 500m</td> <td>1340lm</td> <td>1005lm</td> </tr> </tbody> </table> <p>0,80 Kg</p>				Color temperature	Optics	LED light source	lm source	lm output	/W 4000K	.24 /38 /58	8,7W 17,5V 500m	1466lm	1150lm	/W 4000K	.ST Satinato - Satin	8,7W 17,5V 500m	1466lm	1099lm	/WW 3000K	.24 /38 /58	8,7W 17,5V 500m	1424lm	1117lm	/WW 3000K	.ST Satinato - Satin	8,7W 17,5V 500m	1424lm	1068lm	/XW 2700K	.24 /38 /58	8,7W 17,5V 500m	1340lm	1051lm	/XW 2700K	.ST Satinato - Satin	8,7W 17,5V 500m	1340lm	1005lm
Color temperature	Optics	LED light source	lm source	lm output																																		
/W 4000K	.24 /38 /58	8,7W 17,5V 500m	1466lm	1150lm																																		
/W 4000K	.ST Satinato - Satin	8,7W 17,5V 500m	1466lm	1099lm																																		
/WW 3000K	.24 /38 /58	8,7W 17,5V 500m	1424lm	1117lm																																		
/WW 3000K	.ST Satinato - Satin	8,7W 17,5V 500m	1424lm	1068lm																																		
/XW 2700K	.24 /38 /58	8,7W 17,5V 500m	1340lm	1051lm																																		
/XW 2700K	.ST Satinato - Satin	8,7W 17,5V 500m	1340lm	1005lm																																		
<p>Colore luce Light color</p> <p>Specifiche Specifications</p> <p>Tipologia Typology</p>																																						



Raccordi di luce	pag. 12
Spot	pag. 28
Track	pag. 114
Architectural	pag. 166
Lighting system	pag. 184
Decorative	pag. 266
Outdoor	pag. 294
Tecnology	pag. 348
Accessory	pag. 376

RACCORDI DI LUCE



SPOTS

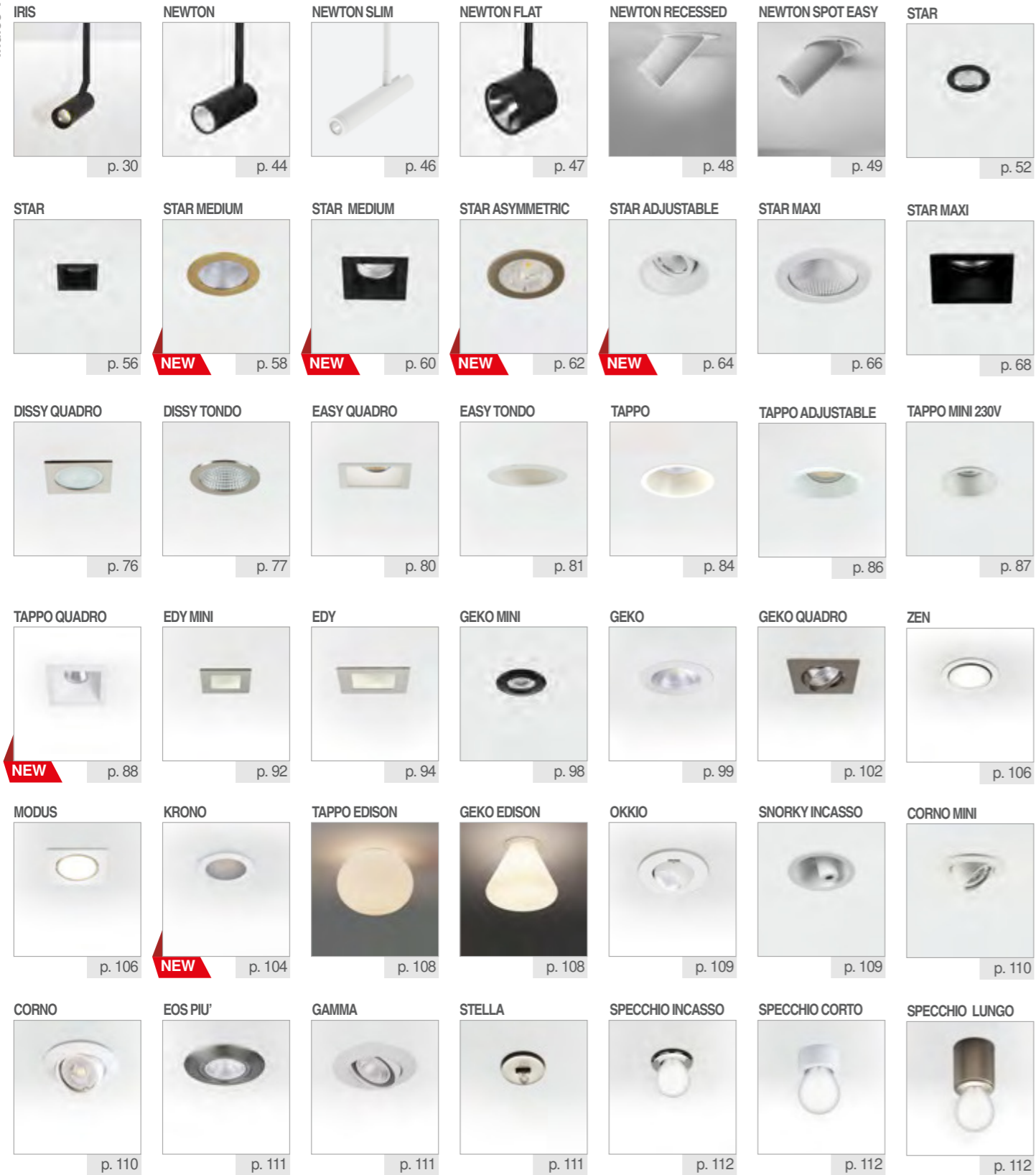

TRACK



ARCHITECTURAL



LIGHTING SYSTEM

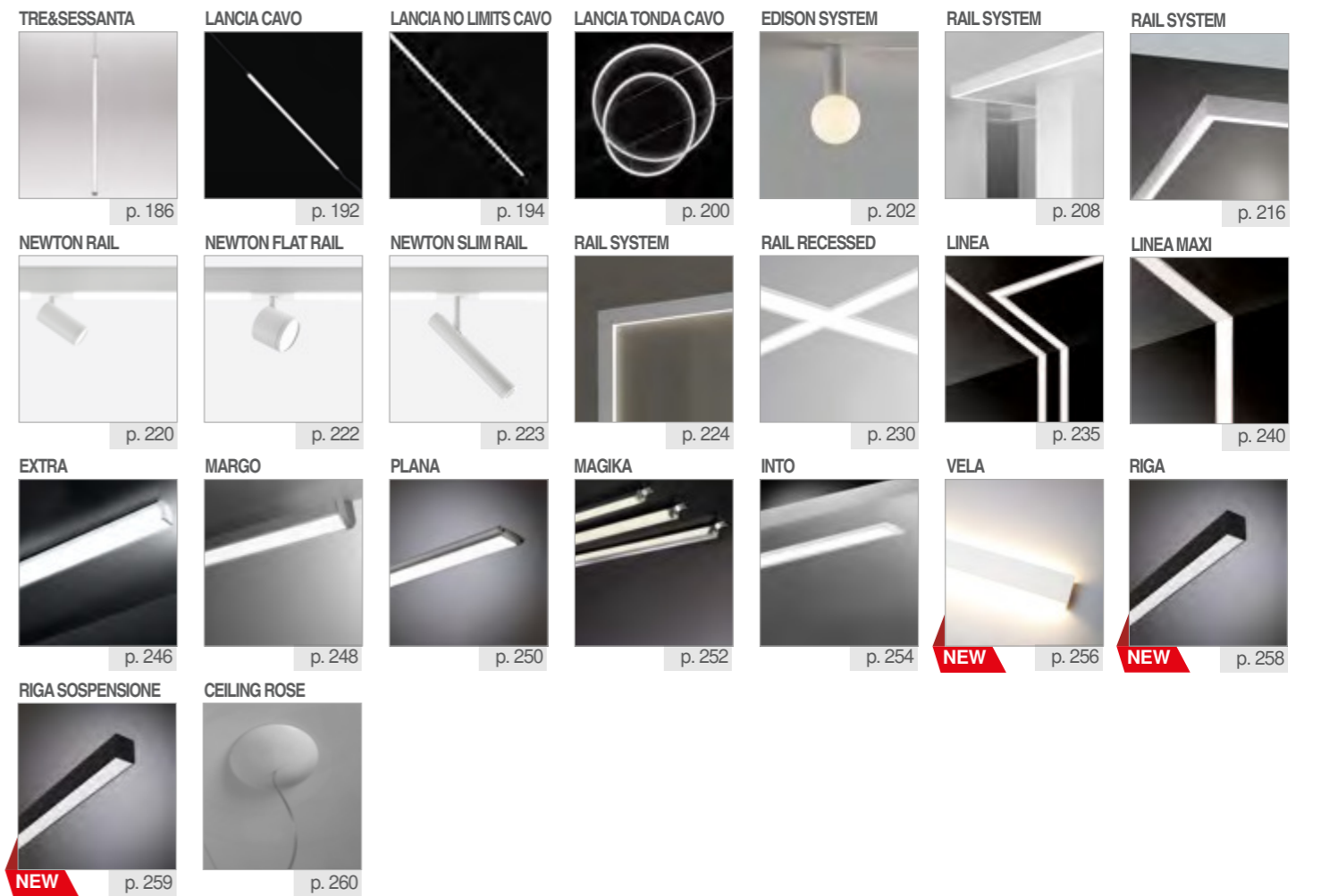



































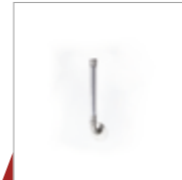



















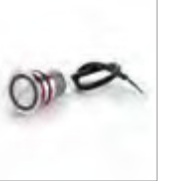
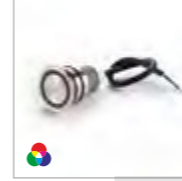

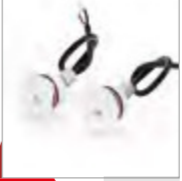
DECORATIVE LIGHT

OUTDOOR

Indice visivo - Visual index

Indice visivo - Visual index

 p. 268	 p. 269	 p. 270	 p. 271	 p. 272	 p. 272	 p. 274
 p. 275	 p. 276	 p. 278	 p. 280	 p. 282	 p. 282	 p. 282
 p. 284	 p. 284	 p. 286	 p. 286	 p. 287	 p. 288	 p. 290
 p. 292	 p. 292	 p. 293				

 NEW p. 296	 NEW p. 302	 NEW p. 304	 NEW p. 307	 p. 310	 p. 312	 p. 314
 p. 320	 p. 321	 p. 321	 p. 324	 p. 325	 p. 326	 p. 327
 p. 328	 p. 330	 NEW p. 331	 p. 332	 p. 334	 p. 335	 p. 336
 p. 337	 p. 338	 NEW p. 339	 p. 340	 NEW p. 341	 p. 342	 p. 343
 NEW p. 344	 p. 346	 p. 347	 p. 348	 p. 349		



7516 - p. 14



4672 - p. 24



4673 - p. 24



5690 - p. 25

RACCORDI DI LUCE SYSTEM JOY SYSTEM

design: **officinadiarchitettura&design**

Sistema di luce modulare IP65 a luce diretta e apertura ottica di 73° con struttura in acciaio INOX 304 e alluminio con anodizzazione rinforzata per esterni oppure, nella finitura in acciaio satinato, in INOX AISI 316L.

FINITURE DISPONIBILI:

- .01 bianco
- .02 nero
- .06 verde
- .33 acciaio INOX AISI 316L
- .34 verniciato corten

RACCORDI DI LUCE SYSTEM – JOY SYSTEM rappresenta un modo nuovo e diverso d'interpretare la luce: partendo da un unico punto di alimentazione, la modularità dei vari elementi permette la realizzazione di infinite configurazioni portando la luce dove si vuole.

L'installazione può essere fatta sia in esterno sia in ambienti interni; a pavimento, a parete o a plafone.

Il suo funzionamento richiede l'utilizzo di un alimentatore da collocare in remoto e da ordinare separatamente.

IP65 modular light system with direct light and 73° optical aperture with structure in 304 stainless steel and aluminum with reinforced anodizing for outdoor use or, in the satin steel finish, in AISI 316L stainless steel.

AVAILABLE FINISHES:

- .01 white
- .02 black
- .06 green
- .33 AISI 316L stainless steel
- .34 painted corten

RACCORDI DI LUCE SYSTEM – JOY SYSTEM represents a new and different way of interpreting light: starting from a single power supply point, the modularity of the various elements allows for the creation of infinite configurations, bringing the light wherever you want.

The installation can be done both outdoors and indoors; on the floor, on the wall or on the ceiling.

Its operation requires the use of a driver to be positioned remotely and to be ordered separately.

Système d'éclairage modulaire IP65 à lumière directe et ouverture optique de 73° avec structure en acier inoxydable 304 et aluminium avec anodisation renforcée pour l'extérieur ou, dans la finition acier satiné, en acier inoxydable AISI 316L.

FINITIONS DISPONIBLES:

- .01 blanc
- .02 noir
- .06 vert
- .33 acier inoxydable AISI 316L
- .34 corten peint

RACCORDI DI LUCE SYSTEM – JOY SYSTEM représente une manière nouvelle et différente d'interpréter la lumière : à partir d'un seul point d'alimentation, la modularité des différents éléments permet de créer des configurations infinies, apportant la lumière où vous le souhaitez.

L'installation peut se faire aussi bien à l'extérieur qu'à l'intérieur; au sol, au mur ou au plafond.

Son fonctionnement nécessite l'utilisation d'une alimentation à positionner à distance et à commander séparément.

Sistema de iluminación modular IP65 de luz directa y apertura óptica de 73° con estructura en acero inoxidable 304 y aluminio con anodizado reforzado para uso exterior o, en el acabado acero satinado, en acero inoxidable AISI 316L.

ACABADOS DISPONIBLES:

- .01 blanco
- .02 negro
- .06 verde
- .33 acero inoxidable AISI 316L
- .34 corten pintado

RACCORDI DI LUCE SYSTEM – JOY SYSTEM representa una forma nueva y diferente de interpretar la luz: partiendo de un único punto de alimentación, la modularidad de los distintos elementos permite crear infinitas configuraciones, llevando la luz donde tú quieras.

La instalación se puede realizar tanto en exterior como en interior; en el suelo, en la pared o en el techo.

Su funcionamiento requiere el uso de una fuente de alimentación que se colocará de forma remota y se pedirá por separado.

Modulares IP65-Lichtsystem mit direktem Licht und 73° optischer Öffnung mit Struktur aus Edelstahl 304 und Aluminium mit verstärkter Eloxierung für den Außenbereich oder in der Ausführung Edelstahl AISI 316L.

VERFÜGBARE AUSFÜHRUNGEN:

- .01 weiß
- .02 schwarz
- .06 grün
- .33 edelstahl AISI 316L
- .34 lackierter corten

RACCORDI DI LUCE SYSTEM – JOY SYSTEM stellt eine neue und andere Art dar, Licht zu interpretieren: Ausgehend von einem einzigen Stromanschlusspunkt ermöglicht die Modularität der verschiedenen Elemente die Schaffung unendlicher Konfigurationen, um das Licht dorthin zu bringen, wo Sie es wünschen.

Die Installation kann sowohl im Freien als auch im Innenbereich erfolgen; auf dem Boden, an der Wand oder an der Decke.

Sein Betrieb erfordert die Verwendung eines Netzteils, das entfernt positioniert und separat bestellt werden muss.

Модульная световая система IP65 с прямым светом и оптической апертурой 73° со структурой из нержавеющей стали 304 и алюминия с усиленным анодированием для наружного использования или с отделкой из satinированной стали из нержавеющей стали AISI 316L.

ДОСТУПНЫЕ ОТДЕЛКИ:

- .01 белый
- .02 черный
- .06 зеленый
- .33 Нержавеющая сталь AISI 316L
- .34 окрашенный кортен

RACCORDI DI LUCE SYSTEM – JOY SYSTEM представляет собой новый и необычный способ интерпретации света: начиная с одной точки питания, модульность различных элементов позволяет создавать бесконечные конфигурации, направляя свет туда, куда вы хотите.

Монтаж можно производить как снаружи, так и внутри помещения; на полу, на стене или на потолке.

Его работа требует использования источника питания, который должен быть расположен удаленно и заказывается отдельно.



Illuminatori

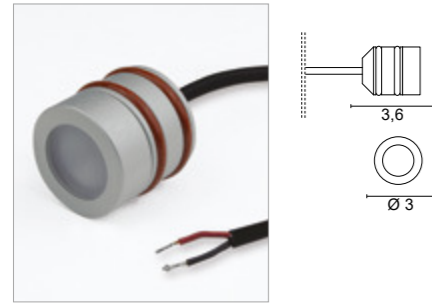

7516

3cm

.45 Alluminio anodizzato - Aluminium anodized

Color temperature	LED Light sources	lm source
/W 4000K	1,5W 500mA	221lm
/WW 3000K	1,5W 500mA	210lm
/XW 2700K	1,5W 500mA	199lm

IP65 100cm 75° 0,08 Kg

Drivers ON/OFF

Cod. LED	0143/IP	0127
	500mA	500mA
7516	1-7	1-6

Solo collegamento in serie - Only serial connection

Elementi - elements

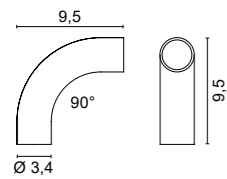

7500

Curva a mandrinare 90°
90° expanding bend

- .01 Bianco - White
- .02 Nero - Black
- .06 Verde - Green
- .33 Acciaio - Stell
- Inox AISI 316L
- .34 Verniciato corten
Painted corten finishing

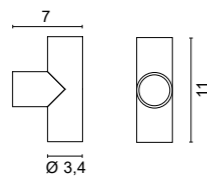

7501

Giunto a T a mandrinare
T joint expanding bend

- .01 Bianco - White
- .02 Nero - Black
- .06 Verde - Green
- .33 Acciaio - Stell
- Inox AISI 316L
- .34 Verniciato corten
Painted corten finishing

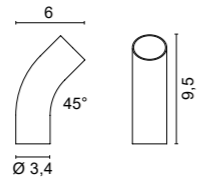

7504

Curva a mandrinare 45°
45° expanding bend

- .01 Bianco - White
- .02 Nero - Black
- .06 Verde - Green
- .33 Acciaio - Stell
- Inox AISI 316L
- .34 Verniciato corten
Painted corten finishing

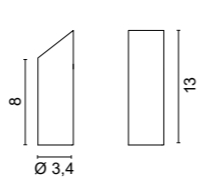

7505

Giunto con taglio a 45°
Joint with 45° cut

- .01 Bianco - White
- .02 Nero - Black
- .06 Verde - Green
- .33 Acciaio - Stell
- Inox AISI 316L
- .34 Verniciato corten
Painted corten finishing

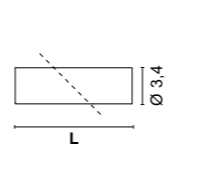

7508

Tubo lineare
Linear tube

- .01 Bianco - White
- .02 Nero - Black
- .06 Verde - Green
- .33 Acciaio - Stell
- Inox AISI 316L
- .34 Verniciato corten
Painted corten finishing

Lunghezza L - Length L

/20	20cm
/50	50cm
/100	100cm
/150	150cm



.01 Bianco - White .02 Nero - Black .06 Verde - Green .33 Acciaio - Stell Inox AISI 316L .34 Verniciato corten Painted corten finishing

Congiunzioni

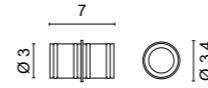

7510

Elemento di giunzione
Junction element

- .02 Nero - Black

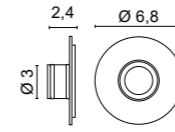

7521

Base a muro in alluminio con copribase
Wall base in aluminum with cover disc

- .01 Bianco - White
- .02 Nero - Black
- .06 Verde - Green
- .33 Acciaio - Stell
- Inox AISI 316L
- .34 Verniciato corten
Painted corten finishing

Optional

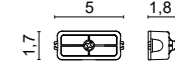

0276

Connettore IP67
IP67 connector

Casseforme / Basi

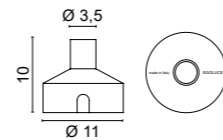

0228/R

Cassforma drenante
Draining junction box

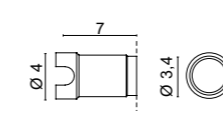

0216

Plastic box

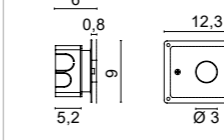

0213

Box + plaster

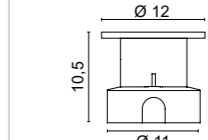

0246/R

Box + plate con viti d'acciaio
Box + plate with steel screws

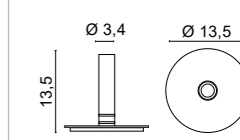
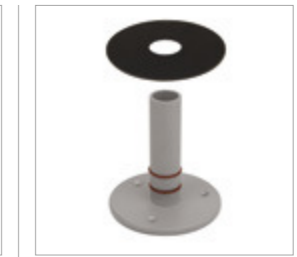

7522

Base con disco copribase
Base with cover disc

- .01 Bianco - White
- .02 Nero - Black
- .06 Verde - Green
- .33 Acciaio - Stell
- Inox AISI 316L
- .34 Verniciato corten
Painted corten finishing

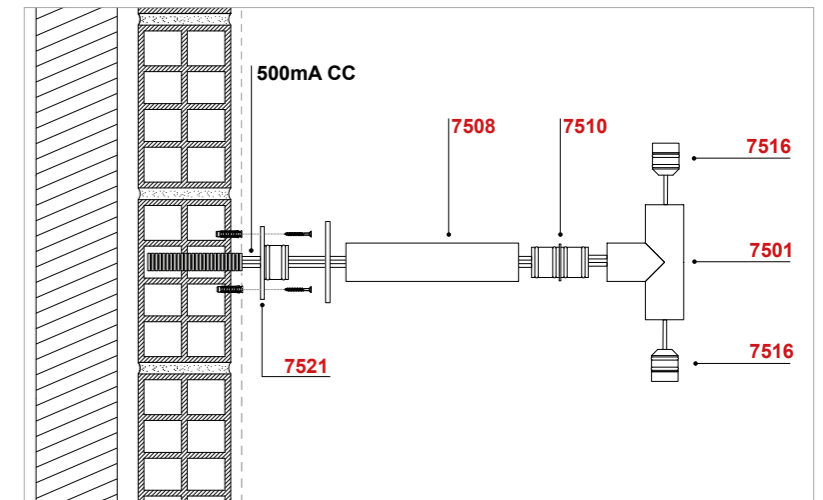

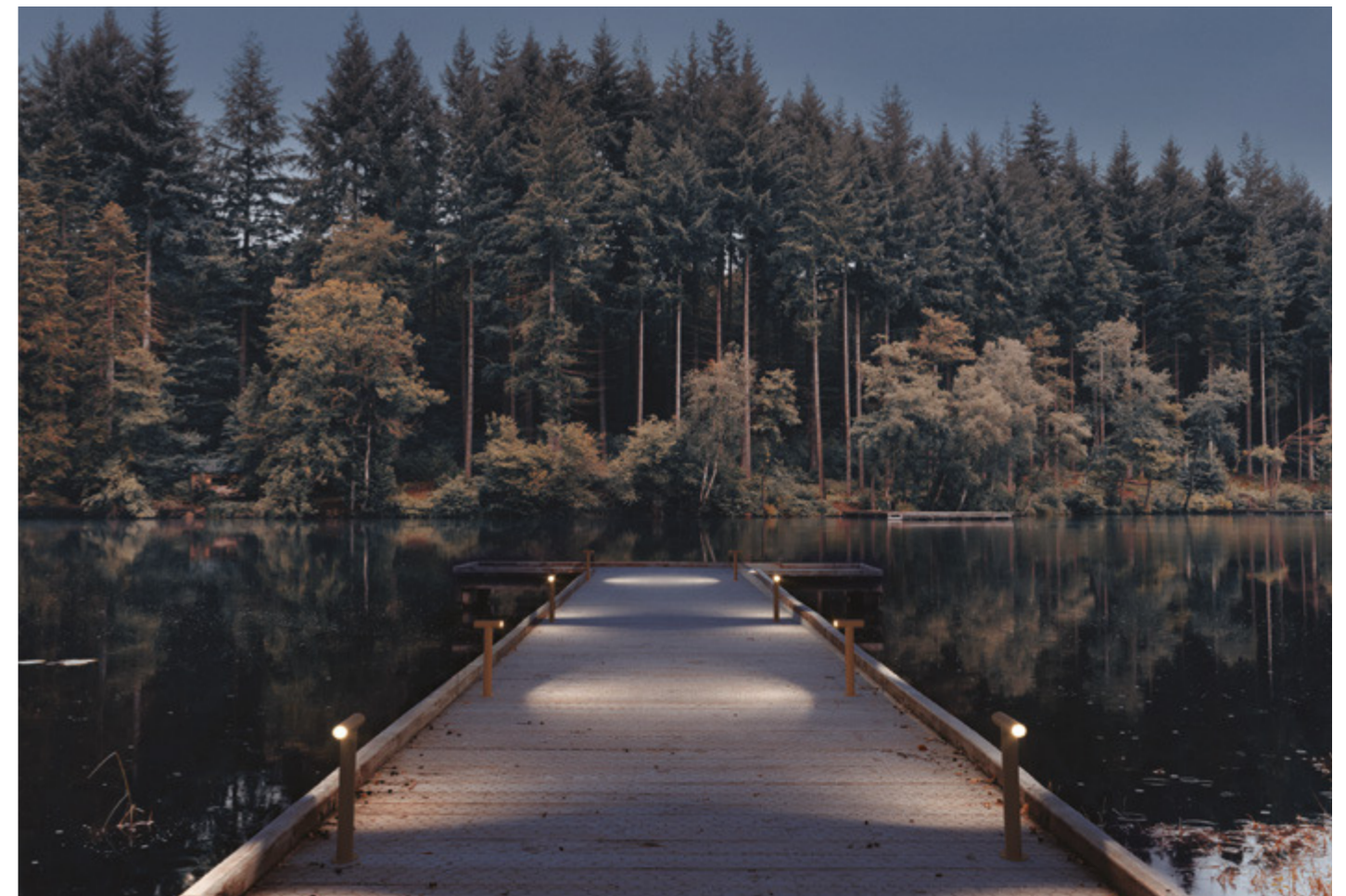
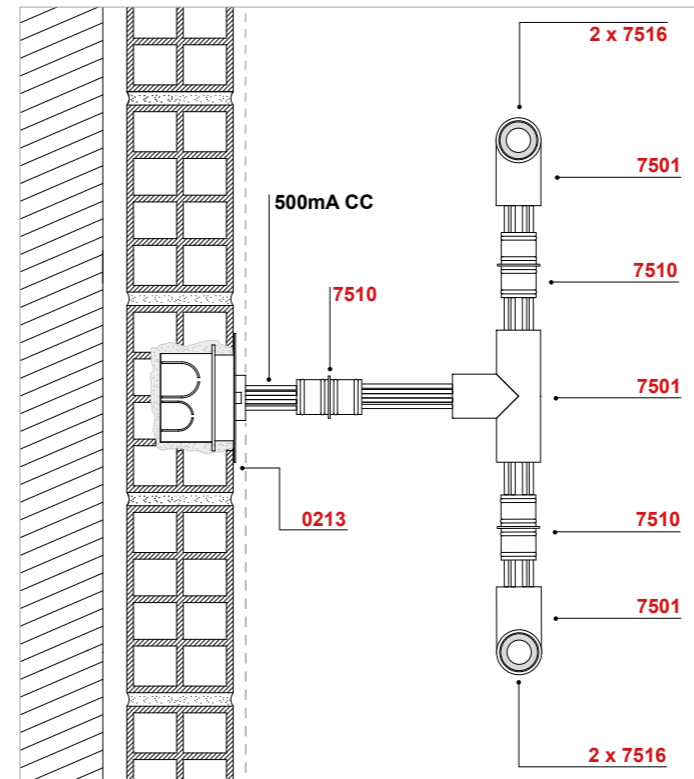

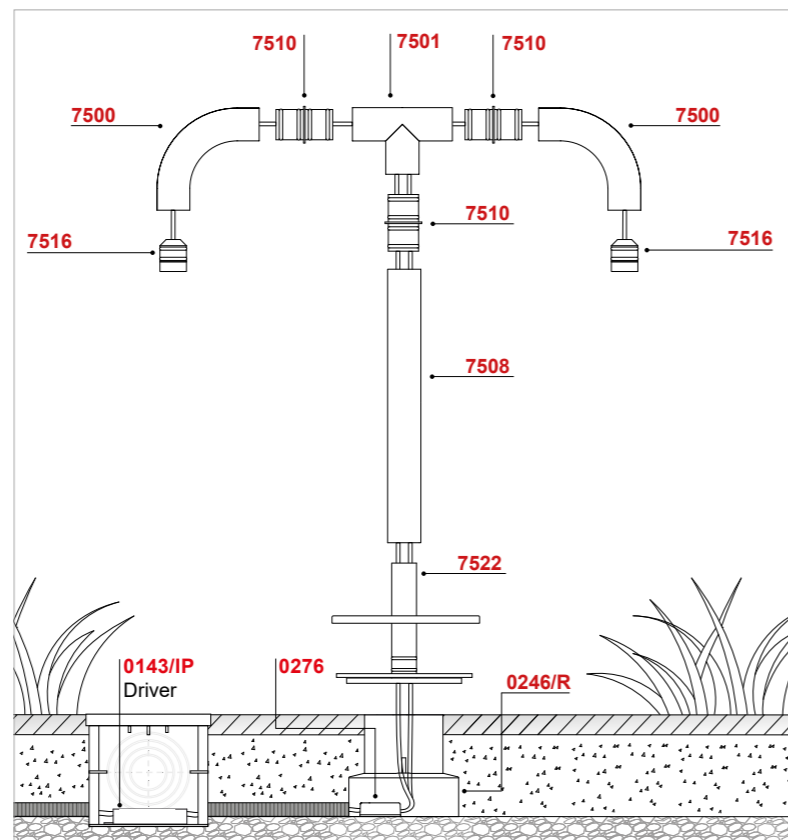
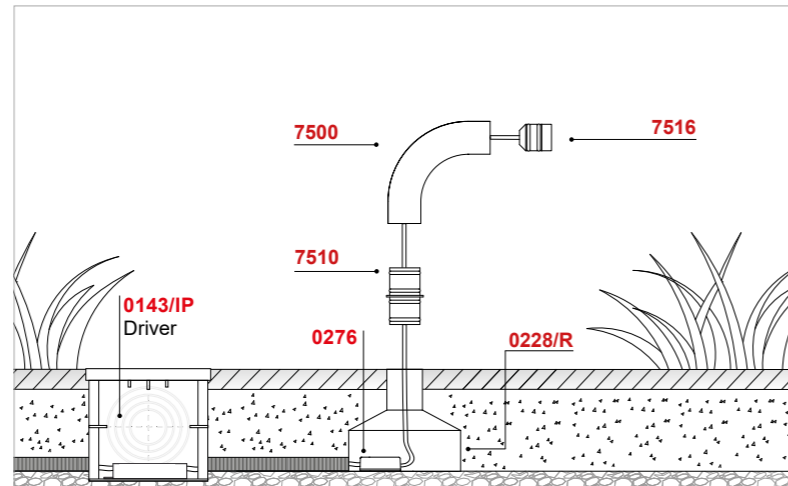

I drivers, da ordinare separatamente, devono essere collocati in remoto
 The drivers, to be ordered separately, must be placed remotely



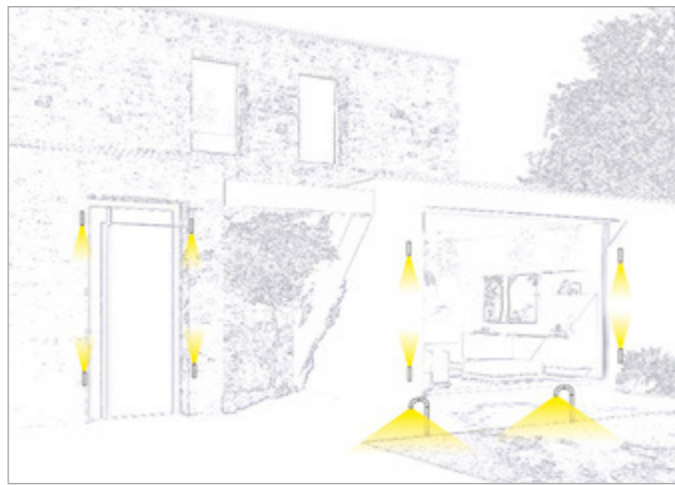
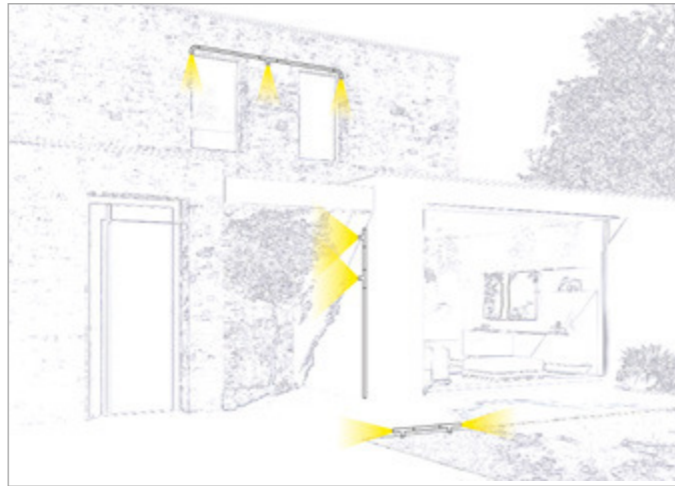
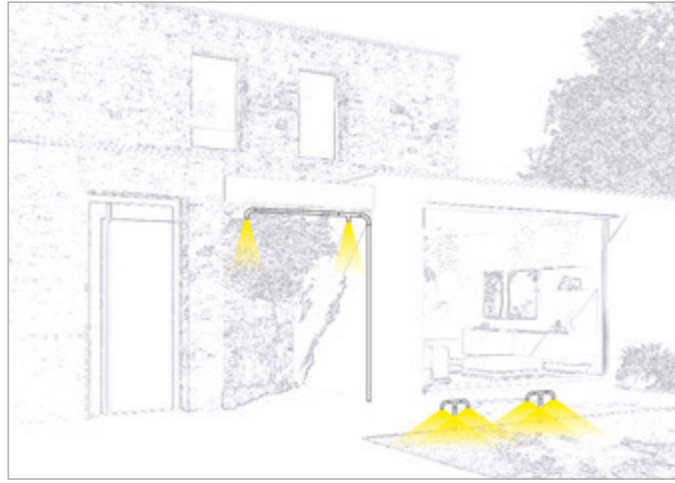

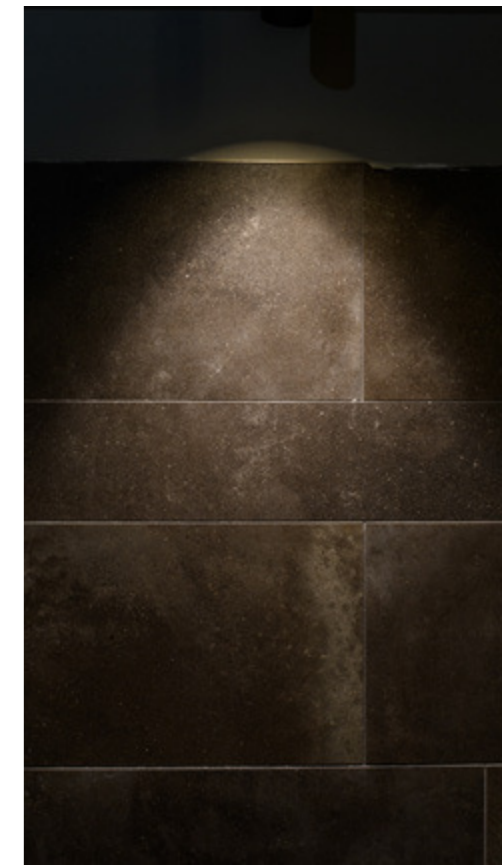

RACCORDI DI LUCE JOY

design: **officinadiarchitettura&design**

Collezione di lampade IP65 a luce diretta da parete, plafone e terra, sia per esterno sia per interno, con struttura in acciaio INOX 304 e alluminio con anodizzazione rinforzata per esterni oppure, nella finitura in acciaio satinato, in INOX AISI 316L.

FINITURE DISPONIBILI:

- .01 bianco
- .02 nero
- .06 verde
- .33 acciaio INOX AISI 316L
- .34 verniciato corten

Le ridotte dimensioni e il tipo di luce, grazie all'apertura ottica di 73°, sono ideali per illuminare passaggi o particolari ambienti esterni, giardini o per creare giochi di luce su facciate di case o illuminare percorsi sotto piccoli portici o verande.

Il suo funzionamento richiede l'utilizzo di un alimentatore da collocare in remoto e da ordinare separatamente.

Collection of IP65 direct light wall, ceiling and floor lamps, for both outdoor and indoor use, with structure in 304 stainless steel and aluminum with reinforced anodizing for outdoor use or, in the satin steel finish, in AISI 316L stainless steel.

AVAILABLE FINISHES:

- .01 white
- .02 black
- .06 green
- .33 AISI 316L stainless steel
- .34 painted corten

The small size and the type of light, thanks to beam optic of 73°, are ideal for illuminating passageways or particular outdoor environments, gardens or for creating plays of light on house facades or illuminating paths under small porches or verandas.

Its operation requires the use of a driver to be placed remotely and to be ordered separately.

Collection d'appliques, plafonniers et lampadaires à lumière directe IP65, pour l'extérieur et l'intérieur, avec structure en acier inoxydable 304 et aluminium avec anodisation renforcée pour l'extérieur ou, dans la finition acier satiné, en acier inoxydable AISI 316L.

FINITIONS DISPONIBLES:

- .01 blanc
- .02 noir
- .06 vert
- .33 acier inoxydable AISI 316L
- .34 corten peint

La petite taille et le type de lumière, grâce à l'ouverture optique de 73°, sont idéaux pour éclairer des passages ou des environnements extérieurs particuliers, des jardins ou pour créer des jeux de lumière sur les façades de maisons ou éclairer des allées sous de petits porches ou vérandas.

Son fonctionnement nécessite l'utilisation d'une alimentation à placer à distance et à commander séparément.

Colección de apliques, plafones y lámparas de pie de luz directa IP65, tanto para uso exterior como interior, con estructura en acero inoxidable 304 y aluminio con anodizado reforzado para uso exterior o, en el acabado acero satinado, en acero inoxidable AISI 316L.

ACABADOS DISPONIBLES:

- .01 blanco
- .02 negro
- .06 verde
- .33 acero inoxidable AISI 316L
- .34 corten pintado

El pequeño tamaño y el tipo de luz, gracias a la apertura óptica de 73°, son ideales para iluminar zonas de paso o ambientes exteriores particulares, jardines o para crear juegos de luz en fachadas de casas o iluminar caminos bajo pequeños porches o terrazas.

Su funcionamiento requiere el uso de una fuente de alimentación que se colocará de forma remota y se pedirá por separado.

Kollektion von Wand-, Decken- und Stehleuchten mit IP65-Direktlicht für den Außen- und Innenbereich, mit Struktur aus Edelstahl 304 und Aluminium mit verstärkter Eloxierung für den Außenbereich oder in satinierter Stahlausführung aus Edelstahl AISI 316L.

VERFÜGBARE AUSFÜHRUNGEN:

- .01 weiß
- .02 schwarz
- .06 grün
- .33 edelstahl AISI 316L
- .34 lackierter corten

Die geringe Größe und die Art des Lichts, dank der optischen Öffnung von 73°, sind ideal für die Beleuchtung von Durchgängen oder bestimmten Außenumgebungen, Gärten oder zur Schaffung von Lichtspielen an Hausfassaden oder zur Beleuchtung von Wegen unter kleinen Veranden oder Veranden.

Sein Betrieb erfordert die Verwendung eines Netzteils, das entfernt positioniert und separat bestellt werden muss.

Collezione di lampade IP65 a luce diretta da parete, plafone e terra, sia per esterno sia per interno, con struttura in acciaio INOX 304 e alluminio con anodizzazione rinforzata per esterni oppure, nella finitura in acciaio satinato, in INOX AISI 316L.

ДОСТУПНЫЕ ОТДЕЛКИ:

- .01 белый
- .02 черный
- .06 зеленый
- .33 Нержавеющая сталь AISI 316L
- .34 окрашенный кортен

Небольшой размер и тип света, благодаря оптической апертуре 73°, идеально подходят для освещения проходов или отдельных наружных пространств, садов или для создания световых игр на фасадах домов или для освещения дорожек под небольшими верандами или верандами.

Его работа требует использования источника питания, который должен быть расположен удаленно и заказывается отдельно.

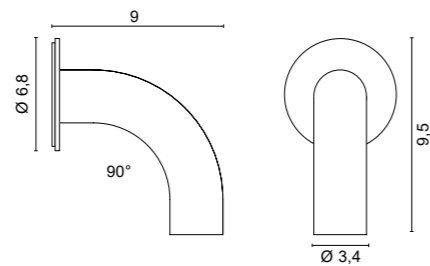
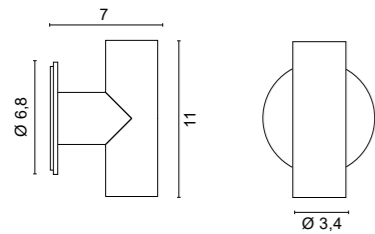
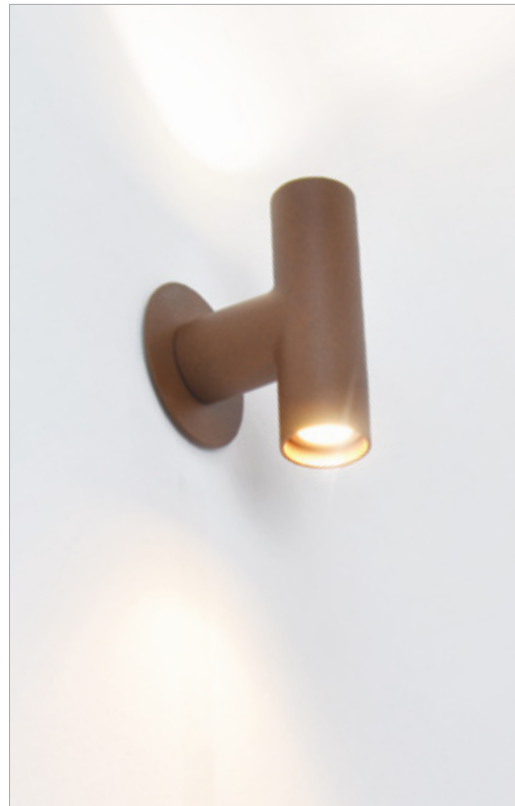

4672

- .01 Bianco - White
- .02 Nero - Black
- .06 Verde - Green
- .33 Acciaio - Stell
- Inox AISI 316L
- .34 Verniciato corten - Painted corten finishing

Color temperature	LED Light source	lm source
/W 4000K	3W 500mA	442lm
/WW 3000K	3W 500mA	420lm
/XW 2700K	3W 500mA	398lm



0,31 Kg

4673

- .01 Bianco - White
- .02 Nero - Black
- .06 Verde - Green
- .33 Acciaio - Stell
- Inox AISI 316L
- .34 Verniciato corten - Painted corten finishing

Color temperature	LED Light source	lm source
/W 4000K	1,5W 500mA	221lm
/WW 3000K	1,5W 500mA	210lm
/XW 2700K	1,5W 500mA	199lm



0,25 Kg



.01 Bianco - White .02 Nero - Black .06 Verde - Green .33 Acciaio - Stell
Inox AISI 316L .34 Verniciato corten
Painted corten finishing

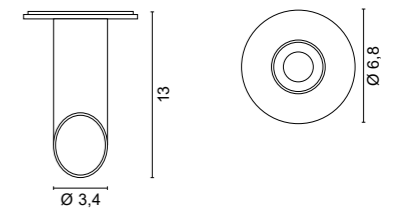
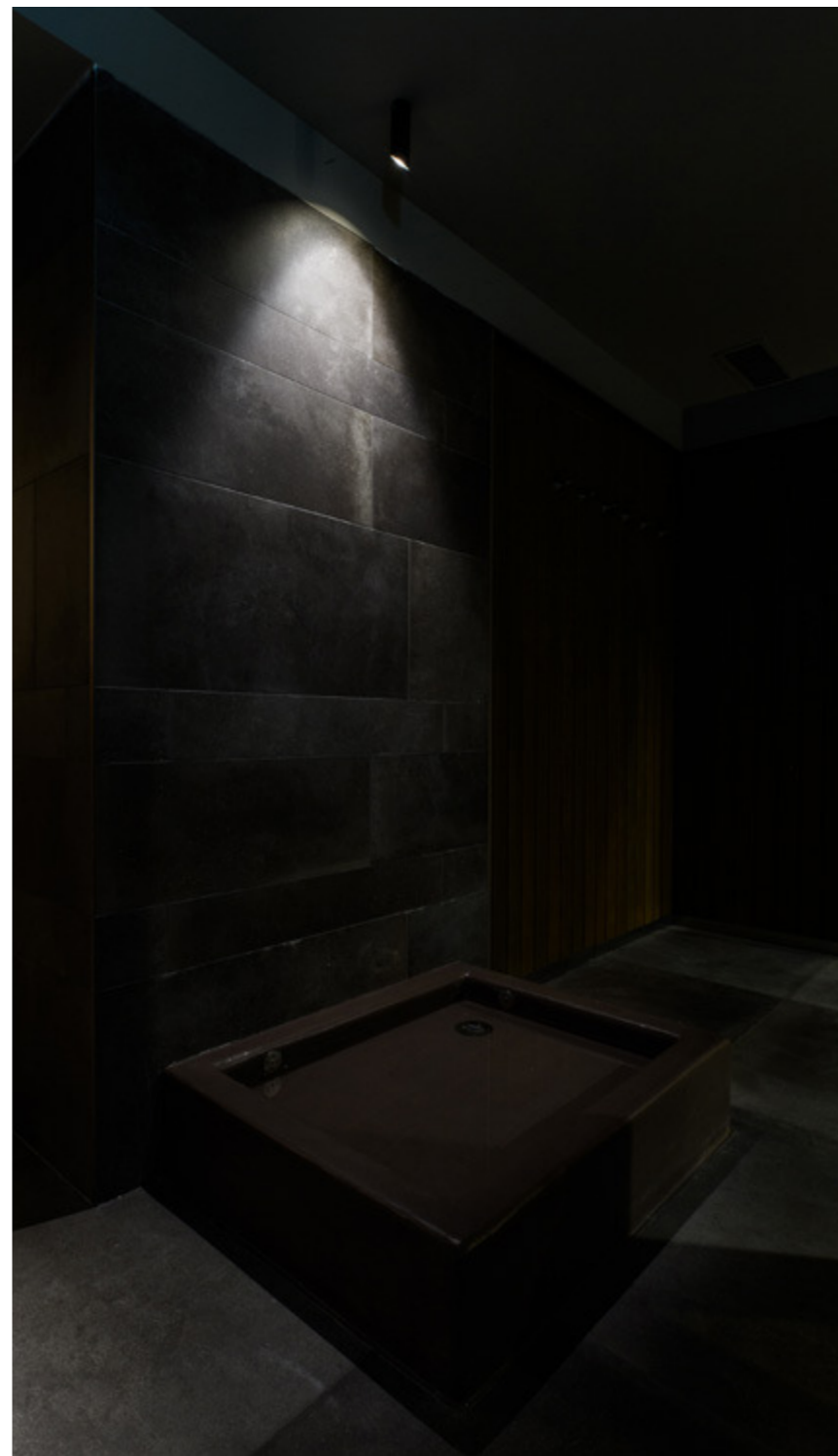

5690

- .01 Bianco - White
- .02 Nero - Black
- .06 Verde - Green
- .33 Acciaio - Stell
- Inox AISI 316L
- .34 Verniciato corten - Painted corten finishing

Color temperature	LED Light source	lm source
/W 4000K	1,5W 500mA	221lm
/WW 3000K	1,5W 500mA	210lm
/XW 2700K	1,5W 500mA	199lm



0,25 Kg

Cod. LED	Drivers ON/OFF	
	0143/IP	0127
	500mA	500mA
4672	1-3	1-3
4673	1-7	1-6
5690	1-7	1-6

Solo collegamento in serie - Only serial connection



IRIS

- 6750 - p. 32
- 6751 - p. 32
- 4640 - p. 36
- 4642 - p. 36
- 6752 - p. 34
- 6753 - p. 34
- 6754 - p. 34
- 4641 - p. 38
- 4643 - p. 38
- 6755 - p. 41
- 6756 - p. 41
- 4655 - p. 40
- 6755 - p. 41
- 6756 - p. 41

NEWTON

- 6342 - p. 44
- 6344 - p. 44
- 6481 - p. 45
- NEWTON SLIM**
- 6470 - p. 46
- 6471 - p. 46
- NEWTON FLAT**
- 6468 - p. 47
- 6469 - p. 47

NEWTON RECESSED

- 6238 - p. 48
- NEWTON SPOT EASY**
- 6326 - p. 49

STAR

- 6690 - p. 52
- 6691 - p. 52
- 6692 IP - p. 54
- 6693 RGB - p. 55
- 6695 - p. 56
- 6696 - p. 56

STAR MEDIUM

- 6710 - p. 58
- 6711 - p. 59
- 6713 - p. 60
- 6714 - p. 61
- STAR ASYMMETRIC**
- 6712 - p. 62
- STAR ADJUSTABLE**
- 6715 - p. 64
- 6716 - p. 64

STAR MAXI

- 6705 - p. 66
- 6706 - p. 66
- 6707 - p. 68
- 6708 - p. 68

DISSY QUADRO

- 6409 - p. 76
- DISSY TONDO**
- 6410 - p. 77

EASY QUADRO

- 6431 - p. 80
- 6432 - p. 80
- EASY TONDO**
- 6442 - p. 81
- 6441 - p. 81

TAPPO

- 6330 - p. 84
- 6329 - p. 84
- TAPPO ADJUSTABLE**
- 6318 - p. 86
- 6319 - p. 86
- TAPPO MINI 230V**
- 6325 - p. 87
- TAPPO QUADRO**
- 6670 - p. 88

EDY MINI

- 6298 - p. 92
- EDY MINI 45°**
- 6299 - p. 92
- EDY**
- 6305 - p. 94
- EDY 230V**
- 6302 - p. 95

GEKO MINI

- 6680 - p. 98
- GEKO MINI ADJUSTABLE**
- 6681 - p. 98
- GEKO 230V**
- 6290 - p. 99
- GEKO ADJUSTABLE 230V**
- 6455 - p. 99

GEKO

- 6460 - p. 100
- GEKO ADJUSTABLE**
- 6447 - p. 101
- GEKO QUADRO ADJUSTABLE**
- 6048 - p. 102
- GEKO QUADRO 230V ADJUSTABLE**
- 6056 - p. 103

ZEN LED

- 6420 - p. 106
- MODUS LED**
- 6421 - p. 106
- ZEN**
- 6251 - p. 107
- MODUS**
- 6265 - p. 107

KRONO

- 6314 - p. 104
- TAPPO EDISON**
- 6561 - p. 108
- GEKO EDISON**
- 6560 - p. 108

OKKIO

- 6324 - p. 109
- SNORKY INCASSO**
- 6698 - p. 109

CORNO MINI 230V

- 6238 - p. 110
- CORNO 12V**
- 6240 - p. 110
- CORNO 230V**
- 6241 - p. 110

EOS PIU'

- 6263 - p. 111
- GAMMA**
- 6249 - p. 111
- STELLA**
- 6204 - p. 111

SPECCHIO INCASSO

- 6024 - p. 112
- SPECCHIO CORTO**
- 6030 - p. 112
- SPECCHIO LUNGO**
- 6028 - p. 112



IRIS design: U.T. EGOLUCE

Collezione di piccoli proiettori orientabili con corpo in alluminio e sorgente COB LED integrata ad elevate prestazioni con luce diretta e d'accento.

FINITURE DISPONIBILI:

- .01 bianco (RAL 9016 opaco)
- .02 nero (RAL 9005 opaco)
- .25 dorato satinato (Art. 6750 e Art. 6751)

CARATTERISTICHE DEL PRODOTTO:

- Dissipazione passiva
- Inclinazione 90° sul piano orizzontale con uno snodo
- Inclinazione 180° sul piano orizzontale con doppio snodo
- Rotazione 350° sull'asse verticale
- Possibilità d'installazione ad incasso su cartongesso o in muratura con apposita cassaforma
- Diverse ottiche disponibili

Iris è fornito con LED COB da 2700K (XW), 3000K (WW) e 4000K (W) con CRI>80 e riflettore con diverse aperture: 25°, 48° e 63°. La lente frontale, in vetro, può essere trasparente o satinata (/ST). A richiesta CRI>90.

Le ridotte dimensioni del proiettore lo rendono uno strumento ideale per sottolineare e disegnare con una luce puntuale oggetti e colori all'interno di spazi espositivi e vetrine ma anche valorizzare angoli e ambienti di case e locali privati.

Il funzionamento prevede l'utilizzo di un alimentatore da ordinare separatamente. Sono disponibili anche alimentatori dimmerabili per un controllo PUSH, 1...10V o DALI e unità per il funzionamento in emergenza.

Possibilità di funzionamento a 24V con art. 0226 (p. 370).

Collection of small adjustable projectors with aluminum body and high performance integrated COB LED source with direct and accent light.

AVAILABLE FINISHES:

- .01 white (RAL 9016 matt)
- .02 black (RAL 9005 matt)
- .25 satin gold (Art. 6750 and Art. 6751)

PRODUCT FEATURES:

- Passive dissipation
- 90° inclination on the horizontal plane with a joint
- 180° inclination on the horizontal plane with double joint
- Rotation of 350° on the vertical axis
- Possibility of recessed installation on plasterboard or masonry with a special formwork
- Different optics beams

Iris is supplied with 2700K (XW), 3000K (WW) and 4000K (W) COB LEDs with CRI>80 and reflector with different optics beams: 25°, 48° and 63°. The front glass lens can be transparent or satin (/ST). On request CRI>90.

The small size of the projector makes it an ideal tool for highlighting and designing objects and colors with punctual light in exhibition spaces and shop windows, but also for enhancing corners and environments of homes and private premises.

Operation involves the use of a driver to be ordered separately. Dimmable drivers for PUSH, 1...10V or DALI control and units for emergency operation are also available.

Possibility of operation at 24V with art. 0226 (p. 370).

Collection de petits projecteurs orientables avec corps en aluminium et source LED COB intégrée haute performance à lumière directe et d'accentuation.

FINITIONS DISPONIBLES:

- .01 blanc (RAL 9016 mat)
- .02 noir (RAL 9005 mat)
- .25 or satiné (Art. 6750 et Art. 6751)

CARACTÉRISTIQUES DU PRODUIT:

- Dissipation passive
- Inclinaison à 90° sur le plan horizontal avec une articulation
- Inclinaison à 180° sur le plan horizontal avec double articulation
- Rotation de 350° sur l'axe vertical
- Possibilité d'installation encastrée sur plaque de plâtre ou maçonnerie avec un coffrage spécial
- Différentes optiques disponibles

Iris est fourni avec des LED COB 2700K (XW), 3000K (WW) et 4000K (W) avec CRI>80 et un réflecteur avec différentes ouvertures : 25°, 48° et 63°. La lentille en verre avant peut être transparente ou satinée (/ST). Sur demande CRI>90.

La petite taille du projecteur en fait un outil idéal pour souligner et concevoir des objets et des couleurs avec une lumière précise dans les espaces d'exposition et les vitrines, mais aussi pour mettre en valeur les coins et les environnements des maisons et des locaux privés.

Le fonctionnement implique l'utilisation d'une alimentation à commander séparément. Des alimentations graduables pour le contrôle PUSH, 1...10V ou DALI et des unités pour le fonctionnement d'urgence sont également disponibles.

Possibilité de fonctionnement en 24V avec art. 0226 (p. 370).

Colección de pequeños proyectores orientables con cuerpo de aluminio y fuente LED COB integrada de alto rendimiento con luz directa y de acento.

ACABADOS DISPONIBLES:

- .01 blanco (RAL 9016 mate)
- .02 negro (RAL 9005 mate)
- .25 oro satinado (Art. 6750 y Art. 6751)

CARACTERÍSTICAS DEL PRODUCTO:

- Dissipación pasiva
- Inclinación de 90° sobre el plano horizontal con articulación
- Inclinación de 180° sobre el plano horizontal con doble articulación
- Rotación de 350° sobre el eje vertical
- Posibilidad de instalación empotrada sobre cartón yeso o mampostería con encofrado especial
- Distintas ópticas disponibles

Iris se suministra con LED COB de 2700K (XW), 3000K (WW) y 4000K (W) con CRI>80 y reflector con diferentes aperturas: 25°, 48° y 63°. La lente de cristal frontal puede ser transparente o satinada (/ST). Bajo pedido CRI>90.

El pequeño tamaño del proyector lo convierte en una herramienta ideal para subrayar y diseñar objetos y colores con luz precisa en espacios de exposición y escaparates, pero también para realzar rincones y ambientes en viviendas y locales privados.

El funcionamiento implica el uso de una fuente de alimentación que se pedirá por separado. También están disponibles alimentaciones regulables para control PUSH, 1...10V o DALI y unidades para operación de emergencia.

Posibilidad de funcionamiento a 24V con arte 0226 (p. 370).

Sammlung kleiner verstellbarer Projektoren mit Aluminiumgehäuse und integrierter Hochleistungs-COB-LED-Quelle mit direktem und akzentuiertem Licht.

VERFÜGBARE AUSFÜHRUNGEN:

- .01 weiß (RAL 9016 matt)
- .02 schwarz (RAL 9005 matt)
- .25 Satingold (Art. 6750 und Art. 6751)

PRODUKTEIGENSCHAFTEN:

- Passive Ableitung
- 90°-Neigung in der Horizontalen mit Gelenk
- 180° Neigung in der Horizontalen mit Doppelgelenk
- Drehung um 350° um die vertikale Achse
- Möglichkeit der versenkten Montage auf Gipskarton oder Mauerwerk mit einer speziellen Schalung
- Verschiedene Optiken erhältlich

Iris wird mit 2700K (XW), 3000K (WW) und 4000K (W) COB-LEDs mit CRI>80 und Reflektor mit verschiedenen Aperturen geliefert: 25°, 48° und 63°. Die vordere Glasscheibe kann transparent oder satiniert (/ST) sein. Auf Anfrage CRI>90.

Die geringe Größe des Projektors macht ihn zu einem idealen Werkzeug, um Objekte und Farben mit präzisiertem Licht in Ausstellungsräumen und Schaufenstern zu unterstreichen und zu gestalten, aber auch um Ecken und Umgebungen in Wohnungen und Privaträumen aufzuwerten.

Der Betrieb erfolgt über ein separat zu bestellendes Netzteil. Dimmbare Netzteil für PUSH-, 1...10V- oder DALI-Steuerung und Geräte für den Notbetrieb sind ebenfalls erhältlich.

Möglichkeit des Betriebs bei 24 V mit Kunst. 0226 (p.370).

Collezione di piccoli regolabili proiettori con corpo in alluminio e sorgente COB LED integrata ad elevate prestazioni con luce diretta e d'accento.

ДОСТУПНЫЕ ОТДЕЛКИ:

- .01 белый (RAL 9016 матовый)
- .02 черный (RAL 9005, матовый)
- .25 сатинированное золото (Art. 6750 и Art. 6751)

ОСОБЕННОСТИ ПРОДУКТА:

- Пассивное рассеивание
- Наклон 90° в горизонтальной плоскости с шарниром
- Наклон 180° в горизонтальной плоскости с двойным шарниром
- Вращение на 350° по вертикальной оси
- Возможность заглубленного монтажа при помощи специальной опалубки
- Доступна различная оптика

Iris поставляется с COB-светодиодами 2700K (XW), 3000K (WW) и 4000K (W) с CRI>80 и отражателем с различной апертурой: 25°, 48° и 63°. Передняя стеклянная линза может быть прозрачной или матовой (/ST). По запросу CRI>90.

Небольшой размер проектора делает его идеальным инструментом для подчеркивания и оформления объектов и цветов с помощью точного света в выставочных залах и витринах, а также для улучшения углов и окружения в домах и частных помещениях.

Эксплуатация предполагает использование блока питания, который заказывается отдельно. Также доступны источник питания для управления PUSH, 1...10V или DALI, а также устройства для аварийного режима.

Возможность работы на 24В с искусством. 0226 (p. 370).



Spots

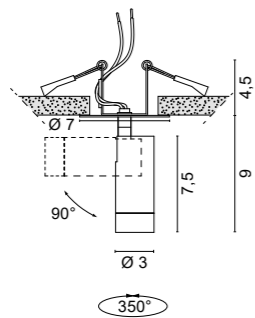

5,5 cm

6750

- .01 Bianco - White
- .02 Nero - Black
- .25 Dorato satinato - Satin golded

Color temperature	Optics	LED light source	lm source	lm output
/W 4000K	/25 /48 /63	5,9W 17V 350mA	1060lm	880lm
/W 4000K	/ST Satinato - Satin	5,9W 17V 350mA	1060lm	816lm
/WW 3000K	/25 /48 /63	5,9W 17V 350mA	1030lm	855lm
/WW 3000K	/ST Satinato - Satin	5,9W 17V 350mA	1030lm	793lm
/XW 2700K	/25 /48 /63	5,9W 17V 350mA	969lm	804lm
/XW 2700K	/ST Satinato - Satin	5,9W 17V 350mA	969lm	746lm



0,23 Kg

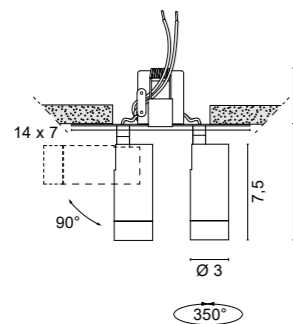

5,5 x 8,5 cm

6751

- .01 Bianco - White
- .02 Nero - Black
- .25 Dorato satinato - Satin golded

Color temperature	Optics	LED light source	lm source	lm output
/W 4000K	/25 /48 /63	11,8W 34V 350mA	2120lm	1760lm
/W 4000K	/ST Satinato - Satin	11,8W 34V 350mA	2120lm	1632lm
/WW 3000K	/25 /48 /63	11,8W 34V 350mA	2060lm	1710lm
/WW 3000K	/ST Satinato - Satin	11,8W 34V 350mA	2060lm	1586lm
/XW 2700K	/25 /48 /63	11,8W 34V 350mA	1938lm	1608lm
/XW 2700K	/ST Satinato - Satin	11,8W 34V 350mA	1938lm	1492lm



0,40 Kg

Iris a incasso, disponibile anche con doppio proiettore deve essere installato su superfici in cartongesso. Disponibile anche versione in finitura galvanica in oro spazzolato.
Il driver è da ordinare separatamente, vedi tabella.

Iris recessed, also available with double projector, must be installed on plasterboard surfaces. Also available version in brushed gold galvanic finish. The driver must be ordered separately, see table.

Accessori - Accessories



0267/S

Frangiluce
Louvres

- .01 Bianco - White
- .02 Nero - Black



- .01 Bianco - White
- .02 Nero - Black
- .25 Dorato satinato
Satin gold



Art. 6750

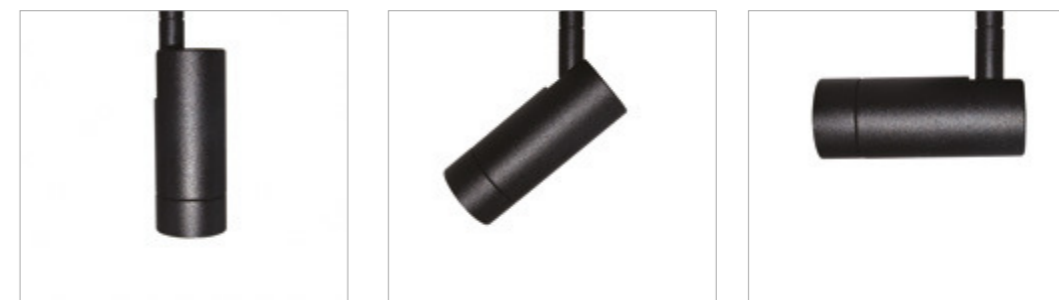

Drivers

Cod. LED	Drivers ON/OFF		DIMMABLE drivers				Casambi 0145/CASA	LED emergency unit 0115/EM Inverter + Battery + LED indicator
	0125 350mA	0128 350mA	0129 PUSH -1...10V DIM DALI	0141/DIM PUSH -1...10V DIM DALI	0145/DIM PUSH -1...10V DIM DALI	0145/DALI 0733/DIM PHASE CUT		
6750	1	1-2	1-2	1-2	1-3	1	1-3	1
6751	NO	1	1	1	1	NO	1-3	1

Solo collegamento in serie - Only serial connection

Spots

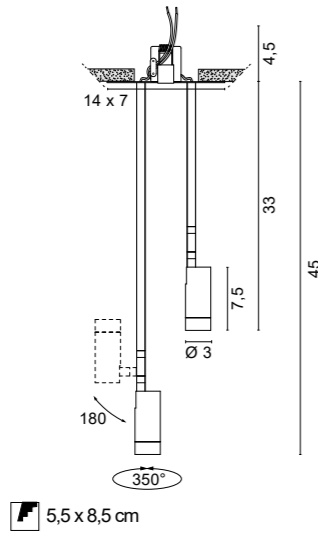

6752

- .01 Bianco - White
- .02 Nero - Black

Color temperature	Optics	LED light source	lm source	lm output
/W 4000K	/25 /48 /63	11,8W 34V 350mA	2120lm	1760lm
/W 4000K	/ST Satinato - Satin	11,8W 34V 350mA	2120lm	1632lm
/WW 3000K	/25 /48 /63	11,8W 34V 350mA	2060lm	1710lm
/WW 3000K	/ST Satinato - Satin	11,8W 34V 350mA	2060lm	1586lm
/XW 2700K	/25 /48 /63	11,8W 34V 350mA	1938lm	1608lm
/XW 2700K	/ST Satinato - Satin	11,8W 34V 350mA	1938lm	1492lm



0,47 Kg

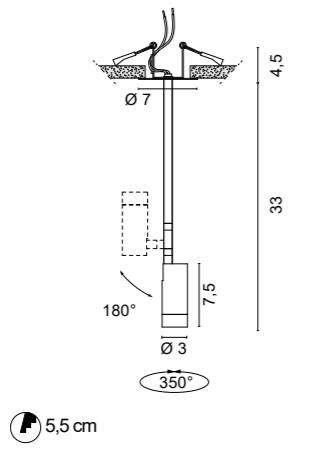

6753

- .01 Bianco - White
- .02 Nero - Black

Color temperature	Optics	LED light source	lm source	lm output
/W 4000K	/25 /48 /63	5,9W 17V 350mA	1060lm	880lm
/W 4000K	/ST Satinato - Satin	5,9W 17V 350mA	1060lm	816lm
/WW 3000K	/25 /48 /63	5,9W 17V 350mA	1030lm	855lm
/WW 3000K	/ST Satinato - Satin	5,9W 17V 350mA	1030lm	793lm
/XW 2700K	/25 /48 /63	5,9W 17V 350mA	969lm	804lm
/XW 2700K	/ST Satinato - Satin	5,9W 17V 350mA	969lm	746lm



0,23 Kg

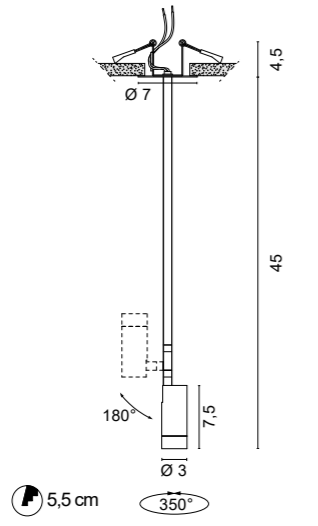
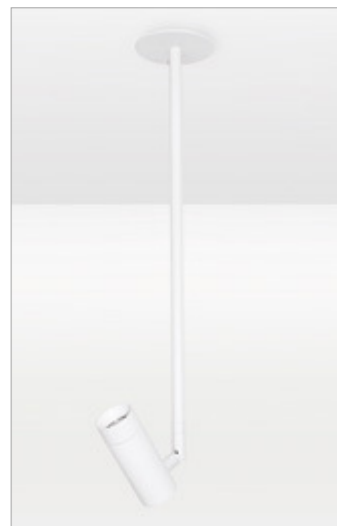

6754

- .01 Bianco - White
- .02 Nero - Black

Color temperature	Optics	LED light source	lm source	lm output
/W 4000K	/25 /48 /63	5,9W 17V 350mA	1060lm	880lm
/W 4000K	/ST Satinato - Satin	5,9W 17V 350mA	1060lm	816lm
/WW 3000K	/25 /48 /63	5,9W 17V 350mA	1030lm	855lm
/WW 3000K	/ST Satinato - Satin	5,9W 17V 350mA	1030lm	793lm
/XW 2700K	/25 /48 /63	5,9W 17V 350mA	969lm	804lm
/XW 2700K	/ST Satinato - Satin	5,9W 17V 350mA	969lm	746lm



0,25 Kg

Iris a incasso, disponibile anche con doppio proiettore deve essere installato su superfici in cartongesso. Il driver è da ordinare separatamente, vedi tabella.

Iris recessed, also available with double projector, must be installed on plasterboard surfaces. The driver must be ordered separately, see table.

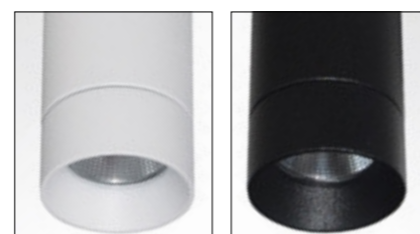

.01 Bianco - White

.02 Nero - Black

Accessori - Accessories



0267/S

Frangiluce
Louvres

- .01 Bianco - White
- .02 Nero - Black



La costruzione con doppio snodo consente anche di indirizzare la luce sulla superficie di installazione. The double joint construction also allows the light to be directed onto the installation surface.



Drivers

Cod. LED	Drivers ON/OFF		DIMMABLE drivers				Casambi 0145/CASA	LED emergency unit 0115/EM Inverter + Battery + LED indicator
	0125 350mA	0128 350mA	0129 DIM DALI	0141/DIM PUSH -1...10V 0141/DALI DIM DALI	0145/DIM PUSH -1...10V 0145/DALI DIM DALI	0733/DIM PHASE CUT		
6752	NO	1	1	1	1	NO	1-3	1
6753	1	1-2	1-2	1-2	1-3	1	1-3	1
6754	1	1-2	1-2	1-2	1-3	1	1-3	1

Solo collegamento in serie - Only serial connection

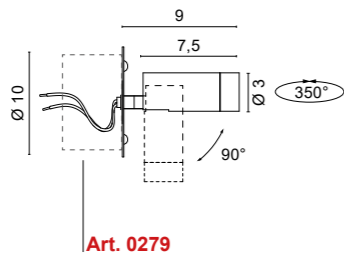
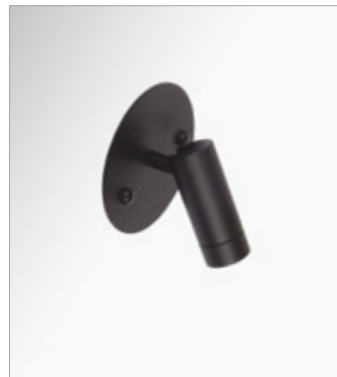

Art. 0279

4640

- .01 Bianco - White
- .02 Nero - Black

Color temperature	Optics	LED light source	lm source	lm output
/W 4000K	/25 /48 /63	5,9W 17V 350mA	1060lm	880lm
/W 4000K	/ST Satinato - Satin	5,9W 17V 350mA	1060lm	816lm
/WW 3000K	/25 /48 /63	5,9W 17V 350mA	1030lm	855lm
/WW 3000K	/ST Satinato - Satin	5,9W 17V 350mA	1030lm	793lm
/XW 2700K	/25 /48 /63	5,9W 17V 350mA	969lm	804lm
/XW 2700K	/ST Satinato - Satin	5,9W 17V 350mA	969lm	746lm



0,20 Kg

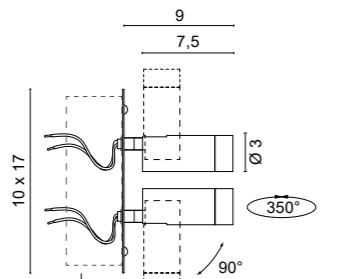

Art. 0280

4642

- .01 Bianco - White
- .02 Nero - Black

Color temperature	Optics	LED light source	lm source	lm output
/W 4000K	/25 /48 /63	11,8W 34V 350mA	2120lm	1760lm
/W 4000K	/ST Satinato - Satin	11,8W 34V 350mA	2120lm	1632lm
/WW 3000K	/25 /48 /63	11,8W 34V 350mA	2060lm	1710lm
/WW 3000K	/ST Satinato - Satin	11,8W 34V 350mA	2060lm	1586lm
/XW 2700K	/25 /48 /63	11,8W 34V 350mA	1938lm	1608lm
/XW 2700K	/ST Satinato - Satin	11,8W 34V 350mA	1938lm	1492lm



0,35 Kg

La lampada può essere installata in muratura con apposita cassaforma o direttamente su pannellatura. Le cassaforme a parete possono contenere i driver. I driver e le cassaforme sono da ordinare separatamente, vedi tabella.

The lamp can be installed in masonry with a special formwork or directly on the paneling. Wall-mounted formwork can contain drivers. Drivers and housing are to be ordered separately, see table.

Accessori - Accessories



0267/S

Frangiluce
Louvres

- .01 Bianco - White
- .02 Nero - Black



0279

Box per muratura (art. 4640- 4641)
Wallbox (art. 4640- 4641)



0280

Box per muratura (art. 4642- 4643)
Wallbox (art. 4642- 4643)



.01 Bianco - White



.02 Nero - Black



Drivers ON/OFF

Cod. LED	0137/LED	0128
	350mA	350mA
4640	1	NO
4642	NO	1

Solo collegamento in serie - Only serial connection

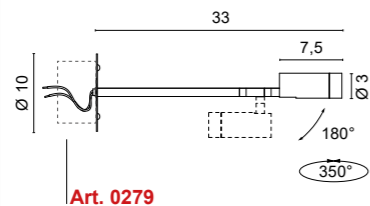

Art. 0279

4641

- .01 Bianco - White
- .02 Nero - Black

Color temperature	Optics	LED light source	lm source	lm output
<i>/W</i> 4000K	<i>/25 /48 /63</i>	5,9W 17V 350mA	1060lm	880lm
<i>/W</i> 4000K	<i>/ST Satinato - Satin</i>	5,9W 17V 350mA	1060lm	816lm
<i>/WW</i> 3000K	<i>/25 /48 /63</i>	5,9W 17V 350mA	1030lm	855lm
<i>/WW</i> 3000K	<i>/ST Satinato - Satin</i>	5,9W 17V 350mA	1030lm	793lm
<i>/XW</i> 2700K	<i>/25 /48 /63</i>	5,9W 17V 350mA	969lm	804lm
<i>/XW</i> 2700K	<i>/ST Satinato - Satin</i>	5,9W 17V 350mA	969lm	746lm



0,20 Kg

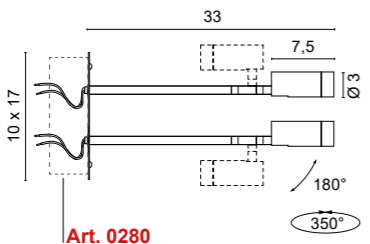

Art. 0280

4643

- .01 Bianco - White
- .02 Nero - Black

Color temperature	Optics	LED light source	lm source	lm output
<i>/W</i> 4000K	<i>/25 /48 /63</i>	11,8W 34V 350mA	2120lm	1760lm
<i>/W</i> 4000K	<i>/ST Satinato - Satin</i>	11,8W 34V 350mA	2120lm	1632lm
<i>/WW</i> 3000K	<i>/25 /48 /63</i>	11,8W 34V 350mA	2060lm	1710lm
<i>/WW</i> 3000K	<i>/ST Satinato - Satin</i>	11,8W 34V 350mA	2060lm	1586lm
<i>/XW</i> 2700K	<i>/25 /48 /63</i>	11,8W 34V 350mA	1938lm	1608lm
<i>/XW</i> 2700K	<i>/ST Satinato - Satin</i>	11,8W 34V 350mA	1938lm	1492lm



0,42 Kg

La lampada può essere installata in muratura con apposita cassaforma o direttamente su pannellatura. Le cassaforme a parete possono contenere i driver. I driver e le cassaforme sono da ordinare separatamente, vedi tabella.

The lamp can be installed in masonry with a special formwork or directly on the paneling. Wall-mounted formwork can contain drivers. Drivers and housing are to be ordered separately, see table.

Accessori - Accessories



0267/S

Frangiluce
Louvres

- .01 Bianco - White
- .02 Nero - Black

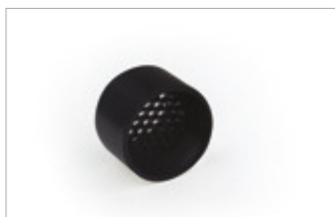

0279

Box per muratura (art. 4640- 4641)
Wallbox (art. 4640- 4641)



0280

Box per muratura (art. 4642- 4643)
Wallbox (art. 4642- 4643)



.01 Bianco - White



.02 Nero - Black

La costruzione con doppio snodo consente anche di indirizzare la luce sulla superficie di installazione.

The double joint construction also allows the light to be directed onto the installation surface.



Drivers ON/OFF

Cod. LED	0137/LED 350mA	0128 350mA
4641	1	NO
4643	NO	1

Solo collegamento in serie - Only serial connection

Spots

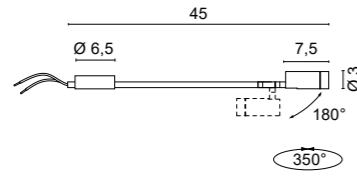

4655

- .01** Bianco - White
- .02** Nero - Black
- .25** Dorato satinato - Satin golded

Color temperature	Optics	LED light source	lm source	lm output
<i>/W</i> 4000K	<i>/25 /48 /63</i>	5,9W 17V 350mA	1060lm	880lm
<i>/W</i> 4000K	<i>/ST Satinato - Satin</i>	5,9W 17V 350mA	1060lm	816lm
<i>/WW</i> 3000K	<i>/25 /48 /63</i>	5,9W 17V 350mA	1030lm	855lm
<i>/WW</i> 3000K	<i>/ST Satinato - Satin</i>	5,9W 17V 350mA	1030lm	793lm
<i>/XW</i> 2700K	<i>/25 /48 /63</i>	5,9W 17V 350mA	969lm	804lm
<i>/XW</i> 2700K	<i>/ST Satinato - Satin</i>	5,9W 17V 350mA	969lm	746lm



0,30 Kg

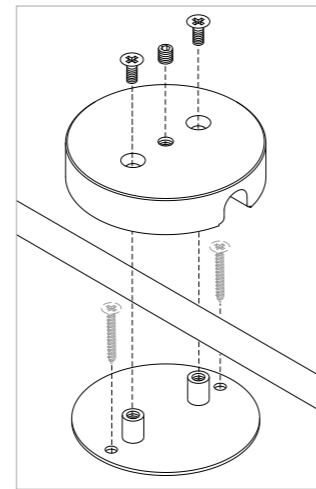
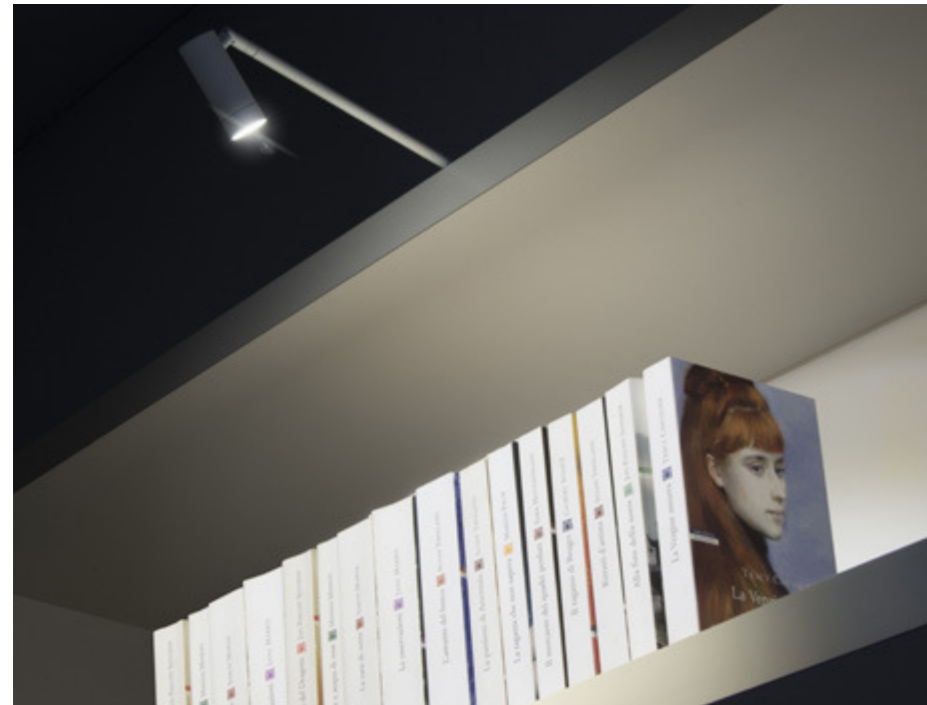

Il modello è fornito con apposito sistema per il montaggio su mensola con viti. I driver sono da ordinare separatamente, vedi tabella.

The model is supplied with a special system for mounting on a shelf with screws. Drivers are to be ordered separately, see table.

La costruzione con doppio snodo consente anche di indirizzare la luce sulla superficie di installazione.
The double joint construction also allows the light to be directed onto the installation surface.

Accessori - Accessories



0267/S

Frangiluce
Louvres

- .01** Bianco - White
- .02** Nero - Black



.01 Bianco - White

.02 Nero - Black

.25 Dorato satinato
Satin gold

Drivers

DIMMABLE drivers

Cod. LED	Drivers ON/OFF		DIMMABLE drivers				Casambi 0145/CASA	LED emergency unit 0115/EM Inverter + Battery + LED indicator
	0125 350mA	0128 350mA	0129 DIM DALI	0141 DALI	0145 DALI	0733 DIM PHASE CUT		
4655	1	1-2	1-2	1-2	1-3	1	1-3	1

Solo collegamento in serie - Only serial connection

Spots

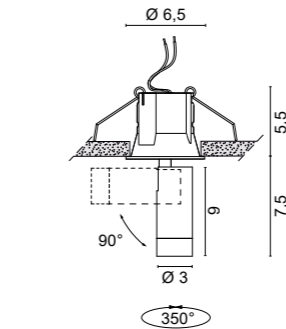

6755

- .01** Bianco - White
- .02** Nero - Black

Color temperature	Optics	LED light source	lm source	lm output
<i>/W</i> 4000K	<i>/25 /48 /63</i>	5,9W 17V 350mA	1060lm	880lm
<i>/W</i> 4000K	<i>/ST Satinato - Satin</i>	5,9W 17V 350mA	1060lm	816lm
<i>/WW</i> 3000K	<i>/25 /48 /63</i>	5,9W 17V 350mA	1030lm	855lm
<i>/WW</i> 3000K	<i>/ST Satinato - Satin</i>	5,9W 17V 350mA	1030lm	793lm
<i>/XW</i> 2700K	<i>/25 /48 /63</i>	5,9W 17V 350mA	969lm	804lm
<i>/XW</i> 2700K	<i>/ST Satinato - Satin</i>	5,9W 17V 350mA	969lm	746lm



0,20 Kg

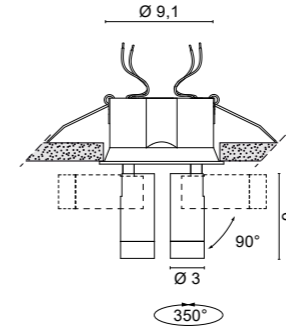
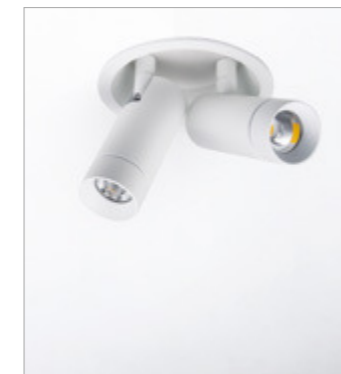

6756

- .01** Bianco - White
- .02** Nero - Black

Color temperature	Optics	LED light source	lm source	lm output
<i>/W</i> 4000K	<i>/25 /48 /63</i>	11,8W 34V 350mA	2120lm	1760lm
<i>/W</i> 4000K	<i>/ST Satinato - Satin</i>	11,8W 34V 350mA	2120lm	1632lm
<i>/WW</i> 3000K	<i>/25 /48 /63</i>	11,8W 34V 350mA	2060lm	1710lm
<i>/WW</i> 3000K	<i>/ST Satinato - Satin</i>	11,8W 34V 350mA	2060lm	1586lm
<i>/XW</i> 2700K	<i>/25 /48 /63</i>	11,8W 34V 350mA	1938lm	1608lm
<i>/XW</i> 2700K	<i>/ST Satinato - Satin</i>	11,8W 34V 350mA	1938lm	1492lm



0,45 Kg



Accessori - Accessories



0267/S

Frangiluce
Louvres

- .01** Bianco - White
- .02** Nero - Black



.01 Bianco - White

.02 Nero - Black

Drivers

DIMMABLE drivers

Cod. LED	Drivers ON/OFF		DIMMABLE drivers				Casambi 0145/CASA	LED emergency unit 0115/EM Inverter + Battery + LED indicator
	0125 350mA	0128 350mA	0129 DIM DALI	0141 DALI	0145 DALI	0733 DIM PHASE CUT		
6755	1	1-2	1-2	1-2	1-3	1	1-3	1
6756	NO	1	1	1	1	NO	1-3	1

Solo collegamento in serie - Only serial connection

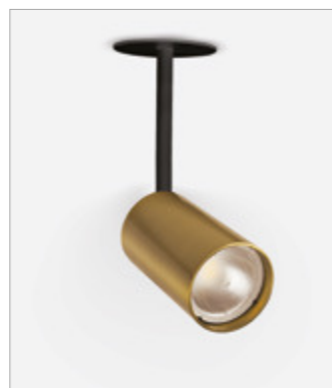

NEWTON

design: **U.T. EGOLUCE**

Collezione di proiettori orientabili da incasso, per installazioni su soffitto in cartongesso, con struttura in alluminio pressofuso e sorgente COB LED integrata ad elevate prestazioni con luce diretta e d'accento.

FINITURE DISPONIBILI:

- .01 bianco (RAL 9016 opaco)
- .02 nero (RAL 9005 opaco)
- .02.25 nero e oro satinato (Art. 6480 e Art. 6481)
- .02.32 nero e nickel satinato (Art. 6480 e Art. 6481)

CARATTERISTICHE DEL PRODOTTO:

- Dissipazione passiva
- Inclinazione di 90° sul piano orizzontale
- Rotazione di 350° sull'asse verticale
- Diverse ottiche disponibili
- Accessori ottici

Newton è fornito con LED COB da 2700K (XW), 3000K (WW) e 4000K (W) con CRI>80 e riflettore con diverse aperture ottiche. La lente frontale, in vetro, può essere trasparente o satinata (ST). A richiesta CRI>90.

Le ridotte dimensioni del proiettore lo rendono uno strumento ideale per sottolineare e disegnare con una luce puntuale oggetti e colori all'interno di spazi espositivi e vetrine ma anche valorizzare angoli e ambienti di case e locali privati.

Il funzionamento prevede l'utilizzo di un alimentatore da ordinare separatamente. Sono disponibili anche alimentatori dimmerabili per un controllo PUSH, 1...10V o DALI e unità per il funzionamento in emergenza.

Possibilità di funzionamento a 24V con art. 0227 (p. 370).

Collection of adjustable recessed projectors, for installation on plasterboard ceilings, with die-cast aluminum structure and integrated high-performance COB LED source with direct and accent light.

AVAILABLE FINISHES:

- .01 white (RAL 9016 matt)
- .02 black (RAL 9005 matt)
- .02.25 black and satin gold (Art. 6480 and Art. 6481)
- .02.32 black and satin nickel (Art. 6480 and Art. 6481)

PRODUCT FEATURES:

- Passive dissipation
- 90° inclination on the horizontal plane
- Rotation of 350° on the vertical axis
- Different optics available
- Optical accessories

Newton is supplied with 2700K (XW), 3000K (WW) and 4000K (W) COB LEDs with CRI>80 and reflector with different optics beams. The front glass lens can be transparent or satin (ST). On request CRI>90.

The small size of the projector makes it an ideal tool for underlining and designing objects and colors with precise light in exhibition spaces and shop windows, but also for enhancing corners and environments in homes and private premises.

Operation involves the use of a driver to be ordered separately. Dimmable drivers for PUSH, 1...10V or DALI control and units for emergency operation are also available.

Possibility of operation at 24V with art. 0227 (p. 370).

Collection de projecteurs encastrés orientables, pour installation sur des plafonds en plaques de plâtre, avec structure en aluminium moulé sous pression et source LED COB haute performance intégrée à lumière directe et d'accentuation.

FINITIONS DISPONIBLES :

- .01 blanc (RAL 9016 mat)
- .02 noir (RAL 9005 mat)
- .02.25 noir et or satiné (Art. 6480 et Art. 6481)
- .02.32 noir et nickel satiné (Art. 6480 et Art. 6481)

CARACTÉRISTIQUES DU PRODUIT:

- Dissipation passive
- Inclinaison à 90° sur le plan horizontal
- Rotation de 350° sur l'axe vertical
- Différentes optiques disponibles
- Accessoires optiques

Newton est fourni avec des LED COB 2700K (XW), 3000K (WW) et 4000K (W) avec CRI>80 et un réflecteur avec différentes ouvertures optiques. La lentille en verre avant peut être transparente ou satinée (ST). Sur demande CRI>90.

La petite taille du projecteur en fait un outil idéal pour souligner et concevoir des objets et des couleurs avec une lumière précise dans les espaces d'exposition et les vitrines, mais aussi pour mettre en valeur les coins et les environnements des maisons et des locaux privés.

Le fonctionnement implique l'utilisation d'une alimentation à commander séparément. Des alimentations graduables avec commande PUSH, 1...10V, DALI ou à coupure de phase et des unités de commande pour l'éclairage de secours sont également disponibles.

Possibilité de fonctionnement en 24V avec art. 0227 (p. 370).

Colección de proyectores empotrables orientables, para instalación en techos de cartón yeso, con estructura de aluminio inyectado y fuente LED COB integrada de alto rendimiento con luz directa y de acento.

ACABADOS DISPONIBLES:

- .01 blanco (RAL 9016 mate)
- .02 negro (RAL 9005 mate)
- .02.25 negro y oro satinado (Art. 6480 y Art. 6481)
- .02.32 níquel negro y satinado (Art. 6480 y Art. 6481)

CARACTERÍSTICAS DEL PRODUCTO:

- Disipación pasiva
- Inclinación de 90° en el plano horizontal
- Rotación de 350° sobre el eje vertical
- Distintas ópticas disponibles
- Accesorios ópticos

Newton se suministra con LED COB de 2700K (XW), 3000K (WW) y 4000K (W) con CRI>80 y reflector con diferentes aperturas ópticas. La lente de cristal frontal puede ser transparente o satinada (ST). Bajo pedido CRI>90.

El pequeño tamaño del proyector lo convierte en una herramienta ideal para subrayar y diseñar objetos y colores con luz precisa en espacios de exposición y escaparates, pero también para realzar rincones y ambientes en viviendas y locales privados.

El funcionamiento implica el uso de una fuente de alimentación que se pedirá por separado. También están disponibles alimentación regulables para control PUSH, 1...10V o DALI y unidades para operación de emergencia.

Posibilidad de funcionamiento a 24V con arte 0227 (p. 370).

Kollektion verstellbarer Einbaustrahler zur Installation an Gipskartondecken mit Struktur aus Aluminiumdruckguss und integrierter COB-LED-Hochleistungsquelle mit direktem und akzentuiertem Licht.

VERFÜGBARE AUSFÜHRUNGEN:

- .01 weiß (RAL 9016 matt)
- .02 schwarz (RAL 9005 matt)
- .02.25 Schwarz und Satingold (Art. 6480 und Art. 6481)
- .02.32 schwarz und satiniertes Nickel (Art. 6480 und Art. 6481)

PRODUKTEIGENSCHAFTEN:

- Passive Ableitung
- 90°-Neigung auf der horizontalen Ebene
- Drehung um 350° um die vertikale Achse
- Verschiedene Optiken erhältlich
- Optisches Zubehör

Newton wird mit 2700K (XW), 3000K (WW) und 4000K (W) COB-LEDs mit CRI>80 und Reflektor mit unterschiedlichen optischen Öffnungen geliefert. Die vordere Glasscheibe kann transparent oder satiniert (ST) sein. Auf Anfrage CRI>90.

Die geringe Größe des Projektors macht ihn zu einem idealen Werkzeug, um Objekte und Farben mit präziser Licht in Ausstellungsräumen und Schaufenstern zu unterstreichen und zu gestalten, aber auch um Ecken und Umgebungen in Wohnungen und Privaträumen aufzuwerten.

Der Betrieb erfolgt über ein separat zu bestellendes Netzteil. Dimmbare Netzteil für PUSH-, 1...10V- oder DALI-Steuerung und Geräte für den Notbetrieb sind ebenfalls erhältlich.

Möglichkeit des Betriebs bei 24 V mit Kunst. 0227 (p. 370).

Collezione regolabile di inestettabili proiettori per installazione su soffitti in gesso, con struttura in alluminio pressofuso e sorgente COB LED integrata ad elevate prestazioni con luce diretta e d'accento.

ДОСТУПНЫЕ ОТДЕЛКИ:

- .01 белый (RAL 9016 матовый)
- .02 черный (RAL 9005, матовый)
- .02.25 черное и сатиновое золото (арт. 6480 и арт. 6481)
- .02.32 черный и матовый никель (арт. 6480 и арт. 6481)

ОСОБЕННОСТИ ПРОДУКТА:

- Пассивное рассеивание
- Наклон 90° в горизонтальной плоскости
- Вращение на 350° по вертикальной оси
- Доступна различная оптика
- Оптические аксессуары

Newton поставляется со светодиодами COB 2700K (XW), 3000K (WW) и 4000K (W) с CRI>80 и отражателем с различными оптическими отверстиями. Передняя стеклянная линза может быть прозрачной или матовой (ST). По запросу CRI>90.

Небольшой размер проектора делает его идеальным инструментом для подчеркивания и оформления объектов и цветов с помощью точного света в выставочных залах и витринах, а также для улучшения углов и окружения в домах и частных помещениях.

Эксплуатация предполагает использование блока питания, который заказывается отдельно. Также доступны источник питания для управления PUSH, 1...10V или DALI, а также устройства для аварийного режима.

Возможность работы на 24В с искусством. 0227 (p. 370).

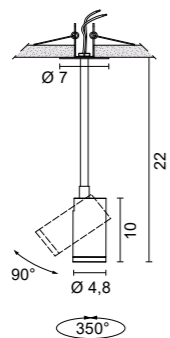

5,1 cm

6342 Newton

- .01 Bianco - White
- .02 Nero - Black

	Color temperature	Optics	LED light source	lm source	lm output
/W	4000K	/24 /38 /58	8,7W 17,5V 500mA	1466lm	1150lm
/W	4000K	/ST Satinato - Satin	8,7W 17,5V 500mA	1466lm	1099lm
/WW	3000K	/24 /38 /58	8,7W 17,5V 500mA	1424lm	1117lm
/WW	3000K	/ST Satinato - Satin	8,7W 17,5V 500mA	1424lm	1068lm
/XW	2700K	/24 /38 /58	8,7W 17,5V 500mA	1340lm	1051lm
/XW	2700K	/ST Satinato - Satin	8,7W 17,5V 500mA	1340lm	1005lm



0,55 Kg

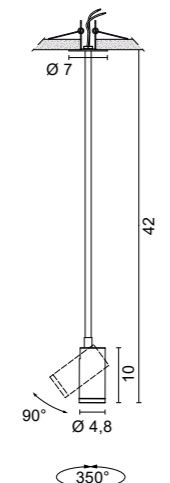

5,1 cm

6344 Newton

- .01 Bianco - White
- .02 Nero - Black

	Color temperature	Optics	LED light source	lm source	lm output
/W	4000K	/24 /38 /58	8,7W 17,5V 500mA	1466lm	1150lm
/W	4000K	/ST Satinato - Satin	8,7W 17,5V 500mA	1466lm	1099lm
/WW	3000K	/24 /38 /58	8,7W 17,5V 500mA	1424lm	1117lm
/WW	3000K	/ST Satinato - Satin	8,7W 17,5V 500mA	1424lm	1068lm
/XW	2700K	/24 /38 /58	8,7W 17,5V 500mA	1340lm	1051lm
/XW	2700K	/ST Satinato - Satin	8,7W 17,5V 500mA	1340lm	1005lm



0,60 Kg

Accessori - Accessories



0267

Frangiluce
Louvres

- .01 Bianco - White
- .02 Nero - Black

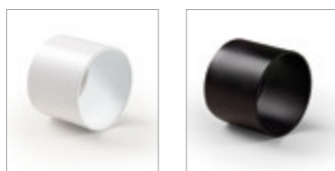

0274

Schermo antiabbagliamento
Anti-glare screen

- .01 Bianco - White
- .02 Nero - Black

Ottiche Disponibili - Available Optics



/24
Ottica fascio stretto per luce d'accento
Narrow beam optic for accent lighting



/38
Ottica fascio medio
Medium beam optic



/58
Ottica fascio largo
Wide beam optic



/ST
Ottica fascio diffuso per illuminazione generale
Diffused light optic for general lighting

Drivers

	Drivers ON/OFF		DIMMABLE drivers					Casambi	LED emergency unit
Cod.	0147/COB 500mA	0149/COB 500mA	0141/DIM PUSH - 1...10V	0141/DALI DIM DALI	0145/DALI DIM DALI	0145 DIM	0734/DIM PHASE CUT	0145/CASA	0115/EM Inverter + Battery + LED indicator
6342	1-2	1	1-2	1-2	1-3	1-3	1	1-3	1
6344	1-2	1	1-2	1-2	1-3	1-3	1	1-3	1

Solo collegamento in serie - Only serial connection

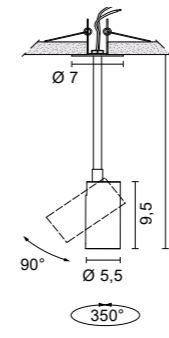
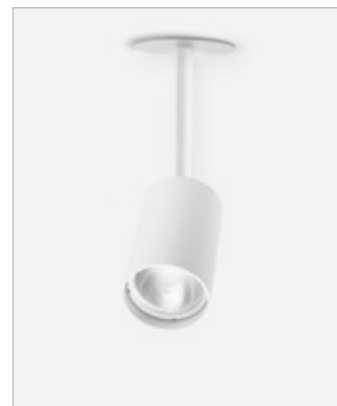

5,1 cm

6481 Newton Easy 230

- .01 Bianco - White
- .02 Nero - Black
- .02.25 Snodo nero, corpo dorato satinato - Black articulated joint, satin golded body
- .02.32 Snodo nero, corpo nickel satinato - Black articulated joint, nickel mat body

Light sources
7W GU10 LED DIM (cod. 0104/..)
7W GU10 LED (cod. 0094/..)
0,40 Kg



.01 Bianco - White



.02 Nero - Black

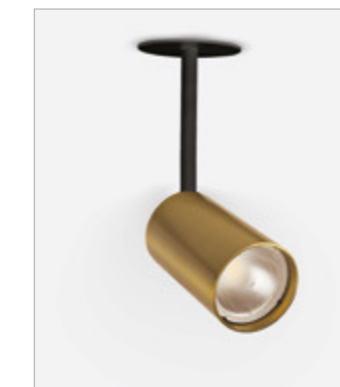

.02.25 Corpo dorato satinato
Satin golded body



.02.32 Corpo nickel satinato
Nickel mat body

NEWTON SLIM

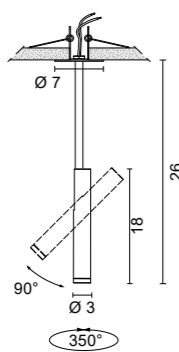

5,1 cm

6470 Newton Slim

- .01 Bianco - White
- .02 Nero - Black

Color temperature	Optics	LED light source	Im source	Im output
/W 4000K	/25 /48 /63	8,7W 17,5V 500mA	1466lm	1150lm
/W 4000K	/ST Satinato - Satin	8,7W 17,5V 500mA	1466lm	1099lm
/WW 3000K	/25 /48 /63	8,7W 17,5V 500mA	1424lm	1117lm
/WW 3000K	/ST Satinato - Satin	8,7W 17,5V 500mA	1424lm	1068lm
/XW 2700K	/25 /48 /63	8,7W 17,5V 500mA	1340lm	1051lm
/XW 2700K	/ST Satinato - Satin	8,7W 17,5V 500mA	1340lm	1005lm



0,50 Kg

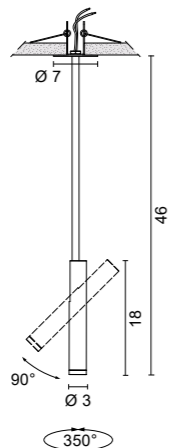

5,1 cm

6471 Newton Slim

- .01 Bianco - White
- .02 Nero - Black

Color temperature	Optics	LED light source	Im source	Im output
/W 4000K	/25 /48 /63	8,7W 17,5V 500mA	1466lm	1150lm
/W 4000K	/ST Satinato - Satin	8,7W 17,5V 500mA	1466lm	1099lm
/WW 3000K	/25 /48 /63	8,7W 17,5V 500mA	1424lm	1117lm
/WW 3000K	/ST Satinato - Satin	8,7W 17,5V 500mA	1424lm	1068lm
/XW 2700K	/25 /48 /63	8,7W 17,5V 500mA	1340lm	1051lm
/XW 2700K	/ST Satinato - Satin	8,7W 17,5V 500mA	1340lm	1005lm



0,70 Kg

Accessori - Accessories



0265

Diffusore in vetro Pyrex sabbato
Sand blasted Pyrex glass diffuser

- .01 Ghiera bianca - White ferrule
- .02 Ghiera nera - Black ferrule

0267/S

Frangilucente
Luovres

- .01 Bianco - White
- .02 Nero - Black

Ottiche Disponibili - Available Optics

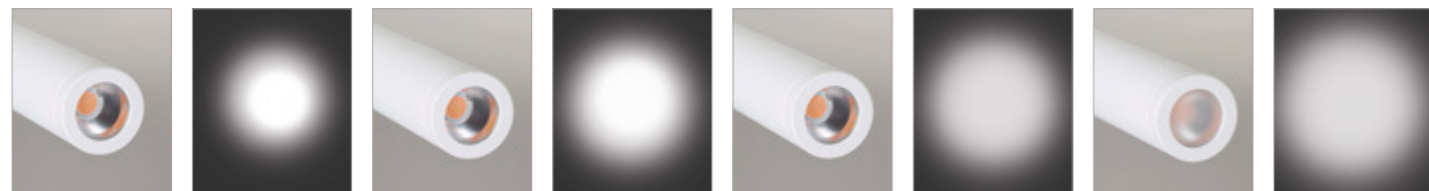

- /25**
Ottica fascio stretto per luce d'accento
Narrow beam optic for accent lighting
- /48**
Ottica fascio medio
Medium beam optic
- /63**
Ottica fascio largo
Wide beam optic
- /ST**
Ottica fascio diffuso per illuminazione generale
Diffused light optic for general lighting

Drivers

Cod.	Drivers ON/OFF		DIMMABLE drivers				Casambi	LED emergency unit
	0147/COB 500mA	0149/COB 500mA	0141/DIM PUSH - 1...10V	0141/DALI DIM DALI	0145/DALI DIM DALI	0145 DIM		
6470	1-2	1	1-2	1-2	1-3	1-3	1	1-3
6471	1-2	1	1-2	1-2	1-3	1-3	1	1-3

Solo collegamento in serie - Only serial connection

NEWTON FLAT

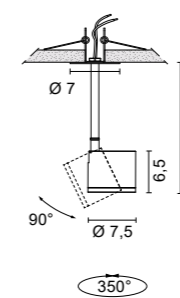
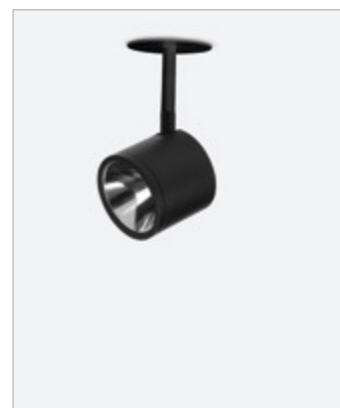

5,1 cm

6468 Newton Flat

- .01 Bianco - White
- .02 Nero - Black

Color temperature	Optics	LED light source	Im source	Im output
/W 4000K	/13 /40	8,7W 17,5V 500mA	1466lm	1150lm
/W 4000K	/ST Satinato - Satin	8,7W 17,5V 500mA	1466lm	1099lm
/WW 3000K	/13 /40	8,7W 17,5V 500mA	1424lm	1117lm
/WW 3000K	/ST Satinato - Satin	8,7W 17,5V 500mA	1424lm	1068lm
/XW 2700K	/13 /40	8,7W 17,5V 500mA	1340lm	1051lm
/XW 2700K	/ST Satinato - Satin	8,7W 17,5V 500mA	1340lm	1005lm



0,60 Kg

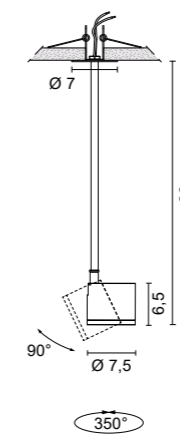
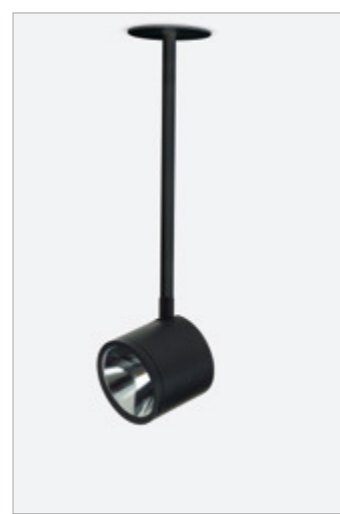

5,1 cm

6469 Newton Flat

- .01 Bianco - White
- .02 Nero - Black

Color temperature	Optics	LED light source	Im source	Im output
/W 4000K	/13 /40	8,7W 17,5V 500mA	1466lm	1150lm
/W 4000K	/ST Satinato - Satin	8,7W 17,5V 500mA	1466lm	1099lm
/WW 3000K	/13 /40	8,7W 17,5V 500mA	1424lm	1117lm
/WW 3000K	/ST Satinato - Satin	8,7W 17,5V 500mA	1424lm	1068lm
/XW 2700K	/13 /40	8,7W 17,5V 500mA	1340lm	1051lm
/XW 2700K	/ST Satinato - Satin	8,7W 17,5V 500mA	1340lm	1005lm



0,70 Kg

Accessori - Accessories



0264

Parabola decorativa
Decorative parabolic reflector

- .01 Bianco - White
- .02 Nero - Black

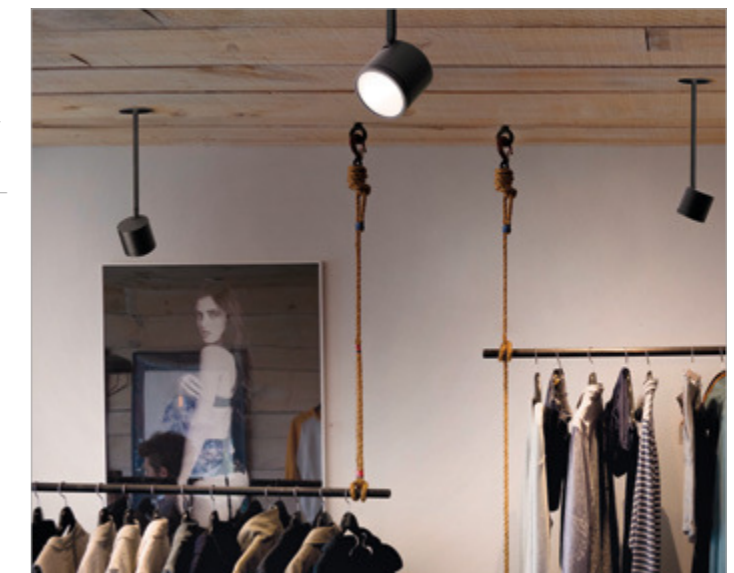

Ottiche Disponibili - Available Optics

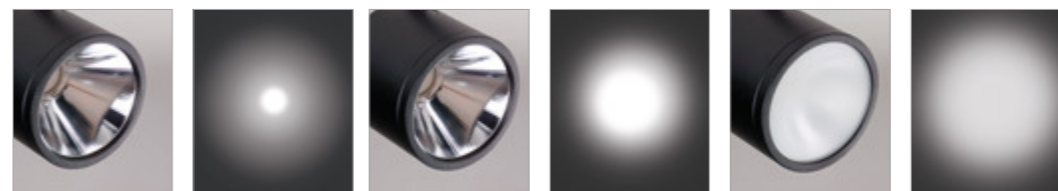

- /13**
Ottica fascio stretto per luce d'accento
Narrow beam optic for accent lighting
- /40**
Ottica fascio largo
Wide beam optic
- /ST**
Ottica fascio diffuso per illuminazione generale
Diffused light optic for general lighting

Drivers

Cod.	Drivers ON/OFF		DIMMABLE drivers				Casambi	LED emergency unit
	0147/COB 500mA	0149/COB 500mA	0141/DIM PUSH - 1...10V	0141/DALI DIM DALI	0145/DALI DIM DALI	0145 DIM		
6468	1-2	1	1-2	1-2	1-3	1-3	1	1-3
6469	1-2	1	1-2	1-2	1-3	1-3	1	1-3

Solo collegamento in serie - Only serial connection

Spots

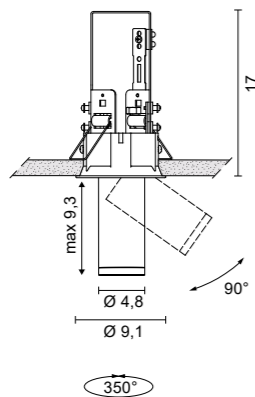

6328 Newton Spot recessed

- .01 Bianco - White
- .02 Nero - Black

Color temperature	Optics	LED light source	lm source	lm output
/W 4000K	/24 /38 /58	8,7W 17,5V 500mA	1466lm	1150lm
/W 4000K	/ST Satinato - Satin	8,7W 17,5V 500mA	1466lm	1099lm
/WW 3000K	/24 /38 /58	8,7W 17,5V 500mA	1424lm	1117lm
/WW 3000K	/ST Satinato - Satin	8,7W 17,5V 500mA	1424lm	1068lm
/XW 2700K	/24 /38 /58	8,7W 17,5V 500mA	1340lm	1051lm
/XW 2700K	/ST Satinato - Satin	8,7W 17,5V 500mA	1340lm	1005lm



0,80 Kg

8,6 cm



Esempio: /ST - Example: /ST

Accessori - Accessories



0267

Frangiluce
Louvres

- .01 Bianco - White
- .02 Nero - Black

0274

Schermo antiabbagliamento
Anti-glare screen

- .01 Bianco - White
- .02 Nero - Black

Ottiche Disponibili - Available Optics



/24
Ottica fascio stretto per luce d'accento
Narrow beam optic for accent lighting

/38
Ottica fascio medio
Medium beam optic

/58
Ottica fascio largo
Wide beam optic

/ST
Ottica fascio diffuso per illuminazione generale
Diffused light optic for general lighting

Drivers

Drivers ON/OFF	DIMMABLE drivers	Casambi	LED emergency unit
Cod. 0147/COB 500mA	0141/DIM PUSH - 1...10V	0145/CASA	0115/EM Inverter + Battery + LED indicator
0149/COB 500mA	0141/DALI DIM DALI		
6328 1-2	0145/DALI DIM DALI		
	0145 DIM		
	0734/DIM PHASE CUT		

Solo collegamento in serie - Only serial connection

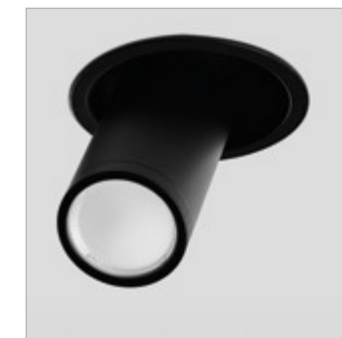
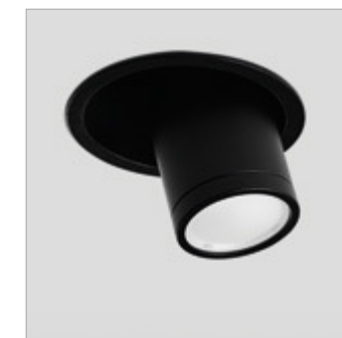
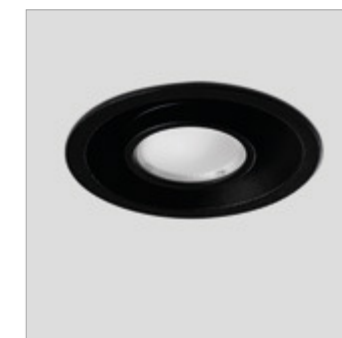

Spots

NEWTON SPOT EASY RECESSED 230V - GU10

6326 Newton Easy 230V - GU10

- .01 Bianco - White
- .02 Nero - Black
- .02.25 Snodo nero, corpo dorato satinato - Black articulated joint, satin golded body
- .02.32 Snodo nero, corpo nickel satinato - Black articulated joint, nickel mat body

Light sources

- 7W GU10 LED DIM (cod. 0104/...)
- 7W GU10 LED (cod. 0094/...)



0,80 Kg

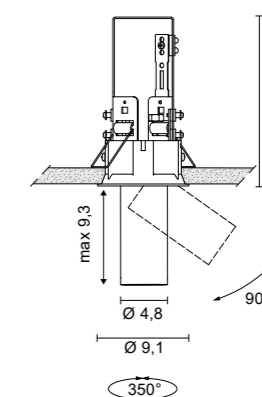

8,6 cm

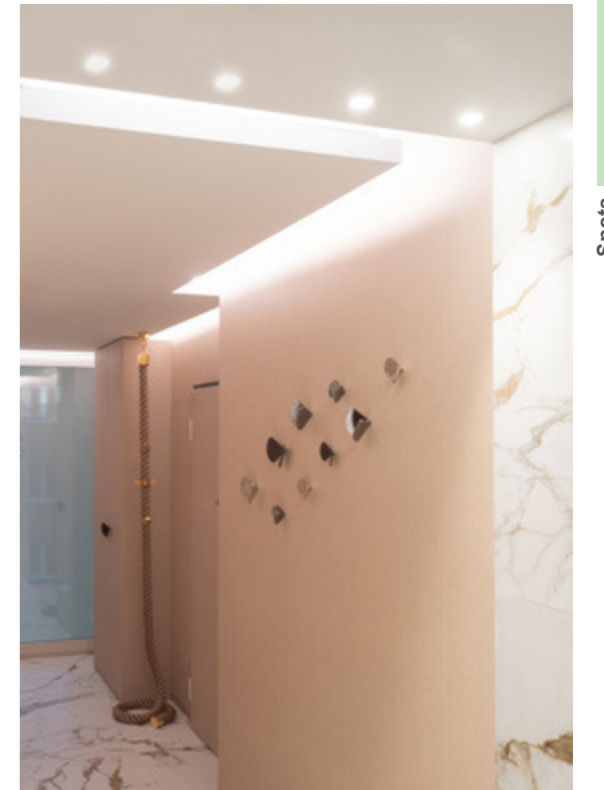

STAR

design: U.T. EGOLUCE

Faretti mini trim da incasso a luce d'accento o diffusa con sorgente COB LED integrata ad elevate prestazioni disponibili in 4 dimensioni.

FINITURE DISPONIBILI

- .01 bianco (RAL 9016 opaco)
- .02 nero (RAL 9005 opaco)
- .25 dorato satinato
- .31 cromato lucido
- .32 nichel satinato

CARATTERISTICHE DEL PRODOTTO:

- Dissipazione passiva
- Diverse ottiche disponibili
- Installabili con o senza casseforme a secondo del modello
- IP54 disponibile in alcuni modelli

I faretti Star sono disponibili con LED COB da 2700K (XW), 3000K (WW) e 4000K (W) con CRI>80 e riflettore con diverse aperture ottiche. La lente frontale, in vetro, può essere trasparente o satinata (/ST). A richiesta CRI>90.

La linea semplice si adatta a qualsiasi tipo di ambiente, dagli interni classici a quelli moderni.

Per funzionare richiede un apposito alimentatore da ordinare separatamente. Tra questi l'alimentatore 0136/15 ha dimensioni tali da consentire il passaggio nel foro incasso delle casseforme.

Sono disponibili anche alimentatori dimmerabili con controllo PUSH, 1...10V, DALI o a taglio di fase e unità di controllo per la luce d'emergenza.

Possibilità di funzionamento a 24V con art. 0226 (p. 370).

Recessed mini trim spotlights for accent or diffused light with integrated high performance COB LED source available in 4 sizes.

FINISHES AVAILABLE

- .01 white (RAL 9016 matt)
- .02 black (RAL 9005 matt).25 satin gold
- .31 bright chrome
- .32 satin nickel

PRODUCT FEATURES:

- Passive dissipation
- Different optics available
- Can be installed with or without formwork depending on the model
- IP54 available in some models

The spotlights Star are available with 2700K (XW), 3000K (WW) and 4000K (W) COB LEDs with CRI>80 and reflector with different optics beams. The front glass lens can be transparent or satin (/ST). On request CRI>90.

The simple line adapts to any type of environment, from classic to modern interiors.

To work, it requires a special driver to be ordered separately. Among these, the driver 0136/15 has dimensions such as to allow it to pass through the built-in hole of the formwork.

Dimmable drivers with PUSH, 1...10V, DALI or phase-cut control and control units for emergency lighting are also available.

Possibility of operation at 24V with art. 0226 (p. 370).

Spots encastrés mini trim pour lumière d'accentuation ou diffuse avec source LED COB haute performance intégrée disponible en 4 tailles.

FINITIONS DISPONIBLES

- .01 blanc (RAL 9016 mat)
- .02 noir (RAL 9005 mat)
- .25 or satiné
- .31 chrome brillant
- .32 nickel satiné

CARACTÉRISTIQUES DU PRODUIT:

- Dissipation passive
- Différentes optiques disponibles
- Peut être installé avec ou sans coffrage selon le modèle
- IP54 disponible sur certains modèles

Les projecteurs Star sont disponibles avec des LED COB 2700K (XW), 3000K (WW) et 4000K (W) avec CRI>80 et un réflecteur avec différentes ouvertures optiques. La lentille en verre avant peut être transparente ou satinée (/ST). Sur demande CRI>90.

La ligne simple s'adapte à tout type d'environnement, des intérieurs classiques aux intérieurs modernes.

Pour fonctionner, il nécessite une alimentation spéciale à commander séparément. Parmi ceux-ci, l'alimentateur 0136/15 a des dimensions telles qu'il lui permette de passer à travers le trou intégré des coffrages.

Des alimentations graduables avec commande PUSH, 1...10V, DALI ou à coupure de phase et des unités de commande pour l'éclairage de secours sont également disponibles.

Possibilité de fonctionnement en 24V avec art. 0226 (p. 370).

Focos empotrables de brida delgada para luz de acento o difusa con fuente LED COB integrada de alto rendimiento disponible en 4 tamaños.

ACABADOS DISPONIBLES

- .01 blanco (RAL 9016 mate)
- .02 negro (RAL 9005 mate)
- .25 oro satinado
- .31 cromo brillante
- .32 níquel satinado

CARACTERÍSTICAS DEL PRODUCTO:

- Dissipación pasiva
- Distintas ópticas disponibles
- Se puede instalar con o sin encofrado según el modelo
- IP54 disponible en algunos modelos

Los focos Star están disponibles con LED COB de 2700K (XW), 3000K (WW) y 4000K (W) con CRI>80 y reflector con diferentes aperturas ópticas. La lente de cristal frontal puede ser transparente o satinada (/ST). Bajo pedido CRI>90.

La línea simple se adapta a cualquier tipo de ambiente, desde interiores clásicos hasta modernos.

Para funcionar, requiere una fuente de alimentación especial que se debe pedir por separado. Entre estos, el alimentador 0136/15 tiene unas dimensiones que le permiten pasar por el hueco incorporado de los encofrados.

También están disponibles fuentes de alimentación regulables con PUSH, 1...10V, DALI o corte de fase y unidades de control para iluminación de emergencia.

Posibilidad de funcionamiento a 24V con arte 0226 (p. 370).

Mini-Einbaustrahler für Akzent- oder Streulicht mit integrierter Hochleistungs-COB-LED-Quelle, erhältlich in 4 Größen.

AUSFÜHRUNGEN VERFÜGBAR

- .01 weiß (RAL 9016 matt)
- .02 schwarz (RAL 9005 matt)
- .25 Satingold
- .31 Glanzchrom
- .32 satiniertes Nickel

PRODUKTEIGENSCHAFTEN:

- Passive Ableitung
- Verschiedene Optiken erhältlich
- Je nach Modell mit oder ohne Schalung montierbar
- IP54 bei einigen Modellen verfügbar

Die Strahler Star sind mit 2700K (XW), 3000K (WW) und 4000K (W) COB-LEDs mit CRI>80 und Reflektor mit unterschiedlichen Lichtkegeln erhältlich. Die vordere Glasscheibe kann transparent oder satiniert (/ST) sein. Auf Anfrage CRI>90.

Die einfache Linie passt sich jeder Art von Umgebung an, von klassischen bis zu modernen Innenräumen.

Für den Betrieb ist ein spezielles Netzteil erforderlich, das separat bestellt werden muss. Darunter ist der Beschicker 0136/15 so dimensioniert, dass er durch die eingebaute Öffnung der Schalung passt.

Ebenfalls erhältlich sind dimmbare Netzteile mit PUSH, 1...10V-, DALI- oder Phasenanschnittsteuer- und Steuergeräten für die Notbeleuchtung.

Möglichkeit des Betriebs bei 24V mit Kunst. 0226 (p. 370).

Встраиваемые мини-прожекторы для акцентного или рассеянного света со встроенным источником высокопроизводительного светодиода COB доступны в 4 размерах.

ДОСТУПНЫЕ ОТДЕЛКИ

- .01 белый (RAL 9016 матовый)
- .02 черный (RAL 9005, матовый)
- .25 атласное золото
- .31 яркий хром
- .32 сатинированный никель

ОСОБЕННОСТИ ПРОДУКТА:

- Пассивное рассеивание
- Доступна различная оптика
- Может быть установлен с опалубкой или без нее в зависимости от модели
- IP54 доступен в некоторых моделях

Прожекторы Star доступны со светодиодами COB 2700K (XW), 3000K (WW) и 4000K (W) с CRI>80 и отражателем с различными оптическими отверстиями. Передняя стеклянная линза может быть прозрачной или матовой (/ST). По запросу CRI>90.

Простая линия адаптируется к любому типу интерьера, от классического до современного интерьера.

Для работы требуется специальный блок питания, который заказывается отдельно. Среди них питатель 0136/15 имеет размеры, позволяющие проходить через встроенное отверстие опалубки.

Также доступны блоки питания с регулируемой яркостью, PUSH, 1...10 В, DALI или фазовой отсечкой, а также блоки управления для аварийного освещения.

Возможность работы на 24В с искусством. 0226 (p. 370).

Spots

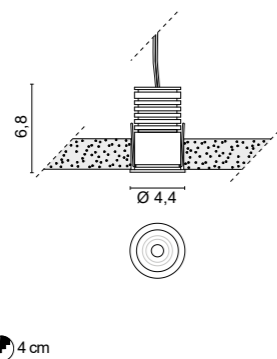

6690 Star 1

- .01 Bianco - White
- .02 Nero - Black
- .25 Dorato satinato - Golded satin
- .32 Nickel satinato - Nickel matt

Color temperature	Optics	LED light source	lm source	lm output
<i>/W</i> 4000K	<i>/18 /40 /60</i>	5,9W 17V 350mA	1060lm	880lm
<i>/W</i> 4000K	<i>/ST</i> Satinato - Satin	5,9W 17V 350mA	1060lm	816lm
<i>/WW</i> 3000K	<i>/18 /40 /60</i>	5,9W 17V 350mA	1030lm	855lm
<i>/WW</i> 3000K	<i>/ST</i> Satinato - Satin	5,9W 17V 350mA	1030lm	793lm
<i>/XW</i> 2700K	<i>/18 /40 /60</i>	5,9W 17V 350mA	969lm	804lm
<i>/XW</i> 2700K	<i>/ST</i> Satinato - Satin	5,9W 17V 350mA	969lm	746lm

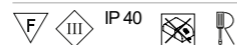

0,14 Kg

IP54 su richiesta. - IP54 upon request



STAR 2

Spots

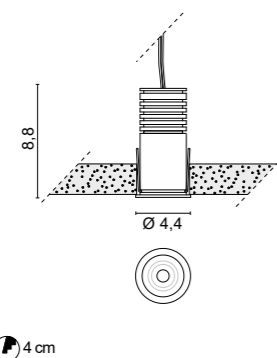

6691 Star 2

- .01 Bianco - White
- .02 Nero - Black
- .25 Dorato satinato - Golded satin
- .32 Nickel satinato - Nickel matt

Color temperature	Optics	LED light source	lm source	lm output
<i>/W</i> 4000K	<i>/18 /40 /60</i>	5,9W 17V 350mA	1060lm	880lm
<i>/W</i> 4000K	<i>/ST</i> Satinato - Satin	5,9W 17V 350mA	1060lm	816lm
<i>/WW</i> 3000K	<i>/18 /40 /60</i>	5,9W 17V 350mA	1030lm	855lm
<i>/WW</i> 3000K	<i>/ST</i> Satinato - Satin	5,9W 17V 350mA	1030lm	793lm
<i>/XW</i> 2700K	<i>/18 /40 /60</i>	5,9W 17V 350mA	969lm	804lm
<i>/XW</i> 2700K	<i>/ST</i> Satinato - Satin	5,9W 17V 350mA	969lm	746lm

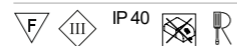

0,16 Kg

IP54 su richiesta. - IP54 upon request

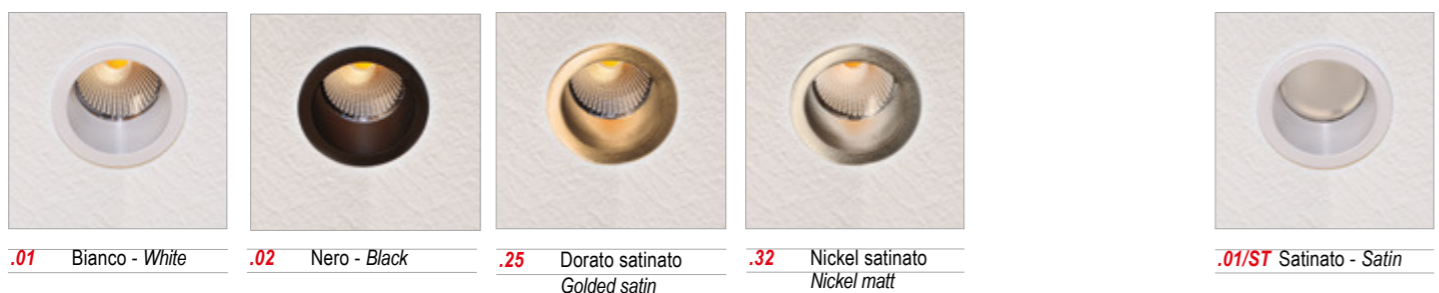

Drivers

Cod.	* Drivers ON/OFF			DIMMABLE drivers				Casambi	LED emergency unit
	0136/15	0125	0128	0141/DIM	0141/DALI	0145	0145/DALI		
	350mA	350mA	350mA	PUSH - 1...10V	DIM DALI	DIM	DIM DALI	PHASE CUT	
6690	1-2	1	1-2	1-2	1-2	1-3	1-3	1	0115/EM Inverter + Battery + LED indicator
6691	1-2	1	1-2	1-2	1-2	1-3	1-3	1	

Solo collegamento in serie - Only serial connection



Spots

*

I drivers 0136/15, 0125 e 0128 possono passare dal foro incasso del faretto. Il driver 0136/15 può essere inserito anche con cassaforma montata.

Drivers 0136/15, 0125 and 0128, can pass through the recessed hole of the spotlight. The driver 0136/15 can also be inserted with a mounted formwork.

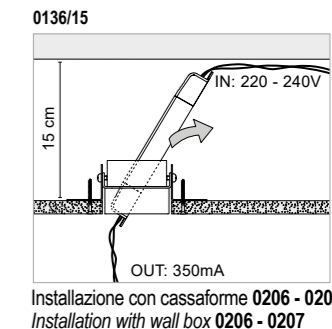
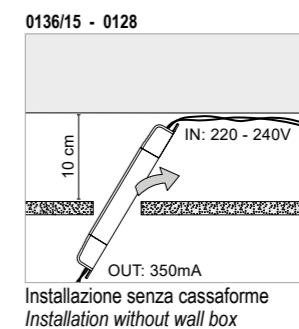
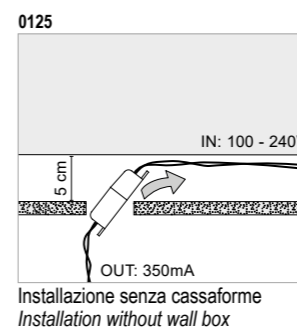

Accessori - Accessories

Installazione arretrata a scomparsa su cartongesso: - Trimless recessed installation in plasterboard:

- 0206 .01 Bianco - White .02 Nero - Black Cassaforma tonda per installazione in cartongesso a scomparsa - Round wall box for installation in plasterboard false ceiling
 - 0207 .01 Bianco - White .02 Nero - Black Cassaforma quadrata per installazione in cartongesso a scomparsa - Square wall box for installation in plasterboard false ceiling
- (schemi installazioni pag. 70) - (installation pg. 70)

Installazione su muratura: - Brick installation:

- 0225 Cassaforma per muratura - Recessed box for brick mounting
 - 0224/C Plaster kit preforato - Perforated plaster kit
- (schemi installazioni pag. 71) - (installation pg. 71)

Installazione in calcestruzzo: - Installation in concrete:

- 0223 Cassaforma per calcestruzzo - Recessed box for concrete mounting
 - 0224/C Plaster kit preforato - Perforated plaster kit
- (schemi installazioni p. 72) - (installation p. 72)

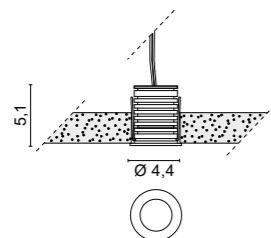

6692 Star IP

- .01** Bianco - White
- .02** Nero - Black
- .31** Cromato - Chromed

Color temperature	LED Light sources	lm source	lm output
/W 4000K	2,4W 16,3V 150mA	477lm	367lm
/WW 3000K	2,4W 16,3V 150mA	463lm	356lm
/XW 2700K	2,4W 16,3V 150mA	435lm	335lm



0,12 Kg

4 cm



.01 Bianco - White



.02 Nero - Black



.31 Cromato - Chromed



Drivers

Drivers ON/OFF

Cod.	0151/150
	150mA
6692	1-2

Solo collegamento in serie - Only serial connection

Accessori - Accessories

Installazione arretrata a scomparsa su cartongesso: - Trimless recessed installation in plasterboard:

- 0206** **.01** Bianco - White **.02** Nero - Black Cassaforma tonda per installazione in cartongesso a scomparsa - Round wall box for installation in plasterboard false ceiling
 - 0207** **.01** Bianco - White **.02** Nero - Black Cassaforma quadrata per installazione in cartongesso a scomparsa - Square wall box for installation in plasterboard false ceiling
- (schemi installazioni pag. 70) - (installation pg. 70)

Installazione su muratura: - Brick installation:

- 0225** Cassaforma per muratura - Recessed box for brick mounting
- 0224/C** Plaster kit perforato - Perforated plaster kit

(schemi installazioni pag. 71) - (installation pg. 71)

Installazione in calcestruzzo: - Installation in concrete:

- 0223** Cassaforma per calcestruzzo - Recessed box for concrete mounting
- 0224/C** Plaster kit perforato - Perforated plaster kit

(schemi installazioni p. 72) - (installation p. 72)

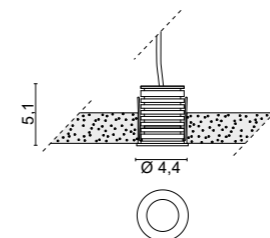

6693 Star RGB

- .01** Bianco - White
- .02** Nero - Black
- .31** Cromato - Chromed

Light sources

LED 3x250mA



0,14 Kg

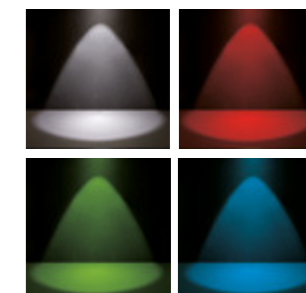

4 cm



.01 Bianco - White



.02 Nero - Black



.31 Cromato - Chromed

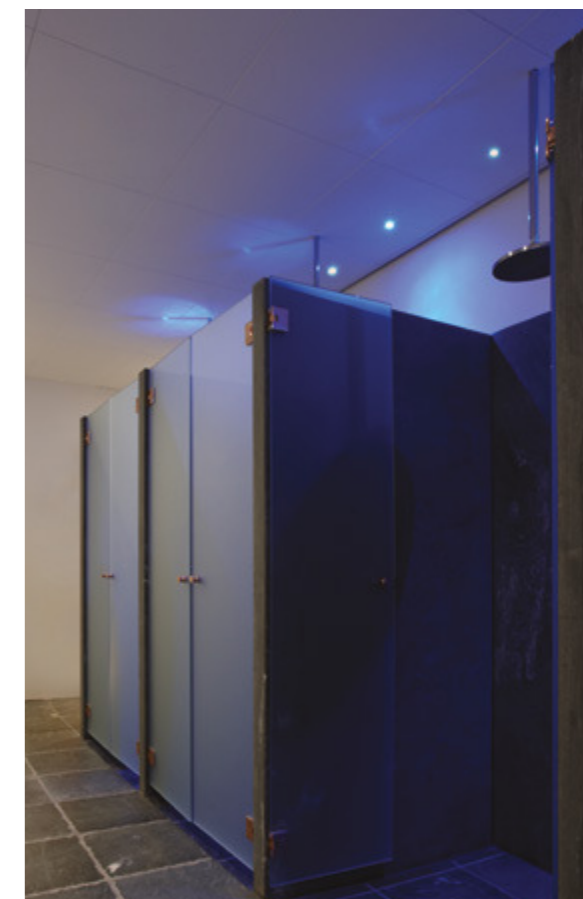

Drivers

Drivers RGB

0164	0167
120W	22W
IN:230V - OUT: 3x24V	

Driver RGB Casambi

0164/CASA
120W
IN:230V - OUT: 3x24V

Converter RGB

0168
IN:24V - OUT: 3x250 mA 1-5 Star RGB

0163	0165	0166
IR Sensor	IR Remote controller	Sinc Cable

Accessori - Accessories

Installazione arretrata a scomparsa su cartongesso: - Trimless recessed installation in plasterboard:

- 0206** **.01** Bianco - White **.02** Nero - Black Cassaforma tonda per installazione in cartongesso a scomparsa - Round wall box for installation in plasterboard false ceiling
 - 0207** **.01** Bianco - White **.02** Nero - Black Cassaforma quadrata per installazione in cartongesso a scomparsa - Square wall box for installation in plasterboard false ceiling
- (schemi installazioni pag. 70) - (installation pg. 70)

Installazione su muratura: - Brick installation:

- 0225** Cassaforma per muratura - Recessed box for brick mounting
- 0224/C** Plaster kit perforato - Perforated plaster kit

(schemi installazioni pag. 71) - (installation pg. 71)

Installazione in calcestruzzo: - Installation in concrete:

- 0223** Cassaforma per calcestruzzo - Recessed box for concrete mounting
- 0224/C** Plaster kit perforato - Perforated plaster kit

(schemi installazioni pag. 72) - (installation pg. 72)

Spots

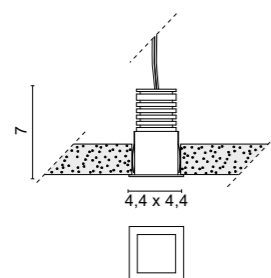

3,8 x 3,8 cm

6695 Star 3

- .01 Bianco - White
- .02 Nero - Black
- .25 Dorato satinato - Golded satin
- .32 Nickel satinato - Nickel matt

	Color temperature	Optics	LED light source	lm source	lm output
/W	4000K	Satinato - Satin	5,9W 17V 350mA	1060lm	816lm
/WW	3000K	Satinato - Satin	5,9W 17V 350mA	1030lm	793lm
/XW	2700K	Satinato - Satin	5,9W 17V 350mA	969lm	746lm

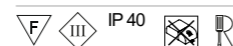

0,15 Kg

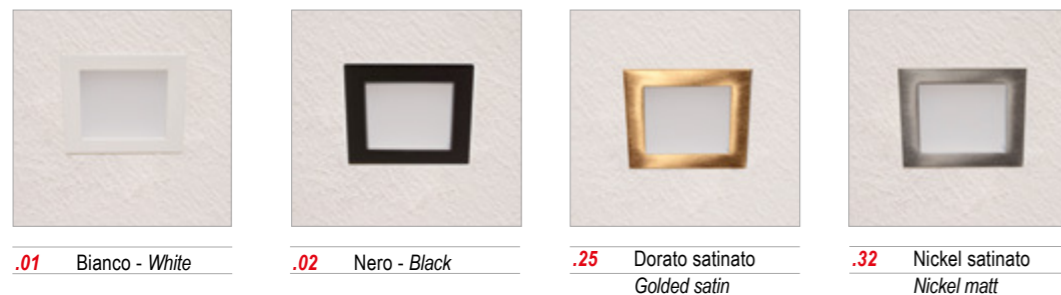

STAR 4

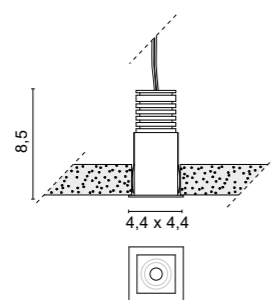

3,8 x 3,8 cm

6696 Star 4

- .01 Bianco - White
- .02 Nero - Black
- .25 Dorato satinato - Golded satin
- .32 Nickel satinato - Nickel matt

	Color temperature	Optics	LED light source	lm source	lm output
/W	4000K	/18 /40 /60	5,9W 17V 350mA	1060lm	880lm
/W	4000K	/ST Satinato - Satin	5,9W 17V 350mA	1060lm	816lm
/WW	3000K	/18 /40 /60	5,9W 17V 350mA	1030lm	855lm
/WW	3000K	/ST Satinato - Satin	5,9W 17V 350mA	1030lm	793lm
/XW	2700K	/18 /40 /60	5,9W 17V 350mA	969lm	804lm
/XW	2700K	/ST Satinato - Satin	5,9W 17V 350mA	969lm	746lm

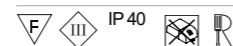

0,18 Kg



Drivers

* Drivers ON/OFF

Cod.	0136/15	0125	0128
	350mA	350mA	350mA
6695	1-2	1	1-2
6696	1-2	1	1-2

DIMMABLE drivers

0141/DIM	0141/DALI	0145	0145/DALI	0733/DIM
PUSH - 1...10V	DIM DALI	DIM	DIM DALI	PHASE CUT
1-2	1-2	1-3	1-3	1
1-2	1-2	1-3	1-3	1

Casambi

0145/CASA	1-3
	1-3

LED emergency unit

0115/EM Inverter + Battery + LED indicator	1
	1

Solo collegamento in serie - Only serial connection



Spots

*

I drivers 0136/15, 0125 e 0128 possono passare dal foro incasso del faretto.

Drivers 0136/15, 0125 and 0128, can pass through the recessed hole of the spotlight.

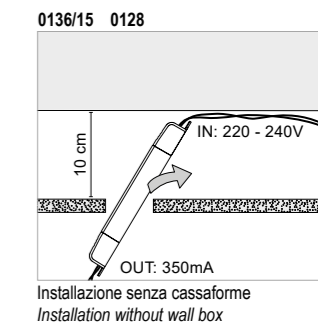
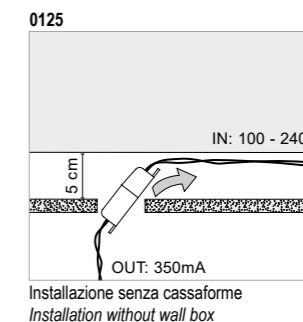

Accessori - Accessories

Installazione in calcestruzzo: - Installation in concrete:

0223	Cassaforma per calcestruzzo - Recessed box for concrete mounting
0224/Q	Plaster kit perforato - Perforated plaster kit

(schemi installazioni pag. 72) - (installation pg. 72)

Installazione su muratura: - Brick installation:

0225	Cassaforma per muratura - Recessed box for brick mounting
0224/Q	Plaster kit perforato - Perforated plaster kit

(schemi installazioni pag. 71) - (installation pg. 71)

STAR MEDIUM 1

Spots

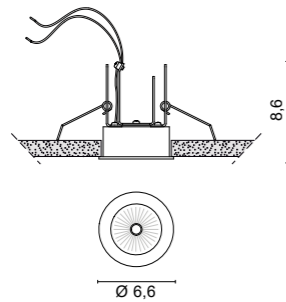
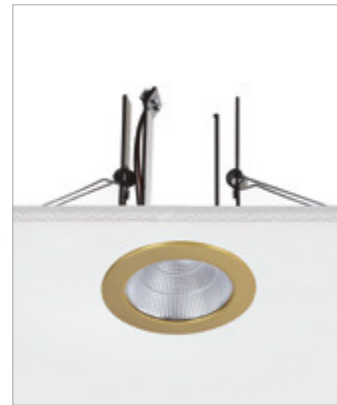

6710 Star Medium 1

- .01 Bianco - White
- .02 Nero - Black
- .25 Dorato satinato - Golded satin
- .32 Nickel satinato - Nickel matt

Color temperature	Optics	LED light source	lm source	lm output
/W 4000K	/24 /40 /60	8,7W 17,5V 500mA	1466lm	1150lm
/W 4000K	/ST Satinato - Satin	8,7W 17,5V 500mA	1466lm	1099lm
/WW 3000K	/24 /40 /60	8,7W 17,5V 500mA	1424lm	1117lm
/WW 3000K	/ST Satinato - Satin	8,7W 17,5V 500mA	1424lm	1068lm
/XW 2700K	/24 /40 /60	8,7W 17,5V 500mA	1340lm	1051lm
/XW 2700K	/ST Satinato - Satin	8,7W 17,5V 500mA	1340lm	1005lm



0,20 Kg

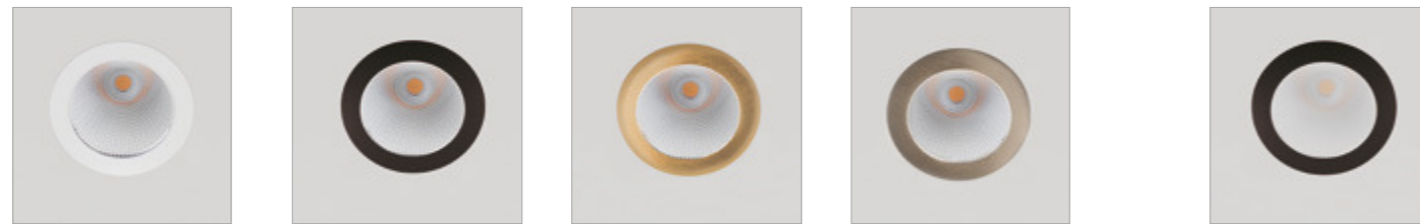

- .01 Bianco - White
- .02 Nero - Black
- .25 Dorato satinato
Golded satin
- .32 Nickel satinato
Nickel matt
- .02/ST Satinato - Satin

Parte a vista IP54 su richiesta *Visible part IP54 on request*

Accessori - Accessories

Installazione su muratura - Brick installation:

- 0200 Cassaforma per muratura - Recessed box for brick mounting
- 0282/C Plaster kit perforato - Perforated plaster kit

(schemi installazioni pag. 71) - (installation pg. 71)

Drivers

Cod.	Drivers ON/OFF		DIMMABLE drivers					Casambi 0145/CASA	LED emergency unit 0115/EM Inverter + Battery + LED indicator
	0147/COB 500mA	0149/COB 500mA	0141/DIM PUSH - 1...10V	0141/DALI DIM DALI	0145/DALI DIM DALI	0145 DIM	0734/DIM PHASE CUT		
6710	1-2	1	1-2	1-2	1-3	1-3	1	1-3	1

Solo collegamento in serie - Only serial connection

STAR MEDIUM 2

Spots

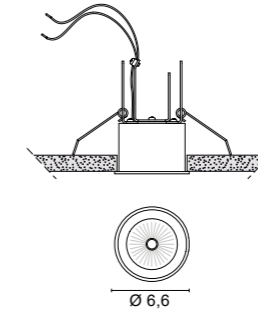

6711 Star Medium 2

- .01 Bianco - White
- .02 Nero - Black

Color temperature	Optics	LED light source	lm source	lm output
/W 4000K	/24 /40 /60	8,7W 17,5V 500mA	1466lm	1150lm
/W 4000K	/ST Satinato - Satin	8,7W 17,5V 500mA	1466lm	1099lm
/WW 3000K	/24 /40 /60	8,7W 17,5V 500mA	1424lm	1117lm
/WW 3000K	/ST Satinato - Satin	8,7W 17,5V 500mA	1424lm	1068lm
/XW 2700K	/24 /40 /60	8,7W 17,5V 500mA	1340lm	1051lm
/XW 2700K	/ST Satinato - Satin	8,7W 17,5V 500mA	1340lm	1005lm



0,25 Kg

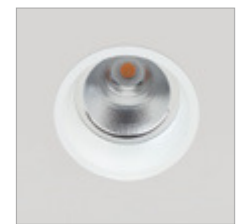

- .01 Bianco - White



- .02 Nero - Black



- .01/ST Satinato - Satin

Parte a vista IP54 a richiesta.
Visible part IP54 on request.

Drivers

Cod.	Drivers ON/OFF		DIMMABLE drivers					Casambi 0145/CASA	LED emergency unit 0115/EM Inverter + Battery + LED indicator
	0147/COB 500mA	0149/COB 500mA	0141/DIM PUSH - 1...10V	0141/DALI DIM DALI	0145/DALI DIM DALI	0145 DIM	0734/DIM PHASE CUT		
6711	1-2	1	1-2	1-2	1-3	1-3	1	1-3	1

Solo collegamento in serie - Only serial connection

STAR MEDIUM 3

Spots

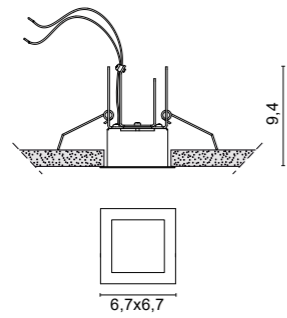

6713 Star Medium 3

- .01 Bianco - White
- .02 Nero - Black
- .25 Dorato satinato - Golded satin
- .32 Nickel satinato - Nickel matt

Color temperature	Optics	LED light source	lm source	lm output
/W 4000K	Satinato - Satin	8,7W 17,5V 500mA	1466lm	1099lm
/WW 3000K	Satinato - Satin	8,7W 17,5V 500mA	1424lm	1068lm
/XW 2700K	Satinato - Satin	8,7W 17,5V 500mA	1340lm	1005lm

IP 40 0,20 Kg

5,9 x 5,9 cm



.01 Bianco - White

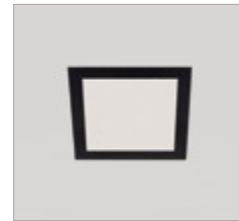

.02 Nero - Black

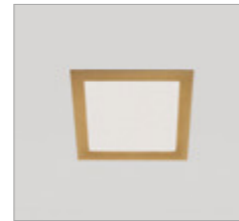

.25 Dorato satinato
Golded satin

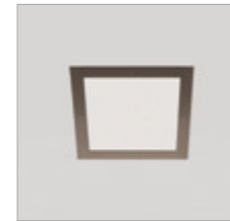

.32 Nickel satinato
Nickel matt



Accessori - Accessories

Installazione su muratura - Brick installation:

0200 Cassaforma per muratura - Recessed box for brick mounting

0283/Q Plaster kit perforato - Perforated plaster kit

(schemi installazioni pag. 71) - (installation pg. 71)

Drivers

Cod.	Drivers ON/OFF		DIMMABLE drivers					Casambi	LED emergency unit
	0147/COB 500mA	0149/COB 500mA	0141/DIM PUSH - 1...10V	0141/DALI DIM DALI	0145/DALI DIM DALI	0145 DIM	0734/DIM PHASE CUT		
6713	1-2	1	1-2	1-2	1-3	1-3	1	1-3	1

Solo collegamento in serie - Only serial connection

STAR MEDIUM 4

Spots

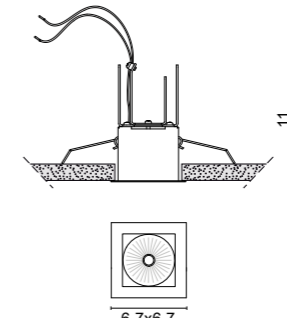

6714 Star Medium 4

- .01 Bianco - White
- .02 Nero - Black

Color temperature	Optics	LED light source	lm source	lm output
/W 4000K	/24 /40 /60	8,7W 17,5V 500mA	1466lm	1150lm
/W 4000K	/ST Satinato - Satin	8,7W 17,5V 500mA	1466lm	1099lm
/WW 3000K	/24 /40 /60	8,7W 17,5V 500mA	1424lm	1117lm
/WW 3000K	/ST Satinato - Satin	8,7W 17,5V 500mA	1424lm	1068lm
/XW 2700K	/24 /40 /60	8,7W 17,5V 500mA	1340lm	1051lm
/XW 2700K	/ST Satinato - Satin	8,7W 17,5V 500mA	1340lm	1005lm

IP 40 0,25 Kg

5,9 x 5,9 cm

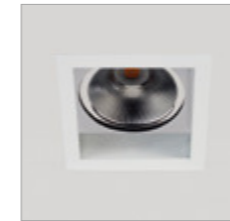

.01 Bianco - White

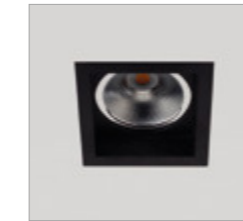

.02 Nero - Black



.01/ST Satinato - Satin

Drivers

Cod.	Drivers ON/OFF		DIMMABLE drivers					Casambi	LED emergency unit
	0147/COB 500mA	0149/COB 500mA	0141/DIM PUSH - 1...10V	0141/DALI DIM DALI	0145/DALI DIM DALI	0145 DIM	0734/DIM PHASE CUT		
6714	1-2	1	1-2	1-2	1-3	1-3	1	1-3	1

Solo collegamento in serie - Only serial connection

Spots

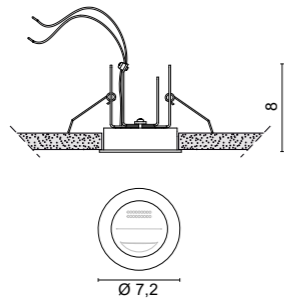

6712 Star Medium Asymmetric

- .01** Bianco - White
- .02** Nero - Black
- .25** Dorato satinato - Golded satin
- .32** Nickel satinato - Nickel matt

	Color temperature	LED light source	lm source	lm output
/W	4000K	8,7W 17,5V 500m	1466lm	1150lm
/WW	3000K	8,7W 17,5V 500m	1424lm	1117lm
/XW	2700K	8,7W 17,5V 500m	1340lm	1051lm

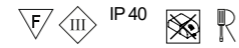

0,20 Kg

6,5 cm

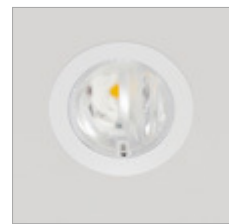

.01 Bianco - White

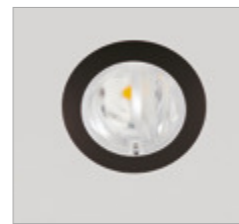

.02 Nero - Black

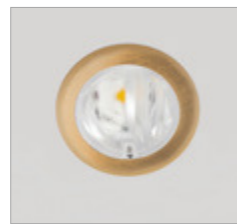

.25 Dorato satinato
Golded satin

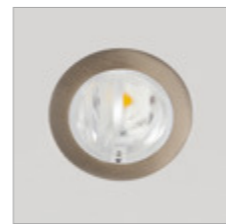

.32 Nickel satinato
Nickel matt

Esempio di installazione - Installation example

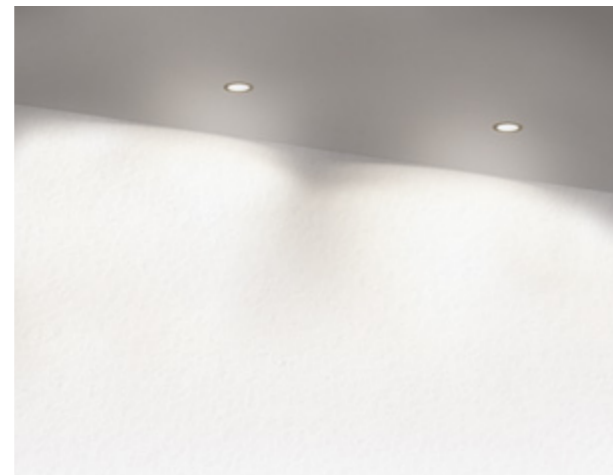
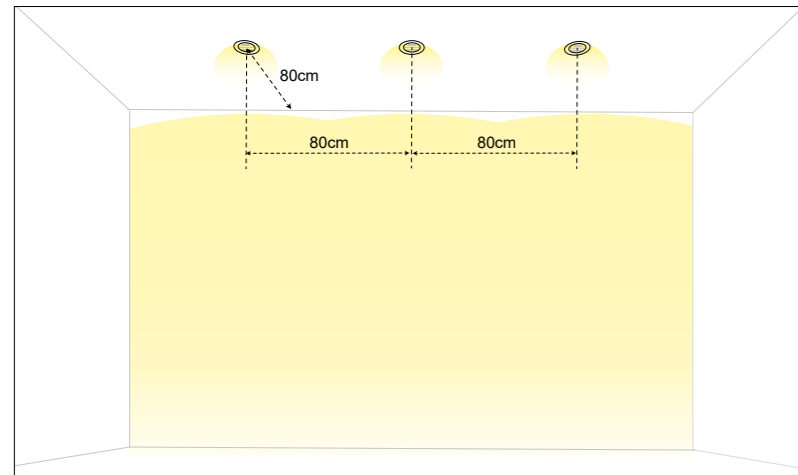

Per illuminare uniformemente una parete posizionare i faretti secondo lo schema.
To uniformly illuminate a wall, position the spotlights according to the diagram.

Drivers

Drivers ON/OFF			DIMMABLE drivers				Casambi	LED emergency unit	
Cod.	0147/COB	0149/COB	0141/DIM	0141/DALI	0145/DALI	0145	0734/DIM	0145/CASA	0115/EM
	500mA	500mA	PUSH - 1...10V	DIM DALI	DIM DALI	DIM	PHASE CUT		Inverter + Battery + LED indicator
6712	1-2	1	1-2	1-2	1-3	1-3	1	1-3	1

Solo collegamento in serie - Only serial connection

Spots



STAR ADJUSTABLE 1

Spots

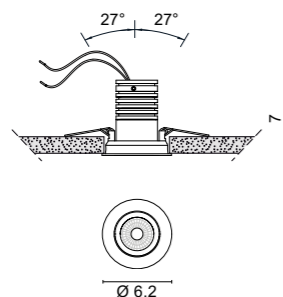

5,7 cm

6715 Star Adjustable 1

- .01 Bianco - White
- .02 Nero - Black

Color temperature	Optics	LED light source	lm source	lm output
<i>/W</i> 4000K	<i>/18 /40 /60</i>	5,9W 17V 350mA	1060lm	880lm
<i>/W</i> 4000K	<i>/ST</i> Satinato - Satin	5,9W 17V 350mA	1060lm	816lm
<i>/WW</i> 3000K	<i>/18 /40 /60</i>	5,9W 17V 350mA	1030lm	855lm
<i>/WW</i> 3000K	<i>/ST</i> Satinato - Satin	5,9W 17V 350mA	1030lm	793lm
<i>/XW</i> 2700K	<i>/18 /40 /60</i>	5,9W 17V 350mA	969lm	804lm
<i>/XW</i> 2700K	<i>/ST</i> Satinato - Satin	5,9W 17V 350mA	969lm	746lm

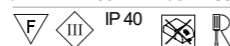

0,16 Kg



.01 Bianco - White



.02 Nero - Black

STAR ADJUSTABLE 2

Spots

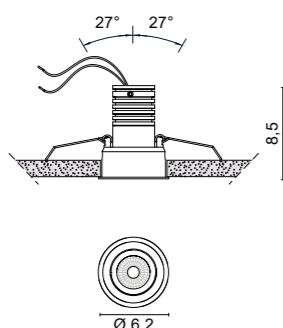

5,7 cm

6716 Star Adjustable 2

- .01 Bianco - White
- .02 Nero - Black

Color temperature	Optics	LED light source	lm source	lm output
<i>/W</i> 4000K	<i>/18 /40 /60</i>	5,9W 17V 350mA	1060lm	880lm
<i>/W</i> 4000K	<i>/ST</i> Satinato - Satin	5,9W 17V 350mA	1060lm	816lm
<i>/WW</i> 3000K	<i>/18 /40 /60</i>	5,9W 17V 350mA	1030lm	855lm
<i>/WW</i> 3000K	<i>/ST</i> Satinato - Satin	5,9W 17V 350mA	1030lm	793lm
<i>/XW</i> 2700K	<i>/18 /40 /60</i>	5,9W 17V 350mA	969lm	804lm
<i>/XW</i> 2700K	<i>/ST</i> Satinato - Satin	5,9W 17V 350mA	969lm	746lm

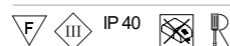

0,16 Kg



.01 Bianco - White



.02 Nero - Black

Accessori - Accessories

Installazione su muratura - Brick installation:

0200 Cassaforma per muratura - Recessed box for brick mounting

0281/O Plaster kit preforato - Perforated plaster kit

(schemi installazioni pag. 71) - (installation pg. 71)

Drivers

* Drivers ON/OFF

Cod.	0136/15	0125	0128
	350mA	350mA	350mA
6715	1-2	1	1-2
6716	1-2	1	1-2

DIMMABLE drivers

0141/DIM	0141/DALI	0145	0145/DALI	0733/DIM
PUSH - 1...10V	DIM DALI	DIM	DIM DALI	PHASE CUT
1-2	1-2	1-3	1-3	1
1-2	1-2	1-3	1-3	1

Casambi

0145/CASA
1-3
1-3

LED emergency unit

0115/EM	Inverter + Battery + LED indicator
1	
1	

Solo collegamento in serie - Only serial connection

STAR ADJUSTABLE



Spots

Spots

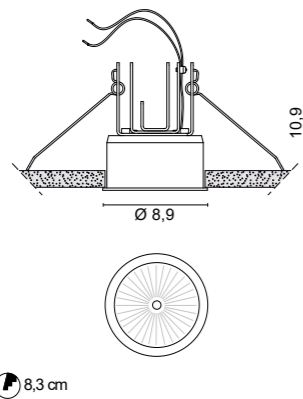

6705 Star Maxi 1

- .01 Bianco - White
- .02 Nero - Black
- .25 Dorato satinato - Golded satin
- .32 Nickel satinato - Nickel matt

	Color temperature	Optics	LED light source	lm source	lm output
/W	4000K	/12 /40	18,8W 37,5V 500mA	2733lm	2213lm
/W	4000K	/ST Satinato - Satin	18,8W 37,5V 500mA	2733lm	2104lm
/WW	3000K	/12 /40	18,8W 37,5V 500mA	2655lm	2150lm
/WW	3000K	/ST Satinato - Satin	18,8W 37,5V 500mA	2655lm	2044lm
/XW	2700K	/12 /40	18,8W 37,5V 500mA	2499lm	2024lm
/XW	2700K	/ST Satinato - Satin	18,8W 37,5V 500mA	2499lm	1924lm

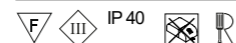

0,40 Kg

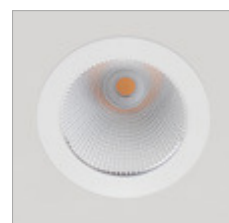

.01 Bianco - White

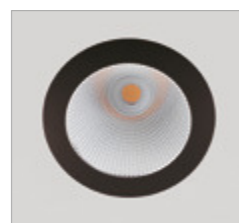

.02 Nero - Black

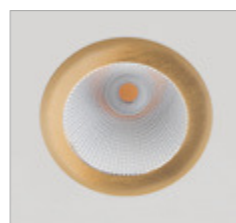

.25 Dorato satinato
Golded satin



.32 Nickel satinato
Nickel matt

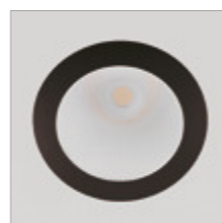

.02/ST Satinato - Satin

Parte a vista IP54 su richiesta. Visible part IP54 on request.

STAR MAXI 2

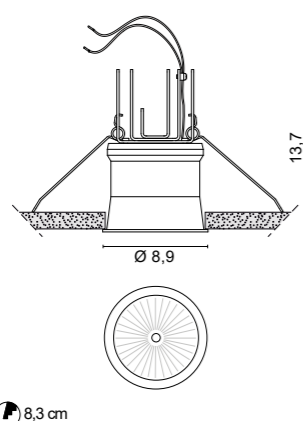

6706 Star Maxi 2

- .01 Bianco - White
- .02 Nero - Black

	Color temperature	Optics	LED light source	lm source	lm output
/W	4000K	/12 /40	18,8W 37,5V 500mA	2733lm	2213lm
/W	4000K	/ST Satinato - Satin	18,8W 37,5V 500mA	2733lm	2104lm
/WW	3000K	/12 /40	18,8W 37,5V 500mA	2655lm	2150lm
/WW	3000K	/ST Satinato - Satin	18,8W 37,5V 500mA	2655lm	2044lm
/XW	2700K	/12 /40	18,8W 37,5V 500mA	2499lm	2024lm
/XW	2700K	/ST Satinato - Satin	18,8W 37,5V 500mA	2499lm	1924lm



0,40 Kg



.01 Bianco - White

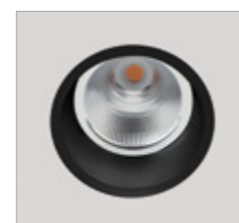

.02 Nero - Black



.01/ST Satinato - Satin

Parte a vista IP54 su richiesta. Visible part IP54 on request.

Drivers

Cod.	Drivers ON/OFF	DIMMABLE drivers				Casambi	LED emergency unit
	0147/COB 500mA	0141/DIM PUSH - 1...10V	0141/DALI DIM DALI	0145 DIM	0145/DALI DIM DALI	0145/CASA	0115/EM Inverter + Battery + LED indicator
6705	1	1	1	1	1	1	1
6706	1	1	1	1	1	1	1

Solo collegamento in serie - Only serial connection



Spots



Spots

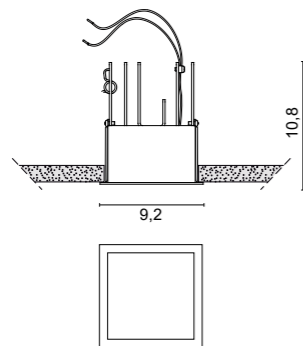

8,5x8,5 cm

6707 Star Maxi 3

- .01 Bianco - White
- .02 Nero - Black
- .25 Dorato satinato - Golded satin
- .32 Nickel satinato - Nickel matt

	Color temperature	Optics	LED light source	lm source	lm output
/W	4000K	Satinato - Satin	18,8W 37,5V 500mA	2733lm	2104lm
/WW	3000K	Satinato - Satin	18,8W 37,5V 500mA	2655lm	2044lm
/XW	2700K	Satinato - Satin	18,8W 37,5V 500mA	2499lm	1924lm

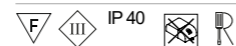

0,40 Kg



.01 Bianco - White

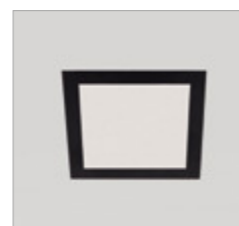

.02 Nero - Black

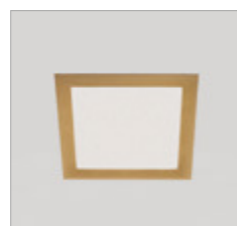

.25 Dorato satinato
Golded satin

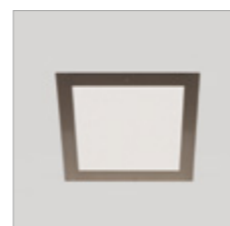

.32 Nickel satinato
Nickel matt

STAR MAXI 4

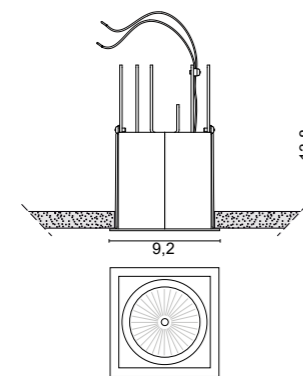

8,5x8,5 cm

6708 Star Maxi 4

- .01 Bianco - White
- .02 Nero - Black

	Color temperature	Optics	LED light source	lm source	lm output
/W	4000K	/12 /40	18,8W 37,5V 500mA	2733lm	2213lm
/W	4000K	/ST Satinato - Satin	18,8W 37,5V 500mA	2733lm	2104lm
/WW	3000K	/12 /40	18,8W 37,5V 500mA	2655lm	2150lm
/WW	3000K	/ST Satinato - Satin	18,8W 37,5V 500mA	2655lm	2044lm
/XW	2700K	/12 /40	18,8W 37,5V 500mA	2499lm	2024lm
/XW	2700K	/ST Satinato - Satin	18,8W 37,5V 500mA	2499lm	1924lm

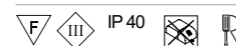

0,50 Kg

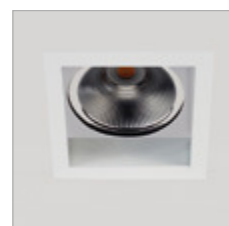

.01 Bianco - White

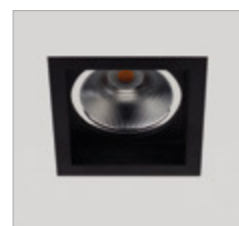

.02 Nero - Black

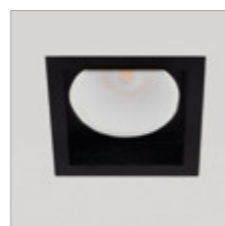

.02/ST Satinato - Satin

Drivers

Drivers ON/OFF	
Cod.	
	0147/COB 500mA
6707	1
6708	1

DIMMABLE drivers				
	0141/DIM	0141/DALI	0145	0145/DALI
	PUSH - 1...10V	DIM DALI	DIM	DIM DALI
	1	1	1	1
	1	1	1	1

Casambi	
	0145/CASA
	1
	1

LED emergency unit	
	0115/EM
	Inverter + Battery + LED indicator
	1
	1

Solo collegamento in serie - Only serial connection



Spots



Accessori - Accessories



0206
Cassaforma tonda per installazione in cartongesso a scomparsa
Round wall box for installation in plasterboard false ceiling
.01 Bianco - White
.02 Nero - Black
⌀ 6,7 cm



0207
Cassaforma quadrata per installazione in cartongesso a scomparsa
Square wall box for installation in plasterboard false ceiling
.01 Bianco - White
.02 Nero - Black
5,5 x 5,5 cm

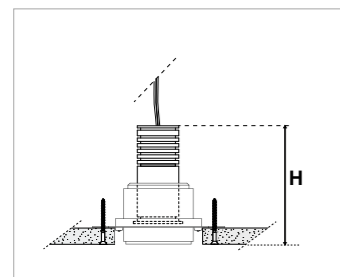
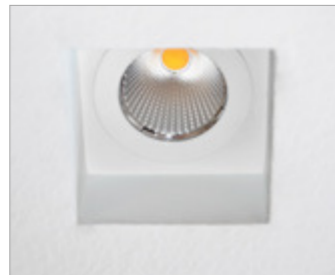

0206+
6690 Star 1 - H = 10cm
6691 Star 2 - H = 12cm
6692 Star IP - H = 8cm
6693 Star RGB - H = 8cm
0207+
6690 Star 1 - H = 10cm
6691 Star 2 - H = 12cm
6692 Star IP - H = 8cm
6693 Star RGB - H = 8cm

Schema di montaggio: - *Assembly scheme:*

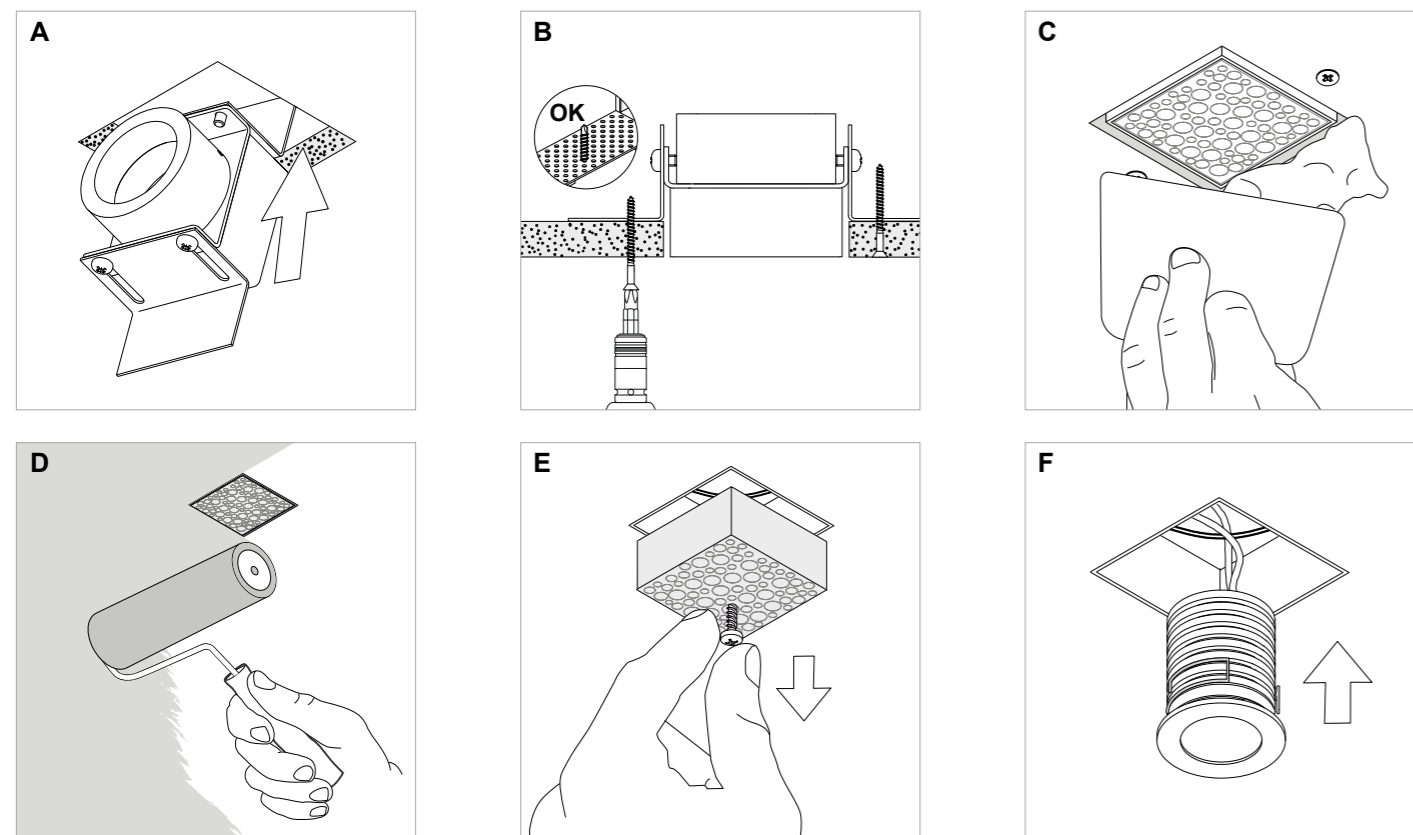

Accessori - Accessories



0225
Cassaforma per muratura
Recessed box for brick mounting
9,5 x 6,5 - h 9,5 cm



0224/C
Plaster kit preforato
Perforated plaster kit
6690 Star 1
6691 Star 2
6692 Star IP
6693 Star RGB



0224/Q
Plaster kit preforato
Perforated plaster kit
6695 Star 3
6696 Star 4



0200
Cassaforma per muratura
Recessed box for brick mounting
15,5 x 12 - h 9,5 cm



0281/O
Plaster kit preforato
Perforated plaster kit
6715 Star adjustable
6716 Star adjustable



0282/C
Plaster kit preforato
Perforated plaster kit
6710 Star medium



0283/Q
Plaster kit preforato
Perforated plaster kit
6713 Star medium

Schema di montaggio: - *Assembly scheme:*

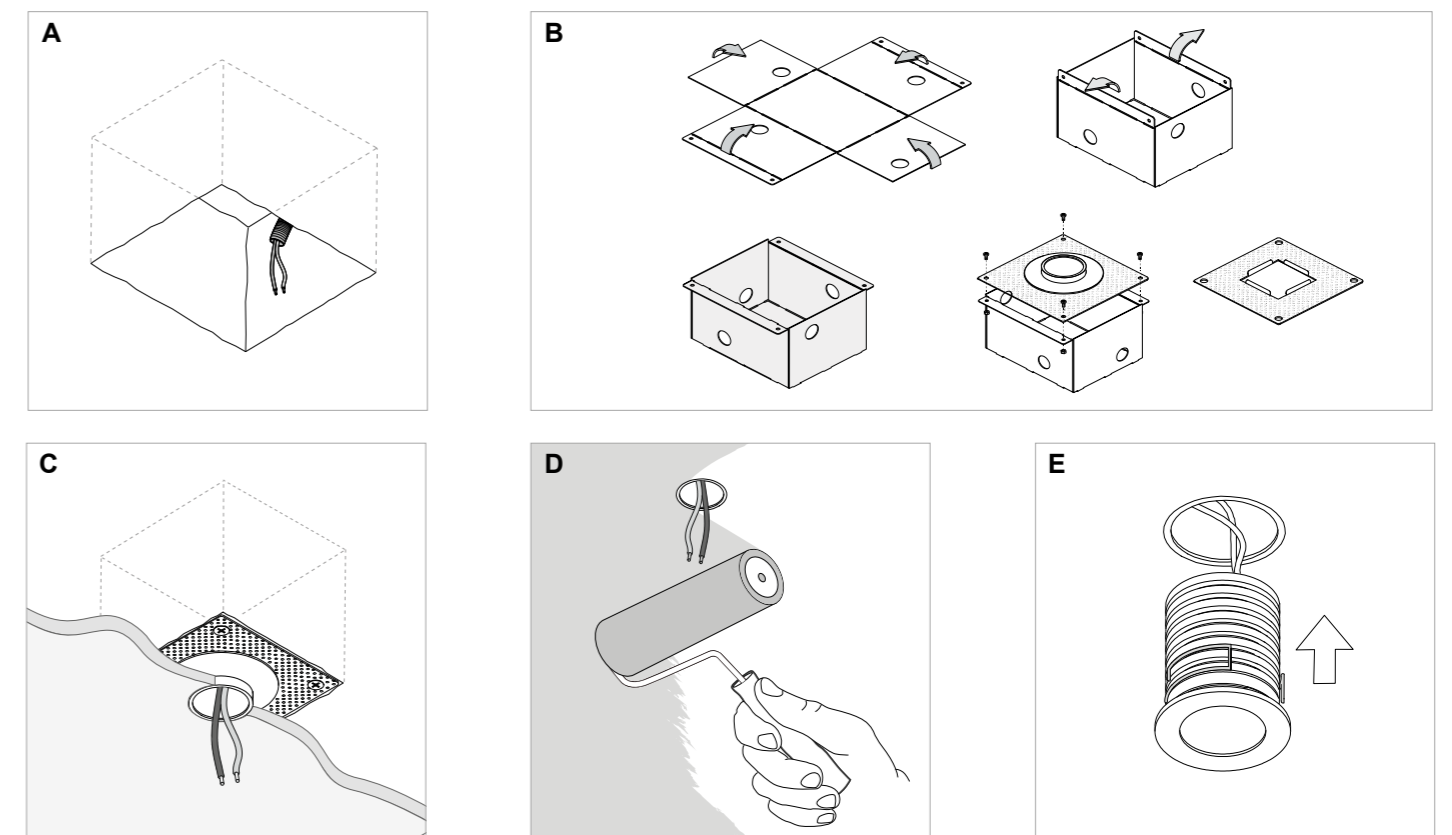

Accessori - Accessories

Spots



0223
Cassaforma per calcestruzzo
Recessed box for concrete mounting
9 x 9 - h 9cm



0224/C
Plaster kit perforato
Perforated plaster kit
6690 Star 1
6691 Star 2
6692 Star IP
6693 Star RGB



0224/Q
Plaster kit perforato
Perforated plaster kit
6695 Star 3
6696 Star 4



Schema di montaggio: - *Assembly scheme:*

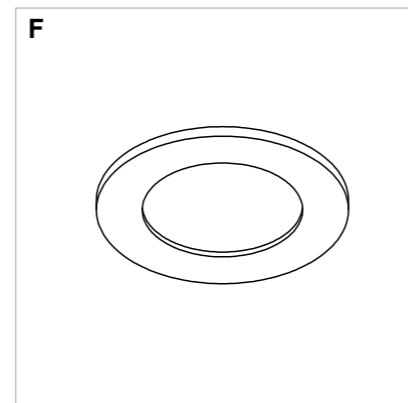
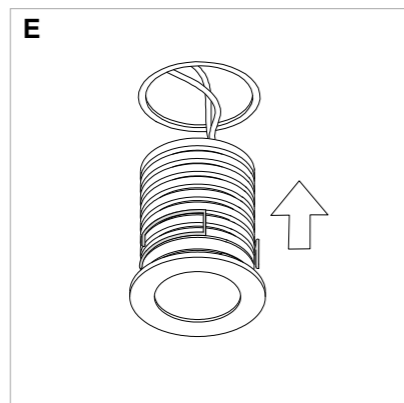
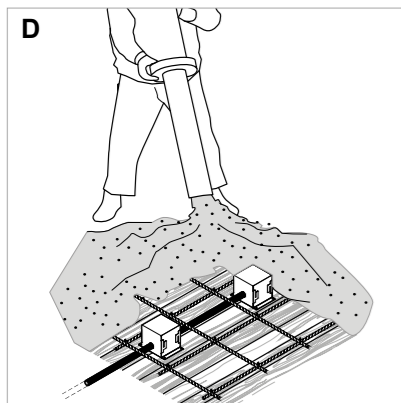
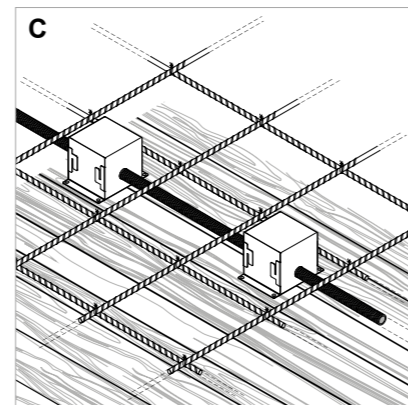
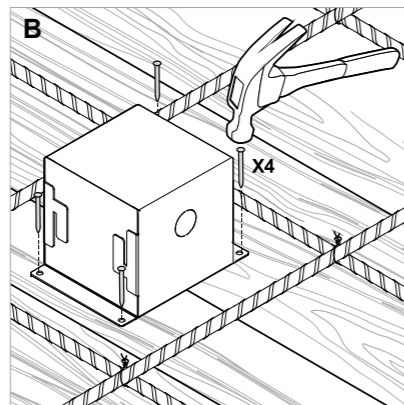
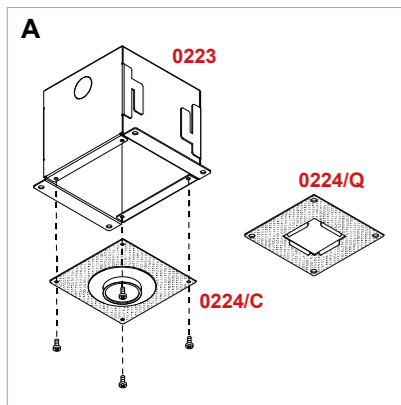

Spots





DISSY design: U.T. EGOLUCE

Faretti "mini trim" da incasso IP54 per controsoffitti in cartongesso con struttura in alluminio, LED COB integrato ed arretrato, disponibile con flangia tonda o quadrata e con la lente frontale in vetro trasparente (TR) o satinata (ST). Le dimensioni del LED ed il posizionamento arretrato rispetto al riflettore riducono l'abbagliamento diretto garantendo un cono di luce uniforme e confortevole.

FINITURE DISPONIBILI:

- .01 bianco
- .02 nero
- .21 dorato lucido
- .31 cromato
- .32 nickel satinato

DISSY è fornito con LED COB a luce bianca 2700K (XW), 3000K (WW) e 4000K (W), con CRI>80 e con riflettore con apertura ottica di 38°. Su richiesta sono disponibili fasci di apertura ottica da 24° o 58° e COB LED con CRI>90.

Il funzionamento prevede l'utilizzo di un alimentatore da ordinare separatamente. Sono disponibili anche alimentatori dimmerabili per un controllo PUSH, 1...10V o DALI e unità per il funzionamento in emergenza.

Possibilità di funzionamento a 24V con art. 0226 (p. 370).

IP54 recessed "mini trim" spotlights for plasterboard false ceilings with aluminum structure, integrated and set back COB LED, available with round or square flange and with front lens in transparent (TR) or satin (ST) glass. The size of the LED and the set back from the reflector reduce direct glare ensuring a uniform and comfortable light cone.

AVAILABLE FINISHES:

- .01 white
- .02 black
- .21 shiny gold
- .31 chrome
- .32 satin nickel

DISSY is supplied with 2700K (XW), 3000K (WW) and 4000K (W) white light COB LEDs, with CRI>80 and with reflector with 38° beam optic. On request, beams optic of 24° or 58° and COB LEDs with CRI>90 are available.

Operation involves the use of a driver to be ordered separately. Dimmable driver for PUSH, 1...10V or DALI control and units for emergency operation are also available.

Possibility of operation at 24V with art. 0226 (p. 370).

Spots encastrés IP54 "mini trim" pour faux plafonds en plaques de plâtre avec structure en aluminium, LED COB intégrées et reculées, disponibles avec collerette ronde ou carrée et avec lentille frontale en verre transparent (TR) ou satiné (ST). La taille de la LED et le retrait du réflecteur réduisent l'éblouissement direct assurant un cône de lumière uniforme et confortable.

FINITIONS DISPONIBLES:

- .01 blanc
- .02 noir
- .21 or brillant
- .31 chromé
- .32 nickel satiné

DISSY est fourni avec des LED COB à lumière blanche de 2700K (XW), 3000K (WW) et 4000K (W), avec CRI>80 et avec réflecteur à ouverture optique de 38°. Sur demande, des faisceaux d'ouverture optique de 24° ou 58° et des LED COB avec CRI>90 sont disponibles.

Le fonctionnement implique l'utilisation d'une alimentation à commander séparément. Des alimentations graduables pour le contrôle PUSH, 1...10V ou DALI et des unités pour le fonctionnement d'urgence sont également disponibles.

Possibilité de fonctionnement en 24V avec art. 0226 (p. 370).



Proyectoros de empotrar "mini trim" IP54 para falsos techos de cartón yeso con estructura de aluminio, LED COB integrados y retranqueados, disponibles con brida redonda o cuadrada y con lente frontal en cristal transparente (TR) o satinado (ST). El tamaño del LED y el retranqueo del reflector reducen el deslumbramiento directo asegurando un cono de luz uniforme y confortable.

ACABADOS DISPONIBLES:

- .01 blanco
- .02 negro
- .21 oro brillante
- .31 cromado
- .32 níquel satinado

DISSY se suministra con LEDs COB de luz blanca de 2700K (XW), 3000K (WW) y 4000K (W), con CRI>80 y con reflector con apertura óptica de 38°. Bajo pedido están disponibles haces de apertura óptica de 24° o 58° y LED COB con CRI>90.

El funcionamiento implica el uso de una fuente de alimentación que se pedirá por separado. También están disponibles alimentación regulables para control PUSH, 1...10V o DALI y unidades para operación de emergencia.

Posibilidad de funcionamiento a 24V con arte 0226 (p. 370).

"Mini Trim" Einbaustrahler IP54 für Zwischendecken aus Gipskarton mit Aluminiumstruktur, integrierte und zurückgesetzte COB-LED, erhältlich mit rundem oder quadratischem Flansch und mit Frontlinse aus transparentem (TR) oder satiniertem (ST) Glas. Die Größe der LED und der Abstand zum Reflektor reduzieren die direkte Blendung und sorgen für einen gleichmäßigen und angenehmen Lichtkegel.

VERFÜGBARE AUSFÜHRUNGEN:

- .01 weiß
- .02 schwarz
- .21 glänzendes Gold
- .31 Chrom
- .32 satiniertes Nickel

DISSY wird mit 2700K (XW), 3000K (WW) und 4000K (W) Weißlicht-COB-LEDs, mit CRI>80 und mit Reflektor mit 38° optischer Öffnung geliefert. Auf Anfrage sind optische Aperturstrahlen von 24° oder 58° und COB-LEDs mit CRI>90 erhältlich.

Der Betrieb erfolgt über ein separat zu bestellendes Netzteil. Dimmbare Netzteil für PUSH, 1...10V oder DALI Steuerung und Geräte für den Notbetrieb sind ebenfalls erhältlich.

Möglichkeit des Betriebs bei 24V mit Kunst. 0226 (p. 370).

Встраиваемые прожекторы IP54 с «мини-отделкой» для подвесных потолков из гипсокартона с алюминиевой конструкцией, встроенным и установленным сзади светодиодом COB, доступны с круглым или квадратным фланцем и с передней линзой из прозрачного (TR) или матированного (ST) стекла. Размер светодиода и удаленность от отражателя уменьшают прямые блики, обеспечивая равномерный и удобный световой конус.

ДОСТУПНЫЕ ОТДЕЛКИ:

- .01 белый
- .02 черный
- .21 блестящее золото
- .31 хром
- .32 матированный никель

DISSY поставляется с COB-светодиодами белого света 2700K (XW), 3000K (WW) и 4000K (W), с индексом цветопередачи >80 и отражателем с оптическим отверстием 38°. По запросу доступны лучи с оптической апертурой 24° или 58° и светодиоды COB с CRI>90.

Эксплуатация предполагает использование блока питания, который заказывается отдельно. Также доступны диммируемые питания для управления PUSH, 1...10 В или DALI, а также устройства для аварийного режима.

Возможность работы на 24В с искусством. 0226 (p. 370).

Spots

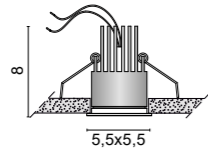

5 cm

6409 Dissy quadro

- .01** Bianco - White
- .02** Nero - Black
- .21** Dorato lucido - Shiny golded
- .31** Cromato - Chromed
- .32** Nickel satinato - Nickel mat

Color temperature	LED light source	lm source	lm output
/W 4000K	8,7W 17,5V 500m	1466lm	1150lm
/W/ST 4000K Satinato - Satin	8,7W 17,5V 500m	1466lm	1099lm
/WW 3000K	8,7W 17,5V 500m	1424lm	1117lm
/WW/ST 3000K Satinato - Satin	8,7W 17,5V 500m	1424lm	1068lm
/XW 2700K	8,7W 17,5V 500m	1340lm	1051lm
/XW/ST 2700K Satinato - Satin	8,7W 17,5V 500m	1340lm	1005lm

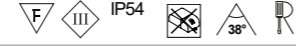

0,20 Kg

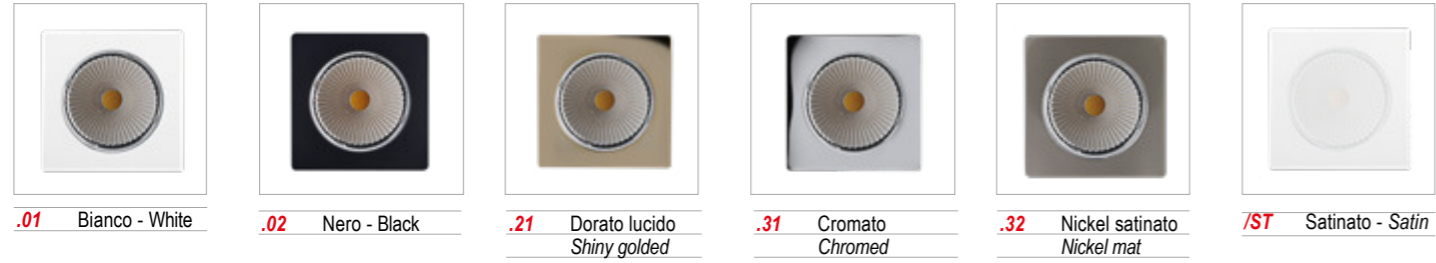

Spots

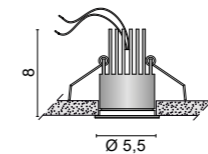

5 cm

6410 Dissy tondo

- .01** Bianco - White
- .02** Nero - Black
- .21** Dorato lucido - Shiny golded
- .31** Cromato - Chromed
- .32** Nickel satinato - Nickel mat

Color temperature	LED light source	lm source	lm output
/W 4000K	8,7W 17,5V 500m	1466lm	1150lm
/W/ST 4000K Satinato - Satin	8,7W 17,5V 500m	1466lm	1099lm
/WW 3000K	8,7W 17,5V 500m	1424lm	1117lm
/WW/ST 3000K Satinato - Satin	8,7W 17,5V 500m	1424lm	1068lm
/XW 2700K	8,7W 17,5V 500m	1340lm	1051lm
/XW/ST 2700K Satinato - Satin	8,7W 17,5V 500m	1340lm	1005lm



0,20 Kg



Drivers

Drivers ON/OFF		DIMMABLE drivers					Casambi	LED emergency unit	
Cod.	0147/COB 500mA	0149/COB 500mA	0141/DIM PUSH - 1...10V	0141/DALI DIM DALI	0145/DALI DIM DALI	0145 DIM	0734/DIM PHASE CUT	0145/CASA	0115/EM Inverter + Battery + LED indicator
6409	1-2	1	1-2	1-2	1-3	1-3	1	1-3	1

Solo collegamento in serie - Only serial connection

Drivers

Drivers ON/OFF		DIMMABLE drivers					Casambi	LED emergency unit	
Cod.	0147/COB 500mA	0149/COB 500mA	0141/DIM PUSH - 1...10V	0141/DALI DIM DALI	0145/DALI DIM DALI	0145 DIM	0734/DIM PHASE CUT	0145/CASA	0115/EM Inverter + Battery + LED indicator
6410	1-2	1	1-2	1-2	1-3	1-3	1	1-3	1

Solo collegamento in serie - Only serial connection

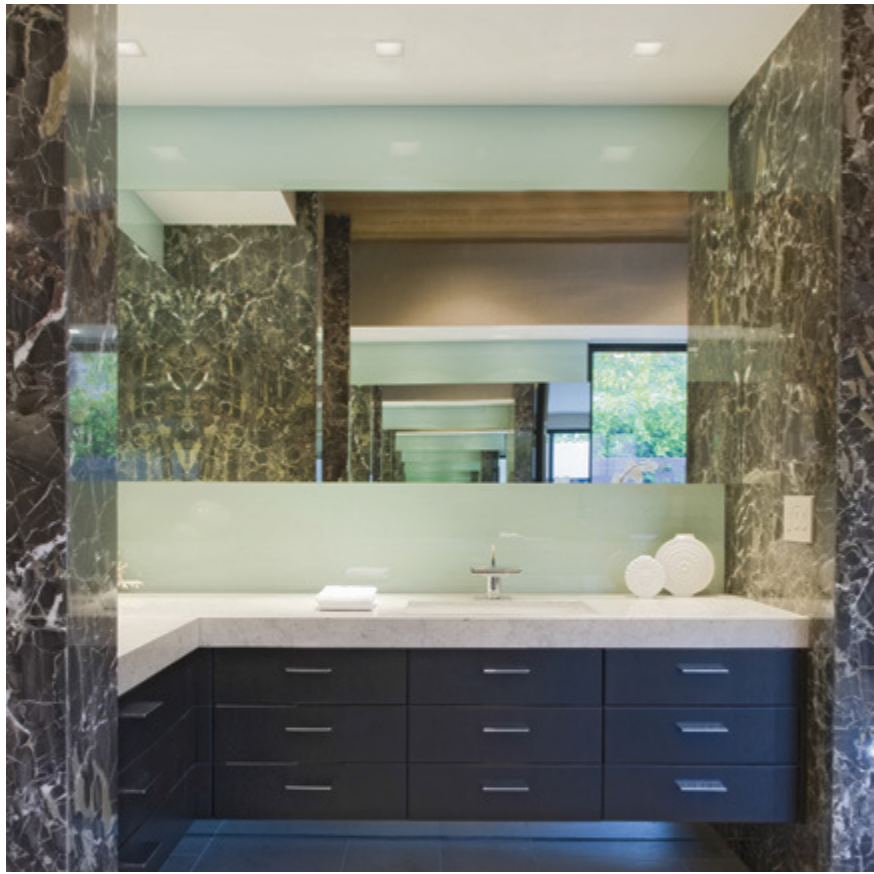

Spots

EASY design: U.T. EGOLUCE

Faretti da incasso "mini trim" per controsoffitti in cartongesso con corpo in metallo verniciato bianco opaco, cornice di ridottissime dimensioni tonda o quadrata, con ottica arretrata e predisposti per consentire l'utilizzo di varie sorgenti luminose. Luce d'accento o diffusa grazie allo schermo diffusore in metacrilato satinato (Art. 0289.01) da ordinare separatamente.

Il posizionamento della sorgente di luce, arretrata all'interno del corpo del faretto, riduce l'abbagliamento diretto pur garantendo il fascino e la funzionalità della luce d'accento.

L'installazione prevede il fissaggio del corpo in soffitti di cartongesso mediante un sistema di molle a filo e la piccola cornice quadra consente un'installazione senza costose operazioni di stuccatura, rasatura e verniciatura. La componentistica elettrica è inserita successivamente ed è facilmente rimovibile per la manutenzione. Il risultato finale prevede la completa integrazione del corpo luce con l'architettura senza la presenza di sporgenze o cornici esterne.

SORGENTI LUMINOSE:

- GU5,3 LED
- GU10 LED
- Modulo LED COB
- Modulo LED COB IP54
- Modulo 24V art. 0107/24V/W, /WW, /XW (p. 394)

I moduli LED COB sono disponibili con temperatura di colore di 2700K (XW), 3000K (WW), 4000K (W) con CRI>90 e con aperture ottiche di 24°, 40° e 60°.

Il funzionamento prevede l'utilizzo di un alimentatore da ordinare separatamente. Sono disponibili anche alimentatori dimmerabili per un controllo PUSH, 1...10V o DALI e unità per il funzionamento in emergenza.

Possibilità di funzionamento a 24V con art. 0226 (p. 370).

"Mini trim" recessed spotlights for plasterboard false ceilings with matt white painted metal body, very small round or square frame, with recessed optics and set up to allow the use of various light sources. Accent or diffused light thanks to the satin methacrylate diffuser screen (Art. 0289.01) to be ordered separately. The positioning of the light source, set back inside the body of the spotlight, reduces direct glare while guaranteeing the charm and functionality of the accent light.

The installation involves fixing the body in plasterboard ceilings using a system of wire springs and the small square frame allows installation without expensive grouting, smoothing and painting operations. The electrical components are inserted later and can be easily removed for maintenance. The final result provides for the complete integration of the light body with the architecture without the presence of external protrusions or frames.

LIGHT SOURCES:

- GU5,3 LED
- GU10 LED
- COB LED module
- IP54 COB LED module
- 24V LED modules art. 0107/24V/W, /WW, /XW (p. 394)

The COB LED modules are available with color temperatures of 2700K (XW), 3000K (WW), 4000K (W) with CRI>90 and with optical apertures of 24°, 40° and 60°.

Operation involves the use of a driver to be ordered separately. Dimmable driver for PUSH, 1...10V or DALI control and units for emergency operation are also available.

Possibility of operation at 24V with art. 0226 (p. 370).

Spots encastrés « mini trim » pour faux plafonds en plaques de plâtre avec corps en métal peint en blanc mat, très petit cadre rond ou carré, avec optique encastrée et configuré pour permettre l'utilisation de différentes sources lumineuses. Lumière d'accentuation ou diffuse grâce à l'écran diffuseur en méthacrylate satiné (Art. 0289.01) à commander séparément.

Le positionnement de la source lumineuse, en retrait à l'intérieur du corps du projecteur, réduit l'éblouissement direct tout en garantissant le charme et la fonctionnalité de la lumière d'accentuation.

L'installation consiste à fixer le corps dans des plafonds en plaques de plâtre à l'aide d'un système de ressorts métalliques et le petit cadre carré permet une installation sans opérations coûteuses de rejointoiement, de lissage et de peinture. Les composants électriques sont insérés plus tard et peuvent être facilement retirés pour l'entretien. Le résultat final prévoit l'intégration complète du corps léger avec l'architecture sans la présence des protubérances ou des armatures externes.

SOURCES LUMINEUSES:

- GU5,3 LED
- GU10 LED
- Module LED COB
- Module LED COB IP54
- Modules LED 24V art. 0107/24V/W, /WW, /XW (p. 394)

Les modules LED COB sont disponibles avec des températures de couleur de 2700K (XW), 3000K (WW), 4000K (W) avec CRI>90 et avec des ouvertures optiques de 24°, 40° et 60°.

Le fonctionnement implique l'utilisation d'une alimentation à commander séparément. Des alimentations graduables pour le contrôle PUSH, 1...10V ou DALI et des unités pour le fonctionnement d'urgence sont également disponibles.

Possibilité de fonctionnement en 24V avec art. 0226 (p. 370).

Proyectores de empotrar "mini trim" para falsos techos de cartón yeso con cuerpo de metal pintado blanco mate, marco redondo o cuadrado muy pequeño, con óptica de empotrar y preparados para permitir el uso de varias fuentes de luz. Luz de acento o difusa gracias a la pantalla difusora de metacrilato satinado (Art. 0289.01) a pedir por separado.

El posicionamiento de la fuente de luz, retranqueada en el interior del cuerpo del proyector, reduce el deslumbramiento directo al mismo tiempo que garantiza el encanto y la funcionalidad de la luz de acento.

La instalación consiste en fijar el cuerpo en techos de cartón yeso mediante un sistema de muelles de alambre y el pequeño marco cuadrado permite su instalación sin costosas operaciones de rejuntado, alisado y pintado. Los componentes eléctricos se insertan más tarde y se pueden quitar fácilmente para su mantenimiento. El resultado final prevé la completa integración del cuerpo de luz con la arquitectura sin la presencia de salientes o marcos externos.

FUENTES DE LUZ:

- GU5,3 LED
- GU10 LED
- Módulo LED COB
- Módulo LED COB IP54
- Módulos LED 24V art. 0107/24V/W, /WW, /XW (p. 394)

Los módulos LED COB están disponibles con temperaturas de color de 2700K (XW), 3000K (WW), 4000K (W) con CRI>90 y con aperturas ópticas de 24°, 40° y 60°.

El funcionamiento implica el uso de una fuente de alimentación que se pedirá por separado. También están disponibles alimentación regulables para control PUSH, 1...10V o DALI y unidades para operación de emergencia.

Posibilidad de funcionamiento a 24V con arte 0226 (p. 370).



Spots

"Mini trim" Einbaustrahler für abgehängte Decken aus Gipskarton mit mattweiß lackiertem Metallkörper, sehr kleinem rundem oder quadratischem Rahmen, mit zurückgesetzter Optik und so eingerichtet, dass verschiedene Lichtquellen verwendet werden können. Akzentuiertes oder diffuses Licht dank des separat zu bestellenden Diffusorschirms aus satiniertem Methacrylat (Art. 0289.01).

Die zurückversetzte Positionierung des Leuchtmittels im Inneren des Strahlerkörpers reduziert die Direktblendung und garantiert gleichzeitig den Charme und die Funktionalität des Akzentlichts.

Die Installation beinhaltet die Befestigung des Körpers in Gipskartondecken mit einem System von Drahtfedern und der kleine quadratische Rahmen ermöglicht eine Installation ohne teure Verfugungs-, Glättungs- und Lackierarbeiten. Die elektrischen Komponenten werden nachträglich eingesetzt und können zur Wartung einfach entnommen werden. Das Endergebnis sieht die vollständige Integration des Lichtkörpers in die Architektur vor, ohne dass äußere Vorsprünge oder Rahmen vorhanden sind.

LICHTQUELLEN:

- GU5,3 LED
- GU10 LED
- COB-LED-Modul
- IP54 COB-LED-Modul
- 24V-LED-Module art. 0107/24V/W, /WW, /XW (p. 394)

Die COB-LED-Module sind mit Farbtemperaturen von 2700K (XW), 3000K (WW), 4000K (W) mit CRI>90 und mit optischen Aperturen von 24°, 40° und 60° erhältlich. Der Betrieb erfolgt über ein separat zu bestellendes Netzteil. Dimmbare Netzteil für PUSH, 1...10V oder DALI Steuerung und Geräte für den Notbetrieb sind ebenfalls erhältlich.

Möglichkeit des Betriebs bei 24V mit Kunst. 0226 (p. 370).

Встраиваемые прожекторы «Mini trim» для подвесных потолков из гипсокартона с металлическим корпусом, окрашенным в белый матовый цвет, с очень маленькой круглой или квадратной рамкой, с утопленной оптикой и возможностью использования различных источников света. Акцентный или рассеянный свет благодаря рассеивателю из матированного метакрилата (арт. 0289.01), который заказывается отдельно. Расположение источника света внутри корпуса прожектора уменьшает прямые блики, гарантируя очарование и функциональность акцентного света.

Установка включает в себя крепление корпуса к гипсокартонному потолку с помощью системы проволочных пружин, а небольшая квадратная рама позволяет выполнять установку без дорогостоящих операций по затирке, выравниванию и покраске. Электрические компоненты вставляются позже и могут быть легко удалены для обслуживания. Конечный результат обеспечивает полную интеграцию светового корпуса с архитектурой без наличия внешних выступов или рамок.

ИСТОЧНИКИ СВЕТА:

- GU5,3 LED
- GU10 LED
- Светодиодный модуль COB
- Светодиодный модуль COB IP54 с использованием
- Светодиодные модули 24В art. 0107/24V/W, /WW, /XW (p. 394)

Светодиодные модули COB доступны с цветовой температурой 2700K (XW), 3000K (WW), 4000K (W) с CRI>90 и с оптическими апертурами 24°, 40° и 60°. Эксплуатация предполагает использование блока питания, который заказывается отдельно. Также доступны диммируемые питания для управления PUSH, 1...10 В или DALI, а также устройства для аварийного режима.

Возможность работы на 24В с искусством. 0226 (p. 370).

Spots

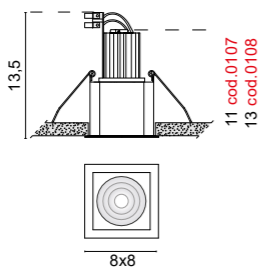

6431 Easy Quadro
 .01 Bianco - White
 F III 0,20 Kg

6431 + COB LED CRI>90

Drivers

Cod. LED	Drivers ON/OFF			DIMMABLE drivers					Casambi	LED emergency unit	
	0125 350mA	0147/COB 500mA	0149/COB 500mA	0141/DIM PUSH - 1...10V	0141/DALI DIM DALI	0145/DALI DIM DALI	0145 DIM	0733/DIM PHASE CUT			0734/DIM PHASE CUT
0107 - COB LED	1	NO	NO	1-2	1-2	1-3	1-3	1	NO	1-3	1
0108 - COB LED	1	1-2	1	1-2	1-2	1-3	1-3	NO	1	1-3	1

Solo collegamento in serie - Only serial connection

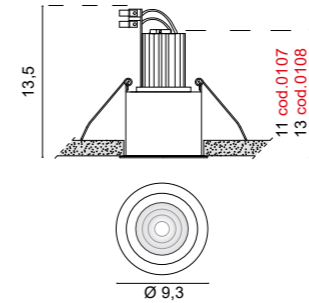

6441 Easy Tondo
 .01 Bianco - White
 F III 0,40 Kg

6441 + COB LED CRI>90

Color temperature	Optics	COB LED light source	lm source	lm output
0107/W	4000K /24 /40 /60 /ST	5,9W 17V 350mA	885lm	695lm
0107/WW	3000K /24 /40 /60 /ST	5,9W 17V 350mA	836lm	657lm
0107/XW	2700K /24 /40 /60 /ST	5,9W 17V 350mA	800lm	629lm
0108/W	4000K /24 /40 /60 /ST	8,7W 17,5V 500mA	1223lm	957lm
0108/WW	3000K /24 /40 /60 /ST	8,7W 17,5V 500mA	1156lm	905lm
0108/XW	2700K /24 /40 /60 /ST	8,7W 17,5V 500mA	1106lm	865lm
0108/W/IP	4000K /24 /38 /58	IP54 8,7W 17,5V 500mA	1223lm	957lm
0108/WW/IP	3000K /24 /38 /58	IP54 8,7W 17,5V 500mA	1156lm	905lm
0108/XW/IP	2700K /24 /38 /58	IP54 8,7W 17,5V 500mA	1106lm	865lm

Drivers

Cod. LED	Drivers ON/OFF			DIMMABLE drivers					Casambi	LED emergency unit	
	0125 350mA	0147/COB 500mA	0149/COB 500mA	0141/DIM PUSH - 1...10V	0141/DALI DIM DALI	0145/DALI DIM DALI	0145 DIM	0733/DIM PHASE CUT			0734/DIM PHASE CUT
0107 - COB LED	1	NO	NO	1-2	1-2	1-3	1-3	1	NO	1-3	1
0108 - COB LED	1	1-2	1	1-2	1-2	1-3	1-3	NO	1	1-3	1

Solo collegamento in serie - Only serial connection

Spots

EASY QUADRO 230V

EASY TONDO 230V

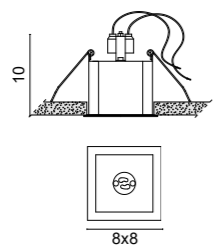

6432 Easy Quadro 230V
 .01 Bianco - White
 Light sources
 7W GU10 LED DIM (cod. 0104/..)
 7W GU10 LED (cod. 0094/..)
 F I 0,20 Kg

Accessori - Accessories



0288
 Schermo in metacrilato satinato
 Satin methacrylate screen

.01 Bianco - White

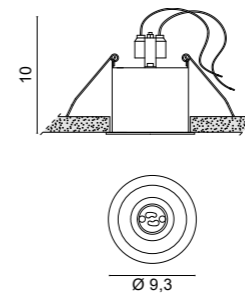

6442 Easy Tondo 230V
 .01 Bianco - White
 Light sources
 7W GU10 LED DIM (cod. 0104/..)
 7W GU10 LED (cod. 0094/..)
 F I 0,20 Kg

Accessori - Accessories



0289
 Schermo in metacrilato satinato
 Satin methacrylate screen

.01 Bianco - White



TAPPO

design: U.T. EGOLUCE

Faretti da incasso "mini trim" con struttura in pressofusione di alluminio, ottica arretrata, realizzati in tre differenti dimensioni per consentire l'utilizzo di varie sorgenti luminose. La sorgente luminosa arretrata nel corpo garantisce un miglior controllo dell'abbagliamento diretto.

FINITURE DISPONIBILI:

- .01 bianco
- .02 nero
- .21 dorato lucido
- .25 dorato satinato
- .31 cromato
- .32 nickel satinato
- .38 ramato lucido

CARATTERISTICHE DEL PRODOTTO:

- Installazione ad incasso su controsoffitti in cartongesso tramite molle
- Installazione ad incasso in muratura utilizzando il Plaster Kit
- Fissi o orientabili

SORGENTI LUMINOSE:

- GU5,3 LED
- GU10 LED
- Modulo LED COB
- Modulo LED COB IP54
- Modulo 24V art. 0107/24V/W, /WW, /XW (p. 394)

I moduli LED COB sono disponibili con temperatura di colore di 2700K (XW), 3000K (WW), 4000K (W) con CRI>90 e con aperture ottiche di 24°, 40° e 60°.

Il funzionamento prevede l'utilizzo di un alimentatore da ordinare separatamente. Sono disponibili anche alimentatori dimmerabili per un controllo PUSH, 1...10V o DALI e unità per il funzionamento in emergenza.

Possibilità di funzionamento a 24V con art. 0226 (p. 370).

"Mini trim" recessed spotlights with die-cast aluminum structure, recessed optics, made in three different sizes to allow the use of various light sources. The light source set back in the body ensures better control of direct glare.

AVAILABLE FINISHES:

- .01 white
- .02 black
- .21 shiny gold
- .25 satin gold
- .31 chromed
- .32 satin nickel
- .38 shiny copper

PRODUCT FEATURES:

- Recessed installation in plasterboard false ceilings using springs
- Recessed installation in masonry using the Plaster Kit
- Fixed or adjustable

LIGHT SOURCES:

- GU5,3 LED
- GU10 LED
- COB LED module
- IP54 COB LED module
- 24V LED modules art. 0107/24V/W, /WW, /XW (p. 394)

The COB LED modules are available with color temperatures of 2700K (XW), 3000K (WW), 4000K (W) with CRI>90 and with optical apertures of 24°, 40° and 60°.

Operation involves the use of a driver to be ordered separately. Dimmable driver for PUSH, 1...10V or DALI control and units for emergency operation are also available.

Possibility of operation at 24V with art. 0226 (p. 370).

Spots encastrés "mini trim" avec structure en aluminium moulé sous pression, optique encastrée, réalisés en trois tailles différentes pour permettre l'utilisation de différentes sources lumineuses. La source lumineuse en retrait dans le corps assure un meilleur contrôle de l'éblouissement direct.

FINITIONS DISPONIBLES:

- .01 blanc
- .02 noir
- .21 or brillant
- .25 or satiné
- .31 chromé
- .32 nickel satiné
- .38 cuivre brillant

CARACTÉRISTIQUES DU PRODUIT:

- Installation encastrée dans les faux plafonds en plaques de plâtre à l'aide de ressorts
- Installation encastrée dans la maçonnerie à l'aide du kit de plâtre
- Fixe ou réglable

SOURCES LUMINEUSES:

- GU5,3 LED
- GU10 LED
- Module LED COB
- Module LED COB IP54
- Modules LED 24V art. 0107/24V/W, /WW, /XW (p. 394)

Les modules LED COB sont disponibles avec des températures de couleur de 2700K (XW), 3000K (WW), 4000K (W) avec CRI>90 et avec des ouvertures optiques de 24°, 40° et 60°.

Le fonctionnement implique l'utilisation d'une alimentation à commander séparément. Des alimentations graduables pour le contrôle PUSH, 1...10V ou DALI et des unités pour le fonctionnement d'urgence sont également disponibles.

Possibilité de fonctionnement en 24V avec art. 0226 (p. 370).

Proyectores de empotrar "Mini trim" con estructura de aluminio inyectado, óptica de empotrar, fabricados en tres tamaños diferentes para permitir el uso de varias fuentes de luz. La fuente de luz retranqueada en el cuerpo garantiza un mejor control del deslumbramiento directo.

ACABADOS DISPONIBLES:

- .01 blanco
- .02 negro
- .21 oro brillante
- .25 oro satinado
- .31 cromado
- .32 níquel satinado
- .38 cobre brillante

CARACTERÍSTICAS DEL PRODUCTO:

- Instalación empotrada en falsos techos de cartón yeso mediante muelles
- Instalación empotrada en mampostería mediante Kit Yeso
- Fijo o ajustable

FUENTES DE LUZ:

- GU5,3 LED
- GU10 LED
- Módulo LED COB
- Módulo LED COB IP54
- Módulos LED 24V art. 0107/24V/W, /WW, /XW (p. 394)

Los módulos LED COB están disponibles con temperaturas de color de 2700K (XW), 3000K (WW), 4000K (W) con CRI>90 y con aperturas ópticas de 24°, 40° y 60°.

El funcionamiento implica el uso de una fuente de alimentación que se pedirá por separado. También están disponibles alimentación regulables para control PUSH, 1...10V o DALI y unidades para operación de emergencia.

Posibilidad de funcionamiento a 24V con arte 0226 (p. 370).

"Mini trim" Einbaustrahler mit Struktur aus Aluminiumdruckguss, Einbauoptik, in drei verschiedenen Größen hergestellt, um die Verwendung verschiedener Lichtquellen zu ermöglichen. Die im Korpus zurückgesetzte Lichtquelle sorgt für eine bessere Kontrolle der Direktblendung.

VERFÜGBARE AUSFÜHRUNGEN:

- .01 weiß
- .02 schwarz
- .21 glänzendes Gold
- .25 Satingold
- .31 Chrom
- .32 satiniertes Nickel
- .38 glänzendes Kupfer

PRODUKTEIGENSCHAFTEN:

- Versenkter Einbau in Zwischendecken aus Gipskarton mit Federn
- Unterputzmontage im Mauerwerk mit dem Putzset
- Fest oder einstellbar

LICHTQUELLEN:

- GU5,3 LED
- GU10 LED
- COB-LED-Modul
- IP54-COB-LED-Modul
- 24V-LED-Module art. 0107/24V/W, /WW, /XW (p. 394)

Die COB-LED-Module sind mit Farbtemperaturen von 2700K (XW), 3000K (WW), 4000K (W) mit CRI>90 und mit optischen Aperturen von 24°, 40° und 60° erhältlich. Der Betrieb erfolgt über ein separat zu bestellendes Netzteil. Dimmbare Netzteil für PUSH, 1...10V oder DALI Steuerung und Geräte für den Notbetrieb sind ebenfalls erhältlich.

Möglichkeit des Betriebs bei 24V mit Kunst. 0226 (p. 370).

Встраиваемые прожекторы «Mini trim» с литой алюминиевой конструкцией, встраиваемой оптикой, выполненные в трех размерах, что позволяет использовать различные источники света. Источник света, расположенный сзади в корпусе, обеспечивает лучшую защиту от прямых бликов.

ДОСТУПНЫЕ ОТДЕЛКИ:

- .01 белый
- .02 черный
- .21 блестящее золото
- .25 атласное золото
- .31 хром
- .32 сатинированный никель
- .38 блестящая медь

ОСОБЕННОСТИ ПРОДУКТА:

- Встраиваемая установка в гипсокартонные подвесные потолки с использованием пружин
- Утопленный монтаж в кирпичной кладке с использованием набора для штукатурки.
- Фиксированный или регулируемый

ИСТОЧНИКИ СВЕТА:

- GU5,3 LED
- GU10 LED
- Светодиодный модуль COB
- Светодиодный модуль COB IP54 с использованием
- Светодиодные модули 24V art. 0107/24V/W, /WW, /XW (p. 394)

Светодиодные модули COB доступны с цветовой температурой 2700K (XW), 3000K (WW), 4000K (W) с CRI>90 и с оптическими апертурами 24°, 40° и 60°. Эксплуатация предполагает использование блока питания, который заказывается отдельно. Также доступны диммируемые питания для управления PUSH, 1...10 В или DALI, а также устройства для аварийного режима.

Возможность работы на 24В с искусством. 0226 (p. 370).

Spots

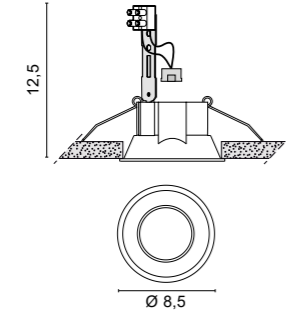
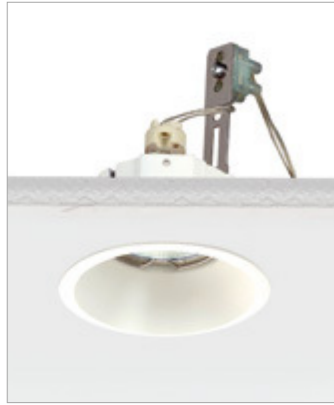

6330 Tappo

.01	Bianco - White
.02	Nero - Black
.21	Dorato lucido - Shiny golded
.25	Dorato satinato - Golded satin
.31	Cromato - Chromed
.32	Nickel satinato - Nickel mat
.38	Ramato lucido - Shiny copper

Light sources
12V GU5.3

0,14 Kg

7,9 cm

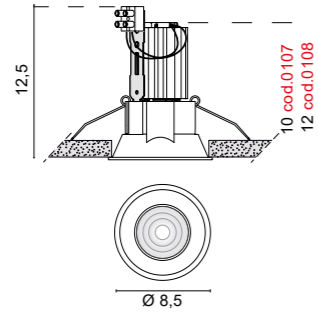

6330 + COB LED CRI>90

	Color temperature	Optics	COB LED light source	lm source	lm output
0107/W	4000K	/24 /40 /60 /ST	5,9W 17V 350mA	885lm	695lm
0107/WW	3000K	/24 /40 /60 /ST	5,9W 17V 350mA	836lm	657lm
0107/XW	2700K	/24 /40 /60 /ST	5,9W 17V 350mA	800lm	629lm
0108/W	4000K	/24 /40 /60 /ST	8,7W 17,5V 500mA	1223lm	957lm
0108/WW	3000K	/24 /40 /60 /ST	8,7W 17,5V 500mA	1156lm	905lm
0108/XW	2700K	/24 /40 /60 /ST	8,7W 17,5V 500mA	1106lm	865lm
0108/W/IP	4000K	/24 /38 /58	IP54 8,7W 17,5V 500mA	1223lm	957lm
0108/WW/IP	3000K	/24 /38 /58	IP54 8,7W 17,5V 500mA	1156lm	905lm
0108/XW/IP	2700K	/24 /38 /58	IP54 8,7W 17,5V 500mA	1106lm	865lm

7,9 cm

Accessori - Accessories



0203
Plaster kit traforato 15 x 19
Plaster kit perforated 15 x 19



0183
Dischi reggi lampadina in metacrilato
solo per il fissaggio del modulo LED.
Methacrylate disks
only for fixing LED module.



/TR Trasparente - Clear



/ST Satinato - Satin

Drivers

Cod. LED	Drivers ON/OFF			DIMMABLE drivers					Casambi 0145/CASA	LED emergency unit 0115/EM Inverter + Battery + LED indicator	
	0125 350mA	0147/COB 500mA	0149/COB 500mA	0141/DIM PUSH - 1...10V	0141/DALI DIM DALI	0145/DALI DIM DALI	0145 DIM	0733/DIM PHASE CUT			0734/DIM PHASE CUT
0107 - COB LED	1	NO	NO	1-2	1-2	1-3	1-3	1	NO	1-3	1
0108 - COB LED	1	1-2	1	1-2	1-2	1-3	1-3	NO	1	1-3	1

Solo collegamento in serie - Only serial connection

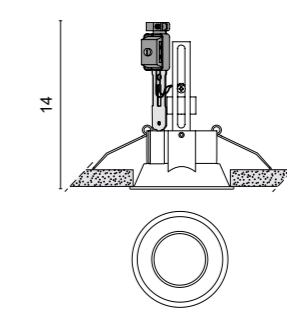
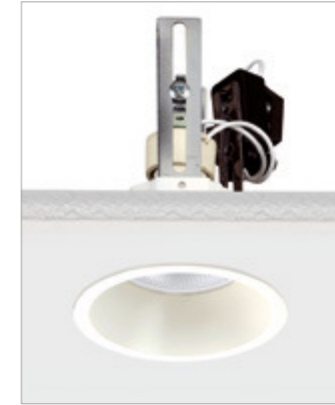

6329 Tappo 230V

.01	Bianco - White
.02	Nero - Black
.21	Dorato lucido - Shiny golded
.25	Dorato satinato - Golded satin
.31	Cromato - Chromed
.32	Nickel satinato - Nickel mat
.38	Ramato lucido - Shiny copper

Light sources
7W GU10 LED DIM (cod. 0104/..)
7W GU10 LED (cod. 0094/..)

0,20 Kg

7,9 cm



.01 Bianco - White



.02 Nero - Black



.21 Dorato lucido - Shiny golded



.25 Dorato satinato - Golded satin



.31 Cromato - Chromed



.32 Nickel satinato - Nickel mat



.38 Rame lucido - Shiny copper



Spots

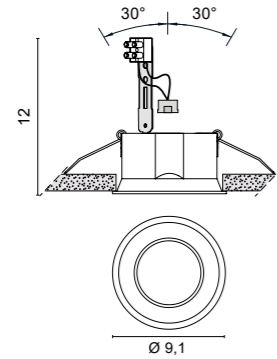

8,6 cm

6318 Tappo Adjustable

- .01 Bianco - White
- .02 Nero - Black

Light sources
12V GU5.3

0,22 Kg

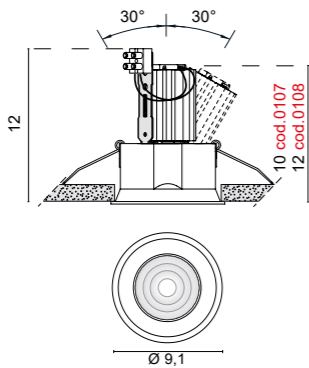

8,6 cm

6318 + COB LED CRI>90

	Color temperature	Optics	COB LED light source	lm source	lm output
0107/W	4000K	/24 /40 /60 /ST	5,9W 17V 350mA	885lm	695lm
0107/WW	3000K	/24 /40 /60 /ST	5,9W 17V 350mA	836lm	657lm
0107/XW	2700K	/24 /40 /60 /ST	5,9W 17V 350mA	800lm	629lm
0108/W	4000K	/24 /40 /60 /ST	8,7W 17,5V 500mA	1223lm	957lm
0108/WW	3000K	/24 /40 /60 /ST	8,7W 17,5V 500mA	1156lm	905lm
0108/XW	2700K	/24 /40 /60 /ST	8,7W 17,5V 500mA	1106lm	865lm
0108/W/IP	4000K	/24 /38 /58	IP54 8,7W 17,5V 500mA	1223lm	957lm
0108/WW/IP	3000K	/24 /38 /58	IP54 8,7W 17,5V 500mA	1156lm	905lm
0108/XW/IP	2700K	/24 /38 /58	IP54 8,7W 17,5V 500mA	1106lm	865lm

Accessori - Accessories



0183
Dischi reggi lampadina in metacrilato solo per il fissaggio del modulo LED.
Methacrylate disks only for fixing LED module.

/TR Trasparente - Clear

/ST Satinato - Satin

Drivers

Cod. LED	Drivers ON/OFF			DIMMABLE drivers				Casambi 0145/CASA	LED emergency unit 0115/EM Inverter + Battery + LED indicator		
	350mA	500mA	500mA	0141/DIM PUSH - 1...10V	0141/DALI DIM DALI	0145/DALI DIM DALI	0145 DIM			0733/DIM PHASE CUT	0734/DIM PHASE CUT
0107 - COB LED	1	NO	NO	1-2	1-2	1-3	1-3	1	NO	1-3	1
0108 - COB LED	1	1-2	1	1-2	1-2	1-3	1-3	NO	1	1-3	1

Solo collegamento in serie - Only serial connection

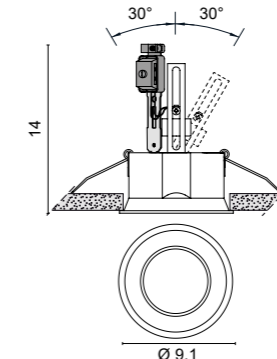

8,6 cm

6319 Tappo Adjustable 230V

- .01 Bianco - White
- .02 Nero - Black

Light sources
7W GU10 LED DIM (cod. 0104/..)
7W GU10 LED (cod. 0094/..)

0,28 Kg



TAPPO mini

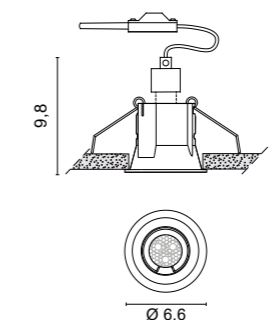

5,9 cm

6325 Tappo mini

- .01 Bianco - White
- .02 Nero - Black

Light sources
3W GU10 LED Ø35mm (cod. 0093/19)

0,10 Kg

Accessori - Accessories



0221
Plaster kit traforato 12,5 x 9
Plaster kit preforated 12,5 x 9



Spots

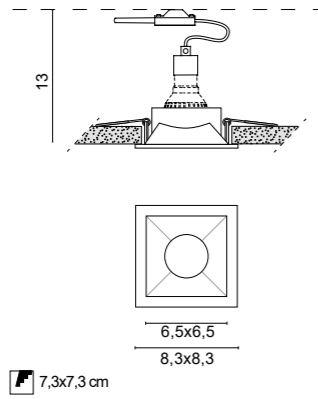
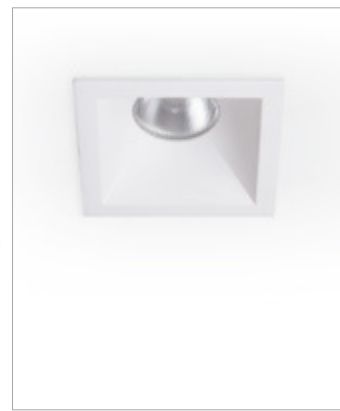

6670 Tappo Quadro 230V

.01 Bianco - White

Light sources

7W GU10 LED DIM (cod. 0104/..)

7W GU10 LED (cod. 0094/..)



0,12 Kg

Spots





EDY design: U.T. EGOLUCE

Faretti da incasso con corpo e cornice in metallo, ottica arretrata, realizzati in due differenti dimensioni per consentire l'utilizzo di varie sorgenti luminose. La sorgente luminosa arretrata nel corpo garantisce un miglior controllo dell'abbagliamento diretto. Luce d'accento o diffusa grazie allo schermo diffusore in vetro satinato (Art. 0199) da ordinare separatamente.

FINITURE DISPONIBILI:

- .01 bianco
- .31 cromato
- .32 nickel satinato

CARATTERISTICHE DEL PRODOTTO:

- Installazione ad incasso su controsoffitti in cartongesso con apposite molle
- Installazione ad incasso in muratura utilizzando apposite casseforme da ordinare separatamente
- Il fissaggio delle cornici con magneti facilita le operazioni di manutenzione

SORGENTI LUMINOSE:

- GU5,3 LED
- GU10 LED
- Modulo LED COB
- Modulo LED COB IP54
- Modulo 24V art. 0107/24V/W, /WW, /XW (p. 394)

I moduli LED COB sono disponibili con temperatura di colore di 2700K (XW), 3000K (WW), 4000K (W) con CRI>90 e con aperture ottiche di 24°, 40° e 60°.

Il funzionamento prevede l'utilizzo di un alimentatore da ordinare separatamente. Sono disponibili anche alimentatori dimmerabili per un controllo PUSH, 1...10V o DALI e unità per il funzionamento in emergenza.

Possibilità di funzionamento a 24V con art. 0226 (p. 370).

Recessed spotlights with metal body and frame, recessed optics, made in two different sizes to allow the use of various light sources. The light source set back in the body ensures better control of direct glare. Accent or diffused light thanks to the satin glass diffuser screen (Art. 0199) to be ordered separately.

AVAILABLE FINISHES:

- .01 white
- .31 chromed
- .32 satin nickel

PRODUCT FEATURES:

- Recessed installation in plasterboard false ceilings with special springs
- Recessed installation in masonry using special formwork to be ordered separately
- Fixing of the frames with magnets facilitates maintenance operations

LIGHT SOURCES:

- GU5,3 LED
- GU10 LED
- COB LED module
- IP54 COB LED module
- 24V LED modules art. 0107/24V/W, /WW, /XW (p. 394)

The COB LED modules are available with color temperatures of 2700K (XW), 3000K (WW), 4000K (W) with CRI>90 and with optical apertures of 24°, 40° and 60°.

Operation involves the use of a driver to be ordered separately. Dimmable driver for PUSH, 1...10V or DALI control and units for emergency operation are also available.

Possibility of operation at 24V with art. 0226 (p. 370).

Spots encastrés avec corps et cadre en métal, optique encastrée, réalisés en deux tailles différentes pour permettre l'utilisation de différentes sources lumineuses. La source lumineuse en retrait dans le corps assure un meilleur contrôle de l'éblouissement direct. Lumière d'accentuation ou diffuse grâce à l'écran diffuseur en verre satiné (Art. 0199) à commander séparément.

FINITIONS DISPONIBLES:

- .01 blanc
- .31 chromé
- .32 nickel satiné

CARACTÉRISTIQUES DU PRODUIT:

- Installation encastrée dans des faux plafonds en plaques de plâtre avec des ressorts spéciaux
- Installation encastrée dans la maçonnerie à l'aide de coffrages spéciaux à commander séparément
- La fixation des cadres par des aimants facilite les opérations de maintenance

SOURCES LUMINEUSES:

- GU5,3 LED
- GU10 LED
- Module LED COB
- Module LED COB IP54
- Modules LED art. 0107/24V/W, /WW, /XW (p. 394)

Les modules LED COB sont disponibles avec des températures de couleur de 2700K (XW), 3000K (WW), 4000K (W) avec CRI>90 et avec des ouvertures optiques de 24°, 40° et 60°.

Le fonctionnement implique l'utilisation d'une alimentation à commander séparément. Des alimentations graduables pour le contrôle PUSH, 1...10V ou DALI et des unités pour le fonctionnement d'urgence sont également disponibles.

Possibilité de fonctionnement en 24V avec art. 0226 (p.370).

Proyectoros de empotrar con cuerpo y marco de metal, óptica de empotrar, realizados en dos tamaños diferentes para permitir el uso de varias fuentes de luz. La fuente de luz retranqueada en el cuerpo garantiza un mejor control del deslumbramiento directo. Luz de acento o difusa gracias a la pantalla difusora de cristal satinado (Art. 0199) a pedir por separado.

ACABADOS DISPONIBLES:

- .01 blanco
- .31 cromado
- .32 níquel satinado

CARACTERÍSTICAS DEL PRODUCTO:

- Instalación empotrada en falsos techos de cartón yeso con muelles especiales
- Instalación empotrada en mampostería mediante encofrado especial a pedir por separado
- La fijación de los marcos con imanes facilita las operaciones de mantenimiento

FUENTES DE LUZ:

- GU5,3 LED
- GU10 LED
- Módulo LED COB
- Módulo LED COB IP54
- Módulos LED 24V art. 0107/24V/W, /WW, /XW (p. 394)

Los módulos LED COB están disponibles con temperaturas de color de 2700K (XW), 3000K (WW), 4000K (W) con CRI>90 y con aperturas ópticas de 24°, 40° y 60°.

El funcionamiento implica el uso de una fuente de alimentación que se pedirá por separado. También están disponibles alimentación regulables para control PUSH, 1...10V o DALI y unidades para operación de emergencia.

Posibilidad de funcionamiento a 24V con arte 0226 (p. 370).

Einbaustrahler mit Metallkörper und rahmen, Einbauoptik, hergestellt in zwei verschiedenen Größen, um die Verwendung verschiedener Lichtquellen zu ermöglichen. Die im Korpus zurückgesetzte Lichtquelle sorgt für eine bessere Kontrolle der Direktblendung. Akzentuierendes oder diffuses Licht dank separat zu bestellender Diffusorscheibe aus satiniertem Glas (Art. 0199).

VERFÜGBARE AUSFÜHRUNGEN:

- .01 weiß
- .31 Chrom
- .32 satiniertes Nickel

PRODUKTEIGENSCHAFTEN:

- Versenkter Einbau in Zwischendecken aus Gipskarton mit speziellen Federn
- Versenkter Einbau in Mauerwerk mit separat zu bestellender Sonderschalung
- Befestigung der Rahmen mit Magneten erleichtert Wartungsarbeiten

LICHTQUELLEN:

- GU5,3 LED
- GU10 LED
- COB-LED-Modul
- IP54-COB-LED-Modul
- 24V-LED-Module art. 0107/24V/W, /WW, /XW (p.394)

Die COB-LED-Module sind mit Farbtemperaturen von 2700K (XW), 3000K (WW), 4000K (W) mit CRI>90 und mit optischen Aperturen von 24°, 40° und 60° erhältlich. Der Betrieb erfolgt über ein separat zu bestellendes Netzteil. Dimmbare Netzteil für PUSH, 1...10V oder DALI Steuerung und Geräte für den Notbetrieb sind ebenfalls erhältlich.

Möglichkeit des Betriebs bei 24V mit Kunst. 0226 (p. 370).

Встраиваемые прожекторы с металлическим корпусом и рамой, встраиваемой оптикой, выполненные в двух размерах, что позволяет использовать различные источники света. Источник света, расположенный сзади в корпусе, обеспечивает лучшую защиту от прямых бликов. Акцентный или рассеянный свет благодаря рассеивателю из сатинированного стекла (арт. 0199), который заказывается отдельно.

ДОСТУПНЫЕ ОТДЕЛКИ:

- .01 белый
- .31 хром
- .32 сатинированный никель

ОСОБЕННОСТИ ПРОДУКТА:

- Встраиваемая установка в гипсокартонные подвесные потолки со специальными пружинами
- Заглубленный монтаж в кирпичной кладке с использованием специальной опалубки, которую необходимо заказывать отдельно.
- Фиксация рам с помощью магнитов облегчает техническое обслуживание

ИСТОЧНИКИ СВЕТА:

- GU5,3 LED
- GU10 LED
- Светодиодный модуль COB
- Светодиодный модуль COB IP54
- Светодиодные модули 24В art. 0107/24V/W, /WW, /XW (p. 394)

Светодиодные модули COB доступны с цветовой температурой 2700K (XW), 3000K (WW), 4000K (W) с CRI>90 и с оптическими апертурами 24°, 40° и 60°. Эксплуатация предполагает использование блока питания, который заказывается отдельно. Также доступны диммируемые питания для управления PUSH, 1...10 В или DALI, а также устройства для аварийного режима.

Возможность работы на 24В с искусством. 0226 (p. 370).

Spots

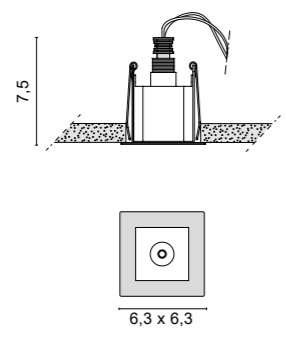

6298 Edy Mini

.01	Bianco - White
.31	Cromato - Chromed
.32	Nickel satinato - Nickel mat

Color temperature	LED light source	lm source
/W 4000K	1,5W 500mA	221lm
/MW 3000K	1,5W 500mA	210lm
/XW 2700K	1,5W 500mA	199lm

0,10 Kg

5,2x5,2 cm

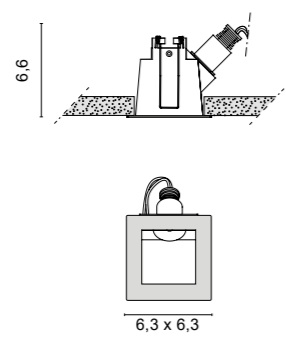

6299 Edy 45° Mini

.01	Bianco - White
.31	Cromato - Chromed
.32	Nickel satinato - Nickel mat

Color temperature	LED light source	lm source
/W 4000K	1,5W 500mA	221lm
/MW 3000K	1,5W 500mA	210lm
/XW 2700K	1,5W 500mA	199lm

0,10 Kg

5,2x5,2 cm

Accessori - Accessories



10x10,5x8,5h

0218
Cassaforma per calcestruzzo
Wallbox for concrete



13x10x0,7h

0219
Plaster kit traforato
Plaster kit preforated

Drivers

Cod.	Drivers ON/OFF	DIMMABLE drivers				Casambi
		0141/DIM PUSH - 1...10V	0141/DALI DIM DALI	0145 DIM	0145/DALI DIM DALI	0145/CASA
6298	1-6	1-11 (500mA)	1-11 (500mA)	1-21	1-21	1-21
6299	1-6	1-11 (500mA)	1-11 (500mA)	1-21	1-21	1-21

Solo collegamento in serie - Only serial connection

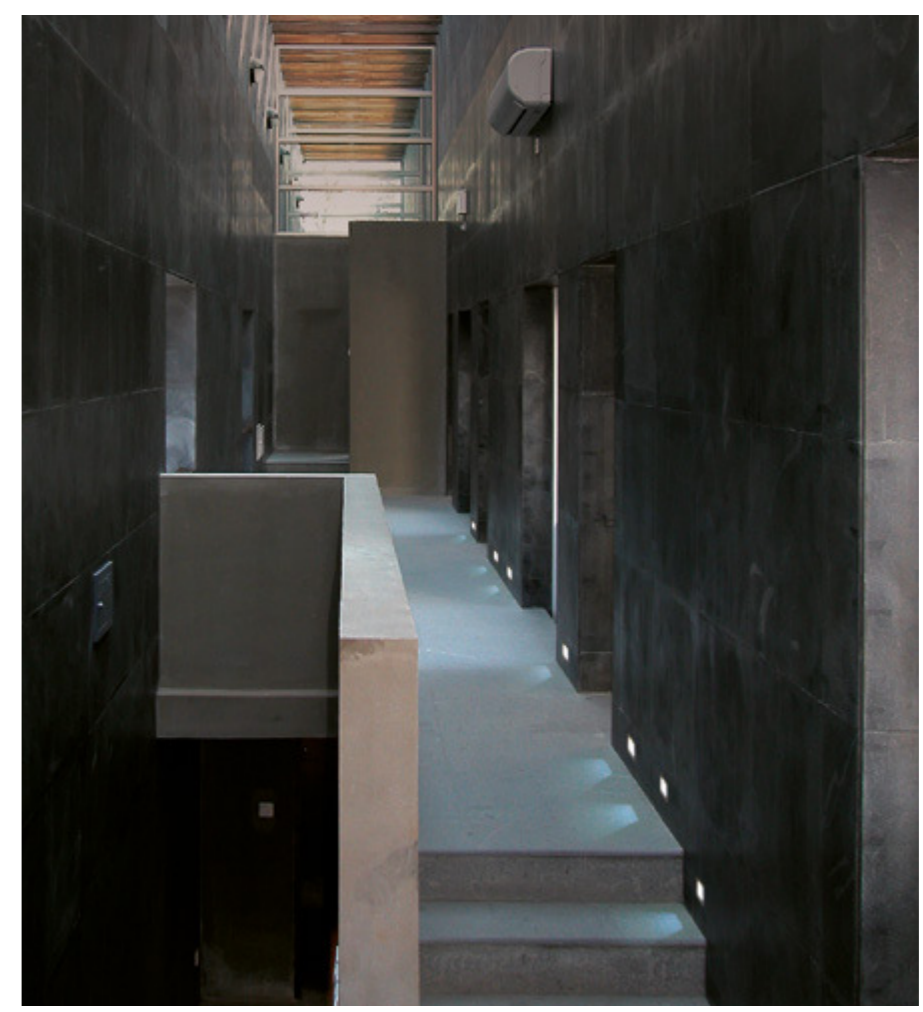

Spots



Art. 6699.31 Edy 45° mini

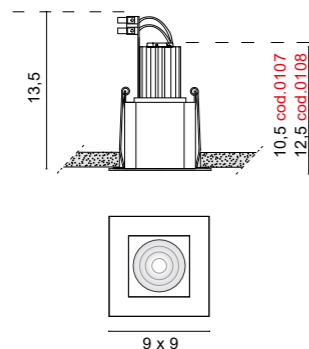

7,2 x 8,2 cm

6305 Edy

- .01** Bianco - White
- .31** Cromato - Chromed
- .32** Nickel satinato - Nickel mat



6305 + COB LED CRI>90

Color temperature	Optics	COB LED light source	lm source	lm output
0107/W 4000K	/24 /40 /60 /ST	5,9W 17V 350mA	885lm	695lm
0107/WW 3000K	/24 /40 /60 /ST	5,9W 17V 350mA	836lm	657lm
0107/XW 2700K	/24 /40 /60 /ST	5,9W 17V 350mA	800lm	629lm
0108/W 4000K	/24 /40 /60 /ST	8,7W 17,5V 500mA	1223lm	957lm
0108/WW 3000K	/24 /40 /60 /ST	8,7W 17,5V 500mA	1156lm	905lm
0108/XW 2700K	/24 /40 /60 /ST	8,7W 17,5V 500mA	1106lm	865lm
0108/W/IP 4000K	/24 /38 /58	IP54 8,7W 17,5V 500mA	1223lm	957lm
0108/WW/IP 3000K	/24 /38 /58	IP54 8,7W 17,5V 500mA	1156lm	905lm
0108/XW/IP 2700K	/24 /38 /58	IP54 8,7W 17,5V 500mA	1106lm	865lm

Accessori - Accessories



0199
Kit vetro diffusore sabbaiato extrachiaro
Kit diffuser glass

Drivers

Cod. LED	Drivers ON/OFF			DIMMABLE drivers				Casambi	LED emergency unit		
	0125	0147/COB	0149/COB	0141/DIM	0141/DALI	0145/DALI	0145	0733/DIM	0734/DIM	0145/CASA	0115/EM
	350mA	500mA	500mA	PUSH - 1...10V	DIM DALI	DIM DALI	DIM	PHASE CUT	PHASE CUT		Inverter + Battery + LED indicator
0107 - COB LED	1	NO	NO	1-2	1-2	1-3	1-3	1	NO	1-3	1
0108 - COB LED	1	1-2	1	1-2	1-2	1-3	1-3	NO	1	1-3	1

Solo collegamento in serie - Only serial connection

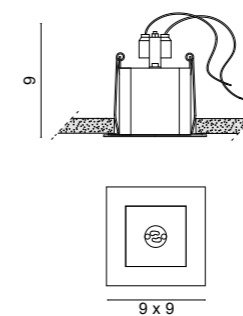

7,2 x 8,2 cm

6302 Edy 230V

- .01** Bianco - White
- .31** Cromato - Chromed
- .32** Nickel satinato - Nickel mat

Light sources

- 7W GU10 LED DIM (cod. 0104/..)
- 7W GU10 LED (cod. 0094/..)



Accessori - Accessories



0199
Kit vetro diffusore sabbaiato extrachiaro
Kit diffuser glass



0200
Cassaforma per calcestruzzo
Wallbox for concrete



0201
Plaster kit traforato
Plaster kit perforated



GEKO *design: U.T. EGOLUCE*

Faretti da incasso per controsoffitti in cartongesso con struttura in pressofusione di alluminio, realizzati in differenti dimensioni per consentire l'utilizzo di varie sorgenti luminose e con flangia tonda o quadrata.

FINITURE DISPONIBILI:

- .01 bianco
- .02 nero
- .03 grigio
- .21 dorato lucido
- .25 dorato satinato
- .31 cromato
- .32 nickel satinato

CARATTERISTICHE DEL PRODOTTO:

- Installazione ad incasso su controsoffitti in cartongesso tramite molle
- Fissi o orientabili

SORGENTI LUMINOSE:

- GU5,3 LED
- GU10 LED
- Modulo LED COB
- Modulo LED COB IP54
- Modulo 24V art. 0107/24V/W, /WW, /XW (p. 394)

I moduli LED COB sono disponibili con temperatura di colore di 2700K (XW), 3000K (WW), 4000K (W) con CRI>90 e con aperture ottiche di 24°, 40° e 60°. Il funzionamento prevede l'utilizzo di un alimentatore da ordinare separatamente. Sono disponibili anche alimentatori dimmerabili per un controllo PUSH, 1...10V o DALI e unità per il funzionamento in emergenza.

Possibilità di funzionamento a 24V con art. 0226 (p. 370).

Recessed spotlights for plasterboard false ceilings with die-cast aluminum structure, made in different sizes to allow the use of various light sources and with a round or square flange.

AVAILABLE FINISHES:

- .01 white
- .02 black
- .03 gray
- .21 shiny gold
- .25 satin gold
- .31 chrome
- .32 satin nickel

PRODUCT FEATURES:

- Recessed installation in plasterboard false ceilings using springs
- Fixed or adjustable

LIGHT SOURCES:

- GU5,3 LED
- GU10 LED
- COB LED module
- IP54 COB LED module
- 24V LED modules art. 0107/24V/W, /WW, /XW (p. 394)

The COB LED modules are available with color temperatures of 2700K (XW), 3000K (WW), 4000K (W) with CRI>90 and with optical apertures of 24°, 40° and 60°.

Operation involves the use of a driver to be ordered separately. Dimmable driver for PUSH, 1...10V or DALI control and units for emergency operation are also available.

Possibility of operation at 24V with art. 0226 (p.370).

Spots encastrés pour faux plafonds en plaques de plâtre avec structure en aluminium moulé sous pression, réalisés en différentes tailles pour permettre l'utilisation de différentes sources lumineuses et avec une bride ronde ou carrée.

FINITIONS DISPONIBLES :

- .01 blanc
- .02 noir
- .03 gris
- .21 or brillant
- .25 or satiné
- .31 chromé
- .32 nickel satiné

CARACTÉRISTIQUES DU PRODUIT:

- Installation encastrée dans les faux plafonds en plaques de plâtre à l'aide de ressorts
- Fixe ou réglable

SOURCES LUMINEUSES:

- GU5,3 LED
- GU10 LED
- Module LED COB
- Module LED COB IP54
- Modules LED 24V art. 0107/24V/W, /WW, /XW (p. 394)

Les modules LED COB sont disponibles avec des températures de couleur de 2700K (XW), 3000K (WW), 4000K (W) avec CRI>90 et avec des ouvertures optiques de 24°, 40° et 60°.

Le fonctionnement implique l'utilisation d'une alimentation à commander séparément. Des alimentations graduables pour le contrôle PUSH, 1...10V ou DALI et des unités pour le fonctionnement d'urgence sont également disponibles.

Possibilité de fonctionnement en 24V avec art. 0226 (p. 370).



Proyectoros de empotrar para falsos techos de escayola con estructura de aluminio inyectado, fabricados en diferentes medidas para permitir el uso de diversas fuentes de luz y con brida redonda o cuadrada.

ACABADOS DISPONIBLES:

- .01 blanco
- .02 negro
- .03 gris
- .21 oro brillante
- .25 oro satinado
- .31 cromado
- .32 níquel satinado

CARACTERÍSTICAS DEL PRODUCTO:

- Instalación empotrada en falsos techos de cartón yeso mediante muelles
- Fijo o ajustable

FUENTES DE LUZ:

- GU5,3 LED
- GU10 LED
- Módulo LED COB
- Módulo LED COB IP54
- Módulos LED 24V art. 0107/24V/W, /WW, /XW (p. 394)

Los módulos LED COB están disponibles con temperaturas de color de 2700K (XW), 3000K (WW), 4000K (W) con CRI>90 y con aperturas ópticas de 24°, 40° y 60°.

El funcionamiento implica el uso de una fuente de alimentación que se pedirá por separado. También están disponibles alimentación regulables para control PUSH, 1...10V o DALI y unidades para operación de emergencia.

Posibilidad de funcionamiento a 24V con arte 0226 (p. 370).

Einbaustrahler für Zwischendecken aus Gipskarton mit Struktur aus Aluminiumdruckguss, in verschiedenen Größen hergestellt, um die Verwendung verschiedener Lichtquellen zu ermöglichen, und mit rundem oder quadratischem Flansch.

VERFÜGBARE AUSFÜHRUNGEN:

- .01 weiß
- .02 schwarz
- .03 grau
- .21 glänzendes Gold
- .25 Satingold
- .31 Chrom
- .32 satiniertes Nickel

PRODUKTEIGENSCHAFTEN:

- Versenkter Einbau in Zwischendecken aus Gipskarton mit Federn
- Fest oder einstellbar

LICHTQUELLEN:

- GU5,3 LED
- GU10 LED
- COB-LED-Modul
- IP54-COB-LED-Modul
- 24V-LED-Module art. 0107/24V/W, /WW, /XW (p. 394)

Die COB-LED-Module sind mit Farbtemperaturen von 2700K (XW), 3000K (WW), 4000K (W) mit CRI>90 und mit optischen Aperturen von 24°, 40° und 60° erhältlich. Der Betrieb erfolgt über ein separat zu bestellendes Netzteil. Dimmbare Netzteil für PUSH, 1...10V oder DALI Steuerung und Geräte für den Notbetrieb sind ebenfalls erhältlich.

Möglichkeit des Betriebs bei 24V mit Kunst. 0226 (p. 370).

Встраиваемые точечные светильники для подвесных потолков из гипсокартона с литой алюминиевой конструкцией различных размеров, позволяющих использовать различные источники света, с круглым или квадратным фланцем.

ДОСТУПНЫЕ ОТДЕЛКИ:

- .01 белый
- .02 черный
- .03 серый
- .21 блестящее золото
- .25 атласное золото
- .31 хром
- .32 сатинированный никель

ОСОБЕННОСТИ ПРОДУКТА:

- Встраиваемая установка в гипсокартонные подвесные потолки с использованием пружин
- Фиксированный или регулируемый

ИСТОЧНИКИ СВЕТА:

- GU5,3 LED
- GU10 LED
- Светодиодный модуль COB
- Светодиодный модуль COB IP54
- Светодиодные модули 24В art. 0107/24V/W, /WW, /XW (p. 394)

Светодиодные модули COB доступны с цветовой температурой 2700K (XW), 3000K (WW), 4000K (W) с CRI>90 и с оптическими апертурами 24°, 40° и 60°. Эксплуатация предполагает использование блока питания, который заказывается отдельно. Также доступны диммируемые питания для управления PUSH, 1...10 В или DALI, а также устройства для аварийного режима.

Возможность работы на 24В с искусством. 0226 (p. 370).

Spots

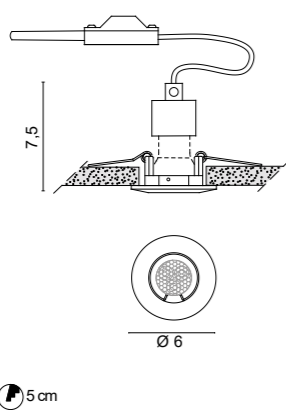

- 6680** Geko Mini 230V
- .01 Bianco - White
 - .02 Nero - Black
 - .21 Dorato lucido - Shiny golded
 - .31 Cromato - Chromed
 - .32 Nickel satinato - Nickel mat

Light sources
 3W GU10 LED Ø 3,5 cm (cod. 0093/19)



0,11 Kg

6 cm

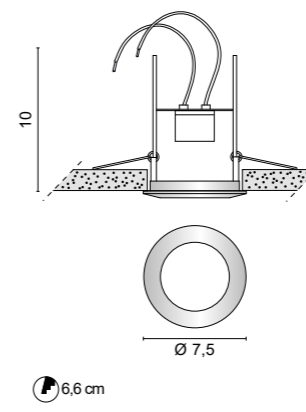

- 6290** Geko 230V
- .01 Bianco - White
 - .02 Nero - Black
 - .21 Dorato lucido - Shiny golded
 - .25 Dorato satinato - Golded satin
 - .31 Cromato - Chromed
 - .32 Nickel satinato - Nickel mat

Light sources
 7W GU10 LED DIM (cod. 0104/..)
 7W GU10 LED (cod. 0094/..)



0,11 Kg

6,6 cm

Spots

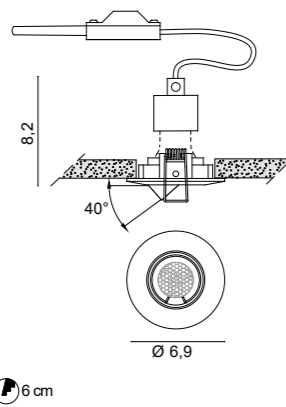

- 6681** Geko Mini Adjustable 230V
- .01 Bianco - White
 - .02 Nero - Black
 - .21 Dorato lucido - Shiny golded
 - .31 Cromato - Chromed
 - .32 Nickel satinato - Nickel mat

Light sources
 3W GU10 LED Ø 3,5 cm (cod. 0093/19)



0,11 Kg

6 cm

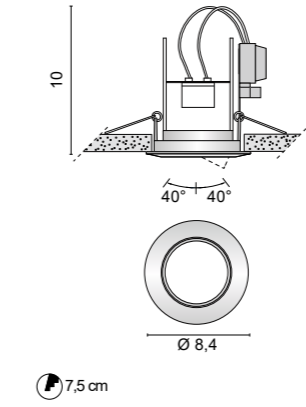

- 6455** Geko Adjustable 230V
- .01 Bianco - White
 - .02 Nero - Black
 - .03 Grigio - Grey
 - .21 Dorato lucido - Shiny golded
 - .25 Dorato satinato - Golded satin
 - .31 Cromato - Chromed
 - .32 Nickel satinato - Nickel mat

Light sources
 7W GU10 LED DIM (cod. 0104/..)
 7W GU10 LED (cod. 0094/..)



0,04 Kg

7,5 cm

Spots

Spots

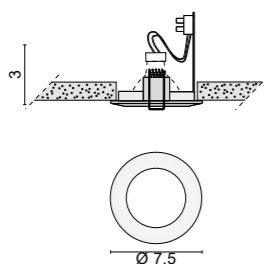

6,6 cm

6460 Geko

- .01 Bianco - White
- .02 Nero - Black
- .21 Dorato lucido - Shiny golded
- .25 Dorato satinato - Golded satin
- .31 Cromato - Chromed
- .32 Nickel satinato - Nickel mat

Light sources
12V GU5.3



0,08 Kg

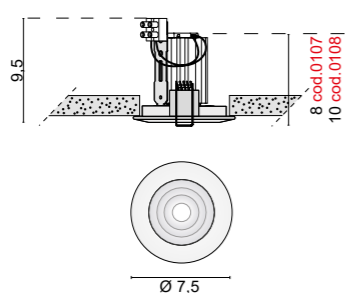
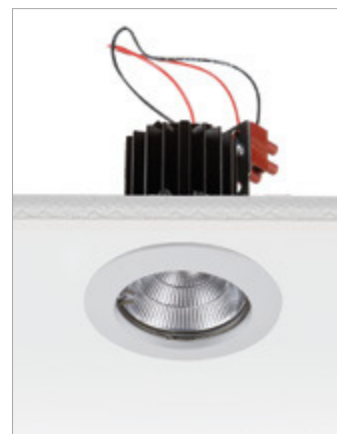

6,6 cm

6460 + COB LED CRI>90

Color temperature	Optics	COB LED light source	lm source	lm output
0107/W	4000K /24 /40 /60 /ST	5,9W 17V 350mA	885lm	695lm
0107/WW	3000K /24 /40 /60 /ST	5,9W 17V 350mA	836lm	657lm
0107/XW	2700K /24 /40 /60 /ST	5,9W 17V 350mA	800lm	629lm
0108/W	4000K /24 /40 /60 /ST	8,7W 17,5V 500mA	1223lm	957lm
0108/WW	3000K /24 /40 /60 /ST	8,7W 17,5V 500mA	1156lm	905lm
0108/XW	2700K /24 /40 /60 /ST	8,7W 17,5V 500mA	1106lm	865lm
0108/W/IP	4000K /24 /38 /58	IP54 8,7W 17,5V 500mA	1223lm	957lm
0108/WW/IP	3000K /24 /38 /58	IP54 8,7W 17,5V 500mA	1156lm	905lm
0108/XW/IP	2700K /24 /38 /58	IP54 8,7W 17,5V 500mA	1106lm	865lm

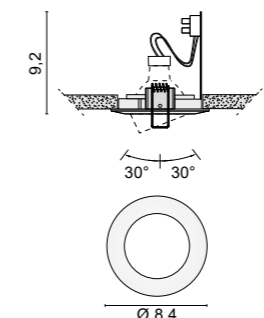
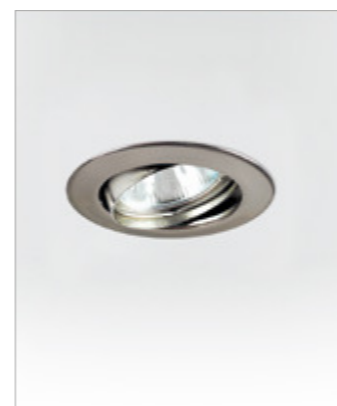

7,5 cm

6447 Geko Tondo Adjustable

- .01 Bianco - White
- .02 Nero - Black
- .03 Grigio - Grey
- .21 Dorato lucido - Shiny golded
- .25 Dorato satinato - Golded satin
- .31 Cromato - Chromed
- .32 Nickel satinato - Nickel mat

Light sources
12V GU5.3



0,13 Kg

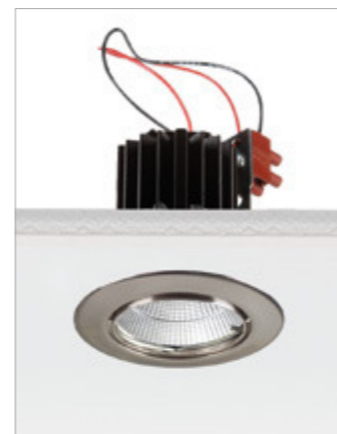

7,5 cm

6447 + COB LED CRI>90

Color temperature	Optics	COB LED light source	lm source	lm output
0107/W	4000K /24 /40 /60 /ST	5,9W 17V 350mA	885lm	695lm
0107/WW	3000K /24 /40 /60 /ST	5,9W 17V 350mA	836lm	657lm
0107/XW	2700K /24 /40 /60 /ST	5,9W 17V 350mA	800lm	629lm
0108/W	4000K /24 /40 /60 /ST	8,7W 17,5V 500mA	1223lm	957lm
0108/WW	3000K /24 /40 /60 /ST	8,7W 17,5V 500mA	1156lm	905lm
0108/XW	2700K /24 /40 /60 /ST	8,7W 17,5V 500mA	1106lm	865lm
0108/W/IP	4000K /24 /38 /58	IP54 8,7W 17,5V 500mA	1223lm	957lm
0108/WW/IP	3000K /24 /38 /58	IP54 8,7W 17,5V 500mA	1156lm	905lm
0108/XW/IP	2700K /24 /38 /58	IP54 8,7W 17,5V 500mA	1106lm	865lm

Accessori - Accessories



0183

Dischi reggi lampadina in metacrilato solo per il fissaggio del modulo LED
Methacrylate disks only for fixing LED module

- /TR Trasparente - Clear
- /ST Satinato - Satin

Drivers

Cod. LED	Drivers ON/OFF			DIMMABLE drivers				Casambi 0145/CASA	LED emergency unit 0115/EM Inverter + Battery + LED indicator		
	0125	0147/COB	0149/COB	0141/DIM	0141/DALI	0145/DALI	0145 DIM			0733/DIM	0734/DIM
0107 - COB LED	1	NO	NO	1-2	1-2	1-3	1-3	1	NO	1-3	1
0108 - COB LED	1	1-2	1	1-2	1-2	1-3	1-3	NO	1	1-3	1

Solo collegamento in serie - Only serial connection

Accessori - Accessories



0183

Dischi reggi lampadina in metacrilato solo per il fissaggio del modulo LED
Methacrylate disks only for fixing LED module

- /TR Trasparente - Clear
- /ST Satinato - Satin

Drivers

Cod. LED	Drivers ON/OFF			DIMMABLE drivers				Casambi 0145/CASA	LED emergency unit 0115/EM Inverter + Battery + LED indicator		
	0125	0147/COB	0149/COB	0141/DIM	0141/DALI	0145/DALI	0145 DIM			0733/DIM	0734/DIM
0107 - COB LED	1	NO	NO	1-2	1-2	1-3	1-3	1	NO	1-3	1
0108 - COB LED	1	1-2	1	1-2	1-2	1-3	1-3	NO	1	1-3	1

Solo collegamento in serie - Only serial connection

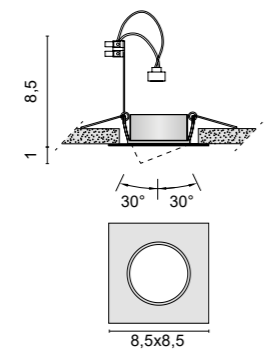
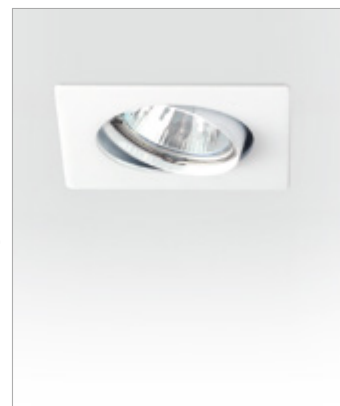

7,5 cm

- 6048** Geko Quadro Adjustable
- .01** Bianco - White
 - .02** Nero - Black
 - .21** Dorato lucido - Shiny golded
 - .25** Dorato satinato - Golded satin
 - .31** Cromato - Chromed
 - .32** Nickel satinato - Nickel mat

Light sources
12V GU5.3

0,10 Kg

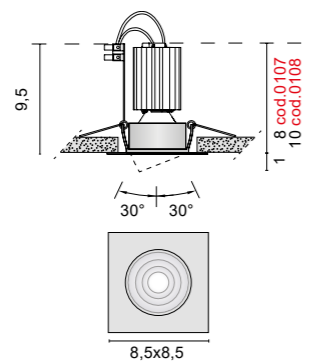

7,5 cm

6048 + COB LED CRI>90

Color temperature	Optics	COB LED light source	lm source	lm output
0107/W	4000K /24 /40 /60 /ST	5,9W 17V 350mA	885lm	695lm
0107/WW	3000K /24 /40 /60 /ST	5,9W 17V 350mA	836lm	657lm
0107/XW	2700K /24 /40 /60 /ST	5,9W 17V 350mA	800lm	629lm
0108/W	4000K /24 /40 /60 /ST	8,7W 17,5V 500mA	1223lm	957lm
0108/WW	3000K /24 /40 /60 /ST	8,7W 17,5V 500mA	1156lm	905lm
0108/XW	2700K /24 /40 /60 /ST	8,7W 17,5V 500mA	1106lm	865lm
0108/W/IP	4000K /24 /38 /58	IP54 8,7W 17,5V 500mA	1223lm	957lm
0108/WW/IP	3000K /24 /38 /58	IP54 8,7W 17,5V 500mA	1156lm	905lm
0108/XW/IP	2700K /24 /38 /58	IP54 8,7W 17,5V 500mA	1106lm	865lm

Accessori - Accessories



Dischi reggi lampadina in metacrilato solo per il fissaggio del modulo LED
Methacrylate disks **only for fixing LED module**

- /TR** Trasparente - Clear
- /ST** Satinato - Satin

Drivers

Cod. LED	Drivers ON/OFF			DIMMABLE drivers				Casambi	LED emergency unit		
	0125	0147/COB	0149/COB	0141/DIM	0141/DALI	0145/DALI	0145			0733/DIM	0734/DIM
	350mA	500mA	500mA	PUSH - 1...10V	DIM DALI	DIM DALI	DIM	PHASE CUT	PHASE CUT		
0107 - COB LED	1	NO	NO	1-2	1-2	1-3	1-3	1	NO	1-3	1
0108 - COB LED	1	1-2	1	1-2	1-2	1-3	1-3	NO	1	1-3	1

Solo collegamento in serie - Only serial connection

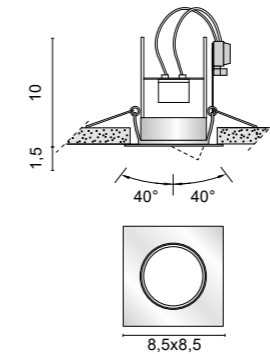
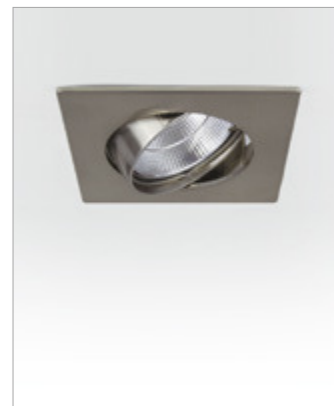

7,5 cm

- 6056** Geko Quadro Adjustable 230V
- .01** Bianco - White
 - .02** Nero - Black
 - .21** Dorato lucido - Shiny golded
 - .25** Dorato satinato - Golded satin
 - .31** Cromato - Chromed
 - .32** Nickel satinato - Nickel mat

Light sources
7W GU10 LED DIM (cod. 0104/..)
7W GU10 LED (cod. 0094/..)

0,15 Kg





Spots

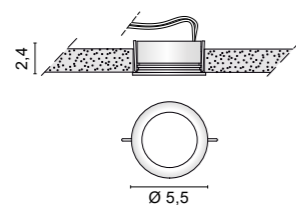
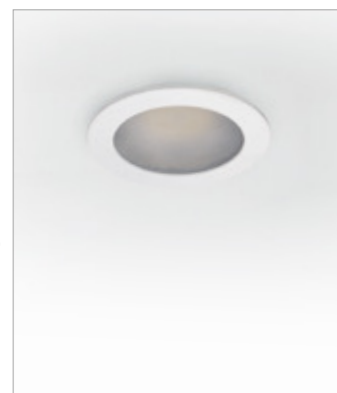

5,1 cm

6314 Krono

- .01** Bianco - White
- .02** Nero - Black
- .31** Cromato - Chromed

Color temperature	LED Light source	lm source
/W 4000K	24V 4W	658lm
/WW 3000K	24V 4W	608lm
/XW 2700K	24V 4W	562lm

F III IP54 R 0,07 Kg

Solo collegamento in parallelo 24V
Only parallel connection 24V



.01 Bianco - White



.02 Nero
Black



.31 Cromato
Chromed



Drivers

Cod.	Drivers ON/OFF		DIMMABLE drivers	
	0155	0156	0717/DIM60V	00717/DIM60
	24V - 13W	24V - 25W	1...10V	DALI - PUSH
6314	1-2	1-5	1-6	1-6

Solo collegamento in parallelo - Only parallel connection

Spots

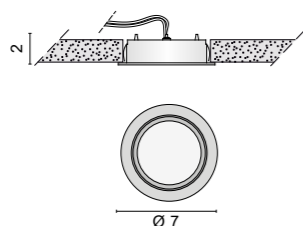

**6420** Zen LED

- .01** Bianco - White
- .21** Dorato lucido - Shiny golded
- .31** Cromato - Chromed
- .32** Nickel satinato - Nickel mat

	Color temperature	LED Light source	lm source
/W	4000K	24V 4W	658lm
/WW	3000K	24V 4W	608lm
/XW	2700K	24V 4W	562lm



0,07 Kg

Solo collegamento in parallelo 24V
Only parallel connection 24V

6 cm

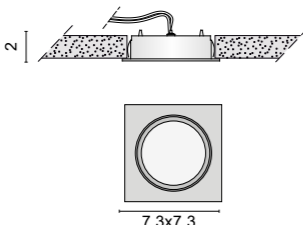
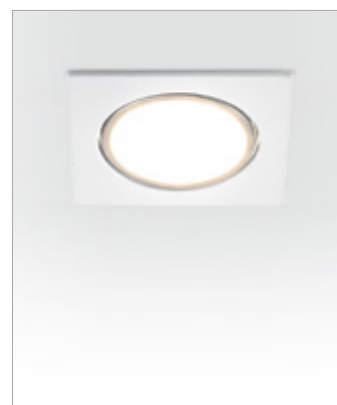
**.01** Bianco - White**.21** Dorato lucido
Shiny golded**.31** Cromato
Chromed**.32** Nickel satinato
Nickel mat**MODUS** LED**6421** Modus LED

- .01** Bianco - White
- .21** Dorato lucido - Shiny golded
- .31** Cromato - Chromed
- .32** Nickel satinato - Nickel mat

	Color temperature	LED Light source	lm source
/W	4000K	24V 4W	658lm
/WW	3000K	24V 4W	608lm
/XW	2700K	24V 4W	562lm



0,07 Kg

Solo collegamento in parallelo 24V
Only parallel connection 24V

6 cm

**.01** Bianco - White**.21** Dorato lucido
Shiny golded**.31** Cromato
Chromed**.32** Nickel satinato
Nickel mat**Accessori - Accessories****0232**

Cassaforma da parete
Wall plastic box

Drivers

Cod.	Drivers ON/OFF		DIMMABLE drivers	
	0155	0156	0717/DIM60V	00717/DIM60
	24V - 13W	24V - 25W	1...10V	DALI - PUSH
6365	1-2	1-5	1-6	1-6
6398	1-2	1-5	1-6	1-6

Solo collegamento in parallelo - Only parallel connection

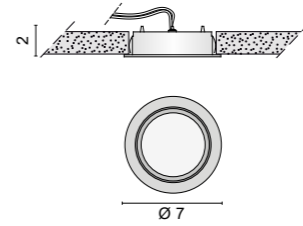
**6251** Zen

- .01** Bianco - White
- .21** Dorato lucido - Shiny golded
- .31** Cromato - Chromed
- .32** Nickel satinato - Nickel mat

Light sources	
12V G4	
F	III

0,07 Kg

6 cm

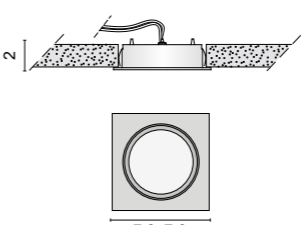
**.01** Bianco - White**.21** Dorato lucido
Shiny golded**.31** Cromato
Chromed**.32** Nickel satinato
Nickel mat**MODUS****6265** Modus

- .01** Bianco - White
- .21** Dorato lucido - Shiny golded
- .31** Cromato - Chromed
- .32** Nickel satinato - Nickel mat

Light sources	
12V G4	
F	III

0,07 Kg

6 cm

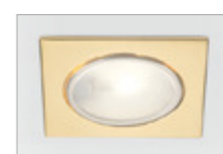
**.01** Bianco - White**.21** Dorato lucido
Shiny golded**.31** Cromato
Chromed**.32** Nickel satinato
Nickel mat

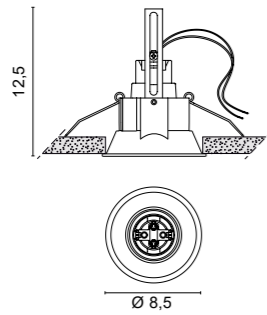

6561 Tappo Edison
.01 Bianco - White
.31 Cromato - Chromed
.38 Ramato lucido - Shiny copper

Light sources
 E27 LED max 7W

0,22 Kg

7,9 cm

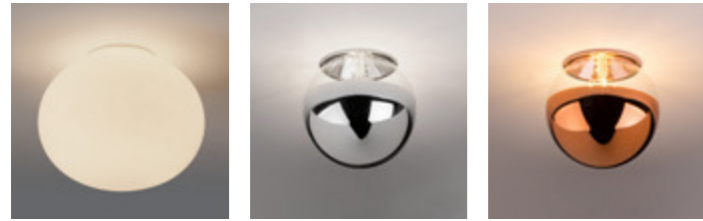

6561.01 Bianco - White + **01LP6** **6561.31** Cromato - Chromed + **01LC1** **6561.38** Rame lucido - Shiny copper + **01LC2**



TAPPO EDISON con lampadina **01LP6** - TAPPO EDISON with bulb **01LP6**

GEKO EDISON

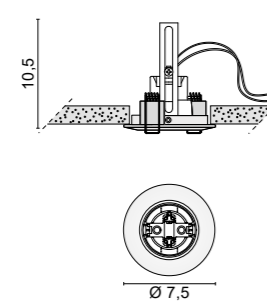

6560 Geko Edison
.01 Bianco - White
.31 Cromato - Chromed

Light sources
 E27 LED

0,15 Kg

6,6 cm



6560.01 Bianco - White + **01LP2** **6560.31** Cromato - Chromed + **01LCR3** **6560.01** Bianco - White + **01LP7** **6560.31** Cromato - Chromed + **01LCR1** **6560.31** Cromato - Chromed + **01LCO1** **6560.01** Bianco - White + **01LCO4**

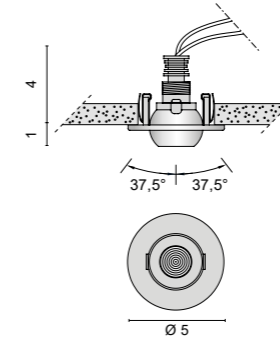

6324 Okkio
.01 Bianco - White
.21 Dorato lucido - Shiny golded
.31 Cromato - Chromed
.32 Nickel satinato - Nickel mat

Color temperature	Optics	LED Light source	lm source
/W 4000K	/11 /25 /45	1W 350mA	158lm
/WW 3000K	/11 /25 /45	1W 350mA	150lm
/XW 2700K	/11 /25 /45	1W 350mA	143lm

IP 40

0,09 Kg

4,5 cm

Drivers

Cod.	Drivers ON/OFF	
	0125	0128
	350mA	350mA
6324	1-6	1-10

Solo collegamento in serie - Only serial connection

DIMMABLE drivers			
0141/DIM	0141/DALI	0145/DALI	0145
PUSH - 1...10V	DIM DALI	DIM DALI	DIM
1-12	1-12	1-21	1-21

DIMMABLE drivers wireless **Casambi 0145/CASA**

1-21

SNORKY INCASSO

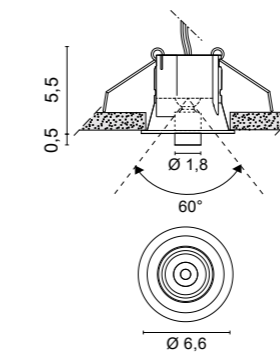

6698 Snorky Incasso
.01 Bianco - White
.02 Nero - Black

Color temperature	Optics	LED Light source	lm source
/W 4000K	/15 /25 /45	1,5W 500mA	221lm
/WW 3000K	/15 /25 /45	1,5W 500mA	210lm
/XW 2700K	/15 /25 /45	1,5W 500mA	199lm

IP 40

0,12 Kg

5,9 cm

Accessori - Accessories



0221
 Plaster kit traforato 12,5 x 9
 Plaster kit perforated 12,5 x 9



Drivers

Cod.	Drivers ON/OFF
	0127
	500mA
6298	1-6

Solo collegamento in serie - Only serial connection

DIMMABLE drivers			
0141/DIM	0141/DALI	0145	0145/DALI
PUSH - 1...10V	DIM DALI	DIM	DIM DALI
1-11 (500mA)	1-11 (500mA)	1-21	1-21

Casambi
0145/CASA
1-21

CORNO MINI 230V

Spots

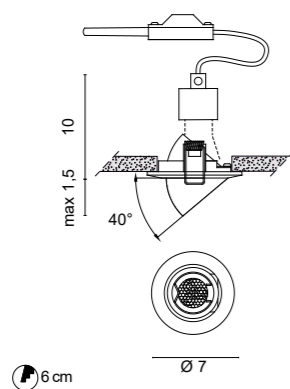

6238 Corno Mini 230V

- .01 Bianco - White
- .21 Dorato lucido - Shiny golded
- .31 Cromato - Chromed
- .32 Nickel satinato - Nickel mat

Light sources
3W GU10 LED Ø 3,5 cm (cod. 0093/19)



CORNO 12V

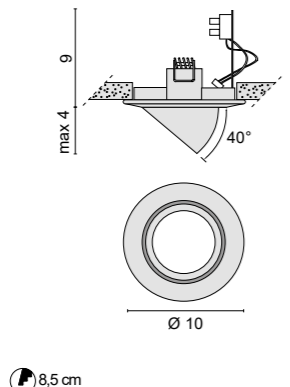

6240 Corno 12V

- .01 Bianco - White
- .21 Dorato lucido - Shiny golded
- .31 Cromato - Chromed
- .32 Nickel satinato - Nickel mat

Light sources
12V GU 5,3



CORNO 230V

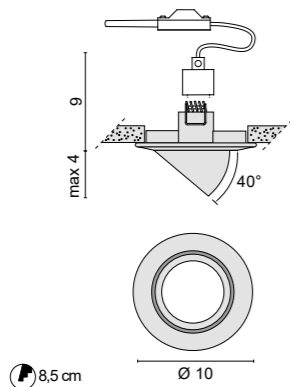

6241 Corno 230V

- .01 Bianco - White
- .21 Dorato lucido - Shiny golded
- .31 Cromato - Chromed
- .32 Nickel satinato - Nickel mat

Light sources
7W GU10 LED DIM (cod. 0104/..)
7W GU10 LED (cod. 0094/..)



EOS PIU'

Spots

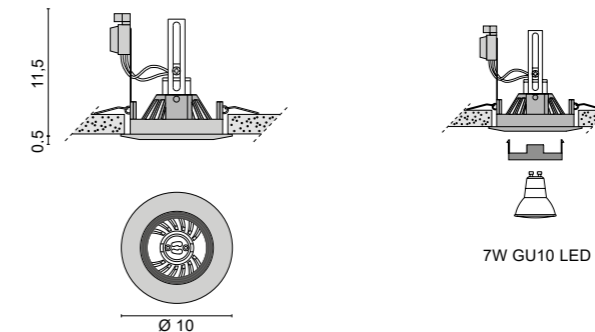

6263 Eos Più

- .01 Bianco - White
- .21 Dorato lucido - Shiny golded
- .31 Cromato - Chromed
- .32 Nickel satinato - Nickel mat

Light sources
7W GU10 LED DIM (cod. 0104/..)
7W GU10 LED (cod. 0094/..)



GAMMA

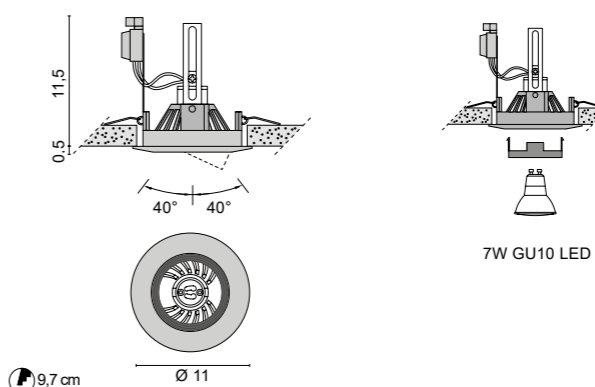

6249 Gamma

- .01 Bianco - White
- .21 Dorato lucido - Shiny golded
- .31 Cromato - Chromed
- .32 Nickel satinato - Nickel mat

Light sources
7W GU10 LED DIM (cod. 0104/..)
7W GU10 LED (cod. 0094/..)



STELLA

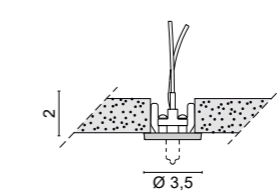
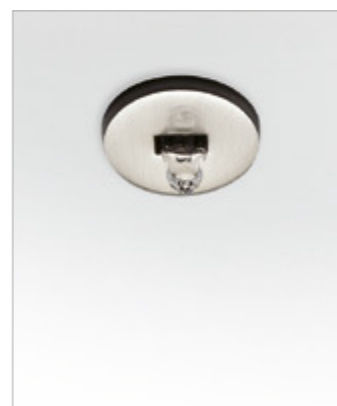

6204 Stella

- .01 Bianco - White
- .02 Nero - Black
- .21 Dorato lucido - Shiny golded
- .31 Cromato - Chromed
- .32 Nickel satinato - Nickel mat

Light sources
12V G4



SPECCHIO INCASSO

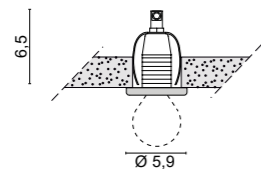
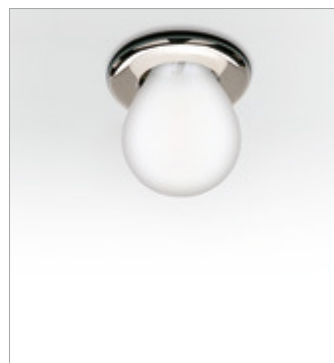

6024 Specchio incasso

- .01** Bianco - White
- .31** Cromato - Chromed
- .32** Nickel satinato - Nickel mat

Light sources

6W E14 LED (cod. 0105/MINI)



0,07 Kg

4,5 cm

Spots



- .01** Bianco - White
- .31** Cromato - Chromed
- .32** Nickel satinato - Nickel mat

SPECCHIO CORTO

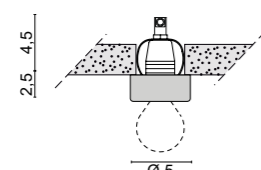

6030 Specchio corto

- .01** Bianco - White
- .31** Cromato - Chromed
- .32** Nickel satinato - Nickel mat

Light sources

6W E14 LED (cod. 0105/MINI)



0,07 Kg

3,5 cm



- .01** Bianco - White
- .31** Cromato - Chromed
- .32** Nickel satinato - Nickel mat

SPECCHIO LUNGO

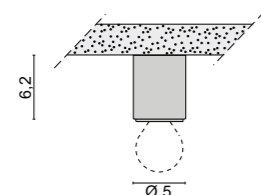

6028 Specchio lungo

- .01** Bianco - White
- .31** Cromato - Chromed
- .32** Nickel satinato - Nickel mat

Light sources

6W E14 LED (cod. 0105/MINI)



0,10 Kg



- .01** Bianco - White
- .31** Cromato - Chromed
- .32** Nickel satinato - Nickel mat



Spots

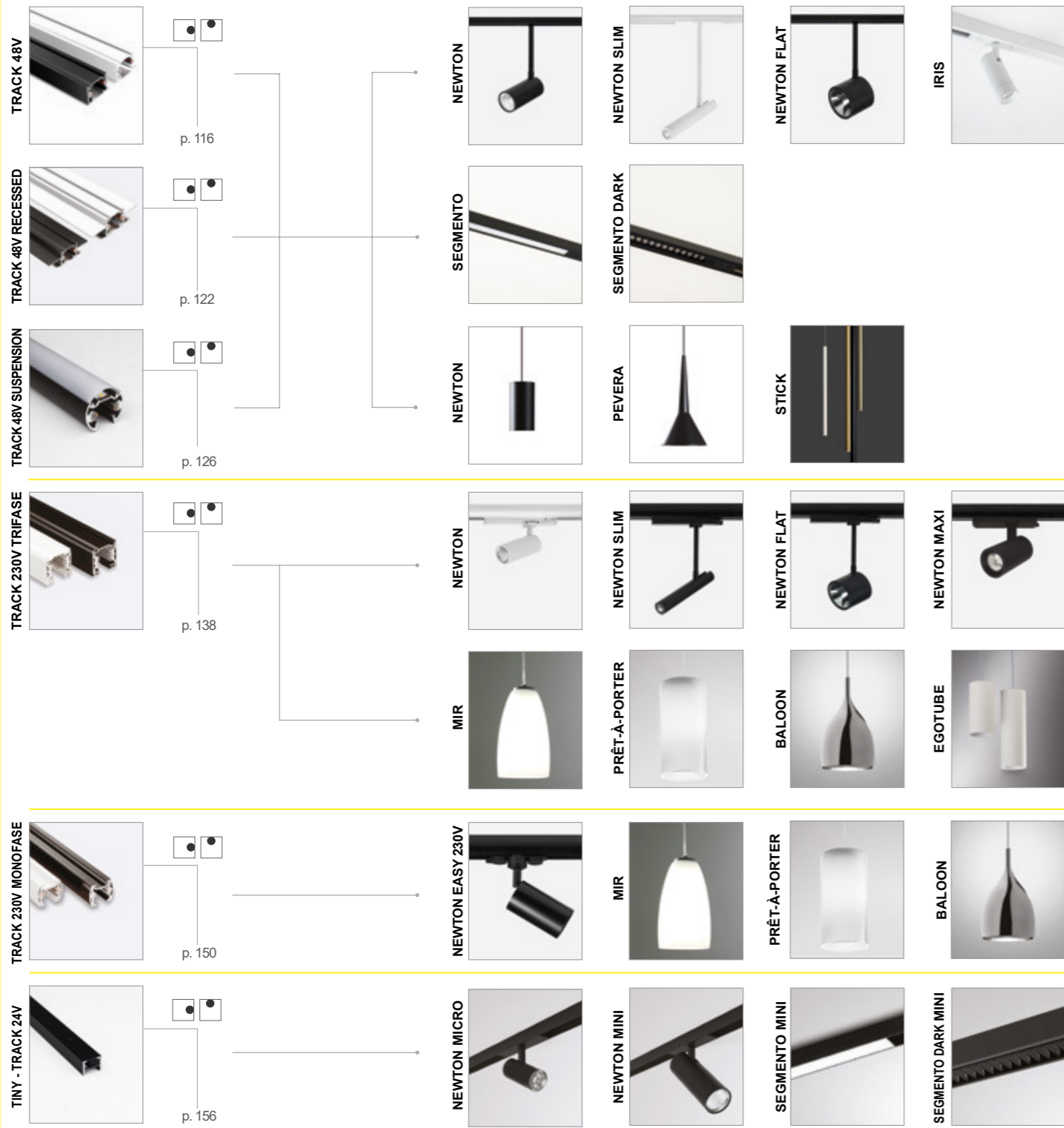

TRACK

Sistemi di binari elettrificati con alimentazione a tensione di rete, 230V, o a bassa tensione, 48V e 24V.

Electrified track systems powered by mains voltage, 230V, or low voltage, 48V and 24V.

Systèmes de voie électrifiés alimentés par tension secteur, 230V, ou basse tension, 48V et 24V.

Sistemas de vía electrificada alimentados con tensión de red, 230V, o baja tensión, 48V y 24V.

Elektrifizierte Schienensysteme, die mit Netzspannung, 230 V, oder Niederspannung, 48 V und 24 V, betrieben werden.

Электрифицированные рельсовые системы с питанием от сети 230В или низкого напряжения 48В и 24В.

- Al tradizionale binario trifase a tensione di rete, ora di sezione quadrata, si affianca il più piccolo binario monofase più facile da inserire anche in ambienti domestici.
- Le proposte a 48V con tipologia plafone/parete o a incasso si completano con il nuovo sistema a sospensione a luce indiretta.
- La collezione EGOLUCE si arricchisce anche di un nuovissimo sistema a 24V, TINY, caratterizzato dalle ridotte dimensioni e di microscopici corpi illuminanti ad inserimento magnetico.

- The traditional three-phase mains voltage track, now with a square section, is joined by the smaller single-phase track, which is easier to insert even in domestic environments.
- The 48V ceiling/wall or recessed versions are completed with the new indirect light suspension system.
- The EGOLUCE collection is also enriched by a brand new 24V system, TINY, characterized by its small size and microscopic magnetic insertion lighting fixtures.

- À la traditionnelle voie de tension secteur triphasée, désormais à section carrée, s'ajoute la voie monophasée plus petite, plus facile à insérer même dans les environnements domestiques.
- Les versions plafonnier/mur ou encastré 48V sont complétées par le nouveau système de suspension à lumière indirecte.
- La collection EGOLUCE s'enrichit également d'un tout nouveau système 24V, TINY, caractérisé par sa petite taille et ses luminaires à insertion magnétique microscopique.

- Al tradicional carril trifásico de tensión de red, ahora de sección cuadrada, se le une el carril monofásico de menor tamaño y más fácil de insertar incluso en entornos domésticos.
- Las versiones de 48V de techo/pared o de empotrar se completan con el nuevo sistema de suspensión de luz indirecta.
- La colección EGOLUCE también se enriquece con un nuevo sistema de 24V, TINY, que se caracteriza por sus pequeñas dimensiones y luminarias microscópicas de inserción magnética.

- Zur traditionellen dreiphasigen Netzspannungsschiene, jetzt mit quadratischem Querschnitt, gesellt sich die kleinere einphasige Stromschiene, die sich auch in Wohnumgebungen einfacher einführen lässt.
- Die 48-V-Decken-/Wand- oder Einbauversionen werden mit dem neuen Aufhängungssystem für indirektes Licht vervollständigt.
- Die EGOLUCE-Kollektion wird auch durch ein brandneues 24-V-System, TINY, bereichert, das sich durch seine geringe Größe und mikroskopische magnetische Einsteckleuchten auszeichnet.

- Традиционная трехфазная шина сетевого напряжения, теперь имеющая квадратное сечение, соединяется с однофазной шиной меньшего размера, которую легче прокладывать даже в бытовых условиях.
- Потолочные/настенные или встраиваемые версии на 48 В дополнены новой системой подвески непрямого света.
- Коллекция EGOLUCE также обогащена совершенно новой системой 24V TINY, отличающейся небольшими размерами и микрооптическими светильниками с магнитной вставкой.

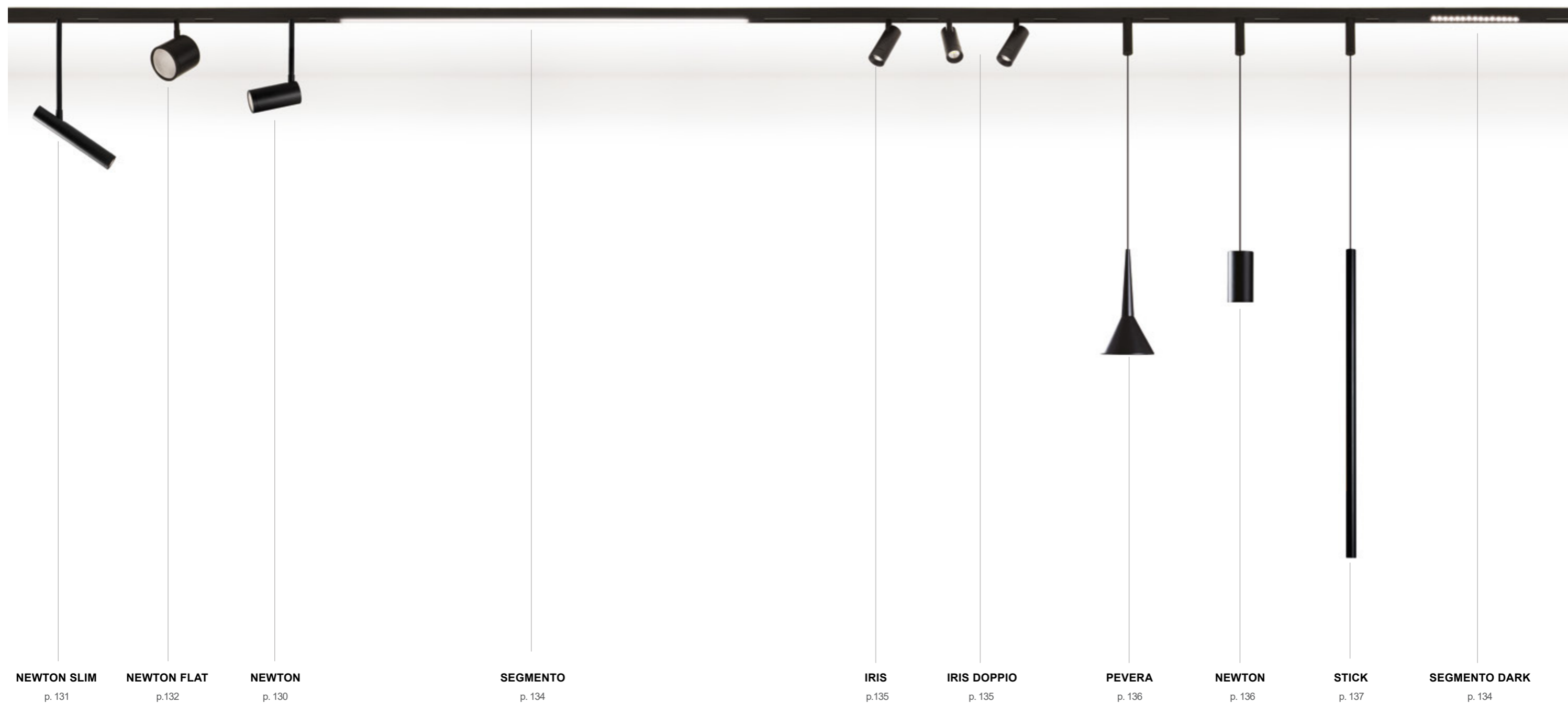

NEWTON SLIM
p. 131

NEWTON FLAT
p.132

NEWTON
p. 130

SEGMENTO
p. 134

IRIS
p.135

IRIS DOPPIO
p. 135

PEVERA
p. 136

NEWTON
p. 136

STICK
p. 137

SEGMENTO DARK
p. 134

TRACK 48V

Le proposte di binari elettrificati a bassa tensione a 48V rappresentano l'evoluzione tecnica dei binari a tensione di rete. I vantaggi nella scelta di questo tipo di binario risiedono principalmente nella dimensione ridotta che ne consente l'utilizzo in qualsiasi tipo di ambiente.

A questo va aggiunta l'eleganza minimalista dei corpi proposti da EGOLUCE, dai piccoli proiettori orientabili per la luce d'accento, ai corpi lineari inseriti nel profilo per una illuminazione diffusa, fino a sospensioni tecniche o decorative.

FINITURE DISPONIBILI:

- .01 bianco
- .02 nero

Il binario a 48V necessita di un alimentatore dedicato, da ordinare separatamente, e dimensionato in funzione degli elementi illuminanti che si decide di utilizzare.

The 48V low voltage electrified tracks represent the technical evolution of mains voltage tracks. The advantages in choosing this type of track lie mainly in the small size which allows it to be used in any type of environment.

To this must be added the minimalist elegance of the bodies proposed by EGOLUCE, from the small adjustable projectors for accent light, to the linear bodies inserted in the profile for diffused lighting, up to technical or decorative suspensions.

AVAILABLE FINISHES:

- .01 white
- .02 black

The 48V track requires a dedicated driver, to be ordered separately, and sized according to the lighting elements you decide to use.

Les voies électrifiées basse tension 48V représentent l'évolution technique des voies tension secteur. Les avantages à choisir ce type de chenille résident principalement dans la petite taille qui permet de l'utiliser dans tout type d'environnement.

À cela, il faut ajouter l'élégance minimaliste des corps proposés par EGOLUCE, des petits projecteurs orientables pour la lumière d'accentuation, aux corps linéaires insérés dans le profil pour un éclairage diffus, jusqu'aux suspensions techniques ou décoratives.

FINITIONS DISPONIBLES:

- .01 blanc
- .02 noir

Le rail 48V nécessite une alimentation dédiée, à commander séparément, et dimensionnée en fonction des éléments d'éclairage que vous décidez d'utiliser.

Las vías electrificadas de baja tensión de 48V representan la evolución técnica de las vías de tensión de red. Las ventajas de elegir este tipo de pista radican principalmente en el pequeño tamaño que permite su uso en cualquier tipo de entorno.

A ello hay que añadir la elegancia minimalista de los cuerpos que propone EGOLUCE, desde los pequeños proyectores orientables para luz de acento, pasando por los cuerpos lineales insertados en el perfil para iluminación difusa, hasta las suspensiones técnicas o decorativas.

ACABADOS DISPONIBLES:

- .01 blanco
- .02 negro

El carril de 48V requiere una fuente de alimentación dedicada, que se pide por separado, y dimensionada según los elementos de iluminación que decidas utilizar.

Die 48V-Niedervolt-Elektrogleise stellen die technische Weiterentwicklung der Netzspannungsgleise dar. Die Vorteile bei der Wahl dieses Schienentyps liegen hauptsächlich in der geringen Größe, die den Einsatz in jeder Art von Umgebung ermöglicht.

Dazu muss die minimalistische Eleganz der von EGOLUCE vorgeschlagenen Körper hinzugefügt werden, von den kleinen verstellbaren Projektoren für Akzentlicht über die in das Profil eingesetzten linearen Körper für diffuses Licht bis hin zu technischen oder dekorativen Aufhängungen.

VERFÜGBARE AUSFÜHRUNGEN:

- .01 weiß
- .02 schwarz

Für die 48-V-Schiene ist ein separates Netzteil erforderlich, das separat bestellt und entsprechend den Beleuchtungselementen bemessen werden muss, die Sie verwenden möchten.

Электрифицированные пути низкого напряжения 48 В представляют собой техническую эволюцию путей сетевого напряжения. Преимущества выбора этого типа гусениц заключаются в основном в небольшом размере, который позволяет использовать его в любых условиях.

К этому следует добавить минималистскую элегантность корпусов, предлагаемых EGOLUCE, от небольших регулируемых прожекторов для акцентного света до линейных корпусов, вставленных в профиль для рассеянного освещения, до технических или декоративных подвесов.

ДОСТУПНЫЕ ОТДЕЛКИ:

- .01 белый
- .02 черный

Для трека 48 В требуется специальный источник питания, который заказывается отдельно, и его размер соответствует элементам освещения, которые вы решите использовать.

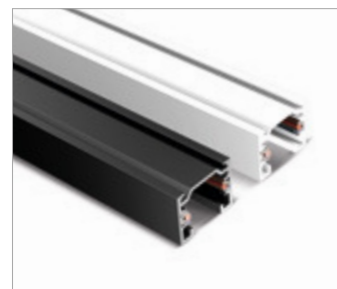

Binari elettrificati a bassa tensione 48V per applicazioni a soffitto, a parete, a sospensione.
I due conduttori per 48V portano, a richiesta, anche il segnale DALI consentendo la regolazione dinamica della luce.

48V low voltage electrified tracks for ceiling, wall, suspensions applications.
The two 48V conductors can transmit, upon request, also DALI signal, allowing for the light dynamic control.

- 7341** Binario 48V (20A) 1 mt - Track 48V (20A) 1 mt
 - .01 Bianco - White
 - .02 Nero - Black
- 7342** Binario 48V (20A) 2 mt - Track 48V (20A) 2 mt
 - .01 Bianco - White
 - .02 Nero - Black
- 7343** Binario 48V (20A) 3 mt - Track 48V (20A) 3 mt
 - .01 Bianco - White
 - .02 Nero - Black

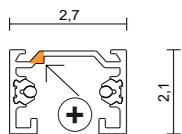

Per una corretta installazione è importante seguire la continuità della linea di positivo di ogni elemento.
The continuity of the positive line between each element is important for a correct installation.

Esempio di configurazione - Configuration example

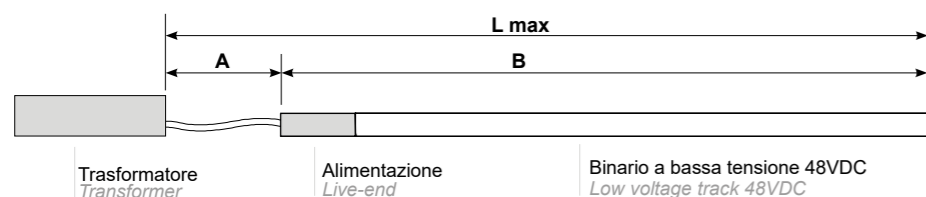
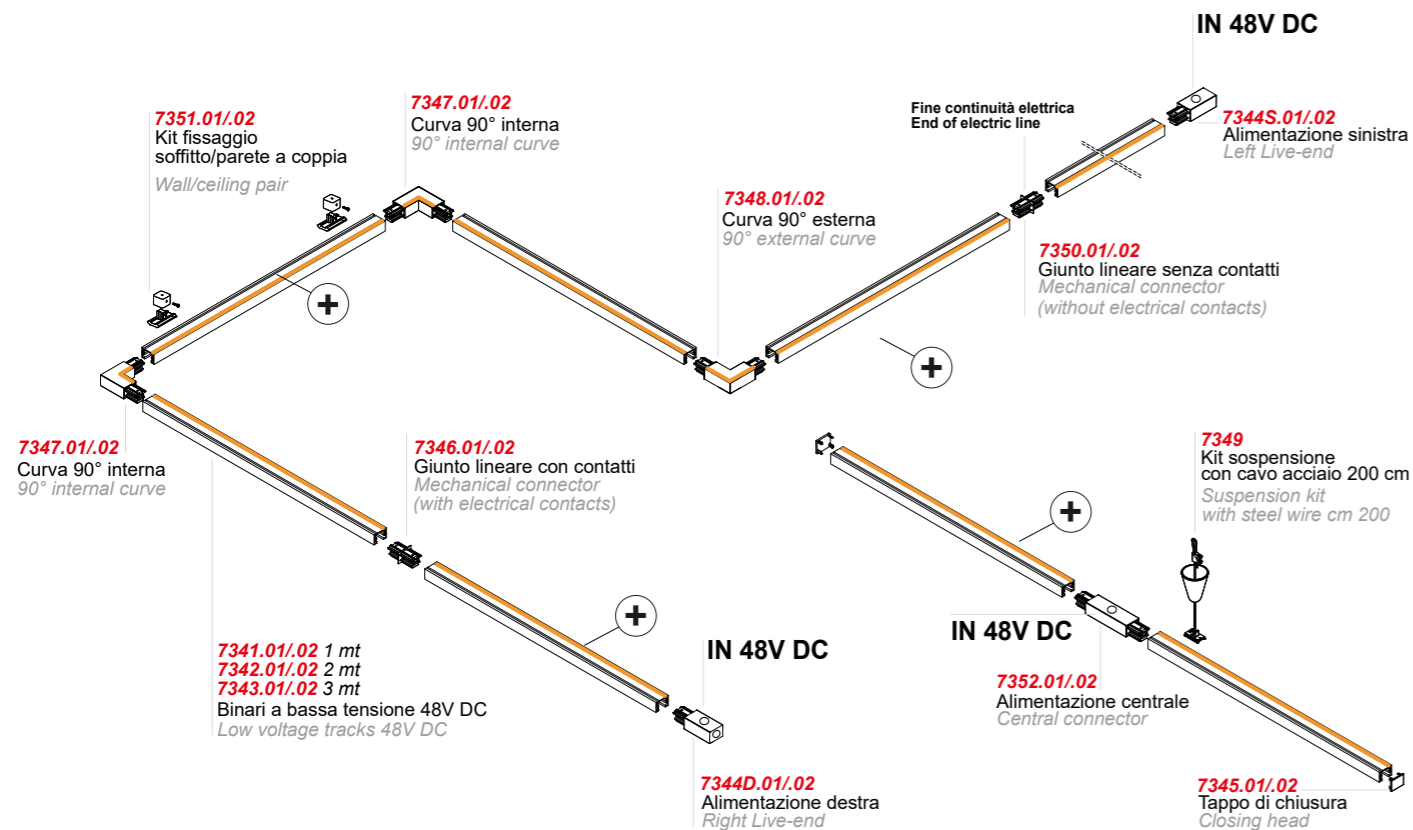

L max = A+B ≤ 30 mt
A = Cavo di alimentazione 2 x 4 mm² - Power supply cable 2 x 4 mm²
B = Binario - Track

P (W)	I (A)	L max
300	6,5	≤ 30mt
150	3,2	
75	1,6	



Accessori - Accessories

- 7344S** Alimentazione sinistra (Left Live-end)
 - .01 Bianco - White
 - .02 Nero - Black
- 7345** Tappo di chiusura (Closing head)
 - .01 Bianco - White
 - .02 Nero - Black
- 7346** Giunto lineare con contatti (with electrical contacts)
 - .01 Bianco - White
 - .02 Nero - Black
- 7347** Curva 90° interna (90° internal curve)
 - .01 Bianco - White
 - .02 Nero - Black
- 7348** Curva 90° esterna (90° external curve)
 - .01 Bianco - White
 - .02 Nero - Black
- 7349** Kit sospensione (cavo 200 cm) (Suspension kit (cable 200 cm))
 - .01 Bianco - White
 - .02 Nero - Black
- 7350** Giunto lineare senza contatti (without electrical contacts)
 - .01 Bianco - White
 - .02 Nero - Black
- 7351** Kit soffitto-parete a coppia (Ceiling wall pair)
 - .01 Bianco - White
 - .02 Nero - Black
- 7352** Alimentazione centrale (Central Connector)
 - .01 Bianco - White
 - .02 Nero - Black
- 7355** Giunto T destro (Right T joint)
 - .01 Bianco - White
 - .02 Nero - Black
- 7356** Giunto T sinistro (Left T joint)
 - .01 Bianco - White
 - .02 Nero - Black
- 7368** Copertura binario 100 cm (Track cover 100 cm)
 - .01 Bianco - White
 - .02 Nero - Black

Rosoni con driver per installazione a plafone - Testata di alimentazione art. 7344S/D non inclusa.
La scelta del rosone deve essere fatta sommando il carico dei prodotti utilizzati sul binario. Quest'ultimo è dato dalla somma dell'assorbimento della sorgente LED a quella dell'adattatore, 3W circa.

Ceiling roses with driver for ceiling installation - Live end 7344S/D not included.
The choice of the ceiling rose must be made by adding the load of the products used on the track. The latter is given by the sum of the absorption of the LED source and that of the adapter, approximately 3W.

0715/48

Rosone con driver (Ceiling rose with driver)
 IN: 220 - 240V
 OUT: 48V - 60W
 ON-OFF
 DIM1...10V
 DIM PUSH

- .01 Bianco - White
- .02 Nero - Black

PUSH **1...10V**

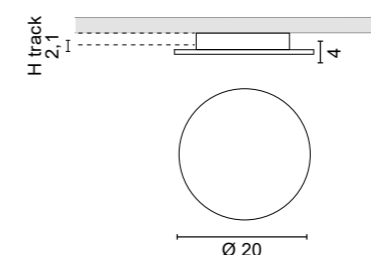

0716/48

Rosone con driver con 1 uscita (Ceiling rose with driver and 1 exit)
 IN: 220 - 240V
 OUT: 48V - 60W
 ON-OFF

0716/48/2

Rosone con driver con 2 uscite (Ceiling rose with driver and 2 exit)
 IN: 220 - 240V
 OUT: 48V - 60W
 ON-OFF

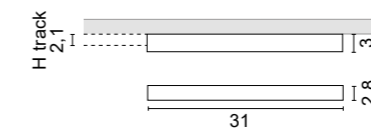

- .01 Bianco - White
- .02 Nero - Black



0715/48
Installazione di testa al binario.
End to track installation.

0716/48/2
Installazione centrale tra due binari.
Central installation between two tracks.



La scelta del rosone e degli alimentatori deve essere fatta sommando il carico dei prodotti utilizzati sul binario. Quest'ultimo è dato dalla somma dell'assorbimento della sorgente LED a quella dell'adattatore, 3W circa.

The choice of the ceiling rose and the drivers must be made by adding the load of the products used on the track. The latter is given by the sum of the absorption of the LED source and that of the adapter, approximately 3W.

Rosoni con driver per installazione a sospensione
Ceiling roses with driver for suspended installation

Code	W	Codici finiture - Finishes codes
0992/150	150W	.01 Bianco - White
0992/150	150W	.02 Nero - Black

IN: 220 - 240V
OUT: 48V - 150W
ON/OFF

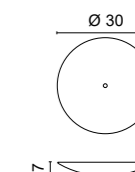

1,30 Kg

Drivers **ON/OFF**

0160/48

IN: 220 - 240V
OUT: 48V - 50W

 SELV

 7 cm

0157/48

IN: 220 - 240V
OUT: 48V - 70/72W

 SELV

 7 cm

0162/48

IN: 220 - 240V
OUT: 48V - 150W

 SELV

 8 cm

Dimmer 48V

Il binario può essere controllato con dimmerazione PUSH, DALI, 1...10V utilizzando i dimmer 0110/DIM o 0110/DIM/MINI. Questi devono essere collegati con gli alimentatori (0160/48, 0157/48, 0162/48) e permettono di dimmerare insieme tutti gli apparecchi installati sul binario.

Dimmerazione DALI del singolo prodotto su richiesta.

The track can be controlled with PUSH, DALI, 1...10V dimming using the dimmers 0110/DIM or 0110/DIM/MINI. These must be installed with the ballasts (0160/48, 0157/48, 0162/48) and allow to dim all the fixtures installed on the track together.

DALI dimming of the single product on request.

0110/DIM

IN: 12/24/48V
OUT: 12/24/48V max 12A
Utilizzabile anche come slave (max 10).
Can be used as a slave (max 10).

  **1...10V**

 4,4 cm

0110/DIM/MINI

IN: 12/24/48V
OUT: 12/24/48V max 5A

  **1...10V**

 2,8 cm

NEWTON SLIM
p. 131

NEWTON FLAT
p. 132

NEWTON
p. 130

SEGMENTO
p. 134

IRIS
p.135

IRIS DOPPIO
p. 135

PEVERA
p. 136

NEWTON
p. 136

STICK
p. 137

SEGMENTO DARK
p. 134

TRACK 48V RECESSED

Il sistema di binario 48V ad incasso in cartongesso garantisce gli stessi vantaggi del binario esterno, riducendo ulteriormente l'impatto visivo del profilo che sparisce e si annulla nel controsoffitto.

Rimangono a vista solo i corpi illuminanti che possono essere spostati a proprio piacimento e collocati nella posizione desiderata. Le proposte vanno dai piccoli proiettori orientabili, ai corpi lineari inseriti nel profilo per una illuminazione diffusa fino a sospensioni tecniche o decorative.

FINITURE DISPONIBILI:

- .01 bianco
- .02 nero

L'installazione del binario è da farsi contestualmente con la posa del controsoffitto.

Il binario a 48V Recessed necessita di un alimentatore dedicato, da ordinare separatamente, e dimensionato in funzione degli elementi illuminanti che si decide di utilizzare.

The 48V recessed track system in plasterboard guarantees the same advantages as the external track, further reducing the visual impact of the profile which disappears and disappears into the false ceiling.

Only the lighting fixtures remain in view and can be moved as you like and placed in the desired position. The proposals range from small adjustable projectors, to linear bodies inserted in the profile for diffused lighting up to technical or decorative suspensions.

AVAILABLE FINISHES:

- .01 white
- .02 black

The installation of the track is to be done at the same time as the installation of the false ceiling.

The 48V Recessed track requires a dedicated driver, to be ordered separately, and sized according to the lighting elements you decide to use.

Le système de rail encastré 48V en plaque de plâtre garantit les mêmes avantages que le rail extérieur, réduisant encore l'impact visuel du profil qui disparaît et disparaît dans le faux plafond.

Seuls les luminaires restent visibles et peuvent être déplacés à votre guise et placés dans la position souhaitée. Les propositions vont des petits projecteurs orientables, aux corps linéaires insérés dans le profil pour un éclairage diffus jusqu'aux suspensions techniques ou décoratives.

FINITIONS DISPONIBLES:

- .01 blanc
- .02 noir

La pose du rail est à faire en même temps que la pose du faux plafond.

Le rail encastré 48V nécessite une alimentation dédiée, à commander séparément, et dimensionnée en fonction des éléments d'éclairage que vous décidez d'utiliser.

El sistema de carril de empotrar en placa de yeso 48V garantiza las mismas ventajas que el carril exterior, reduciendo aún más el impacto visual del perfil que desaparece y desaparece en el falso techo.

Solo las luminarias quedan a la vista y se pueden mover como se desee y colocar en la posición deseada. Las propuestas van desde pequeños proyectores orientables, pasando por cuerpos lineales insertados en el perfil para iluminación difusa hasta suspensiones técnicas o decorativas.

ACABADOS DISPONIBLES:

- .01 blanco
- .02 negro

La instalación del riel se debe realizar al mismo tiempo que la instalación del falso techo.

El riel Empotrable de 48V requiere una fuente de alimentación dedicada, que debe pedirse por separado y dimensionada de acuerdo con los elementos de iluminación que decida utilizar.

Das 48V-Einbauschienensystem aus Gipskarton garantiert die gleichen Vorteile wie die Außenschiene und reduziert die visuelle Wirkung des Profils, das in der Zwischendecke verschwindet und verschwindet.

Nur die Leuchten bleiben im Blick und können beliebig verschoben und in die gewünschte Position gebracht werden. Die Vorschläge reichen von kleinen verstellbaren Strahlern über in das Profil eingesetzte lineare Körper für diffuses Licht bis hin zu technischen oder dekorativen Aufhängungen.

VERFÜGBARE AUSFÜHRUNGEN:

- .01 weiß
- .02 schwarz

Die Installation der Schiene muss gleichzeitig mit der Installation der Zwischendecke erfolgen.

Die 48-V-Einbauschiene erfordert ein spezielles Netzteil, das separat bestellt und entsprechend den Beleuchtungselementen bemessen werden muss, die Sie verwenden möchten.

Встраиваемая система направляющих 48 В из гипсокартона гарантирует те же преимущества, что и внешняя направляющая, дополнительно уменьшая визуальное воздействие профиля, который исчезает и исчезает в подвесном потолке.

На виду остаются только осветительные приборы, которые можно перемещать по своему усмотрению и размещать в нужном положении. Предложения варьируются от небольших регулируемых прожекторов до линейных корпусов, вставленных в профиль для рассеянного освещения, до технических или декоративных подвесов.

ДОСТУПНЫЕ ОТДЕЛКИ:

- .01 белый
- .02 черный

Установку направляющей необходимо производить одновременно с установкой подвесного потолка.

Для встроенной направляющей 48 В требуется специальный источник питания, который заказывается отдельно, а его размер соответствует элементам освещения, которые вы решите использовать.



Binari elettrificati a bassa tensione 48V per installazioni a incasso trimless in controsoffitti. I due conduttori per 48V portano, a richiesta, anche il segnale DALI consentendo la regolazione dinamica della luce.

48V low voltage electrified tracks for trimless recessed installation in false ceilings. The two 48V conductors can transmit, upon request, also DALI signal, allowing for the light dynamic control.

7361 Binario 48V (20A) 1mt - Track 48V (20A) 1 mt
 .01 Bianco - White
 .02 Nero - Black

7362 Binario 48V (20A) 2mt - Track 48V (20A) 2 mt
 .01 Bianco - White
 .02 Nero - Black

7363 Binario 48V (20A) 3mt - Track 48V (20A) 3 mt
 .01 Bianco - White
 .02 Nero - Black

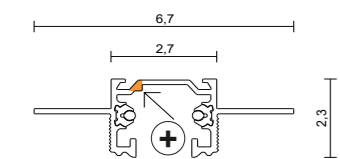

Per una corretta installazione è importante seguire la continuità della linea di positivo di ogni elemento.
 The continuity of the positive line between each element is important for a correct installation.

Esempio di configurazione - Configuration example

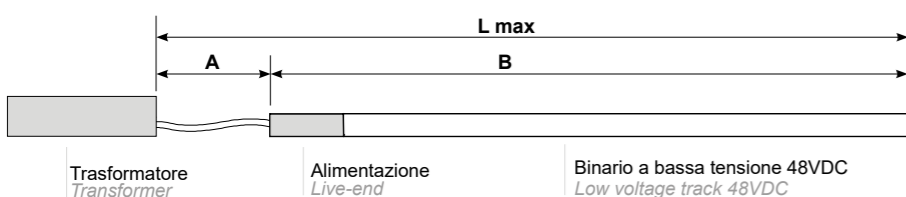
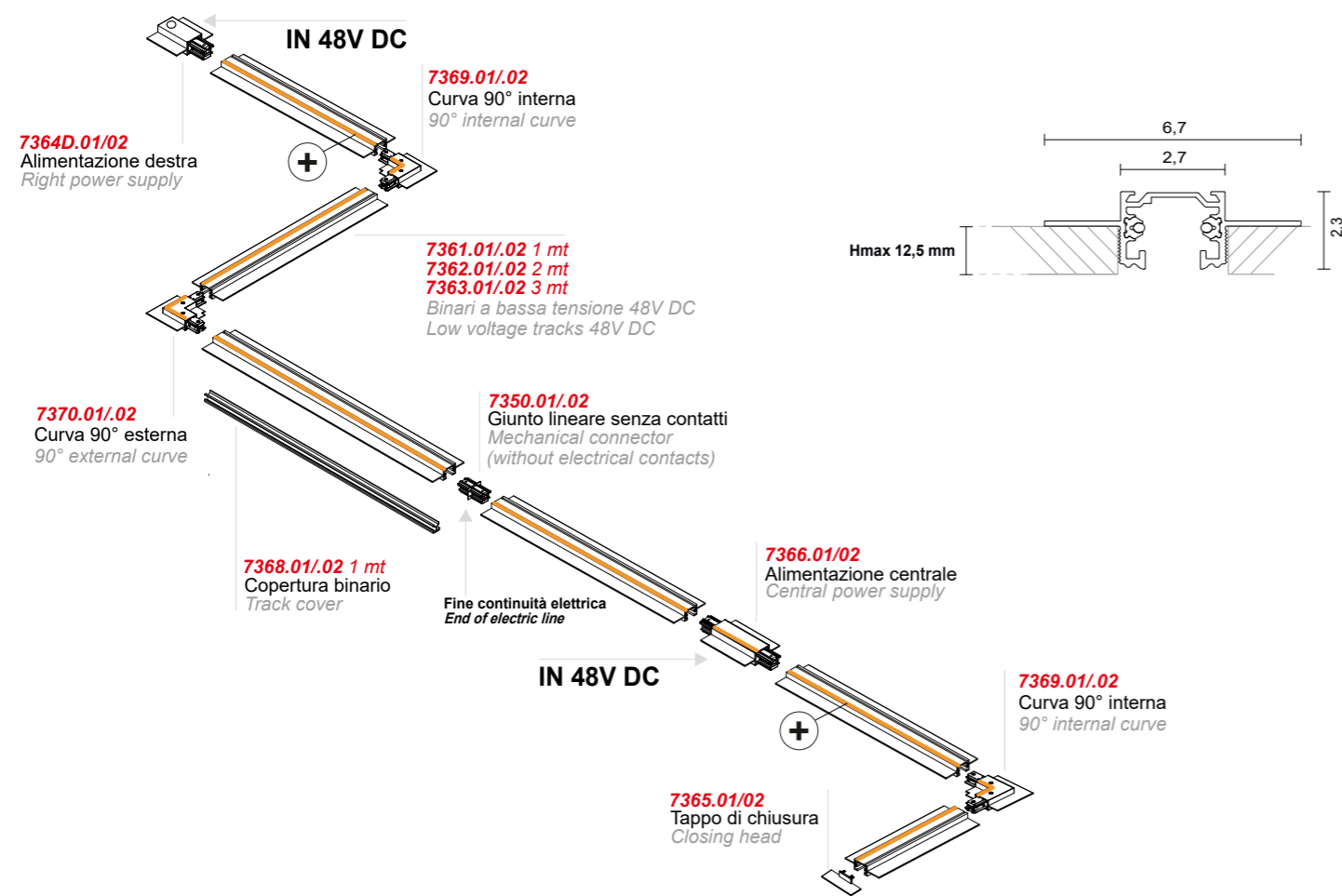

L max = A+B ≤ 30 mt
 A = Cavo di alimentazione 2 x 4 mm² - Power supply cable 2 x 4 mm²
 B = Binario - Track

P (W)	I (A)	L max
300	6,5	≤ 30mt
150	3,2	
75	1,6	

Accessori - Accessories

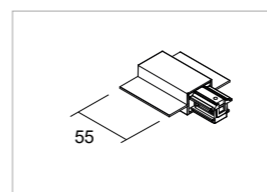

7364S
 Alimentazione sinistra Left Live-end

7364D
 Alimentazione destra Right Live-end
 .01 Bianco - White
 .02 Nero - Black

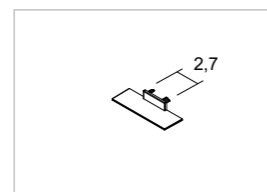

7365
 Tappo di chiusura Closing head
 .01 Bianco - White
 .02 Nero - Black

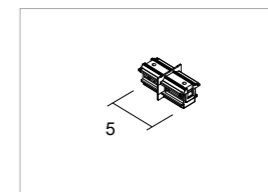

7346
 Giunto lineare con contatti Mechanical connector (with electrical contacts)
 .01 Bianco - White
 .02 Nero - Black

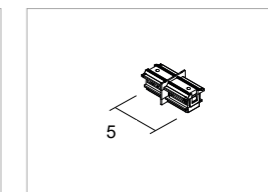

7350
 Giunto lineare senza contatti Mechanical connector (without electrical contacts)
 .01 Bianco - White
 .02 Nero - Black

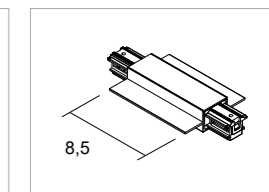

7366
 Alimentazione centrale Central Connector
 .01 Bianco - White
 .02 Nero - Black

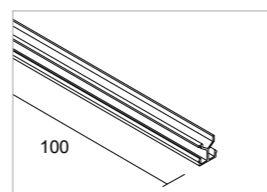

7368
 Copertura binario 1mt Track cover 1mt
 .01 Bianco - White
 .02 Nero - Black

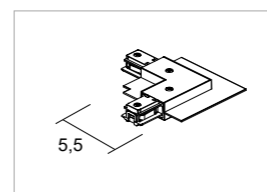

7369
 Curva 90° interna 90° internal curve
 .01 Bianco - White
 .02 Nero - Black

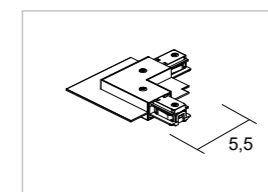

7370
 Curva 90° esterna 90° external curve
 .01 Bianco - White
 .02 Nero - Black

La scelta degli alimentatori deve essere fatta sommando il carico dei prodotti utilizzati sul binario. Quest'ultimo è dato dalla somma dell'assorbimento della sorgente LED a quella dell' adattatore, 3W circa.

The choice of the drivers must be made by adding the load of the products used on the track. The latter is given by the sum of the absorption of the LED source and that of the adapter, approximately 3W.

Drivers ON/OFF

0160/48
 IN: 220 - 240V
 OUT: 48V - 50W

SELV 7 cm

0157/48
 IN: 220 - 240V
 OUT: 48V - 70/72W

SELV 7 cm

0162/48
 IN: 220 - 240V
 OUT: 48V - 150W

SELV 8 cm

Dimmer 48V

Il binario può essere controllato con dimmerazione PUSH, DALI, 1...10V utilizzando i dimmer 0110/DIM o 0110/DIM/MINI. Questi devono essere collegati con gli alimentatori (0160/48, 0157/48, 0162/48) e permettono di dimmerare insieme tutti gli apparecchi installati sul binario.

Dimmerazione DALI del singolo prodotto su richiesta.

The track can be controlled with PUSH, DALI, 1...10V dimming using the dimmers 0110/DIM or 0110/DIM/MINI. These must be installed with the ballasts (0160/48, 0157/48, 0162/48) and allow to dim all the fixtures installed on the track together.

DALI dimming of the single product on request.

0110/DIM
 IN: 12/24/48V
 OUT: 12/24/48V max 12A
 Utilizzabile anche come slave (max 10).
 Can be used as a slave (max 10).

4,4 cm

0110/DIM/MINI
 IN: 12/24/48V
 OUT: 12/24/48V max 5A

2,8 cm

NEWTON SLIM
p. 131

NEWTON FLAT
p. 132

NEWTON
p. 130

SEGMENTO
p. 134

IRIS
p. 135

IRIS DOPPIO
p. 135

PEVERA
p. 136

NEWTON
p. 136

STICK
p. 137

SEGMENTO DARK
p. 134

TRACK 48V SUSPENSION

Il nuovo sistema di binario lineare a 48V sospeso rappresenta una novità della collezione EGOLUCE. Si tratta di un binario sospeso a luce indiretta. Lo schermo opalino garantisce un'illuminazione omogenea del soffitto a 120°.

Nella parte inferiore è invece possibile inserire una vasta gamma di prodotti, da ordinare separatamente: dai piccoli proiettori orientabili per una luce d'accento, ai corpi lineari per una illuminazione diffusa anche verso il basso, fino a sospensioni tecniche o decorative.

FINITURE DISPONIBILI:
• .02 nero

Il binario a 48V SUSPENSION necessita di un alimentatore dedicato, da ordinare separatamente, e dimensionato in funzione degli elementi illuminanti che si decide di utilizzare.

The new linear suspended 48V rail system represents a novelty of the EGOLUCE collection. It is a suspended track with indirect light. The opal screen guarantees homogeneous lighting of the ceiling at 120°.

In the lower part, however, it is possible to insert a vast range of products, to be ordered separately: from small adjustable projectors for accent lighting, to linear bodies for diffused lighting also downwards, up to technical or decorative suspensions.

AVAILABLE FINISHES:
• .02 black

The 48V SUSPENSION track requires a dedicated driver, to be ordered separately, and sized according to the lighting elements you decide to use.

Le nouveau système de rail suspendu 48V représente une nouveauté de la collection EGOLUCE. Il s'agit d'un rail suspendu à lumière indirecte. L'écran opale garantit un éclairage homogène du plafond à 120°.

Dans la partie inférieure, cependant, il est possible d'insérer une vaste gamme de produits, à commander séparément : des petits projecteurs orientables pour l'éclairage d'accentuation, aux corps linéaires pour l'éclairage diffus également vers le bas, jusqu'aux suspensions techniques ou décoratives.

FINITIONS DISPONIBLES:
• .02 noir

Le rail SUSPENSION 48V nécessite une alimentation dédiée, à commander séparément, et dimensionnée en fonction des éléments d'éclairage que vous décidez d'utiliser.

El nuevo sistema de carril suspendido de 48V representa una novedad de la colección EGOLUCE. Es un riel suspendido con luz indirecta. La pantalla opal garantiza una iluminación homogénea del techo a 120°.

En la parte inferior, sin embargo, es posible insertar una amplia gama de productos, que se piden por separado: desde pequeños proyectores orientables para iluminación de acento, pasando por cuerpos lineales para iluminación difusa también hacia abajo, hasta suspensiones técnicas o decorativas.

ACABADOS DISPONIBLES:
• .02 negro

El rail 48V SUSPENSION requiere una fuente de alimentación dedicada, que se pide por separado, y dimensionada en función de los elementos de iluminación que decida utilizar.

Das neue hängende 48V-Schienensystem ist eine Neuheit in der EGOLUCE-Kollektion. Es ist eine hängende Schiene mit indirektem Licht. Der Opalschirm garantiert eine homogene Ausleuchtung der Decke bei 120°.

Im unteren Teil hingegen kann eine große Auswahl an Produkten eingesetzt werden, die separat bestellt werden können: von kleinen verstellbaren Strahlern für Akzentbeleuchtung über lineare Körper für diffuses Licht auch nach unten bis hin zu technischen oder dekorativen Abhängungen.

VERFÜGBARE AUSFÜHRUNGEN:
• .02 schwarz

Die 48V SUSPENSION Schiene erfordert ein spezielles Netzteil, das separat bestellt und entsprechend den Beleuchtungselementen, die Sie verwenden möchten, dimensioniert werden muss.

Новая подвесная рельсовая система 48 В представляет собой новинку коллекции EGOLUCE. Это подвесная дорожка с непрямым освещением. Опаловый экран гарантирует равномерное освещение потолка на 120°.

Однако в нижней части можно вставить широкий спектр продуктов, которые можно заказать отдельно: от небольших регулируемых прожекторов для акцентного освещения до линейных корпусов для рассеянного освещения, а также вниз, до технических или декоративных подвесов.

ДОСТУПНЫЕ ОТДЕЛКИ:
• .02 черный

Для трека SUSPENSION 48V требуется специальный источник питания, который заказывается отдельно, и его размер соответствует элементам освещения, которые вы решите использовать.

Binario sospeso a bassa tensione 48Vdc completo di circuito LED e schermo opalino per un'illuminazione omogenea del soffitto con a 120°. Il sistema è monoaccensione, prevede la contemporanea accensione della luce indiretta e dei prodotti installati sul binario.

Low voltage 48Vdc suspended track complete with LED circuit and opal screen for homogeneous lighting of the ceiling with a 120° angle. The system is single-access, it provides for the simultaneous switching on of the indirect light and of the products installed on the track.

7421 Track 48V suspension

.02 Nero - Black



100cm

Color temperature	LED Light source	lm source
/100/W	4000K 48V 14,4W	1650lm
/100/WW	3000K 48V 14,4W	1551lm
/100/XW	2700K 48V 14,4W	1626lm

200cm

Color temperature	LED Light source	lm source
/200/W	4000K 48V 28,8W	3300lm
/200/WW	3000K 48V 28,8W	3102lm
/200/XW	2700K 48V 28,8W	2852lm

150cm

Color temperature	LED Light source	lm source
/150/W	4000K 48V 21,6W	2475m
/150/WW	3000K 48V 21,6W	2339lm
/150/XW	2700K 48V 21,6W	2139lm

300cm

Color temperature	LED Light source	lm source
/300/W	4000K 48V 43,2W	4950lm
/300/WW	3000K 48V 43,2W	4653lm
/300/XW	2700K 48V 43,2W	4278lm

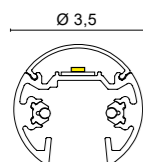

Esempio di configurazione - Configuration example

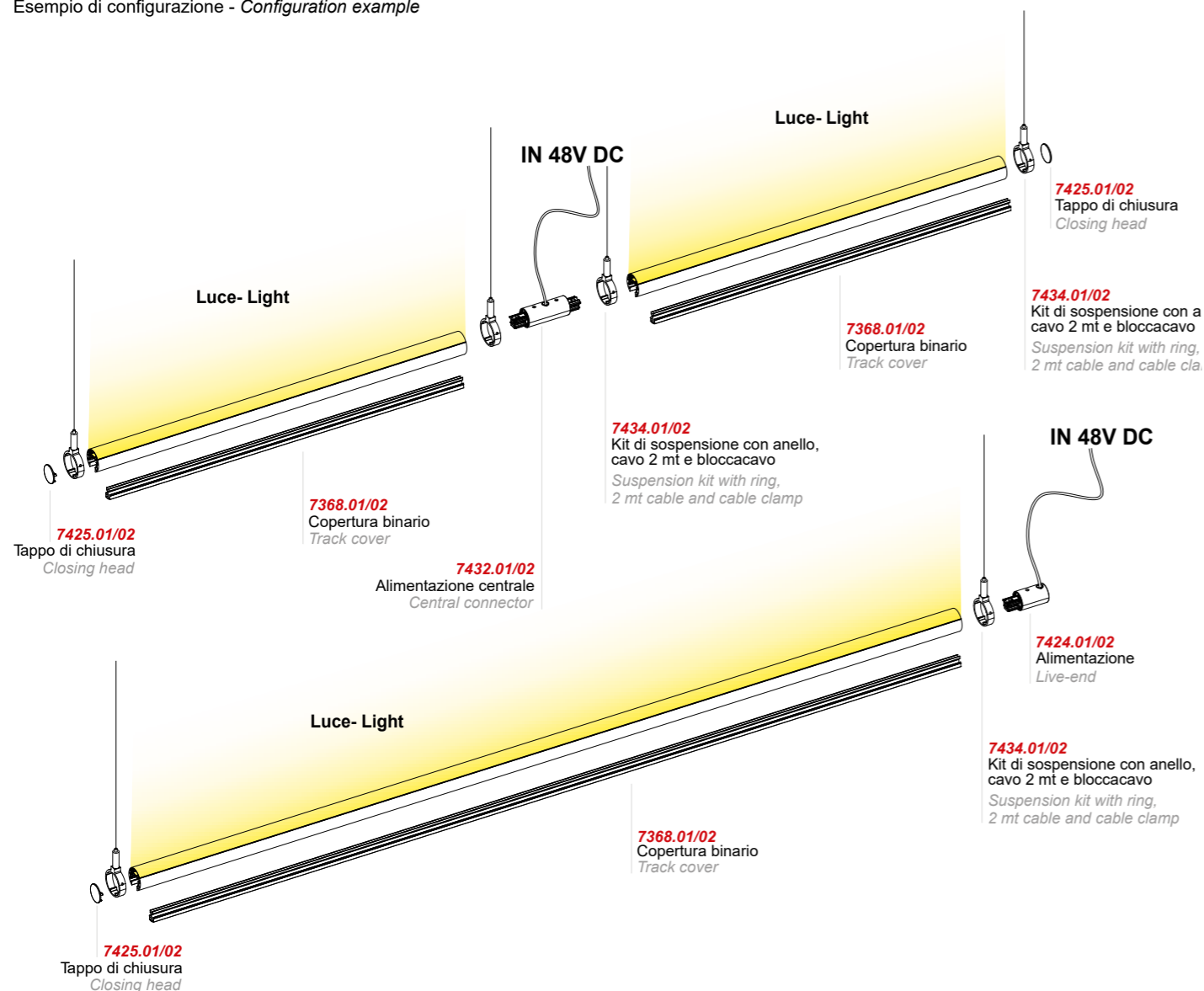

Accessori - Accessories

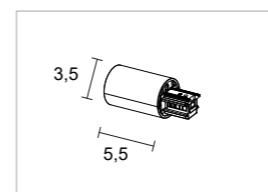

7424S

Alimentazione sinistra
Left Live-end

7424D

Alimentazione destra
Right Live-end

.02 Nero - Black

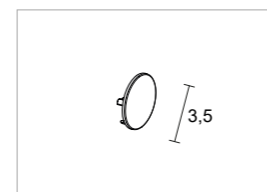

7425

Tappo di chiusura
Closing head

.02 Nero - Black

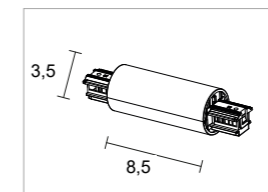

7432

Alimentazione centrale
Central Connector

.02 Nero - Black

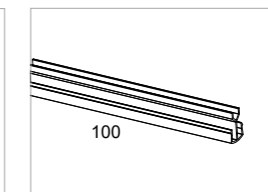

7368

Copertura binario 1mt
Track cover 1mt

.02 Nero - Black

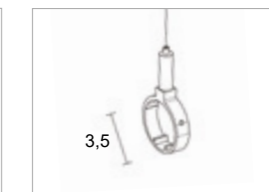

7434

Kit di sospensione con anello,
cavo 2mt e bloccacavo
Suspension kit with ring, 2mt
cable and cable clamp

.02 Nero - Black

La scelta del rosone e dei drivers deve essere fatta sommando il carico della luce indiretta con quello dei prodotti utilizzati sul binario inferiore. Questo ultimo è dato dalla somma dell'assorbimento della sorgente LED a quella dell' adattatore, 3W circa.

The choice of the ceiling rose and drivers must be made by adding the load of the indirect light to that of the products used on the lower track. The latter is given by the sum of the absorption of the LED source and that of the adapter, approximately 3W.

Rosoni con driver per installazione a sospensione
Ceiling roses with driver for suspended installation

Code	W	Codici finiture - Finishes codes
0992/150	150W	.01 Bianco - White
0992/150	150W	.02 Nero - Black

IN: 220 - 240V
OUT: 48V - 150W
ON/OFF

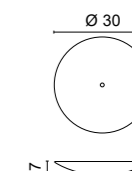

1,30 Kg



Drivers ON/OFF

0160/48

IN: 220 - 240V
OUT: 48V - 50W

SELV 7 cm

0157/48

IN: 220 - 240V
OUT: 48V - 70/72W

SELV 7 cm

0162/48

IN: 220 - 240V
OUT: 48V - 150W

SELV 8 cm

Dimmer 48V

Il binario può essere controllato con dimmerazione PUSH, DALI, 1...10V utilizzando i dimmer 0110/DIM o 0110/DIM/MINI. Questi devono essere collegati con gli alimentatori (0160/48, 0157/48, 0162/48) e permettono di dimmerare insieme tutti gli apparecchi installati sul binario.

Dimmerazione DALI del singolo prodotto su richiesta.

The track can be controlled with PUSH, DALI, 1...10V dimming using the dimmers 0110/DIM or 0110/DIM/MINI. These must be installed with the ballasts (0160/48, 0157/48, 0162/48) and allow to dim all the fixtures installed on the track together.

DALI dimming of the single product on request.

0110/DIM

IN: 12/24/48V
OUT: 12/24/48V max 12A
Utilizzabile anche come slave (max 10).
Can be used as a slave (max 10).

4,4 cm

0110/DIM/MINI

IN: 12/24/48V
OUT: 12/24/48V max 5A

2,8 cm

Track

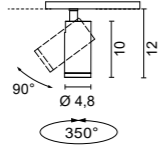
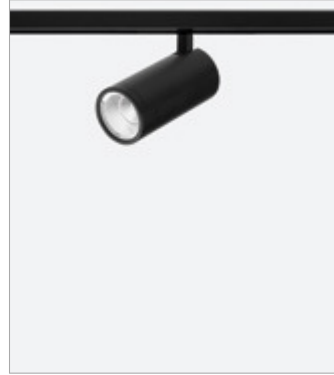

6343 Newton

- .01 Bianco - White
- .02 Nero - Black

Color temperature	Optics	LED light source	lm source	lm output
/W 4000K	/24 /38 /58	48V DC 8,7W	1466lm	1150lm
/W 4000K	/ST Satinato - Satin	48V DC 8,7W	1466lm	1099lm
/WW 3000K	/24 /38 /58	48V DC 8,7W	1424lm	1117lm
/WW 3000K	/ST Satinato - Satin	48V DC 8,7W	1424lm	1068lm
/XW 2700K	/24 /38 /58	48V DC 8,7W	1340lm	1051lm
/XW 2700K	/ST Satinato - Satin	48V DC 8,7W	1340lm	1005lm



0,40 Kg

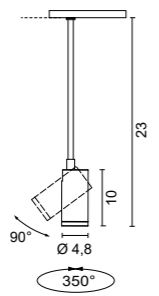
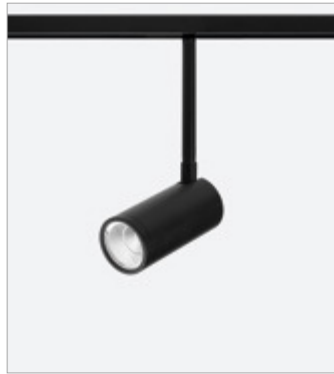

6345 Newton

- .01 Bianco - White
- .02 Nero - Black

Color temperature	Optics	LED light source	lm source	lm output
/W 4000K	/24 /38 /58	48V DC 8,7W	1466lm	1150lm
/W 4000K	/ST Satinato - Satin	48V DC 8,7W	1466lm	1099lm
/WW 3000K	/24 /38 /58	48V DC 8,7W	1424lm	1117lm
/WW 3000K	/ST Satinato - Satin	48V DC 8,7W	1424lm	1068lm
/XW 2700K	/24 /38 /58	48V DC 8,7W	1340lm	1051lm
/XW 2700K	/ST Satinato - Satin	48V DC 8,7W	1340lm	1005lm



0,50 Kg

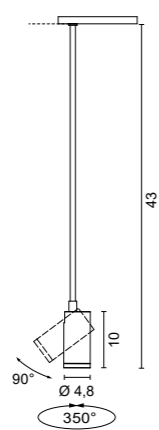

6346 Newton

- .01 Bianco - White
- .02 Nero - Black

Color temperature	Optics	LED light source	lm source	lm output
/W 4000K	/24 /38 /58	48V DC 8,7W	1466lm	1150lm
/W 4000K	/ST Satinato - Satin	48V DC 8,7W	1466lm	1099lm
/WW 3000K	/24 /38 /58	48V DC 8,7W	1424lm	1117lm
/WW 3000K	/ST Satinato - Satin	48V DC 8,7W	1424lm	1068lm
/XW 2700K	/24 /38 /58	48V DC 8,7W	1340lm	1051lm
/XW 2700K	/ST Satinato - Satin	48V DC 8,7W	1340lm	1005lm



0,60 Kg

Accessori - Accessories



0267
Frangilucente - Louvres

- .01 Bianco - White
- .02 Nero - Black



0274
Schermo antiabbagliamento
Anti-glare screen

- .01 Bianco - White
- .02 Nero - Black



Ottiche Disponibili - Available Optics

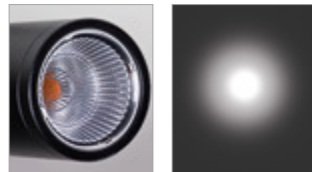

/24
Ottica fascio stretto per luce d'accento
Narrow beam optic for accent lighting



/38
Ottica fascio medio
Medium beam optic

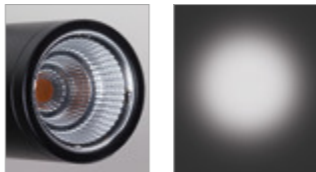

/58
Ottica fascio largo
Wide beam optic



/ST
Ottica fascio diffuso per illuminazione generale
Diffused light optic for general lighting

Track

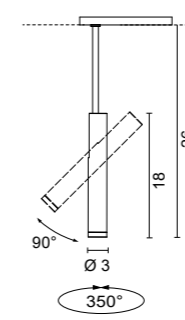

6451 Newton Slim

- .01 Bianco - White
- .02 Nero - Black

Color temperature	Optics	LED light source	lm source	lm output
/W 4000K	/25 /48 /63	48V DC 8,7W	1466lm	1150lm
/W 4000K	/ST Satinato - Satin	48V DC 8,7W	1466lm	1099lm
/WW 3000K	/25 /48 /63	48V DC 8,7W	1424lm	1117lm
/WW 3000K	/ST Satinato - Satin	48V DC 8,7W	1424lm	1068lm
/XW 2700K	/25 /48 /63	48V DC 8,7W	1340lm	1051lm
/XW 2700K	/ST Satinato - Satin	48V DC 8,7W	1340lm	1005lm



0,50 Kg

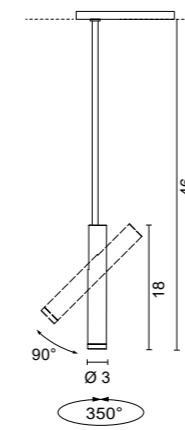

6452 Newton Slim

- .01 Bianco - White
- .02 Nero - Black

Color temperature	Optics	LED light source	lm source	lm output
/W 4000K	/25 /48 /63	48V DC 8,7W	1466lm	1150lm
/W 4000K	/ST Satinato - Satin	48V DC 8,7W	1466lm	1099lm
/WW 3000K	/25 /48 /63	48V DC 8,7W	1424lm	1117lm
/WW 3000K	/ST Satinato - Satin	48V DC 8,7W	1424lm	1068lm
/XW 2700K	/25 /48 /63	48V DC 8,7W	1340lm	1051lm
/XW 2700K	/ST Satinato - Satin	48V DC 8,7W	1340lm	1005lm



0,60 Kg

Accessori - Accessories



0265
Diffusore in vetro Pyrex sabbato
Sand blasted Pyrex glass diffuser

- .01 Ghiera bianca - White ferrule
- .02 Ghiera nera - Black ferrule



0267/S
Frangilucente
Louvres

- .01 Bianco - White
- .02 Nero - Black



Ottiche Disponibili - Available Optics

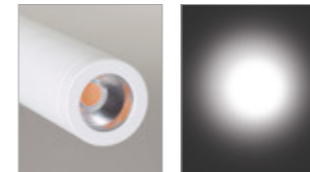

/25
Ottica fascio stretto per luce d'accento
Narrow beam optic for accent lighting

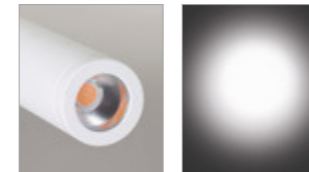

/48
Ottica fascio medio
Medium beam optic

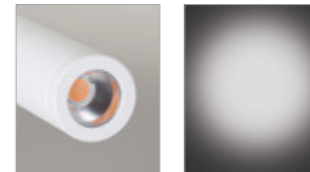

/63
Ottica fascio largo
Wide beam optic

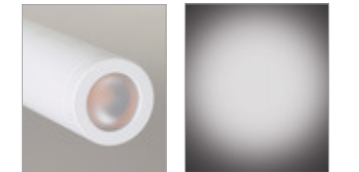

/ST
Ottica fascio diffuso per illuminazione generale
Diffused light optic for general lighting

Track

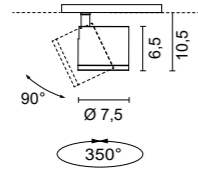
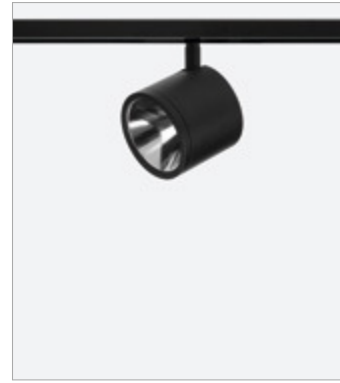

6448 Newton flat

- .01 Bianco - White
- .02 Nero - Black

Color temperature	Optics	LED light source	lm source	lm output
/W 4000K	/13 /40	48V DC 8,7W	1466lm	1150lm
/W 4000K	/ST Satinato - Satin	48V DC 8,7W	1466lm	1099lm
/WW 3000K	/13 /40	48V DC 8,7W	1424lm	1117lm
/WW 3000K	/ST Satinato - Satin	48V DC 8,7W	1424lm	1068lm
/XW 2700K	/13 /40	48V DC 8,7W	1340lm	1051lm
/XW 2700K	/ST Satinato - Satin	48V DC 8,7W	1340lm	1005lm

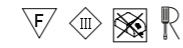

0,50 Kg

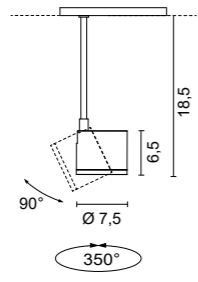

6449 Newton flat

- .01 Bianco - White
- .02 Nero - Black

Color temperature	Optics	LED light source	lm source	lm output
/W 4000K	/13 /40	48V DC 8,7W	1466lm	1150lm
/W 4000K	/ST Satinato - Satin	48V DC 8,7W	1466lm	1099lm
/WW 3000K	/13 /40	48V DC 8,7W	1424lm	1117lm
/WW 3000K	/ST Satinato - Satin	48V DC 8,7W	1424lm	1068lm
/XW 2700K	/13 /40	48V DC 8,7W	1340lm	1051lm
/XW 2700K	/ST Satinato - Satin	48V DC 8,7W	1340lm	1005lm



0,60 Kg

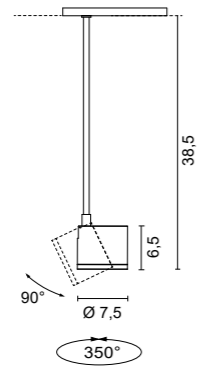
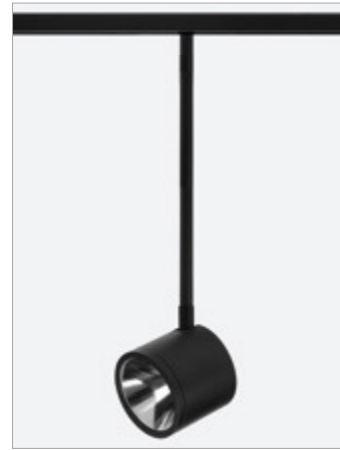

6450 Newton flat

- .01 Bianco - White
- .02 Nero - Black

Color temperature	Optics	LED light source	lm source	lm output
/W 4000K	/13 /40	48V DC 8,7W	1466lm	1150lm
/W 4000K	/ST Satinato - Satin	48V DC 8,7W	1466lm	1099lm
/WW 3000K	/13 /40	48V DC 8,7W	1424lm	1117lm
/WW 3000K	/ST Satinato - Satin	48V DC 8,7W	1424lm	1068lm
/XW 2700K	/13 /40	48V DC 8,7W	1340lm	1051lm
/XW 2700K	/ST Satinato - Satin	48V DC 8,7W	1340lm	1005lm



0,70 Kg

Accessori - Accessories



0264
Parabola decorativa
Decorative parabolic reflector

- .01 Bianco - White
- .02 Nero - Black



Ottiche Disponibili - Available Optics

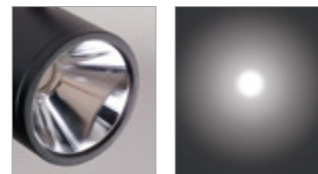

/13
Ottica fascio stretto per luce d'accento
Narrow beam optic for accent lighting

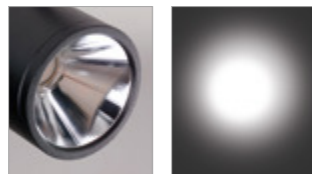

/40
Ottica fascio largo
Wide beam optic



/ST
Ottica fascio diffuso per illuminazione generale
Diffused light optic for general lighting



Track



Track



6699 Segmento

.01	Bianco - White
.02	Nero - Black

Color temperature	LED Light source	lm source
/WW 3000K	48V DC 12W	1292lm
/XW 2700K	48V DC 12W	1162lm

0,35 Kg

6700 Segmento

.01	Bianco - White
.02	Nero - Black

Color temperature	LED Light source	lm source
/WW 3000K	48V DC 19W	2068lm
/XW 2700K	48V DC 19W	1861lm

0,50 Kg

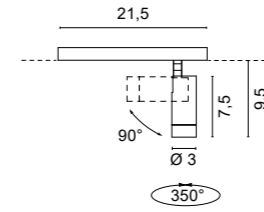
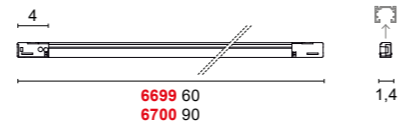

6704 Iris

.01	Bianco - White
.02	Nero - Black

Color temperature	Optics	LED light source	lm source	lm output
/W 4000K	/25 /48 /63	48V DC 5,9W	1060lm	880lm
/W 4000K	/ST Satinato - Satin	48V DC 5,9W	1060lm	816lm
/WW 3000K	/25 /48 /63	48V DC 5,9W	1030lm	855lm
/WW 3000K	/ST Satinato - Satin	48V DC 5,9W	1030lm	793lm
/XW 2700K	/25 /48 /63	48V DC 5,9W	969lm	804lm
/XW 2700K	/ST Satinato - Satin	48V DC 5,9W	969lm	746lm

0,20 Kg

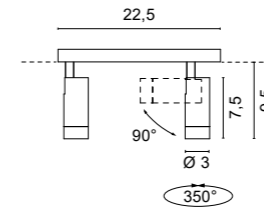

6717 Iris

.01	Bianco - White
.02	Nero - Black

Color temperature	Optics	LED light source	lm source	lm output
/W 4000K	/25 /48 /63	48V DC 11,8W	2120lm	1760lm
/W 4000K	/ST Satinato - Satin	48V DC 11,8W	2120lm	1632lm
/WW 3000K	/25 /48 /63	48V DC 11,8W	2060lm	1710lm
/WW 3000K	/ST Satinato - Satin	48V DC 11,8W	2060lm	1586lm
/XW 2700K	/25 /48 /63	48V DC 11,8W	1938lm	1608lm
/XW 2700K	/ST Satinato - Satin	48V DC 11,8W	1938lm	1492lm

0,30 Kg



6697 Segmento Dark

.02	Nero - Black
-----	--------------

Color temperature	LED Light source	lm source	lm output
/WW 3000K	48V DC 17W	1650lm	1320lm
/XW 2700K	48V DC 17W	1485 lm	1188lm

0,10 Kg

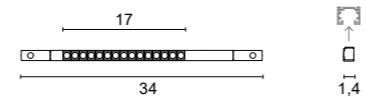

Accessori - Accessories

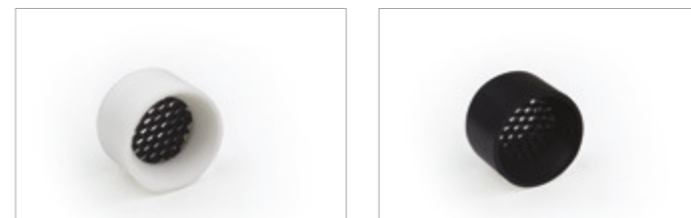

0267/S

Frangiluce
Louvres

.01	Bianco - White
.02	Nero - Black

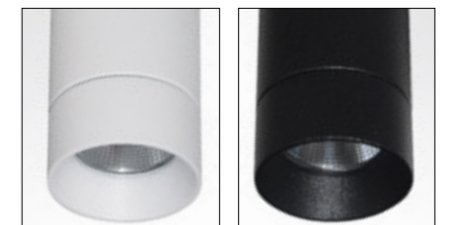

.01 Bianco - White .02 Nero - Black

Track

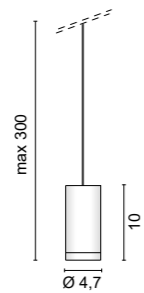

1591 Newton

- .02** Nero - Black
- .25** Dorato satinato - Golded satin
- .32** Nickel satinato - Nickel mat

Adattatore **0987** da ordinate separatamente
Adapters **0987** to be ordered separately

2 elementi per decentramento inclusi
2 displacement component included

	Color temperature	LED light source	Im source	Im output
/W	4000K	5,9W 17V 350mA	1060lm	880lm
/W	4000K	/ST Satinato - Satin	5,9W 17V 350mA	1060lm 816lm
/WW	3000K	5,9W 17V 350mA	1030lm	855lm
/WW	3000K	/ST Satinato - Satin	5,9W 17V 350mA	1030lm 793lm
/XW	2700K	5,9W 17V 350mA	969lm	804lm
/XW	2700K	/ST Satinato - Satin	5,9W 17V 350mA	969lm 746lm



0,50 Kg

Su richiesta fascio di apertura: 24° o 58° - Upon request beam angles: 24° o 58°



0987

IN: 48V
OUT: 350mA DC
Adattatore per binario 48V - 1 lampada
Adapter for 48V track - 1 lamp

- .01** Bianco - White
- .02** Nero - Black



Accessori decorativi - Decorative accessories



1591.02 + 0547.02



1591.02 + 0549.02.00



1591.02 + 0549.02.57



1591.02 + 0547.02 + 0549.02.00



1591.02 + 0547.02 + 0549.02.57

PEVERA

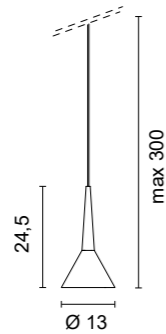

1568 Pevera

- .01** Bianco - White
- .02** Nero - Black
- .05** Rosso - Red

2 elementi per decentramento inclusi
2 displacement component included

	Color temperature	LED Light source	Im source
/W	4000K	6W 17V 350mA	1073lm
/WW	3000K	6W 17V 350mA	1011lm
/XW	2700K	6W 17V 350mA	970lm



0,50 Kg



0987

IN: 48V
OUT: 350mA DC
Adattatore per binario 48V - 1 lampada
Adapter for 48V track - 1 lamp

- .01** Bianco - White
- .02** Nero - Black



Adattatore **0987** da ordinate separatamente
Adapters **0987** to be ordered separately

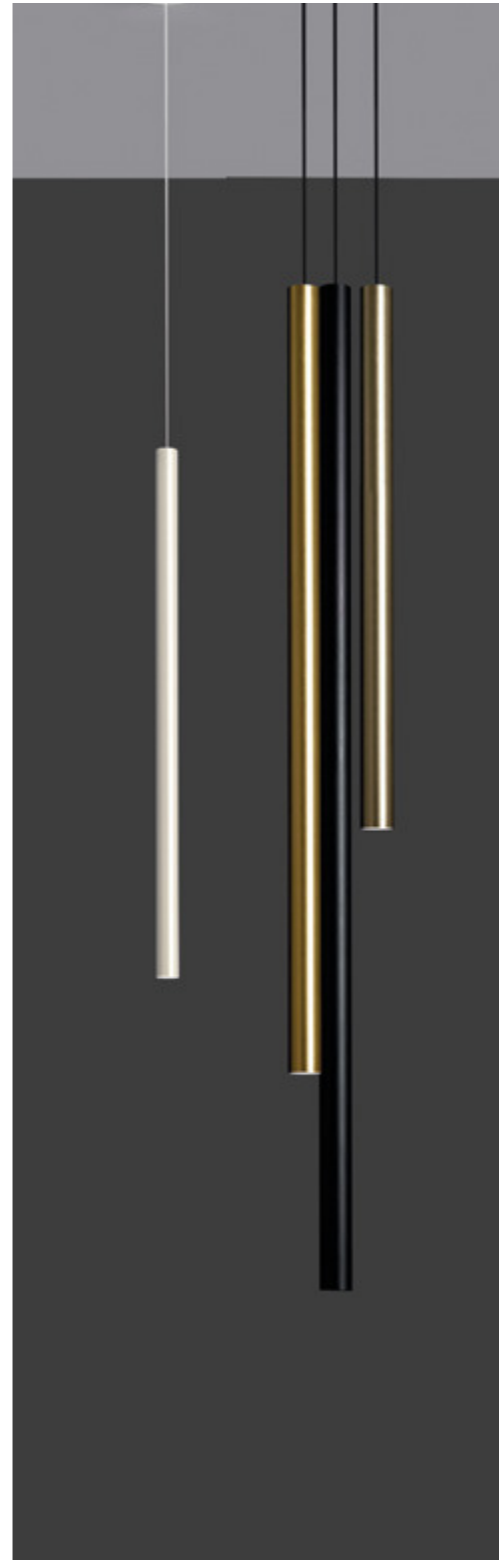

1580 Stick

- .01** Bianco - White
- .02** Nero - Black
- .21** Dorato lucido - Shiny golded
- .25** Dorato satinato - Golded satin

Adattatore **0987** da ordinate separatamente
Adapters **0987** to be ordered separately

2 elementi per decentramento inclusi
2 displacement component included

	Color temperature	LED light source	Im source	Im output
/W	4000K	5,9W 17V 350mA	1060lm	880lm
/W	4000K	/ST Satinato - Satin	5,9W 17V 350mA	1060lm 816lm
/WW	3000K	5,9W 17V 350mA	1030lm	855lm
/WW	3000K	/ST Satinato - Satin	5,9W 17V 350mA	1030lm 793lm
/XW	2700K	5,9W 17V 350mA	969lm	804lm
/XW	2700K	/ST Satinato - Satin	5,9W 17V 350mA	969lm 746lm



0,90 Kg

1581 Stick

- .01** Bianco - White
- .02** Nero - Black
- .21** Dorato lucido - Shiny golded
- .25** Dorato satinato - Golded satin

2 elementi per decentramento inclusi
2 displacement component included

	Color temperature	LED light source	Im source	Im output
/W	4000K	5,9W 17V 350mA	1060lm	880lm
/W	4000K	/ST Satinato - Satin	5,9W 17V 350mA	1060lm 816lm
/WW	3000K	5,9W 17V 350mA	1030lm	855lm
/WW	3000K	/ST Satinato - Satin	5,9W 17V 350mA	1030lm 793lm
/XW	2700K	5,9W 17V 350mA	969lm	804lm
/XW	2700K	/ST Satinato - Satin	5,9W 17V 350mA	969lm 746lm



1,00 Kg

1582 Stick

- .01** Bianco - White
- .02** Nero - Black
- .21** Dorato lucido - Shiny golded
- .25** Dorato satinato - Golded satin

2 elementi per decentramento inclusi
2 displacement component included

	Color temperature	LED light source	Im source	Im output
/W	4000K	5,9W 17V 350mA	1060lm	880lm
/W	4000K	/ST Satinato - Satin	5,9W 17V 350mA	1060lm 816lm
/WW	3000K	5,9W 17V 350mA	1030lm	855lm
/WW	3000K	/ST Satinato - Satin	5,9W 17V 350mA	1030lm 793lm
/XW	2700K	5,9W 17V 350mA	969lm	804lm
/XW	2700K	/ST Satinato - Satin	5,9W 17V 350mA	969lm 746lm



1,10 Kg

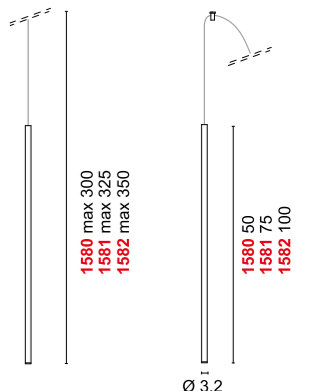

0987

IN: 48V
OUT: 350mA DC
Adattatore per binario 48V - 1 lampada
Adapter for 48V track - 1 lamp

- .01** Bianco - White
- .02** Nero - Black





NEWTON MAXI
p. 145

NEWTON MAXI
p. 145

NEWTON
p. 142

NEWTON SLIM
p. 143

NEWTON FLAT
p. 144

MIR
p. 146

PRÊT-À-PORTER
p. 146

EGOTUBE
p. 147

BALOON
p. 146

EDISON
p. 147

STICK
p. 149

PEVERA
p. 148

NEWTON
p. 148

TRACK 230V TRIFASE

Il sistema di binario trifase a tensione di rete è il più versatile e di facile installazione.

Proposto nella nuova versione a sezione quadra consente di dividere le lampade collegate in tre circuiti indipendenti e avere così tre accensioni diversificate. Questo permette di gestire diversi scenari di luce all'interno dell'ambiente.

FINITURE DISPONIBILI:

- .01 bianco
- .02 nero

Il funzionamento non richiede alimentatori che sono invece contenuti negli adattatori degli apparecchi. Al binario possono essere installati anche tutti gli apparecchi che funzionano a tensione di rete.

The mains voltage three-phase track system is the most versatile and easy to install.

Proposed in the new square section version, it allows the connected lamps to be divided into three independent circuits and thus have three different switchings. This allows you to manage different light scenarios within the environment.

AVAILABLE FINISHES:

- .01 white
- .02 black

Operation does not require drivers which are instead contained in the adapters of the devices. All the devices that operate on mains voltage can also be installed on the track.

Le système de rail triphasé à tension secteur est le plus polyvalent et le plus facile à installer.

Proposé dans la nouvelle version à section carrée, il permet de diviser les lampes connectées en trois circuits indépendants et ainsi d'avoir trois commutations différentes. Cela vous permet de gérer différents scénarios d'éclairage dans l'environnement.

FINITIONS DISPONIBLES:

- .01 blanc
- .02 noir

Le fonctionnement ne nécessite pas d'alimentations électriques qui sont plutôt contenues dans les adaptateurs des appareils. Tous les appareils fonctionnant sur secteur peuvent également être installés sur le rail.

El sistema de carril trifásico a tensión de red es el más versátil y fácil de instalar.

Propuesto en la nueva versión de sección cuadrada, permite dividir las lámparas conectadas en tres circuitos independientes y así tener tres encendidos diferentes. Esto le permite gestionar diferentes escenarios de luz dentro del entorno.

ACABADOS DISPONIBLES:

- .01 blanco
- .02 negro

El funcionamiento no requiere fuentes de alimentación que, en cambio, están contenidas en los adaptadores de los dispositivos. Todos los dispositivos que funcionan con tensión de red también se pueden instalar en la vía.

Das Netzspannungs-Dreiphasen-Schienensystem ist das vielseitigste und einfachste zu installieren.

In der neuen Version mit quadratischem Querschnitt vorgeschlagen, ermöglicht es, die angeschlossenen Lampen in drei unabhängige Stromkreise aufzuteilen und somit drei verschiedene Schaltungen zu haben. Auf diese Weise können Sie verschiedene Lichtszenarien innerhalb der Umgebung verwalten.

VERFÜGBARE AUSFÜHRUNGEN:

- .01 weiß
- .02 schwarz

Für den Betrieb sind keine Netzteile erforderlich, die stattdessen in den Adaptern der Geräte enthalten sind. Alle Geräte, die mit Netzspannung betrieben werden, können auch auf dem Gleis installiert werden.

Трёхфазная рельсовая система сетевого напряжения является наиболее универсальной и простой в монтаже.

Предлагаемая в новой версии квадратного сечения, она позволяет разделить подключённые лампы на три независимые цепи и, таким образом, иметь три разных переключения. Это позволяет вам управлять различными сценариями освещения в среде.

ДОСТУПНЫЕ ОТДЕЛКИ:

- .01 белый
- .02 чёрный

Для работы не требуются блоки питания, которые содержатся в адаптерах устройств. Все устройства, работающие от сетевого напряжения, также могут быть установлены на трассе.

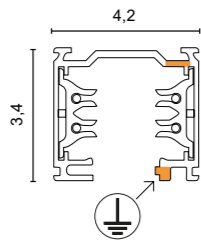

BINARIO elettrificato a tre accensioni diversificate, costruito in lega di alluminio estruso con conduttori in rame alloggiati all'interno di profilati estrusi in PVC.

Electrified TRACK with 3 different switchings, made in extruded aluminium with internal PVC extrusion copper wires.

7301 Binario 230/250V 16A 1 mt
 .01 Bianco - White
 .02 Nero - Black

7302 Binario 230/250V 16A 2 mt
 .01 Bianco - White
 .02 Nero - Black

7303 Binario 230/250V 16A 3 mt
 .01 Bianco - White
 .02 Nero - Black

Nuova versione a sezione quadra
 New version with square section

Esempi di configurazioni - Configuration examples

I giunti di collegamento saranno Destro o Sinistro secondo la posizione laterale del contatto di terra.
 Joints will be right(D) or left(S) following the lateral position of earth conductors.

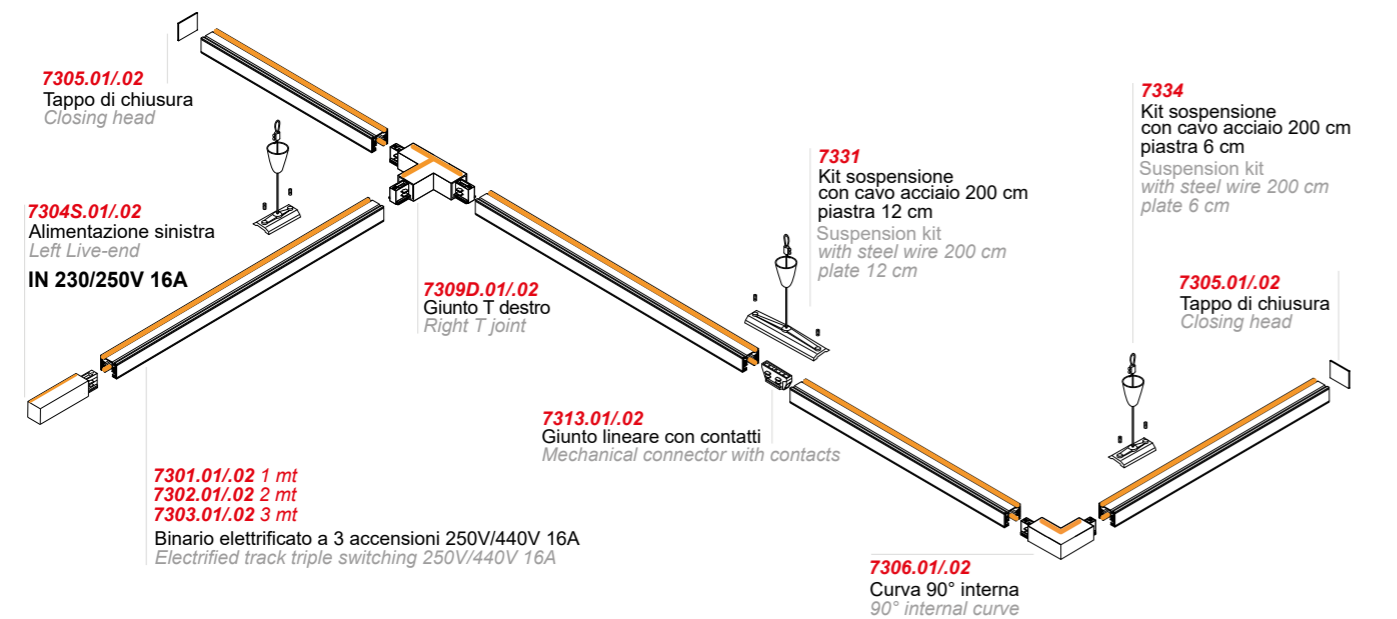
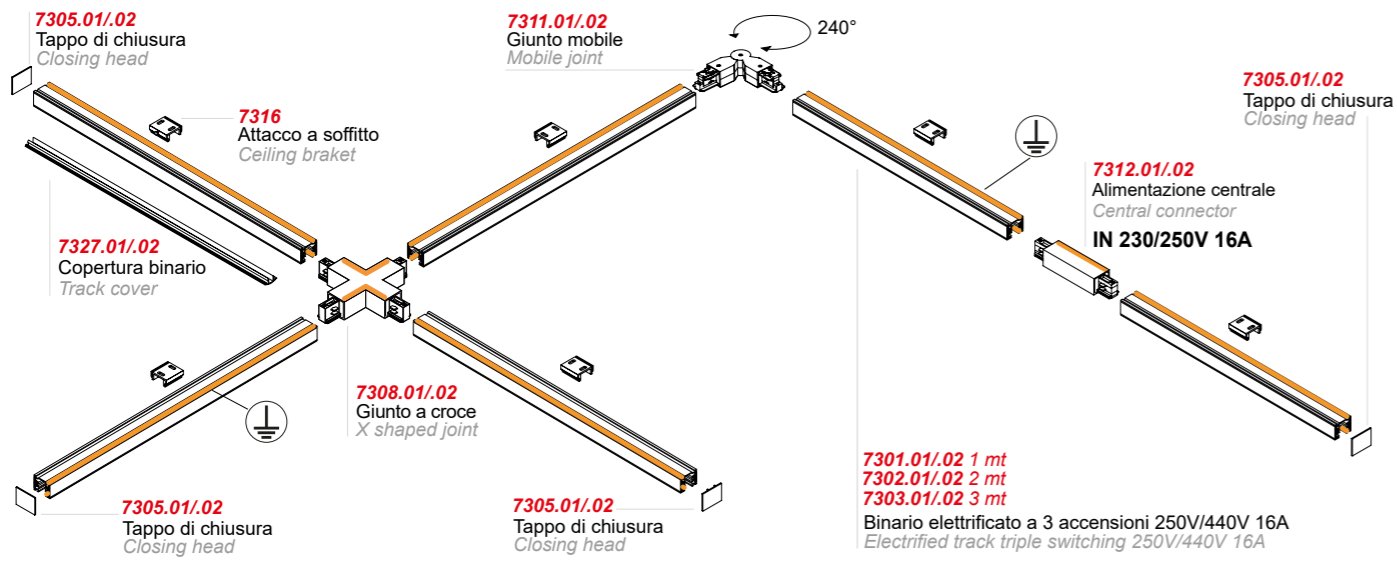

Accessori - Accessories

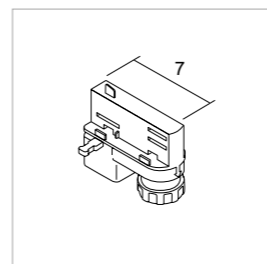

7317
 Adattatore meccanico/elettrico 6A
 Carico meccanico 5 Kg
 Mechanical/electrical adapters 6A
 Mechanical load 5 Kg
 .01 Bianco - White
 .02 Nero - Black

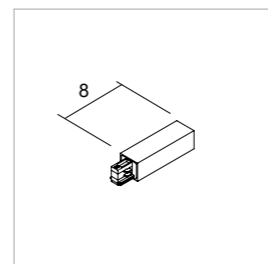

7304S
 Alimentazione sinistra
 Left live-end

7304D
 Alimentazione destra
 Right live-end
 .01 Bianco - White
 .02 Nero - Black

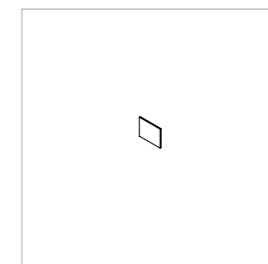

7305
 Tappo di chiusura
 Closing head
 .01 Bianco - White
 .02 Nero - Black

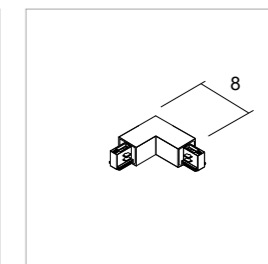

7306
 Curva 90° interna
 90° internal curve

7307
 Curva 90° esterna
 90° external curve
 .01 Bianco - White
 .02 Nero - Black

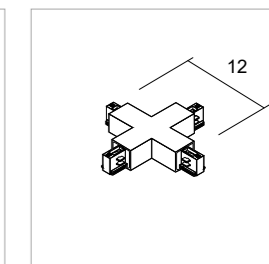

7308
 Giunto X
 X joint
 .01 Bianco - White
 .02 Nero - Black

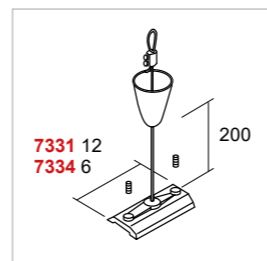

7331
 Kit per sospensione binario con cavo acciaio (2 mt), piastra 12 cm
 Kit to suspend track with steel wire (2 mt), plate 12 cm
7334
 Kit per sospensione binario con cavo acciaio (2 mt), piastra 6 cm
 Kit to suspend track with steel wire (2 mt), plate 6 cm
 .01 Bianco - White
 .02 Nero - Black

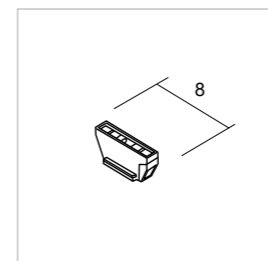

7314
 Giunto lineare senza contatti
 Linear joint without contacts
 .01 Bianco - White
 .02 Nero - Black

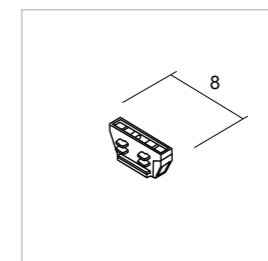

7313
 Giunto lineare con contatti
 Linear joint with contacts
 .01 Bianco - White
 .02 Nero - Black

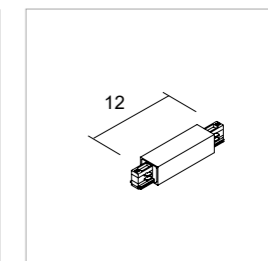

7312
 Alimentazione centrale e giunto lineare
 Central connector with straight joint
 .01 Bianco - White
 .02 Nero - Black

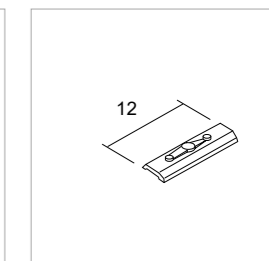

7315
 Piastra 12 cm
 Plate 12 cm

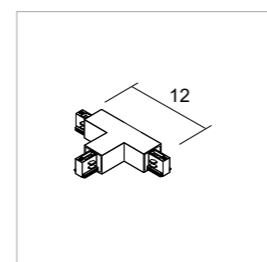

7309D
 Giunto T destro
 Right T joint

7310S
 Giunto T sinistro
 Left T joint
 .01 Bianco - White
 .02 Nero - Black

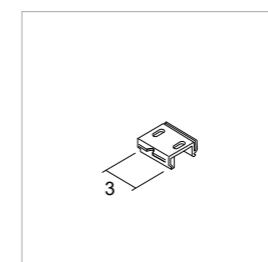

7316
 Attacco soffitto
 Ceiling kit

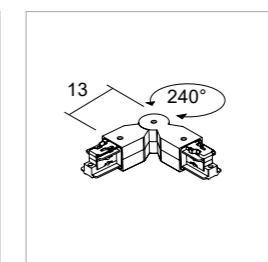

7311
 Giunto mobile
 Mobile joint
 .01 Bianco - White
 .02 Nero - Black

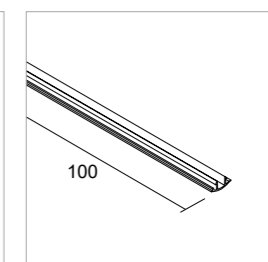

7327
 Copertura binario 100 cm
 Track cover 100 cm
 .01 Bianco - White
 .02 Nero - Black

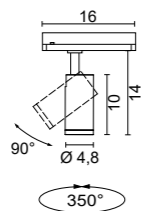

6370 Newton

.01	Bianco - White
.02	Nero - Black

Color temperature	Optics	LED light source	lm source	lm output
/W 4000K	/24 /38 /58	8,7W	1466lm	1150lm
/W 4000K	/ST Satinato - Satin	8,7W	1466lm	1099lm
/WW 3000K	/24 /38 /58	8,7W	1424lm	1117lm
/WW 3000K	/ST Satinato - Satin	8,7W	1424lm	1068lm
/XW 2700K	/24 /38 /58	8,7W	1340lm	1051lm
/XW 2700K	/ST Satinato - Satin	8,7W	1340lm	1005lm

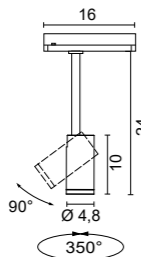

6466 Newton

.01	Bianco - White
.02	Nero - Black

Color temperature	Optics	LED light source	lm source	lm output
/W 4000K	/24 /38 /58	8,7W	1466lm	1150lm
/W 4000K	/ST Satinato - Satin	8,7W	1466lm	1099lm
/WW 3000K	/24 /38 /58	8,7W	1424lm	1117lm
/WW 3000K	/ST Satinato - Satin	8,7W	1424lm	1068lm
/XW 2700K	/24 /38 /58	8,7W	1340lm	1051lm
/XW 2700K	/ST Satinato - Satin	8,7W	1340lm	1005lm

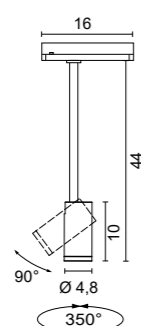

6467 Newton

.01	Bianco - White
.02	Nero - Black

Color temperature	Optics	LED light source	lm source	lm output
/W 4000K	/24 /38 /58	8,7W	1466lm	1150lm
/W 4000K	/ST Satinato - Satin	8,7W	1466lm	1099lm
/WW 3000K	/24 /38 /58	8,7W	1424lm	1117lm
/WW 3000K	/ST Satinato - Satin	8,7W	1424lm	1068lm
/XW 2700K	/24 /38 /58	8,7W	1340lm	1051lm
/XW 2700K	/ST Satinato - Satin	8,7W	1340lm	1005lm



Su richiesta sono disponibili versioni dimmerabili con controllo **CASAMBI**. On request are available dimmable versions with **CASAMBI** control.

Accessori - Accessories

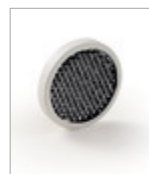

0267
Frangiluce - Louvres

.01	Bianco - White
.02	Nero - Black



0274
Schermo antiabbagliamento
Anti-glare screen

.01	Bianco - White
.02	Nero - Black



Ottiche Disponibili - Available Optics



/24
Ottica fascio stretto per luce d'accento
Narrow beam optic for accent lighting

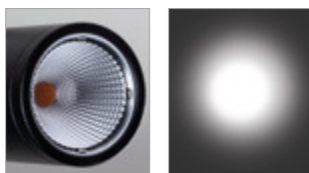

/38
Ottica fascio medio
Medium beam optic

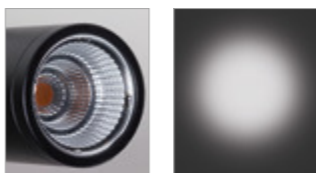

/58
Ottica fascio largo
Wide beam optic

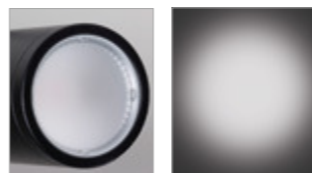

/ST
Ottica fascio diffuso per illuminazione generale
Diffused light optic for general lighting

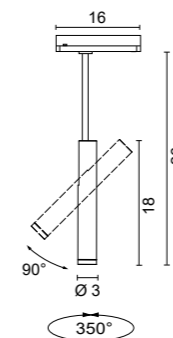

6464 Newton Slim

.01	Bianco - White
.02	Nero - Black

Color temperature	Optics	LED light source	lm source	lm output
/W 4000K	/25 /48 /63	8,7W	1466lm	1150lm
/W 4000K	/ST Satinato - Satin	8,7W	1466lm	1099lm
/WW 3000K	/25 /48 /63	8,7W	1424lm	1117lm
/WW 3000K	/ST Satinato - Satin	8,7W	1424lm	1068lm
/XW 2700K	/25 /48 /63	8,7W	1340lm	1051lm
/XW 2700K	/ST Satinato - Satin	8,7W	1340lm	1005lm

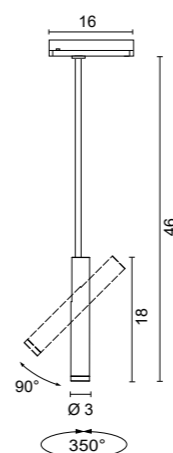

6465 Newton Slim

.01	Bianco - White
.02	Nero - Black

Color temperature	Optics	LED light source	lm source	lm output
/W 4000K	/25 /48 /63	8,7W	1466lm	1150lm
/W 4000K	/ST Satinato - Satin	8,7W	1466lm	1099lm
/WW 3000K	/25 /48 /63	8,7W	1424lm	1117lm
/WW 3000K	/ST Satinato - Satin	8,7W	1424lm	1068lm
/XW 2700K	/25 /48 /63	8,7W	1340lm	1051lm
/XW 2700K	/ST Satinato - Satin	8,7W	1340lm	1005lm



Su richiesta sono disponibili versioni dimmerabili con controllo **CASAMBI**. On request are available dimmable versions with **CASAMBI** control.

Accessori - Accessories



0265
Diffusore in vetro Pyrex sabbato
Sand blasted Pyrex glass diffuser

.01	Ghiera bianca - White ferrule
.02	Ghiera nera - Black ferrule



0267/S
Frangiluce
Louvres

.01	Bianco - White
.02	Nero - Black



Ottiche Disponibili - Available Optics

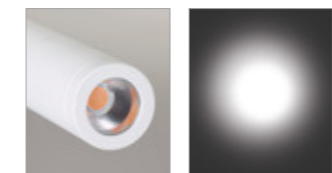

/25
Ottica fascio stretto per luce d'accento
Narrow beam optic for accent lighting

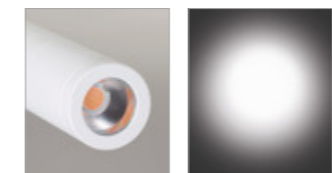

/48
Ottica fascio medio
Medium beam optic

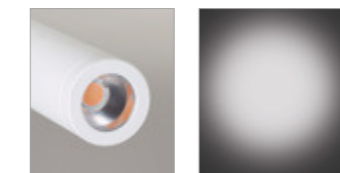

/63
Ottica fascio largo
Wide beam optic

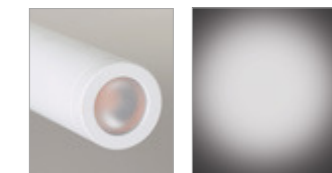

/ST
Ottica fascio diffuso per illuminazione generale
Diffused light optic for general lighting

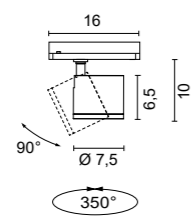

6461 Newton flat

- .01 Bianco - White
- .02 Nero - Black

Color temperature	Optics	LED light source	lm source	lm output
/W 4000K	/13 /40	8,7W	1466lm	1150lm
/W 4000K	/ST Satinato - Satin	8,7W	1466lm	1099lm
/WW 3000K	/13 /40	8,7W	1424lm	1117lm
/WW 3000K	/ST Satinato - Satin	8,7W	1424lm	1068lm
/XW 2700K	/13 /40	8,7W	1340lm	1051lm
/XW 2700K	/ST Satinato - Satin	8,7W	1340lm	1005lm



0,60 Kg

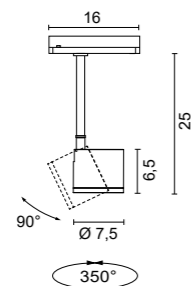

6462 Newton flat

- .01 Bianco - White
- .02 Nero - Black

Color temperature	Optics	LED light source	lm source	lm output
/W 4000K	/13 /40	8,7W	1466lm	1150lm
/W 4000K	/ST Satinato - Satin	8,7W	1466lm	1099lm
/WW 3000K	/13 /40	8,7W	1424lm	1117lm
/WW 3000K	/ST Satinato - Satin	8,7W	1424lm	1068lm
/XW 2700K	/13 /40	8,7W	1340lm	1051lm
/XW 2700K	/ST Satinato - Satin	8,7W	1340lm	1005lm



0,70 Kg

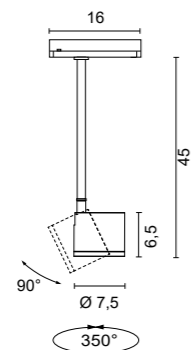

6463 Newton flat

- .01 Bianco - White
- .02 Nero - Black

Color temperature	Optics	LED light source	lm source	lm output
/W 4000K	/13 /40	8,7W	1466lm	1150lm
/W 4000K	/ST Satinato - Satin	8,7W	1466lm	1099lm
/WW 3000K	/13 /40	8,7W	1424lm	1117lm
/WW 3000K	/ST Satinato - Satin	8,7W	1424lm	1068lm
/XW 2700K	/13 /40	8,7W	1340lm	1051lm
/XW 2700K	/ST Satinato - Satin	8,7W	1340lm	1005lm



0,80 Kg

Su richiesta sono disponibili versioni dimmerabili con controllo **CASAMBI**. On request are available dimmable versions with **CASAMBI** control.

Accessori - Accessories



0264

Parabola decorativa
Decorative parabolic reflector

- .01 Bianco - White
- .02 Nero - Black

Ottiche Disponibili - Available Optics

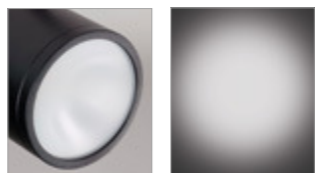
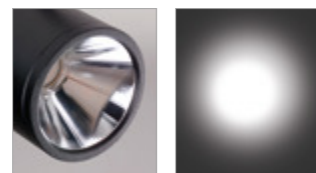
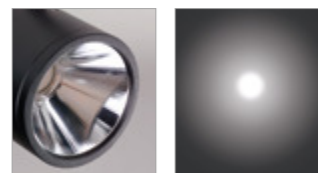

/13
Ottica fascio stretto per luce d'accento
Narrow beam optic for accent lighting

/40
Ottica fascio largo
Wide beam optic

/ST
Ottica fascio diffuso per illuminazione generale
Diffused light optic for general lighting

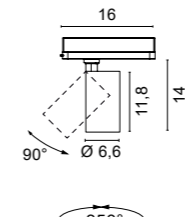
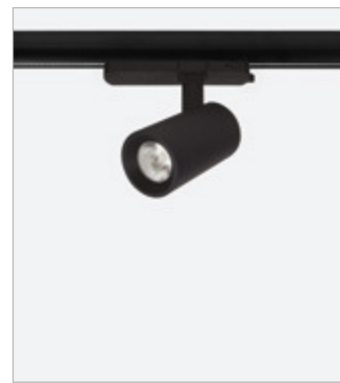

6720 Newton maxi

- .01 Bianco - White
- .02 Nero - Black

Color temperature	Optics	LED light source	lm source
/W 4000K	/15 /38 /60	12W	1705lm
/WW 3000K	/15 /38 /60	12W	1550lm



0,55 Kg

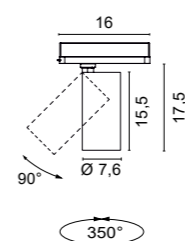
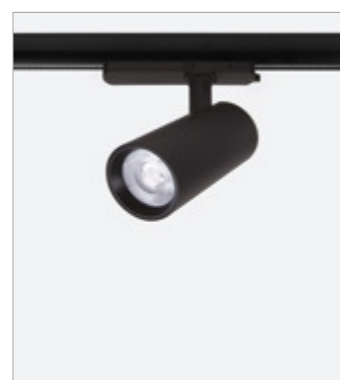

6721 Newton maxi

- .01 Bianco - White
- .02 Nero - Black

Color temperature	Optics	LED light source	lm source
/W 4000K	/15 /38 /60	21W	3060lm
/WW 3000K	/15 /38 /60	21W	2780lm



0,50 Kg



6720 Newton maxi

6721 Newton maxi

MIR TRACK 230V

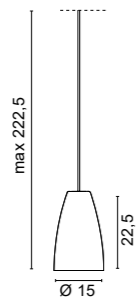

1133 Mir
.57 Vetro bianco - White glass

Light sources
 E27 LED
 12W 2700K 1800lm (art. 0109/12/XW)
 12W 4000K 1800lm (art. 0109/12/W)
 15W 2700K 2200lm (art. 0109/15/XW)
 15W 4000K 2200lm (art. 0109/15/W)

1,00 Kg

Adattatore 7326 da ordinate separatamente
 Adapters 7326 to be ordered separately

7326
 Adattatore meccanico/elettrico 6A
 Carico meccanico 5 Kg
 Mechanical/electrical adapters 6A
 Mechanical load 5 Kg

- .01** Bianco - White
.02 Nero - Black



EGOTUBE TRACK 230V

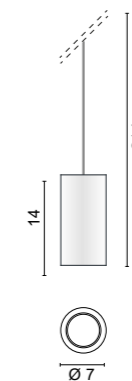

1660 Egotube

.01 Bianco - White
.02 Nero - Black
.35 Sabbia - Sand
.02.28 Nero foglia rame - Black copper leaf
.02.29 Nero foglia oro - Black gold leaf
.31.01 Cromato, interno bianco
 Chromed, in white

Light sources
 GU10 LED
 7W 2700K 580lm (art. 0094/XW)
 7W 3000K 600lm (art. 0094/WW)
 7W 4000K 630lm (art. 0094/W)

0,30 Kg

Adattatore 7326 da ordinate separatamente
 Adapters 7326 to be ordered separately

PRÊT-À-PORTER TRACK 230V

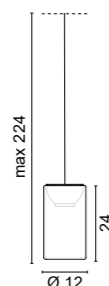

1516 Prêt-à-Porter

.01 Vetro pyrex trasparente con inserto bianco
 Clear pyrex glass with white insert
.02.21 Vetro pyrex trasparente con inserto nero - interno oro
 Clear pyrex glass with black - in gold insert

Light sources
 E27 LED
 12W 2700K 1800lm (art. 0109/12/XW)
 12W 4000K 1800lm (art. 0109/12/W)

1,00 Kg

Adattatore 7326 da ordinate separatamente
 Adapters 7326 to be ordered separately

7326
 Adattatore meccanico/elettrico 6A
 Carico meccanico 5 Kg
 Mechanical/electrical adapters 6A
 Mechanical load 5 Kg

- .01** Bianco - White
.02 Nero - Black



7326
 Adattatore meccanico/elettrico 6A
 Carico meccanico 5 Kg
 Mechanical/electrical adapters 6A
 Mechanical load 5 Kg

- .01** Bianco - White
.02 Nero - Black

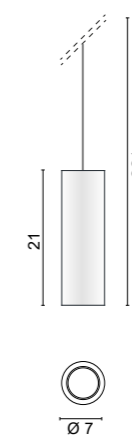

1661 Egotube

.01 Bianco - White
.02 Nero - Black
.35 Sabbia - Sand
.02.28 Nero foglia rame - Black copper leaf
.02.29 Nero foglia oro - Black gold leaf
.31.01 Cromato, interno bianco
 Chromed, in white

Light sources
 GU10 LED
 7W 2700K 580lm (art. 0094/XW)
 7W 3000K 600lm (art. 0094/WW)
 7W 4000K 630lm (art. 0094/W)

0,40 Kg

Adattatore 7326 da ordinate separatamente
 Adapters 7326 to be ordered separately

BALOON TRACK 230V

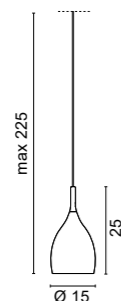

1549 Baloon

.01 Bianco - White
.31 Cromato lucido - Shiny chromed

Light sources
 E27 LED
 12W 2700K 1800lm (art. 0109/12/XW)
 12W 4000K 1800lm (art. 0109/12/W)
 15W 2700K 2200lm (art. 0109/15/XW)
 15W 4000K 2200lm (art. 0109/15/W)

1,60 Kg

Adattatore 7326 da ordinate separatamente
 Adapters 7326 to be ordered separately

7326
 Adattatore meccanico/elettrico 6A
 Carico meccanico 5 Kg
 Mechanical/electrical adapters 6A
 Mechanical load 5 Kg

- .01** Bianco - White
.02 Nero - Black



EDISON TRACK 230V

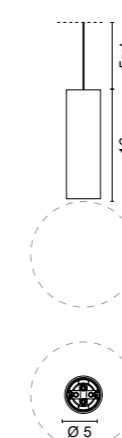

1598 Edison

.01 Bianco - White
.02 Nero - Black
.25 Dorato satinato - Gilded satin
.32 Nickel satinato - Nickel mat

Light sources
 E27 LED max 7W

0,40 Kg

- Lunghezza cavo 5 mt.
 Cable length 5 mt

Adattatore 7326 da ordinate separatamente
 Adapters 7326 to be ordered separately

7326
 Adattatore meccanico/elettrico 6A
 Carico meccanico 5 Kg
 Mechanical/electrical adapters 6A
 Mechanical load 5 Kg

- .01** Bianco - White
.02 Nero - Black



1598.01 Bianco - White + 01LP6

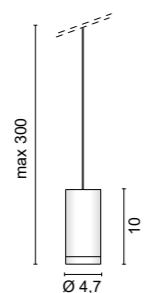

1591 Newton

- .02** Nero - Black
- .25** Dorato satinato - Golded satin
- .32** Nickel satinato - Nickel mat

Adattatore **0988** da ordinate separatamente
Adapters **0988** to be ordered separately

2 elementi per decentramento inclusi.
2 displacement component included.

Color temperature	LED light source	Im source	Im output
/W 4000K	5,9W 17V 350mA	1060lm	880lm
/W 4000K /ST Satinato - Satin	5,9W 17V 350mA	1060lm	816lm
/WW 3000K	5,9W 17V 350mA	1030lm	855lm
/WW 3000K /ST Satinato - Satin	5,9W 17V 350mA	1030lm	793lm
/XW 2700K	5,9W 17V 350mA	969lm	804lm
/XW 2700K /ST Satinato - Satin	5,9W 17V 350mA	969lm	746lm



0,50 Kg

A richiesta fascio di apertura: 24° o 58° - Upon request beam angles: 24° o 58°



0988

IN: 50/60Hz
OUT: 350mA DC
Adattatore per binario 220-240V - 1 lampada
Adapter for 220-240V track - 1 lamp

- .01** Bianco - White
- .02** Nero - Black



Accessori decorativi - Decorative accessories



1591.02 + 0547.02

1591.02 + 0549.02.00

1591.02 + 0549.02.57

1591.02 + 0547.02 + 0549.02.00

1591.02 + 0547.02 + 0549.02.57

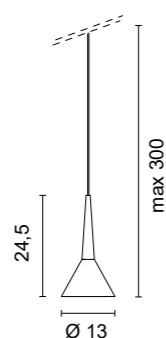

1568 Pevera

- .01** Bianco - White
- .02** Nero - Black
- .05** Rosso - Red

Adattatore **0988** da ordinate separatamente
Adapters **0988** to be ordered separately

2 elementi per decentramento inclusi.
2 displacement component included

Color temperature	LED Light source	Im source
/W 4000K	6W 17V 350mA	1073lm
/WW 3000K	6W 17V 350mA	1011lm
/XW 2700K	6W 17V 350mA	970lm



0,50 Kg



0988

IN: 50/60Hz
OUT: 350mA DC
Adattatore per binario 220-240V - 1 lampada
Adapter for 220-240V track - 1 lamp

- .01** Bianco - White
- .02** Nero - Black

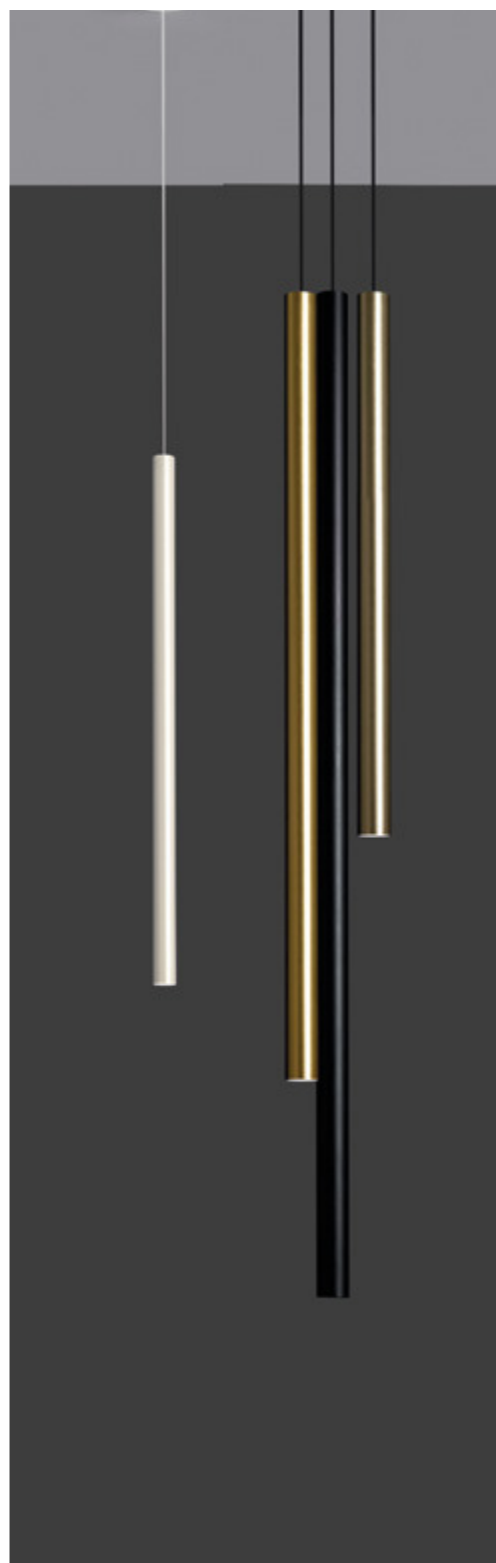

1580 Stick

- .01** Bianco - White
- .02** Nero - Black
- .21** Dorato lucido - Shiny golded
- .25** Dorato satinato - Golded satin

Adattatore **0988** da ordinate separatamente
Adapters **0988** to be ordered separately

2 elementi per decentramento inclusi.
2 displacement component included

Color temperature	LED light source	Im source	Im output
/W 4000K	5,9W 17V 350mA	1060lm	880lm
/W 4000K /ST Satinato - Satin	5,9W 17V 350mA	1060lm	816lm
/WW 3000K	5,9W 17V 350mA	1030lm	855lm
/WW 3000K /ST Satinato - Satin	5,9W 17V 350mA	1030lm	793lm
/XW 2700K	5,9W 17V 350mA	969lm	804lm
/XW 2700K /ST Satinato - Satin	5,9W 17V 350mA	969lm	746lm



0,90 Kg

1581 Stick

- .01** Bianco - White
- .02** Nero - Black
- .21** Dorato lucido - Shiny golded
- .25** Dorato satinato - Golded satin

Adattatore **0988** da ordinate separatamente
Adapters **0988** to be ordered separately

2 elementi per decentramento inclusi.
2 displacement component included

Color temperature	LED light source	Im source	Im output
/W 4000K	5,9W 17V 350mA	1060lm	880lm
/W 4000K /ST Satinato - Satin	5,9W 17V 350mA	1060lm	816lm
/WW 3000K	5,9W 17V 350mA	1030lm	855lm
/WW 3000K /ST Satinato - Satin	5,9W 17V 350mA	1030lm	793lm
/XW 2700K	5,9W 17V 350mA	969lm	804lm
/XW 2700K /ST Satinato - Satin	5,9W 17V 350mA	969lm	746lm



1,00 Kg

1582 Stick

- .01** Bianco - White
- .02** Nero - Black
- .21** Dorato lucido - Shiny golded
- .25** Dorato satinato - Golded satin

Adattatore **0988** da ordinate separatamente
Adapters **0988** to be ordered separately

2 elementi per decentramento inclusi.
2 displacement component included

Color temperature	LED light source	Im source	Im output
/W 4000K	5,9W 17V 350mA	1060lm	880lm
/W 4000K /ST Satinato - Satin	5,9W 17V 350mA	1060lm	816lm
/WW 3000K	5,9W 17V 350mA	1030lm	855lm
/WW 3000K /ST Satinato - Satin	5,9W 17V 350mA	1030lm	793lm
/XW 2700K	5,9W 17V 350mA	969lm	804lm
/XW 2700K /ST Satinato - Satin	5,9W 17V 350mA	969lm	746lm



1,10 Kg

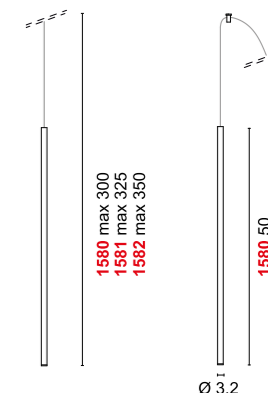

0988

IN: 50/60Hz
OUT: 350mA DC
Adattatore per binario 220-240V - 1 lampada
Adapter for 220-240V track - 1 lamp

- .01** Bianco - White
- .02** Nero - Black



NEWTON GU10
p. 154

MIR
p. 154

PRÊT-À-PORTER
p. 154

BALOON
p. 154

EDISON
p. 155

EGOTUBE
p. 155

TRACK 230V MONOFASE

design: U.T. EGOLUCE

Il sistema di binario monofase a tensione di rete è più piccolo del tradizionale trifase e consente un'unica accensione.

Le dimensioni ridotte e la facilità d'installazione sono le caratteristiche di questo sistema che lo rendono ideale per qualsiasi tipo di ambiente anche in ambito domestico.

FINITURE DISPONIBILI:

- .01 bianco
- .02 nero

Il funzionamento non richiede alimentatori. Al binario possono essere installati tutti gli apparecchi che funzionano a tensione di rete.

The single-phase mains voltage track system is smaller than the traditional three-phase and allows for a single switch-on.

The small size and ease of installation are the characteristics of this system that make it ideal for any type of environment, even in the home.

AVAILABLE FINISHES:

- .01 white
- .02 black

Operation does not require drivers. All the devices that operate on mains voltage can be installed on the track.

Le système de voie de tension secteur monophasé est plus petit que le triphasé traditionnel et permet un seul allumage.

La petite taille et la facilité d'installation sont les caractéristiques de ce système qui le rendent idéal pour tout type d'environnement, même à la maison.

FINITIONS DISPONIBLES:

- .01 blanc
- .02 noir

Le fonctionnement ne nécessite pas d'alimentation électrique. Tous les appareils fonctionnant sur tension secteur peuvent être installés sur le rail.

El sistema de vía de tensión de red monofásico es más pequeño que el trifásico tradicional y permite un único encendido.

El pequeño tamaño y la facilidad de instalación son las características de este sistema que lo hacen ideal para cualquier tipo de ambiente, incluso en el hogar.

ACABADOS DISPONIBLES:

- .01 blanco
- .02 negro

El funcionamiento no requiere fuentes de alimentación. Todos los dispositivos que funcionan con tensión de red se pueden instalar en la vía.

Das einphasige Netzspannungs-Schienensystem ist kleiner als das herkömmliche dreiphasige und ermöglicht ein einmaliges Einschalten.

Die geringen Abmessungen und die einfache Installation sind die Merkmale dieses Systems, die es ideal für jede Art von Umgebung machen, auch für den Wohnbereich.

VERFÜGBARE AUSFÜHRUNGEN:

- .01 weiß
- .02 schwarz

Für den Betrieb sind keine Netzteile erforderlich. Auf dem Gleis können alle Geräte installiert werden, die mit Netzspannung betrieben werden.

Однофазная система рельсов сетевого напряжения меньше, чем традиционная трехфазная, и допускает однократное включение.

Небольшой размер и простота установки — характеристики этой системы, которые делают ее идеальной для любого типа среды, даже дома.

ДОСТУПНЫЕ ОТДЕЛКИ:

- .01 белый
- .02 черный

Для работы не требуются источники питания. Все устройства, работающие от сетевого напряжения, могут быть установлены на трассе.

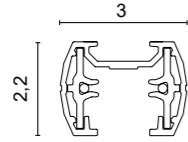

BINARIO elettrificato monofase costruito in lega di alluminio estruso con conduttori in rame alloggiati all'interno di profilati estrusi in PVC.

Electrified TRACK with single-phase, made in extruded aluminium with internal PVC extrusion copper wires.

7381 Binario 230/250V 16A 1 mt
 .01 Bianco - White
 .02 Nero - Black

7382 Binario 230/250V 16A 2 mt
 .01 Bianco - White
 .02 Nero - Black

7383 Binario 230/250V 16A 3 mt
 .01 Bianco - White
 .02 Nero - Black



Accessori - Accessories

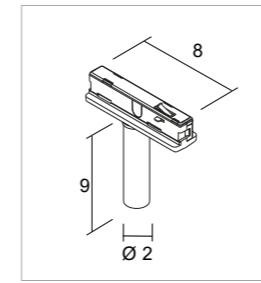

7386
 Adattatore meccanico/elettrico 6A
 Carico meccanico 5 Kg
*Mechanical/electrical adapters 6A
 Mechanical load 5 Kg*
 .01 Bianco - White
 .02 Nero - Black

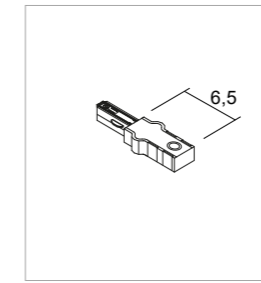

7384
 Alimentazione Live-end
 .01 Bianco - White
 .02 Nero - Black

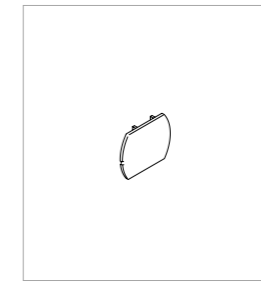

7385
 Tappo di chiusura Closing head
 .01 Bianco - White
 .02 Nero - Black

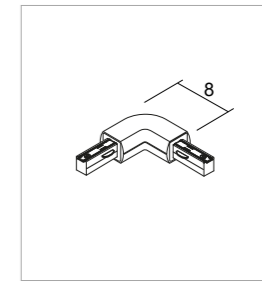

7387
 Curva 90° 90° curve
 .01 Bianco - White
 .02 Nero - Black

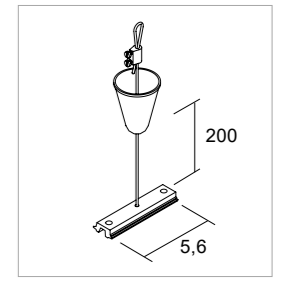

7391
 Kit per sospensione binario con cavo acciaio (2 mt), piastra 5,6 cm
Kit to suspend track with steel wire (2 mt), plate 5,6 cm
 .01 Bianco - White
 .02 Nero - Black

Esempi di configurazioni - Configuration examples

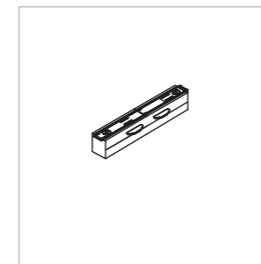
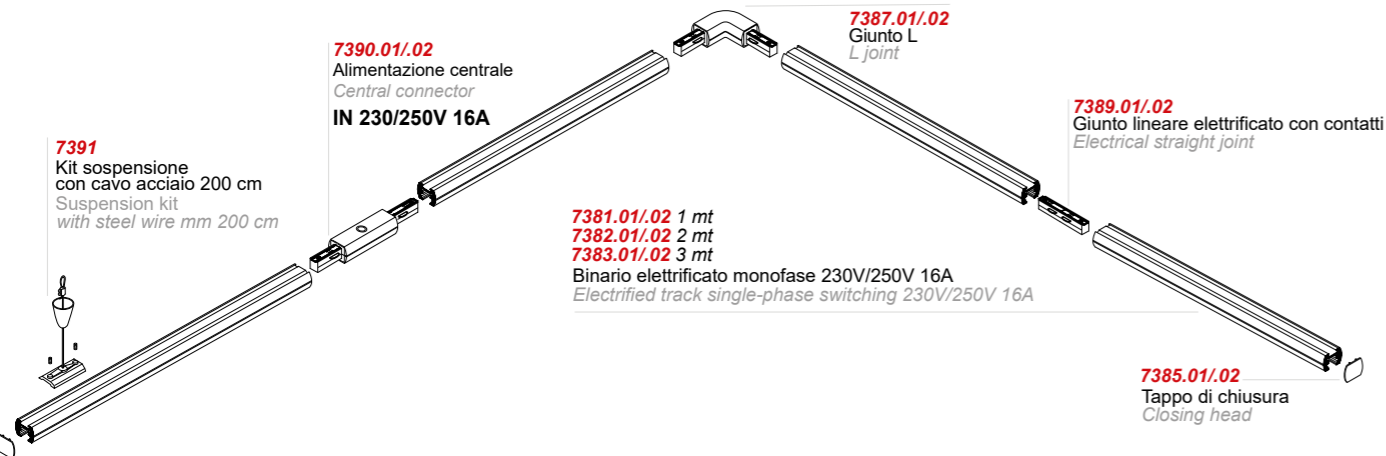
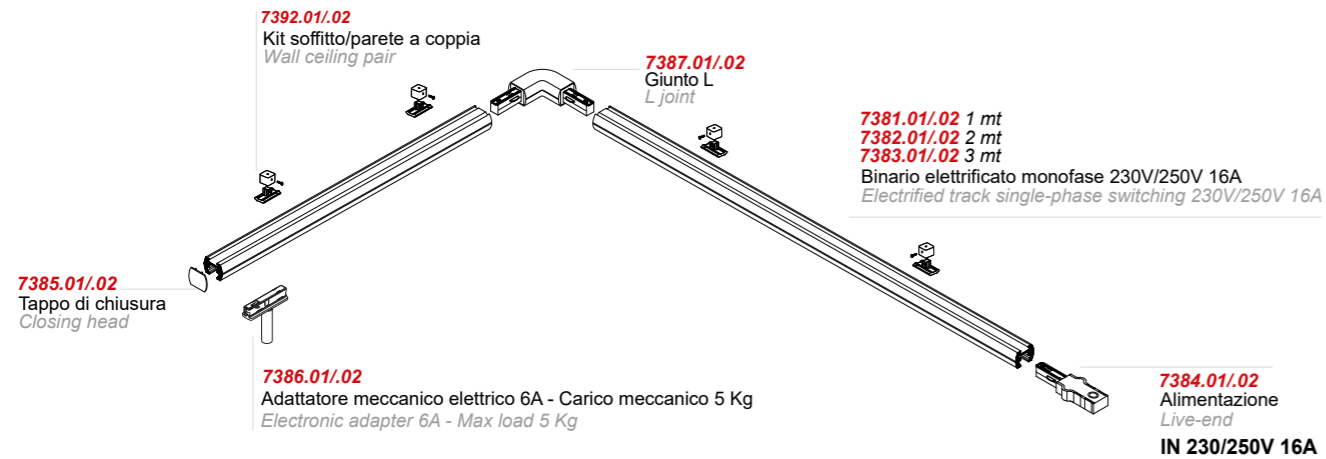

7389
 Giunto lineare con contatti
Linear joint with contacts
 .01 Bianco - White
 .02 Nero - Black

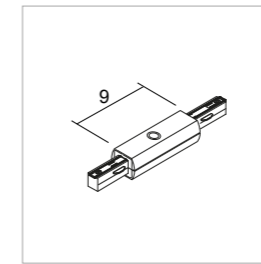

7390
 Alimentazione centrale e giunto lineare
Central connector with straight joint
 .01 Bianco - White
 .02 Nero - Black

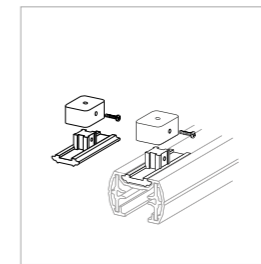

7392
 Kit soffitto-parete a coppia
Ceiling wall pair
 .01 Bianco - White
 .02 Nero - Black

NEWTON EASY GU10 TRACK 230V MONOFASE

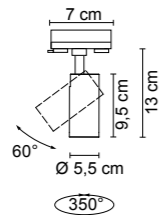

6482 Newton Easy track 230V - GU10

- .01 Bianco - White
- .02 Nero - Black
- .02.25 Snodo nero, corpo dorato satinato - Black articulated joint, satin golded body
- .02.32 Snodo nero, corpo nickel satinato - Black articulated joint, nickel mat body

Light sources

7W GU10 LED (cod. 0094/16)

0,45 Kg

MIR TRACK 230V MONOFASE

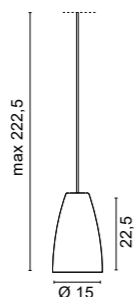

1133 Mir

- .57 Vetro bianco - White glass

Light sources

E27 LED

- 12W 2700K 1800lm (art. 0109/12/XW)
- 12W 4000K 1800lm (art. 0109/12/W)
- 15W 2700K 2200lm (art. 0109/15/XW)
- 15W 4000K 2200lm (art. 0109/15/W)

1,00 Kg

Adattatore 7386 da ordinate separatamente
Adapters 7386 to be ordered separately

7386

Adattatore meccanico/elettrico 6A
Carico meccanico 5 Kg
Mechanical/electrical adapters 6A
Mechanical load 5 Kg

- .01 Bianco - White
- .02 Nero - Black



PRÊT-À-PORTER TRACK 230V MONOFASE

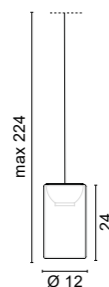

1516 Prêt-à-Porter

- .01 Vetro pyrex trasparente con inserto bianco.
Clear pyrex glass with white insert
- .02.21 Vetro pyrex trasparente con inserto nero - interno oro.
Clear pyrex glass with black - in gold insert

Light sources

E27 LED

- 12W 2700K 1800lm (art. 0109/12/XW)
- 12W 4000K 1800lm (art. 0109/12/W)

1,00 Kg

Adattatore 7386 da ordinate separatamente
Adapters 7386 to be ordered separately

7386

Adattatore meccanico/elettrico 6A
Carico meccanico 5 Kg
Mechanical/electrical adapters 6A
Mechanical load 5 Kg

- .01 Bianco - White
- .02 Nero - Black



BALOON TRACK 230V MONOFASE

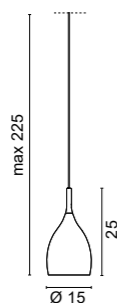

1549 Baloon

- .01 Bianco - White
- .31 Cromato lucido - Shiny chromed

Light sources

E27 LED

- 12W 2700K 1800lm (art. 0109/12/XW)
- 12W 4000K 1800lm (art. 0109/12/W)
- 15W 2700K 2200lm (art. 0109/15/XW)
- 15W 4000K 2200lm (art. 0109/15/W)

1,60 Kg

Adattatore 7386 da ordinate separatamente
Adapters 7386 to be ordered separately

7386

Adattatore meccanico/elettrico 6A
Carico meccanico 5 Kg
Mechanical/electrical adapters 6A
Mechanical load 5 Kg

- .01 Bianco - White
- .02 Nero - Black



EGOTUBE TRACK 230V MONOFASE

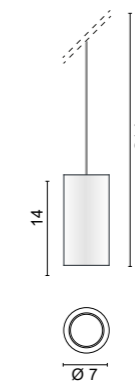

1660 Egotube

- .01 Bianco - White
- .02 Nero - Black
- .35 Sabbia - Sand
- .02.28 Nero foglia rame - Black copper leaf
- .02.29 Nero foglia oro - Black gold leaf
- .31.01 Cromato, interno bianco
Chromed, in white

Light sources

GU10 LED

- 7W 2700K 580lm (art. 0094/XW)
- 7W 3000K 600lm (art. 0094/WW)
- 7W 4000K 630lm (art. 0094/W)

0,30 Kg

Adattatore 7386 da ordinate separatamente
Adapters 7386 to be ordered separately

7386

Adattatore meccanico/elettrico 6A
Carico meccanico 5 Kg.
Mechanical/electrical adapters 6A
Mechanical load 5 Kg.

- .01 Bianco - White
- .02 Nero - Black

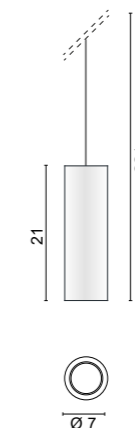

1661 Egotube

- .01 Bianco - White
- .02 Nero - Black
- .35 Sabbia - Sand
- .02.28 Nero foglia rame - Black copper leaf
- .02.29 Nero foglia oro - Black gold leaf
- .31.01 Cromato, interno bianco
Chromed, in white

Light sources

GU10 LED

- 7W 2700K 580lm (art. 0094/XW)
- 7W 3000K 600lm (art. 0094/WW)
- 7W 4000K 630lm (art. 0094/W)

0,40 Kg

Adattatore 7386 da ordinate separatamente
Adapters 7386 to be ordered separately

EDISON TRACK 230V MONOFASE



1598 Edison

- .01 Bianco - White
- .02 Nero - Black
- .25 Dorato satinato - Golded satin
- .32 Nickel satinato - Nickel mat

Light sources

E27 LED max 7W

0,40 Kg

Lunghezza cavo 5 mt
Cable length 5 mt

Adattatore 7386 da ordinate separatamente
Adapters 7386 to be ordered separately

7386

Adattatore meccanico/elettrico 6A
Carico meccanico 5 Kg
Mechanical/electrical adapters 6A
Mechanical load 5 Kg

- .01 Bianco - White
- .02 Nero - Black



NEWTON MICRO
p. 162

NEWTON MINI
p. 162

SEGMENTO MINI
p. 164

SEGMENTO DARK MINI
p. 164

TINY - TRACK 24V

design: **U.T. EGOLUCE**

Nuovo sistema di binario magnetico a 24V di ridottissime dimensioni che si adatta a qualsiasi tipo di ambiente e soluzione, dagli interni classici a quelli moderni.

Il punto di forza di questo prodotto risiede proprio nelle dimensioni e nella facilità di configurazione che lo rende perfetto per ogni tipo di applicazione.

Tiny viene proposto nella sola finitura nera.

Il sistema binario a 24V è da completare con una serie di accessori, da ordinare separatamente. Grazie ai vari componenti magnetici, è possibile creare facilmente diverse configurazioni personalizzate per soddisfare qualsiasi esigenza.

Il binario a 24V necessita di un alimentatore dedicato, da ordinare separatamente, e dimensionato in funzione degli elementi illuminanti che si decide vogliono utilizzare. Dimmerazione DALI e altre tonalità di luce bianca (2700K e 4000K) disponibili su richiesta.

New 24V magnetic track system of very small dimensions that adapts to any type of environment and solution, from classic to modern interiors.

The strength of this product lies precisely in the size and ease of configuration which makes it perfect for any type of application.

Tiny is offered in a black finish only.

The 24V binary system is to be completed with a series of accessories, to be ordered separately. Thanks to the various magnetic components, you can easily create different customized configurations to meet any need.

The 24V track requires a dedicated driver, to be ordered separately, and sized according to the lighting elements that you decide to use.

DALI dimming and other white light tones (2700K and 4000K) available on request.

Nouveau système de rail magnétique 24V de très petites dimensions qui s'adapte à tout type d'environnement et de solution, des intérieurs classiques aux intérieurs modernes.

La force de ce produit réside précisément dans sa taille et sa facilité de configuration qui le rend parfait pour tout type d'application.

Tiny est proposé uniquement en finition noire.

Le système binaire 24V est à compléter par une série d'accessoires, à commander séparément. Grâce aux différents composants magnétiques, vous pouvez facilement créer différentes configurations personnalisées pour répondre à tous les besoins.

Le rail 24V nécessite une alimentation dédiée, à commander séparément, et dimensionnée en fonction des éléments d'éclairage que vous décidez d'utiliser.

Gradation DALI et autres tons de lumière blanche (2700K et 4000K) disponibles sur demande.

Nuevo sistema de rieles magnéticos de 24V de dimensiones muy reducidas que se adapta a cualquier tipo de ambiente y solución, desde interiores clásicos hasta modernos.

La fuerza de este producto radica precisamente en el tamaño y la facilidad de configuración que lo hace perfecto para cualquier tipo de aplicación.

Tiny se ofrece solo en un acabado negro.

El sistema binario de 24V se debe completar con una serie de accesorios que se piden por separado. Gracias a los diversos componentes magnéticos, puede crear fácilmente diferentes configuraciones personalizadas para satisfacer cualquier necesidad.

El carril de 24V requiere una fuente de alimentación dedicada, que se pide por separado, y dimensionada en función de los elementos de iluminación que decida utilizar.

Regulación DALI y otros tonos de luz blanca (2700K y 4000K) disponibles bajo pedido.

Neues 24-V-Magnetschienensystem mit sehr kleinen Abmessungen, das sich an jede Art von Umgebung und Lösung anpasst, von klassischen bis zu modernen Innenräumen.

Die Stärke dieses Produkts liegt genau in der Größe und der einfachen Konfiguration, die es perfekt für jede Art von Anwendung macht.

Tiny wird nur in schwarzer Ausführung angeboten.

Das 24V-Binärsystem ist mit einer Reihe von separat zu bestellendem Zubehör zu vervollständigen. Dank der verschiedenen magnetischen Komponenten können Sie ganz einfach verschiedene individuelle Konfigurationen für jeden Bedarf erstellen.

Für die 24-V-Schiene ist ein separates Netzteil erforderlich, das separat bestellt und entsprechend den Beleuchtungselementen bemessen werden muss, die Sie verwenden möchten.

DALI-Dimmung und andere Weißlichttöne (2700K und 4000K) auf Anfrage erhältlich.

Новая система магнитных направляющих 24 В очень малых размеров, которая адаптируется к любому типу среды и решения, от классического до современного интерьера.

Сила этого продукта заключается именно в размере и простоте конфигурации, что делает его идеальным для любого типа применения.

Тину предлагается только в черном цвете.

Бинарная система 24 В должна комплектоваться рядом аксессуаров, которые заказываются отдельно. Благодаря различным магнитным компонентам вы можете легко создавать различные индивидуальные конфигурации для удовлетворения любых потребностей.

Для трека 24 В требуется специальный источник питания, который заказывается отдельно, и его размер соответствует элементам освещения, которые вы решите использовать.

Диммирование DALI и другие тона белого света (2700K и 4000K) доступны по запросу.



Binari elettrificati a bassa tensione 24V per applicazioni a soffitto, a parete, non tagliabile.
Dimmerazione DALI su richiesta.

24V low voltage electrified tracks for ceiling, wall, not cuttable.
DALI dimming on request

- | | |
|------------------------------------------------------------------------|------------------------------------------------------------------------|
| 7399 Binario 24V 30cm - Track 24V 30 cm
.02 Nero - Black | 7402 Binario 24V 1,80mt - Track 24V 1,80 mt
.02 Nero - Black |
| 7400 Binario 24V 60cm - Track 24V 60 cm
.02 Nero - Black | 7403 Binario 24V 2,40mt - Track 24V 2,40 mt
.02 Nero - Black |
| 7401 Binario 24V 1,20mt - Track 24V 1,20 mt
.02 Nero - Black | |

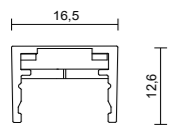

Esempi di configurazioni - Configuration examples

Lunghezza massima 10 mt, max 100W
Maximum length 10 mt, max 100W

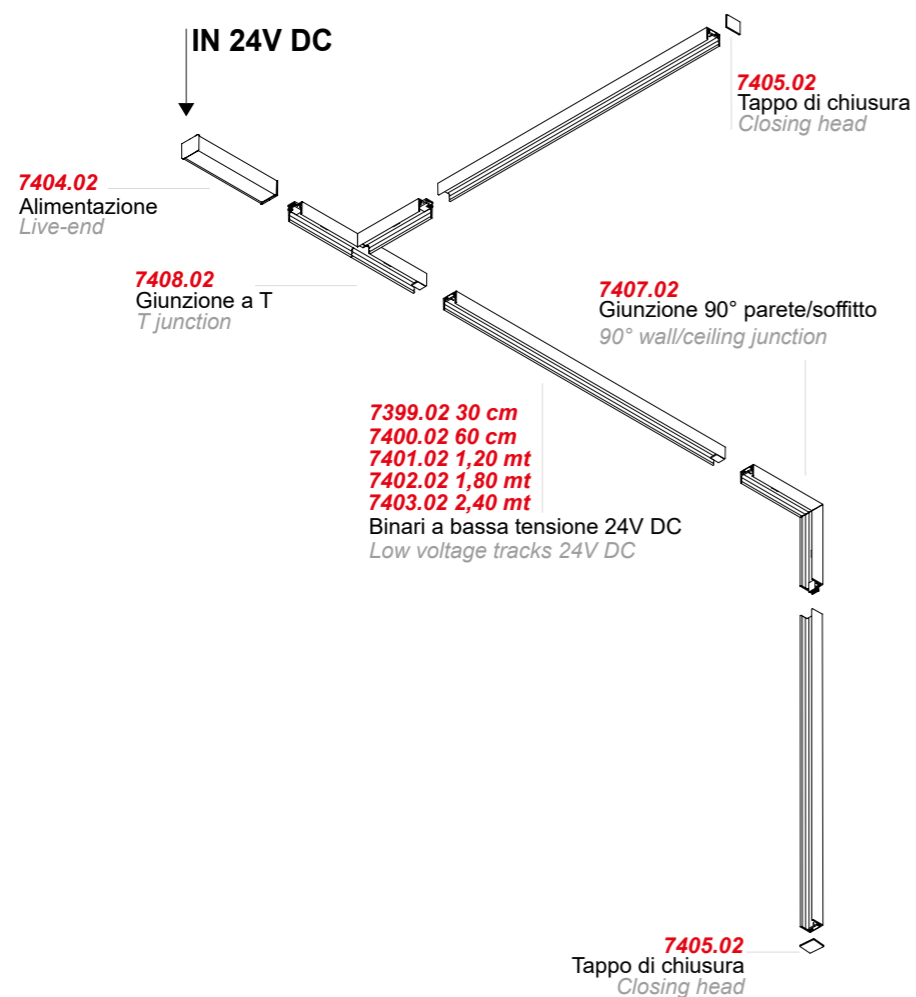

Accessori - Accessories

- | | | | |
|-----------------------------------------------------------------------------------|--------------------------------------------------------------------------|-----------------------------------------------------------------------------|------------------------------------------------------------------------------------------------------------------|
|
7404
Testata di alimentazione
Live end Power
.02 Nero - Black |
7405
Tappo di chiusura
Closing head
.02 Nero - Black |
7406
Set di connessione
Connection set
.02 Nero - Black |
7407
Giunzione a 90°
per soffitto/parete
90° junction for ceiling / wall
.02 Nero - Black |
|
7408
Giunzione a T
T junction
.02 Nero - Black |
7409
Giunzione a X
X joint
.02 Nero - Black |
7410
Giunzione a 90°
90° junction
.02 Nero - Black |
7411
Copertura binario 1 mt
Track cover 1 mt
.02 Nero - Black |

Drivers ON/OFF

- | | |
|---------------------------------------------------------------------|----------------------------------------------------------------------------------|
| 0156
IN: 220 - 240V
OUT: 24V - 25W
KEMA SELV 6 cm | 1 - 6 (Newton micro - Segmento mini - Segmento mini dark)
1 - 3 Newton mini |
| 0157
IN: 220 - 240V
OUT: 24V - 75W
KEMA SELV 6,8 cm | 1 - 18 (Newton micro - Segmento mini - Segmento mini dark)
1 - 10 Newton mini |
| 0160
IN: 220 - 240V
OUT: 24V - 50W
KEMA SELV 6,6 cm | 1 - 12 (Newton micro - Segmento mini - Segmento mini dark)
1 - 7 Newton mini |

Schema cablaggio accensione ON/OFF
Ignition ON/OFF Wiring Diagram

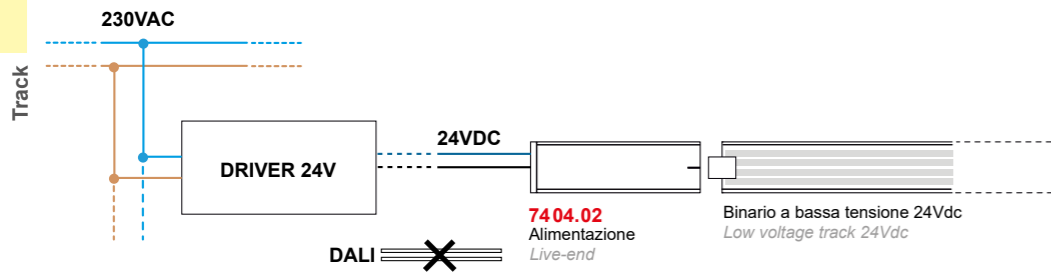

NEWTON MICRO - MEWTON MINI TRACK 24V

Faretti orientabili con corpo in alluminio e attacco magnetico da installare nei binari elettrificati 24V DC a bassa tensione da superficie.

Possono essere ruotati fino a 350° sul piano orizzontale e inclinati fino a 90° sull'asse verticale.

Dimmerazione DALI e altre tonalità di luce bianca (2700K e 4000K) disponibili su richiesta.

Adjustable spotlights with aluminum body and magnetic connection to be installed in 24V DC low voltage surface mounted electrified tracks.

They can be rotated up to 350° in the horizontal plane and tilted up to 90° on the vertical axis.

DALI dimming and other white light tones (2700K and 4000K) available on request.

Projecteurs orientables avec corps en aluminium et connexion magnétique à installer sur des rails électrifiés en saillie basse tension 24V DC.

Ils peuvent être tournés jusqu'à 350° dans le plan horizontal et inclinés jusqu'à 90° sur l'axe vertical.

Gradation DALI et autres tons de lumière blanche (2700K et 4000K) disponibles sur demande.

Ausrichtbare Strahler mit Aluminiumkörper und magnetischer Verbindung zum Einbau in 24-V-DC-Niederspannungs-Stromschienen zur Oberflächenmontage.

Sie können in der Horizontalen um bis zu 350° gedreht und bis zu geneigt werden 90° auf der vertikalen Achse.

DALI-Dimmung und andere Weißlichttöne (2700K und 4000K) auf Anfrage erhältlich.

Регулируемые прожекторы с алюминиевым корпусом и магнитным соединением для установки в электрифицированные рельсы низкого напряжения постоянного тока 24 В постоянного тока.

Их можно поворачивать до 350° в горизонтальной плоскости и наклонять вверх до 90° по вертикальной оси.

Диммирование DALI и другие тона белого света (2700K и 4000K) доступны по запросу.

NEWTON MICRO

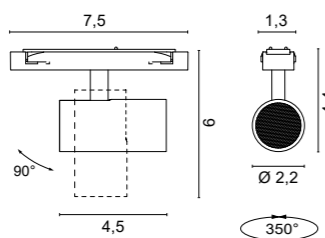

6722 Newton micro

.02 Nero - Black

Color temperature	LED Light source	lm output
3000K	4W	310lm

A richiesta disponibile 2700K - 4000K
On request 2700K - 4000K



0,04 Kg

NEWTON MINI

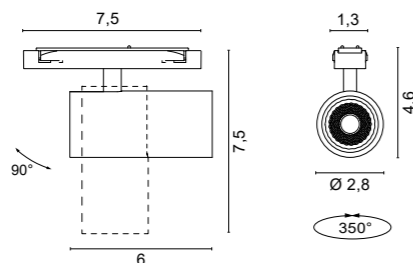

6723 Newton mini

.02 Nero - Black

Color temperature	Optics	LED Light source	lm output
3000K	/24 /38	24V DC 7W	430lm

A richiesta disponibile 2700K - 4000K
On request 2700K - 4000K



0,06 Kg

Drivers ON/OFF

Cod.	0156	0157	0160	0162
	IN: 100 - 240V OUT: 24V - 25W	IN: 220 - 240V OUT: 24V - 75W	IN: 220 - 240V OUT: 24V - 50W	IN: 2200 - 240V OUT: 24V - 150W
6722	3	10	6	20
6723	2	7	4	14

TINY - TRACK 24V

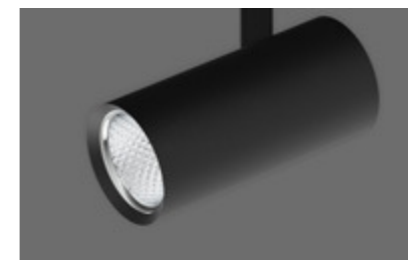

SEGMENTO MINI

Linea di luce opale a luce diffusa di 30 cm con attacco magnetico da installare nei binari elettrificati 24V DC a bassa tensione da superficie.

SEGMENTO DARK MINI

Linea di luce diretta con griglia di 15 cm. Attacco magnetico da installare nei binari elettrificati 24V DC a bassa tensione da superficie. Fascio luminoso a 60°.

SEGMENTO MINI

30 cm line of opal diffuse light with magnetic attachment to be installed in the 24V DC low voltage electrified tracks, surface mounting.

SEGMENTO DARK MINI

15 cm grid line of light with magnetic attachment to be installed in the 24V DC low voltage electrified tracks, surface mounting. 60° light beam.

SEGMENTO MINI

Ligne de lumière diffuse opale de 30 cm avec fixation magnétique à installer dans les rails électrifiés basse tension 24V DC, montage en surface.

SEGMENTO DARK MINI

Grille lumineuse de 15 cm avec fixation magnétique à installer dans les rails électrifiés basse tension 24V DC, montage en saillie. Faisceau lumineux 60°

Dimmerazione DALI e altre tonalità di luce bianca (2700K e 4000K) disponibili su richiesta.

DALI dimming and other white light tones (2700K and 4000K) available on request.

Gradation DALI et autres tons de lumière blanche (2700K et 4000K) disponibles sur demande.

SEGMENTO MINI

Linea de 30 cm de luz difusa opal con fijación magnética para instalar en carril electrificado de baja tensión 24V DC, montaje en superficie.

SEGMENTO MINI

30 cm breites opalfarbenes diffuses Licht mit magnetischer Befestigung zum Einbau in 24-V-DC-Niederspannungsstromschienen, Oberflächenmontage.

SEGMENTO MINI

Линия рассеянного света опалового цвета длиной 30 см с магнитным креплением для установки в электрифицированных шинах низкого напряжения 24 В пост. тока, поверхностный монтаж.

SEGMENTO DARK MINI

Linea de luz de rejilla de 15 cm con fijación magnética para instalar en los carriles electrificados de baja tensión de 24 V CC, montaje en superficie. haz de luz de 60°

SEGMENTO DARK MINI

15 cm Rasterlichtlinie mit magnetischer Befestigung zum Einbau in die 24V DC Niedervolt Stromschienen, Aufputzmontage. 60° Lichtstrahl.

SEGMENTO DARK MINI

Световая решетка шириной 15 см с магнитным креплением для установки на электрифицированных направляющих низкого напряжения 24 В пост. тока, поверхностный монтаж. Световой луч 60°.

Regulación DALI y otros tonos de luz blanca (2700K y 4000K) disponibles bajo pedido.

DALI-Dimmung und andere Weißlichttöne (2700K und 4000K) auf Anfrage erhältlich.

Диммирование DALI и другие тона белого света (2700K и 4000K) доступны по запросу.

SEGMENTO MINI

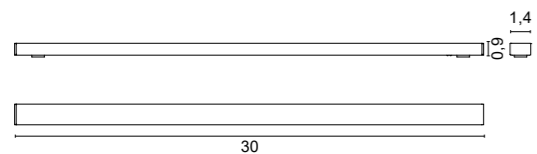

6724 Segmento mini		
.02 Nero - Black		
Color temperature	LED Light source	lm output
WW 3000K	4W	290lm
A richiesta disponibile 2700K - 4000K On request 2700K - 4000K		
		0,03 Kg

SEGMENTO DARK MINI

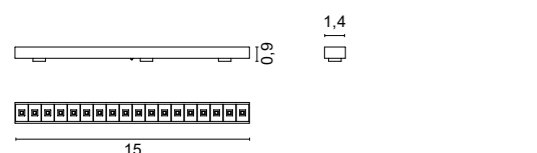
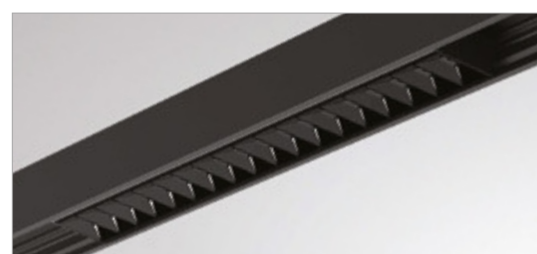

6725 Segmento dark mini		
.02 Nero - Black		
Color temperature	LED Light source	lm output
WW 3000K	4W	120lm
A richiesta disponibile 2700K - 4000K On request 2700K - 4000K		
		0,02 Kg

Drivers ON/OFF				
Cod.	0156	0157	0160	0162
	IN: 100 - 240V OUT: 24V - 25W	IN: 220 - 240V OUT: 24V - 75W	IN: 220 - 240V OUT: 24V - 50W	IN: 2200 - 240V OUT: 24V - 150W
6723	3	10	6	20
6724	3	10	6	20



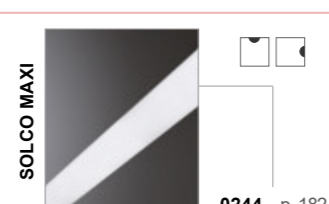
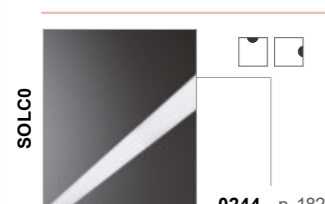
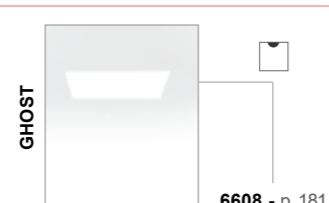
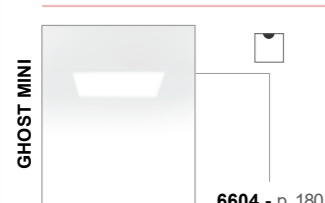
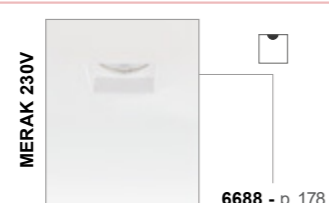
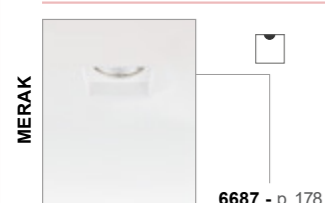
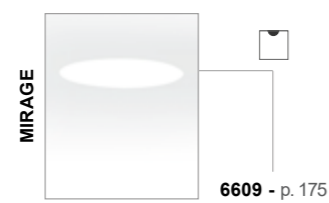
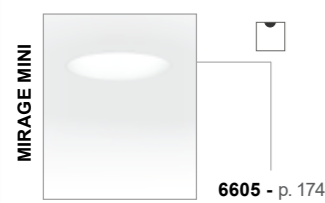
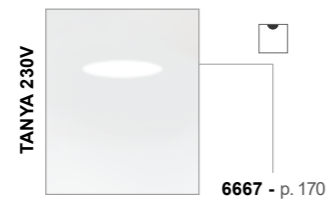
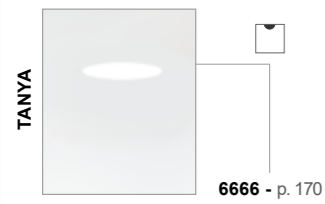

Collezione di lampade da incasso a scomparsa totale per installazioni in soffitti di cartongesso.
L'installazione prevede operazioni di stuccatura, rasatura e verniciatura.
Il risultato finale è la completa integrazione del corpo luce con l'architettura senza la presenza di sporgenze o cornici esterne. Disponibili in varie forme, dimensioni e differenti soluzioni di luce.

Colección de lámparas empotradas totalmente desaparecidas para instalación en techos de pladur.
La instalación implica lechada, afeitado y pintura.
El resultado final es la integración completa del cuerpo de luz con la arquitectura sin la presencia de protuberancias o marcos externos. Disponible en varias formas, tamaños y diferentes soluciones de luz.

Collection of recessed trimless lamps for installations in plasterboard ceilings.
The installation involves grouting, smoothing and painting.
The end result is the complete integration of the body with the architecture without the presence of external frames. Available in various shapes, sizes and different light solutions.

Einbauleuchtersammlung zum Einbau in komplett verschwindende Gipskartondecken.
Die Installation beinhaltet Verfugen, Glätten und Streichen.
Das Endergebnis ist die vollständige Integration des Lichtkörpers in die Architektur, ohne dass Vorsprünge oder äußere Rahmen vorhanden sind.
Erhältlich in verschiedenen Formen, Größen und verschiedenen Lichtlösungen.

Collection de lampes encastrées totalement disparues pour une installation dans des plafonds en plaques de plâtre.
L'installation comprend le jointoiement, le rasage et la peinture.
Le résultat final est l'intégration complète du corps de lumière avec l'architecture sans la présence de saillies ou de cadres externes. Disponible en différentes formes, tailles et différentes solutions d'éclairage.

Collección de lámparas empotradas totalmente desaparecidas para instalación en techos de pladur.
La instalación implica lechada, afeitado y pintura.
El resultado final es la integración completa del cuerpo de luz con la arquitectura sin la presencia de protuberancias o marcos externos. Disponible en varias formas, tamaños y diferentes soluciones de luz.

Architural

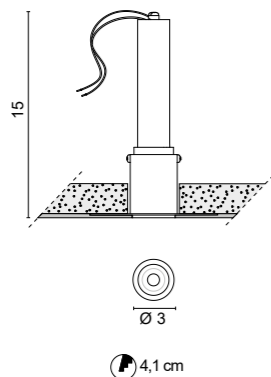
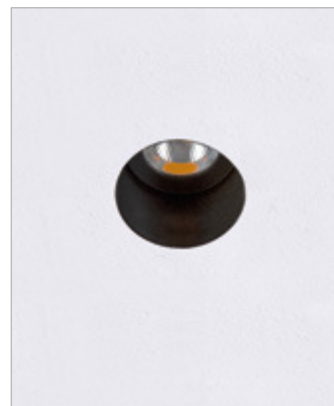

6689 Star zero

- .01 Bianco - White
- .02 Nero - Black

	Color temperature	Optics	LED light source	lm source	lm output
<i>/W</i>	4000K	<i>/25 /48 /63</i>	5,9W 17V 350mA	1060lm	880lm
<i>/W</i>	4000K	<i>/ST</i> Satinato - Satin	5,9W 17V 350mA	1060lm	816lm
<i>/WW</i>	3000K	<i>/25 /48 /63</i>	5,9W 17V 350mA	1030lm	855lm
<i>/WW</i>	3000K	<i>/ST</i> Satinato - Satin	5,9W 17V 350mA	1030lm	793lm
<i>/XW</i>	2700K	<i>/25 /48 /63</i>	5,9W 17V 350mA	969lm	804lm
<i>/XW</i>	2700K	<i>/ST</i> Satinato - Satin	5,9W 17V 350mA	969lm	746lm

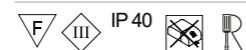

0,30 Kg

IP54 su richiesta - IP54 upon request

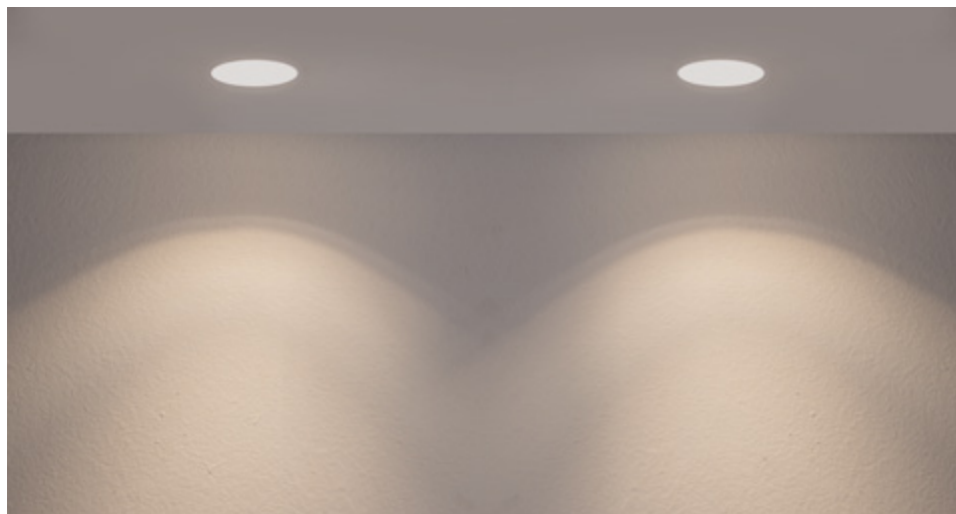

Drivers

* Drivers ON/OFF				DIMMABLE drivers					Casambi	LED emergency unit
Cod.	0136/15	0125	0128	0141/DIM	0141/DALI	0145	0145/DALI	0733/DIM	0145/CASA	0115/EM
	350mA	350mA	350mA	PUSH - 1...10V	DIM DALI	DIM	DIM DALI	PHASE CUT		Inverter + Battery + LED indicator
6690	1-2	1	1-2	1-2	1-2	1-3	1-3	1	1-3	1
6691	1-2	1	1-2	1-2	1-2	1-3	1-3	1	1-3	1

Solo collegamento in serie - Only serial connection

*

I drivers **0136/15** può passare dal foro incasso del faretto
 Il driver **0136/15** può essere inserito anche con cassaforma montata

Driver **0136/15** can pass through the recessed hole of the spotlight
 The driver **0136/15** can also be inserted with a mounted formwork

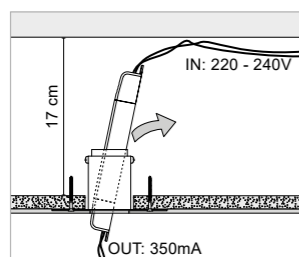

Installazione con cassaforma
 Installation with wall box

Architural



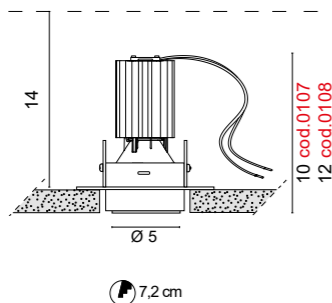
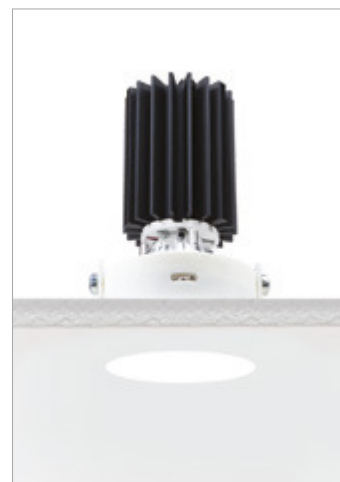

Glass diffuser

6666 Tanya
 .57 Vetro bianco - White glass
 F III 0,15 Kg

6666 + COB LED CRI>90

Color temperature	Optics	COB LED light source	lm source	lm output
0107/W	4000K /24 /40 /60 /ST	5,9W 17V 350mA	885lm	695lm
0107/WW	3000K /24 /40 /60 /ST	5,9W 17V 350mA	836lm	657lm
0107/XW	2700K /24 /40 /60 /ST	5,9W 17V 350mA	800lm	629lm
0108/W	4000K /24 /40 /60 /ST	8,7W 17,5V 500mA	1223lm	957lm
0108/WW	3000K /24 /40 /60 /ST	8,7W 17,5V 500mA	1156lm	905lm
0108/XW	2700K /24 /40 /60 /ST	8,7W 17,5V 500mA	1106lm	865lm
0108/W/IP	4000K /24 /38 /58	IP54 8,7W 17,5V 500mA	1223lm	957lm
0108/WW/IP	3000K /24 /38 /58	IP54 8,7W 17,5V 500mA	1156lm	905lm
0108/XW/IP	2700K /24 /38 /58	IP54 8,7W 17,5V 500mA	1106lm	865lm

Drivers

Cod. LED	Drivers ON/OFF			DIMMABLE drivers						Casambi	LED emergency unit
	0125	0147/COB	0149/COB	0141/DIM	0141/DALI	0145/DALI	0145	0733/DIM	0734/DIM	0145/CASA	0115/EM
	350mA	500mA	500mA	PUSH - 1...10V	DIM DALI	DIM DALI	DIM	PHASE CUT	PHASE CUT		Inverter + Battery + LED indicator
0107 - COB LED	1	NO	NO	1-2	1-2	1-3	1-3	1	NO	1-3	1
0108 - COB LED	1	1-2	1	1-2	1-2	1-3	1-3	NO	1	1-3	1

Solo collegamento in serie - Only serial connection

TANYA 230V

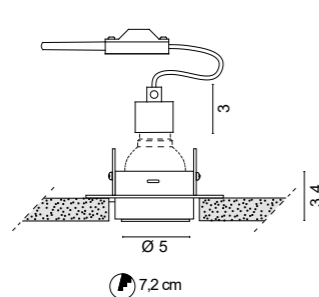

6667 Tanya 230V
 .57 Vetro bianco - White glass

Light sources
 7W GU10 LED DIM (cod. 0104/..)
 7W GU10 LED (cod. 0094/..)
 F III 0,20 Kg



Glass diffuser



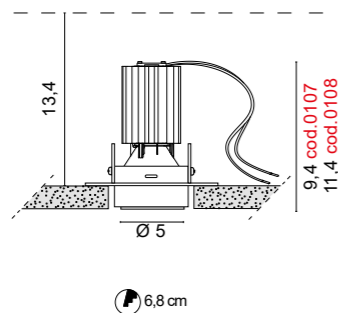

6668 Alya
 .01 Bianco - White
 F III 0,14 Kg

6668 + COB LED CRI>90

Color temperature	Optics	COB LED light source	lm source	lm output
0107/W 4000K	/24 /40 /60 /ST	5,9W 17V 350mA	885lm	695lm
0107/WW 3000K	/24 /40 /60 /ST	5,9W 17V 350mA	836lm	657lm
0107/XW 2700K	/24 /40 /60 /ST	5,9W 17V 350mA	800lm	629lm
0108/W 4000K	/24 /40 /60 /ST	8,7W 17,5V 500mA	1223lm	957lm
0108/WW 3000K	/24 /40 /60 /ST	8,7W 17,5V 500mA	1156lm	905lm
0108/XW 2700K	/24 /40 /60 /ST	8,7W 17,5V 500mA	1106lm	865lm
0108/W/IP 4000K	/24 /38 /58	IP54 8,7W 17,5V 500mA	1223lm	957lm
0108/WW/IP 3000K	/24 /38 /58	IP54 8,7W 17,5V 500mA	1156lm	905lm
0108/XW/IP 2700K	/24 /38 /58	IP54 8,7W 17,5V 500mA	1106lm	865lm

Drivers

Cod. LED	Drivers ON/OFF			DIMMABLE drivers					Casambi	LED emergency unit	
	0125	0147/COB	0149/COB	0141/DIM	0141/DALI	0145/DALI	0145	0733/DIM	0734/DIM	0145/CASA	0115/EM
	350mA	500mA	500mA	PUSH - 1...10V	DIM DALI	DIM DALI	DIM	PHASE CUT	PHASE CUT		Inverter + Battery + LED indicator
0107 - COB LED	1	NO	NO	1-2	1-2	1-3	1-3	1	NO	1-3	1
0108 - COB LED	1	1-2	1	1-2	1-2	1-3	1-3	NO	1	1-3	1

Solo collegamento in serie - Only serial connection

ALYA 230V

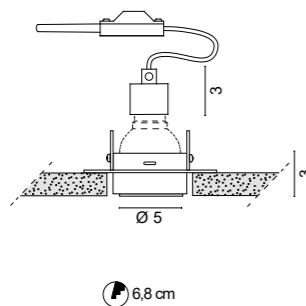

6669 Alya 230V
 .01 Bianco - White
 Light sources
 7W GU10 LED DIM (cod. 0104/..)
 7W GU10 LED (cod. 0094/..)
 F 0,20 Kg



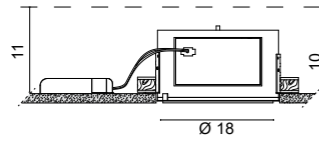

6605 Mirage mini
 .01 Bianco - White

Color temperature		LED Light source		lm source
<i>/W</i>	4000K	ON/OFF	11,9W	1811lm
<i>/WW</i>	3000K	ON/OFF	11,9W	1701lm

Color temperature		Dimming	LED Light source		lm source
<i>/W</i>	4000K	<i>/DALI</i>	11,9W	1811lm	
<i>/WW</i>	3000K	<i>/DIM 1...10V - PUSH</i>	11,9W	1811lm	
<i>/W</i>	4000K	<i>/DALI</i>	11,9W	1701lm	
<i>/WW</i>	3000K	<i>/DIM 1...10V - PUSH</i>	11,9W	1701lm	

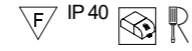

1,90 Kg



Methacrylate diffuser



Cod. LED	LED emergency unit
6605	0115/EM Inverter + Battery + LED indicator 1

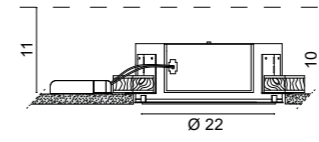

6609 Mirage
 .01 Bianco - White

Color temperature		LED Light source		lm source
<i>/W</i>	4000K	ON/OFF	17,2W	2617lm
<i>/WW</i>	3000K	ON/OFF	17,2W	2452lm

Color temperature		Dimming	LED Light source		lm source
<i>/W</i>	4000K	<i>/DALI</i>	17,2W	2617lm	
<i>/WW</i>	3000K	<i>/DIM 1...10V - PUSH</i>	17,2W	2617lm	
<i>/W</i>	4000K	<i>/DALI</i>	17,2W	2452lm	
<i>/WW</i>	3000K	<i>/DIM 1...10V - PUSH</i>	17,2W	2452lm	

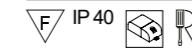

2,50 Kg



Methacrylate diffuser



Cod. LED	LED emergency unit
6609	0115/EM Inverter + Battery + LED indicator 1



Architectural

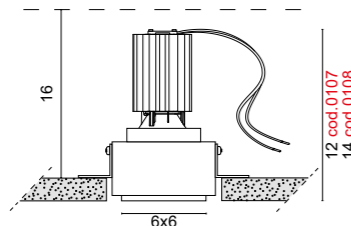
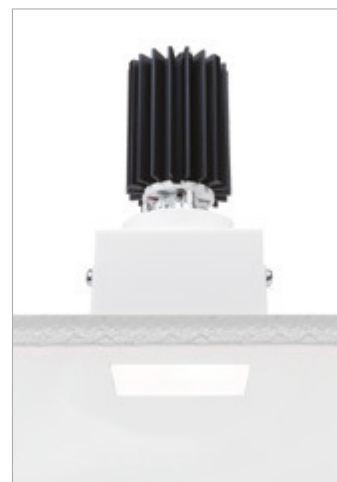

Glass diffuser

6685 Kuma
 .57 Vetro bianco - White glass
 F III CRI >90 0,15 Kg

6685 + COB LED CRI>90

Color temperature	Optics	COB LED light source	lm source	lm output
0107/W	4000K /24 /40 /60 /ST	5,9W 17V 350mA	885lm	695lm
0107/WW	3000K /24 /40 /60 /ST	5,9W 17V 350mA	836lm	657lm
0107/XW	2700K /24 /40 /60 /ST	5,9W 17V 350mA	800lm	629lm
0108/W	4000K /24 /40 /60 /ST	8,7W 17,5V 500mA	1223lm	957lm
0108/WW	3000K /24 /40 /60 /ST	8,7W 17,5V 500mA	1156lm	905lm
0108/XW	2700K /24 /40 /60 /ST	8,7W 17,5V 500mA	1106lm	865lm
0108/W/IP	4000K /24 /38 /58	IP54 8,7W 17,5V 500mA	1223lm	957lm
0108/WW/IP	3000K /24 /38 /58	IP54 8,7W 17,5V 500mA	1156lm	905lm
0108/XW/IP	2700K /24 /38 /58	IP54 8,7W 17,5V 500mA	1106lm	865lm

Drivers

Cod. LED	Drivers ON/OFF			DIMMABLE drivers					Casambi	LED emergency unit	
	0125	0147/COB	0149/COB	0141/DIM	0141/DALI	0145/DALI	0145	0733/DIM	0734/DIM	0145/CASA	0115/EM
	350mA	500mA	500mA	PUSH - 1...10V	DIM DALI	DIM DALI	DIM	PHASE CUT	PHASE CUT		Inverter + Battery + LED indicator
0107 - COB LED	1	NO	NO	1-2	1-2	1-3	1-3	1	NO	1-3	1
0108 - COB LED	1	1-2	1	1-2	1-2	1-3	1-3	NO	1	1-3	1

Solo collegamento in serie - Only serial connection

KUMA 230V

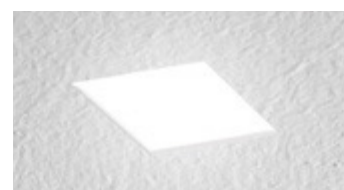
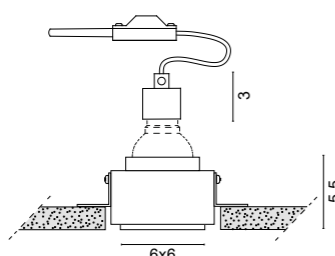

Glass diffuser

6686 Kuma 230V
 .57 Vetro bianco - White glass
 Light sources
 7W GU10 LED DIM (cod. 0104/..)
 7W GU10 LED (cod. 0094/..)
 F □ 0,20 Kg



Architectural



Architectural

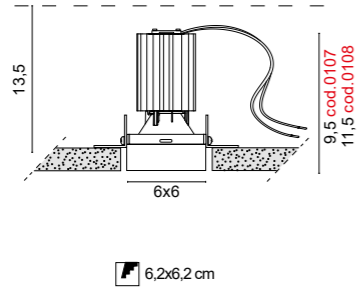

6687 Merak
 .01 Bianco - White
 F III 0,14 Kg

6686 + COB LED CRI>90

Color temperature	Optics	COB LED light source	lm source	lm output
0107/W	4000K /24 /40 /60 /ST	5,9W 17V 350mA	885lm	695lm
0107/WW	3000K /24 /40 /60 /ST	5,9W 17V 350mA	836lm	657lm
0107/XW	2700K /24 /40 /60 /ST	5,9W 17V 350mA	800lm	629lm
0108/W	4000K /24 /40 /60 /ST	8,7W 17,5V 500mA	1223lm	957lm
0108/WW	3000K /24 /40 /60 /ST	8,7W 17,5V 500mA	1156lm	905lm
0108/XW	2700K /24 /40 /60 /ST	8,7W 17,5V 500mA	1106lm	865lm
0108/W/IP	4000K /24 /38 /58	IP54 8,7W 17,5V 500mA	1223lm	957lm
0108/WW/IP	3000K /24 /38 /58	IP54 8,7W 17,5V 500mA	1156lm	905lm
0108/XW/IP	2700K /24 /38 /58	IP54 8,7W 17,5V 500mA	1106lm	865lm

Drivers

Cod. LED	Drivers ON/OFF			DIMMABLE drivers					Casambi	LED emergency unit	
	0125	0147/COB	0149/COB	0141/DIM	0141/DALI	0145/DALI	0145	0733/DIM	0734/DIM	0145/CASA	0115/EM
	350mA	500mA	500mA	PUSH - 1...10V	DIM DALI	DIM DALI	DIM	PHASE CUT	PHASE CUT		Inverter + Battery + LED indicator
0107 - COB LED	1	NO	NO	1-2	1-2	1-3	1-3	1	NO	1-3	1
0108 - COB LED	1	1-2	1	1-2	1-2	1-3	1-3	NO	1	1-3	1

Solo collegamento in serie - Only serial connection

MERAK 230V

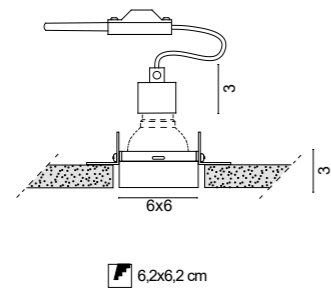

6688 Merak 230V
 .01 Bianco - White
 Light sources
 7W GU10 LED DIM (cod. 0104/..)
 7W GU10 LED (cod. 0094/..)
 F 0,19 Kg

Architectural

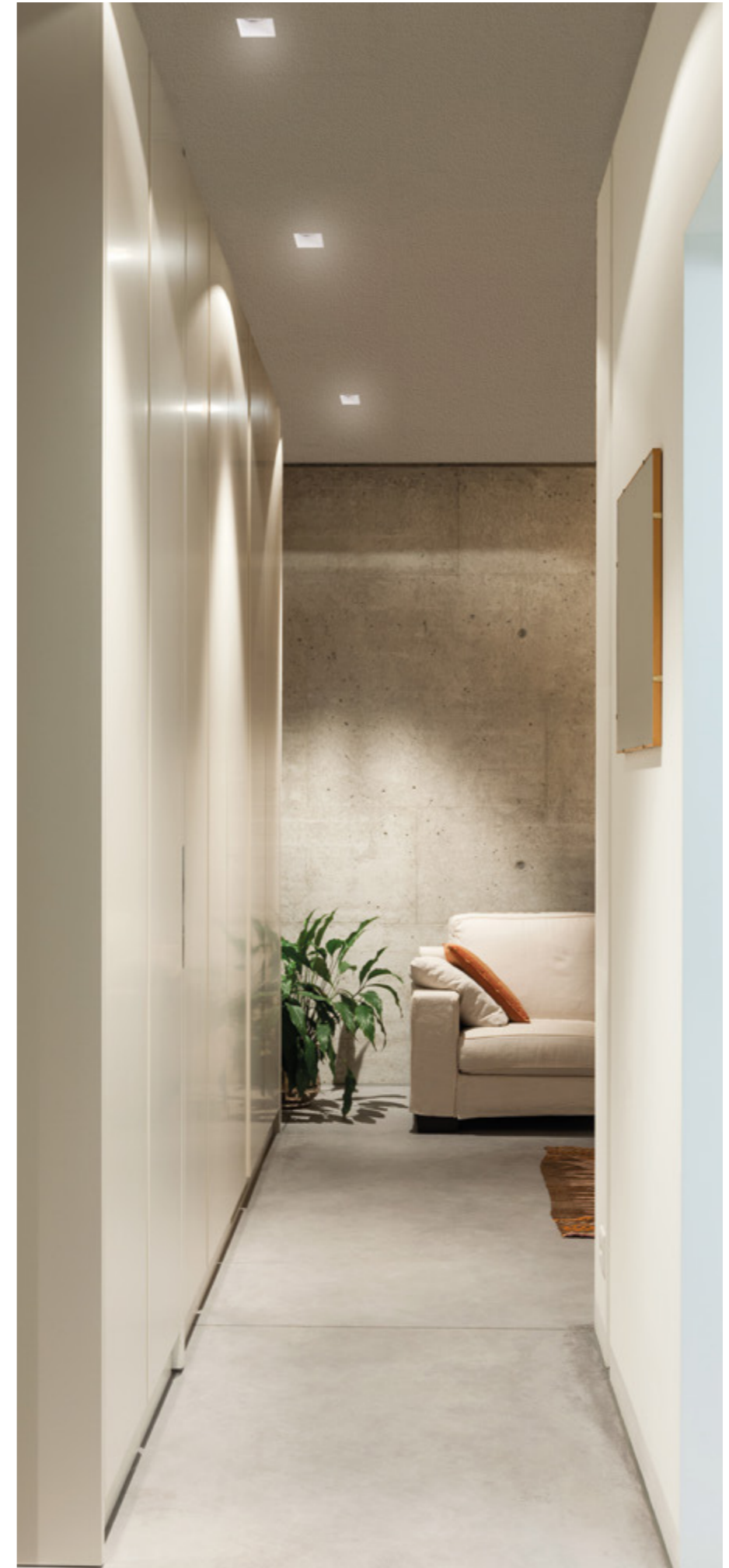

Architectural

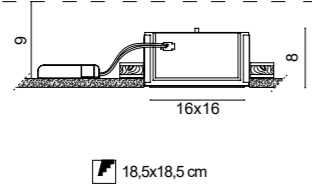

6604 Ghost mini
 .01 Bianco - White

Color temperature		LED Light source		lm source
/W	4000K	ON/OFF	11,9W	1811lm
/WW	3000K	ON/OFF	11,9W	1701lm

Color temperature		Dimming	LED Light sources	lm source
/W	4000K	/DALI	11,9W	1811lm
/WW	3000K	/DIM 1...10V - PUSH	11,9W	1811lm
/W	4000K	/DALI	11,9W	1701lm
/WW	3000K	/DIM 1...10V - PUSH	11,9W	1701lm



1,90 Kg

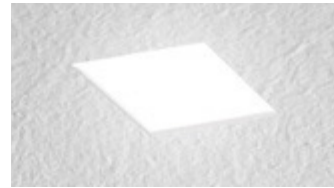

Methacrylate diffuser



Cod. LED	LED emergency unit
6604	0115/EM Inverter + Battery + LED indicator 1

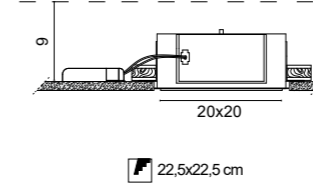

6608 Ghost
 .01 Bianco - White

Color temperature		LED Light source		lm source
/W	4000K	ON/OFF	17,2W	2617lm
/WW	3000K	ON/OFF	17,2W	2452lm

Color temperature		Dimming	LED Light source	lm source
/W	4000K	/DALI	17,2W	2617lm
/WW	3000K	/DIM 1...10V - PUSH	17,2W	2617lm
/W	4000K	/DALI	17,2W	2452lm
/WW	3000K	/DIM 1...10V - PUSH	17,2W	2452lm

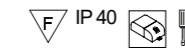

2,40 Kg

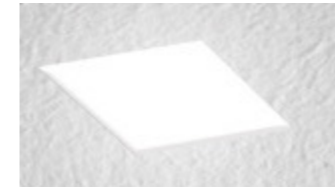

Methacrylate diffuser



Cod. LED	LED emergency unit
6608	0115/EM Inverter + Battery + LED indicator 1



Architectural

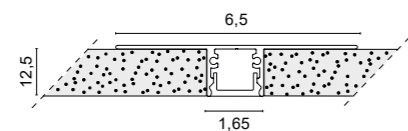

1,65x L cm

Solco	L	
0244/150/SOL1	151,5 cm	0,55 Kg
0244/300/SOL1	301,5 cm	1,05 Kg

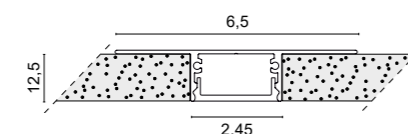

2,45x L cm

Solco maxi	L	
0244/150/SOL2	151,5 cm	0,60 Kg
0244/300/SOL2	301,5 cm	1,20 Kg

I profili sono compresi di 2 schermi, il primo per la protezione durante l'installazione in cartongesso, il secondo per la diffusione della luce.
The profiles include 2 screens, the first for protection during plasterboard installation, the second for light diffusion.

Accessori - Accessories



0245T/SOL1
2 testate di chiusura per art. 0244/.../SOL1
2 end stoppers for art. 0244/.../SOL1



0245T/SOL2
2 testate di chiusura per art. 0244/.../SOL2
2 end stoppers for 0244/.../SOL2

Strip LED

cm.	watt	2700K (XW) Im/mt source	3000K (WW) Im/mt source	4000K (W) Im/mt source
500	14,4Wmt - 240LED/mt - CRI>94 - IP20	5511.14.4/XW 1680	5511.14.4/WW 1730	5511.14.4/W 1890
500	19,2Wmt - 240LED/mt - CRI>94 - IP20	5511.19.2/XW 2220	5511.19.2/WW 2310	5511.19.2/W 2490

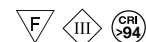

Drivers

Drivers ON/OFF

Cod.	0155	0156	0160	0157	0161/100	0162
	24V-13W	24V-25W	24V-50W	24V-75W	24V-100W	24V-150W

DIMMABLE drivers

Cod.	0110/DIM	0717/DIM60V	0717/DIM60	0717/DIM100
	12/24V	24V-60W 1...10V	24V-60W PUSH - DALI	24V-100W 1...10V - PUSH - DALI









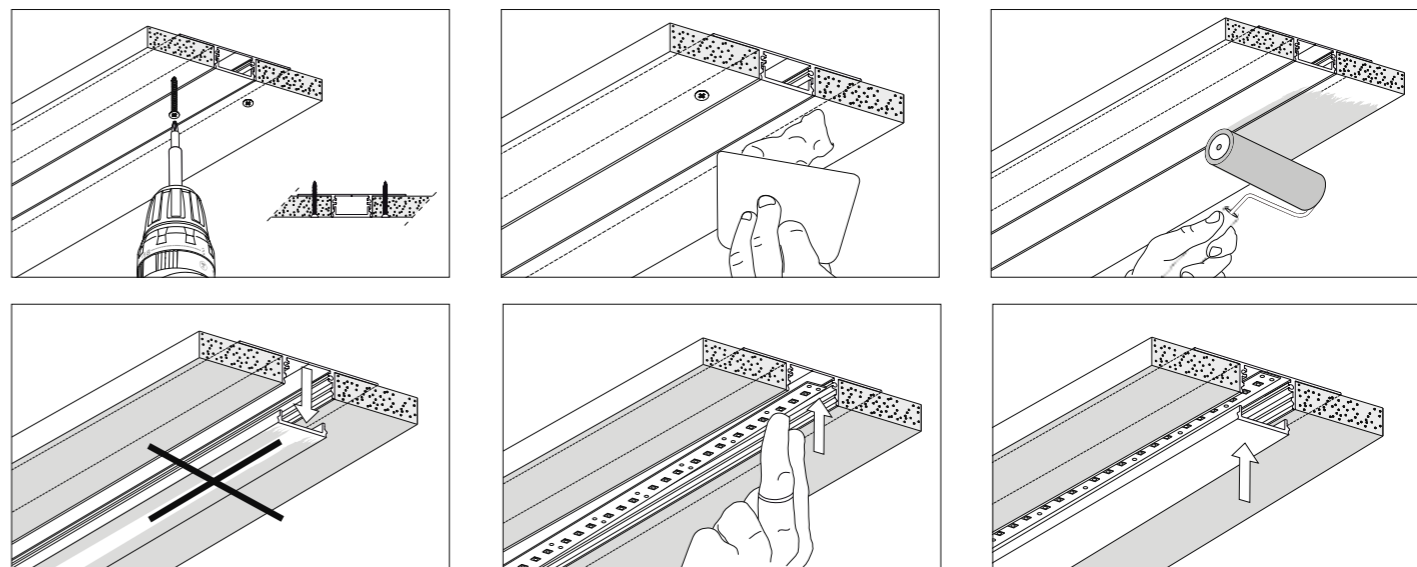







LED emergency unit







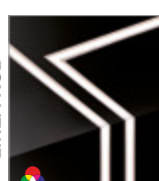

Cod.	0115EM
	Inverter + Battery + LED indicator



Indicazioni per una corretta installazione su cartongesso. Instructions for correct installation on plasterboard.

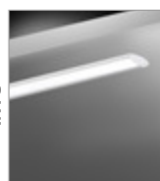

TRE&SESSANTA		1662 - p. 188
LANCIA CAVO		1565 - p. 192
LANCIA NO LIMITS CAVO		1672 - p. 194
LANCIA TONDA CAVO		1171 - p. 200 1172 - p. 200 1173 - p. 200
EDISON SYSTEM		5612 - p. 204
EDISON SYSTEM		1598 - p. 204
RAIL SYSTEM		5542 - p. 210 5543 - p. 210
RAIL SYSTEM		1544 - p. 216 1543 - p. 216
NEWTON RAIL		6347 - p. 220
NEWTON FLAT RAIL		6475 - p. 222
NEWTON SLIM RAIL		6474 - p. 223
RAIL SYSTEM		4580 - p. 224 4581 - p. 224
RAIL SYSTEM RECESSED		6660 - p. 230
LINEA		6615 - p. 236 6616 - p. 236
LINEA RGB		6617 - p. 236 6618 - p. 236
LINEA MAXI		6655 - p. 240 6656 - p. 240
LINEA MAXI RGB		6657 - p. 240 6658 - p. 240

EXTRA		4521 - p. 246
MARGO		4520 - p. 248
PLANA		4515 - p. 250
MAGIKA		4522 - p. 252 4523 - p. 256
INTO		6661 - p. 258
VELA		4589 - p. 000
RIGA		5613 - p. 258
RIGA SOSPENSIONE		1684 - p. 259
CEILING ROSE		230V - p. 260 350mA - p. 262 24V - p. 264



TRE&SESSANTA *design: U.T. EGOLUCE*

Lampada a sospensione a luce diffusa con corpo in metacrilato trasparente e tappi di chiusura in alluminio anodizzato. La sorgente luce è realizzata con un doppio circuito LED contrapposto avvolto da un estruso di silicone bianco. La caratteristica della lampada è proprio l'emissione della luce a 360° che è priva di ombre e parti scure per tutta la sua lunghezza. Questo la rende ideale per illuminare, singolarmente o in gruppi di più elementi, vani scala o ambienti molto alti. Il rosone con l'alimentatore, dimensionato in funzione degli elementi illuminanti che si decide di utilizzare, è da ordinare separatamente.

Suspension lamp with diffused light with transparent methacrylate body and anodized aluminum caps. The light source is made with a double opposing LED circuit wrapped in an extruded white silicone. The characteristic of the lamp is precisely the 360° light emission which is free of shadows and dark parts along its entire length. This makes it ideal for illuminating, individually or in groups of several elements, stairwells or very high environments. The ceiling rose with the driver, sized according to the lighting elements that you decide to use, must be ordered separately.

Lampe à suspension à lumière diffuse avec corps en méthacrylate transparent et culots en aluminium anodisé. La source lumineuse est constituée d'un double circuit LED opposé enveloppé dans un silicone blanc extrudé. La caractéristique de la lampe est précisément l'émission de lumière à 360° qui est exempte d'ombres et de parties sombres sur toute sa longueur. Cela le rend idéal pour éclairer, individuellement ou en groupes de plusieurs éléments, des cages d'escalier ou des environnements très élevés. La rosace avec l'alimentation, dimensionnée en fonction des éléments d'éclairage que vous décidez d'utiliser, doit être commandée séparément.

Lámpara de suspensión de luz difusa con cuerpo de metacrilato transparente y casquillos de aluminio anodizado. La fuente de luz está fabricada con un doble circuito LED opuesto envuelto en una silicona blanca extrusionada. La característica de la lámpara es precisamente la emisión de luz de 360° libre de sombras y partes oscuras en toda su longitud. Esto lo hace ideal para iluminar, individualmente o en grupos de varios elementos, huecos de escaleras o ambientes muy altos. El rosetón con la fuente de alimentación, dimensionado según los elementos de iluminación que decidas utilizar, se debe pedir por separado.

Pendelleuchte mit diffusem Licht mit transparentem Methacrylatkörper und Kappen aus eloxiertem Aluminium. Die Lichtquelle besteht aus einem doppelt gegenüberliegenden LED-Schaltkreis, der in ein extrudiertes weißes Silikon eingewickelt ist. Charakteristisch für die Leuchte ist gerade der 360°-Lichtaustritt, der über die gesamte Länge frei von Schatten und dunklen Partien ist. Dadurch ist sie ideal geeignet, um einzeln oder in Gruppen von mehreren Elementen Treppenhäuser oder sehr hohe Umgebungen zu beleuchten. Die Rosette mit Netzteil, die entsprechend den von Ihnen gewählten Beleuchtungselementen dimensioniert ist, muss separat bestellt werden.

Подвесной светильник рассеянного света с прозрачным корпусом из метакрилата и цоколями из анодированного алюминия. Источник света состоит из двойной цепи светодиодов, расположенных друг напротив друга, обернутых экструдированным белым силиконом. Характерной чертой лампы является именно излучение света на 360°, без теней и темных участков по всей длине. Это делает его идеальным для индивидуального или группового освещения лестничных клеток или очень высоких помещений. Окно-роза с блоком питания, размер которой соответствует элементам освещения, которые вы решите использовать, необходимо заказывать отдельно.

Lighting system

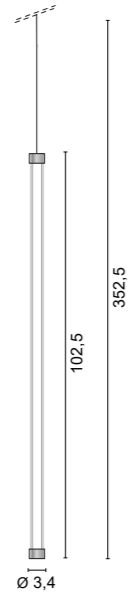

1662 Tre&sessanta

.23 Alluminio satinato - Satin aluminium

Color temperature	LED Light sources	lm source
/W 4000K	24V 20W	lm 2010
/WW 3000K	24V 20W	lm 1920
/XW 2700K	24V 20W	lm 1880

0,75 Kg

Rosoni con alimentatori da ordinare separatamente. (p. 264)
Ceiling roses with power supplies are to be ordered separately. (p. 264)



Lighting system

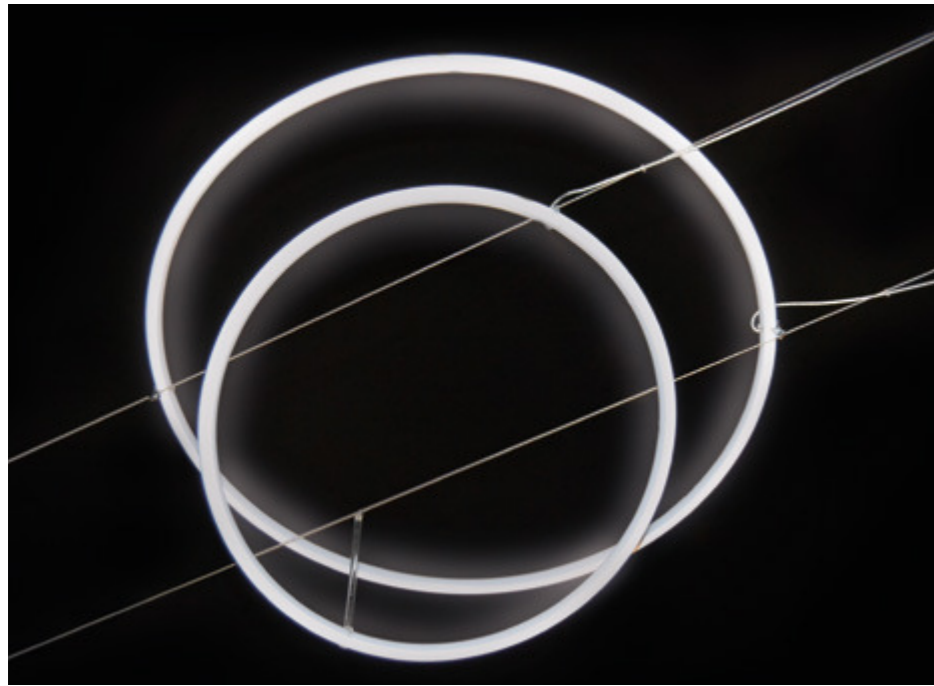

SYSTEM LANCIA CAVO

design: U.T. EGOLUCE

Sistemi di luce diffusa su cavi di acciaio. I modelli proposti sono lineari o tondi con corpo in trafilata di alluminio, diffusore in policarbonato opale e cavo coassiale.

I profili lineari della LANCIA CAVO di 100, 150, 200 e 300 cm sono disposti su un unico cavo d'acciaio. Possono ruotare sul proprio asse consentendo di avere una luce diffusa diretta o indiretta. Il rosone con l'alimentatore è compreso mentre i tenditori sono da ordinare separatamente.

Il sistema d'illuminazione lineare LANCIA NO LIMITS CAVO consente di creare linee di luce continue fino a 9 metri partendo da un solo punto di alimentazione. Il rosone con l'alimentatore ed i tenditori sono da ordinare separatamente.

FINITURE DISPONIBILI:

- .01 bianco
- .02 nero

Le LANCIA TONDA CAVO hanno un diametro di 35, 50 e 70 cm. I corpi sono posizionati in appoggio su una coppia di cavi d'acciaio e, con appositi accessori, possono essere ruotati e inclinati. Il rosone con l'alimentatore è compreso mentre i tenditori sono da ordinare separatamente.

FINITURE DISPONIBILI:

- .01 bianco
- .02 nero
- .25 dorato satinato
- .31 cromato

Il sistema consente di disporre le lampade lungo i cavi nel punto desiderato partendo da un'unica alimentazione a parete o a soffitto. Il rosone contiene l'alimentatore. Il cavo di acciaio è teso tra i due tenditori contrapposti e copre distanze fino a 10 mt.

La luce LED è disponibile a 2700K (XW), 3000K (WW) e 4000K (W) con un valore di CRI superiore a 90. Sono disponibili anche versioni dimmerabili.

Su richiesta sono fornite anche soluzioni che prevedono il collegamento di più corpi con cavi di alimentazione passanti da lampada a lampada.

Diffused light systems on steel cables. The proposed models are linear or round with a die-cast aluminum body, opal polycarbonate diffuser and coaxial cable.

The linear profiles of the LANCIA CAVO of 100, 150, 200 and 300 cm are arranged on a single steel cable. They can rotate on their axis allowing for direct or indirect diffused light. The ceiling rose with the driver is included while the tensors are to be ordered separately.

The LANCIA NO LIMITS CAVO linear lighting system allows you to create continuous lines of light up to 9 meters starting from a single power supply point. The ceiling rose with the driver and the tensors are to be ordered separately.

AVAILABLE FINISHES:

- .01 white
- .02 black

The LANCIA TONDA CAVO have a diameter of 35, 50 and 70 cm. The bodies rest on a pair of steel cables and, with special accessories, can be rotated and tilted. The ceiling rose with the driver is included while the tensors are to be ordered separately.

AVAILABLE FINISHES:

- .01 white
- .02 black
- .25 satin gold
- .31 chrome

The system allows you to arrange the lamps along the cables in the desired point starting from a single wall or ceiling power supply. The ceiling rose contains the driver. The steel cable is stretched between the two opposing turnbuckles and covers distances of up to 10 meters.

The LED light is available in 2700K (XW), 3000K (WW) and 4000K (W) with a CRI value higher than 90. Dimmable versions are also available.

Upon request, solutions are also supplied which envisage the connection of several bodies with power cables passing from lamp to lamp.

Systèmes de lumière diffuse sur câbles en acier. Les modèles proposés sont linéaires ou ronds avec un corps en aluminium moulé sous pression, un diffuseur en polycarbonate opale et un câble coaxial.

Les profils linéaires de la LANCIA CAVO de 100, 150, 200 et 300 cm sont disposés sur un seul câble en acier. Ils peuvent pivoter sur leur axe permettant une lumière diffuse directe ou indirecte. La rosace avec l'alimentation est incluse tandis que les tendeurs sont à commander séparément.

Le système d'éclairage linéaire LANCIA NO LIMITS CAVO vous permet de créer des lignes de lumière continues jusqu'à 9 mètres à partir d'un seul point d'alimentation. La rosace avec l'alimentation et les tendeurs sont à commander séparément.

FINITIONS DISPONIBLES:

- .01 blanc
- .02 noir

Les LANCIA TONDA CAVO ont un diamètre de 35, 50 et 70 cm. Les corps reposent sur une paire de câbles en acier et, avec des accessoires spéciaux, peuvent être tournés et inclinés. La rosace avec l'alimentation est incluse tandis que les tendeurs sont à commander séparément.

FINITIONS DISPONIBLES:

- .01 blanc
- .02 noir
- .25 or satiné
- .31 chromé

Le système vous permet de disposer les lampes le long des câbles à l'endroit souhaité à partir d'une seule alimentation murale ou au plafond. La rosette de plafond contient l'alimentation électrique. Le câble en acier est tendu entre les deux tendeurs opposés et couvre des distances allant jusqu'à 10 mètres.

La lumière LED est disponible en 2700K (XW), 3000K (WW) et 4000K (W) avec une valeur CRI supérieure à 90. Des versions dimmables sont également disponibles.

Sur demande, des solutions sont également fournies qui prévoient la connexion de plusieurs corps avec des câbles d'alimentation passant de lampe à lampe.

Sistemas de luz difusa sobre cables de acero. Los modelos propuestos son lineales o redondos con cuerpo de aluminio inyectado, difusor de policarbonato opal y cable coaxial.

Los perfiles lineales del LANCIA CAVO de 100, 150, 200 y 300 cm se disponen sobre un único cable de acero. Pueden girar sobre su eje permitiendo luz difusa directa o indirecta. Se incluye el rosetón con la fuente de alimentación, mientras que los tensores se piden por separado.

El sistema de iluminación lineal LANCIA NO LIMITS CAVO permite crear líneas continuas de luz de hasta 9 metros a partir de un único punto de alimentación. El rosetón con la fuente de alimentación y los tensores se piden por separado.

ACABADOS DISPONIBLES:

- .01 blanco
- .02 negro

Las LANCIA TONDA CAVO tienen un diámetro de 35, 50 y 70 cm. Los cuerpos descansan sobre un par de cables de acero y, con accesorios especiales, se pueden girar e inclinar. Se incluye el rosetón con la fuente de alimentación, mientras que los tensores se piden por separado.

ACABADOS DISPONIBLES:

- .01 blanco
- .02 negro
- .25 oro satinado
- .31 cromado

El sistema permite disponer las lámparas a lo largo de los cables en el punto deseado a partir de una única fuente de alimentación de pared o de techo. El rosetón del techo contiene la fuente de alimentación. El cable de acero se estira entre los dos tensores opuestos y cubre distancias de hasta 10 metros.

La luz LED está disponible en 2700K (XW), 3000K (WW) y 4000K (W) con un valor CRI superior a 90. También hay disponibles versiones regulables.

Bajo pedido también se suministran soluciones que prevén la conexión de varios cuerpos con cables de alimentación que pasan de lámpara a lámpara.

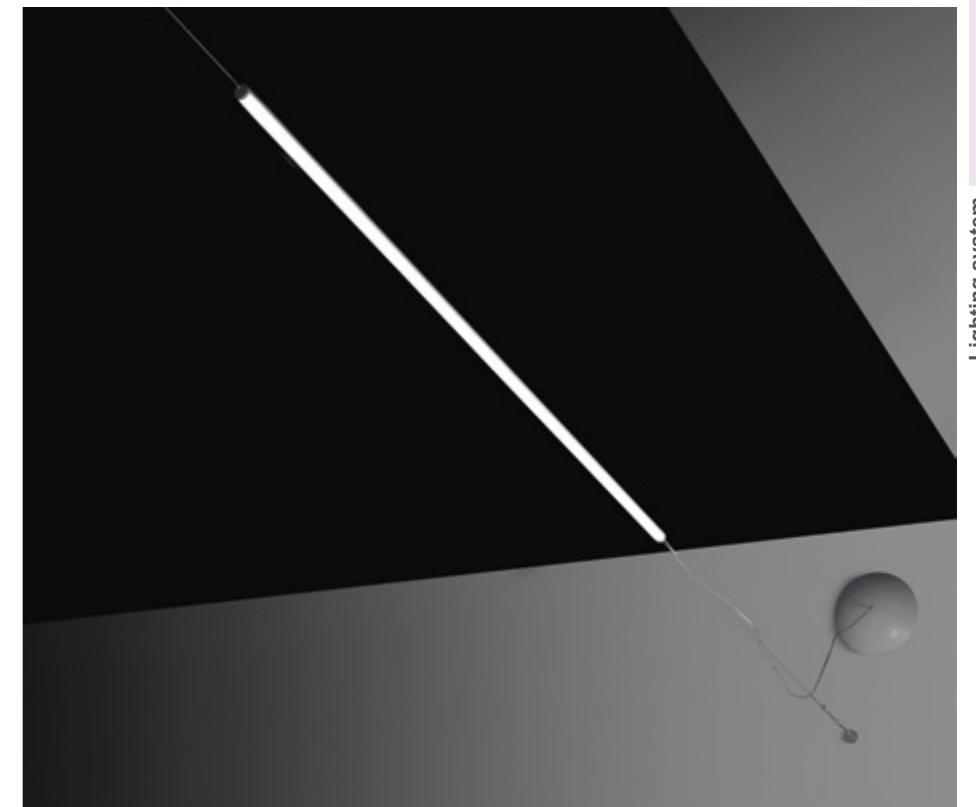

Systeme mit diffusen Licht an Stahlseilen. Die vorgeschlagenen Modelle sind linear oder rund mit einem Gehäuse aus Aluminiumdruckguss, einem Diffusor aus opalem Polycarbonat und einem Koaxialkabel.

Die linearen Profile des LANCIA CAVO von 100, 150, 200 und 300 cm sind an einem einzigen Stahlseil angeordnet. Sie können um ihre eigene Achse gedreht werden, was direktes oder indirektes Streulicht ermöglicht. Der Deckenbaldachin mit dem Netzteil ist im Lieferumfang enthalten, während die Spanner separat bestellt werden müssen.

Mit dem linearen Beleuchtungssystem LANCIA NO LIMITS CAVO können Sie ausgehend von einem einzigen Stromanschlusspunkt durchgehende Lichtlinien von bis zu 9 Metern erzeugen. Der Deckenbaldachin mit Netzteil und die Spanner sind separat zu bestellen.

VERFÜGBARE AUSFÜHRUNGEN:

- .01 weiß
- .02 schwarz

Die LANCIA TONDA CAVO haben einen Durchmesser von 35, 50 und 70 cm. Die Körper ruhen auf zwei Stahlseilen und sind mit speziellem Zubehör dreh- und neigbar. Der Deckenbaldachin mit dem Netzteil ist im Lieferumfang enthalten, während die Spanner separat bestellt werden müssen.

VERFÜGBARE AUSFÜHRUNGEN:

- .01 weiß
- .02 schwarz
- .25 Satingold
- .31 Chrom

Das System ermöglicht es Ihnen, ausgehend von einem einzigen Wand- oder Deckennetzteil, die Lampen entlang der Kabel an der gewünschten Stelle anzuordnen. Die Deckenrossette enthält die Stromversorgung. Das Stahlseil wird zwischen den beiden gegenüberliegenden Spannschlössern gespannt und überwindet Distanzen von bis zu 10 Metern.

Die LED-Leuchte ist in 2700K (XW), 3000K (WW) und 4000K (W) mit einem CRI-Wert von über 90 erhältlich. Dimmbare Versionen sind ebenfalls erhältlich.

Auf Wunsch werden auch Lösungen geliefert, die die Verbindung mehrerer Körper mit Stromkabeln von Leuchte zu Leuchte vorsehen.

Системы рассеянного света на стальных тросах. Предлагаемые модели имеют линейную или круглую форму с литым алюминиевым корпусом, рассеивателем из опалового поликарбоната и коаксиальным кабелем.

Линейные профили LANCIA CAVO длиной 100, 150, 200 и 300 см расположены на одном стальном тросе. Они могут вращаться вокруг своей оси, обеспечивая прямой или непрямой рассеянный свет. Потолочная розетка с блоком питания входит в комплект, а натяжители заказываются отдельно.

Линейная система освещения LANCIA NO LIMITS CAVO позволяет создавать непрерывные линии света длиной до 9 метров, начиная с одной точки электропитания. Потолочная розетка с блоком питания и натяжители заказываются отдельно.

ДОСТУПНЫЕ ОТДЕЛКИ:

- .01 белый
- .02 черный

LANCIA TONDA CAVO имеют диаметр 35, 50 и 70 см. Корпуса опираются на пару стальных тросов и с помощью специальных аксессуаров могут вращаться и наклоняться. Потолочная розетка с блоком питания входит в комплект, а натяжители заказываются отдельно.

ДОСТУПНЫЕ ОТДЕЛКИ:

- .01 белый
- .02 черный
- .25 атласное золото
- .31 хром

Система позволяет расположить светильники вдоль кабелей в нужной точке, начиная от одного настенного или потолочного источника питания. Потолочная розетка содержит блок питания. Стальной трос натянут между двумя противоположными талрепами и покрывает расстояние до 10 метров.

Светодиодный свет доступен в 2700K (XW), 3000K (WW) и 4000K (W) со значением CRI выше 90. Также доступны версии с диммированием.

По запросу также поставляются решения, предусматривающие соединение нескольких корпусов силовыми кабелями, идущими от светильника к светильнику.

Lighting system

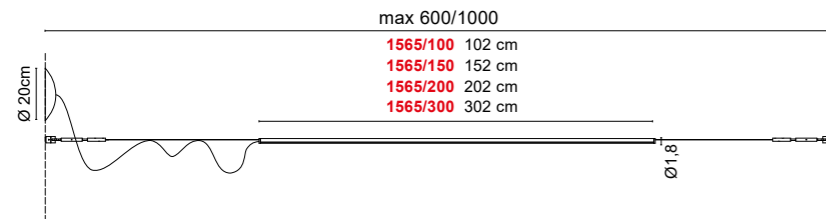

1565
Lancia Cavo è fornita completa di rosone e cavo di alimentazione
Lancia Cavo is supplied complete with ceiling rose and power cable

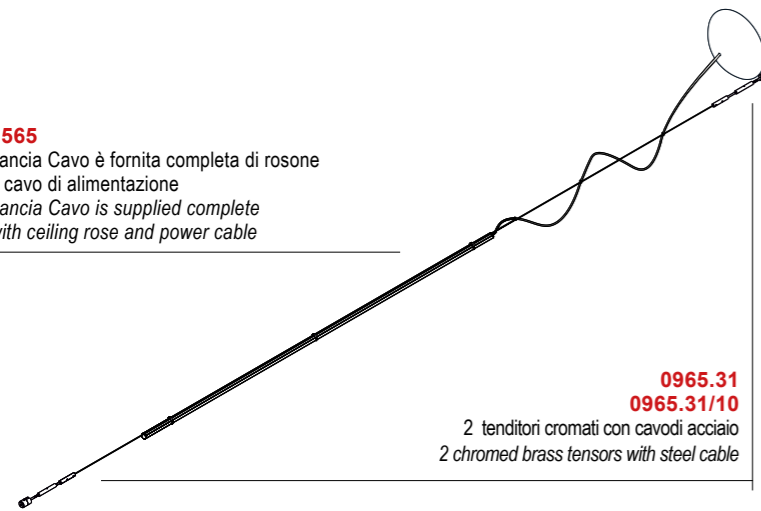

Optional
Accessori - Accessories



0965.31
Coppia di tenditori cromati con cavo di acciaio lunghezza 6 mt
2 chromed brass tensors with steel cable L. 6 mt

0965.31/10
Coppia di tenditori cromati con cavo di acciaio lunghezza 10 mt
2 chromed brass tensors with steel cable L. 10 mt

0991/C
Kit fissaggio singola lampada
1 Cavo acciaio 2 mt
1 Decentratore fissaggio cavo
1 Clip reggi lampada

Single lamp cable kit
1 Steel cable 2 mt
1 Element for cable fixing
1 Suspension clip



1565 Lancia Cavo

.01	Bianco - White
.02	Nero - Black
.85	Verniciato argento - Painted silver finishing
.86	Verniciato oro - Painted gold finishing
.87	Verniciato rame - Painted copper finishing
.88	Verniciato bronzo - Painted bronze finishing

100cm  0,80 Kg

Color temperature	LED Light source	lm source
/100/W 4000K	18W	2260lm
/100/WW 3000K	18W	2020lm
/100/XW 2700K	18W	1890lm

150cm  1,00 Kg

Color temperature	LED Light source	lm source
/150/W 4000K	27W	3390lm
/150/WW 3000K	27W	3030lm
/150/XW 2700K	27W	2835lm

200cm  1,20 Kg

Color temperature	LED Light source	lm source
/200/W 4000K	36W	4520lm
/200/WW 3000K	36W	4040lm
/200/XW 2700K	36W	3780lm

300cm  2 Kg

Color temperature	LED Light source	lm source
/300/W 4000K	54W	6780lm
/300/WW 3000K	54W	6060lm
/300/XW 2700K	54W	5670lm



Tenditori da ordinare separatamente
Tensors are to be ordered separately



Lighting system

Il profilo può ruotare sul suo asse di 360° per orientare la luce
The profile can rotate on its axis of 360° to direct the light





1672 Lancia No Limits Cavo

- .01** Bianco - White
- .02** Nero - Black

500cm  3 Kg

Color temperature	LED Light source	lm source
/500/W 4000K	24V 60W	9200lm
/500/WW 3000K	24V 60W	8250lm
/500/XW 2700K	24V 60W	7800lm

900cm  5,50 Kg

Color temperature	LED Light source	lm source
/900/W 4000K	24V 108W	16560lm
/900/WW 3000K	24V 108W	14850lm
/900/XW 2700K	24V 108W	14040lm



Tenditori e rosoni con alimentatori (p. 264) da ordinare separatamente
Tensor and ceiling roses with power supplies (p. 264) are to be ordered separately.



.01 Bianco - White



.02 Nero - Black

max 600/1000

- 1672/500** 502 cm
- 1672/900** 902 cm

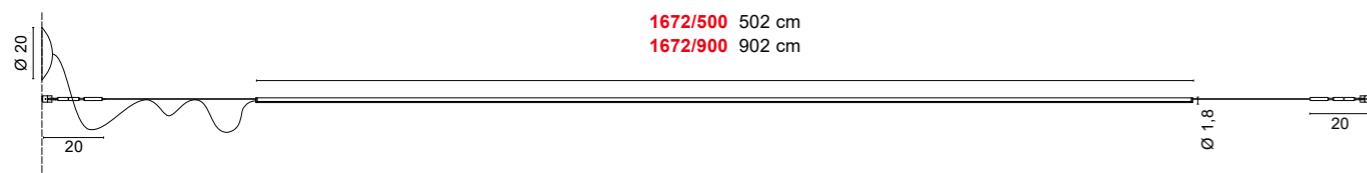

Optional
 Accessori - Accessories



0965.31

Coppia di tenditori cromati con cavo di acciaio lunghezza 6 mt
 2 chromed brass tensors
 with steel cable L. 6 mt

0965.31/10

Coppia di tenditori cromati con cavo di acciaio lunghezza 10 mt
 2 chromed brass tensors
 with steel cable L. 10 mt

0991/C

Kit fissaggio singola lampada
 1 Cavo acciaio 2 mt
 1 Decentratore fissaggio cavo
 1 Clip reggi lampada

Single lamp cable kit

1 Steel cable 2 mt
 1 Element for cable fixing
 1 Suspension clip



Il profilo può ruotare sul suo asse di 360° per orientare la luce
The profile can rotate on its axis of 360° to direct the light



Lighting system

Lighting system

1672
Lancia no limits cavo senza rosone
Lancia no limits cavo without ceiling rose

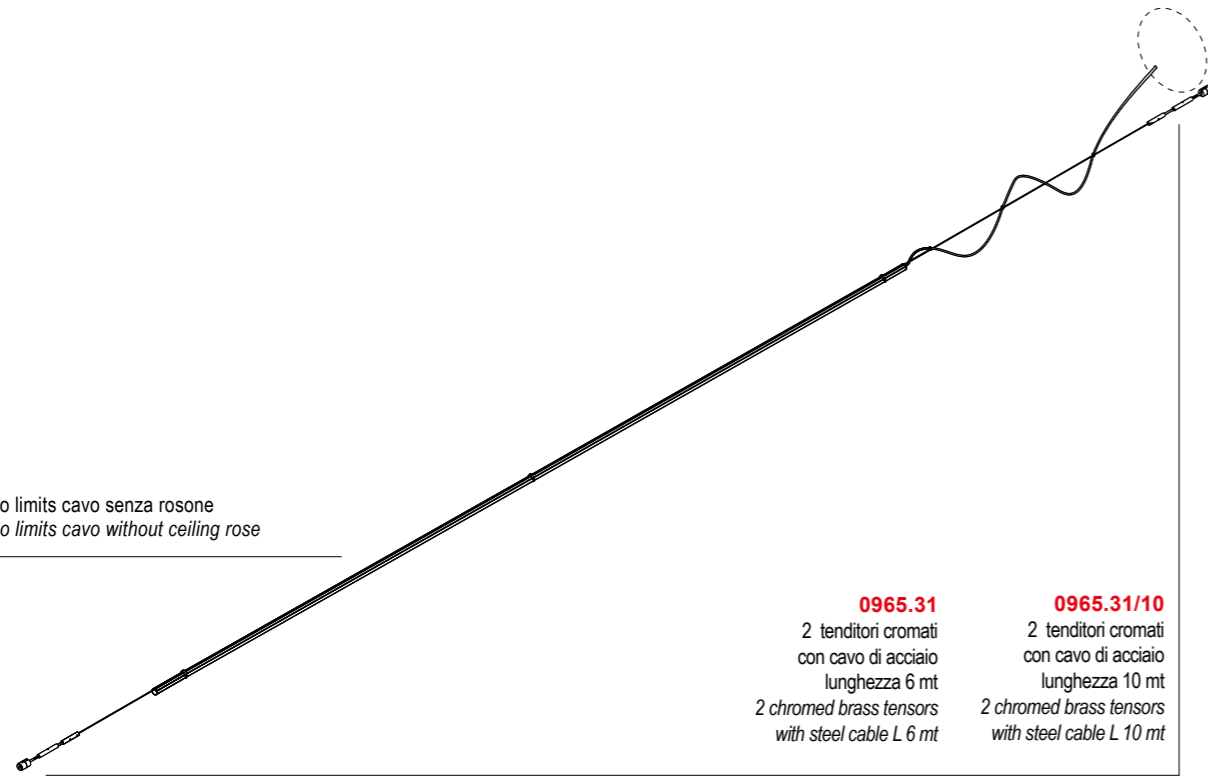

0965.31
2 tenditori cromati
con cavo di acciaio
lunghezza 6 mt
2 chromed brass tensors
with steel cable L 6 mt

0965.31/10
2 tenditori cromati
con cavo di acciaio
lunghezza 10 mt
2 chromed brass tensors
with steel cable L 10 mt



Indicazioni per una corretta installazione. *Instructions for correct installation.*

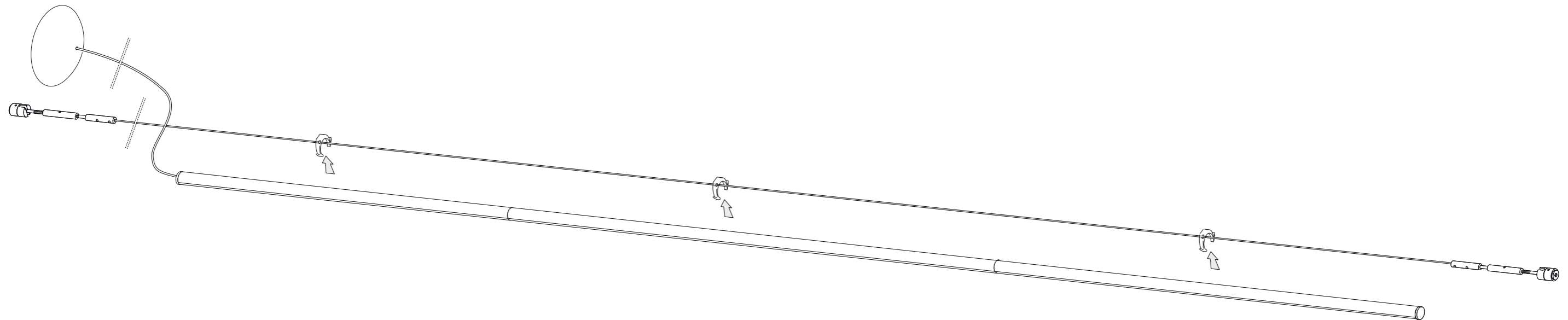



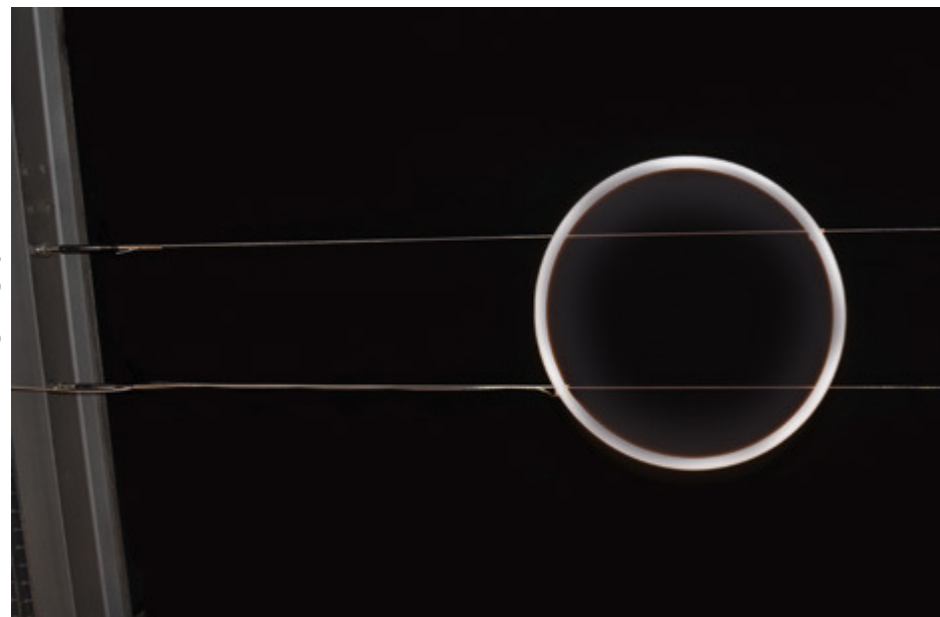

1171 Lancia Tonda Cavo Ø 35cm

.01	Bianco - <i>White</i>
.02	Nero - <i>Black</i>
.25	Dorato satinato - <i>Satin gold</i>
.31	Cromato - <i>Chromed</i>

Color temperature	LED Light source	lm source
/W 4000K	18W	2260lm
/WW 3000K	18W	2020lm
/XW 2700K	18W	1890lm



0,80 Kg

1172 Lancia Tonda Cavo Ø 50cm

.01	Bianco - <i>White</i>
.02	Nero - <i>Black</i>
.25	Dorato satinato - <i>Satin gold</i>
.31	Cromato - <i>Chromed</i>

Color temperature	LED Light source	lm source
/W 4000K	27W	3390lm
/WW 3000K	27W	3030lm
/XW 2700K	27W	2835lm



1,00 Kg

1173 Lancia Tonda Cavo Ø 70cm

.01	Bianco - <i>White</i>
.02	Nero - <i>Black</i>
.25	Dorato satinato - <i>Satin gold</i>
.31	Cromato - <i>Chromed</i>

Color temperature	LED Light source	lm source
/W 4000K	37,5W	4633lm
/WW 3000K	37,5W	4141lm
/XW 2700K	37,5W	3874lm



1,20 Kg

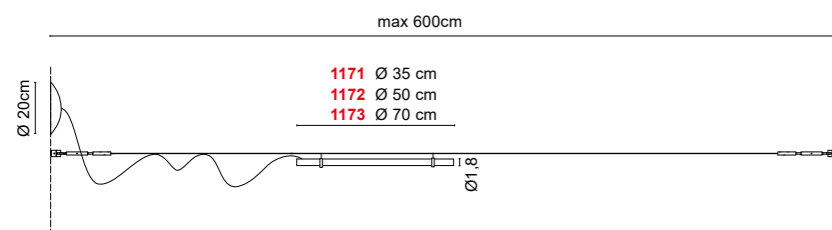

Accessori - Accessories



0970.31

KIT:
4 tenditori cromati
con 2 cavi di acciaio lunghezza 6 mt
*4 chromed brass tensors
with 2 steel cables L. 6 mt*

0970.31/10

KIT:
4 tenditori cromati
con 2 cavi di acciaio lunghezza 10 mt
*4 chromed brass tensors
with 2 steel cables L. 10 mt*

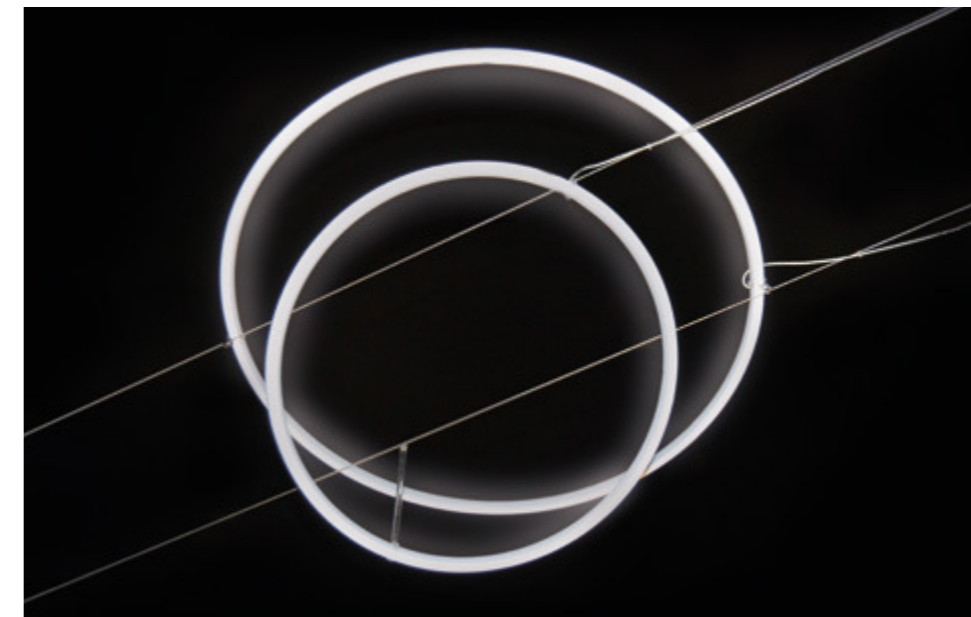

1172

Lancia Tonda Cavo Ø 50 cm è fornita completa di rosone e cavo di alimentazione L 5,5 mt
Lancia Tonda Cavo Ø 50 cm è fornita complete with ceiling rose and power cable 5,5 mt

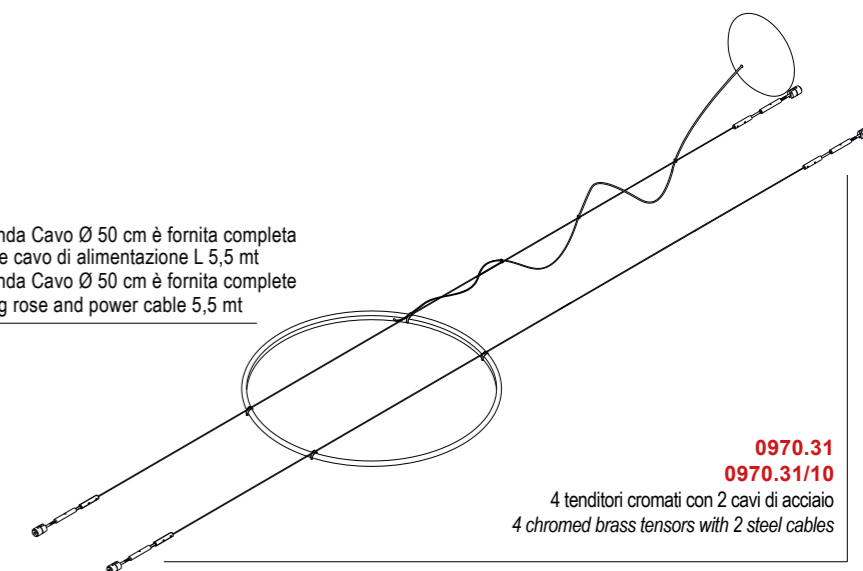

0970.31
0970.31/10

4 tenditori cromati con 2 cavi di acciaio
4 chromed brass tensors with 2 steel cables





EDISON

design: **U.T. EGOLUCE**

Soluzione di illuminazione che permette di moltiplicare i punti luce partendo da un'alimentazione iniziale a parete o a soffitto utilizzando lampadine decorative a filamento LED con attacco E27. Struttura in alluminio.

FINITURE DISPONIBILI:

- .01 bianco
- .02 nero
- .25 dorato satinato
- .32 nickel satinato

EDISON SYSTEM è costituito da un elemento a plafone e uno a sospensione con i portalampana regolabili in altezza che consentono di valorizzare a pieno la forma e la decorazione della sorgente. Si completa con una serie di accessori, cavi, deviatori e rosoni, da ordinare separatamente, che permettono di creare infinite configurazioni.

Lighting solution that allows you to multiply the light points starting from an initial power supply on the wall or ceiling using decorative LED filament bulbs with E27 socket. Aluminum structure.

AVAILABLE FINISHES:

- .01 white
- .02 black
- .25 satin gold
- .32 satin nickel

EDISON SYSTEM consists of a ceiling-mounted element and a suspended one with height-adjustable lamp holders that allow you to fully enhance the shape and decoration of the source. It is completed with a series of accessories, cables, diverters and rosettes, to be ordered separately, which allow you to create infinite configurations.

Solution d'éclairage qui permet de multiplier les points lumineux à partir d'une première alimentation au mur ou au plafond à l'aide d'ampoules décoratives à filament LED avec culot E27. Structure en aluminium.

FINITIONS DISPONIBLES:

- .01 blanc
- .02 noir
- .25 or satiné
- .32 nickel satiné

EDISON SYSTEM se compose d'un élément plafonnier et d'un élément suspendu avec douilles réglables en hauteur qui permettent de mettre pleinement en valeur la forme et la décoration de la source. Il est complété par une série d'accessoires, câbles, déviateurs et rosettes, à commander séparément, qui permettent de créer des configurations infinies.

Solución de iluminación que permite multiplicar los puntos de luz a partir de una alimentación inicial en pared o techo mediante bombillas LED decorativas de filamento con casquillo E27. Estructura de aluminio.

ACABADOS DISPONIBLES:

- .01 blanco
- .02 negro
- .25 oro satinado
- .32 níquel satinado

EDISON SYSTEM se compone de un elemento de techo y otro de suspensión con portalamparas regulables en altura que permiten realizar al máximo la forma y decoración de la fuente. Se completa con una serie de accesorios, cables, desviadores y rosetas, a pedir por separado, que permiten crear infinitas configuraciones.

Beleuchtungslösung, die es Ihnen ermöglicht, die Lichtpunkte ausgehend von einer anfänglichen Stromversorgung an Wand oder Decke mit dekorativen LED-Glühlampen mit E27-Fassung zu vervielfachen. Aluminiumstruktur.

VERFÜGBARE AUSFÜHRUNGEN:

- .01 weiß
- .02 schwarz
- .25 Satingold
- .32 satiniertes Nickel

EDISON SYSTEM besteht aus einem an der Decke montierten Element und einem hängenden Element mit höhenverstellbaren Lampenfassungen, mit denen Sie die Form und Dekoration der Quelle vollständig verbessern können. Es wird durch eine Reihe von Zubehörteilen, Kabeln, Umlenkern und Rosetten vervollständigt, die separat bestellt werden können und die es Ihnen ermöglichen, unendlich viele Konfigurationen zu erstellen.

Световое решение, позволяющее увеличить количество точек освещения, начиная с первоначального источника питания на стене или потолке с использованием декоративных светодиодных ламп накаливания с цоколем E27. Алюминиевая конструкция.

ДОСТУПНЫЕ ОТДЕЛКИ:

- .01 белый
- .02 черный
- .25 атласное золото
- .32 сатиновый никель

EDISON SYSTEM состоит из потолочного элемента и подвешено с регулирующими по высоте ламподержателями, позволяющими полностью подчеркнуть форму и декор источника. Он комплектуется серией аксессуаров, кабелей, диверторов и розеток, которые заказываются отдельно, что позволяет создавать бесконечное количество конфигураций.



5612.01 Bianco - White + 01LP8



5612 Edison PLAFONE - CEILING

- .01 Bianco - White
- .02 Nero - Black
- .25 Dorato satinato - Gilded satin
- .32 Nickel satinato - Nickel mat

Light sources
E27 LED max 7W

Lampadine decorative a filamento LED con attacco E27 pag. 216
LED filament decorative bulbs with E27 socket pag. 216

0,60 Kg

- Predisposto per 4 collegamenti
Prepared for 4 connections



1598.31 Cromato - Chromed + 01LP8

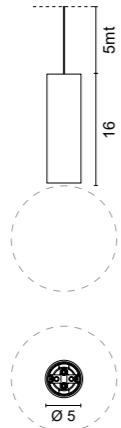

1598 Edison SUSPENSION

- .01 Bianco - White
- .02 Nero - Black
- .25 Dorato satinato - Gilded satin
- .32 Nickel satinato - Nickel mat

Light sources
E27 LED max 7W

Lampadine decorative a filamento LED con attacco E27 pag. 216
LED filament decorative bulbs with E27 socket pag. 216

0,40 Kg

- Lunghezza cavo 5 mt
Cable length 5 mt

Accessori - Accessories



0603
Rosone da 1 a 4 uscite
50/60Hz 220-240V
Ceiling rose with 1 - 4 holes
50/60Hz 220-240V

- .01 Bianco - White
- .02 Nero - Black

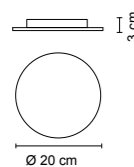

0,40 Kg



0604
Rosone - 1 uscita
50/60Hz 220-240V
Ceiling rose with 1 hole
50/60Hz 220-240V

- .01 Bianco - White
- .02 Nero - Black

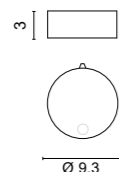

0,15 Kg



0946
Rosone per sospensione - 1 uscita
50/60Hz 220-240V
Ceiling rose for suspension - 1 hole
50/60Hz 220-240V

- .01 Bianco - White
- .02 Nero - Black

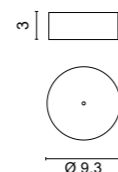

0,20 Kg



0605
Deviatore e decentratore - Ø 1,7 H 2,2
Displacement element - Ø 1,7 H 2,2

- .01 Bianco - White
- .02 Nero - Black

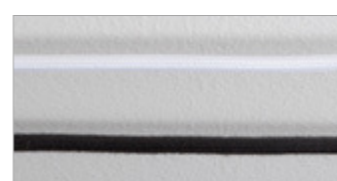

0606
Cavo con rivestimento in tessuto 5 mt
Textile covered cable 5 mt

- .01 Bianco - White
- .02 Nero - Black

Esempi di configurazioni - Configuration example

0605
Deviatore e decentratore
Displacement element

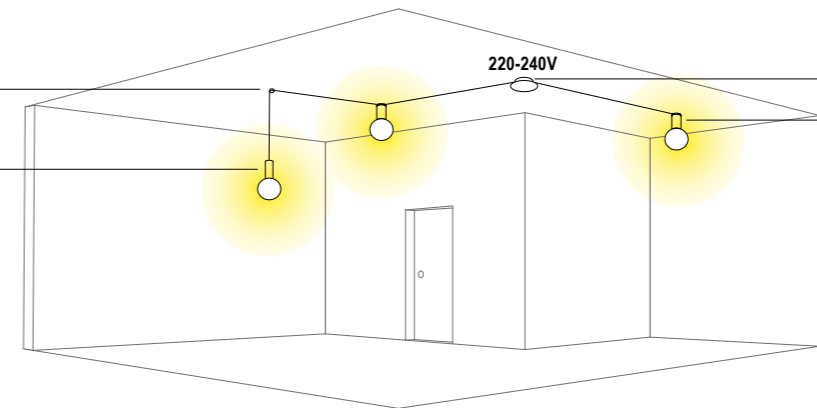

0603
Rosone da 1 a 4 uscite
50/60Hz 220-240V
Ceiling rose with 1 - 4 holes
50/60Hz 220-240V

1598
Edison Suspension
Lunghezza cavo 5 mt
Cable length 5 mt

5612
Edison Plafone
Predisposto per 4 collegamenti
Prepared for 4 connections

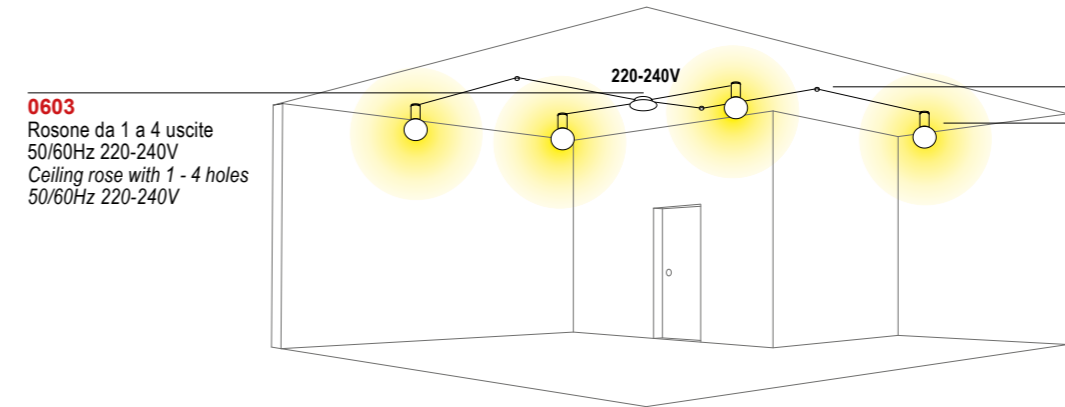

0605
Deviatore e decentratore
Displacement element

0603
Rosone da 1 a 4 uscite
50/60Hz 220-240V
Ceiling rose with 1 - 4 holes
50/60Hz 220-240V

5612
Edison Plafone
Predisposto per 4 collegamenti
Prepared for 4 connections

5612
Edison Plafone
Predisposto per 4 collegamenti
Prepared for 4 connections

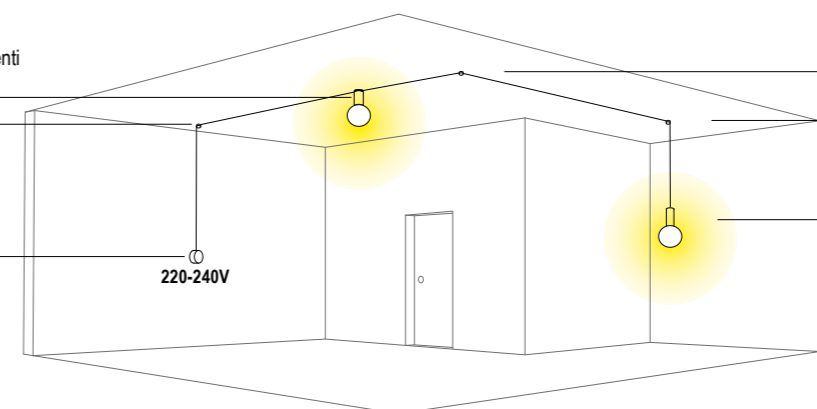

0605
Deviatore e decentratore
Displacement element

0605
Deviatore e decentratore
Displacement element

0605
Deviatore e decentratore
Displacement element

0604
Rosone - 1 uscita
50/60Hz 220-240V
Ceiling rose with 1 hole
50/60Hz 220-240V

1598
Edison Suspension
Lunghezza cavo 5 mt
Cable length 5 mt

5612
Edison Plafone
Predisposto per 4 collegamenti
Prepared for 4 connections

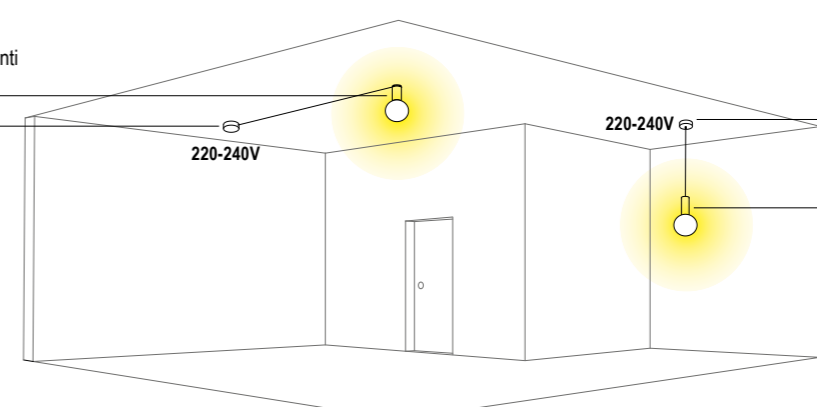

0946
Rosone per sospensione - 1 uscita
50/60Hz 220-240V
Ceiling rose for suspension - 1 hole
50/60Hz 220-240V

0604
Rosone - 1 uscita
50/60Hz 220-240V
Ceiling rose with 1 hole
50/60Hz 220-240V

1598
Edison Suspension
Lunghezza cavo 5 mt
Cable length 5 mt



EDISON System con lampadina **01LP8** - EDISON System with bulb **01LP8**



EDISON System con lampadina **01LCR1** - EDISON System with bulb **01LCR1**.



5612.25
Dorato satinato - Golded satin + **01LS1**



5612.01
Bianco - White + **01LP7**



5612.32
Nickel satinato - Nickel mat + **01LCR1**



5612.02
Nero - Black + **01LCO3**



RAIL SYSTEM *design: U.T. EGOLUCE*

Sistema di illuminazione lineare a luce diretta/diffusa con corpo in estruso di alluminio, dimensionato per poter contenere gli alimentatori, diffusore in metacrilato opalino, circuito da 18W/mt e CRI>90.

FINITURE DISPONIBILI:

- .01 bianco
- su richiesta altre finiture disponibili

RAIL SYSTEM è un modo diverso d'interpretare la luce. Un sistema lineare continuo LED che, allo stesso tempo, diventa uno strumento decorativo per disegnare e ridefinire lo spazio.

La modularità degli elementi permette di realizzare molteplici configurazioni luminose senza ombre o interruzioni.

È possibile disegnare linee, angoli ed incroci di luce su di un unico piano o tra piani diversi (parete/soffitto, parete/sospensione, incasso).

Questo rende RAIL un sistema estremamente versatile che si presta per una vasta gamma di installazioni sia in ambienti privati che pubblici.

La luce LED è disponibile a 2700K (XW), 3000K (WW) e 4000K (W) con un valore di CRI superiore a 90. Sono disponibili su richiesta anche versioni dimmerabili. Con il NEWTON RAIL SYSTEM aggiungiamo la possibilità di avere anche la luce d'accento grazie ai proiettori orientabili.

Linear lighting system with direct/diffused light with extruded aluminum body, sized to contain the drivers, opal methacrylate diffuser, 18W/mt circuit and CRI>90.

AVAILABLE FINISHES:

- .01 white
- other finishes available upon request

RAIL SYSTEM is a different way of interpreting light. A continuous LED linear system which, at the same time, becomes a decorative tool for designing and redefining space.

The modularity of the elements makes it possible to create multiple lighting configurations without shadows or interruptions.

It is possible to draw lines, angles and intersections of light on a single plane or between different planes (wall/ceiling, wall/suspension, recessed).

This makes RAIL an extremely versatile system that lends itself to a wide range of installations in both private and public environments.

The LED light is available at 2700K (XW), 3000K (WW) and 4000K (W) with a CRI value higher than 90. Dimmable versions are also available on request. With NEWTON RAIL SYSTEM we add the possibility of also having accent light thanks to the adjustable projectors.

Système d'éclairage linéaire à lumière directe/diffuse avec corps en aluminium extrudé, dimensionné pour contenir les alimentations, diffuseur en méthacrylate opale, circuit 18W/mt et CRI>90.

FINITIONS DISPONIBLES:

- .01 blanc
- autres finitions disponibles sur demande

RAIL SYSTEM est une manière différente d'interpréter la lumière. Un système linéaire LED continu qui, en même temps, devient un outil décoratif pour concevoir et redéfinir l'espace.

La modularité des éléments permet de créer de multiples configurations d'éclairage sans ombres ni interruptions. Il est possible de tracer des lignes, des angles et des intersections de lumière sur un même plan ou entre différents plans (mur/plafond, mur/suspension, encastré).

Cela fait de RAIL un système extrêmement polyvalent qui se prête à une large gamme d'installations dans des environnements privés et publics.

La lumière LED est disponible à 2700K (XW), 3000K (WW) et 4000K (W) avec une valeur CRI supérieure à 90. Des versions dimmables sont également disponibles sur demande. Avec NEWTON RAIL SYSTEM, nous ajoutons la possibilité d'avoir également une lumière d'accentuation grâce aux projecteurs orientables.

Sistema de iluminación lineal de luz directa/difusa con cuerpo de extrusión de aluminio, dimensionado para contener los balastos, difusor de metacrilato opal, circuito de 18W/mt y CRI>90.

ACABADOS DISPONIBLES:

- .01 blanco
- otros acabados disponibles bajo pedido

RAIL SYSTEM es una forma diferente de interpretar la luz. Un sistema lineal LED continuo que, al mismo tiempo, se convierte en una herramienta decorativa para diseñar y redefinir el espacio.

La modularidad de los elementos permite crear múltiples configuraciones de iluminación sin sombras ni interrupciones. Es posible dibujar líneas, ángulos e intersecciones de luz en un solo plano o entre diferentes planos (pared/techo, pared/suspensión, empotrado).

Esto convierte a RAIL en un sistema extremadamente versátil que se presta a una amplia gama de instalaciones tanto en entornos privados como públicos.

La luz LED está disponible en 2700K (XW), 3000K (WW) y 4000K (W) con un valor CRI superior a 90. Las versiones regulables también están disponibles bajo pedido. Con NEWTON RAIL SYSTEM añadimos la posibilidad de tener también luz de acento gracias a los proyectores orientables.

Lineares Beleuchtungssystem mit direktem/diffusem Licht mit Körper aus extrudiertem Aluminium, der so bemessen ist, dass er die Vorschaltgeräte aufnehmen kann, Diffusor aus opalem Methacrylat, Schaltung mit 18 W/mt und CRI>90.

VERFÜGBARE AUSFÜHRUNGEN:

- .01 weiß
- andere Ausführungen auf Anfrage erhältlich

RAIL SYSTEM ist eine andere Art, Licht zu interpretieren. Ein durchgehendes LED-Linearsystem, das gleichzeitig zu einem dekorativen Werkzeug für die Gestaltung und Neudefinition von Räumen wird.

Die Modularität der Elemente ermöglicht es, mehrere Beleuchtungskonfigurationen ohne Schatten oder Unterbrechungen zu erstellen. Es ist möglich, Lichtlinien, Winkel und Schnittpunkte auf einer Ebene oder zwischen verschiedenen Ebenen (Wand/Decke, Wand/Abhängung, Einbau) zu zeichnen.

Dies macht RAIL zu einem äußerst vielseitigen System, das sich für eine Vielzahl von Installationen im privaten und öffentlichen Bereich eignet.

Die LED-Leuchte ist in 2700K (XW), 3000K (WW) und 4000K (W) mit einem CRI-Wert über 90 erhältlich. Auf Anfrage sind auch dimmbare Versionen erhältlich. Mit NEWTON RAIL SYSTEM fügen wir die Möglichkeit hinzu, dank der verstellbaren Projektoren auch Akzentlicht zu haben.

Линейная система освещения с прямым/рассеянным светом с корпусом из экструдированного алюминия, размер которого позволяет разместить балласты, рассеиватель из опалового метакрилата, схема 18 Вт/метр и индекс цветопередачи >90.

ДОСТУПНЫЕ ОТДЕЛКИ:

- .01 белый
- другие варианты отделки доступны по запросу

RAIL SYSTEM это другой способ интерпретации света. Непрерывная линейная светодиодная система, которая одновременно становится декоративным инструментом для проектирования и переопределения пространства.

Модульность элементов позволяет создавать несколько конфигураций освещения без теней и прерываний. Можно рисовать линии, углы и пересечения света на одной плоскости или между разными плоскостями (стена/потолок, стена/подвес, углубление).

Это делает RAIL чрезвычайно универсальной системой, которая подходит для широкого спектра установок как в частных, так и в общественных местах.

Доступны светодиодные лампы с цветовой температурой 2700K (XW), 3000K (WW) и 4000K (W) со значением индекса цветопередачи выше 90. По запросу также доступны версии с диммированием. С системой NEWTON RAIL SYSTEM мы добавляем возможность акцентного освещения благодаря регулируемым прожекторам.

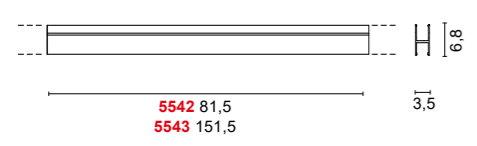

5542 Rail System CEILING/WALL
.01 Bianco - White

Color temperature	LED Light source	lm source
/W 4000K	14,4W	1808lm
/WW 3000K	14,4W	1616lm
/XW 2700K	14,4W	1512lm

IP40 CRI>90 R

1,1 Kg

5543 Rail System CEILING/WALL
.01 Bianco - White

Color temperature	LED Light source	lm source
/W 4000K	27W	3390lm
/WW 3000K	27W	3030lm
/XW 2700K	27W	2835lm

IP40 CRI>90 R

1,5 Kg

Nuova versione con circuito 18W/mt, 180 LED/mt CRI>90
New version with 18W/mt strip LED, 180 LED/mt CRI> 90

Su richiesta sono disponibili altre finiture
Other finishes upon request



Accessori - Accessories



0941
Angolo 90° - 90° corner
.01 Bianco - White

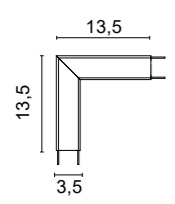

Color temperature	LED Light source	lm
/W 4000K	3,6W	452lm
/WW 3000K	3,6W	404lm
/XW 3000K	3,6W	378lm

IP40 CRI>90

0,40 Kg

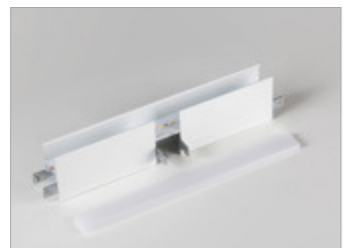

0942
Giunzione a T - T joint
.01 Bianco - White

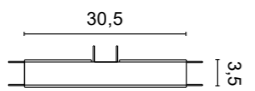

Color temperature	LED Light source	lm
/W 4000K	5,4W	678lm
/WW 3000K	5,4W	606lm
/XW 3000K	5,4W	567lm

IP40 CRI>90

0,35 Kg



0943
Giunzione a croce - Cross joint
.01 Bianco - White

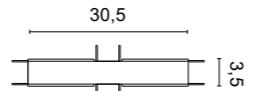

Color temperature	LED Light source	lm
/W 4000K	5,4W	678lm
/WW 3000K	5,4W	606lm
/XW 3000K	5,4W	567lm

IP40 CRI>90

0,35 Kg



0944
Raccordo parete - plafone
Wall - ceiling joint
.01 Bianco - White

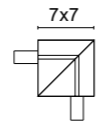

0,15 Kg



0948
Schermo in metacrilato satinato
Satin methacrylate diffuser
/100 105 cm
/200 205 cm
/300 305 cm



0945
2 testate di chiusura
2 end stoppers
.01 Bianco - White

CUSTOM SIZE

Tabella lunghezze disponibili su richiesta - Table of available lengths on request

cm	watt	2700K (XW)	lm source	3000K (WW)	lm source	4000K (W)	lm source
61,5	10,8W	A5542.01/60/XW	1134	A5542.01/60/WW	1212	A5542.01/60/W	1356
71,5	12,6W	A5542.01/70/XW	1323	A5542.01/70/WW	1414	A5542.01/70/W	1582
* 81,5	14,4W	5542.01/XW	1512	5542.01/WW	1616	5542.01/W	1808
91,5	16,2W	A5542.01/90/XW	1701	A5542.01/90/WW	1818	A5542.01/90/W	2034
101,5	18W	A5542.01/100/XW	1890	A5542.01/100/WW	2020	A5542.01/100/W	2260
111,5	19,8W	A5542.01/110/XW	2079	A5542.01/110/WW	2222	A5542.01/110/W	2486
121,5	21,6W	A5542.01/120/XW	2268	A5542.01/120/WW	2424	A5542.01/120/W	2712
131,5	23,4W	A5542.01/130/XW	2457	A5542.01/130/WW	2626	A5542.01/130/W	2938
141,5	25,2W	A5542.01/140/XW	2646	A5542.01/140/WW	2828	A5542.01/140/W	3164
* 151,5	27W	5543.01/XW	2835	5543.01/WW	3030	5543.01/W	3390
161,5	28,8W	A5542.01/160/XW	3024	A5542.01/160/WW	3232	A5542.01/160/W	3616
171,5	30,6W	A5542.01/170/XW	3213	A5542.01/170/WW	3434	A5542.01/170/W	3842
181,5	32,4W	A5542.01/180/XW	3402	A5542.01/180/WW	3636	A5542.01/180/W	4068
191,5	34,2W	A5542.01/190/XW	3591	A5542.01/190/WW	3838	A5542.01/190/W	4294
201,5	36W	A5542.01/200/XW	3780	A5542.01/200/WW	4040	A5542.01/200/W	4520
211,5	37,8W	A5542.01/210/XW	3969	A5542.01/210/WW	4242	A5542.01/210/W	4746
221,5	39,6W	A5542.01/220/XW	4158	A5542.01/220/WW	4444	A5542.01/220/W	4972
231,5	41,4W	A5542.01/230/XW	4347	A5542.01/230/WW	4646	A5542.01/230/W	5198
241,5	43,2W	A5542.01/240/XW	4536	A5542.01/240/WW	4848	A5542.01/240/W	5424
251,5	45W	A5542.01/250/XW	4725	A5542.01/250/WW	5050	A5542.01/250/W	5650
261,5	46,8W	A5542.01/260/XW	4914	A5542.01/260/WW	5252	A5542.01/260/W	5876
271,5	48,6W	A5542.01/270/XW	5103	A5542.01/270/WW	5454	A5542.01/270/W	6102
281,5	50,4W	A5542.01/280/XW	5292	A5542.01/280/WW	5656	A5542.01/280/W	6328
291,5	52,2W	A5542.01/290/XW	5481	A5542.01/290/WW	5858	A5542.01/290/W	6554
301,5	54W	A5542.01/300/XW	5670	A5542.01/300/WW	6060	A5542.01/300/W	6780

* Articolo standard a catalogo - Standard catalogue item



Esempio di configurazione - Configuration example

Lighting system

Lighting system

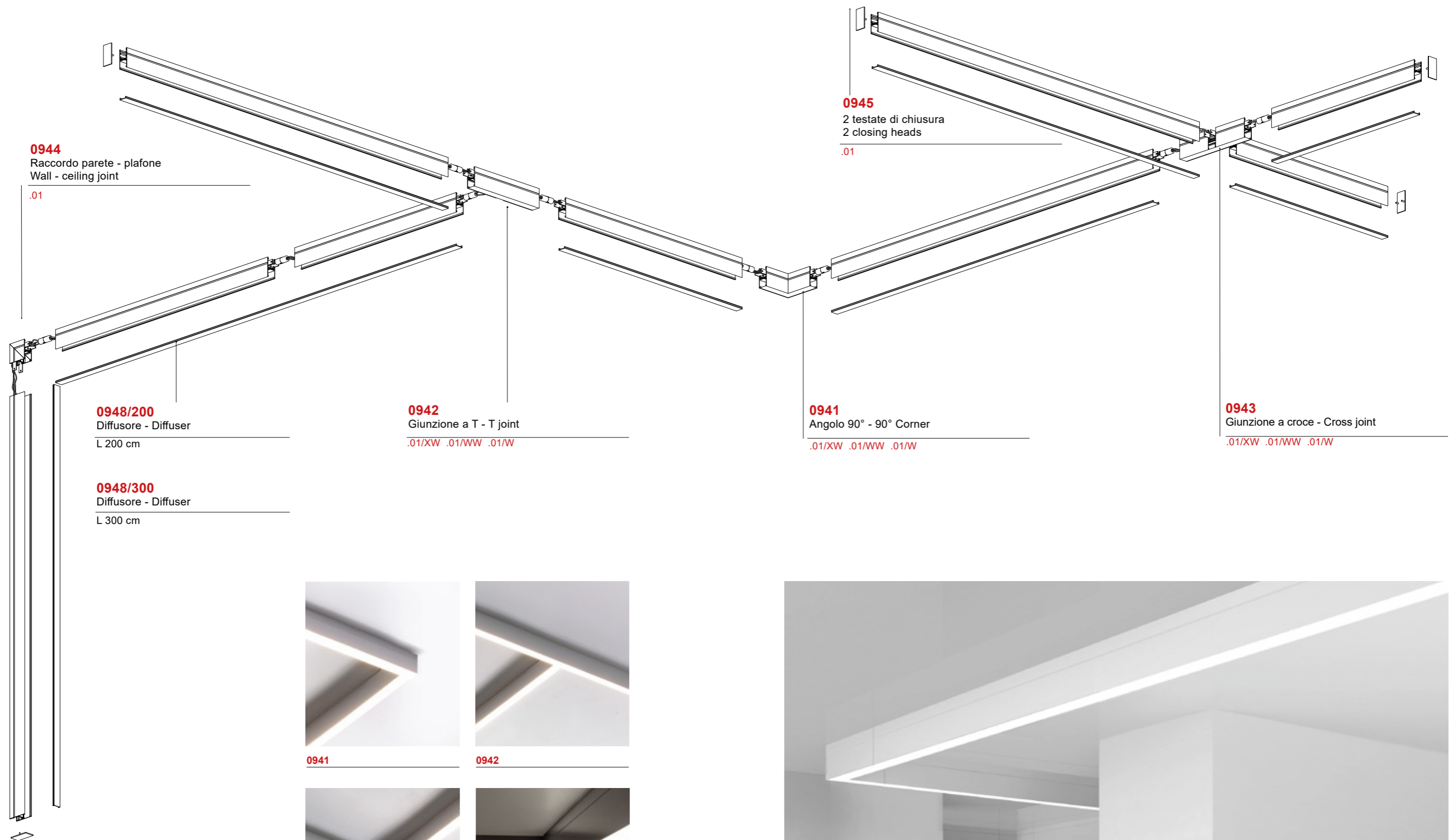

0941

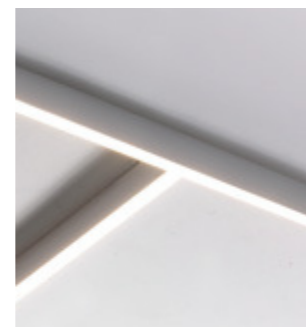

0942



0943



0944





Lighting system



Lighting system



Lighting system

Lighting system

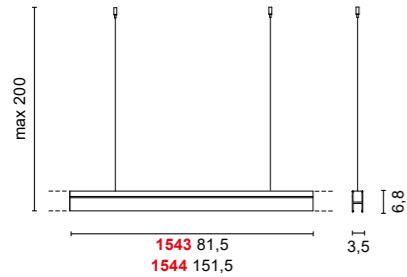

1543 Rail System SUSPENSION
.01 Bianco - White

Color temperature	LED Light source	lm source
/W 4000K	14,4W	1808lm
/WW 3000K	14,4W	1616lm
/XW 2700K	14,4W	1512lm

IP40 CRI >90 1 Kg

1544 Rail System SUSPENSION
.01 Bianco - White

Color temperature	LED Light source	lm source
/W 4000K	27W	3390lm
/WW 3000K	27W	3030lm
/XW 2700K	27W	2835lm

IP40 CRI >90 1,4 Kg

Nuova versione con circuito 18W/mt, 180 LED/mt CRI>90
New version with 18W/mt strip LED, 180 LED/mt CRI> 90

Su richiesta sono disponibili altre finiture
Other finishes upon request



Accessori - Accessories



0941
Angolo 90° - 90°corner
.01 Bianco - White

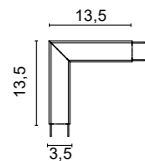

Color temperature	LED Light source	lm
/W 4000K	3,6W	452lm
/WW 3000K	3,6W	404lm
/XW 3000K	3,6W	378lm

IP40 CRI >90 0,40 Kg

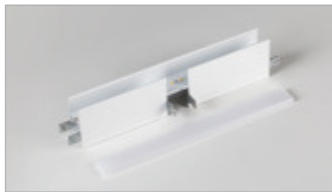

0942
Giunzione a T - T joint
.01 Bianco - White

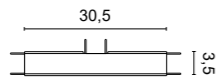

Color temperature	LED Light source	lm
/W 4000K	5,4W	678lm
/WW 3000K	5,4W	606lm
/XW 3000K	5,4W	567lm

IP40 CRI >90 0,35 Kg

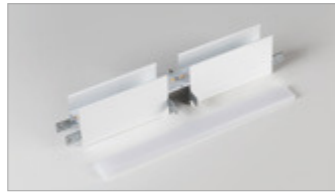

0943
Giunzione a croce - Cross joint
.01 Bianco - White

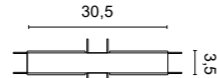

Color temperature	LED Light source	lm
/W 4000K	5,4W	678lm
/WW 3000K	5,4W	606lm
/XW 3000K	5,4W	567lm

IP40 CRI >90 0,35 Kg



0944
Raccordo parete - plafone
Wall - ceiling joint
.01 Bianco - White

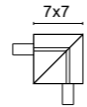

0,15 Kg



0946
Rosone completo di cavo di alimentazione
Ceiling rose with cable
.01 Bianco - White

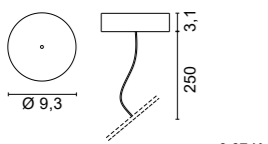

0,07 Kg



0947
Piastra con molle per controsoffitti
Ceiling plate with springs
.01 Bianco - White

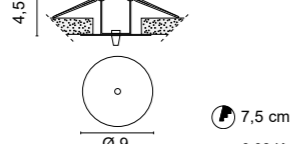

7,5 cm.
0,08 Kg



0948
Schermo in metacrilato satinato
Satin methacrylate diffuser
/100 105 cm
/200 205 cm
/300 305 cm



0945
2 testate di chiusura
2 end stoppers
.01 Bianco - White

CUSTOM SIZE

Tabella lunghezze disponibili su richiesta - Table of available lengths on request

cm	watt	2700K (XW)	lm source	3000K (WW)	lm source	4000K (W)	lm source
61,5	10,8W	A1543.01/60/XW	1134	A1543.01/60/WW	1212	A1543.01/60/W	1356
71,5	12,6W	A1543.01/70/XW	1323	A1543.01/70/WW	1414	A1543.01/70/W	1582
* 81,5	14,4W	1543.01/XW	1512	1543.01/WW	1616	1543.01/W	1808
91,5	16,2W	A1543.01/90/XW	1701	A1543.01/90/WW	1818	A1543.01/90/W	2034
101,5	18W	A1543.01/100/XW	1890	A1543.01/100/WW	2020	A1543.01/100/W	2260
111,5	19,8W	A1543.01/110/XW	2079	A1543.01/110/WW	2222	A1543.01/110/W	2486
121,5	21,6W	A1543.01/120/XW	2268	A1543.01/120/WW	2424	A1543.01/120/W	2712
131,5	23,4W	A1543.01/130/XW	2457	A1543.01/130/WW	2626	A1543.01/130/W	2938
141,5	25,2W	A1543.01/140/XW	2646	A1543.01/140/WW	2828	A1543.01/140/W	3164
* 151,5	27W	1544.01/XW	2835	1544.01/WW	3030	1544.01/W	3390
161,5	28,8W	A1543.01/160/XW	3024	A1543.01/160/WW	3232	A1543.01/160/W	3616
171,5	30,6W	A1543.01/170/XW	3213	A1543.01/170/WW	3434	A1543.01/170/W	3842
181,5	32,4W	A1543.01/180/XW	3402	A1543.01/180/WW	3636	A1543.01/180/W	4068
191,5	34,2W	A1543.01/190/XW	3591	A1543.01/190/WW	3838	A1543.01/190/W	4294
201,5	36W	A1543.01/200/XW	3780	A1543.01/200/WW	4040	A1543.01/200/W	4520
211,5	37,8W	A1543.01/210/XW	3969	A1543.01/210/WW	4242	A1543.01/210/W	4746
221,5	39,6W	A1543.01/220/XW	4158	A1543.01/220/WW	4444	A1543.01/220/W	4972
231,5	41,4W	A1543.01/230/XW	4347	A1543.01/230/WW	4646	A1543.01/230/W	5198
241,5	43,2W	A1543.01/240/XW	4536	A1543.01/240/WW	4848	A1543.01/240/W	5424
251,5	45W	A1543.01/250/XW	4725	A1543.01/250/WW	5050	A1543.01/250/W	5650
261,5	46,8W	A1543.01/260/XW	4914	A1543.01/260/WW	5252	A1543.01/260/W	5876
271,5	48,6W	A1543.01/270/XW	5103	A1543.01/270/WW	5454	A1543.01/270/W	6102
281,5	50,4W	A1543.01/280/XW	5292	A1543.01/280/WW	5656	A1543.01/280/W	6328
291,5	52,2W	A1543.01/290/XW	5481	A1543.01/290/WW	5858	A1543.01/290/W	6554
301,5	54W	A1543.01/300/XW	5670	A1543.01/300/WW	6060	A1543.01/300/W	6780

* Articolo standard a catalogo - Standard catalogue item



Esempio di configurazione - *Configuration example*

Lighting system

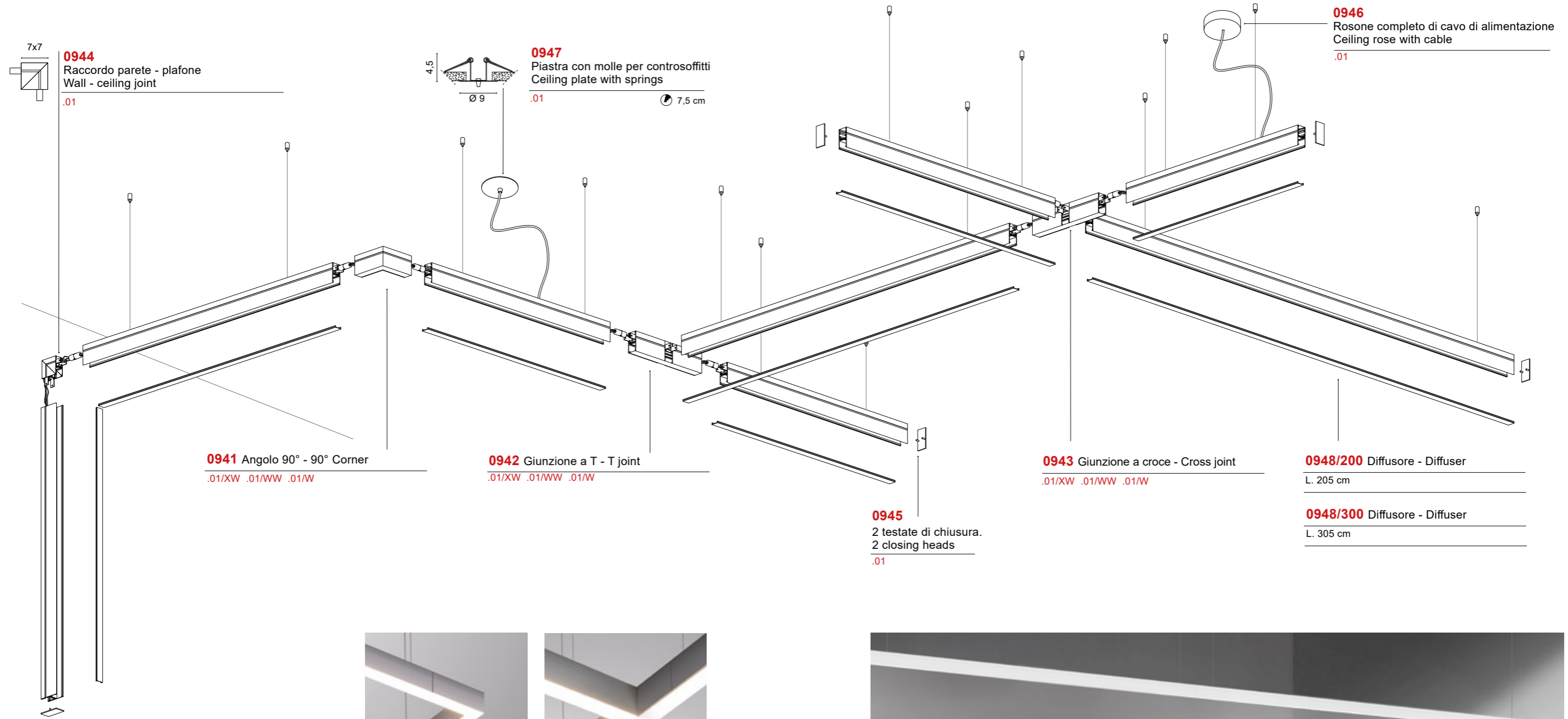

Lighting system

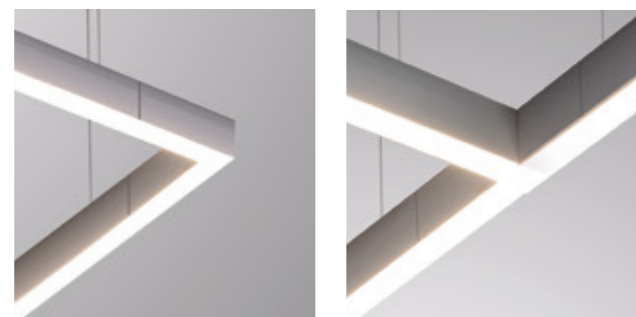

0941



0942



0943



0944



Lighting system

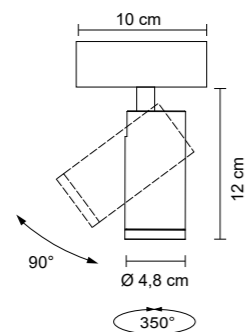

6347 Newton rail

.01	Bianco - White
.02	Nero - Black

Color temperature	Optics	LED light source	lm source	lm output
/W 4000K	/24 /38 /58	8,7W 17,5V 500mA	1466lm	1150lm
/W 4000K	/ST Satinato - Satin	8,7W 17,5V 500mA	1466lm	1099lm
/WW 3000K	/24 /38 /58	8,7W 17,5V 500mA	1424lm	1117lm
/WW 3000K	/ST Satinato - Satin	8,7W 17,5V 500mA	1424lm	1068lm
/XW 2700K	/24 /38 /58	8,7W 17,5V 500mA	1340lm	1051lm
/XW 2700K	/ST Satinato - Satin	8,7W 17,5V 500mA	1340lm	1005lm



0,50 Kg

Il posizionamento e le distanze dei proiettori **NEWTON** nei profili **RAIL** sono da definirsi in fase d'ordine e non possono essere modificati successivamente. Nei sistemi sospensione e plafone i driver sono integrati. Nel sistema incasso sono invece da ordinare separatamente.

The fixing and distances of the **NEWTON** projectors in the **RAIL** profiles are to be defined when ordering and it cannot be changed later. In suspension and ceiling systems the drivers are integrated. In the recessed system, on the other hand, they must be ordered separately.

6347 Newton Rail +

Rail sospensione - Rail suspension



Driver compresi
Drivers are included

6347 Newton Rail +

Rail plafone - Rail ceiling

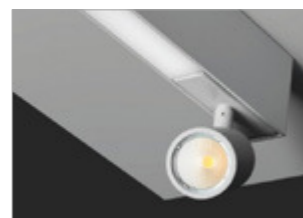

Driver compresi
Drivers are included

6347 Newton Rail +

Rail incasso - Rail recessed



I driver per art. 6347 sono da ordinare separatamente (vedi tabella)
Drivers for art. 6347 must be ordered separately (see table)

Accessori - Accessories



0267

Frangiluce - Louvres

.01	Bianco - White
.02	Nero - Black



0274

Schermo antiabbagliamento
Anti-glare screen

.01	Bianco - White
.02	Nero - Black



Ottiche Disponibili - Available Optics



/24

Ottica fascio stretto per luce d'accento
Narrow beam optic for accent lighting

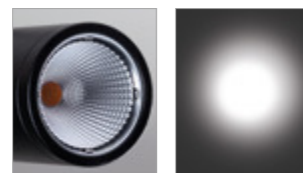

/38

Ottica fascio medio
Medium beam optic

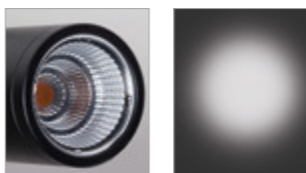

/58

Ottica fascio largo
Wide beam optic

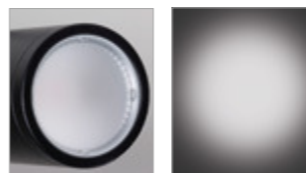

/ST

Ottica fascio diffuso per illuminazione generale
Diffused light optic for general lighting

Lighting system



Esempio Rail sospensione 1543 + Newton 6347 - I driver sono compresi
Example Rail suspension 1543 + Newton 6347 - Drivers are included

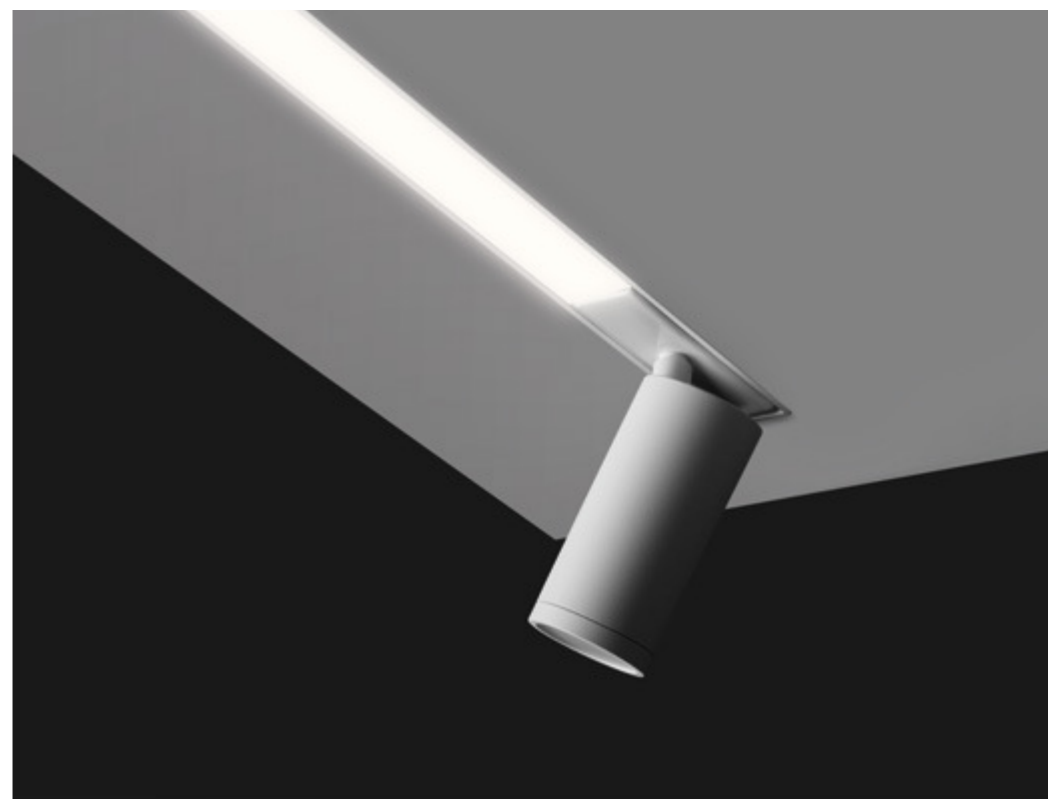

Esempio Rail incasso 6660 + Newton 6347 - I driver sono da ordinare separatamente (vedi tabella)
Example Rail recessed 6660 + Newton 6347 - Drivers must be ordered separately (see table)

Tabella drivers per **Newton Rail + Rail incasso** - Drivers table for **Newton Rail + Rail recessed**

Cod.	Drivers ON/OFF		DIMMABLE drivers				Casambi 0145/CASA	LED emergency unit 0115/EM Inverter + Battery + LED indicator
	0147/COB 500mA	0149/COB 500mA	0141/DIM PUSH - 1...10V	0141/DALI DIM DALI	0145/DALI DIM DALI	0145 DIM		
6347	1-2	1	1-2	1-2	1-3	1-3	1	1-3

Solo collegamento in serie - Only serial connection

NEWTON FLAT RAIL

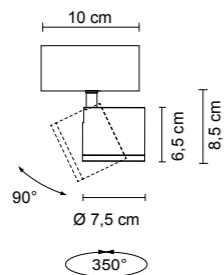
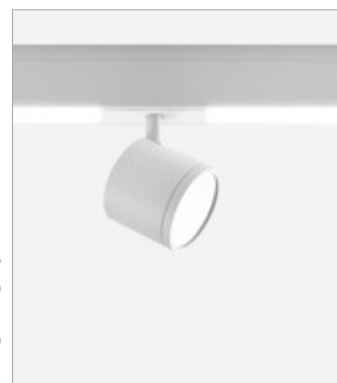

6475 Newton FLAT rail

- .01 Bianco - White
- .02 Nero - Black

Color temperature	Optics	LED light source	lm source	lm output
/W	4000K /13 /40	8,7W 17,5V 500mA	1466lm	1150lm
/W	4000K /ST Satinato - Satin	8,7W 17,5V 500mA	1466lm	1099lm
/WW	3000K /13 /40	8,7W 17,5V 500mA	1424lm	1117lm
/WW	3000K /ST Satinato - Satin	8,7W 17,5V 500mA	1424lm	1068lm
/XW	2700K /13 /40	8,7W 17,5V 500mA	1340lm	1051lm
/XW	2700K /ST Satinato - Satin	8,7W 17,5V 500mA	1340lm	1005lm



0,55 Kg

Il posizionamento e le distanze dei proiettori **NEWTON** nei profili **RAIL** sono da definirsi in fase d'ordine e non possono essere modificati successivamente. Nei sistemi sospensione e plafone i driver sono integrati. Nel sistema incasso sono invece da ordinare separatamente.

The fixing and distances of the **NEWTON** projectors in the **RAIL** profiles are to be defined when ordering and it cannot be changed later. In suspension and ceiling systems the drivers are integrated. In the recessed system, on the other hand, they must be ordered separately.

6475 Newton FLAT rail +

Rail sospensione - Rail suspension



Driver compresi
Drivers are included

6475 Newton FLAT rail +

Rail plafone - Rail ceiling



Driver compresi
Drivers are included

6475 Newton FLAT rail +

Rail incasso - Rail recessed

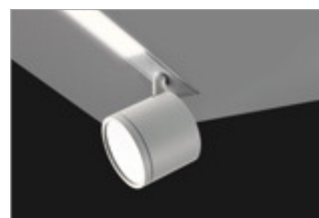

I driver per art. 6475 sono da ordinare separatamente (vedi tabella)
Drivers for art. 6475 must be ordered separately (see table)

Accessori - Accessories



0264

Parabola decorativa
Decorative parabolic reflector

- .01 Bianco - White
- .02 Nero - Black



Ottiche Disponibili - Available Optics

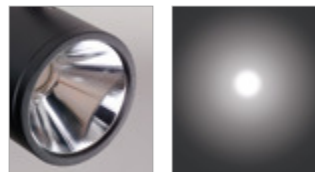

/24

Ottica fascio stretto per luce d'accento
Narrow beam optic for accent lighting

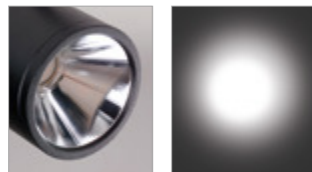

/38

Ottica fascio largo
Wide beam optic



/ST

Ottica fascio diffuso per illuminazione generale
Diffused light optic for general lighting

Tabella drivers per **Newton FLAT Rail + Rail incasso** - Drivers table for **Newton FLAT Rail + Rail recessed**

Cod.	Drivers ON/OFF		DIMMABLE drivers				Casambi	LED emergency unit
	0147/COB 500mA	0149/COB 500mA	0141/DIM PUSH - 1...10V	0141/DALI DIM DALI	0145/DALI DIM DALI	0145 DIM		
6475	1-2	1	1-2	1-2	1-3	1-3	1-3	1

Solo collegamento in serie - Only serial connection

NEWTON SLIM RAIL

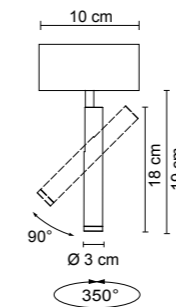

6474 Newton SLIM Rail

- .01 Bianco - White
- .02 Nero - Black

Color temperature	Optics	LED light source	lm source	lm output
/W	4000K /25 /48 /63	8,7W 17,5V 500mA	1466lm	1150lm
/W	4000K /ST Satinato - Satin	8,7W 17,5V 500mA	1466lm	1099lm
/WW	3000K /25 /48 /63	8,7W 17,5V 500mA	1424lm	1117lm
/WW	3000K /ST Satinato - Satin	8,7W 17,5V 500mA	1424lm	1068lm
/XW	2700K /25 /48 /63	8,7W 17,5V 500mA	1340lm	1051lm
/XW	2700K /ST Satinato - Satin	8,7W 17,5V 500mA	1340lm	1005lm



0,50 Kg

Il posizionamento e le distanze dei proiettori **NEWTON** nei profili **RAIL** sono da definirsi in fase d'ordine e non possono essere modificati successivamente. Nei sistemi sospensione e plafone i driver sono integrati. Nel sistema incasso sono invece da ordinare separatamente.

The fixing and distances of the **NEWTON** projectors in the **RAIL** profiles are to be defined when ordering and it cannot be changed later. In suspension and ceiling systems the drivers are integrated. In the recessed system, on the other hand, they must be ordered separately.

6474 Newton SLIM rail +

Rail sospensione - Rail suspension



Driver compresi
Drivers are included

6474 Newton SLIM rail +

Rail plafone - Rail ceiling



Driver compresi
Drivers are included

6474 Newton SLIM rail +

Rail incasso - Rail recessed



I driver per art. 6474 sono da ordinare separatamente (vedi tabella)
Drivers for art. 6474 must be ordered separately (see table)

Accessori - Accessories



0265

Diffusore in vetro Pyrex sabbato
Sand blasted Pyrex glass diffuser

- .01 Ghiera bianca - White ferrule
- .02 Ghiera nera - Black ferrule

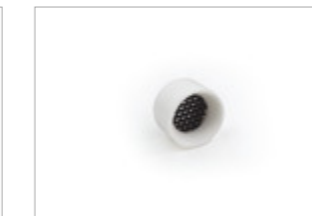

0267/S

Frangilucente
Luovres

- .01 Bianco - White
- .02 Nero - Black



Ottiche Disponibili - Available Optics

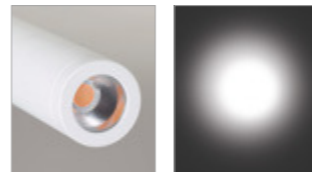

/25

Ottica fascio stretto per luce d'accento
Narrow beam optic for accent lighting

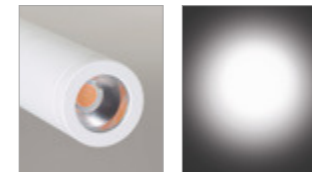

/48

Ottica fascio medio
Medium beam optic

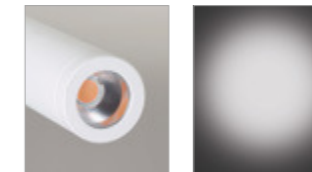

/63

Ottica fascio largo
Wide beam optic

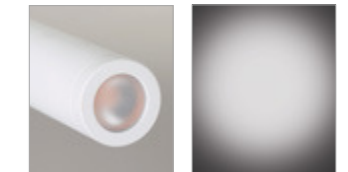

/ST

Ottica fascio diffuso per illuminazione generale
Diffused light optic for general lighting

Tabella drivers per **Newton SLIM Rail + Rail incasso** - Drivers table for **Newton SLIM Rail + Rail recessed**

Cod.	Drivers ON/OFF		DIMMABLE drivers				Casambi	LED emergency unit
	0147/COB 500mA	0149/COB 500mA	0141/DIM PUSH - 1...10V	0141/DALI DIM DALI	0145/DALI DIM DALI	0145 DIM		
6474	1-2	1	1-2	1-2	1-3	1-3	1-3	1

Solo collegamento in serie - Only serial connection

4580 Rail System WALL

.01 Bianco - White

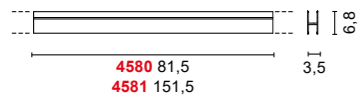

Color temperature	LED Light source	lm source
/W 4000K	14,4W	1808lm
/WW 3000K	14,4W	1616lm
/XW 2700K	14,4W	1512lm



4581 Rail System WALL

.01 Bianco - White

Color temperature	LED Light source	lm source
/W 4000K	27W	3390lm
/WW 3000K	27W	3030lm
/XW 2700K	27W	2835lm



Nuova versione con circuito 18W/mt, 180 LED/mt CRI>90
New version with 18W/mt strip LED, 180 LED/mt CRI> 90

Su richiesta sono disponibili altre finiture
Other finishes upon request

CUSTOM SIZE

Tabella lunghezze disponibili su richiesta - Table of available lengths on request

cm	watt	2700K (XW)	lm source	3000K (WW)	lm source	4000K (W)	lm source
61,5	10,8W	A4580.01/60/XW	1134	A4580.01/60/WW	1212	A4580.01/60/W	1356
71,5	12,6W	A4580.01/70/XW	1323	A4580.01/70/WW	1414	A4580.01/70/W	1582
* 81,5	14,4W	4580.01/XW	1512	4580.01/WW	1616	4580.01/W	1808
91,5	16,2W	A4580.01/90/XW	1701	A4580.01/90/WW	1818	A4580.01/90/W	2034
101,5	18W	A4580.01/100/XW	1890	A4580.01/100/WW	2020	A4580.01/100/W	2260
111,5	19,8W	A4580.01/110/XW	2079	A4580.01/110/WW	2222	A4580.01/110/W	2486
121,5	21,6W	A4580.01/120/XW	2268	A4580.01/120/WW	2424	A4580.01/120/W	2712
131,5	23,4W	A4580.01/130/XW	2457	A4580.01/130/WW	2626	A4580.01/130/W	2938
141,5	25,2W	A4580.01/140/XW	2646	A4580.01/140/WW	2828	A4580.01/140/W	3164
* 151,5	27W	4581.01/XW	2835	4581.01/WW	3030	4581.01/W	3390
161,5	28,8W	A4580.01/160/XW	3024	A4580.01/160/WW	3232	A4580.01/160/W	3616
171,5	30,6W	A4580.01/170/XW	3213	A4580.01/170/WW	3434	A4580.01/170/W	3842
181,5	32,4W	A4580.01/180/XW	3402	A4580.01/180/WW	3636	A4580.01/180/W	4068
191,5	34,2W	A4580.01/190/XW	3591	A4580.01/190/WW	3838	A4580.01/190/W	4294
201,5	36W	A4580.01/200/XW	3780	A4580.01/200/WW	4040	A4580.01/200/W	4520
211,5	37,8W	A4580.01/210/XW	3969	A4580.01/210/WW	4242	A4580.01/210/W	4746
221,5	39,6W	A4580.01/220/XW	4158	A4580.01/220/WW	4444	A4580.01/220/W	4972
231,5	41,4W	A4580.01/230/XW	4347	A4580.01/230/WW	4646	A4580.01/230/W	5198
241,5	43,2W	A4580.01/240/XW	4536	A4580.01/240/WW	4848	A4580.01/240/W	5424
251,5	45W	A4580.01/250/XW	4725	A4580.01/250/WW	5050	A4580.01/250/W	5650
261,5	46,8W	A4580.01/260/XW	4914	A4580.01/260/WW	5252	A4580.01/260/W	5876
271,5	48,6W	A4580.01/270/XW	5103	A4580.01/270/WW	5454	A4580.01/270/W	6102
281,5	50,4W	A4580.01/280/XW	5292	A4580.01/280/WW	5656	A4580.01/280/W	6328
291,5	52,2W	A4580.01/290/XW	5481	A4580.01/290/WW	5858	A4580.01/290/W	6554
301,5	54W	A4580.01/300/XW	5670	A4580.01/300/WW	6060	A4580.01/300/W	6780

* Articolo standard a catalogo - Standard catalogue item



0944
Raccordo parete - plafone
Wall - ceiling joint

.01 Bianco - White

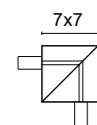

0,15 Kg



0948
Schermo in metacrilato satinato
Satin methacrylate diffuser

/100 105 cm
/200 205 cm
/300 305 cm



0949
Copertura. - Polycarbonate screen

/100 105 cm
/200 205 cm
/300 305 cm



0945
2 testate di chiusura
2 end stoppers

.01 Bianco - White

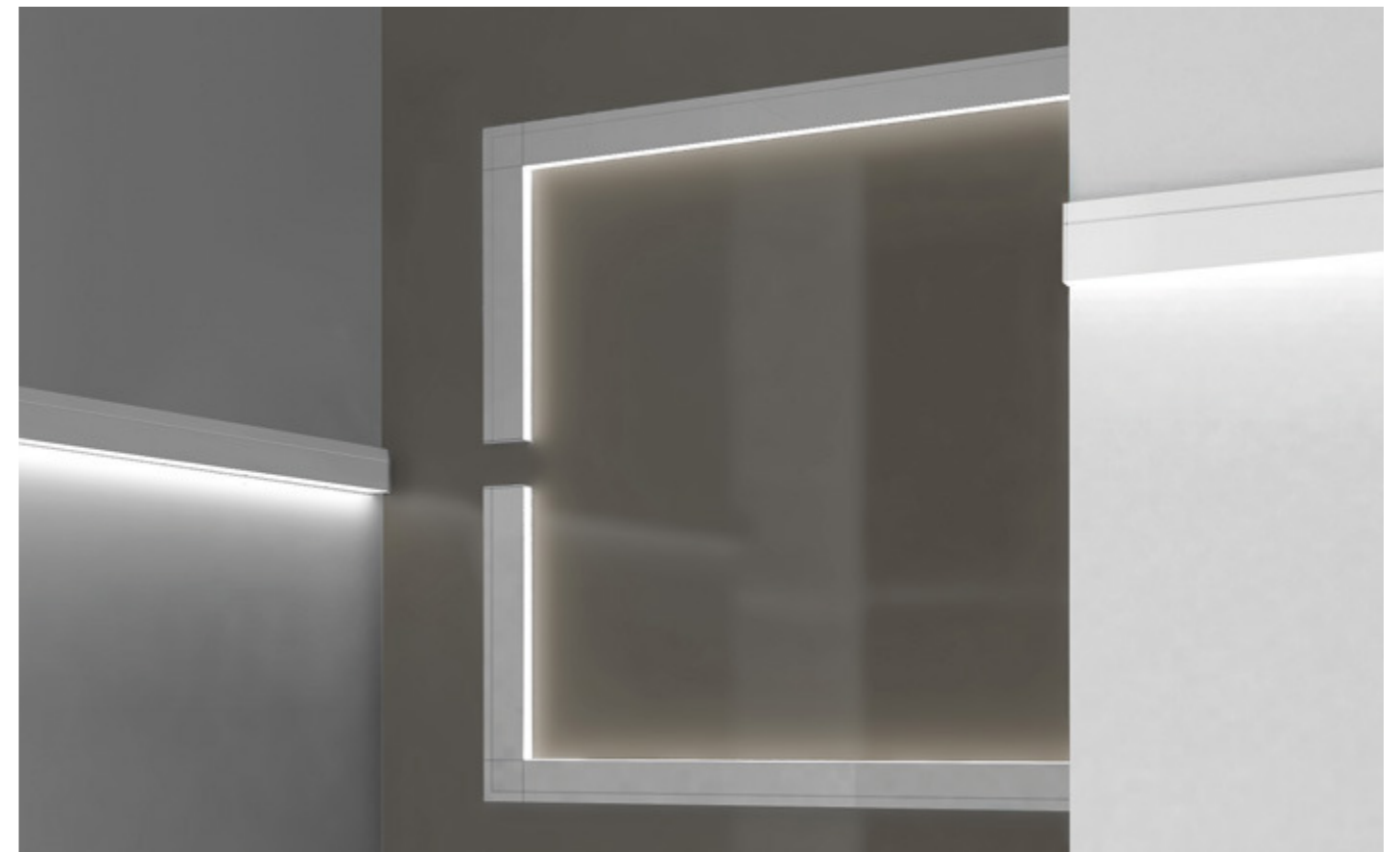

Esempio di configurazione - Configuration example

Lighting system

Lighting system

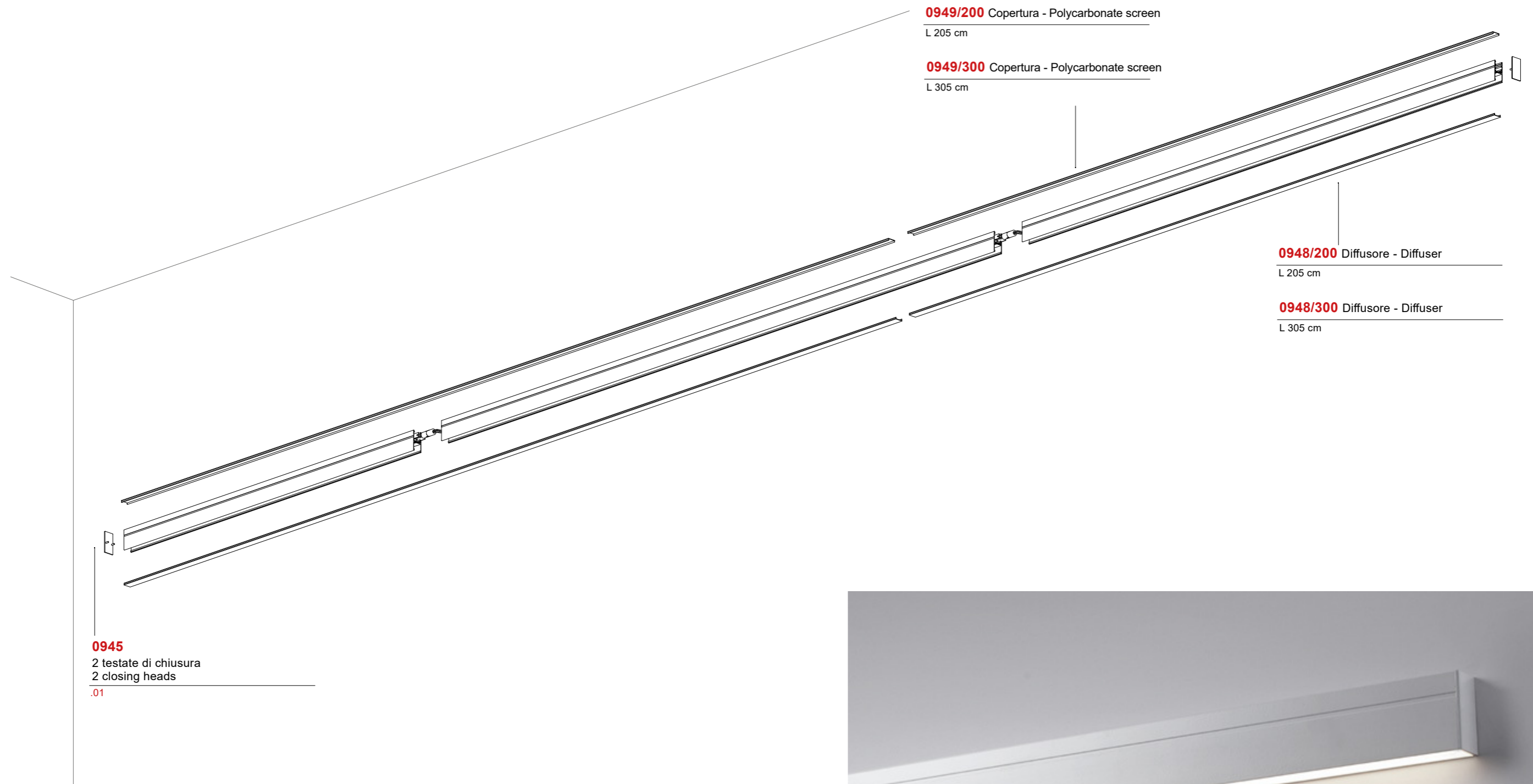

Lighting system



Lighting system



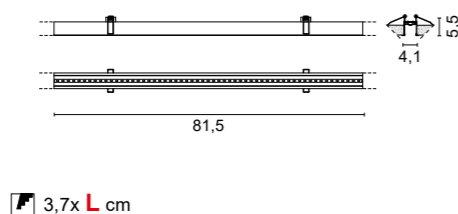

6660 Rail System RECESSED

.01 Bianco - White

	Color temperature	LED Light source	lm source
/W	4000K	24V 14,4W	1808lm
/WW	3000K	24V 14,4W	1616lm
/XW	2700K	24V 14,4W	1512lm



Lighting system

Lighting system

Nuova versione con circuito 18W/mt, 180 LED/mt CRI>90
New version with 18W/mt strip LED, 180 LED/mt CRI> 90

Su richiesta sono disponibili altre finiture
Other finishes upon request



Accessori - Accessories



0957
Angolo 90° - 90°corner
.01 Bianco - White



0956
Giunzione a croce - Cross joint
.01 Bianco - White



0958
Giunzione a T - T joint
.01 Bianco - White

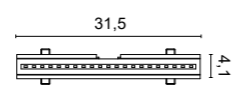
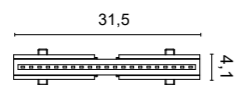
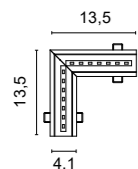

	Color temperature	Light sources	lm
/W	4000K	LED 3,6W	452lm
/WW	3000K	LED 3,6W	404lm
/XW	3000K	LED 3,6W	378lm

	Color temperature	Light sources	lm
/W	4000K	LED 5,4W	678lm
/WW	3000K	LED 5,4W	606lm
/XW	3000K	LED 5,4W	567lm

	Color temperature	Light sources	lm
/W	4000K	LED 5,4W	678lm
/WW	3000K	LED 5,4W	606lm
/XW	3000K	LED 5,4W	567lm



0948
Schermo in metacrilato satinato
Satin methacrylate diffuser
/100 105 cm
/200 205 cm
/300 305 cm

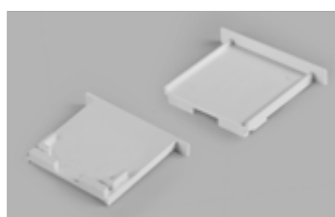

0939
2 testate di chiusura
2 end stoppers
.01 Bianco - White

CUSTOM SIZE

Tabella lunghezze disponibili su richiesta - Table of available lengths on request

cm	watt	2700K (XW)	lm source	3000K (WW)	lm source	4000K (W)	lm source
61,5	10,8W	A6660.01/60/XW	1134	A6660.01/60/WW	1212	A6660.01/60/W	1356
71,5	12,6W	A6660.01/70/XW	1323	A6660.01/70/WW	1414	A6660.01/70/W	1582
* 81,5	14,4W	6660.01/XW	1512	6660.01/WW	1616	6660.01/W	1808
91,5	16,2W	A6660.01/90/XW	1701	A6660.01/90/WW	1818	A6660.01/90/W	2034
101,5	18W	A6660.01/100/XW	1890	A6660.01/100/WW	2020	A6660.01/100/W	2260
111,5	19,8W	A6660.01/110/XW	2079	A6660.01/110/WW	2222	A6660.01/110/W	2486
121,5	21,6W	A6660.01/120/XW	2268	A6660.01/120/WW	2424	A6660.01/120/W	2712
131,5	23,4W	A6660.01/130/XW	2457	A6660.01/130/WW	2626	A6660.01/130/W	2938
141,5	25,2W	A6660.01/140/XW	2646	A6660.01/140/WW	2828	A6660.01/140/W	3164
151,5	27W	A6660.01/150/XW	2835	A6660.01/150/WW	3030	A6660.01/150/W	3390
161,5	28,8W	A6660.01/160/XW	3024	A6660.01/160/WW	3232	A6660.01/160/W	3616
171,5	30,6W	A6660.01/170/XW	3213	A6660.01/170/WW	3434	A6660.01/170/W	3842
181,5	32,4W	A6660.01/180/XW	3402	A6660.01/180/WW	3636	A6660.01/180/W	4068
191,5	34,2W	A6660.01/190/XW	3591	A6660.01/190/WW	3838	A6660.01/190/W	4294
201,5	36W	A6660.01/200/XW	3780	A6660.01/200/WW	4040	A6660.01/200/W	4520
211,5	37,8W	A6660.01/210/XW	3969	A6660.01/210/WW	4242	A6660.01/210/W	4746
221,5	39,6W	A6660.01/220/XW	4158	A6660.01/220/WW	4444	A6660.01/220/W	4972
231,5	41,4W	A6660.01/230/XW	4347	A6660.01/230/WW	4646	A6660.01/230/W	5198
241,5	43,2W	A6660.01/240/XW	4536	A6660.01/240/WW	4848	A6660.01/240/W	5424
251,5	45W	A6660.01/250/XW	4725	A6660.01/250/WW	5050	A6660.01/250/W	5650
261,5	46,8W	A6660.01/260/XW	4914	A6660.01/260/WW	5252	A6660.01/260/W	5876
271,5	48,6W	A6660.01/270/XW	5103	A6660.01/270/WW	5454	A6660.01/270/W	6102
281,5	50,4W	A6660.01/280/XW	5292	A6660.01/280/WW	5656	A6660.01/280/W	6328
291,5	52,2W	A6660.01/290/XW	5481	A6660.01/290/WW	5858	A6660.01/290/W	6554
301,5	54W	A6660.01/300/XW	5670	A6660.01/300/WW	6060	A6660.01/300/W	6780

* Articolo standard a catalogo - Standard catalogue item

FORO INCASSO - CUT OUT - 3,7x L cm

La lunghezza totale L del foro d'incasso si ottiene aggiungendo 0,6 cm alla somma delle lunghezze dei singoli pezzi.
Total length of the cutout L is obtained by adding 0,6 cm to the sum of each component length.



Drivers

Drivers ON/OFF

Cod.	0155	0156	0160	0157	0161/100	0162
	24V-13W	24V-25W	24V-50W	24V-75W	24V-100W	24V-150W

DIMMABLE drivers

Cod.	0110/DIM	0717/DIM60/V	0717/DIM60	0717/DIM100
	12/24V	24V-60W 1...10V	24V-60W PUSH - DALI	24V-100W 1...10V - PUSH - DALI

LED emergency unit

Cod.	0115/EM
	Inverter + Battery + LED indicator

Solo collegamento in parallelo - Only parallel connection

Esempio di configurazione - Configuration example

Lighting system

Lighting system

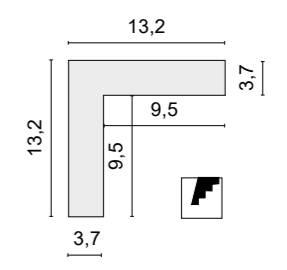
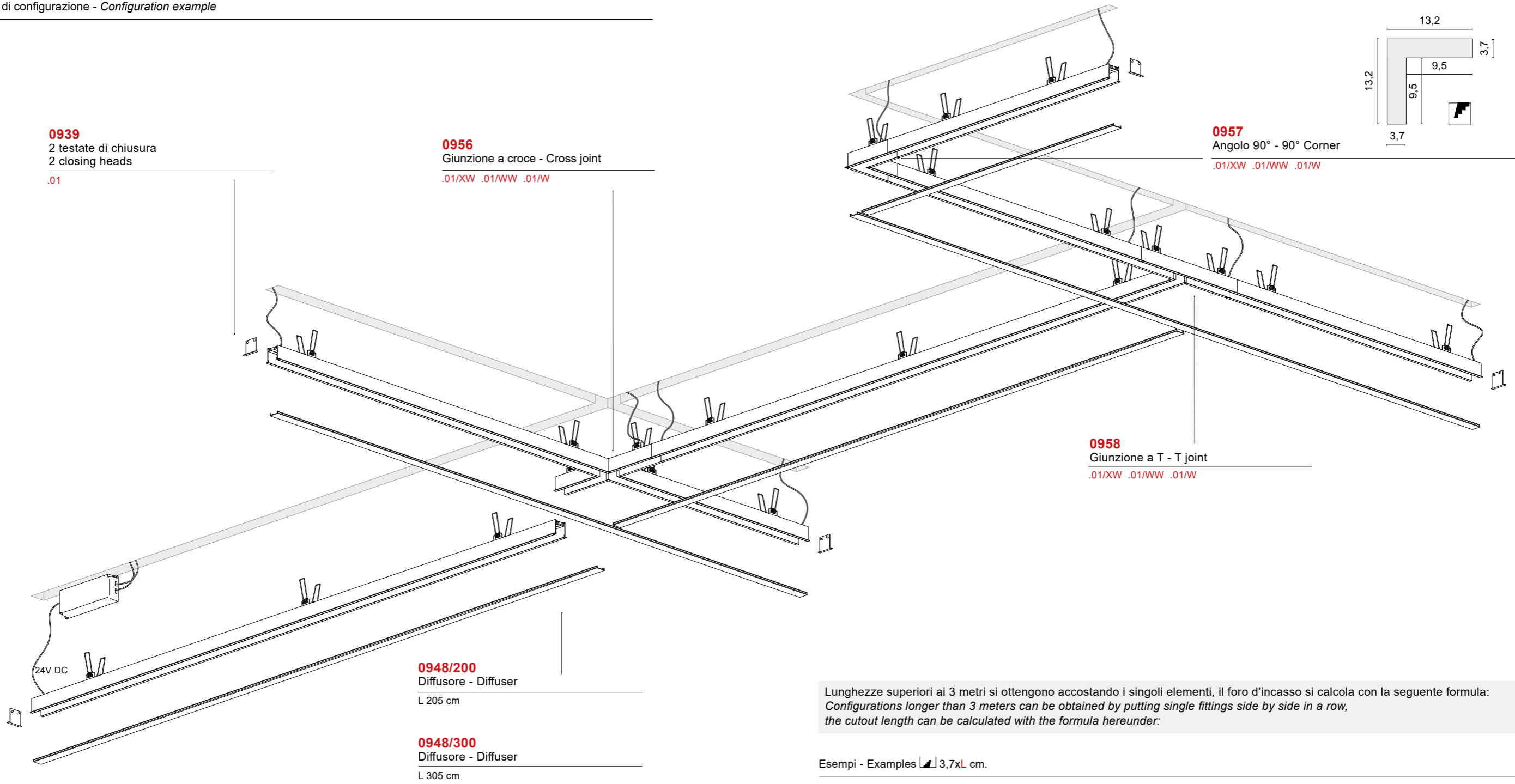

0939
2 testate di chiusura
2 closing heads
.01

0956
Giunzione a croce - Cross joint
.01/XW .01/WW .01/W

0957
Angolo 90° - 90° Corner
.01/XW .01/WW .01/W

0958
Giunzione a T - T joint
.01/XW .01/WW .01/W

0948/200
Diffusore - Diffuser
L 205 cm

0948/300
Diffusore - Diffuser
L 305 cm

24V DC

Lunghezze superiori ai 3 metri si ottengono accostando i singoli elementi, il foro d'incasso si calcola con la seguente formula:
Configurations longer than 3 meters can be obtained by putting single fittings side by side in a row,
the cutout length can be calculated with the formula hereunder:

Esempi - Examples $3,7 \times L$ cm.

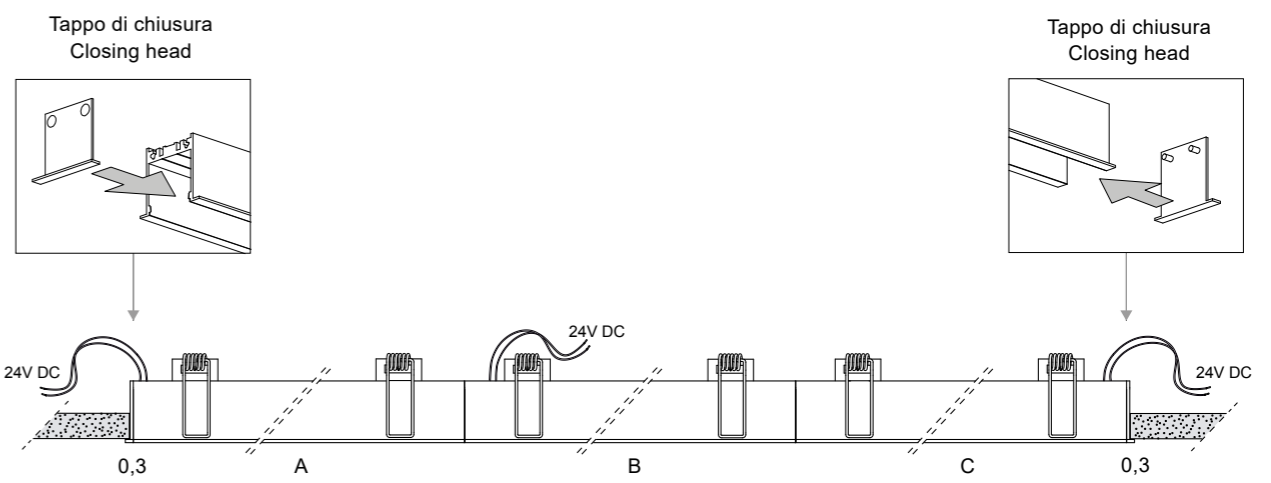

$$L = 0,3 + A + B + C + 0,3$$

A B C = Lunghezza delle lampade senza tappi di chiusura. Lamps length without closing heads.



0956



0957



0958

Sistema modulare lineare IP40 a luce diffusa per installazioni ad incasso con struttura di ridottissime dimensioni in metacrilato coestruso, dissipatore interno in alluminio anodizzato e testate di chiusura in metacrilato stampato ad iniezione. Il piccolo bordo in metacrilato consente un'installazione semplice che non richiede costose operazioni di rasatura, stuccatura e gessatura.

I singoli apparecchi sono realizzati in varie lunghezze da 12 a 302 cm con modularità ogni 10 cm (vedi tabella). Disponibili tre tonalità di luce (2700K, 3000K, 4000K) e versioni RGB.

Su richiesta vengono realizzati tagli ad angolo.

Le casseforme per muratura (solo per il modello LINEA), i profili angolari per facilitare l'installazione sul cartongesso, gli alimentatori, i dimmer DALI, 1...10V o PUSH e i gruppi di emergenza sono da ordinare separatamente.

IP40 linear modular system with diffused light for recessed installations with very small co-extruded methacrylate structure, anodized aluminium internal dissipator and injection molded methacrylate end caps. The small methacrylate border allows for simple installation that does not require costly shaving, grouting and plastering operations.

The single luminaires are made in various lengths from 12 to 302 cm with modularity every 10 cm (see table). Available in three shades of light (2700K, 3000K, 4000K) and RGB versions.

Angled cuts are made upon request.

The formwork for masonry (only for the LINEA model), the corner profiles to facilitate installation on plasterboard, the drivers, the DALI, 1...10V or PUSH dimmers and the emergency groups are to be ordered separately.

Système modulaire linéaire IP40 à lumière diffuse pour installations encastrées avec très petite structure en méthacrylate co-extrudé, dissipateur interne en aluminium anodisé et embouts en méthacrylate moulé par injection. La petite bordure en méthacrylate permet une installation simple qui ne nécessite pas d'opérations coûteuses de rasage, de jointoiement et de plâtrage.

Les luminaires simples sont fabriqués en différentes longueurs de 12 à 302 cm avec une modularité tous les 10 cm (voir tableau). Disponible en trois nuances de lumière (2700K, 3000K, 4000K) et en versions RVB.

Les coupes en biais sont réalisées sur demande.

Le coffrage pour maçonnerie (uniquement pour le modèle LINEA), les profilés d'angle pour faciliter la pose sur plaque de plâtre, les alimentations, les variateurs DALI, 1...10V ou PUSH et les groupes de secours sont à commander séparément.

LINEA design: U.T. EGOLUCE

Sistema modular lineal IP40 de luz difusa para instalaciones empotradas con estructura de metacrilato coextrusionado de dimensiones muy reducidas, disipador interior de aluminio anodizado y tapas finales de metacrilato moldeado por inyección. El pequeño borde de metacrilato permite una instalación sencilla que no requiere costosas operaciones de raspado, rejuntado y enlucido.

Las luminarias individuales se fabrican en varias longitudes de 12 a 302 cm con modularidad cada 10 cm (ver tabla). Disponible en tres tonos de luz (2700K, 3000K, 4000K) y versiones RGB.

Los cortes en ángulo se realizan bajo pedido.

El encofrado para mampostería (solo para el modelo LINEA), los perfiles de esquina para facilitar la instalación sobre cartón yeso, las fuentes de alimentación, los dimmers DALI, 1...10V o PUSH y los grupos de emergencia se piden por separado.

Lineare LED Einbauleuchten-system mit 'minitrim'. Der kleine Rahmen aus Methacrylat ermöglicht eine einfache und billige Installation ohne Gipsfertigung. Profil aus satiniertem Methacrylat weiß und Kühlkörper aus Aluminium eloxiert.

Die einzelne Elemente sind in verschiedenen Längen verfügbar: von 12 bis 302 cm. mit Modularität je 10 cm (siehe Tabelle). Erhältlich in drei Lichtfarben (2700, 3000 oder 4000K) oder RGB. Auf Anfrage vorbereiten wir Sonderausführungen mit eckeschnitt oder mit andere Lichtfarbe.

Separat zu bestellen: Konverter, dimmer DALI/1...10V/PUSH, Notbeleuchtung, Einbaudose (nur für LINEA).

LINEA – Breite 2,7 cm. Die Standardversion ist mit flexible LED Leisten 15W/m - 1700Lm/m (4000K) versehen.

LINEA – Breite 5,4 cm. Die Standardversion ist mit flexible LED Leisten 18W/m - 2000Lm/m (4000K). versehen.

Линейная модульная система IP40 с рассеянным светом для встраиваемых установок с очень маленькой коэкструдированной структурой из метакрилата, внутренним рассеивателем из анодированного алюминия и торцевыми крышками из литого под давлением метакрилата. Небольшой бордюр из метакрилата обеспечивает простую установку, не требующую дорогостоящих работ по шлифовке, затирке и штукатурке.

Одиночные светильники изготавливаются различной длины от 12 до 302 см с модульностью через каждые 10 см (см. таблицу). Доступны три оттенка света (2700К, 3000К, 4000К) и версии RGB.

Угловыерезы выполняются по запросу.

Опалубка для кладки (только для модели LINEA), угловые профили для облегчения монтажа на гипскартон, блоки питания, диммеры DALI, 1...10V или PUSH и аварийные группы заказываются отдельно.

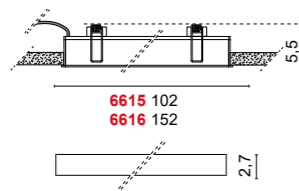

6615 101,5x2,2 cm
6616 151,5x2,2 cm

6615 Linea
.01 Bianco - White

Color temperature	LED Light source	lm source
/W 4000K	24V 15W	1840lm
/WW 3000K	24V 15W	1650lm
/XW 2700K	24V 15W	1560lm

IP 40, >90, 0,50 Kg

Versione ETL disponibile su richiesta
ETL version available upon request

6616 Linea
.01 Bianco - White

Color temperature	LED Light source	lm source
/W 4000K	24V 22,5W	2760lm
/WW 3000K	24V 22,5W	2475lm
/XW 2700K	24V 22,5W	2340lm

IP 40, >90, 1,50 Kg

Versione ETL disponibile su richiesta
ETL version available upon request

LINEA RGB

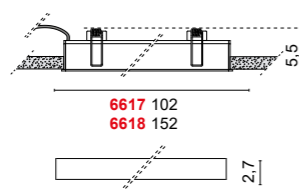

6617 101,5x2,2 cm
6618 151,5x2,2 cm

6617 Linea RGB
.01 Bianco - White

LED Light source
24V 14,4W

IP 40, >90, 0,50 Kg

Versione ETL disponibile su richiesta
ETL version available upon request

6618 Linea RGB
.01 Bianco - White

LED Light sources
24V 21,6W

IP 40, >90, 1,50 Kg

Versione ETL disponibile su richiesta
ETL version available upon request



Accessori - Accessories

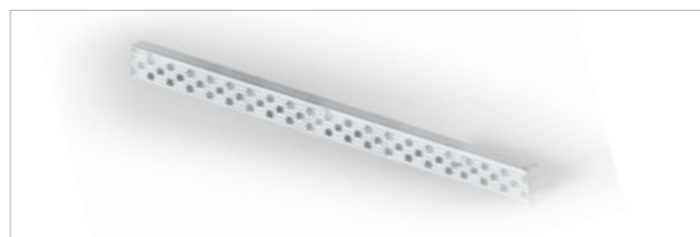

0210/100 101,8 cm
0210/150 151,8 cm
0210/200 201,8 cm
0210/300 301,8 cm

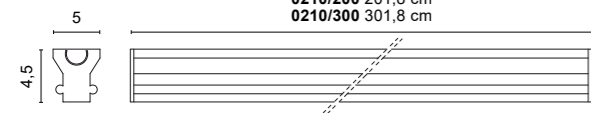

0210

Cassaforma per calcestruzzo.
Wallbox for concrete.

/100	101,8 cm	6x105x5 cm
/150	151,8 cm	6x155x5 cm
/200	201,8 cm	6x205x5 cm
/300	301,8 cm	6x305x5 cm

0242

Profilo angolare opzionale per facilitare l'installazione nel cartongesso.
Optional L shaped profile to ease installation into plasterboard.

/100	100 cm
/200	200 cm
/300	300 cm

CUSTOM SIZE

Tabella lunghezze disponibili su richiesta. Le misure si riferiscono alle lunghezze totali delle lampade comprese di tappi terminali. N.B. senza tappi: - 1 cm
Table of available lengths on request. Measures are referred to complete fixtures including closing heads. Attention: Without closing heads: - 1 cm

cm	watt	cm	2700K (XW)	lm source	3000K (WW)	lm source	4000K (W)	lm source	RGB
12	1,5W	11,5x2,2	A6615.01/10/XW	156	A6615.01/10/WW	165	A6615.01/10/W	184	A6615.01/10RGB
22	3W	21,5x2,2	A6615.01/20/XW	312	A6615.01/20/WW	330	A6615.01/20/W	368	A6615.01/20RGB
32	4,5W	31,5x2,2	A6615.01/30/XW	468	A6615.01/30/WW	495	A6615.01/30/W	552	A6615.01/30RGB
42	6W	41,5x2,2	A6615.01/40/XW	624	A6615.01/40/WW	660	A6615.01/40/W	736	A6615.01/40RGB
52	7,5W	51,5x2,2	A6615.01/50/XW	780	A6615.01/50/WW	895	A6615.01/50/W	920	A6615.01/50RGB
62	9W	61,5x2,2	A6615.01/60/XW	936	A6615.01/60/WW	990	A6615.01/60/W	1104	A6615.01/60RGB
72	10,5W	71,5x2,2	A6615.01/70/XW	1092	A6615.01/70/WW	1155	A6615.01/70/W	1288	A6615.01/70RGB
82	12W	81,5x2,2	A6615.01/80/XW	1248	A6615.01/80/WW	1320	A6615.01/80/W	1472	A6615.01/80RGB
92	13,5W	91,5x2,2	A6615.01/90/XW	1404	A6615.01/90/WW	1485	A6615.01/90/W	1656	A6615.01/90RGB
102	15W	101,5x2,2	6615.01/XW *	1560	6615.01/WW *	1650	6615.01/W*	1840	6617.01 *
112	16,5W	111,5x2,2	A6615.01/110/XW	1716	A6615.01/110/WW	1815	A6615.01/110/W	2024	A6615.01/110RGB
122	18W	121,5x2,2	A6615.01/120/XW	1872	A6615.01/120/WW	1980	A6615.01/120/W	2208	A6615.01/120RGB
132	19,5W	131,5x2,2	A6615.01/130/XW	2028	A6615.01/130/WW	2145	A6615.01/130/W	2392	A6615.01/130RGB
142	21W	141,5x2,2	A6615.01/140/XW	2184	A6615.01/140/WW	2310	A6615.01/140/W	2576	A6615.01/140RGB
152	22,5W	151,5x2,2	6616.01/XW *	2340	6616.01/WW *	2475	6616.01/W*	2760	6618.01 *
162	24W	161,5x2,2	A6615.01/160/XW	2496	A6615.01/160/WW	2640	A6615.01/160/W	2944	A6615.01/160RGB
172	25,5W	171,5x2,2	A6615.01/170/XW	2652	A6615.01/170/WW	2805	A6615.01/170/W	3128	A6615.01/170RGB
182	27W	181,5x2,2	A6615.01/180/XW	2808	A6615.01/180/WW	2970	A6615.01/180/W	3312	A6615.01/180RGB
192	28,5W	191,5x2,2	A6615.01/190/XW	2964	A6615.01/190/WW	3135	A6615.01/190/W	3496	A6615.01/190RGB
202	30W	201,5x2,2	A6615.01/200/XW	3120	A6615.01/200/WW	3300	A6615.01/200/W	3680	A6615.01/200RGB
212	31,5W	211,5x2,2	A6615.01/210/XW	3276	A6615.01/210/WW	3465	A6615.01/210/W	3864	A6615.01/210RGB
222	33W	221,5x2,2	A6615.01/220/XW	3432	A6615.01/220/WW	3630	A6615.01/220/W	4048	A6615.01/220RGB
232	34,5W	231,5x2,2	A6615.01/230/XW	3588	A6615.01/230/WW	3795	A6615.01/230/W	4232	A6615.01/230RGB
242	36W	241,5x2,2	A6615.01/240/XW	3744	A6615.01/240/WW	3960	A6615.01/240/W	4416	A6615.01/240RGB
252	37,5W	251,5x2,2	A6615.01/250/XW	3900	A6615.01/250/WW	4125	A6615.01/250/W	4600	A6615.01/250RGB
262	39W	261,5x2,2	A6615.01/260/XW	4056	A6615.01/260/WW	4290	A6615.01/260/W	4784	A6615.01/260RGB
272	40,5W	271,5x2,2	A6615.01/270/XW	4212	A6615.01/270/WW	4455	A6615.01/270/W	4968	A6615.01/270RGB
282	42W	281,5x2,2	A6615.01/280/XW	4368	A6615.01/280/WW	4620	A6615.01/280/W	5152	A6615.01/280RGB
292	43,5W	291,5x2,2	A6615.01/290/XW	4524	A6615.01/290/WW	4785	A6615.01/290/W	5336	A6615.01/290RGB
302	45W	301,5x2,2	A6615.01/300/XW	4680	A6615.01/300/WW	4950	A6615.01/300/W	5520	A6615.01/300RGB

* Articolo standard a catalogo - Standard catalogue item

Drivers

Drivers ON/OFF

Cod.	0155	0156	0160	0157	0161/100	0162
	24V-13W	24V-25W	24V-50W	24V-75W	24V-100W	24V-150W

DIMMABLE drivers

Cod.	0110/DIM	0717/DIM60/V	0717/DIM60	0717/DIM100
	12/24V	24V-60W 1...10V	24V-60W PUSH - DALI	24V-100W 1...10V - PUSH - DALI

LED emergency unit

Cod.	0115/EM
	Inverter + Battery + LED indicator

RGB drivers

Cod.	0164	0167	0164/CASA
	120W	22W	120W
	IN:230V - OUT: 3x24V		IN:230V - OUT: 3x24V

Driver RGB Casambi

0163	0165	0166
IR Sensor	IR Remote controller	Sinc Cable

Solo collegamento in parallelo - Only parallel connection



Lunghezze superiori ai 3 metri si ottengono accostando i singoli elementi, il foro d'incasso si calcola con la seguente formula:
 Configurations longer than 3 meters can be obtained by putting single fittings side by side in a row, the cutout length can be calculated with the formula hereunder:

Esempi - Examples 2,2x L cm

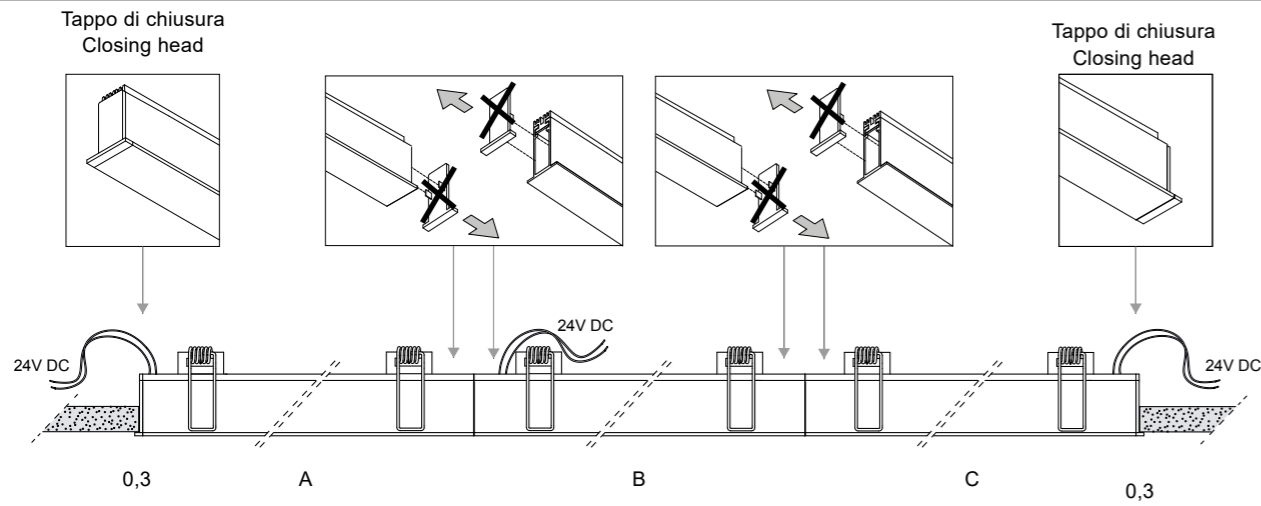

A B C = Lunghezza delle lampade senza tappi di chiusura. Lamps length without closing heads.

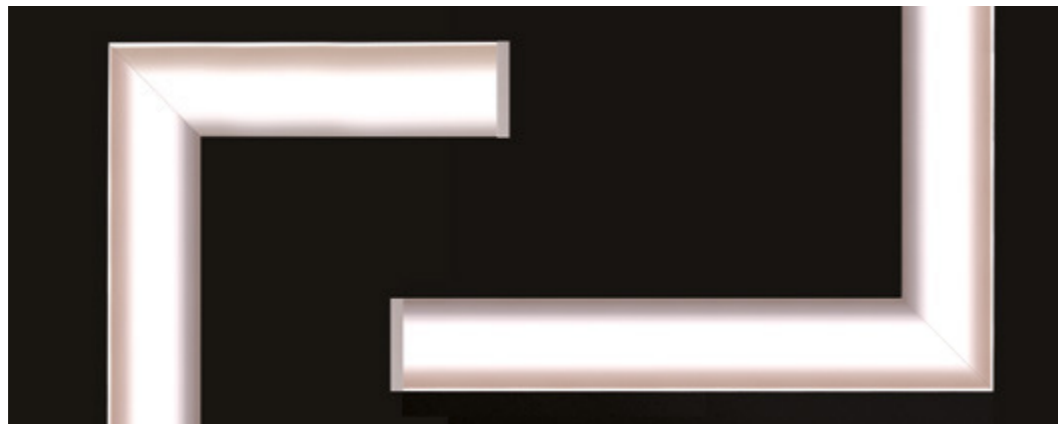

Su richiesta sono disponibili soluzioni angolari a 90° - 90° angled options are available upon request



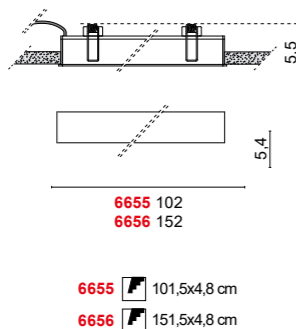

6655 Linea Maxi
.01 Bianco - White

Color temperature	LED Light source	Im source
/W 4000K	24V 18W	2260lm
/WW 3000K	24V 18W	2020lm
/XW 2700K	24V 18W	1890lm

Versione ETL disponibile su richiesta
ETL version available upon request

6656 Linea Maxi
.01 Bianco - White

Color temperature	LED Light source	Im source
/W 4000K	24V 27W	3390lm
/WW 3000K	24V 27W	3030lm
/XW 2700K	24V 27W	2835lm

Versione ETL disponibile su richiesta
ETL version available upon request

Lighting system

Opportunamente installato garantisce UGR < 19 (Indice unificato d'abbagliamento)
Conveniently positioned grants an UGR < 19 (Unified Glare Rating)

LINEA MAXI RGB

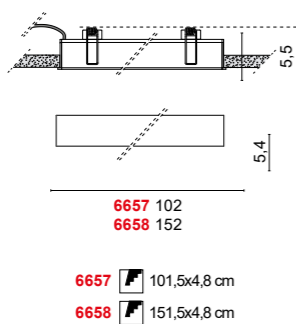

6657 Linea Maxi RGB
.01 Bianco - White

LED Light source
24V 14,4W

Versione ETL disponibile su richiesta
ETL version available upon request

6658 Linea Maxi RGB
.01 Bianco - White

LED Light source
24V 21,6W

Versione ETL disponibile su richiesta
ETL version available upon request

Accessori - Accessories

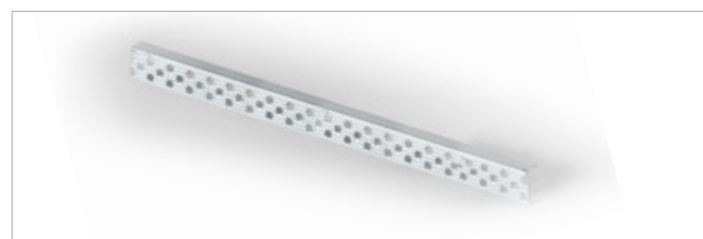

0242

Profilo angolare opzionale per facilitare l'installazione nel cartongesso.
Optional L shaped profile to ease installation into plasterboard.

/100	100 cm
/200	200 cm
/300	300 cm



CUSTOM SIZE

Tabella lunghezze disponibili su richiesta. Le misure si riferiscono alle lunghezze totali delle lampade comprese di tappi terminali. N.B. senza tappi: - 1 cm.
Table of available lengths on request. Measures are referred to complete fixtures including closing heads. Attention: Without closing heads: - 1 cm.

cm	watt	cm	2700K (XW)	Im source	3000K (WW)	Im source	4000K (W)	Im source	RGB
12	1,8W	11,5x4,8	A6655.01/10/XW	189	A6655.01/10/WW	202	A6655.01/10/W	226	A6655.01/10RGB
22	3,6W	21,5x4,8	A6655.01/20/XW	378	A6655.01/20/WW	404	A6655.01/20/W	452	A6655.01/20RGB
32	5,4W	31,5x4,8	A6655.01/30/XW	567	A6655.01/30/WW	606	A6655.01/30/W	678	A6655.01/30RGB
42	7,2W	41,5x4,8	A6655.01/40/XW	756	A6655.01/40/WW	808	A6655.01/40/W	904	A6655.01/40RGB
52	9W	51,5x4,8	A6655.01/50/XW	645	A6655.01/50/WW	1010	A6655.01/50/W	1130	A6655.01/50RGB
62	10,8W	61,5x4,8	A6655.01/60/XW	1134	A6655.01/60/WW	1212	A6655.01/60/W	1356	A6655.01/60RGB
72	12,6W	71,5x4,8	A6655.01/70/XW	1323	A6655.01/70/WW	1414	A6655.01/70/W	1582	A6655.01/70RGB
82	14,4W	81,5x4,8	A6655.01/80/XW	1512	A6655.01/80/WW	1616	A6655.01/80/W	1808	A6655.01/80RGB
92	16,2W	91,5x4,8	A6655.01/90/XW	1701	A6655.01/90/WW	1818	A6655.01/90/W	2034	A6655.01/90RGB
102	18W	101,5x4,8	6655.01/XW *	1890	6655.01/WW *	2020	6655.01/W *	2260	6657.01 *
112	19,8W	111,5x4,8	A6655.01/110/XW	2079	A6655.01/110/WW	2222	A6655.01/110/W	2486	A6655.01/110RGB
122	21,6W	121,5x4,8	A6655.01/120/XW	2268	A6655.01/120/WW	2424	A6655.01/120/W	2712	A6655.01/120RGB
132	23,4W	131,5x4,8	A6655.01/130/XW	2457	A6655.01/130/WW	2626	A6655.01/130/W	2938	A6655.01/130RGB
142	25,2W	141,5x4,8	A6655.01/140/XW	2646	A6655.01/140/WW	2828	A6655.01/140/W	3164	A6655.01/140RGB
152	27W	151,5x4,8	6656.01/XW *	2835	6656.01/WW *	3030	6656.01/W *	3390	6658.01 *
162	28,8W	161,5x4,8	A6655.01/160/XW	3024	A6655.01/160/WW	3232	A6655.01/160/W	3616	A6655.01/160RGB
172	30,6W	171,5x4,8	A6655.01/170/XW	3213	A6655.01/170/WW	3434	A6655.01/170/W	3842	A6655.01/170RGB
182	32,4W	181,5x4,8	A6655.01/180/XW	3402	A6655.01/180/WW	3636	A6655.01/180/W	4068	A6655.01/180RGB
192	34,2W	191,5x4,8	A6655.01/190/XW	3591	A6655.01/190/WW	3838	A6655.01/190/W	4294	A6655.01/190RGB
202	36W	201,5x4,8	A6655.01/200/XW	3780	A6655.01/200/WW	4040	A6655.01/200/W	4520	A6655.01/200RGB
212	37,8W	211,5x4,8	A6655.01/210/XW	3969	A6655.01/210/WW	4242	A6655.01/210/W	4746	A6655.01/210RGB
222	39,6W	221,5x4,8	A6655.01/220/XW	4158	A6655.01/220/WW	4444	A6655.01/220/W	4972	A6655.01/220RGB
232	41,4W	231,5x4,8	A6655.01/230/XW	4347	A6655.01/230/WW	4646	A6655.01/230/W	5198	A6655.01/230RGB
242	43,2W	241,5x4,8	A6655.01/240/XW	4536	A6655.01/240/WW	4848	A6655.01/240/W	5424	A6655.01/240RGB
252	45W	251,5x4,8	A6655.01/250/XW	4725	A6655.01/250/WW	5050	A6655.01/250/W	5650	A6655.01/250RGB
262	46,8W	261,5x4,8	A6655.01/260/XW	4914	A6655.01/260/WW	5252	A6655.01/260/W	5876	A6655.01/260RGB
272	48,6W	271,5x4,8	A6655.01/270/XW	5103	A6655.01/270/WW	5454	A6655.01/270/W	6102	A6655.01/270RGB
282	50,4W	281,5x4,8	A6655.01/280/XW	5292	A6655.01/280/WW	5656	A6655.01/280/W	6328	A6655.01/280RGB
292	52,2W	291,5x4,8	A6655.01/290/XW	5481	A6655.01/290/WW	5858	A6655.01/290/W	6554	A6655.01/290RGB
302	54W	301,5x4,8	A6655.01/300/XW	5670	A6655.01/300/WW	6060	A6655.01/300/W	6780	A6655.01/300RGB

* Articolo standard a catalogo - Standard catalogue item

Drivers

Drivers ON/OFF

Cod.	0155	0156	0160	0157	0161/100	0162
	24V-13W	24V-25W	24V-50W	24V-75W	24V-100W	24V-150W

DIMMABLE drivers

Cod.	0110/DIM	0717/DIM60/V	0717/DIM60	0717/DIM100
	12/24V	24V-60W 1...10V	24V-60W PUSH - DALI	24V-100W 1...10V - PUSH - DALI

LED emergency unit

Cod.	0115/EM
	Inverter + Battery + LED indicator

RGB drivers

Cod.	0164	0167	0164/CASA
	120W	22W	120W
	IN:230V - OUT: 3x24V		IN:230V - OUT: 3x24V

Driver RGB Casambi

0163	0165	0166
IR Sensor	IR Remote controller	Sinc Cable

Solo collegamento in parallelo - Only parallel connection

Lighting system

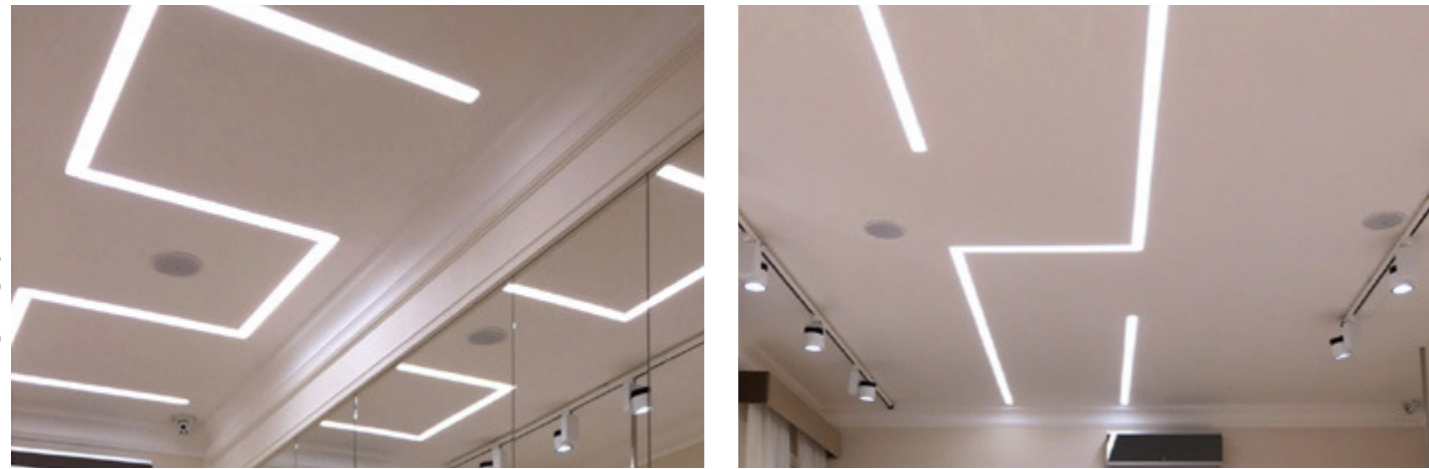

Lunghezze superiori ai 3 metri si ottengono accostando i singoli elementi, il foro d'incasso si calcola con la seguente formula:
 Configurations longer than 3 meters can be obtained by putting single fittings side by side in a row, the cutout length can be calculated with the formula hereunder:

Esempi - Examples 4,8x L cm

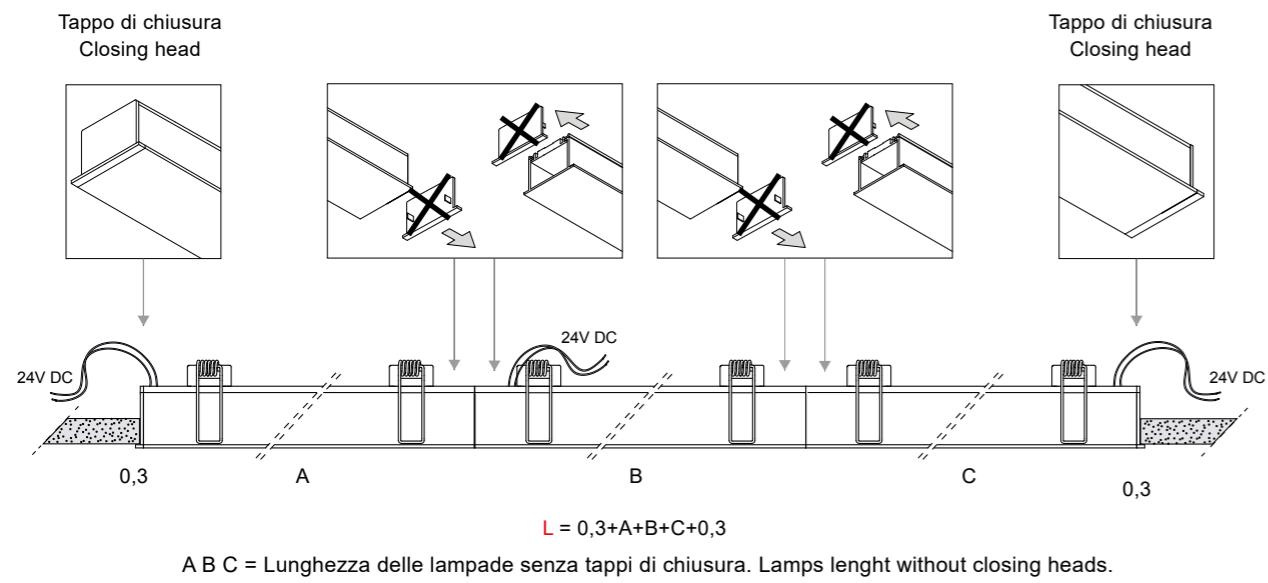

Su richiesta sono disponibili soluzioni angolari a 90° - 90° angled options are available upon request



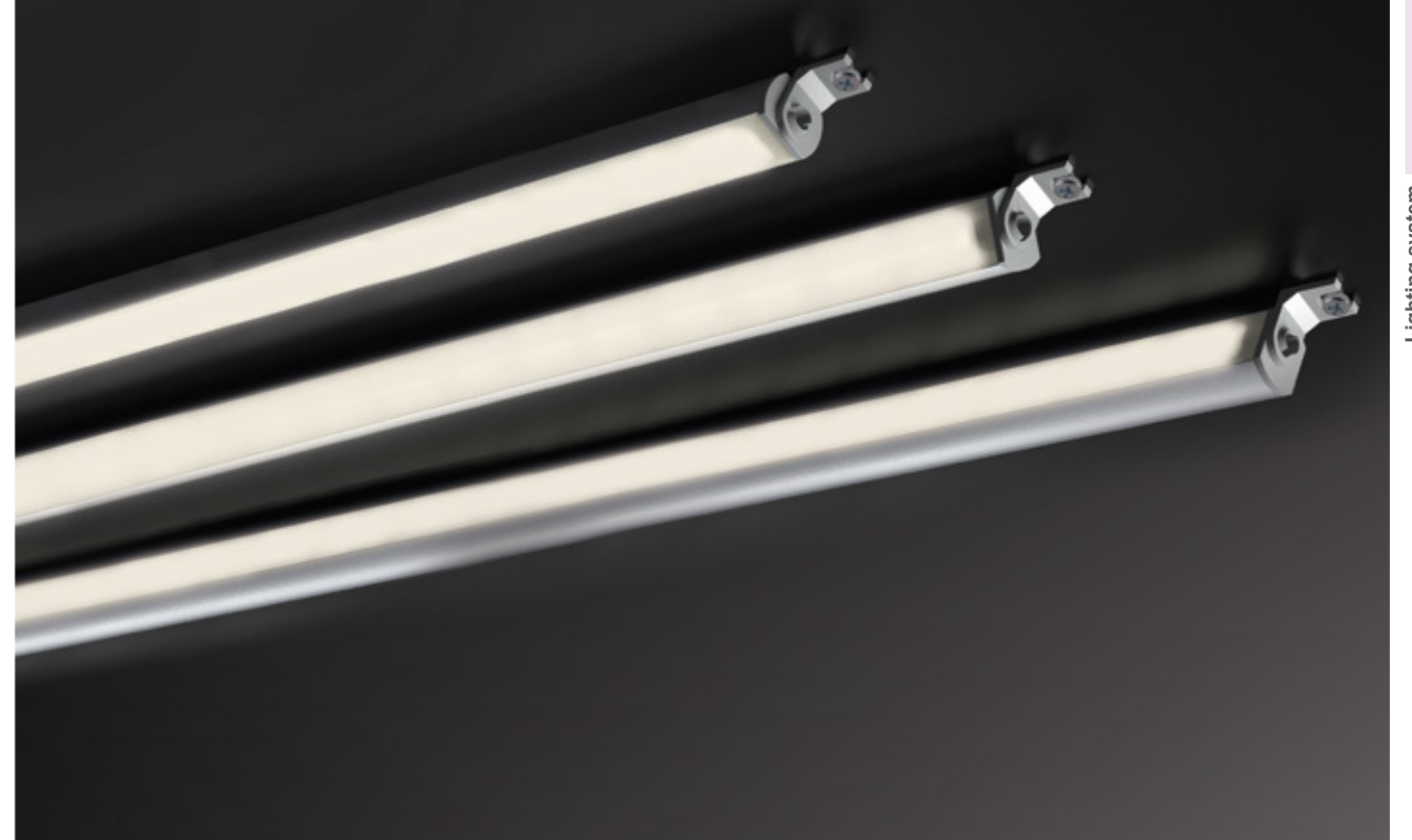
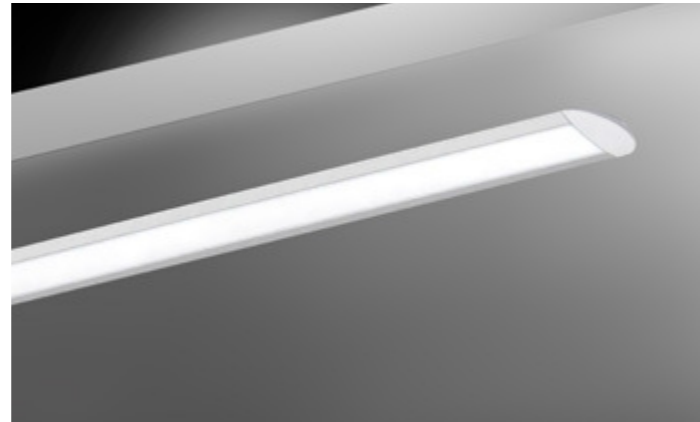

PROFILI design: U.T. EGOLUCE

Barre lineari per luce LED in estruso d'alluminio anodizzato con diffusori in policarbonato opalino per applicazioni su parete, soffitto o ad incasso.

Tappi di chiusura in ABS verniciato. Disponibili in diverse misure (vedi tabelle), tre temperature di colore della luce (2700K, 3000K e 4000K) e versioni RGB. LED CRI>90, 180 LED/metro (15W o 18W) o 120 LED/metro (9,6W), 3 SDCM.

Linear profiles for LED light in extruded anodized aluminum with opal polycarbonate diffusers for wall, ceiling or recessed applications.

Closing caps in painted ABS. Available in different sizes (see tables), three light color temperatures (2700K, 3000K and 4000K) and RGB versions. CRI LED >90, 180 LED/meter (15W or 18W) or 120 LED/meter (9,6W), 3 SDCM.

Barres linéaires pour lumière LED en aluminium extrudé anodisé avec diffuseurs en polycarbonate opale pour applications en applique, plafond ou encastrées.

Bouchons de fermeture en ABS peint. Disponible en différentes tailles (voir tableaux), trois températures de couleur (2700K, 3000K et 4000K) et versions RGB. LED CRI > 90, 180 LED/mètre (15W ou 18W) ou 120 LED/mètre (9,6W), 3 SDCM.

Barras lineales para luz LED en aluminio anodizado extruido con difusores de policarbonato opal para aplicaciones sobre pared, techo o empotradas. Taponos de cierre, en ABS pintado. Disponible en diferentes tamaños (ver tablas), tres temperaturas de color de la luz (2700K, 3000K y 4000K) y versiones RGB.

LED CRI > 90, 180 LED / metro (15W o 18W) o 120 LED / metro (9,6W), 3 SDCM.

Lineare LED-Lichtleisten aus stranggepresstem, eloxiertem Aluminium mit Diffusoren aus opalem Polycarbonat für Wall oder Decken oder Einbauanwendungen.

Verschlusskappen aus lackiertem ABS. Erhältlich in verschiedenen Größen (siehe Tabellen), drei Lichtfarbtemperaturen (2700K, 3000K und 4000K) und RGB-Versionen. CRI-LED > 90, 180 LED / Meter (15 W oder 18 W) oder 120 LED / Meter (9,6 W), 3 SDCM.

Линейные линейки для светодиодного освещения из экструдированного анодированного алюминия с рассеивателями из поликарбоната опала для наружных или встраиваемых систем

Закрывающиеся крышки, окрашенные в серый цвет ABS. Доступны разные размеры (см. Таблицы), три варианта цветовой температуры (2700K, 3000K и 4000K) и версии RGB.

Светодиоды CRI > 90, 180 светодиодов / метр (15 Вт или 18 Вт) или 120 светодиодов / метр (9,6 Вт), 3 СДКМ.

Lighting system

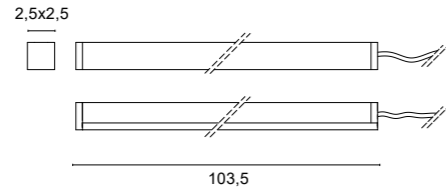

4521 Extra

.01 Bianco - White

	Color temperature	LED Light source	lm source
/W	4000K	24V 15W	1840lm
/WW	3000K	24V 15W	1650lm
/XW	2700K	24V 15W	1560lm



Versione ETL disponibile su richiesta
ETL version available upon request

0,15Kg

Pixeling free

Il nuovo circuito 15W/mt - 180 LED/mt, CRI>90 annulla l'effetto puntiforme garantendo una luce continua e uniforme.

New LED strip 15W/mt - 180 LED/mt, CRI>90 cancels the pixeling effect guaranteeing a continuous and uniform light.



CUSTOM SIZE

Tabella lunghezze disponibili su richiesta. - Table of available lengths on request.

cm	watt	2700K (XW)	lm source	3000K (WW)	lm source	4000K (W)	lm source
13,5	1,5W	A4521.01/10/XW	156	A4521.01/10/WW	165	A4521.01/10/W	184
23,5	3W	A4521.01/20/XW	312	A4521.01/20/WW	330	A4521.01/20/W	368
33,5	4,5W	A4521.01/30/XW	468	A4521.01/30/WW	495	A4521.01/30/W	552
43,5	6W	A4521.01/40/XW	624	A4521.01/40/WW	660	A4521.01/40/W	736
53,5	7,5W	A4521.01/50/XW	780	A4521.01/50/WW	825	A4521.01/50/W	920
63,5	9W	A4521.01/60/XW	936	A4521.01/60/WW	990	A4521.01/60/W	1104
73,5	10,5W	A4521.01/70/XW	1092	A4521.01/70/WW	1155	A4521.01/70/W	1288
83,5	12W	A4521.01/80/XW	1248	A4521.01/80/WW	1320	A4521.01/80/W	1472
93,5	13,5W	A4521.01/90/XW	1404	A4521.01/90/WW	1485	A4521.01/90/W	1656
* 103,5	15W	4521.01/XW	1560	4521.01/WW	1650	4521.01/W	1840
113,5	16,5W	A4521.01/110/XW	1716	A4521.01/110/WW	1815	A4521.01/110/W	2024
123,5	18W	A4521.01/120/XW	1872	A4521.01/120/WW	1980	A4521.01/120/W	2208
133,5	19,5W	A4521.01/130/XW	2028	A4521.01/130/WW	2145	A4521.01/130/W	2392
143,5	21W	A4521.01/140/XW	2184	A4521.01/140/WW	2310	A4521.01/140/W	2576
153,5	22,5W	A4521.01/150/XW	2340	A4521.01/150/WW	2475	A4521.01/150/W	2760
163,5	24W	A4521.01/160/XW	2496	A4521.01/160/WW	2640	A4521.01/160/W	2944
173,5	25,5W	A4521.01/170/XW	2652	A4521.01/170/WW	2805	A4521.01/170/W	3128
183,5	27W	A4521.01/180/XW	2808	A4521.01/180/WW	2970	A4521.01/180/W	3312
193,5	28,5W	A4521.01/190/XW	2964	A4521.01/190/WW	3135	A4521.01/190/W	3496
203,5	30W	A4521.01/200/XW	3120	A4521.01/200/WW	3300	A4521.01/200/W	3680
213,5	31,5W	A4521.01/210/XW	3276	A4521.01/210/WW	3465	A4521.01/210/W	3864
223,5	33W	A4521.01/220/XW	3432	A4521.01/220/WW	3630	A4521.01/220/W	4048
233,5	34,5W	A4521.01/230/XW	3588	A4521.01/230/WW	3795	A4521.01/230/W	4232
243,5	36W	A4521.01/240/XW	3744	A4521.01/240/WW	3960	A4521.01/240/W	4416
253,5	37,5W	A4521.01/250/XW	3900	A4521.01/250/WW	4125	A4521.01/250/W	4600
263,5	39W	A4521.01/260/XW	4056	A4521.01/260/WW	4290	A4521.01/260/W	4784
273,5	40,5W	A4521.01/270/XW	4212	A4521.01/270/WW	4455	A4521.01/270/W	4968
283,5	42W	A4521.01/280/XW	4368	A4521.01/280/WW	4620	A4521.01/280/W	5152
293,5	43,5W	A4521.01/290/XW	4524	A4521.01/290/WW	4785	A4521.01/290/W	5336
303,5	45W	A4521.01/300/XW	4680	A4521.01/300/WW	4950	A4521.01/300/W	5520

* Articolo standard a catalogo - Standard catalogue item



Drivers

Drivers **ON/OFF**

Cod.	0155	0156	0160	0157	0161/100	0162
	24V-13W	24V-25W	24V-50W	24V-75W	24V-100W	24V-150W

DIMMABLE drivers

Cod.	0110/DIM	0717/DIM60/V	0717/DIM60	0717/DIM100
	12/24V	24V-60W 1...10V	24V-60W PUSH - DALI	24V-100W 1...10V - PUSH - DALI

LED emergency unit

Cod.	0115/EM
	Inverter + Battery + LED indicator

Solo collegamento in parallelo - Only parallel connection

Lighting system

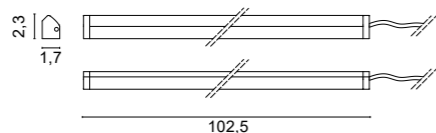

4520 Margo

.45 Alluminio anodizzato
Aluminium anodized

Color temperature	LED Light source	lm source
/W 4000K	24V 15W	1840lm
/WW 3000K	24V 15W	1650lm
/XW 2700K	24V 15W	1560lm



0,15 Kg

Versione ETL disponibile su richiesta
ETL version available upon request

Pixeling free

Il nuovo circuito 15W/mt - 180 LED/mt, CRI>90 annulla l'effetto puntiforme garantendo una luce continua e uniforme.

New LED strip 15W/mt - 180 LED/mt, CRI>90 cancels the pixeling effect guaranteeing a continuous and uniform light.



Optional

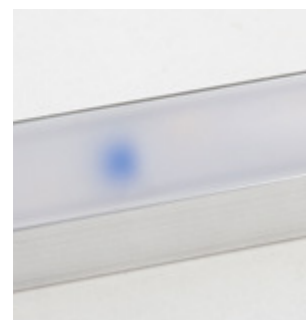

0131/S

Interruttore dimmer touch su richiesta. La lunghezza della lampada rimane invariata, l'interruttore riduce di 10 cm la linea di luce

Touch dimmer switch on request. The lamp length don't change, touch switch reduces 10 cm the light line.



0131/RV

Sensore di presenza su richiesta. La lunghezza della lampada rimane invariata, il sensore riduce di 10 cm la linea di luce

Body detector on request. The lamp length don't change, body detector reduces 10 cm the light line

CUSTOM SIZE

Tabella lunghezze disponibili. Le misure si riferiscono alle lunghezze totali delle lampade complete di tappi.
Table of available lengths. Measures are referred to complete fixtures including closing heads.

cm	watt	2700K (XW)	lm source	3000K (WW)	lm source	4000K (W)	lm source	RGB
12,5	1,5W	A4520.45/10/XW	156	A4520.45/10/WW	165	A4520.45/10/W	184	A4520.45/10RGB
22,5	3W	A4520.45/20/XW	312	A4520.45/20/WW	330	A4520.45/20/W	368	A4520.45/20RGB
32,5	4,5W	A4520.45/30/XW	468	A4520.45/30/WW	495	A4520.45/30/W	552	A4520.45/30RGB
42,5	6W	A4520.45/40/XW	624	A4520.45/40/WW	660	A4520.45/40/W	736	A4520.45/40RGB
52,5	7,5W	A4520.45/50/XW	780	A4520.45/50/WW	825	A4520.45/50/W	920	A4520.45/50RGB
62,5	9W	A4520.45/60/XW	936	A4520.45/60/WW	990	A4520.45/60/W	1104	A4520.45/60RGB
72,5	10,5W	A4520.45/70/XW	1092	A4520.45/70/WW	1155	A4520.45/70/W	1288	A4520.45/70RGB
82,5	12W	A4520.45/80/XW	1248	A4520.45/80/WW	1320	A4520.45/80/W	1472	A4520.45/80RGB
92,5	13,5W	A4520.45/90/XW	1404	A4520.45/90/WW	1485	A4520.45/90/W	1656	A4520.45/90RGB
* 102,5	15W	4520.45/XW	1560	4520.45/WW	1650	4520.45/W	1840	A4520.45/100RGB
112,5	16,5W	A4520.45/110/XW	1716	A4520.45/110/WW	1815	A4520.45/110/W	2024	A4520.45/110RGB
122,5	18W	A4520.45/120/XW	1872	A4520.45/120/WW	1980	A4520.45/120/W	2208	A4520.45/120RGB
132,5	19,5W	A4520.45/130/XW	2028	A4520.45/130/WW	2145	A4520.45/130/W	2392	A4520.45/130RGB
142,5	21W	A4520.45/140/XW	2184	A4520.45/140/WW	2310	A4520.45/140/W	2576	A4520.45/140RGB
152,5	22,5W	A4520.45/150/XW	2340	A4520.45/150/WW	2475	A4520.45/150/W	2760	A4520.45/150RGB
162,5	24W	A4520.45/160/XW	2496	A4520.45/160/WW	2640	A4520.45/160/W	2944	A4520.45/160RGB
172,5	25,5W	A4520.45/170/XW	2652	A4520.45/170/WW	2805	A4520.45/170/W	3128	A4520.45/170RGB
182,5	27W	A4520.45/180/XW	2808	A4520.45/180/WW	2970	A4520.45/180/W	3312	A4520.45/180RGB
192,5	28,5W	A4520.45/190/XW	2964	A4520.45/190/WW	3135	A4520.45/190/W	3496	A4520.45/190RGB
202,5	30W	A4520.45/200/XW	3120	A4520.45/200/WW	3300	A4520.45/200/W	3680	A4520.45/200RGB
212,5	31,5W	A4520.45/210/XW	3276	A4520.45/210/WW	3465	A4520.45/210/W	3864	A4520.45/210RGB
222,5	33W	A4520.45/220/XW	3432	A4520.45/220/WW	3630	A4520.45/220/W	4048	A4520.45/220RGB
232,5	34,5W	A4520.45/230/XW	3588	A4520.45/230/WW	3795	A4520.45/230/W	4232	A4520.45/230RGB
242,5	36W	A4520.45/240/XW	3744	A4520.45/240/WW	3960	A4520.45/240/W	4416	A4520.45/240RGB
252,5	37,5W	A4520.45/250/XW	3900	A4520.45/250/WW	4125	A4520.45/250/W	4600	A4520.45/250RGB
262,5	39W	A4520.45/260/XW	4056	A4520.45/260/WW	4290	A4520.45/260/W	4784	A4520.45/260RGB
272,5	40,5W	A4520.45/270/XW	4212	A4520.45/270/WW	4455	A4520.45/270/W	4968	A4520.45/270RGB
282,5	42W	A4520.45/280/XW	4368	A4520.45/280/WW	4620	A4520.45/280/W	5152	A4520.45/280RGB
292,5	43,5W	A4520.45/290/XW	4524	A4520.45/290/WW	4785	A4520.45/290/W	5336	A4520.45/290RGB
302,5	45W	A4520.45/300/XW	4680	A4520.45/300/WW	4950	A4520.45/300/W	5520	A4520.45/300RGB

* Articolo standard a catalogo - Standard catalogue item

Drivers

Drivers ON/OFF

Cod.	0155	0156	0160	0157	0161/100	0162
	24V-13W	24V-25W	24V-50W	24V-75W	24V-100W	24V-150W

DIMMABLE drivers

Cod.	0110/DIM	0717/DIM60/V	0717/DIM60	0717/DIM100
	12/24V	24V-60W 1...10V	24V-60W PUSH - DALI	24V-100W 1...10V - PUSH - DALI

LED emergency unit

Cod.	0115/EM
	Inverter + Battery + LED indicator

RGB drivers

Cod.	0164	0167	0164/CASA	0163	0165	0166
	120W	22W	120W	IR Sensor	IR Remote controller	Sinc Cable
	IN:230V - OUT: 3x24V		IN:230V - OUT: 3x24V			

Solo collegamento in parallelo - Only parallel connection

Lighting system

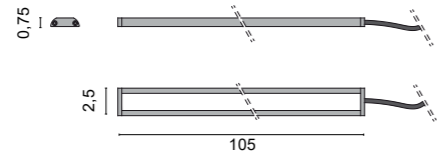

4515 Plana

- .01** Bianco - White
- .45** Alluminio anodizzato
Aluminium anodized

Color temperature	LED Light source	lm source
/W 4000K	24V 9,6W	1080lm
/WW 3000K	24V 9,6W	1020lm
/XW 2700K	24V 9,6W	960lm



0,15Kg

Versione ETL disponibile su richiesta
ETL version available upon request

Pixeling free

Il nuovo circuito 15W/mt - 180 LED/mt, CRI>90 annulla l'effetto puntiforme garantendo una luce continua e uniforme.

New LED strip 15W/mt - 180 LED/mt, CRI>90 cancels the pixeling effect guaranteeing a continuous and uniform light.



Optional

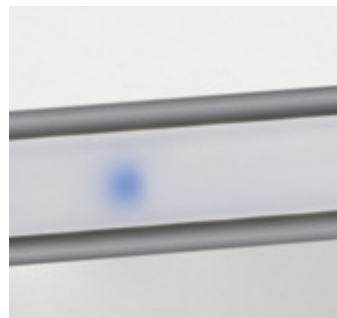

0131/S

Interruttore dimmer touch su richiesta. La lunghezza della lampada rimane invariata, l'interruttore riduce di 10 cm la linea di luce

Touch dimmer switch on request. The lamp length don't change, touch switch reduces 10 cm the light line.



CUSTOM SIZE

Tabella lunghezze disponibili. Le misure si riferiscono alle lunghezze totali delle lampade complete di tappi.
Table of available lengths. Measures are referred to complete fixtures including closing heads.

cm	watt	2700K (XW)	lm source	3000K (WW)	lm source	4000K (W)	lm source
15	1W	A4515 * /10/XW	96	A4515 * /10/WW	102	A4515 * /10/W	108
25	1,9W	A4515 * /20/XW	192	A4515 * /20/WW	204	A4515 * /20/W	216
35	2,9W	A4515 * /30/XW	288	A4515 * /30/WW	306	A4515 * /30/W	324
45	3,8W	A4515 * /40/XW	384	A4515 * /40/WW	408	A4515 * /40/W	432
55	4,8W	A4515 * /50/XW	480	A4515 * /50/WW	510	A4515 * /50/W	540
65	5,8W	A4515 * /60/XW	576	A4515 * /60/WW	612	A4515 * /60/W	648
75	6,7W	A4515 * /70/XW	672	A4515 * /70/WW	714	A4515 * /70/W	756
85	7,7W	A4515 * /80/XW	768	A4515 * /80/WW	816	A4515 * /80/W	864
95	8,6W	A4515 * /90/XW	864	A4515 * /90/WW	918	A4515 * /90/W	972
105 **	9,6W	4515 * /XW	960	4515 * /WW	1020	4515 * /W	1080
115	10,6W	A4515 * /110/XW	1056	A4515 * /110/WW	1122	A4515 * /110/W	1188
125	11,5W	A4515 * /120/XW	1152	A4515 * /120/WW	1224	A4515 * /120/W	1296
135	12,5W	A4515 * /130/XW	1248	A4515 * /130/WW	1326	A4515 * /130/W	1404
145	13,4W	A4515 * /140/XW	1344	A4515 * /140/WW	1428	A4515 * /140/W	1512
155	14,4W	A4515 * /150/XW	1440	A4515 * /150/WW	1530	A4515 * /150/W	1620
165	15,4W	A4515 * /160/XW	1536	A4515 * /160/WW	1632	A4515 * /160/W	1728
175	16,3W	A4515 * /170/XW	1632	A4515 * /170/WW	1734	A4515 * /170/W	1836
185	17,3W	A4515 * /180/XW	1728	A4515 * /180/WW	1836	A4515 * /180/W	1944
195	18,2W	A4515 * /190/XW	1824	A4515 * /190/WW	1938	A4515 * /190/W	2052
205	19,2W	A4515 * /200/XW	1920	A4515 * /200/WW	2040	A4515 * /200/W	2160
215	20,2W	A4515 * /210/XW	2016	A4515 * /210/WW	2142	A4515 * /210/W	2268
225	21,1W	A4515 * /220/XW	2112	A4515 * /220/WW	2244	A4515 * /220/W	2376
235	22,1W	A4515 * /230/XW	2208	A4515 * /230/WW	2346	A4515 * /230/W	2484
245	23W	A4515 * /240/XW	2304	A4515 * /240/WW	2448	A4515 * /240/W	2592
255	24W	A4515 * /250/XW	2400	A4515 * /250/WW	2550	A4515 * /250/W	2700
265	25W	A4515 * /260/XW	2496	A4515 * /260/WW	2652	A4515 * /260/W	2808
275	25,9W	A4515 * /270/XW	2592	A4515 * /270/WW	2754	A4515 * /270/W	2916
285	26,9W	A4515 * /280/XW	2688	A4515 * /280/WW	2856	A4515 * /280/W	3024
295	27,8W	A4515 * /290/XW	2784	A4515 * /290/WW	2958	A4515 * /290/W	3132
305	28,8W	A4515 * /300/XW	2880	A4515 * /300/WW	3060	A4515 * /300/W	3240

* Finiture - Finishes:

- .01** Bianco - White
- .45** Alluminio anodizzato - Aluminium anodized

** Articolo standard a catalogo - Standard catalogue item

Drivers

Drivers ON/OFF

Cod.	0155	0156	0160	0157	0161/100	0162
	24V-13W	24V-25W	24V-50W	24V-75W	24V-100W	24V-150W

DIMMABLE drivers

Cod.	0110/DIM	0717/DIM60/V	0717/DIM60	0717/DIM100
	12/24V	24V-60W 1...10V	24V-60W PUSH - DALI	24V-100W 1...10V - PUSH - DALI

LED emergency unit

Cod.	0115/EM
	Inverter + Battery + LED indicator

Solo collegamento in parallelo - Only parallel connection

Lighting system

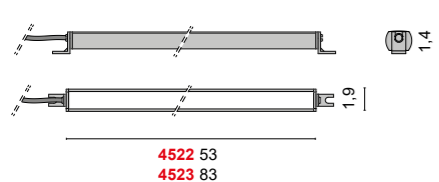

4522 Magika
.45 Alluminio anodizzato
Aluminium anodized

Color temperature	LED Light source	lm source
/W 4000K	24V 7,5W	920lm
/WW 3000K	24V 7,5W	825m
/XW 2700K	24V 7,5W	780lm

0,15Kg
 Versione ETL disponibile su richiesta
ETL version available upon request

4523 Magika
.45 Alluminio anodizzato
Aluminium anodized

Color temperature	LED Light source	lm source
/W 4000K	24V 12W	1472lm
/WW 3000K	24V 12W	1320m
/XW 2700K	24V 12W	1248lm

0,20Kg
 Versione ETL disponibile su richiesta
ETL version available upon request

Pixeling free

Il nuovo circuito 15W/mt - 180 LED/mt, CRI>90 annulla l'effetto puntiforme garantendo una luce continua e uniforme.

New LED strip 15W/mt - 180 LED/mt, CRI>90 cancels the pixeling effect guaranteeing a continuous and uniform light.



Optional

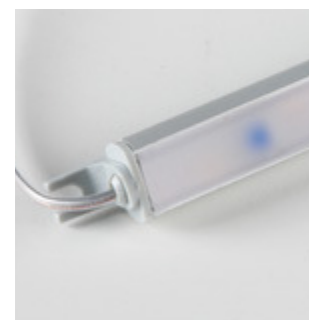

0131/S
 Interruttore dimmer touch su richiesta. La lunghezza della lampada rimane invariata, l'interruttore riduce di 10 cm la linea di luce
 Touch dimmer switch on request. The lamp length don't change, touch switch reduces 10 cm the light line.



0131/RV
 Sensore di presenza su richiesta. La lunghezza della lampada rimane invariata, il sensore riduce di 10 cm la linea di luce
 Body detector on request. The lamp length don't change, body detector reduces 10 cm the light line

CUSTOM SIZE

Tabella lunghezze disponibili. Le misure si riferiscono alle lunghezze totali delle lampade senza squadrette orientabili. Per montaggio con squadrette orientabili aggiungere 2 cm.
 Table of available lengths. Measures are referred to complete fixtures excluding fixing supports. To install using fixing supports add 2 cm more.

cm	watt	2700K (XW)	lm source	3000K (WW)	lm source	4000K (W)	lm source	RGB
13	1,5W	A4522.45/10/XW	156	A4522.45/10/WW	165	A4522.45/10/W	184	A4522.45/10RGB
23	3W	A4522.45/20/XW	312	A4522.45/20/WW	330	A4522.45/20/W	368	A4522.45/20RGB
33	4,5W	A4522.45/30/XW	468	A4522.45/30/WW	495	A4522.45/30/W	552	A4522.45/30RGB
43	6W	A4522.45/40/XW	624	A4522.45/40/WW	660	A4522.45/40/W	736	A4522.45/40RGB
53**	7,5W	4522.45/XW	780	4522.45/WW	825	4522.45/W	920	A4522.45/50RGB
63	9W	A4522.45/60/XW	936	A4522.45/60/WW	990	A4522.45/60/W	1104	A4522.45/60RGB
73	10,5W	A4522.45/70/XW	1092	A4522.45/70/WW	1155	A4522.45/70/W	1288	A4522.45/70RGB
83**	12W	4523.45/XW	1248	4523.45/WW	1320	4523.45/W	1472	A4522.45/80RGB
93	13,5W	A4522.45/90/XW	1404	A4522.45/90/WW	1485	A4522.45/90/W	1656	A4522.45/90RGB
103	15W	A4522.45/100/XW	1560	A4522.45/100/WW	1650	A4522.45/100/W	1840	A4522.45/100RGB
113	16,5W	A4522.45/110/XW	1716	A4522.45/110/WW	1815	A4522.45/110/W	2024	A4522.45/110RGB
123	18W	A4522.45/120/XW	1872	A4522.45/120/WW	1980	A4522.45/120/W	2208	A4522.45/120RGB
133	19,5W	A4522.45/130/XW	2028	A4522.45/130/WW	2145	A4522.45/130/W	2392	A4522.45/130RGB
143	21W	A4522.45/140/XW	2184	A4522.45/140/WW	2310	A4522.45/140/W	2576	A4522.45/140RGB
153	22,5W	A4522.45/150/XW	2340	A4522.45/150/WW	2475	A4522.45/150/W	2760	A4522.45/150RGB
163	24W	A4522.45/160/XW	2496	A4522.45/160/WW	2640	A4522.45/160/W	2944	A4522.45/160RGB
173	25,5W	A4522.45/170/XW	2652	A4522.45/170/WW	2805	A4522.45/170/W	3128	A4522.45/170RGB
183	27W	A4522.45/180/XW	2808	A4522.45/180/WW	2970	A4522.45/180/W	3312	A4522.45/180RGB
193	28,5W	A4522.45/190/XW	2964	A4522.45/190/WW	3135	A4522.45/190/W	3496	A4522.45/190RGB
203	30W	A4522.45/200/XW	3120	A4522.45/200/WW	3300	A4522.45/200/W	3680	A4522.45/200RGB
213	31,5W	A4522.45/210/XW	3276	A4522.45/210/WW	3465	A4522.45/210/W	3864	A4522.45/210RGB
223	33W	A4522.45/220/XW	3432	A4522.45/220/WW	3630	A4522.45/220/W	4048	A4522.45/220RGB
233	34,5W	A4522.45/230/XW	3588	A4522.45/230/WW	3795	A4522.45/230/W	4232	A4522.45/230RGB
243	36W	A4522.45/240/XW	3744	A4522.45/240/WW	3960	A4522.45/240/W	4416	A4522.45/240RGB
253	37,5W	A4522.45/250/XW	3900	A4522.45/250/WW	4125	A4522.45/250/W	4600	A4522.45/250RGB
263	39W	A4522.45/260/XW	4056	A4522.45/260/WW	4290	A4522.45/260/W	4784	A4522.45/260RGB
273	40,5W	A4522.45/270/XW	4212	A4522.45/270/WW	4455	A4522.45/270/W	4968	A4522.45/270RGB
283	42W	A4522.45/280/XW	4368	A4522.45/280/WW	4620	A4522.45/280/W	5152	A4522.45/280RGB
293	43,5W	A4522.45/290/XW	4524	A4522.45/290/WW	4785	A4522.45/290/W	5336	A4522.45/290RGB
303	45W	A4522.45/300/XW	4680	A4522.45/300/WW	4950	A4522.45/300/W	5520	A4522.45/300RGB

** Articolo standard a catalogo - Standard catalogue item



Se installato con le squadrette laterali in dotazione, il profilo puo' ruotare per indirizzare la luce.

If installed with the supplied side brackets, the profile can rotate to direct the light.

Drivers

Drivers ON/OFF						
Cod.	0155	0156	0160	0157	0161/100	0162
	24V-13W	24V-25W	24V-50W	24V-75W	24V-100W	24V-150W

DIMMABLE drivers				
Cod.	0110/DIM	0717/DIM60/V	0717/DIM60	0717/DIM100
	12/24V	24V-60W 1...10V	24V-60W PUSH - DALI	24V-100W 1...10V - PUSH - DALI

LED emergency unit	
Cod.	0115/EM
	Inverter + Battery + LED indicator

RGB drivers		Driver RGB Casambi				
Cod.	0164	0167	0164/CASA	0163	0165	0166
	120W	22W	120W	IR Sensor	IR Remote controller	Sinc Cable
	IN:230V - OUT: 3x24V		IN:230V - OUT: 3x24V			

Solo collegamento in parallelo - Only parallel connection

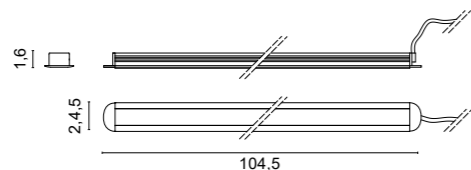

1,6x 103,5 cm.

6661 Into

.01 Bianco - White

Color temperature	LED Light source	lm source
/W 4000K	24V 9,6W	1080lm
/WW 3000K	24V 9,6W	1020lm
/XW 2700K	24V 9,6W	960lm



Versione ETL disponibile su richiesta
ETL version available upon request

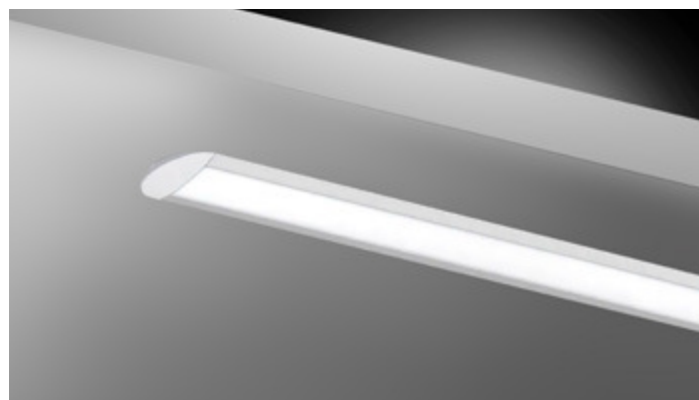

Pixeling free

Il nuovo circuito 9,6W/mt - 120 LED/mt, CRI>90 annulla l'effetto puntiforme garantendo una luce continua e uniforme.

New LED strip 9,6W/mt - 120 LED/mt, CRI>90 cancels the pixeling effect guaranteeing a continuous and uniform light.

Accessori - Accessories



0244/CLIP/INT

Clip di fissaggio
Fixing clip



0244/SPR/INT

Molla di fissaggio per cartongesso
Fixing spring for plasterboard

Optional

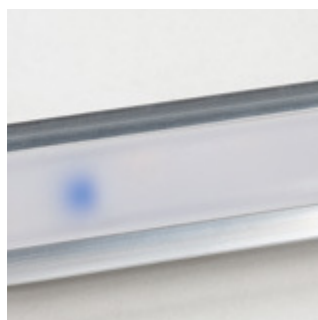

0131/S

Interruttore dimmer touch su richiesta. La lunghezza della lampada rimane invariata, l'interruttore riduce di 10 cm la linea di luce

Touch dimmer switch on request. The lamp length don't change, touch switch reduces 10 cm the light line.

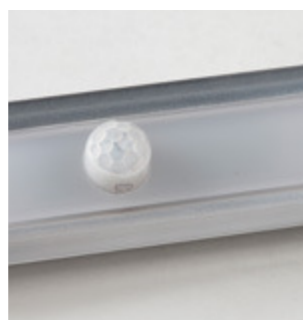

0131/RV

Sensore di presenza su richiesta. La lunghezza della lampada rimane invariata, il sensore riduce di 10 cm la linea di luce

Body detector on request. The lamp length don't change, body detector reduces 10 cm the light line



CUSTOM SIZE

Tabella lunghezze disponibili. Le misure si riferiscono alle lunghezze totali delle lampade complete di tappi.
Table of available lengths. Measures are referred to complete fixtures including closing heads.

cm	watt	cm	2700K (XW)	lm source	3000K (WW)	lm source	4000K (W)	lm source
14,5	1W	13,5x1,8	A6661.01/10/XW	96	A6661.01/10/WW	102	A6661.01/10/W	108
24,5	1,9W	23,5x1,8	A6661.01/20/XW	192	A6661.01/20/WW	204	A6661.01/20/W	216
34,5	2,9W	33,5x1,8	A6661.01/30/XW	288	A6661.01/30/WW	306	A6661.01/30/W	324
44,5	3,8W	43,5x1,8	A6661.01/40/XW	384	A6661.01/40/WW	408	A6661.01/40/W	432
54,5	4,8W	53,5x1,8	A6661.01/50/XW	480	A6661.01/50/WW	510	A6661.01/50/W	540
64,5	5,8W	63,5x1,8	A6661.01/60/XW	576	A6661.01/60/WW	612	A6661.01/60/W	648
74,5	6,7W	73,5x1,8	A6661.01/70/XW	672	A6661.01/70/WW	714	A6661.01/70/W	756
84,5	7,7W	83,5x1,8	A6661.01/80/XW	768	A6661.01/80/WW	816	A6661.01/80/W	864
94,5	8,6W	93,5x1,8	A6661.01/90/XW	864	A6661.01/90/WW	918	A6661.01/90/W	972
104,5 **	9,6W	103,5x1,8	6661.01/XW	960	6661.01/ WW	1020	6661.01/W	1080
114,5	10,6W	113,5x1,8	A6661.01/110/XW	1056	A6661.01/110/WW	1122	A6661.01/110/W	1188
124,5	11,5W	123,5x1,8	A6661.01/120/XW	1152	A6661.01/120/WW	1224	A6661.01/120/W	1296
134,5	12,5W	133,5x1,8	A6661.01/130/XW	1248	A6661.01/130/WW	1326	A6661.01/130/W	1404
144,5	13,4W	143,5x1,8	A6661.01/140/XW	1344	A6661.01/140/WW	1428	A6661.01/140/W	1512
154,5	14,4W	153,5x1,8	A6661.01/150/XW	1440	A6661.01/150/WW	1530	A6661.01/150/W	1620
164,5	15,4W	163,5x1,8	A6661.01/160/XW	1536	A6661.01/160/WW	1632	A6661.01/160/W	1728
174,5	16,3W	173,5x1,8	A6661.01/170/XW	1632	A6661.01/170/WW	1734	A6661.01/170/W	1836
184,5	17,3W	183,5x1,8	A6661.01/180/XW	1728	A6661.01/180/WW	1836	A6661.01/180/W	1944
194,5	18,2W	193,5x1,8	A6661.01/190/XW	1824	A6661.01/190/WW	1938	A6661.01/190/W	2052
204,5	19,2W	203,5x1,8	A6661.01/200/XW	1920	A6661.01/200/WW	2040	A6661.01/200/W	2160
214,5	20,2W	213,5x1,8	A6661.01/210/XW	2016	A6661.01/210/WW	2142	A6661.01/210/W	2268
224,5	21,1W	223,5x1,8	A6661.01/220/XW	2112	A6661.01/220/WW	2244	A6661.01/220/W	2376
234,5	22,1W	233,5x1,8	A6661.01/230/XW	2208	A6661.01/230/WW	2346	A6661.01/230/W	2484
244,5	23W	243,5x1,8	A6661.01/240/XW	2304	A6661.01/240/WW	2448	A6661.01/240/W	2592
254,5	24W	253,5x1,8	A6661.01/250/XW	2400	A6661.01/250/WW	2550	A6661.01/250/W	2700
264,5	25W	263,5x1,8	A6661.01/260/XW	2496	A6661.01/260/WW	2652	A6661.01/260/W	2808
274,5	25,9W	273,5x1,8	A6661.01/270/XW	2592	A6661.01/270/WW	2754	A6661.01/270/W	2916
284,5	26,9W	283,5x1,8	A6661.01/280/XW	2688	A6661.01/280/WW	2856	A6661.01/280/W	3024
294,5	27,8W	293,5x1,8	A6661.01/290/XW	2784	A6661.01/290/WW	2958	A6661.01/290/W	3132
304,5	28,8W	303,5x1,8	A6661.01/300/XW	2880	A6661.01/300/WW	3060	A6661.01/300/W	3240

** Articolo standard a catalogo - Standard catalogue item

Su richiesta sono disponibili soluzioni angolari a 90°
90° angled options are available upon request



Drivers

Drivers ON/OFF

Cod.	0155	0156	0160	0157	0161/100	0162
	24V-13W	24V-25W	24V-50W	24V-75W	24V-100W	24V-150W

DIMMABLE drivers

Cod.	0110/DIM	0717/DIM60/V	0717/DIM60	0717/DIM100
	12/24V	24V-60W 1...10V	24V-60W PUSH - DALI	24V-100W 1...10V - PUSH - DALI

LED emergency unit

Cod.	0115/EM
	Inverter + Battery + LED indicator

Solo collegamento in parallelo - Only parallel connection

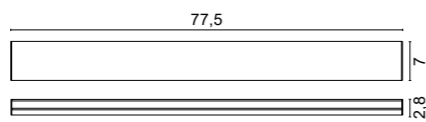

4589 Vela

.01 Bianco - White

Color temperature	LED Light source	lm source
/W 4000K	12V 28,8W	3720 lm
/WW 3000K	12V 28,8W	3465 lm
/XW 2700K	12V 28,8W	3285 lm



1,00Kg

CUSTOM SIZE

Tabella lunghezze disponibili. Le misure si riferiscono alle lunghezze totali delle lampade complete di tappi.
Table of available lengths. Measures are referred to complete fixtures including closing heads.

cm	watt	2700K (XW)	lm source	3000K (WW)	lm source	4000K (W)	lm source
77,5	28,8W	4589.01/75/XW	3285	4589.01/75/WW	3465	4589.01/75/W	3720
102,5	38,4W	A4589.01/100/XW	4380	A4589.01/100/WW	4620	A4589.01/100/W	4960
127,5	48W	A4589.01/125/XW	5474	A4589.01/125/WW	5775	A4589.01/125/W	6200
152,5	57,6W	A4589.01/150/XW	6570	A4589.01/150/WW	6930	A4589.01/150/W	7440
177,5	67,2W	A4589.01/175/XW	7664	A4589.01/175/WW	8084	A4589.01/175/W	8690
202,5	76,8W	A4589.01/200/XW	8760	A4589.01/200/WW	9240	A4589.01/200/W	9920

★ Articolo standard a catalogo - Standard catalogue item



Pixeling free

Il nuovo circuito 19,2W/mt - 240 LED/mt, CRI>94 annulla l'effetto puntiforme garantendo una luce continua e uniforme.

New LED strip 19,2W/mt - 240 LED/mt, CRI>94 cancels the pixeling effect guaranteeing a continuous and uniform light.

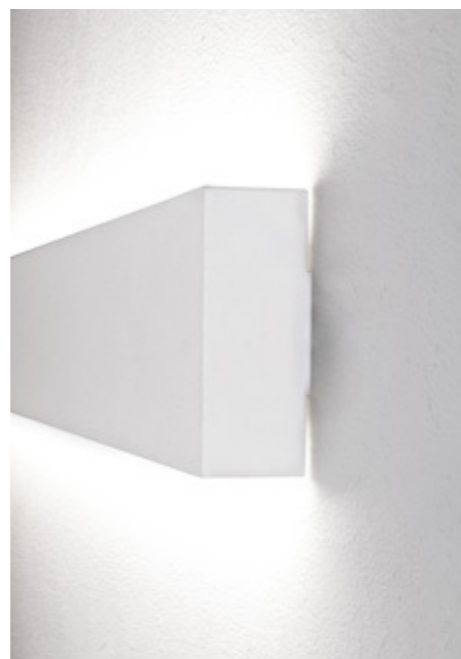

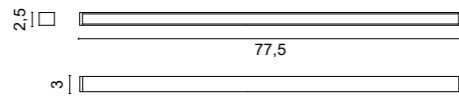

5613 Riga

- .01 Bianco - White
- .02 Nero - Black

Color temperature	LED Light source	lm source
/W 4000K	24V 14,4W	1860lm
/WW 3000K	24V 14,4W	1732lm
/XW 2700K	24V 14,4W	1642lm



Pixeling free

Il nuovo circuito 19,2W/mt - 240 LED/mt, CRI>94 annulla l'effetto puntiforme garantendo una luce continua e uniforme.

New LED strip 19,2W/mt - 240 LED/mt, CRI>94 cancels the pixeling effect guaranteeing a continuous and uniform light.

CUSTOM SIZE

Tabella lunghezze disponibili. Le misure si riferiscono alle lunghezze totali delle lampade complete di tappi.
Table of available lengths. Measures are referred to complete fixtures including closing heads.

cm.	watt	2700K (XW)	lm source	3000K (WW)	lm source	4000K (W)	lm source
77,5	14,4W	5613 * /75/XW	1642	5613 * /75/WW	1732	5613 * /75/W	1860
102,5	19,2W	A5613 * /100/XW	2190	A5613 * /100/WW	2310	A5613 * /100/W	2480
127,5	24W	A5613 * /125/XW	2737	A5613 * /125/WW	2890	A5613 * /125/W	3100
152,5	28,8W	A5613 * /150/XW	3285	A5613 * /150/WW	3465	A5613 * /150/W	3720
177,5	33,6W	A5613 * /175/XW	3832	A5613 * /175/WW	4042	A5613 * /175/W	4340
202,5	38,4W	A5613 * /200/XW	4380	A5613 * /200/WW	4620	A5613 * /200/W	4960
227,5	43,2W	A5613 * /225/XW	4927	A5613 * /225/WW	5197	A5613 * /225/W	5580
252,5	48W	A5613 * /250/XW	5474	A5613 * /250/WW	5775	A5613 * /250/W	6200
277,5	52,8W	A5613 * /275/XW	6022	A5613 * /275/WW	6352	A5613 * /275/W	6820
302,5	57,6W	A5613 * /300/XW	6570	A5613 * /300/WW	6930	A5613 * /200/W	7440

- * Finiture - Finishes:
.01 Bianco - White
.02 Nero - Black

* Articolo standard a catalogo - Standard catalogue item

Drivers

Drivers ON/OFF

Cod.	0155	0156	0160	0157	0161/100	0162
	24V-13W	24V-25W	24V-50W	24V-75W	24V-100W	24V-150W

DIMMABLE drivers

Cod.	0110/DIM	0717/DIM60/V	0717/DIM60	0717/DIM100
	12/24V	24V-60W 1...10V	24V-60W PUSH - DALI	24V-100W 1...10V - PUSH - DALI

LED emergency unit

Cod.	0115/EM
	Inverter + Battery + LED indicator



1684 Riga

- .01 Bianco - White
- .02 Nero - Black

Color temperature	LED Light source	lm source
/W 4000K	24V 14,4W	1860lm
/WW 3000K	24V 14,4W	1732lm
/XW 2700K	24V 14,4W	1642lm



Tenditori e rosoni con alimentatori (p. 264) da ordinare separatamente
Tensor and ceiling roses with power supplies (p. 264) are to be ordered separately.

Pixeling free

Il nuovo circuito 19,2W/mt - 240 LED/mt, CRI>94 annulla l'effetto puntiforme garantendo una luce continua e uniforme.

New LED strip 19,2W/mt - 240 LED/mt, CRI>94 cancels the pixeling effect guaranteeing a continuous and uniform light.

CUSTOM SIZE

Tabella lunghezze disponibili. Le misure si riferiscono alle lunghezze totali delle lampade complete di tappi.
Table of available lengths. Measures are referred to complete fixtures including closing heads.

cm.	watt	2700K (XW)	lm source	3000K (WW)	lm source	4000K (W)	lm source
77,5	14,4W	1684 * /75/XW	1642	1684 * /75/WW	1732	1684 * /75/W	1860
102,5	19,2W	A1684 * /100/XW	2190	A1684 * /100/WW	2310	A1684 * /100/W	2480
127,5	24W	A1684 * /125/XW	2737	A1684 * /125/WW	2890	A1684 * /125/W	3100
152,5	28,8W	A1684 * /150/XW	3285	A1684 * /150/WW	3465	A1684 * /150/W	3720
177,5	33,6W	A1684 * /175/XW	3832	A1684 * /175/WW	4042	A1684 * /175/W	4340
202,5	38,4W	A1684 * /200/XW	4380	A1684 * /200/WW	4620	A1684 * /200/W	4960
227,5	43,2W	A1684 * /225/XW	4927	A1684 * /225/WW	5197	A1684 * /225/W	5580
252,5	48W	A1684 * /250/XW	5474	A1684 * /250/WW	5775	A1684 * /250/W	6200
277,5	52,8W	A1684 * /275/XW	6022	A1684 * /275/WW	6352	A1684 * /275/W	6820
302,5	57,6W	A1684 * /300/XW	6570	A1684 * /300/WW	6930	A1684 * /300/W	7440

- * Finiture - Finishes:
.01 Bianco - White
.02 Nero - Black

* Articolo standard a catalogo - Standard catalogue item



Accessori e rosoni per sistemi a sospensione 230V
 Accessories and ceiling roses for LED suspension systems with 230V

Riferimento progetti - Projects reference:
BALOON - UNIDEA - MIR - PRÊT-À-PORTER - EGOTUBE

Lighting system

0607
 IN: 50/60Hz 220-240V
 Ø 9,3 cm
 H 3 cm

Rosone in policarbonato per sospensione senza cavo - 1 lampada
Polycarbonate ceiling rose for suspension without cable - 1 lamp

Colore
 .01 Bianco - White
 .02 Nero - Black
 .35 Verniciato sabbia - Painted sand finishing

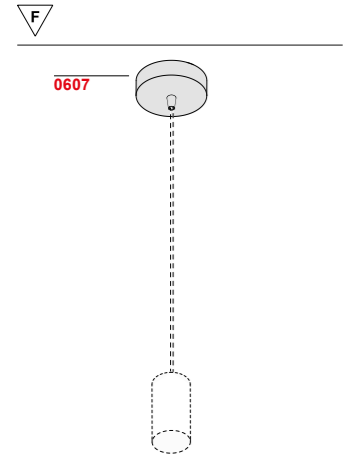

0976/1
 IN: 50/60Hz 220-240V
 Ø 10 cm
 H 3 cm

Rosone in metallo per sospensione senza cavo - 1 lampada
Metal ceiling rose for suspension without cable - 1 lamp

Colore
 .01 Bianco - White
 .02 Nero - Black
 .71 Fumè

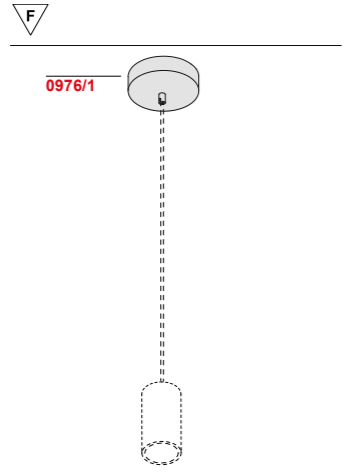

0976/2
 IN: 50/60Hz 220-240V
 Ø 10 cm
 H 3 cm

Rosone in metallo per sospensione senza cavo - 2 lampade
Metal ceiling rose for suspension without cable - 2 lamps

Colore
 .01 Bianco - White
 .02 Nero - Black
 .71 Fumè

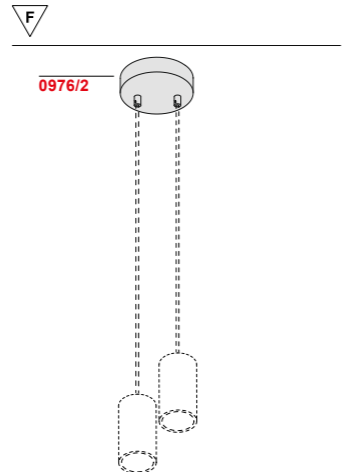

0976/3
 IN: 50/60Hz 220-240V
 Ø 10 cm
 H 3 cm

Rosone in metallo per sospensione senza cavo - 3 lampade
Metal ceiling rose for suspension without cable - 3 lamps

Colore
 .01 Bianco - White
 .02 Nero - Black
 .71 Fumè

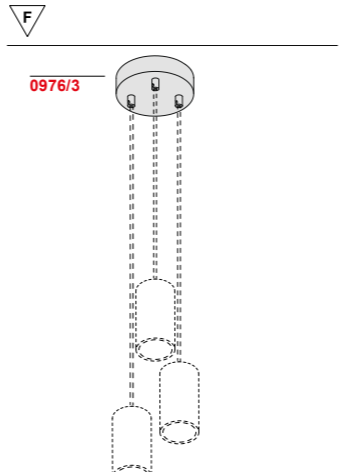

0947
 IN: 50/60Hz 220-240V
 Ø 9 cm

Rosone per cartongesso - 1 lampada
Plasterboard ceiling rose - 1 lamp

Colore
 .01 Bianco - White
 .02 Nero - Black
 .35 Verniciato sabbia - Painted sand finishing

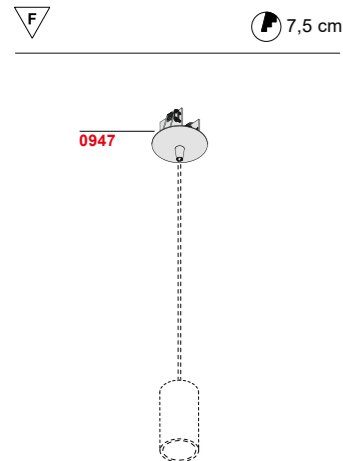

0604
 IN: 50/60Hz 220-240V
 Ø 9,3 cm
 H 3 cm

Rosone senza interruttore senza cavo - 1 lampada
Canopy without cable (no switch) - 1 lamp

Colore
 .01 Bianco - White
 .02 Nero - Black

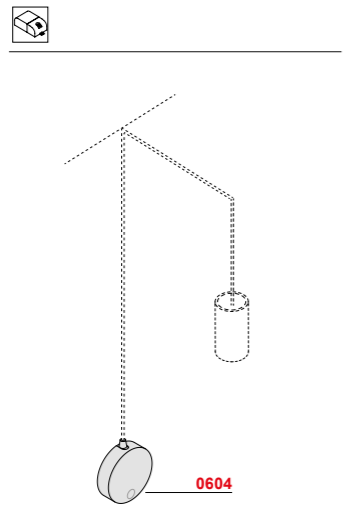

0605
 Ø 1,7 cm
 H 2,2 cm

1 Deviatore e decentratore
1 Displacement element

Colore
 .01 Bianco - White
 .02 Nero - Black

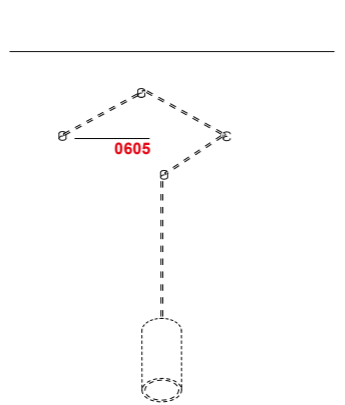

0975/1
 Ø 2 cm
 H 2,3 cm

1 Decentratore per soffitto in ottone satinato
1 Satin brass displacement element for ceiling fixing

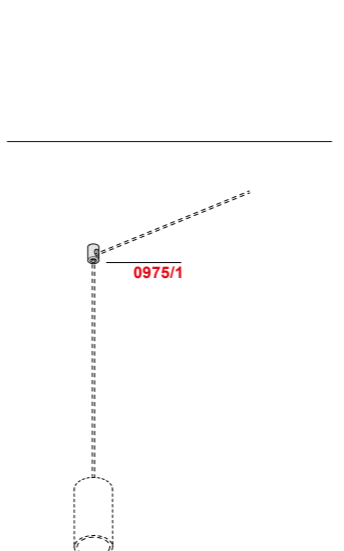

0613/3
 IN: 50/60Hz 220-240V
 L 90 cm
 H 6,8 cm

Rosone per sospensione senza cavo - 3 lampade
Ceiling rose for suspension without cable - 3 lamps

Colore
 .01 Bianco - White
 .02 Nero - Black
 .35 Verniciato sabbia - Painted sand finishing

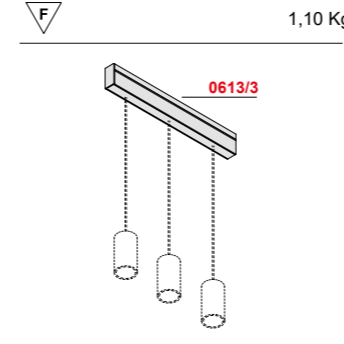

0613/4
 IN: 50/60Hz 220-240V
 L 120 cm
 H 6,8 cm

Rosone per sospensione senza cavo - 3 lampade
Ceiling rose for suspension without cable - 3 lamps

Colore
 .01 Bianco - White
 .02 Nero - Black
 .35 Verniciato sabbia - Painted sand finishing

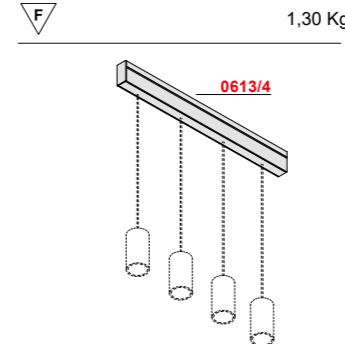

0613/6
 IN: 50/60Hz 220-240V
 L 180 cm
 H 6,8 cm

Rosone per sospensione senza cavo - 3 lampade
Ceiling rose for suspension without cable - 3 lamps

Colore
 .01 Bianco - White
 .02 Nero - Black
 .35 Verniciato sabbia - Painted sand finishing

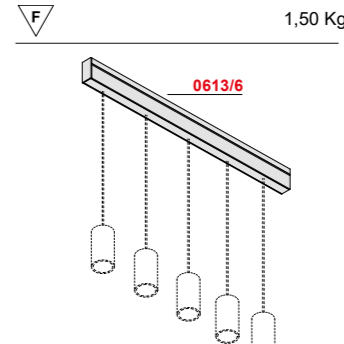

0603
 IN: 50/60Hz 220-240V
 Ø 20 cm
 H 3 cm

Rosone per sospensione senza cavo - 1-4 lampade
Ceiling rose for suspension without cable - 1-4 lamps

Colore
 .01 Bianco - White
 .02 Nero - Black

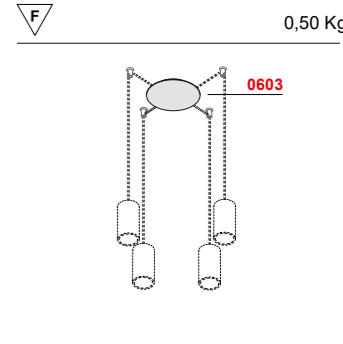

Lighting system

0602
 IN: 50/60Hz 220-240V
 Ø 38 cm
 H 4 cm

Rosone per sospensione senza cavo - 1-12 lampade
Ceiling rose for suspension without cable - 1-12 lamps

Colore
 .01 Bianco - White
 .02 Nero - Black

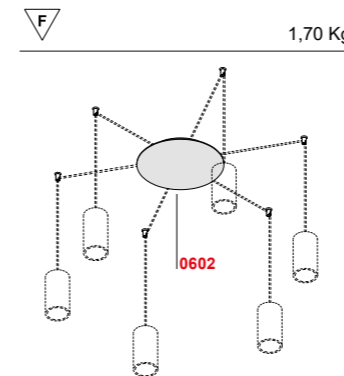

0978/2
 IN: 50/60Hz 220-240V
 48x24 cm
 H 3 cm

Rosone per sospensione senza cavo - 2 lampade
Ceiling rose for suspension without cable - 2 lamps

Colore
 .01 Bianco - White
 .02 Nero - Black

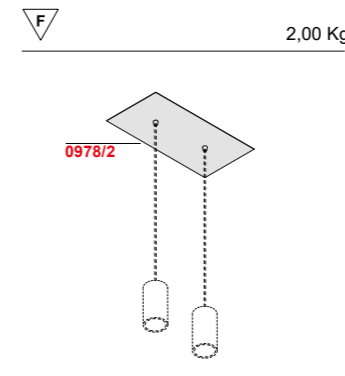

0978/4
 IN: 50/60Hz 220-240V
 48x48 cm
 H 3 cm

Rosone per sospensione senza cavo - 4 lampade
Ceiling rose for suspension without cable - 4 lamps

Colore
 .01 Bianco - White
 .02 Nero - Black

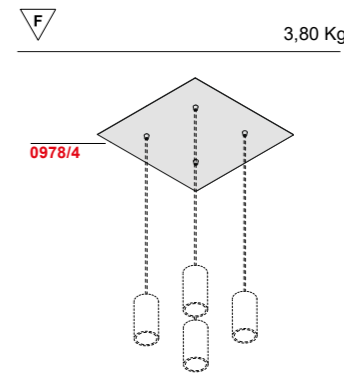

0600
 IN: 50/60Hz 220-240V
 Ø 35 cm
 H 3 cm

Rosone per sospensione senza cavo - 3 lampade
Ceiling rose for suspension without cable - 3 lamps

Colore
 .01 Bianco - White
 .02 Nero - Black

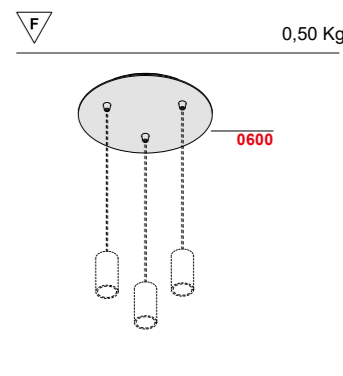

0601
 IN: 50/60Hz 220-240V
 Ø 45 cm
 H 3 cm

Rosone per sospensione senza cavo - 5 lampade
Ceiling rose for suspension without cable - 5 lamps

Colore
 .01 Bianco - White
 .02 Nero - Black

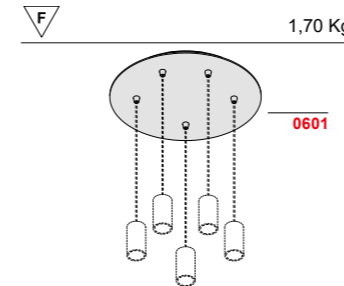

Accessori e rosoni per sistemi a sospensione con LED 350mA
 Accessories and ceiling roses for LED suspension systems with 350mA

Riferimento progetti - Projects reference:
PEVERA system - NEWTON system - STICK system

Lighting system

0968
 IN: 50/60Hz 200-240V
 OUT: 350mA DC

Spina a parete con driver integrato + Jack - 1 lampada
 Plug in driver + Jack - 1 lamp

Colore
 .01 Bianco - White
 .02 Nero - Black

0967
 IN: 50/60Hz 220-240V
 OUT: 350mA DC
 Ø 9,3 cm
 H 3 cm

Rosone per sospensione con driver integrato senza cavo - 1 lampada
 Ceiling rose for suspension with switch without cable - 1 lamp

Colore
 .01 Bianco - White
 .02 Nero - Black

0969
 IN: 50/60Hz 220-240V
 OUT: 350mA DC
 Ø 9,3 cm
 H 3 cm

Rosone senza interruttore con driver integrato - 1 lampada
 Canopy with driver (no switch) - 1 lamp

Colore
 .01 Bianco - White
 .02 Nero - Black

0969/S
 IN: 50/60Hz 220-240V
 OUT: 350mA DC
 Ø 9,3 cm
 H 3 cm

Rosone con interruttore con driver integrato - 1 lampada
 Canopy with driver (with switch) - 1 lamp

Colore
 .01 Bianco - White
 .02 Nero - Black

0987
 IN: 48V
 OUT: 350mA DC

Adattatore per binario 48V senza cavo - 1 lampada
 Adapter for 48V track without cable - 1 lamp

Colore
 .01 Bianco - White
 .02 Nero - Black

0988
 IN: 50/60Hz 220-240V
 OUT: 350mA DC

Adattatore per binario 220-240V senza cavo 1 lampada
 Adapter for 220-240V track without cable 1 lamp

Colore
 .01 Bianco - White
 .02 Nero - Black

0970
 IN: 50/60Hz 220-240V
 OUT: 350mA DC
 Ø 9 cm

Rosone per cartongesso con alimentatore - 1 lampada
 Plasterboard ceiling rose with converter - 1 lamp

Colore
 .01 Bianco - White
 .02 Nero - Black

0612
 Ø 2 cm
 H 2,3 cm

Elemento per decentramento
 Displacement component

Colore
 .01 Bianco - White
 .02 Nero - Black

0987
 IN: 48V
 OUT: 350mA DC

Adattatore per binario 48V senza cavo - 1 lampada
 Adapter for 48V track without cable - 1 lamp

Colore
 .01 Bianco - White
 .02 Nero - Black

0988
 IN: 50/60Hz 220-240V
 OUT: 350mA DC

Adattatore per binario 220-240V senza cavo 1 lampada
 Adapter for 220-240V track without cable 1 lamp

Colore
 .01 Bianco - White
 .02 Nero - Black

0970
 IN: 50/60Hz 220-240V
 OUT: 350mA DC
 Ø 9 cm

Rosone per cartongesso con alimentatore - 1 lampada
 Plasterboard ceiling rose with converter - 1 lamp

Colore
 .01 Bianco - White
 .02 Nero - Black

0612
 Ø 2 cm
 H 2,3 cm

Elemento per decentramento
 Displacement component

Colore
 .01 Bianco - White
 .02 Nero - Black

0987

0988

0970

0612

0556/3
 IN: 50/60Hz 220-240V
 OUT: 350mA DC
 L 90 cm
 H 6,8 cm

Rosone con driver integrato - 3 lampade
 Dimmerabile a richiesta
 Canopy with driver - 3 lamps
 Dimmable upon request

Colore
 .01 Bianco - White
 .02 Nero - Black
 .05 Rosso - Red

1,20 Kg

0556/4
 IN: 50/60Hz 220-240V
 OUT: 350mA DC
 L 120 cm
 H 6,8 cm

Rosone con driver integrato - 4 lampade
 Dimmerabile a richiesta
 Canopy with driver - 4 lamps
 Dimmable upon request

Colore
 .01 Bianco - White
 .02 Nero - Black
 .05 Rosso - Red

1,40 Kg

0556/6
 IN: 50/60Hz 220-240V
 OUT: 350mA DC
 L 180 cm
 H 6,8 cm

Rosone con driver integrato - 6 lampade
 Dimmerabile a richiesta
 Canopy with driver - 6 lamps
 Dimmable upon request

Colore
 .01 Bianco - White
 .02 Nero - Black
 .05 Rosso - Red

1,60 Kg

0557/2
 IN: 50/60Hz 220-240V
 OUT: 350mA DC
 Ø 20 cm
 H 3 cm

Rosone con driver integrato - 2 lampade
 Dimmerabile a richiesta
 Canopy with driver - 2 lamps
 Dimmable upon request

Colore
 .01 Bianco - White
 .02 Nero - Black

0,50 Kg

0556/3

0556/4

0556/6

0557/2

0557/3
 IN: 50/60Hz 220-240V
 OUT: 350mA DC
 Ø 38 cm
 H 4 cm

Rosone con driver integrato - 3 lampade
 Dimmerabile a richiesta
 Canopy with driver - 3 lamps
 Dimmable upon request

Colore
 .01 Bianco - White
 .02 Nero - Black

0,50 Kg

0557/6
 IN: 50/60Hz 220-240V
 OUT: 350mA DC
 Ø 38 cm
 H 4 cm

Rosone con driver integrato - 4-6 lampade
 Dimmerabile a richiesta
 Canopy with driver - 4-6 lamps
 Dimmable upon request

Colore
 .01 Bianco - White
 .02 Nero - Black

1,80 Kg

0979/2
 IN: 50/60Hz 220-240V
 OUT: 350mA DC
 48x24 cm
 H 3 cm

Rosone con driver integrato - 2 lampade
 Dimmerabile a richiesta
 Canopy with driver - 2 lamps
 Dimmable upon request

Colore
 .01 Bianco - White
 .02 Nero - Black

2,00 Kg

0979/4
 IN: 50/60Hz 220-240V
 OUT: 350mA DC
 48x48 cm
 H 3 cm

Rosone con driver integrato - 4 lampade
 Dimmerabile a richiesta
 Canopy with driver - 4 lamps
 Dimmable upon request

Colore
 .01 Bianco - White
 .02 Nero - Black

3,80 Kg

0557/3

0557/6

0979/2

0979/4

0980/3
 IN: 50/60Hz 220-240V
 OUT: 350mA DC
 Ø 35 cm
 H 3 cm

Rosone con driver integrato - 3 lampade
 Dimmerabile a richiesta
 Canopy with driver - 3 lamps
 Dimmable upon request

Colore
 .01 Bianco - White
 .02 Nero - Black

1,20 Kg

0980/5
 IN: 50/60Hz 220-240V
 OUT: 350mA DC
 Ø 45 cm
 H 3 cm

Rosone con driver integrato - 5 lampade
 Dimmerabile a richiesta
 Canopy with driver - 5 lamps
 Dimmable upon request

Colore
 .01 Bianco - White
 .02 Nero - Black

2,40 Kg

0980/3

0980/5

Lighting system

Rosoni per sistemi a sospensione 24V - Ceiling roses for suspension systems 24V

Riferimento progetti - Projects reference:

**WANDA system - LANCIA system - LANCIA system
MULTI LANCIA system - EXTRA system**

Lighting system

**ROSONE COMPLETO DI DRIVER 60W
CEILING ROSE WITH DRIVER 60W**

Code	W	Codici finiture - Finishes codes
0990/60	60W	.01 Bianco - White
0990/60	60W	.02 Nero - Black
0990/60	60W	.85 Verniciato argento - Painted silver finishing
0990/60	60W	.86 Verniciato oro - Painted gold finishing
0990/60	60W	.87 Verniciato rame - Painted copper finishing
0990/60	60W	.88 Verniciato bronzo - Painted bronze finishing

**DIMMERAZIONE
DIMMING**

PUSH	1...10V
/P	/N
/P	/N
/P	/N
/P	/N
/P	/N
/P	/N

50/60Hz 220-230V - 60W

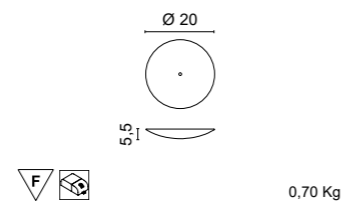

**ROSONE COMPLETO DI DRIVER 100W
CEILING ROSE WITH DRIVER 100W**

Code	W	Codici finiture - Finishes codes
0990/100	100W	.01 Bianco - White
0990/100	100W	.02 Nero - Black
0990/100	100W	.85 Verniciato argento - Painted silver finishing
0990/100	100W	.86 Verniciato oro - Painted gold finishing
0990/100	100W	.87 Verniciato rame - Painted copper finishing
0990/100	100W	.88 Verniciato bronzo - Painted bronze finishing

**DIMMERAZIONE
DIMMING**

PUSH	1...10V	3-5-10
/P	/N	/ID
/P	/N	/ID
/P	/N	/ID
/P	/N	/ID
/P	/N	/ID
/P	/N	/ID

50/60Hz 220-230V - 100W

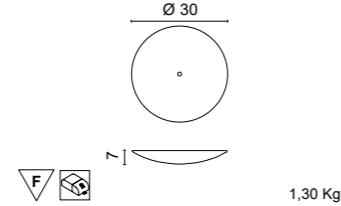

**ROSONE COMPLETO DI DRIVER 150W
CEILING ROSE WITH DRIVER 150W**

Code	W	Codici finiture - Finishes codes
0990/150	150W	.01 Bianco - White
0990/150	150W	.02 Nero - Black
0990/150	150W	.85 Verniciato argento - Painted silver finishing
0990/150	150W	.86 Verniciato oro - Painted gold finishing
0990/150	150W	.87 Verniciato rame - Painted copper finishing
0990/150	150W	.88 Verniciato bronzo - Painted bronze finishing

**DIMMERAZIONE
DIMMING**

PUSH	1...10V	3-5-10
/P	/N	/ID
/P	/N	/ID
/P	/N	/ID
/P	/N	/ID
/P	/N	/ID
/P	/N	/ID

50/60Hz 220-230V - 150W

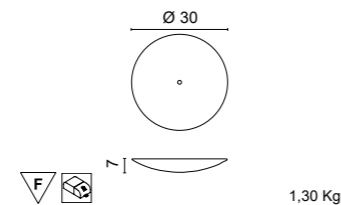

**ROSONE COMPLETO DI DRIVER 200W (2x100W)
CEILING ROSE WITH DRIVER 200W (2x100W)**

Code	W	Codici finiture - Finishes codes
0990/200	200W	.01 Bianco - White
0990/200	200W	.02 Nero - Black
0990/200	200W	.85 Verniciato argento - Painted silver finishing
0990/200	200W	.86 Verniciato oro - Painted gold finishing
0990/200	200W	.87 Verniciato rame - Painted copper finishing
0990/200	200W	.88 Verniciato bronzo - Painted bronze finishing

**DIMMERAZIONE
DIMMING**

PUSH	1...10V	3-5-10
/P	/N	/ID
/P	/N	/ID
/P	/N	/ID
/P	/N	/ID
/P	/N	/ID
/P	/N	/ID

50/60Hz 220-230V - 200W

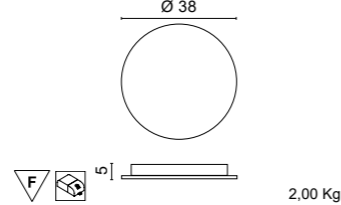

Esempi di installazione multipla, la scelta del rosone è determinata dalla somma delle potenze delle singole lampade.
Examples of multiple installation, the choice of the ceiling rose depends on total power consumption.

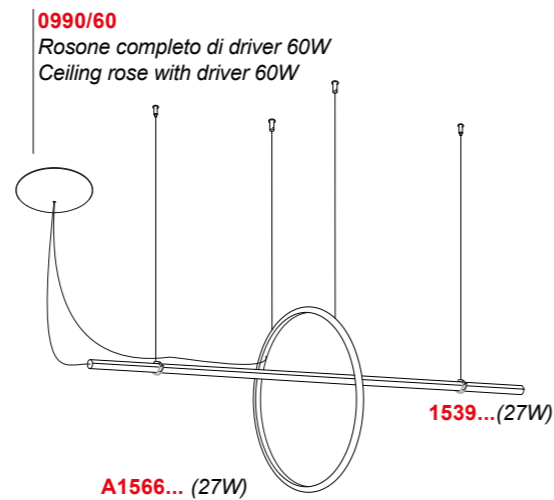
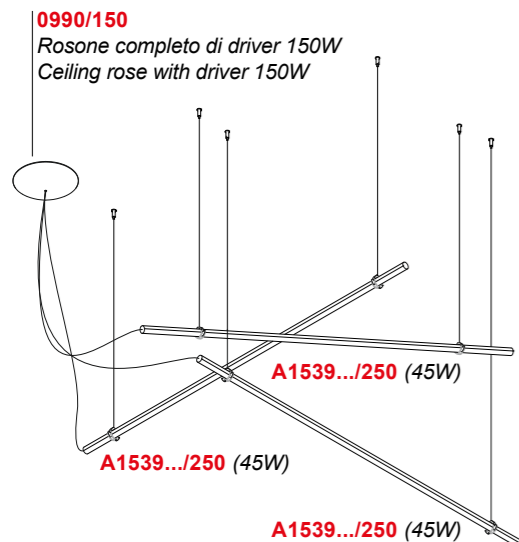

Kit di fissaggio a sospensione fornito con la lampada. - Suspension fixing kit supplied with the lamp.

Lighting system

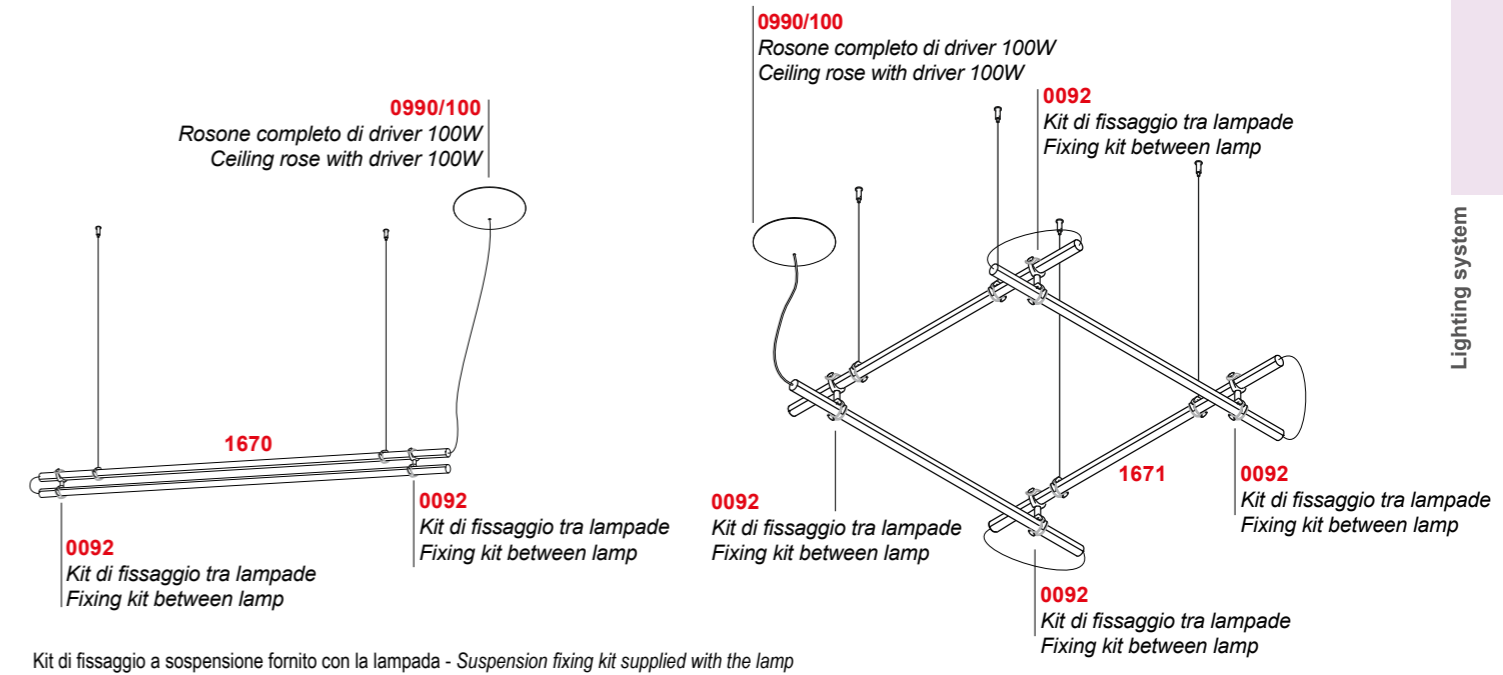



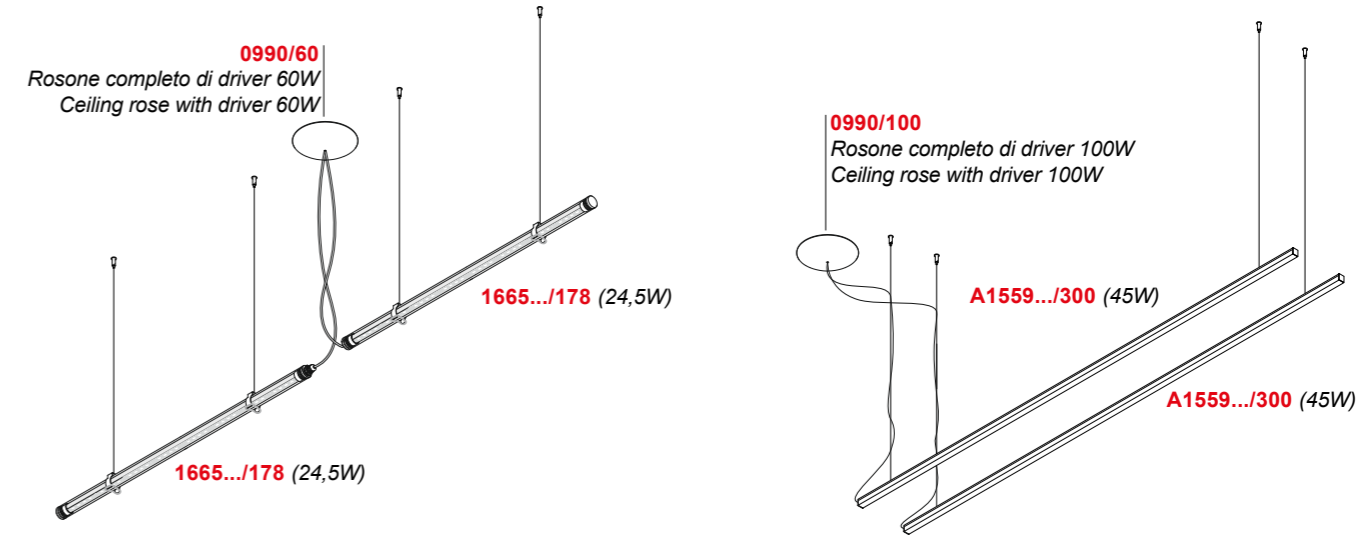



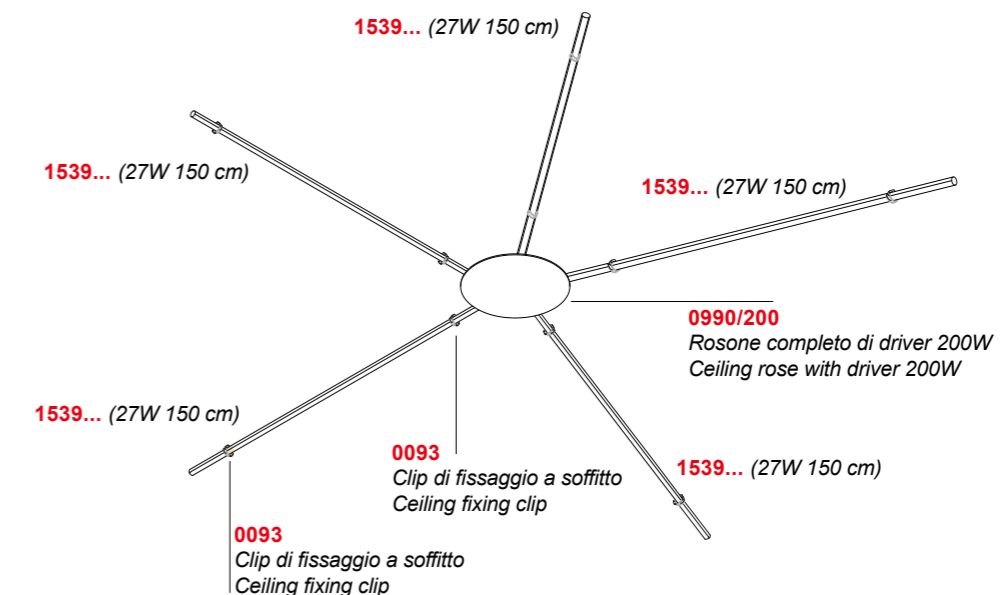















Kit di fissaggio a sospensione fornito con la lampada - Suspension fixing kit supplied with the lamp













Kit di fissaggio a sospensione fornito con la lampada - Suspension fixing kit supplied with the lamp



DECORATIVE LIGHTS

SNORKY	 6373 - p. 268	SNORKY MAXI	 6313 - p. 269
DOT TONDO	 6320 - p. 270	DOT QUADRO	 6321 - p. 270
DOT PLUS TONDO	 6316 - p. 271	DOT PLUS QUADRO	 6317 - p. 271
TRIM TONDO SINGLE EMISSION	 6338 - p. 272	TRIM QUADRO SINGLE EMISSION	 6339 - p. 272
TRIM TONDO BIEMISSION	 6336 - p. 272	TRIM QUADRO BIEMISSION	 6337 - p. 272
FIRE	 6340 - p. 274	FIRE RGB	 6341 - p. 275
SPOON TONDO	 6350 - p. 276	SPOON QUADRO	 6351 - p. 276
LUCCIOLA	 6372 - p. 278	LUCCIOLA RGB	 6353 - p. 279
ICE TONDO	 6354 - p. 280	ICE QUADRO	 6355 - p. 280
VEGA	 6358 - p. 282	SIRIO	 6359 - p. 282
		ALCOR	 6360 - p. 282
VEGA MAXI RGB	 6378 - p. 284	ALCOR MAXI RGB	 6379 - p. 284

DECORATIVE LIGHTS

TOP	 6363 - p. 286	TOP IP	 6740 - p. 286	TOP MINI	 6364 - p. 287
PIX TONDO	 6322 - p. 288	PIX QUADRO	 6323 - p. 288	PIX TONDO RGB	 6375 - p. 290
		PIX QUADRO RGB	 6413 - p. 290		
CERCHIETTO	 6391 - p. 292				
CRUISE	 6382 - p. 292				
SLOT	 6381 - p. 293				



Decorative lights

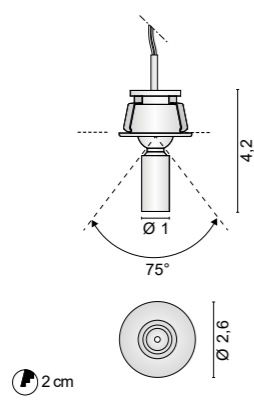

6373 Snorky
.31 Cromato - Chromed

Color temperature	LED Light source	lm source
/W 4000K	1W 350mA	158lm
/WW 3000K	1W 350mA	150lm
/XW 2700K	1W 350mA	143lm

IP 40 0,02 Kg
 Versione ETL disponibile su richiesta
 ETL version available upon request



Accessori - Accessories



0212
KIT: box + Plaster



0215
Controcassa in materiale plastico
Plastic box

Drivers

Cod.	Drivers ON/OFF		DIMMABLE drivers				DIMMABLE drivers
	0125	0128	0141/DIM	0141/DALI	0145	0145/DALI	Casambi
	350mA	350mA	PUSH - 1...10V	DIM DALI	DIM	DIM DALI	0145/CASA
6373	1-6	1-10	1-12	1-12	1-21	1-21	1-21

Solo collegamento in serie - Only serial connection



Decorative lights

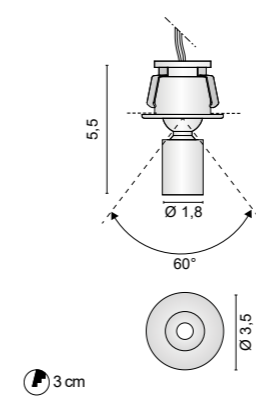

6313 Snorky Maxi
.01 Bianco - White
.02 Nero - Black
.31 Cromato - Chromed

Color temperature	Optics	LED Light source	lm source
/W 4000K	/15 /25 /45	max 1,5W 500mA	221lm
/WW 3000K	/15 /25 /45	max 1,5W 500mA	210lm
/XW 2700K	/15 /25 /45	max 1,5W 500mA	199lm

IP 40 0,06 Kg



Accessori - Accessories



0213
KIT: box + Plaster



0216
Controcassa in materiale plastico
Plastic box

Drivers

Cod.	Drivers ON/OFF			DIMMABLE drivers				DIMMABLE drivers
	0125	0128	0127	0141/DIM	0141/DALI	0145/DALI	0145	Casambi
	350mA	350mA	500mA	PUSH - 1...10V	DIM DALI	DIM DALI	DIM	0145/CASA
6313	1-6	1-10	1-6	1-11	1-11	1-21	1-21	1-21

Solo collegamento in serie - Only serial connection



Decorative lights

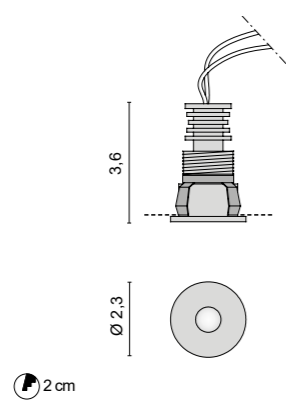

6320 Dot Tondo

.01	Bianco - White	
.32	Nickel satinato - Nickel mat	

Color temperature	LED Light source	lm source
/W 4000K	1W 350mA	158lm
/WW 3000K	1W 350mA	150lm
/XW 2700K	1W 350mA	143lm

0,02 Kg

Versione ETL disponibile su richiesta
 ETL version available upon request

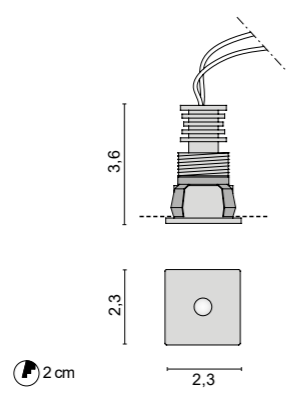

6321 Dot Quadro

.01	Bianco - White	
.32	Nickel satinato - Nickel mat	

Color temperature	LED Light source	lm source
/W 4000K	1W 350mA	158lm
/WW 3000K	1W 350mA	150lm
/XW 2700K	1W 350mA	143lm

0,02 Kg

Versione ETL disponibile su richiesta
 ETL version available upon request

Accessori - Accessories



0208
Adattatore per doghe



0212
KIT: box + Plaster



0215
Controcassa in materiale plastico
Plastic box

Drivers

Cod.	Drivers ON/OFF		DIMMABLE drivers				DIMMABLE drivers Casambi	
	0125	0128	0141/DIM	0141/DALI	0145	0145/DALI	0145/CASA	
	350mA	350mA	PUSH - 1...10V	DIM DALI	DIM	DIM DALI		
6320	1-6	1-10	1-12	1-12	1-21	1-21	1-21	
6321	1-6	1-10	1-12	1-12	1-21	1-21	1-21	

Solo collegamento in serie - Only serial connection



Decorative lights

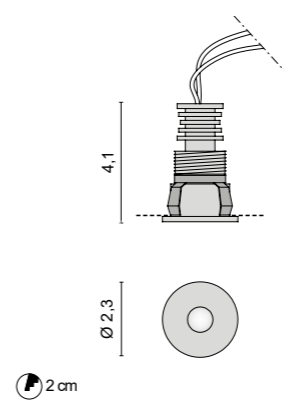

6316 Dot Plus Tondo

.01	Bianco - White	
.32	Nickel satinato - Nickel mat	

Color temperature	Optics	LED Light sources	lm source
/W 4000K	/15 /25 /45	1W 350mA	158lm
/WW 3000K	/15 /25 /45	1W 350mA	150lm
/XW 2700K	/15 /25 /45	1W 350mA	143lm

0,02 Kg

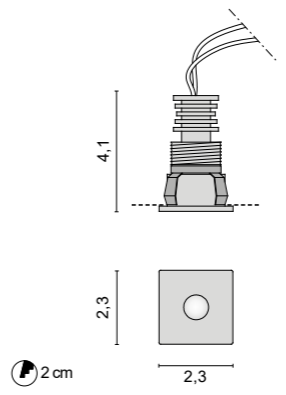

6317 Dot Plus Quadro

.01	Bianco - White	
.32	Nickel satinato - Nickel mat	

Color temperature	Optics	LED Light sources	lm source
/W 4000K	/15 /25 /45	1W 350mA	158lm
/WW 3000K	/15 /25 /45	1W 350mA	150lm
/XW 2700K	/15 /25 /45	1W 350mA	143lm

0,02 Kg



Accessori - Accessories



0212
KIT: box + Plaster



0215
Controcassa in materiale plastico
Plastic box

Drivers

Cod.	Drivers ON/OFF		DIMMABLE drivers				DIMMABLE drivers Casambi	
	0125	0128	0141/DIM	0141/DALI	0145	0145/DALI	0145/CASA	
	350mA	350mA	PUSH - 1...10V	DIM DALI	DIM	DIM DALI		
6316	1-6	1-10	1-12	1-12	1-21	1-21	1-21	
6317	1-6	1-10	1-12	1-12	1-21	1-21	1-21	

Solo collegamento in serie - Only serial connection

Decorative lights

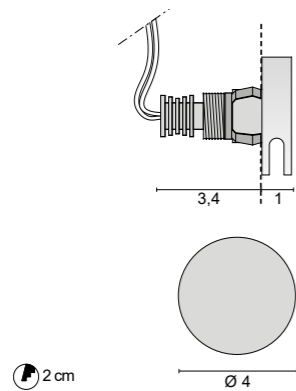

6338 Trim Tondo single emission

- .01 Bianco - White
- .45 Alluminio anodizzato
Anodized aluminium

Color temperature	LED Light source	lm source
/W 4000K	max 1,5W 500mA	221lm
/WW 3000K	max 1,5W 500mA	210lm
/XW 2700K	max 1,5W 500mA	199lm

IP 40 0,03 Kg

Versione ETL disponibile su richiesta
ETL version available upon request

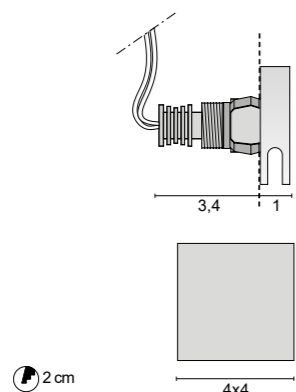

6339 Trim Quadro monoemissione

- .01 Bianco - White
- .45 Alluminio anodizzato
Anodized aluminium

Color temperature	LED Light source	lm source
/W 4000K	max 1,5W 500mA	221lm
/WW 3000K	max 1,5W 500mA	210lm
/XW 2700K	max 1,5W 500mA	199lm

IP 40 0,03 Kg

Versione ETL disponibile su richiesta
ETL version available upon request

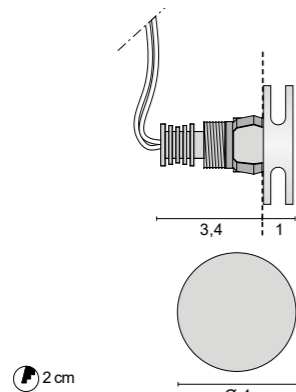
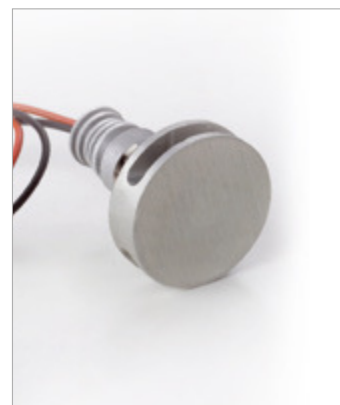

6336 Trim Tondo biemission

- .01 Bianco - White
- .45 Alluminio anodizzato
Anodized aluminium

Color temperature	LED Light source	lm source
/W 4000K	max 1,5W 500mA	221lm
/WW 3000K	max 1,5W 500mA	210lm
/XW 2700K	max 1,5W 500mA	199lm

IP 40 0,03 Kg

Versione ETL disponibile su richiesta
ETL version available upon request

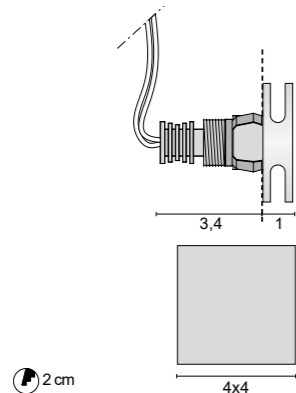

6337 Trim Quadro biemission

- .01 Bianco - White
- .45 Alluminio anodizzato
Anodized aluminium

Color temperature	LED Light source	lm source
/W 4000K	max 1,5W 500mA	221lm
/WW 3000K	max 1,5W 500mA	210lm
/XW 2700K	max 1,5W 500mA	199lm

IP 40 0,03 Kg

Versione ETL disponibile su richiesta
ETL version available upon request



Decorative lights

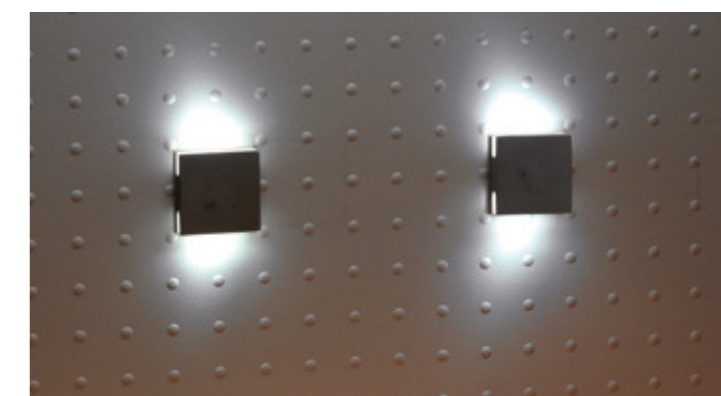

Accessori - Accessories



0212
KIT: box + Plaster



0215
Controcassa in materiale plastico
Plastic box

Drivers

Cod.	Drivers ON/OFF		
	0125	0128	0127
	350mA	350mA	500mA
6336	1-6	1-10	1-6
6337	1-6	1-10	1-6
6338	1-6	1-10	1-6
6339	1-6	1-10	1-6

DIMMABLE drivers			
0141/DIM	0141/DALI	0145/DALI	0145
PUSH - 1...10V	DIM DALI	DIM DALI	DIM
1-11	1-11	1-21	1-21
1-11	1-11	1-21	1-21
1-11	1-11	1-21	1-21
1-11	1-11	1-21	1-21

DIMMABLE drivers	
Casambi	0145/CASA
1-21	1-21
1-21	1-21
1-21	1-21
1-21	1-21

Solo collegamento in serie - Only serial connection

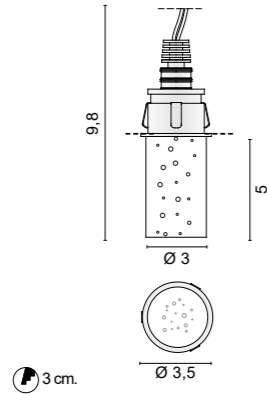

6340 Fire

.00 Trasparente - Transparent

Color temperature	LED Light source	lm source
/W 4000K	1W 350mA	158lm
/WW 3000K	1W 350mA	150lm
/XW 2700K	1W 350mA	143lm

IP 44 0,08 Kg

Versione ETL disponibile su richiesta
ETL version available upon request

Diffusore in metacrilato trasparente con inclusione di bolle
Transparent methacrylate diffuser with bubbles enclosure

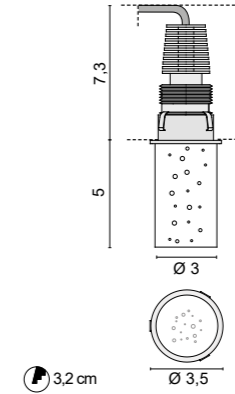

6341 Fire RGB

.00 Trasparente - Transparent

LED Light sources
3x250mA

IP 40 0,12 Kg

Diffusore in metacrilato trasparente con inclusione di bolle
Transparent methacrylate diffuser with bubbles enclosure



Accessori - Accessories



0213
KIT: box + Plaster



0216
Controcassa in materiale plastico
Plastic box

Drivers

Cod.	Drivers ON/OFF		DIMMABLE drivers				DIMMABLE drivers
	0125	0128	0141/DIM	0141/DALI	0145/DALI	0145	Casambi
	350mA	350mA	PUSH - 1...10V	DIM DALI	DIM DALI	DIM	0145/CASA
6313	1-6	1-10	1-11	1-11	1-21	1-21	1-21

Solo collegamento in serie - Only serial connection

Accessori - Accessories



0234
Controcassa in materiale plastico
Plastic box

Drivers

Drivers RGB		Driver RGB Casambi	Converter RGB	0163	0165	0166
0164	0167	0164/CASA	0168	IR Sensor	IR Remote controller	Sinc Cable
120W	22W	120W	IN:24V - OUT: 3x250 mA 1-5 Fire RGB			
IN:230V - OUT: 3x24V		IN:230V - OUT: 3x24V				

Solo collegamento in serie - Only serial connection

Decorative lights

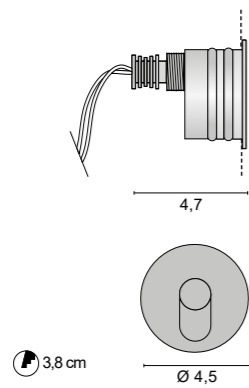
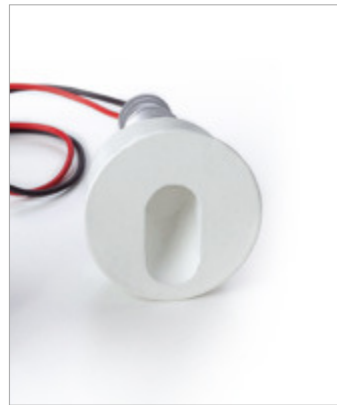

6350 Spoon Tondo

- .01** Bianco - White
- .02** Nero - Black
- .45** Alluminio anodizzato - Anodized aluminium

Color temperature	LED Light source	lm source
/W 4000K	max 1,5W 500mA	221lm
/WW 3000K	max 1,5W 500mA	210lm
/XW 2700K	max 1,5W 500mA	199lm

0,07 Kg

Versione ETL disponibile su richiesta - ETL version available upon request

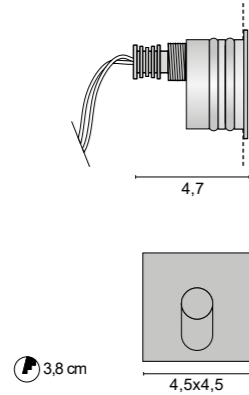

6351 Spoon Quadro

- .01** Bianco - White
- .02** Nero - Black
- .45** Alluminio anodizzato - Anodized aluminium

Color temperature	LED Light source	lm source
/W 4000K	max 1,5W 500mA	221lm
/WW 3000K	max 1,5W 500mA	210lm
/XW 2700K	max 1,5W 500mA	199lm

0,07 Kg

Versione ETL disponibile su richiesta - ETL version available upon request

Accessori - Accessories



0214
KIT: box + Plaster



0217
Controcassa in materiale plastico
Plastic box



Drivers

Cod.	Drivers ON/OFF			DIMMABLE drivers				DIMMABLE drivers Casambi 0145/CASA
	0125	0128	0127	0141/DIM	0141/DALI	0145/DALI	0145	
6350	350mA	350mA	500mA	PUSH - 1...10V	DIM DALI	DIM DALI	DIM	1-21
6351	1-6	1-10	1-6	1-11	1-11	1-21	1-21	1-21

Solo collegamento in serie - Only serial connection



Decorative lights

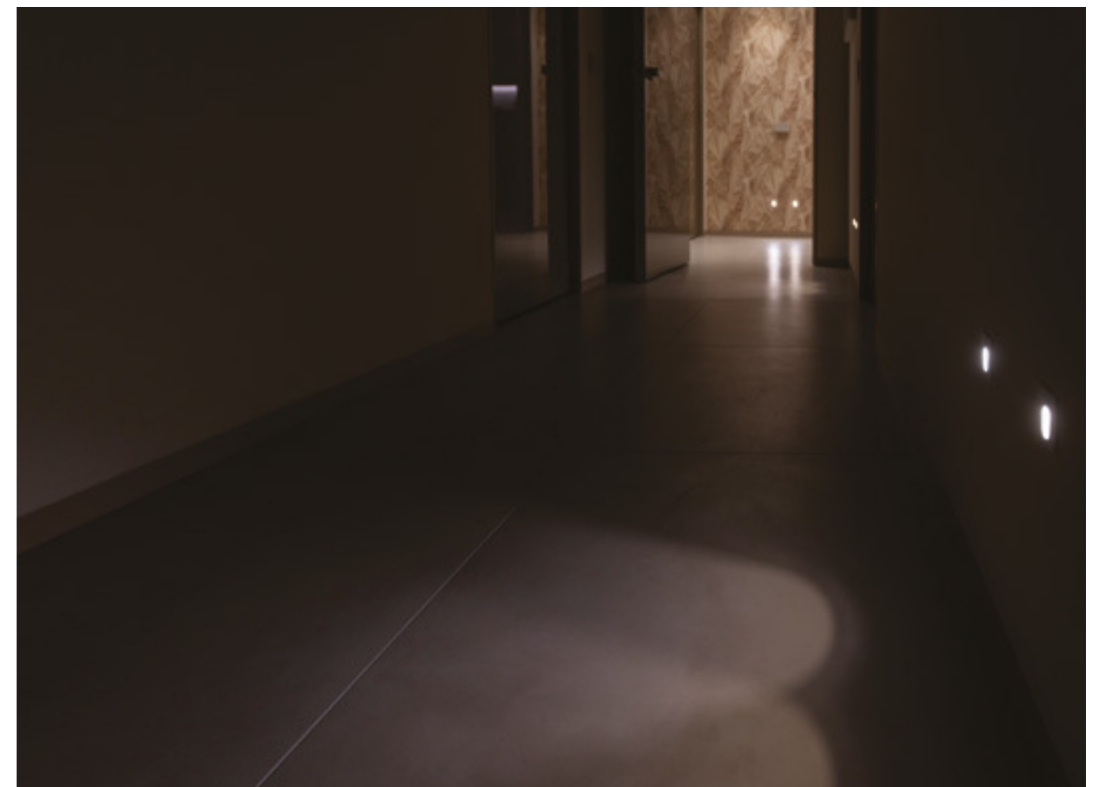

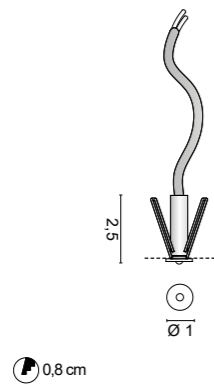

6372 Lucciola

.01 Bianco - White

Color temperature LED Light source

/B	LED BLU	8V DC 0,16W 20mA
/CW	5000K	8V DC 0,16W 20mA
/WW	3000K	8V DC 0,16W 20mA
/XW	2700K	8V DC 0,16W 20mA

F III IP 40 30 cm 0,01 Kg

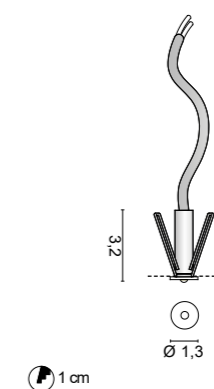

6353 Lucciola RGB

.01 Bianco - White

LED Light sources

0,7 12V DC

F III IP 40 30 cm 0,01 Kg

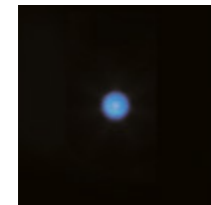

.01/B

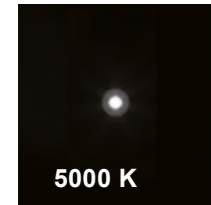

5000 K

.01/CW



3000 K

.01/WW

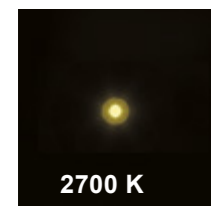

2700 K

.01/XW



Drivers

Drivers ON/OFF	
Cod.	0130
	8V DC
6372	1-40

Solo collegamento in parallelo, NON dimmerabile - Only parallel connection, NON dimmable

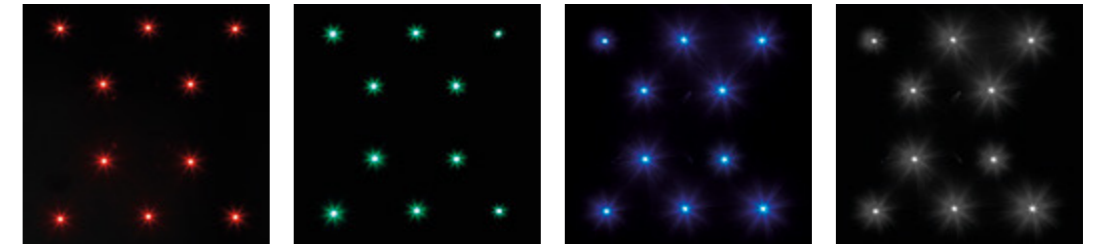

Drivers

	RGB CONTROLLER	DRIVERS RGB	
Cod.	0152	0159	0173
	Kit centralina RGB + Telecomando	12V	12V
	Kit RGB controller + Remote control	25W	50W
6353		1-26	1-50

Centraline RGB non sincronizzabili tra loro - Solo collegamento in parallelo
RGB controller cannot be synchronized with each other - Only parallel connection

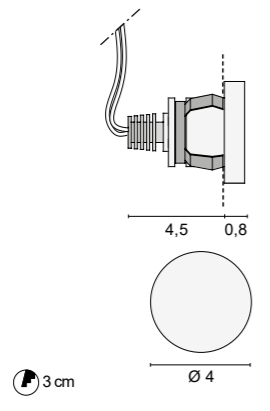

6354 Ice Tondo

.01 Bianco - White

Color temperature	LED Light source	lm source
/B	LED BLU 1W 350mA	
/W	4000K 1W 350mA	158lm
/WW	3000K 1W 350mA	150lm
/XW	2700K 1W 350mA	143lm

IP 44 0,05 Kg

Versione ETL disponibile su richiesta
ETL version available upon request



Diffusore in metacrilato satinato
Frosted methacrylate diffuser

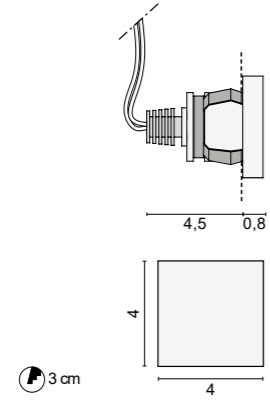

6355 Ice Quadro

.01 Bianco - White

Color temperature	LED Light source	lm source
/B	LED BLU 1W 350mA	
/W	4000K 1W 350mA	158lm
/WW	3000K 1W 350mA	150lm
/XW	2700K 1W 350mA	143lm

IP 44 0,04 Kg

Versione ETL disponibile su richiesta
ETL version available upon request



Diffusore in metacrilato satinato
Frosted methacrylate diffuser



.01/B .01/W 4000 K .01/WW 3000 K .01/XW 2700 K

Accessori - Accessories

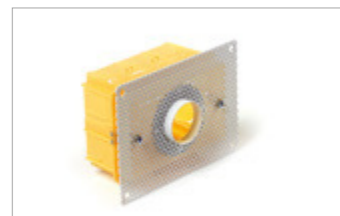

0213
KIT: box + Plaster



0216
Controcassa in materiale plastico
Plastic box

Drivers

Cod.	Drivers ON/OFF	
	0125 350mA	0128 350mA
6354	1-6	1-10
6355	1-6	1-10

DIMMABLE drivers			
0141/DIM	0141/DALI	0145/DALI	0145
PUSH - 1...10V	DIM DALI	DIM DALI	DIM
1-12	1-12	1-21	1-21
1-12	1-12	1-21	1-21

DIMMABLE drivers	
Casambi	0145/CASA
1-21	
1-21	

Solo collegamento in serie - Only serial connection



VEGA

Decorative lights

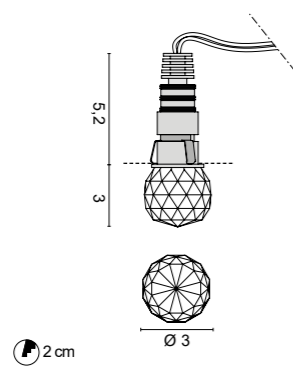

6358 Vega
.50 Cristallo - Crystal

Color temperature	LED Light source	lm source
/W 4000K	1W 350mA	158lm
/WW 3000K	1W 350mA	150lm
/XW 2700K	1W 350mA	143lm

0,06 Kg

Versione ETL disponibile su richiesta
 ETL version available upon request



SIRIO

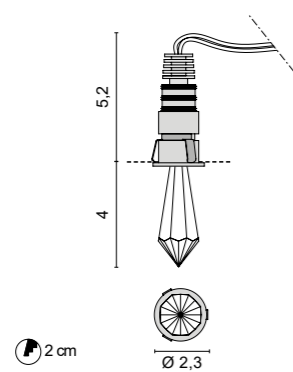

6359 Sirio
.50 Cristallo - Crystal

Color temperature	LED Light source	lm source
/W 4000K	1W 350mA	158lm
/WW 3000K	1W 350mA	150lm
/XW 2700K	1W 350mA	143lm

0,04 Kg

Versione ETL disponibile su richiesta
 ETL version available upon request



ALCOR

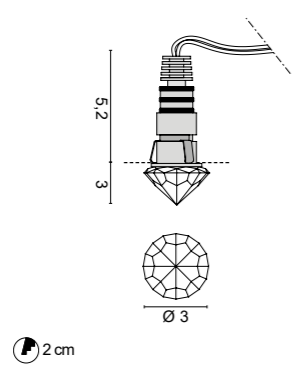

6360 Alcor
.50 Cristallo - Crystal

Color temperature	LED Light source	lm source
/W 4000K	1W 350mA	158lm
/WW 3000K	1W 350mA	150lm
/XW 2700K	1W 350mA	143lm

0,03 Kg

Versione ETL disponibile su richiesta
 ETL version available upon request



Accessori - Accessories



0212
 KIT: box + Plaster

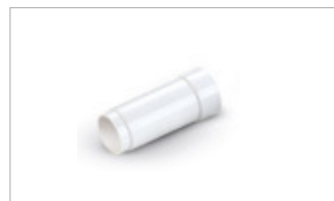

0215
 Controcassa in materiale plastico
 Plastic box

Drivers

Cod.	Drivers ON/OFF	
	0125	0128
	350mA	350mA
6358 - 6359 - 6360	1-6	1-10

DIMMABLE drivers			
0141/DIM	0141/DALI	0145/DALI	0145
PUSH - 1...10V	DIM DALI	DIM DALI	DIM
1-12	1-12	1-21	1-21

DIMMABLE drivers
Casambi
0145/CASA
1-21

Solo collegamento in serie - Only serial connection

Art. 6359 Sirio

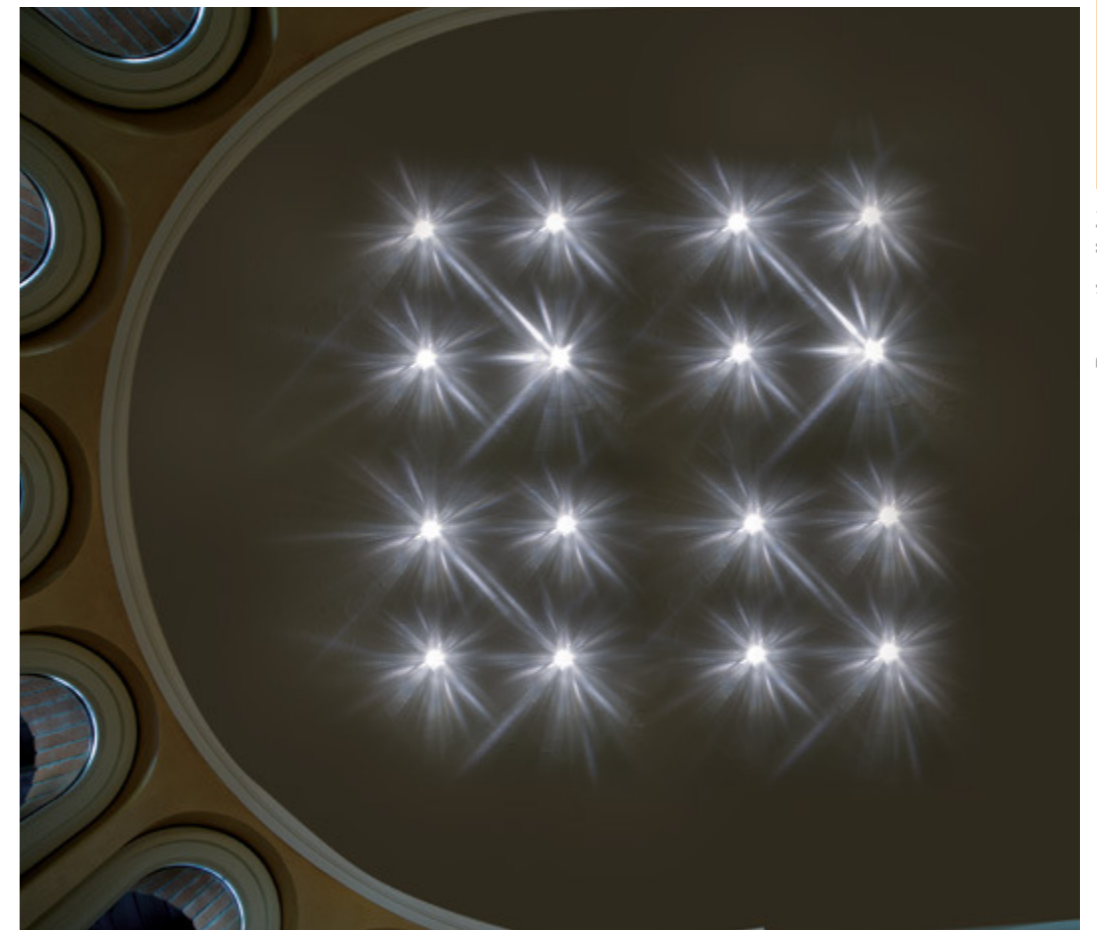

Decorative lights

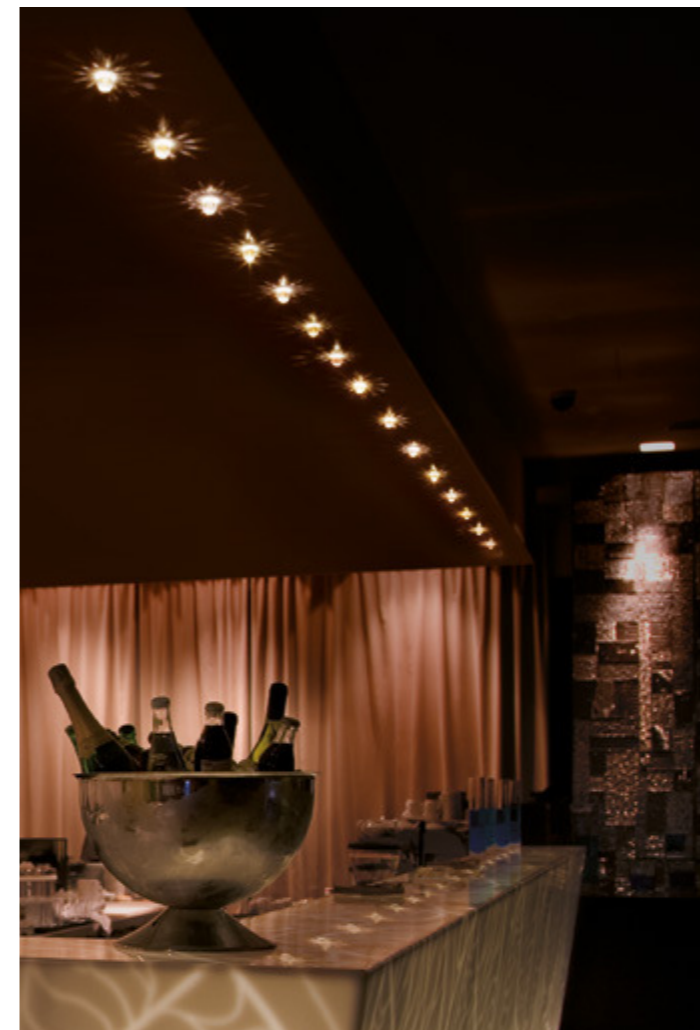

Art. 6358 Vega



Art. 6360 Alcor

VEGA MAXI RGB

Decorative lights

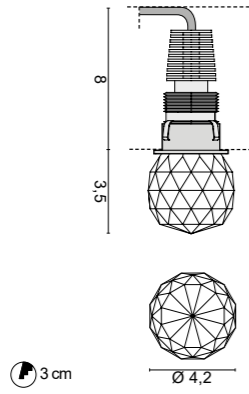

6378 Vega Maxi RGB

.50 Cristallo - Crystal

LED Light source
3x250mA

F III IP 44 30 cm R 0,16 Kg

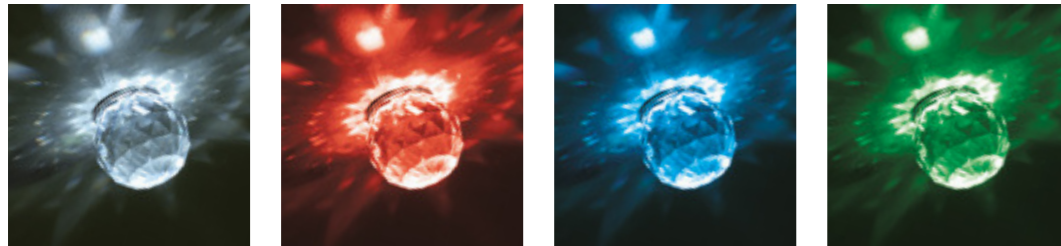

ALCOR MAXI RGB

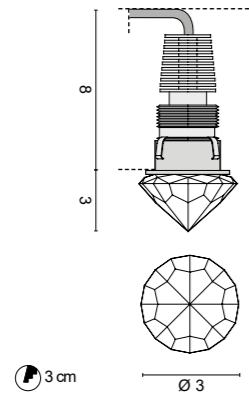

6379 Alcor Maxi RGB

.50 Cristallo - Crystal

LED Light source
3x250mA

F III IP 44 30 cm R 0,12 Kg

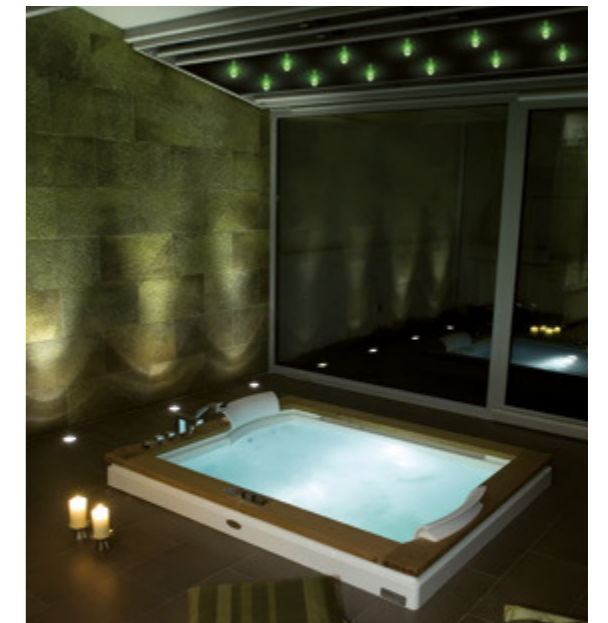
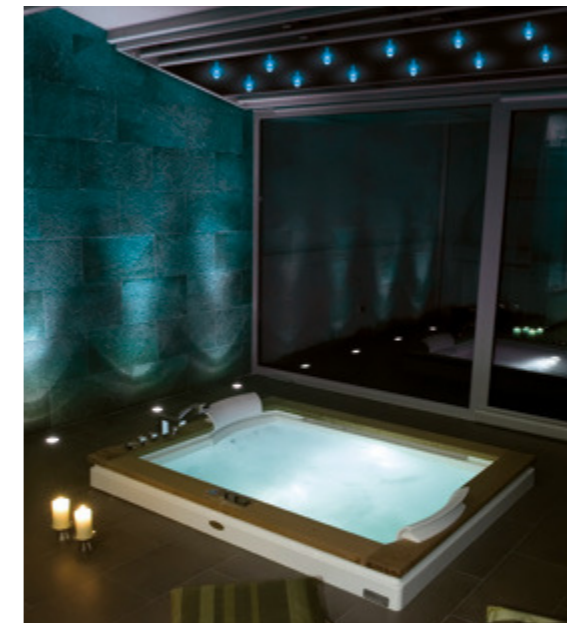
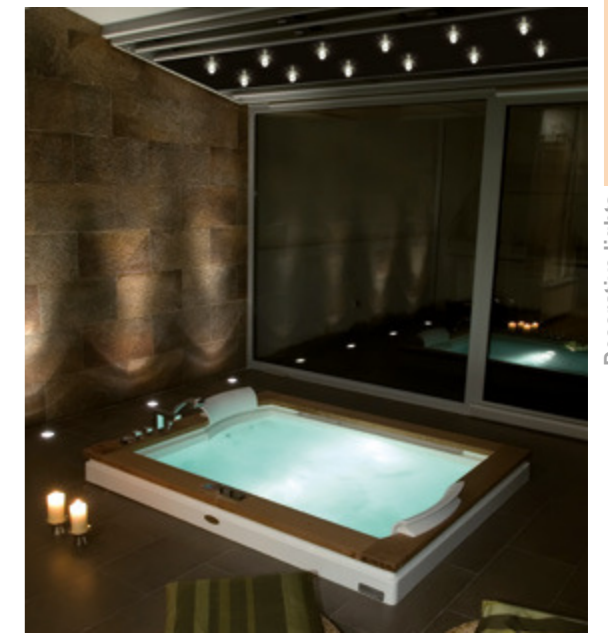
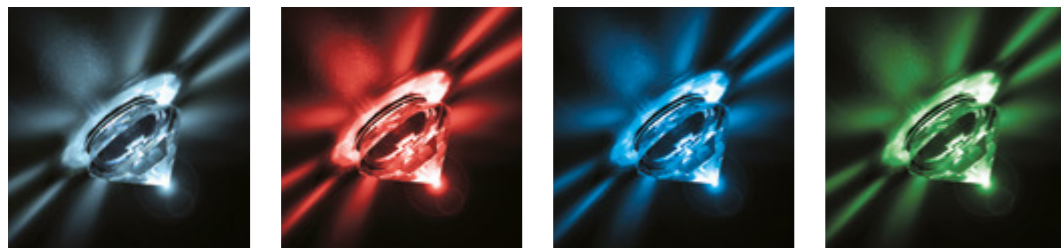

Decorative lights

Accessori - Accessories



0234

Controcassa in materiale plastico
Plastic box

Drivers

Drivers RGB

0164
120W
IN:230V - OUT: 3x24V

0167
22W

Driver RGB Casambi

0164/CASA
120W
IN:230V - OUT: 3x24V

Converter RGB

0168
IN:24V - OUT: 3x250 mA 1-5 Vega RGB

0163
IR Sensor

0165
IR Remote controller

0166
Sinc Cable

Solo collegamento in serie - Only serial connection

TOP

Decorative lights

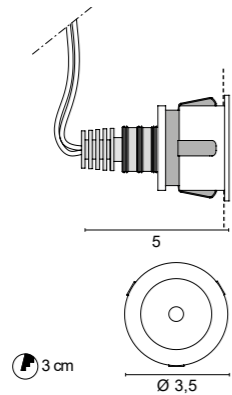

6363 Top

.01	Bianco - White
.02	Nero - Black

Color temperature	LED Light source	lm source
/W 4000K	max 1,5W 500mA	221lm
/WW 3000K	max 1,5W 500mA	210lm
/XW 2700K	max 1,5W 500mA	199lm

0,04 Kg

Versione ETL disponibile su richiesta
 ETL version available upon request

TOP MINI

Decorative lights

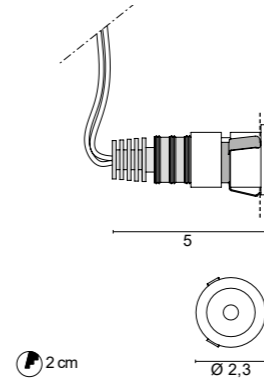

6364 Top Mini

.01	Bianco - White
.02	Nero - Black

Color temperature	LED Light source	lm source
/W 4000K	1W 350mA	158lm
/WW 3000K	1W 350mA	150lm
/XW 2700K	1W 350mA	143lm

0,02 Kg

Versione ETL disponibile su richiesta
 ETL version available upon request

TOP IP

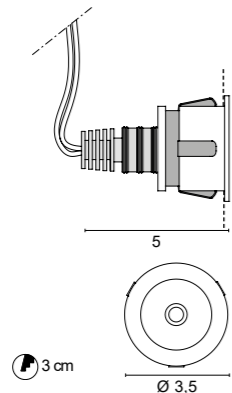

6740 Top IP

.01	Bianco - White
.02	Nero - Black
.31	Cromato - Chromed

Color temperature	Optics	LED Light source	lm source
/W 4000K	/15 /25 /45	max 1,5W 500mA	221lm
/WW 3000K	/15 /25 /45	max 1,5W 500mA	210lm
/XW 2700K	/15 /25 /45	max 1,5W 500mA	199lm

0,04 Kg

Versione ETL disponibile su richiesta
 ETL version available upon request

Accessori - Accessories



0213
 KIT: box + Plaster



0216
 Controcassa in materiale plastico
 Plastic box

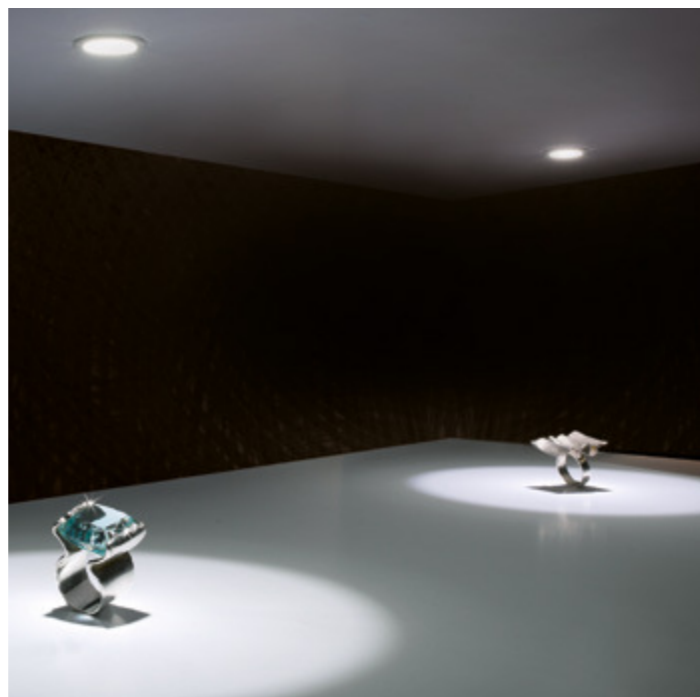

Drivers

Cod.	Drivers ON/OFF			DIMMABLE drivers				DIMMABLE drivers Casambi 0145/CASA
	0125 350mA	0128 350mA	0127 500mA	0141/DIM PUSH - 1...10V	0141/DALI DIM DALI	0145/DALI DIM DALI	0145 DIM	
6363 - 6740	1-6	1-10	1-6	1-11	1-11	1-21	1-21	1-21

Solo collegamento in serie - Only serial connection



Accessori - Accessories



0212
 KIT: box + Plaster



0215
 Controcassa in materiale plastico
 Plastic box

Drivers

Cod.	Drivers ON/OFF		DIMMABLE drivers				DIMMABLE drivers Casambi 0145/CASA
	0125 350mA	0128 350mA	0141/DIM PUSH - 1...10V	0141/DALI DIM DALI	0145/DALI DIM DALI	0145 DIM	
6364	1-6	1-10	1-12	1-12	1-21	1-21	1-21

Solo collegamento in serie - Only serial connection

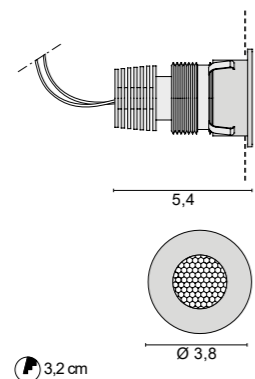

6322 Pix Tondo

- .01** Bianco - *White*
- .32** Nickel satinato - *Nickel mat*

Color temperature	Optics	LED Light source	lm source
/W 4000K	/11 /25 /45	max 1,5W 500mA	221lm
/WW 3000K	/11 /25 /45	max 1,5W 500mA	210lm
/XW 2700K	/11 /25 /45	max 1,5W 500mA	199lm

IP 40 0,06 Kg

Versione ETL disponibile su richiesta
ETL version available upon request

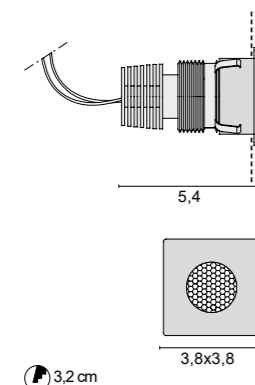

6323 Pix Quadro

- .01** Bianco - *White*
- .32** Nickel satinato - *Nickel mat*

Color temperature	Optics	LED Light source	lm source
/W 4000K	/11 /25 /45	max 1,5W 500mA	221lm
/WW 3000K	/11 /25 /45	max 1,5W 500mA	210lm
/XW 2700K	/11 /25 /45	max 1,5W 500mA	199lm

IP 40 0,06 Kg

Versione ETL disponibile su richiesta
ETL version available upon request

Accessori - Accessories



0209
Adattatore per doghe



0213
KIT: box + Plaster



0234
Controcassa in materiale plastico
Plastic box

Drivers

Cod.	Drivers ON/OFF		
	0125 350mA	0128 350mA	0127 500mA
6322	1-6	1-10	1-6
6323	1-6	1-10	1-6

DIMMABLE drivers			
0141/DIM PUSH - 1...10V	0141/DALI DIM DALI	0145/DALI DIM DALI	0145 DIM
1-12	1-12	1-21	1-21
1-12	1-12	1-21	1-21

DIMMABLE drivers Casambi	
0145/CASA	
1-21	
1-21	

Solo collegamento in serie - Only serial connection



Decorative lights

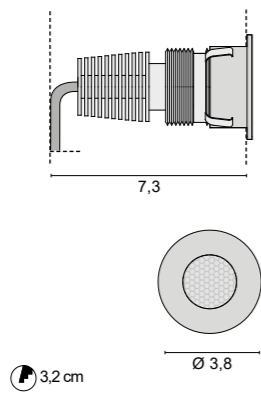

6375 Pix RGB Tondo

- .01** Bianco - *White*
- .32** Nickel satinato - *Nickel mat*

LED Light source
3x250mA

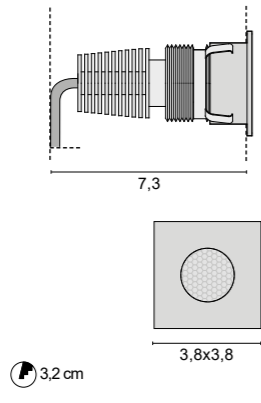

6413 Pix RGB Quadro

- .01** Bianco - *White*
- .32** Nickel satinato - *Nickel mat*

LED Light source
3x250mA



Accessori - Accessories



0209
Adattatore per doghe



0234
Controcassa in materiale plastico
Plastic box

Drivers

Drivers RGB

0164 120W IN:230V - OUT: 3x24V	0167 22W
---------------------------------------------	--------------------

Driver RGB Casambi

0164/CASA 120W IN:230V - OUT: 3x24V

Converter RGB

0168 IN:24V - OUT: 3x250 mA 1-5 Pix RGB

0163 IR Sensor	0165 IR Remote controller	0166 Sinc Cable
--------------------------	-------------------------------------	---------------------------

Solo collegamento in serie - Only serial connection



Decorative lights

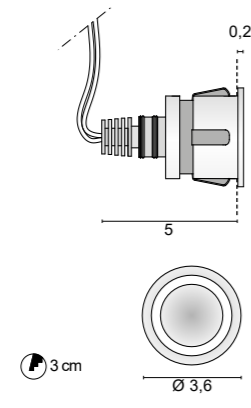

6391 Cerchietto

.01 Bianco - White

Color temperature	LED Light source	Im source
/B LED BLU	1W 350mA	
/W 4000K	max 1,5W 500mA	221lm
/WW 3000K	max 1,5W 500mA	210lm
/XW 2700K	max 1,5W 500mA	199lm

F III IP 44 R 0,04 Kg

Versione ETL disponibile su richiesta
ETL version available upon request

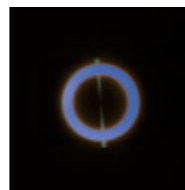

.01/B



.01/W



.01/WW



.01/XW

Accessori - Accessories



0213
KIT: box + Plaster



0216
Controcassa in materiale plastico
Plastic box

Cod.	Drivers ON/OFF			DIMMABLE drivers			DIMMABLE drivers Casambi
	0125	0128	0127	0141/DIM	0141/DALI	0145/DALI	0145/CASA
6391	350mA	350mA	500mA	PUSH - 1...10V	DIM DALI	DIM DALI	
	1-6	1-10	1-6	1-11	1-11	1-21	1-21

Solo collegamento in serie - Only serial connection

CRUISE

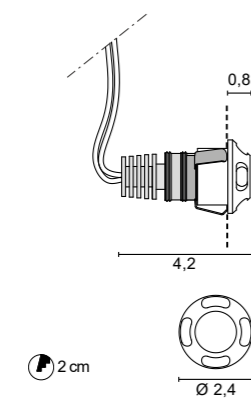
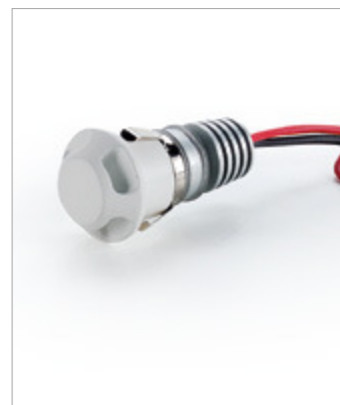

6382 Cruise

.01 Bianco - White

Color temperature	LED Light source	Im source
/B LED BLU	1W 350mA	
/W 4000K	1W 350mA	158lm
/WW 3000K	1W 350mA	150lm
/XW 2700K	1W 350mA	143lm

F III IP 44 R 0,02 Kg

Versione ETL disponibile su richiesta
ETL version available upon request

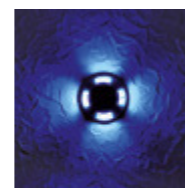

.01/B

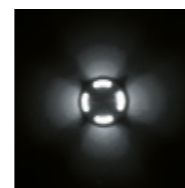

.01/W

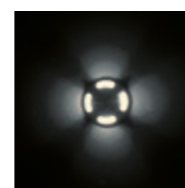

.01/WW

Accessori - Accessories



0212
KIT: box + Plaster



0215
Controcassa in materiale plastico
Plastic box

Cod.	Drivers ON/OFF			DIMMABLE drivers				DIMMABLE drivers Casambi
	0125	0128		0141/DIM	0141/DALI	0145/DALI	0145/CASA	
6382	350mA	350mA		PUSH - 1...10V	DIM DALI	DIM DALI		
	1-6	1-10		1-12	1-12	1-21	1-21	

Solo collegamento in serie - Only serial connection

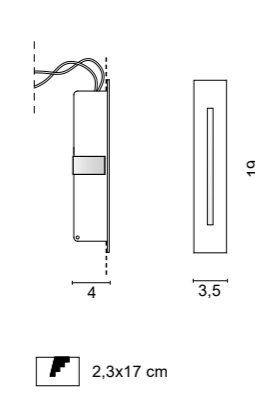

6381 Slot

.01 Bianco - White

Color temperature	LED Light source	Im source
/W 4000K	1W 350mA	158lm
/WW 3000K	1W 350mA	150lm
/XW 2700K	1W 350mA	143lm

F III IP 44 R 0,02 Kg

Versione ETL disponibile su richiesta
ETL version available upon request



Accessori - Accessories



















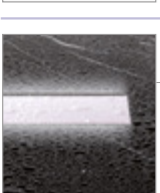
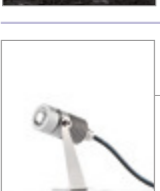
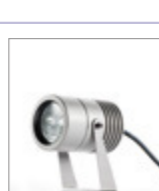

0249
KIT: box + Plaster

Drivers

Cod.	Drivers ON/OFF			DIMMABLE drivers				DIMMABLE drivers Casambi
	0125	0128		0141/DIM	0141/DALI	0145/DALI	0145/CASA	
6381	350mA	350mA		PUSH - 1...10V	DIM DALI	DIM DALI		
	1-6	1-10		1-12	1-12	1-21	1-21	

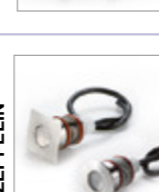
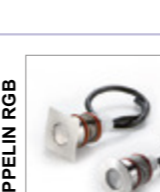
Solo collegamento in serie - Only serial connection

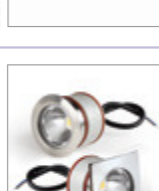
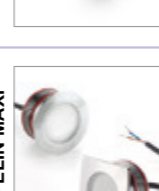
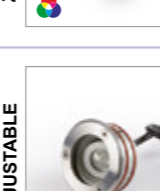
AGOS	 3540 - p. 256	 3541 - p. 256	 4680 - p. 300	 4681 - p. 301
SPILLO	 3542 - p. 302 3543 - p. 302			
LARA	 2550 - p. 306	 2552 - p. 307	 2553 - p. 307	 1690 - p. 308
LARA MAXI	 3551 - p. 309	 3552 - p. 309		
WANDA	 4536 - p. 312 4537 - p. 312	 4538 - p. 312 4539 - p. 312		
SPOOK	 6417 - p. 316 6418 - p. 316 6419 - p. 316			
VISION 1	 4510 - p. 320	 4511 - p. 321	 4555 - p. 321	
ZEPPELIN MINI	 6730 - p. 324 6731 - p. 324	 6732 - p. 325 6733 - p. 325	 6348 - p. 326 6349 - p. 326	 6376 - p. 327 6395 - p. 327
ZEPPELIN 25 PLUS	 6394 - p. 328 6384 - p. 328	 6397 - p. 330 6341 - p. 330	 6736 - p. 331 6737 - p. 331	 6411 - p. 332

TRIS	 6371 - p. 334			
SOFT	 6388 - p. 335			
CERCHIO	 6389 - p. 336	 6390 - p. 337		
STEP	 6387 - p. 338 6369 - p. 338	 6738 - p. 339 6739 - p. 339		
KROSS	 6361 - p. 340	 6735 - p. 341		
VISTA	 6362 - p. 342	 6734 - p. 343		
DRIVE	 6729 - p. 344			
JAZZ	 5538 - p. 346	 5539 - p. 347	 5520 - p. 348	 4625 - p. 349

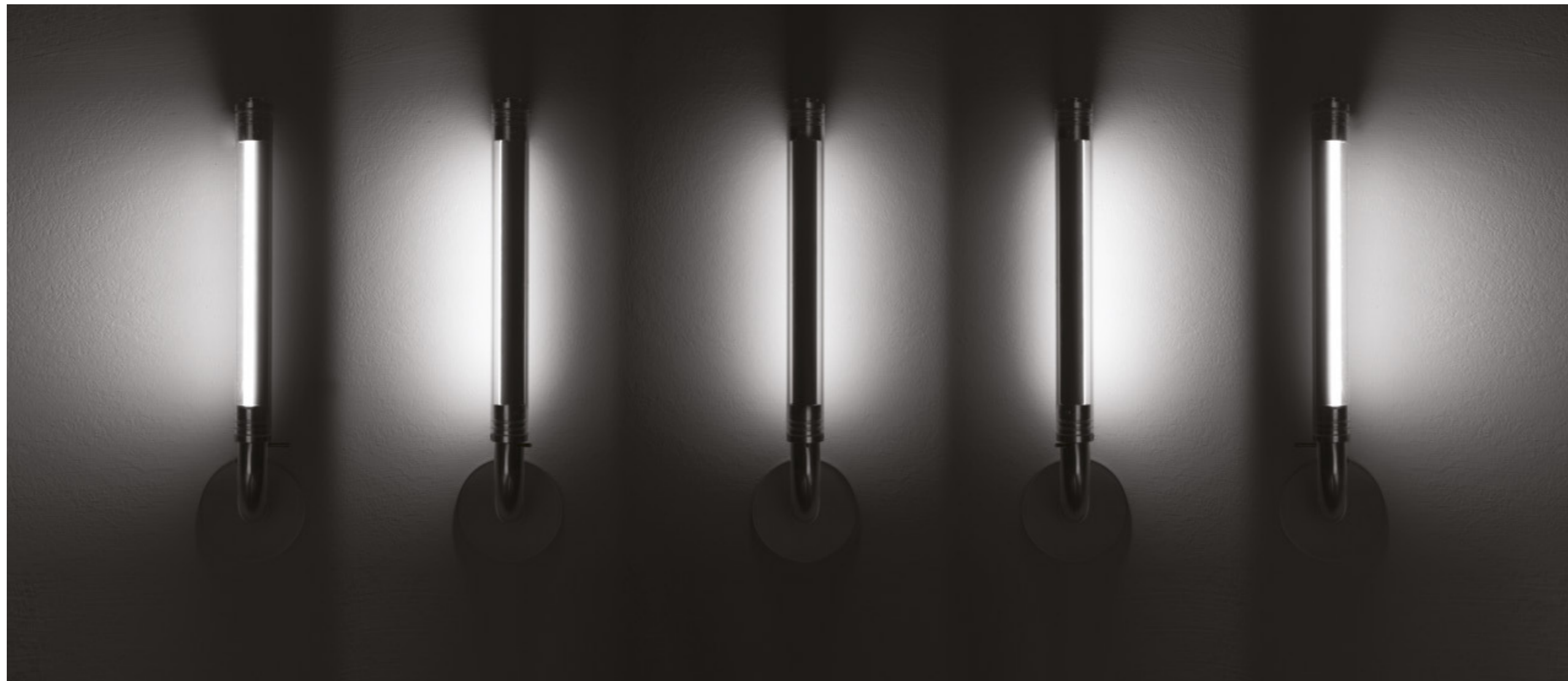

AGOS *design: officinadiarchitettura&design*

Collezione di lampade orientabili da esterno con struttura in acciaio AISI 316L e diffusore in metacrilato trasparente coestruso anti UV.

I diffusori possono ruotare indipendentemente di 350° sul proprio asse rendendo l'apparecchio estremamente funzionale e confortevole.

AGOS può assumere diverse forme ed altezze e può essere posizionata a terra o a parete.

Il suo funzionamento prevede l'utilizzo di un alimentatore da posizionare in remoto.

Collection of adjustable outdoor lamps with structure in AISI 316L steel and diffuser in anti-UV coextruded transparent methacrylate.

The diffusers can rotate independently of 350° on their axis making the fixture extremely functional and comfortable.

AGOS can take on different shapes and heights and can be placed on the floor or on the wall.

Its operation involves the use of a driver to be positioned remotely.

Collection de lampes d'extérieur orientables avec structure en acier AISI 316L et diffuseur en méthacrylate transparent co-extrudé anti-UV.

Les diffuseurs peuvent pivoter indépendamment de 350° sur leur axe, ce qui rend le luminaire extrêmement fonctionnel et confortable.

AGOS peut prendre différentes formes et hauteurs et peut être placée au sol ou au mur.

Son fonctionnement implique l'utilisation d'une alimentation à positionner à distance.

Colección de luminarias de exterior orientables con estructura en acero AISI 316L y difusor en metacrilato transparente coextruido anti-UV.

Los difusores pueden girar independientemente 350° sobre su eje, lo que hace que la luminaria sea extremadamente funcional y cómoda.

AGOS puede adoptar diferentes formas y alturas y puede colocarse en el suelo o en la pared.

Su funcionamiento implica el uso de una fuente de alimentación para ser posicionado de forma remota.

Kollektion verstellbarer Außenleuchten mit Struktur aus AISI 316L-Stahl und Diffusor aus coextrudiertem transparentem Methacrylat mit UV-Schutz.

Die Diffusoren können unabhängig von 350° um ihre Achse gedreht werden, was die Leuchte äußerst funktional und komfortabel macht.

AGOS kann verschiedene Formen und Höhen annehmen und auf dem Boden oder an der Wand platziert werden.

Sein Betrieb beinhaltet die Verwendung einer Stromversorgung, die entfernt positioniert werden soll.

Collezione regolabile di apparecchi per illuminazione esterna con struttura in acciaio AISI 316L e diffusore in metacrilato trasparente coestruido anti-UV.

I diffusori possono ruotare indipendentemente di 350° attorno all'asse, rendendo l'apparecchio estremamente funzionale e confortevole.

AGOS può assumere diverse forme ed altezze e può essere posizionata a terra o a parete.

Il suo funzionamento prevede l'utilizzo di un alimentatore da posizionare in remoto.

Outdoor

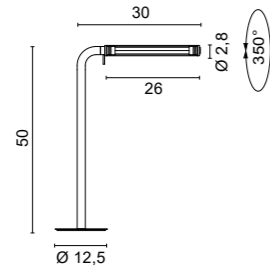

3540 Agos

.33 Acciaio satinato - Matt steel
Inox AISI 316L

Color temperature	LED Light source	lm source
/W 4000K	24V 3W	368lm
/WW 3000K	24V 3W	330lm
/XW 2700K	24V 3W	312lm

IP67 0,75 Kg

Le lampade sono fornite senza driver.
Questi sono da ordinare separatamente e collocare in remoto.
The lamps are supplied without drivers.
These are to be ordered separately and placed remotely.

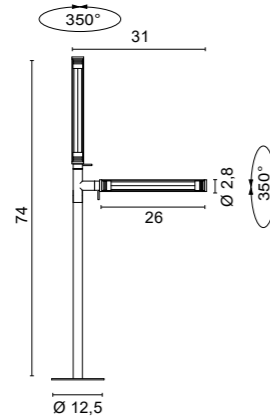

3541 Agos

.33 Acciaio satinato - Matt steel
Inox AISI 316L

Color temperature	LED Light source	lm source
/W 4000K	24V 6W	736lm
/WW 3000K	24V 6W	660lm
/XW 2700K	24V 6W	624lm

IP67 1,00 Kg

Le lampade sono fornite senza driver.
Questi sono da ordinare separatamente e collocare in remoto.
The lamps are supplied without drivers.
These are to be ordered separately and placed remotely.

Il diffusore puo' ruotare di 350°
The diffuser can rotate by 350°

Accessori - Accessories



0246/R
Box + plate con viti d'acciaio
Box + plate with steel screws



0243
Connettore IP per cavi Ø < 7.0 mm
IP Connector for cables Ø < 7.0 mm



0245
Picchetto per l'installazione
temporanea a terreno
Stakes for temporary
installation on field

Drivers

Drivers ON/OFF

Cod.	0155	0156	0160	0157
	24V-13W	24V-25W	24V-50W	24V-75W

IP67 drivers

Cod.	0033/IP	0034/IP
	24V-14,4W	24V-70W

Outdoor





Outdoor

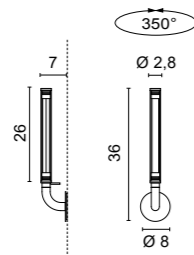

4680 Agos

.33 Acciaio satinato - Matt steel
Inox AISI 316L

Color temperature	LED Light source	lm source
/W 4000K	24V 3W	368lm
/WW 3000K	24V 3W	330lm
/XW 2700K	24V 3W	312lm

IP67 550 cm R 0,40 Kg

Le lampade sono fornite senza driver.
Questi sono da ordinare separatamente e collocare in remoto.
The lamps are supplied without drivers.
These are to be ordered separately and placed remotely.

Il diffusore puo' ruotare di 350°
The diffuser can rotate by 350°



Drivers

Drivers **ON/OFF**

Cod.	0155	0156	0160	0157
	24V-13W	24V-25W	24V-50W	24V-75W

IP67 drivers

Cod.	0033/IP	0034/IP
	24V-14,4W	24V-70W



Outdoor

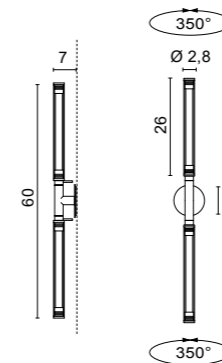

4681 Agos

.33 Acciaio satinato - Matt steel
Inox AISI 316L

Color temperature	LED Light source	lm source
/W 4000K	24V 6W	736lm
/WW 3000K	24V 6W	660lm
/XW 2700K	24V 6W	624lm

IP67 550 cm R 0,75 Kg

Le lampade sono fornite senza driver.
Questi sono da ordinare separatamente e collocare in remoto.
The lamps are supplied without drivers.
These are to be ordered separately and placed remotely.

I due diffusori possono ruotare indipendentemente di 350°
The two diffusers can rotate independently by 350°

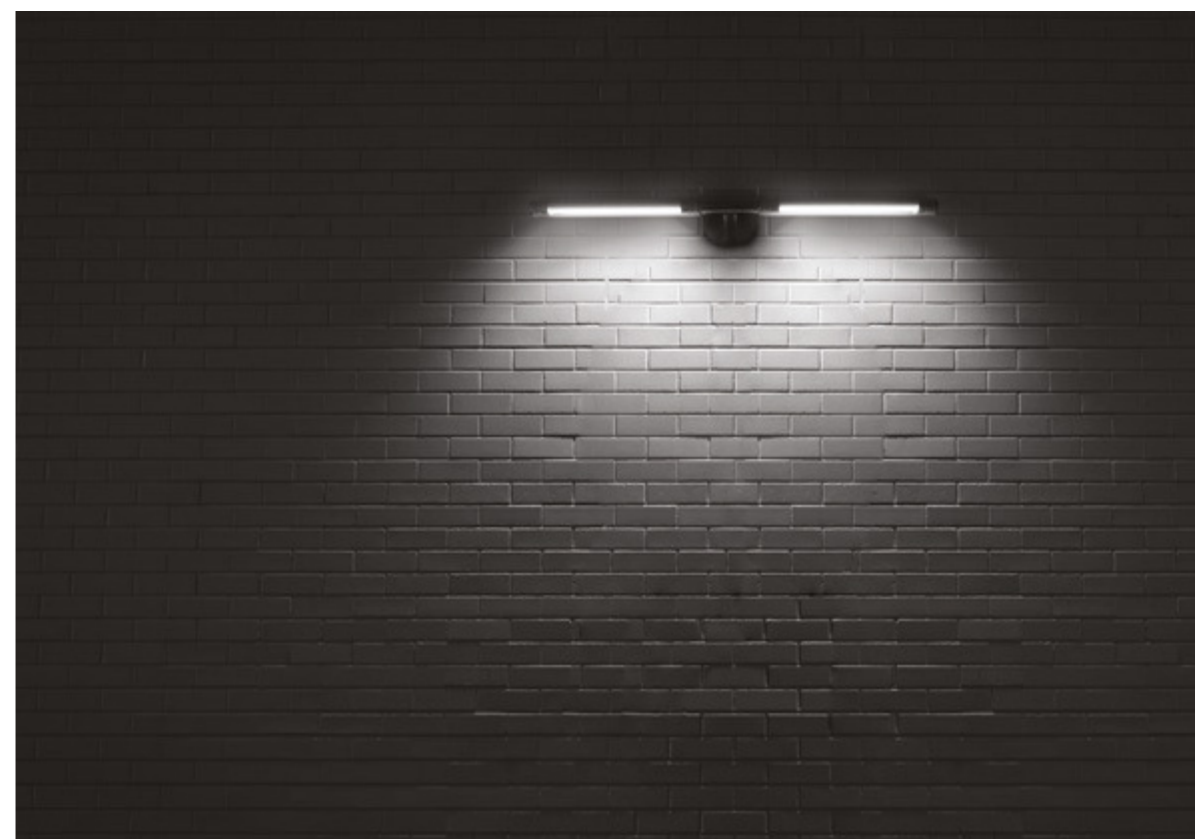
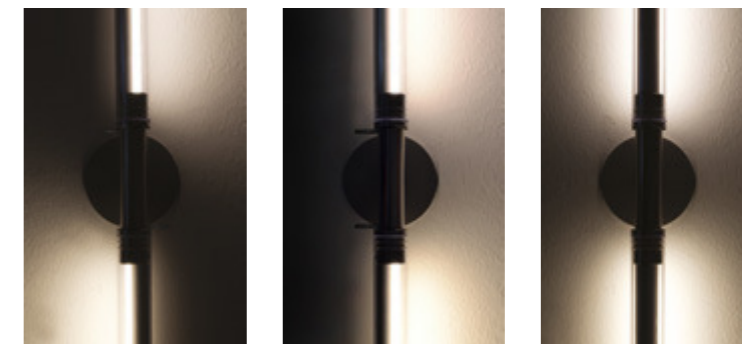

Drivers

Drivers **ON/OFF**

Cod.	0155	0156	0160	0157
	24V-13W	24V-25W	24V-50W	24V-75W

IP67 drivers

Cod.	0033/IP	0034/IP
	24V-14,4W	24V-70W

Outdoor

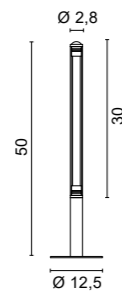

3542 Spillo

.33 Acciaio satinato - Matt steel

	Color temperature	LED Light source	lm source
/W	4000K	24V 6W	650lm
/WW	3000K	24V 6W	576lm
/XW	2700K	24V 6W	520lm

IP67 R 0,60 Kg

Le lampade sono fornite senza driver.
Questi sono da ordinare separatamente e collocare in remoto.
The lamps are supplied without drivers.
These are to be ordered separately and placed remotely.

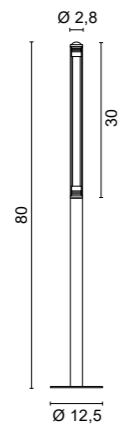

3543 Spillo

.33 Acciaio satinato - Matt steel

	Color temperature	LED Light source	lm source
/W	4000K	24V 6W	650lm
/WW	3000K	24V 6W	576lm
/XW	2700K	24V 6W	520lm

IP67 R 0,90 Kg

Le lampade sono fornite senza driver.
Questi sono da ordinare separatamente e collocare in remoto.
The lamps are supplied without drivers.
These are to be ordered separately and placed remotely.

La luce è emessa a 360° per tutta la lunghezza del diffusore.
The light is emitted at 360° along the entire length of the diffuser.

Accessori - Accessories



0246/R
Box + plate with steel screws



0243
IP Connector for cables Ø < 7.0 mm



0245
Picchetto per l'installazione temporanea a terreno
Stakes for temporary installation on field



0252/S.33
Copribase
Basecover

Drivers

Drivers ON/OFF

Cod.	0155	0156	0160	0157
	24V-13W	24V-25W	24V-50W	24V-75W

IP67 drivers

Cod.	0033/IP	0034/IP
	24V-14,4W	24V-70W

Outdoor





LARA design: Serge Cornelissen

Il design essenziale, combinato con la tecnologia innovativa di una lampada portatile alimentata a batteria, rendono Lara un prodotto elegante e funzionale. Il riflettore versatile dell'apparecchio può essere utilizzato in varie applicazioni. Con Lara non c'è limite alla creatività: che sia una piantana, con un morsetto da tavolo, un picchetto da terra o una corda per sospensione. Lara può essere ricaricata con un cavo USB-C (incluso).

The minimal design combined with the innovative technology of the battery-powered portable luminaire, makes Lara an elegant and functional product. The multipurpose luminaire reflector can be used in various applications. Whether a floor, table clamp, ground stake, or rope to hang, there is no limit to your creativity. Lara can be charged a USB-C cable (included).

Le design minimaliste combiné à la technologie innovante du luminaire portable à piles font de Lara un produit élégant et fonctionnel. Le réflecteur de luminaire polyvalent peut être utilisé dans diverses applications. Qu'il s'agisse d'un sol, d'une pince de table, d'un piquet de sol ou d'une corde à suspendre, il n'y a pas de limite à votre créativité. Lara peut être chargée avec un câble USB-C (inclus).

El diseño minimalista combinado con la tecnología innovadora de la luminaria portátil alimentada por batería, hace de Lara un producto elegante y funcional. El reflector de luminaria polivalente se puede utilizar en diversas aplicaciones. Ya sea un piso, una abrazadera de mesa, una estaca de tierra o una cuerda para colgar, no hay límite para su creatividad. Lara se puede cargar con un cable USB-C (incluido).

Das minimalistische Design kombiniert mit der innovativen Technologie der batteriebetriebenen tragbaren Leuchte macht Lara zu einem eleganten und funktionalen Produkt. Der Mehrzweck-Leuchtenreflektor kann in verschiedenen Anwendungen eingesetzt werden. Ob Boden, Tischklemme, Erdspeiß oder Seil zum Aufhängen, Ihrer Kreativität sind keine Grenzen gesetzt. Lara kann über ein USB-C-Kabel (im Lieferumfang enthalten) aufgeladen werden.

Минималистичный дизайн в сочетании с инновационной технологией переносного светильника с батарейным питанием делает Lara элегантным и функциональным продуктом. Многоцелевой отражатель светильника можно использовать в различных приложениях. Будь то пол, зажим для стола, наземный стержень или веревка для подвешивания, нет предела вашему творчеству. Лара можно заряжать с помощью кабеля USB-C (входит в комплект).



Outdoor

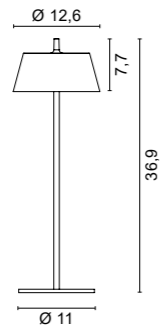

2550 Lara

.02	Nero - Black
.06	Verde - Green
.34	Corten - Rust Brown
.39	Antracite - Anthracite

Color temperature	LED Light source	lm source
2700K - 3000K	2,2W	117lm

0,65 Kg

Lampada da tavolo IP65, ricaricabile e dimmerabile Tunable White 2700K-3000K, con struttura in acciaio e metallo, riflettore in PVC e cavo USB-C in dotazione. La durata della batteria è di 8 ore al 100% di luminosità e dimmerazione continua ed il tempo di ricarica è di 7 ore.

IP65 table lamp, rechargeable and dimmable Tunable White 2700K-3000K, with structure in steel and metal, reflector in PVC and USB-C cable supplied. The battery life is 8 hours at 100% brightness and continuous dimming and the recharge time is 7 hours.

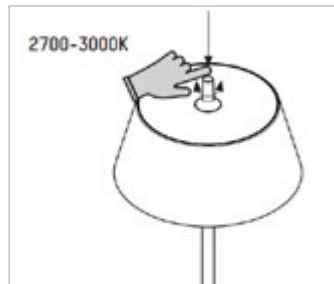

Outdoor

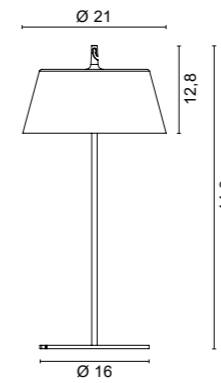

2552 Lara Maxi

.02	Nero - Black
-----	--------------

Color temperature	LED Light source	lm source
3000K	3,5W	140lm

1,53 Kg

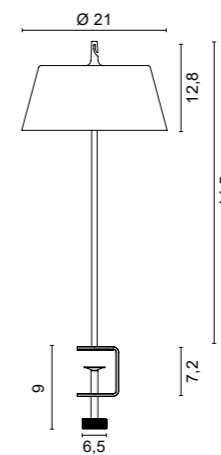

2553 Lara Maxi

.02	Nero - Black
-----	--------------

Color temperature	LED Light source	lm source
3000K	3,5W	140lm

0,92 Kg

Lampada da tavolo IP65, ricaricabile, dimmerabile in tre step, con struttura in acciaio e metallo, riflettore in PVC e cavo USB-C in dotazione. Impilabile fino a tre elementi. La durata della batteria è di 11 ore al 100% di luminosità ed il tempo di ricarica è di 7 ore.

IP65 rechargeable table lamp, dimmable in three steps, with steel and metal structure, PVC reflector and USB-C cable supplied. Stackable up to three elements. Battery life is 11 hours at 100% brightness and recharge time is 7 hours.





Outdoor

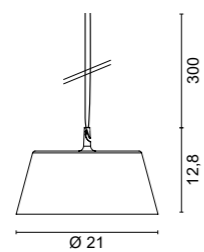

1690 Lara Maxi Suspension

- .02 Nero - Black
- .05 Rosso - Red

Color temperature	LED Light source	lm source
WW 3000K	3,5W	140m

0,70 Kg

Lampada da sospensione IP65, ricaricabile, dimmerabile in tre step, con riflettore in PVC, cavo di sospensione in cotone di tre metri e cavo USB-C in dotazione. Impilabile fino a tre elementi.

La durata della batteria è di 11 ore al 100% di luminosità ed il tempo di ricarica è di 7 ore.

IP65 rechargeable suspension lamp, dimmable in three steps, with PVC reflector, three-metre cotton suspension cable and USB-C cable supplied. Stackable up to three elements. Battery life is 11 hours at 100% brightness and recharge time is 7 hours.



Outdoor

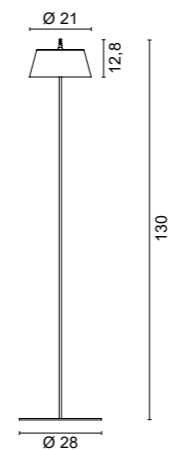

3551 Lara Maxi

- .02 Nero - Black

Color temperature	LED Light source	lm source
WW 3000K	3,5W	140m

1,53 Kg

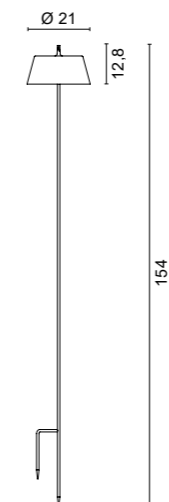
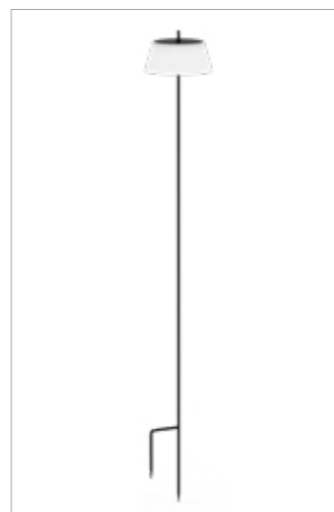

3552 Lara Maxi

- .02 Nero - Black

Color temperature	LED Light source	lm source
WW 3000K	3,5W	140m

0,92 Kg



Lampada da terra IP65, ricaricabile, dimmerabile in tre step, con struttura in acciaio e metallo, riflettore in PVC e cavo USB-C in dotazione. Impilabile fino a tre elementi. La durata della batteria è di 11 ore al 100% di luminosità ed il tempo di ricarica è di 7 ore.

IP65 floor lamp, rechargeable, dimmable in three steps, with steel and metal structure, PVC reflector and USB-C cable supplied. Stackable up to three elements. Battery life is 11 hours at 100% brightness and recharge time is 7 hours.



WANDA design: U.T. EGOLUCE

Barra luminosa orientabile a LED IP67 in metacrilato trasparente coestruso anti-UV e terminali in acciaio inox AISI 316L.

Cavo in neoprene da 100 cm. Applicazione a parete o a soffitto. Disponibile in diverse lunghezze fino a 3 metri. Versione ETL disponibile a richiesta.

Adjustable LED profile IP67 in coextruded anti-UV transparent methacrylate and AISI 316L stainless steel terminals. Neoprene cable 100 cm. Wall or ceiling installation possible. Available in different lengths up to 3 meters. ETL version available upon request.

Barre lumineuse orientable à LED IP67 en méthacrylate transparent coextru anti-UV et terminales en acier inox AISI 316L. Câble en néoprène 100 cm. Installable en applique ou au plafond. Disponibles en plusieurs longueurs jusqu'à 3 mètres.

Version ETL disponible sur demande.

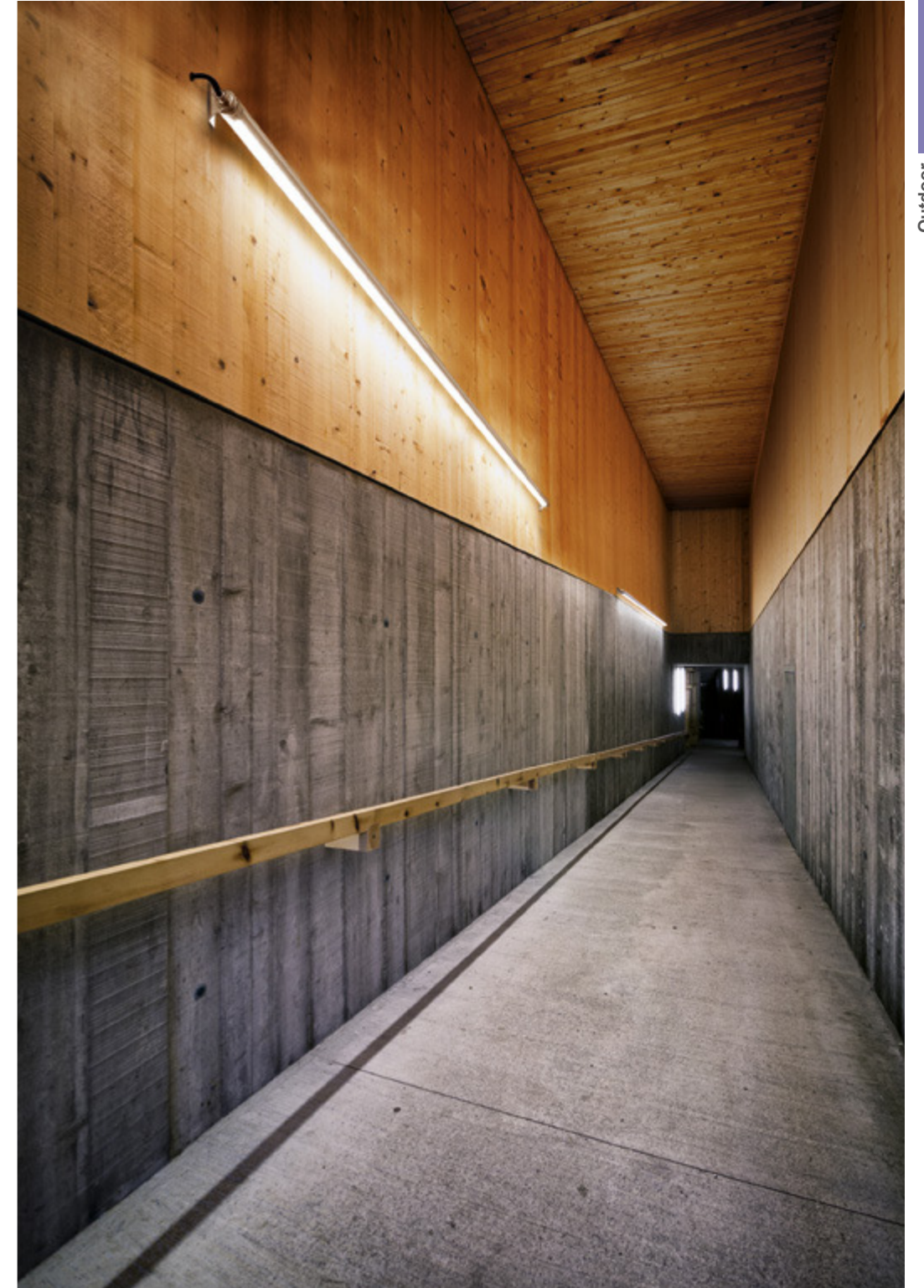

Barra luminosa orientabile a LED IP67 in metacrilato chiaro coestruso anti-UV y terminales de acero inox AISI 316L. Cable de neopreno 100 cm. Para montaje a pared y techo es disponible en varias larguras hasta 3 metros.

Verstellbare Linear LED System IP67 aus transparentem fließgepresstem Methakrylat mit UV schutz und Endteile aus Edelstahl AISI316L. Inkl. Neoprene Stromkabel 100 cm.

Zur Montage als Wand oder Deckenleuchte ist in verschiedene Länge bis Max. 3 Meter verfügbar.

Поворотный профиль со степенью защиты IP67 из прозрачного метакрилата без УФ, концевые детали из нержавеющей стали. Кабель из неопрена 100 см. Для стены или потолка. В разных размерах до 3 метров длиной.

Outdoor

Outdoor

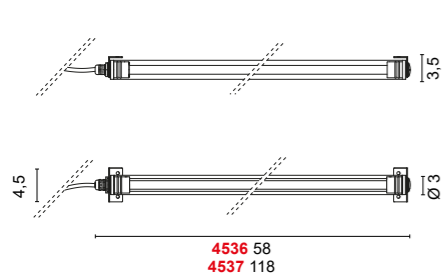

4536 Wanda
.33 Acciaio satinato - Matt steel
 Inox AISI 316L

Color temperature	LED Light source	lm source
/W 4000K	24V 7,5W	920lm
/WW 3000K	24V 7,5W	825lm
/XW 2700K	24V 7,5W	780lm

Versione ETL disponibile su richiesta
 ETL version available upon request

4537 Wanda
.33 Acciaio satinato - Matt steel
 Inox AISI 316L

Color temperature	LED Light source	lm source
/W 4000K	24V 16,5W	2024lm
/WW 3000K	24V 16,5W	1815lm
/XW 2700K	24V 16,5W	1716lm

Versione ETL disponibile su richiesta
 ETL version available upon request

WANDA RGB

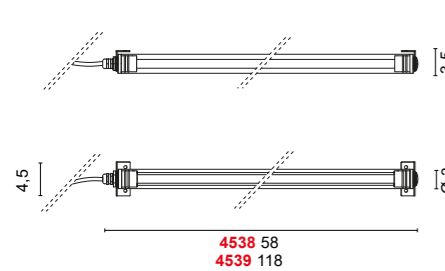

4538 Wanda RGB
.33 Acciaio satinato - Matt steel
 Inox AISI 316L

LED Light sources
 7,2W 24V

Versione ETL disponibile su richiesta
 ETL version available upon request

4539 Wanda RGB
.33 Acciaio satinato - Matt steel
 Inox AISI 316L

LED Light sources
 7,2W 24V

Versione ETL disponibile su richiesta
 ETL version available upon request



CUSTOM SIZE

Tabella lunghezze disponibili. Le misure si riferiscono alle lunghezze totali delle lampade.
 Table of available lengths. Measures are referred to complete fixtures including closing heads.

cm	watt	2700K (XW)	lm source	3000K (WW)	lm source	4000K (W)	lm source	RGB
18	1,5W	A4536.33/18/XW	156	A4536.33/18/WW	165	A4536.33/18/W	184	A4536.33/18RGB
28	3W	A4536.33/28/XW	312	A4536.33/28/WW	330	A4536.33/28/W	368	A4536.33/28RGB
38	4,5W	A4536.33/38/XW	468	A4536.33/38/WW	495	A4536.33/38/W	552	A4536.33/38RGB
48	6W	A4536.33/48/XW	624	A4536.33/48/WW	660	A4536.33/48/W	736	A4536.33/48RGB
58	7,5W	4536.33/XW *	780	4536.33/WW *	825	4536.33/W *	920	4538.33*
68	9W	A4536.33/68/XW	936	A4536.33/68/WW	990	A4536.33/68/W	1104	A4536.33/68RGB
78	10,5W	A4536.33/78/XW	1092	A4536.33/78/WW	1155	A4536.33/78/W	1288	A4536.33/78RGB
88	12W	A4536.33/88/XW	1248	A4536.33/88/WW	1320	A4536.33/88/W	1472	A4536.33/88RGB
98	13,5W	A4536.33/98/XW	1404	A4536.33/98/WW	1485	A4536.33/98/W	1656	A4536.33/98RGB
108	15W	A4536.33/108/XW	1560	A4536.33/108/WW	1650	A4536.33/108/W	1840	A4536.33/108RGB
118	16,5W	4537.33/XW *	1716	4537.33/WW *	1815	4537.33/W *	2024	4539.33*
128	18W	A4536.33/128/XW	1872	A4536.33/128/WW	1980	A4536.33/128/W	2208	A4536.33/128RGB
138	19,5W	A4536.33/138/XW	2028	A4536.33/138/WW	2145	A4536.33/138/W	2392	A4536.33/138RGB
148	21W	A4536.33/148/XW	2184	A4536.33/148/WW	2310	A4536.33/148/W	2576	A4536.33/148RGB
158	22,5W	A4536.33/158/XW	2340	A4536.33/158/WW	2475	A4536.33/158/W	2760	A4536.33/158RGB
168	24W	A4536.33/168/XW	2496	A4536.33/168/WW	2640	A4536.33/168/W	2944	A4536.33/168RGB
178	25,5W	A4536.33/178/XW	2652	A4536.33/178/WW	2805	A4536.33/178/W	3128	A4536.33/178RGB
188	27W	A4536.33/188/XW	2808	A4536.33/188/WW	2970	A4536.33/188/W	3312	A4536.33/188RGB
198	28,5W	A4536.33/198/XW	2964	A4536.33/198/WW	3135	A4536.33/198/W	3396	A4536.33/198RGB
208	30W	A4536.33/208/XW	3120	A4536.33/208/WW	3300	A4536.33/208/W	3680	A4536.33/208RGB
218	31,5W	A4536.33/218/XW	3276	A4536.33/218/WW	3465	A4536.33/218/W	3864	A4536.33/218RGB
228	33W	A4536.33/228/XW	3432	A4536.33/228/WW	3630	A4536.33/228/W	4048	A4536.33/228RGB
238	34,5W	A4536.33/238/XW	3588	A4536.33/238/WW	3795	A4536.33/238/W	4232	A4536.33/238RGB
248	36W	A4536.33/248/XW	3744	A4536.33/248/WW	3960	A4536.33/248/W	4416	A4536.33/248RGB
258	37,5W	A4536.33/258/XW	3900	A4536.33/258/WW	4125	A4536.33/258/W	4600	A4536.33/258RGB
268	39W	A4536.33/268/XW	4056	A4536.33/268/WW	4290	A4536.33/268/W	4784	A4536.33/268RGB
278	40,5W	A4536.33/278/XW	4212	A4536.33/278/WW	4455	A4536.33/278/W	4968	A4536.33/278RGB
288	42W	A4536.33/288/XW	4368	A4536.33/288/WW	4620	A4536.33/288/W	5152	A4536.33/288RGB
298	43,5W	A4536.33/298/XW	4524	A4536.33/298/WW	4785	A4536.33/298/W	5336	A4536.33/298RGB

* Articolo standard a catalogo - Standard catalogue item

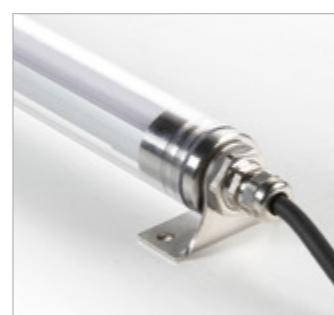

Drivers

Drivers ON/OFF						
Cod.	0155	0156	0160	0157	0161/100	0162
	24V-13W	24V-25W	24V-50W	24V-75W	24V-100W	24V-150W
IP67 drivers						
Cod.	0033/IP	0034/IP	0036/IP			
	24V-14,4W	24V-70W	24V-160W			
DIMMABLE drivers						
Cod.	0110/DIM	0717/DIM60/V	0717/DIM60	0717/DIM100		
	12/24V	24V-60W 1...10V	24V-60W PUSH - DALI	24V-100W 1...10V - PUSH - DALI		
RGB drivers						
Cod.	0164	0167	Driver RGB Casambi	0163	0165	0166
	120W	22W	0164/CASA	IR Sensor	IR Remote controller	Sinc Cable
	IN:230V - OUT: 3x24V		IN:230V - OUT: 3x24V			

Solo collegamento in parallelo - Only parallel connection

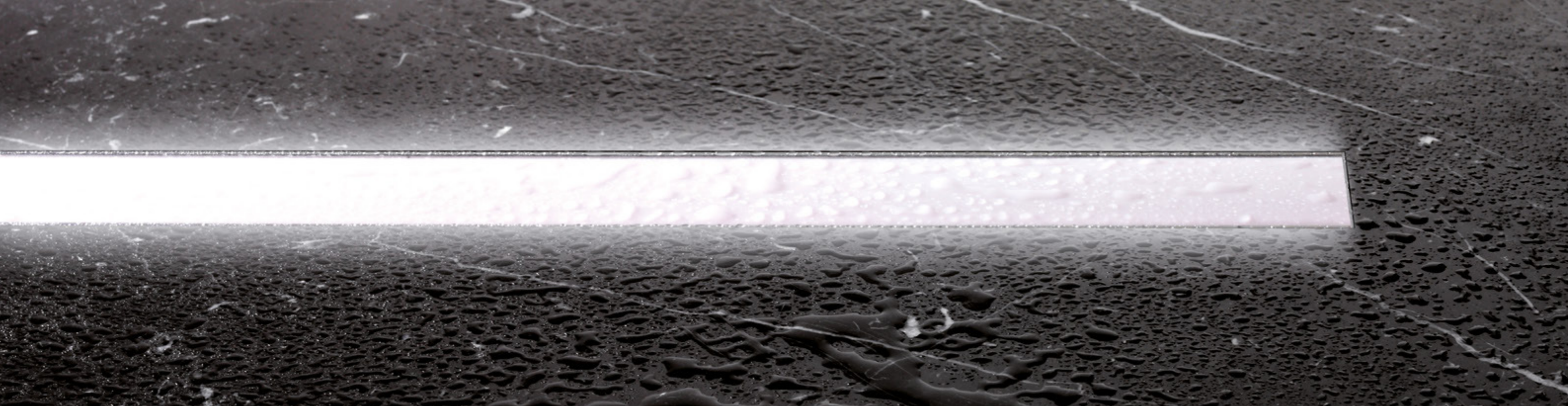

SPOOK design: U.T. EGOLUCE

Linea luminosa LED calpestabile IP67 in metacrilato coestruso trasparente ed opalino. Casseforme modulari in alluminio anodizzato (anodizzazione rinforzata per esterni). Installazione a pavimento o parete con possibilità di comporre linee luminose continue. Versione ETL disponibile su richiesta

LED linear trampleable IP67 in coextruded transparent and opal methacrylate. Modular anodized aluminium blind boxes (reinforced anodizing for outdoor). To be installed into floor or wall and possibility to compose endless light lines. ETL version available upon request

LED linéaire piétinable IP67 en méthacrylate coextrudé transparent et opale. Boîtes aveugles modulables en aluminium anodisé (anodisation renforcée pour l'extérieur). À installer au sol ou au mur et possibilité de composer des lignes lumineuses infinies. Version ETL disponible sur demande



Linea luminosa LED pisabile IP67 in metacrilato coestruso trasparente y opal. Cajetín modular en aluminio anodizado (anodización reforzada para exterior). Instalación a suelo o pared y posibilidad de realizar líneas luminosas continuas.

Begehbarer LED Einbaulinie IP67, Struktur aus transparentem und opalisierten fließgepresstem Methakrylat. Modularen Einbaugehäuse aus Aluminium (verstärktem Eloxierung für Außenbereich) für wand-oder Bodeneinsetzung. Montage als endlose Linearsystem möglich.

Светодиодный и встраиваемый в грунт профиль для пешеходных зон, степень защиты IP67, алюминий, прозрачный или матовый диффузор. Монтажный корпус из алюминия с усиленным анодированием для наружного использования. Для встраивания в пол или стену, можно составить бесконечную линию.

Outdoor



Outdoor

cm.	watt	3000K (WW)	lm source	4000K (W)	lm source
14	1W	A6417.01/14/WW	102	A6417.01/14/W	108
24	1,9W	A6417.01/24/WW	204	A6417.01/24/W	216
34	2,9W	A6417.01/34/WW	306	A6417.01/34/W	324
44	3,8W	A6417.01/44/WW	408	A6417.01/44/W	432
54	4,8W	6417.01/WW *	510	6417.01/W *	540
64	5,8W	A6417.01/64/WW	612	A6417.01/64/W	648
74	6,7W	A6417.01/74/WW	714	A6417.01/74/W	756
84	7,7W	A6417.01/84/WW	816	A6417.01/84/W	864
94	8,6W	A6417.01/94/WW	918	A6417.01/94/W	972
104	9,6W	6418.01/WW *	1020	6418.01/W *	1080
114	10,6W	A6417.01/114/WW	1122	A6417.01/114/W	1188
124	11,5W	A6417.01/124/WW	1224	A6417.01/124/W	1296
134	12,5W	A6417.01/134/WW	1326	A6417.01/134/W	1404
144	13,4W	A6417.01/144/WW	1428	A6417.01/144/W	1512
154	14,4W	6419.01/WW *	1530	6419.01/W *	1620

CUSTOM SIZE

Tabella lunghezze disponibili su richiesta.
Le misure si riferiscono alle lunghezze totali delle lampade.

Table of available lengths on request.
Measures are referred to complete fixtures including closing heads.

* Articolo standard a catalogo - Standard catalogue item

Drivers

Drivers ON/OFF						IP67 drivers			
Cod.	0155	0156	0160	0157	0161/100	0162	0033/IP	0034/IP	0036/IP
	24V-13W	24V-25W	24V-50W	24V-75W	24V-100W	24V-150W	24V-14,4W	24V-70W	24V-160W

DIMMABLE drivers				LED emergency unit
Cod.	0110/DIM	0717/DIM60/V	0717/DIM60	0115/EM
	12/24V	24V-60W 1...10V	24V-60W PUSH - DALI	Inverter + Battery + LED indicator

Solo collegamento in parallelo. - Only parallel connection.

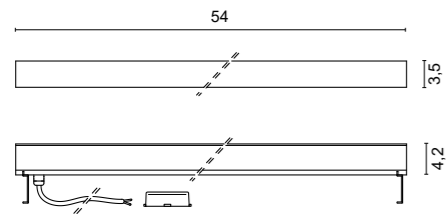

6417 Spook

.01 Bianco - White

Color temperature	LED Light source	lm source
/W 4000K	24V 4,5W	540lm
/WW 3000K	24V 4,5W	510lm



Versione ETL disponibile su richiesta
ETL version available upon request

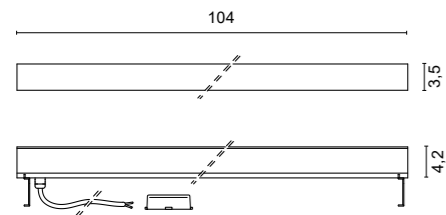

6418 Spook

.01 Bianco - White

Color temperature	LED Light source	lm source
/W 4000K	24V 8,9W	1080lm
/WW 3000K	24V 8,9W	1020lm



Versione ETL disponibile su richiesta
ETL version available upon request

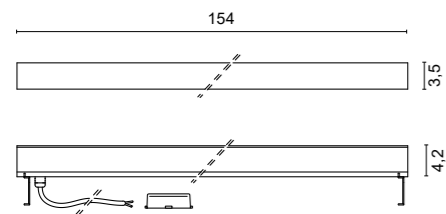

6419 Spook

.01 Bianco - White

Color temperature	LED Light source	lm source
/W 4000K	24V 13,4W	1620lm
/WW 3000K	24V 13,4W	1530lm



Versione ETL disponibile su richiesta
ETL version available upon request



Esempio di configurazione - Configuration example

Outdoor

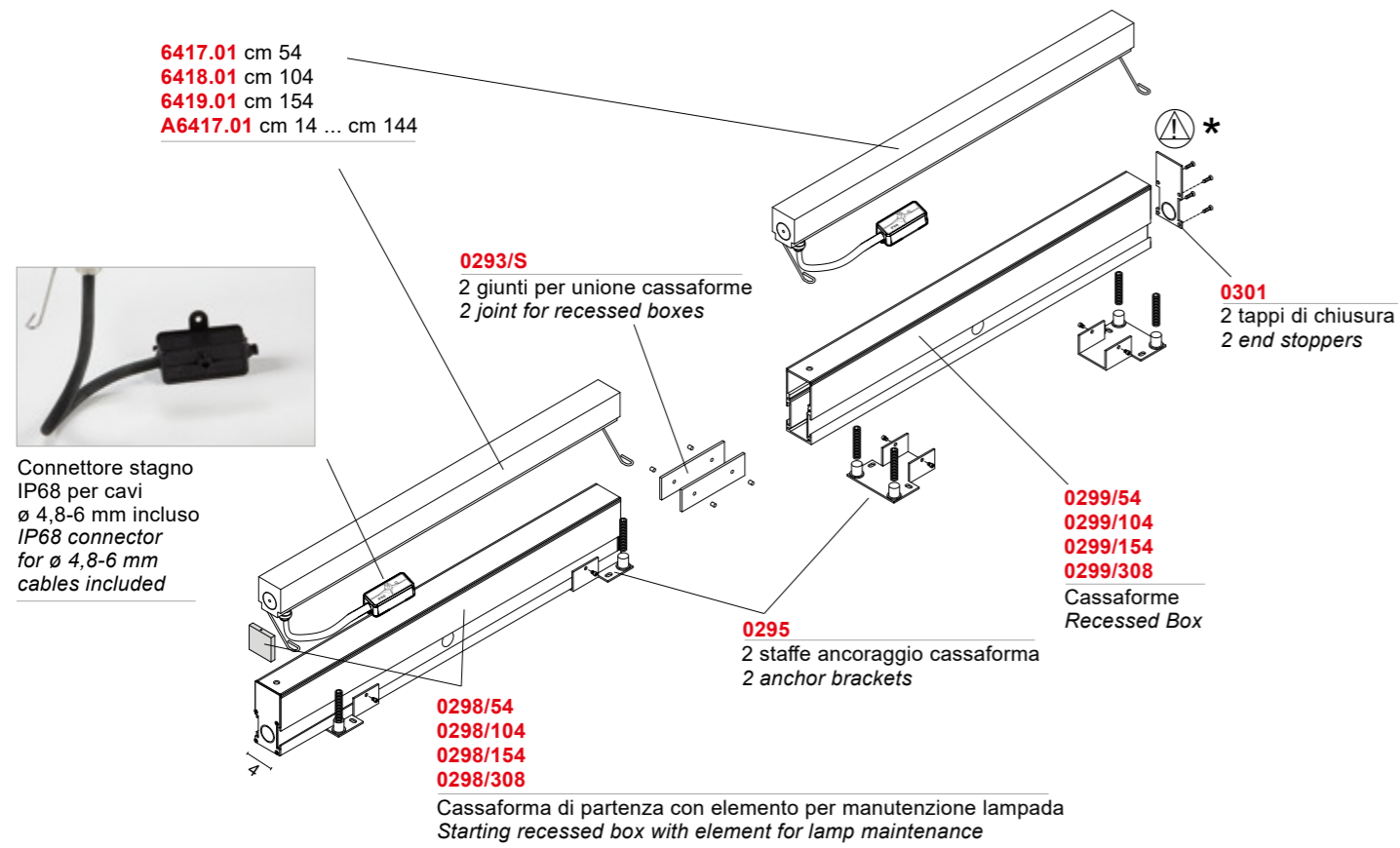

*Il tappo di chiusura è fornito con la cassaforma di partenza. The end stopper is included in the starting box.



Accessori - Accessories

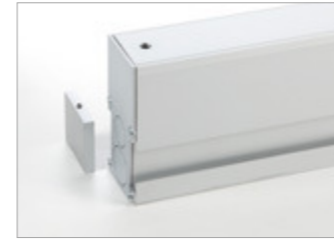

0298
 Cassaforma di partenza con tappi ed elemento per manutenzione lampada.
 Starting recessed box with caps and element for lamp maintenance.

/54	55,1 x 4 x 9 cm	0,9kg
/104	105,1 x 4 x 9 cm	1,7kg
/154	155,1 x 4 x 9 cm	2,6kg
/308	309,1 x 4 x 9 cm	5,7kg

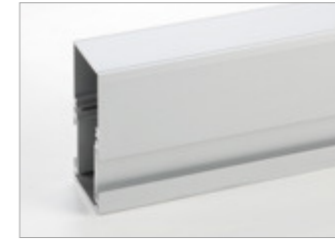

0299
 Cassaforma
 I tappi di chiusura sono forniti con la cassaforma di partenza.
 Recessed box
 The end stoppers are included in the starting box

/54	54,1 x 4 x 9 cm	0,8kg
/104	104,1 x 4 x 9 cm	1,6kg
/154	154,1 x 4 x 9 cm	2,5kg
/308	308,1 x 4 x 9 cm	5,6kg



0295
 2 staffe ancoraggio per cassaforma
 2 anchor brackets for recessed box



0293/S
 2 giunti per unione cassaforme
 2 joints for recessed box



0301
 2 tappi di chiusura per cassaforma
 2 end stoppers for recessed box

Outdoor





Outdoor

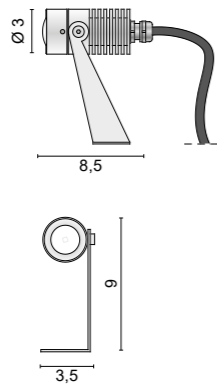

4510 Vision 1

.06	Verde - Green
.39	Verniciato antracite - Painted anthracite finishing
.45	Alluminio anodizzato - Anodized aluminium

Color temperature	Optics	LED Light source	lm source
/W 4000K	/11 /25 /45	max 1,5W 500mA	221lm
/WW 3000K	/11 /25 /45	max 1,5W 500mA	210lm
/XW 2700K	/11 /25 /45	max 1,5W 500mA	199lm

IP 67 150 cm

0,30 Kg

Versione ETL disponibile su richiesta
ETL version available upon request



Outdoor

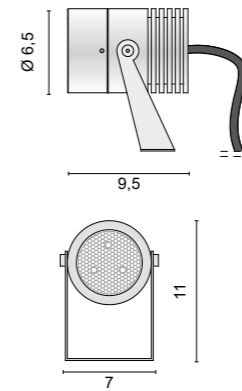

4511 Vision 3

.06	Verde - Green
.39	Verniciato antracite - Painted anthracite finishing
.45	Alluminio anodizzato - Anodized aluminium

Color temperature	Optics	LED Light source	lm source
/W 4000K	/10 /25	max 3x1,5W 500mA	663lm
/WW 3000K	/10 /25	max 3x1,5W 500mA	630lm
/XW 2700K	/10 /25	max 3x1,5W 500mA	597lm

IP 67 300 cm

0,9 Kg

Versione ETL disponibile su richiesta
ETL version available upon request

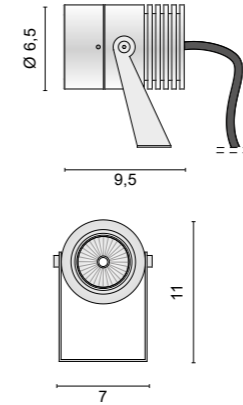

4555 Vision 3 COB

.06	Verde - Green
.39	Verniciato antracite - Painted anthracite finishing
.45	Alluminio anodizzato - Anodized aluminium

Color temperature	Optics	COB LED Light source	lm source
/W 4000K	/15 /25 /42	8,7W 17,5V 500mA	1466lm
/WW 3000K	/15 /25 /42	8,7W 17,5V 500mA	1424lm
/XW 2700K	/15 /25 /42	8,7W 17,5V 500mA	1340lm

IP 67 300 cm

0,9 Kg

Accessori - Accessories



0247
Picchetto
Stake



0243
Connettore stagno
IP Connector

Drivers

Cod.	Drivers ON/OFF			IP67 drivers		DIMMABLE drivers			
	0125	0128	0127	0031/IP	0143/IP	0141/DIM	0141/DALI	0145/DALI	0145
4510	350mA	350mA	500mA	350mA	500mA	PUSH - 1...10V	DIM DALI	DIM DALI	DIM
	1-6	1-10	1-6	1-12	1-7	1-11	1-11	1-21	1-21

Solo collegamento in serie - Only serial connection

Accessori - Accessories



0248
Picchetto
Stake



0243
Connettore stagno
IP Connector

Drivers

Cod.	Drivers ON/OFF				IP67 drivers		DIMMABLE drivers				LED emergency unit
	0125	0128	0127	0147/COB	0031/IP	0143/IP	0141/DIM	0141/DALI	0145/DALI	0145	0115/EM
4511	350mA	350mA	500mA	500mA	350mA	500mA	PUSH - 1...10V	DIM DALI	DIM DALI	DIM	Inverter + Battery + LED indicator
4555	NO	NO	NO	1-2	NO	1	1-3	1-3	1-7	1-7	NO
							1-2	1-2	1-3	1-3	1

Solo collegamento in serie - Only serial connection



ZEPPELIN design: U.T. EGOLUCE

Serie di faretti da incasso calpestabili (IP 67) con flangia in acciaio INOX AISI 316L, dissipatore in alluminio e cavo in neoprene da 30 cm. Disponibili in versioni tonde e quadrate. Montaggio con cassaforma o in cartongesso con apposito accessorio. Versione ETL disponibile a richiesta

Series of trampleable recessed spots (IP 67) with frame in stainless steel AISI 316L, heat sink in aluminum and neoprene cable 30 cm. Available in round and square versions. Mounting with recessed box or in plasterboards by means of a specific accessory. ETL version available upon request

Serie de spots encastrable piétinable (IP67). Cadre en acier INOX AISI316L et dissipateur en aluminium. Câble en néoprène de 30 cm. Verre de protection satiné. Montage avec boîte d'encastrement ou dans le placoplâtre avec accessoire spécifique. Version ETL disponible sur demande



Serie de focos pisables para empotrar (IP67) con brida en acero INOX AISI316L y dissipador de calor en aluminio. Cable de neopreno de 30 cm. Cristal de protección satinado. Montaje con cajetín o, en paneles de yeso, utilizando el accesorio específico.

Begehbarer Einbaustrahler (IP67). Rahme aus rostfreier Stahl AISI316L und Kuhlkörper aus Aluminium. Neopren Stromkabel 30 cm. inbegriffen. Satiniertem Schutzglas. Montage mit Einbaugeschäule oder im Gipskarton mit spezifischem Zubehör.

Встроенные светильники из нержавеющей стали марки AISI316L для пешеходных зон. IP67. С радиатором для отвода тепла и кабелем из неопрена 30 см. Круглые или квадратные. Монтируются с монтажной коробкой или в гипскартон с помощью специального аксессуара.



Outdoor

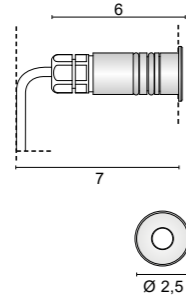

6730 Zeppelin mini tondo

.33 Acciaio satinato - *Matt steel*
Inox AISI 316L

Color temperature	LED Light source	lm source
/W 4000K	1W 350mA	158lm
/WW 3000K	1W 350mA	150lm
/XW 2700K	1W 350mA	143lm

IP67 30 cm 100 kg Tc: 40°C 0,05 Kg

2 cm

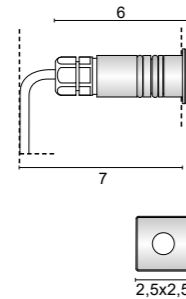

6731 Zeppelin mini quadro

.33 Acciaio satinato - *Matt steel*
Inox AISI 316L

Color temperature	LED Light source	lm source
/W 4000K	1W 350mA	158lm
/WW 3000K	1W 350mA	150lm
/XW 2700K	1W 350mA	143lm

IP67 30 cm 100 kg Tc: 40°C 0,06 Kg

2 cm



Molla per cartongesso inclusa
Spring for plasterboard included

2,2 cm

Accessori - Accessories



0215

Controcassa in materiale plastico
Plastic box



Drivers

Cod.	Drivers ON/OFF		IP67 drivers	DIMMABLE drivers			
	0125	0128	0031/IP	0141/DIM	0141/DALI	0145	0145/DALI
6730	350mA	350mA	350mA	PUSH - 1...10V	DIM DALI	DIM	DIM DALI
6731	1-6	1-12	1-10	1-12	1-12	1-21	1-21

Solo collegamento in serie - Only serial connection



Outdoor

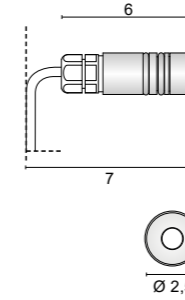

6732 Zeppelin plus mini tondo

.33 Acciaio satinato - *Matt steel*
Inox AISI 316L

Color temperature	Optics	LED Light source	lm source
/W 4000K	/11 /25 /45	1W 350mA	158lm
/WW 3000K	/11 /25 /45	1W 350mA	150lm
/XW 2700K	/11 /25 /45	1W 350mA	143lm

IP67 30 cm 100 kg Tc: 40°C 0,05 Kg

2 cm

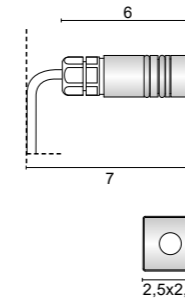

6733 Zeppelin plus mini quadro

.33 Acciaio satinato - *Matt steel*
Inox AISI 316L

Color temperature	Optics	LED Light source	lm source
/W 4000K	/11 /25 /45	1W 350mA	158lm
/WW 3000K	/11 /25 /45	1W 350mA	150lm
/XW 2700K	/11 /25 /45	1W 350mA	143lm

IP67 30 cm 100 kg Tc: 40°C 0,06 Kg

2 cm



Molla per cartongesso inclusa
Spring for plasterboard included

2,2 cm

Accessori - Accessories



0215

Controcassa in materiale plastico
Plastic box

Drivers

Cod.	Drivers ON/OFF		IP67 drivers	DIMMABLE drivers			
	0125	0128	0031/IP	0141/DIM	0141/DALI	0145	0145/DALI
6732	350mA	350mA	350mA	PUSH - 1...10V	DIM DALI	DIM	DIM DALI
6733	1-6	1-10	1-12	1-12	1-12	1-21	1-21

Solo collegamento in serie - Only serial connection



Outdoor

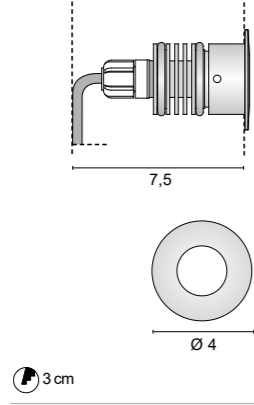

6348 Zeppelin tondo

.33 Acciaio satinato - Matt steel
Inox AISI 316L

Color temperature	LED Light source	lm source
/W 4000K	max 1,5W 500mA	221lm
/WW 3000K	max 1,5W 500mA	210lm
/XW 2700K	max 1,5W 500mA	199lm

IP67 30 cm 500 kg Tc:40°C 73° 0,08 Kg

Versione ETL disponibile su richiesta
ETL version available upon request



Outdoor

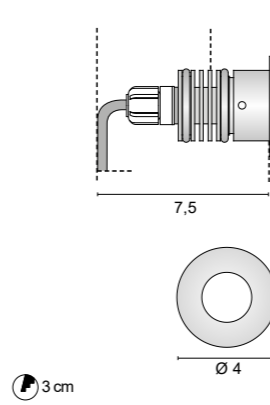

6376 Zeppelin RGB tondo

.33 Acciaio satinato - Matt steel
Inox AISI 316L

LED Light sources
3x250mA

IP67 30 cm 500 kg Tc:40°C 73° 0,2 Kg

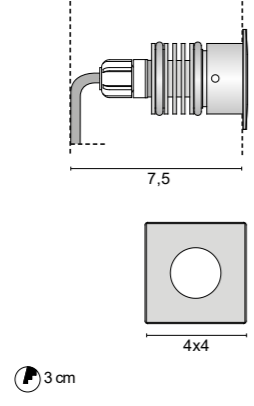

6349 Zeppelin quadro

.33 Acciaio satinato - Matt steel
Inox AISI 316L

Color temperature	LED Light source	lm source
/W 4000K	max 1,5W 500mA	221lm
/WW 3000K	max 1,5W 500mA	210lm
/XW 2700K	max 1,5W 500mA	199lm

IP67 30 cm 500 kg Tc:40°C 73° 0,10 Kg

Versione ETL disponibile su richiesta
ETL version available upon request

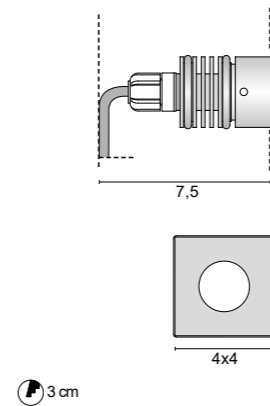

6395 Zeppelin RGB quadro

.33 Acciaio satinato - Matt steel
Inox AISI 316L

LED Light sources
3x250mA

IP67 30 cm 500 kg Tc:40°C 73° 0,2 Kg



Molla per cartongesso inclusa
Spring for plasterboard included

3,2 cm



Molla per cartongesso inclusa
Spring for plasterboard included

3,2 cm

Accessori - Accessories



0216
Controcassa in materiale plastico
Plastic box



0220
KIT: cassaforma drenante + Connettore IP
KIT: draining junction + IP connector



Accessori - Accessories



0216
Controcassa in materiale plastico
Plastic box



0228
Cassaforma drenante
Draining junction

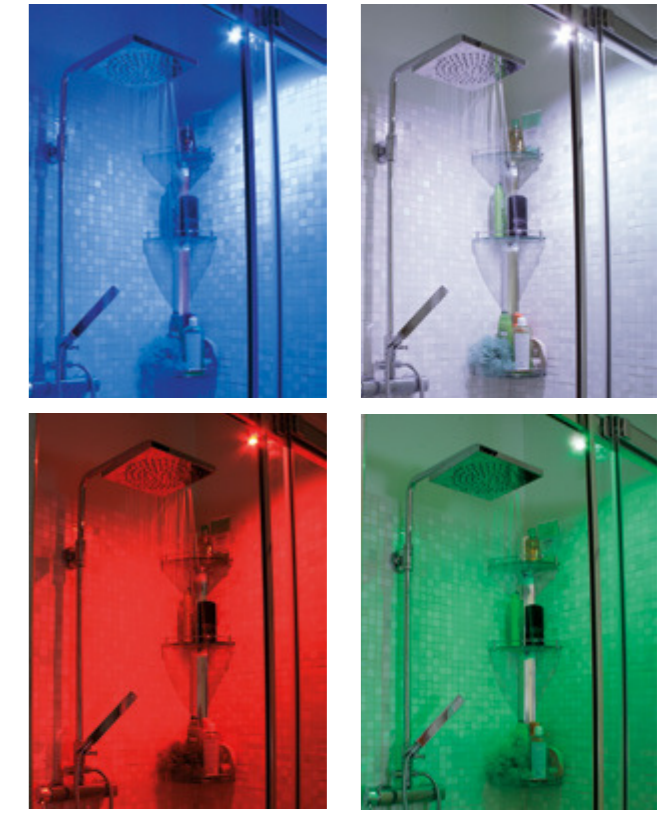

Drivers

Cod.	Drivers ON/OFF			IP67 drivers		DIMMABLE drivers			
	0125	0128	0127	0031/IP	0143/IP	0141/DIM	0141/DALI	0145/DALI	0145
	350mA	350mA	500mA	350mA	500mA	PUSH - 1...10V	DIM DALI	DIM DALI	DIM
6348	1-6	1-10	1-6	1-12	1-7	1-11	1-11	1-21	1-21
6349	1-6	1-10	1-6	1-12	1-7	1-11	1-11	1-21	1-21

Solo collegamento in serie - Only serial connection

Drivers

Drivers RGB		Driver RGB Casambi	Converter RGB		
0164	0167	0164/CASA	0168	0163	0165
120W	22W	120W	IN:24V - OUT: 3x250 mA 1-5 Zeppelin RGB	IR Sensor	IR Remote controller
IN:230V - OUT: 3x24V		IN:230V - OUT: 3x24V			0166 Sinc Cable

Solo collegamento in serie - Only serial connection



Outdoor

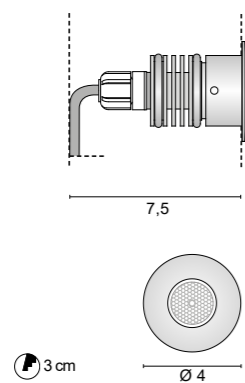

6384 Zeppelin Plus Tondo 25

.33 Acciaio satinato - Matt steel
Inox AISI 316L

Color temperature	Optics	LED Light source	lm source
/W 4000K	/11 /25 /45	max 1,5W 500mA	221lm
/WW 3000K	/11 /25 /45	max 1,5W 500mA	210lm
/XW 2700K	/11 /25 /45	max 1,5W 500mA	199lm



0,08 Kg

Versione ETL disponibile su richiesta
ETL version available upon request

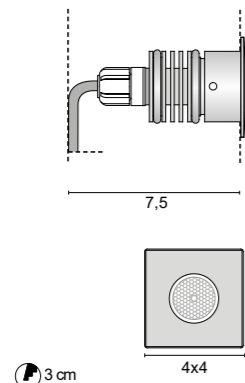

6394 Zeppelin Plus Quadro 25

.33 Acciaio satinato - Matt steel
Inox AISI 316L

Color temperature	Optics	LED Light source	lm source
/W 4000K	/11 /25 /45	max 1,5W 500mA	221lm
/WW 3000K	/11 /25 /45	max 1,5W 500mA	210lm
/XW 2700K	/11 /25 /45	max 1,5W 500mA	199lm



0,10 Kg

Versione ETL disponibile su richiesta
ETL version available upon request



Molla per cartongesso inclusa
Spring for plasterboard included

3,2 cm

Accessori - Accessories



0216
Controcassa in materiale plastico
Plastic box



0220
KIT: cassaforma drenante + Connettore IP
KIT: draining junction + IP connector

Drivers

Cod.	Drivers ON/OFF			IP67 drivers		DIMMABLE drivers			
	0125	0128	0127	0031/IP	0143/IP	0141/DIM	0141/DALI	0145/DALI	0145
	350mA	350mA	500mA	350mA	500mA	PUSH - 1...10V	DIM DALI	DIM DALI	DIM
6384	1-6	1-10	1-6	1-12	1-7	1-11	1-11	1-21	1-21
6394	1-6	1-10	1-6	1-12	1-7	1-11	1-11	1-21	1-21

Solo collegamento in serie - Only serial connection



Outdoor



Outdoor

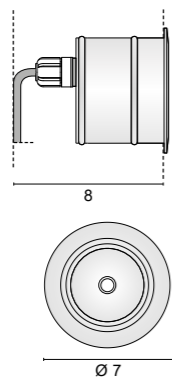

6 cm

6397 Zeppelin Maxi COB Tondo

.33 Acciaio satinato - Matt steel
Inox AISI 316L

Color temperature	Optics	COB LED Light source	lm source
<i>/W</i> 4000K	<i>/15 /28 /60</i>	8,7W 17,5V 500mA	1466lm
<i>/WW</i> 3000K	<i>/15 /28 /60</i>	8,7W 17,5V 500mA	1424lm
<i>/XW</i> 2700K	<i>/15 /28 /60</i>	8,7W 17,5V 500mA	1340lm



0,40 Kg

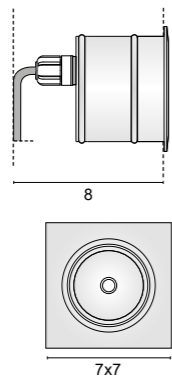

6 cm

6741 Zeppelin Maxi COB Quadro

.33 Acciaio satinato - Matt steel
Inox AISI 316L

Color temperature	Optics	COB LED Light source	lm source
<i>/W</i> 4000K	<i>/15 /28 /60</i>	8,7W 17,5V 500mA	1466lm
<i>/WW</i> 3000K	<i>/15 /28 /60</i>	8,7W 17,5V 500mA	1424lm
<i>/XW</i> 2700K	<i>/15 /28 /60</i>	8,7W 17,5V 500mA	1340lm



0,35 Kg

Accessori - Accessories



0230
KIT: cassaforma drenante + Connettore IP
KIT: draining junction + IP connector



0260/C
Molla per installazione in cartongesso
Spring for plasterboard



Drivers

Cod.	Drivers ON/OFF	IP67 drivers	DIMMABLE drivers			
			0141/DIM	0141/DALI	0145/DALI	0145
	500mA	500mA	PUSH - 1...10V	DIM DALI	DIM DALI	DIM
6397	1-2	1	1-2	1-2	1-3	1-3
6740	1-2	1	1-2	1-2	1-3	1-3

Solo collegamento in serie - Only serial connection



Outdoor

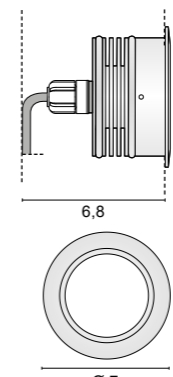

6 cm

6736 Zeppelin Maxi Tondo

.33 Acciaio satinato - Matt steel
Inox AISI 316L

Color temperature	LED Light source	lm source
<i>/W</i> 4000K	24V 4W	658m
<i>/WW</i> 3000K	24V 4W	608lm
<i>/XW</i> 2700K	24V 4W	562lm



0,40 Kg

Solo collegamento in parallelo
Only parallel connection

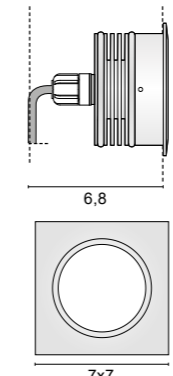
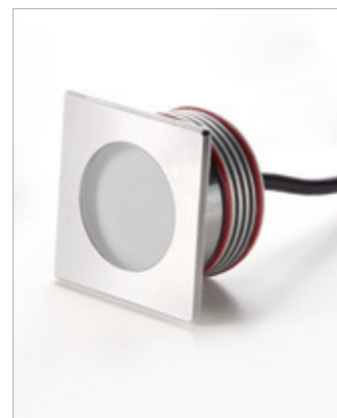

6 cm

6737 Zeppelin Maxi Quadro

.33 Acciaio satinato - Matt steel
Inox AISI 316L

Color temperature	LED Light source	lm source
<i>/W</i> 4000K	24V 4W	658m
<i>/WW</i> 3000K	24V 4W	608lm
<i>/XW</i> 2700K	24V 4W	562lm



0,35 Kg

Solo collegamento in parallelo
Only parallel connection

Accessori - Accessories



0230
KIT: cassaforma drenante + Connettore IP
KIT: draining junction + IP connector



0232
Cassaforma da parete
Wall plastic box



0260
Molla per installazione in cartongesso
Spring for plasterboard



Drivers

Cod.	Drivers ON/OFF		DIMMABLE drivers		IP67 drivers	
			0717/DIM60/V	00717/DIM60	0033/IP	0037/IP
	24V - 13W	24V - 25W	1...10V	DALI - PUSH	24V - 14,4W	24V - 60W
6736	1-2	1-4	1-10	1-10	1-2	1-10
6737	1-2	1-4	1-10	1-10	1-2	1-10

Solo collegamento in parallelo - Only parallel connection



Outdoor

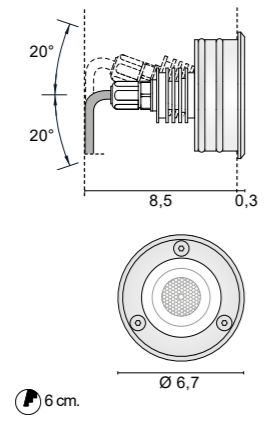

6411 Zeppelin Adjustable

.33 Acciaio satinato - Matt steel
Inox AISI 316L

Color temperature	Optics	LED Light source	lm source
/W 4000K	/11 /25 /45	max 1,5W 500mA	221lm
/WW 3000K	/11 /25 /45	max 1,5W 500mA	210lm
/XW 2700K	/11 /25 /45	max 1,5W 500mA	199lm



0,40 Kg

Versione ETL disponibile su richiesta
ETL version available upon request

6 cm.

Ø 6,7



Outdoor

Accessori - Accessories



0230
KIT: cassaforma drenante + Connettore IP
KIT: draining junction + IP connector



0232
Cassaforma da parete
Wall plastic box



0238
Molla per installazione in cartongesso
Spring for plasterboard

Drivers

Cod.	Drivers ON/OFF			IP67 drivers		DIMMABLE drivers			
	0125	0128	0127	0031/IP	0143/IP	0141/DIM	0141/DALI	0145/DALI	0145
	350mA	350mA	500mA	350mA	500mA	PUSH - 1...10V	DIM DALI	DIM DALI	DIM
6411	1-6	1-10	1-6	1-12	1-7	1-11	1-11	1-21	1-21

Solo collegamento in serie - Only serial connection



Outdoor

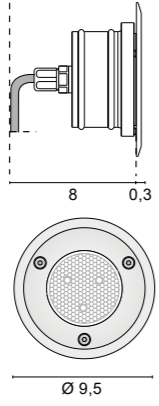

6371 Tris

.33 Acciaio satinato - Matt steel
Inox AISI 316L

Color temperature	Optics	LED Light source	lm source
/W 4000K	/10 /25	max 3x1,5W 500mA	663lm
/WW 3000K	/10 /25	max 3x1,5W 500mA	630lm
/XW 2700K	/10 /25	max 3x1,5W 500mA	597lm



0,40 Kg

Versione ETL disponibile su richiesta
ETL version available upon request

8,5 cm

Ø 9,5



Accessori - Accessories



0231
KIT: cassaforma drenante + Conettore IP
KIT: draining junction + IP connector



0235
Cassaforma da parete
Wall plastic box



0243
Connettore stagno
IP Connector



0233
Molla per installazione in cartongesso
Spring for plasterboard

Drivers

	Drivers ON/OFF			IP67 drivers		DIMMABLE drivers			
Cod.	0125	0128	0127	0031/IP	0143/IP	0141/DIM	0141/DALI	0145/DALI	0145
	350mA	350mA	500mA	350mA	500mA	PUSH - 1...10V	DIM DALI	DIM DALI	DIM
6371	1-2	1-3	1-2	1-3	1-2	1-3	1-3	1-7	1-7

Solo collegamento in serie - Only serial connection



Outdoor

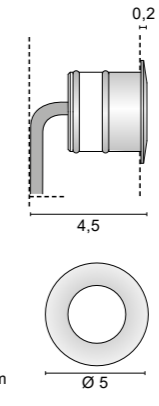

6388 Soft

.33 Acciaio satinato - Matt steel
Inox AISI 316L

Color temperature	LED Light source
/W 4000K	12V 1,5W
/WW 3000K	12V 1,5W



0,11 Kg

Solo collegamento in parallelo
Only parallel connection

3,8 cm

Ø 5



Accessori - Accessories



0217
Controcassa in materiale plastico
Plastic box



0250
KIT: cassaforma drenante + Conettore IP
KIT: draining junction + IP connector

Drivers

	Drivers ON/OFF		IP67 drivers	DIMMABLE drivers	
Cod.	0159	0159	0036/IP	0129	0129/DALI
	12V - 25W	12V - 25W	12V - 14,4W	Multi power dimmable driver	Multi power DALI dimmable driver
6388	1-15	1-15	1-8	1-6	1-6

Solo collegamento in parallelo - Only parallel connection



Outdoor

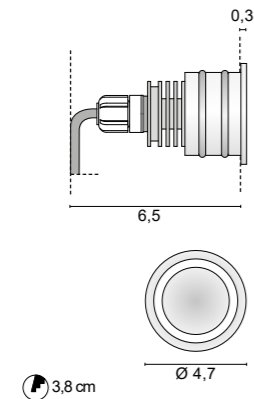

6389 Cerchio

.33 Acciaio satinato - Matt steel
Inox AISI 316L

Color temperature	LED Light sources	lm source
/B	LED BLU max 1W 350mA	
/W	4000K max 1,5W 500mA	221lm
/WW	3000K max 1,5W 500mA	210lm
/XW	2700K max 1,5W 500mA	199lm

IP67 30 cm 500 kg Tc: 40°C 0,20 Kg

Versione ETL disponibile su richiesta
ETL version available upon request

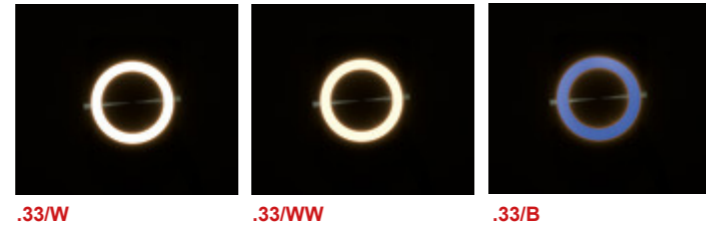

Accessori - Accessories



0217
Controcassa in materiale plastico
Plastic box



0250
KIT: cassaforma drenante + Connettore IP
KIT: draining junction + IP connector

Drivers

Cod.	Drivers ON/OFF			IP67 drivers		DIMMABLE drivers			
	0125 350mA	0128 350mA	0127 500mA	0031/IP 350mA	0143/IP 500mA	0141/DIM PUSH - 1...10V	0141/DALI DIM DALI	0145/DALI DIM DALI	0145 DIM
6389	1-6	1-10	1-6	1-10	1-7	1-11	1-11	1-21	1-21

Solo collegamento in serie - Only serial connection



Outdoor

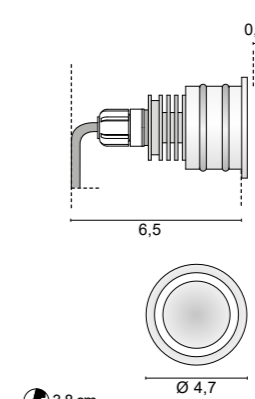

6390 Cerchio RGB

.33 Acciaio satinato - Matt steel
Inox AISI 316L

LED Light source
3x250mA

IP67 100 cm 500 kg Tc: 40°C 0,30 Kg



Accessori - Accessories



0217
Controcassa in materiale plastico
Plastic box



0251
Cassaforma drenante
Draining junction

Drivers

Drivers RGB		Driver RGB Casambi	Converter RGB			
0164 120W	0167 22W	0164/CASA 120W	0168 IN:24V - OUT: 3x250 mA 1-5 Cerchio RGB	0163 IR Sensor	0165 IR Remote controller	0166 Sinc Cable
IN:230V - OUT: 3x24V		IN:230V - OUT: 3x24V				

Solo collegamento in serie - Only serial connection

STEP TONDO

Outdoor

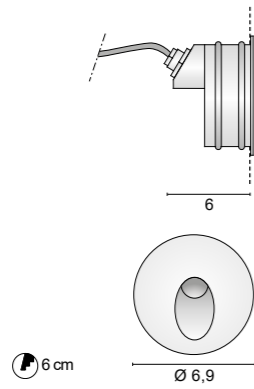

6387 Step Tondo

.01 Bianco - White
.45 Alluminio anodizzato - Anodized aluminium

Color temperature	LED Light source	lm source
/W 4000K	1,5W 500mA	221lm
/WW 3000K	1,5W 500mA	210lm
/XW 2700K	1,5W 500mA	199lm



0,24 Kg

Versione ETL disponibile su richiesta
ETL version available upon request

STEP MINI TONDO

Outdoor

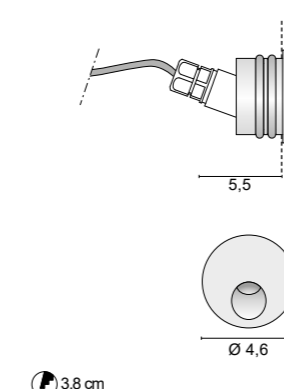

6738 Step Mini Tondo

.01 Bianco - White
.45 Alluminio anodizzato - Anodized aluminium

Color temperature	LED Light source	lm source
/W 4000K	1W 350mA	158lm
/WW 3000K	1W 350mA	150lm
/XW 2700K	1W 350mA	143lm

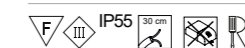

0,24 Kg

STEP QUADRO

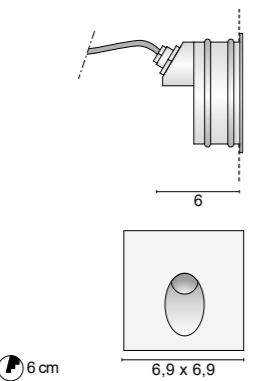

6369 Step Quadro

.01 Bianco - White
.45 Alluminio anodizzato - Anodized aluminium

Color temperature	LED Light source	lm source
/W 4000K	1,5W 500mA	221lm
/WW 3000K	1,5W 500mA	210lm
/XW 2700K	1,5W 500mA	199lm



0,24 Kg

Versione ETL disponibile su richiesta
ETL version available upon request

STEP MINI QUADRO

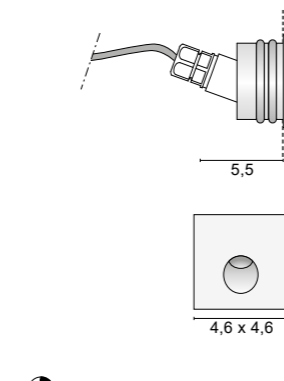

6739 Step Mini Quadro

.01 Bianco - White
.45 Alluminio anodizzato - Anodized aluminium

Color temperature	LED Light source	lm source
/W 4000K	1W 350mA	158lm
/WW 3000K	1W 350mA	150lm
/XW 2700K	1W 350mA	143lm



0,24 Kg

Accessori - Accessories



0232
Cassaforma da parete
Wall plastic box



Accessori - Accessories



0214
KIT: box + Plaster



0217
Controcassa in materiale plastico
Plastic box

Drivers

Cod.	Drivers ON/OFF			IP67 drivers		DIMMABLE drivers			
	0125 350mA	0128 350mA	0127 500mA	0031/IP 350mA	0143/IP 500mA	0141/DIM PUSH - 1...10V	0141/DALI DIM DALI	0145/DALI DIM DALI	0145 DIM
6387	1-6	1-10	1-6	1-10	1-7	1-11	1-11	1-21	1-21
6369	1-6	1-10	1-6	1-10	1-7	1-11	1-11	1-21	1-21

Solo collegamento in serie - Only serial connection

Drivers

Cod.	Drivers ON/OFF		IP67 drivers	DIMMABLE drivers			
	0125 350mA	0128 350mA	0031/IP 350mA	0141/DIM PUSH - 1...10V	0141/DALI DIM DALI	0145 DIM	0145/DALI DIM DALI
6738	1-6	1-10	1-12	1-12	1-12	1-21	1-21
6739	1-6	1-10	1-12	1-12	1-12	1-21	1-21

Solo collegamento in serie - Only serial connection

Outdoor

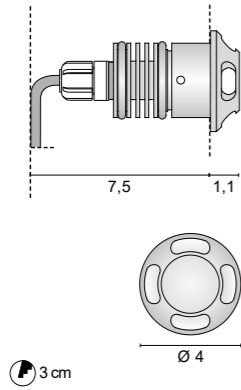

6361 Kross

.33 Acciaio satinato - Matt steel
Inox AISI 316L

Color temperature	LED Light source	lm source
/B LED BLU	1W 350mA	
/W 4000K	max 1,5W 500mA	221lm
/WW 3000K	max 1,5W 500mA	210lm
/XW 2700K	max 1,5W 500mA	199lm

IP67 30 cm 500 Kg Tc:40°C 0,10 Kg

Versione ETL disponibile su richiesta
ETL version available upon request



Molla per cartongesso inclusa
Spring for plasterboard included
3,2 cm

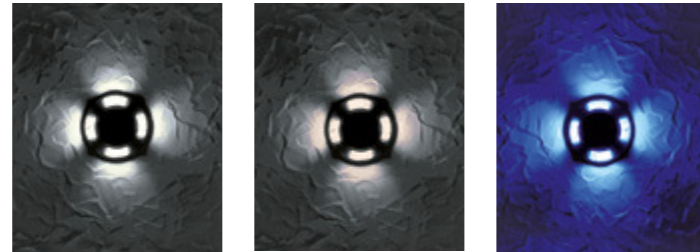

.33/W **.33/WW** **.33/B**

Accessori - Accessories



0216
Controcassa in materiale plastico
Plastic box



0220
KIT: cassaforma drenante + Connettore IP
KIT: draining junction + IP connector



Drivers

Cod.	Drivers ON/OFF			IP67 drivers		DIMMABLE drivers			
	0125	0128	0127	0031/IP	0143/IP	0141/DIM	0141/DALI	0145/DALI	0145
	350mA	350mA	500mA	350mA	500mA	PUSH - 1...10V	DIM DALI	DIM DALI	DIM
6361	1-6	1-10	1-6	1-12	1-7	1-11	1-11	1-21	1-21

Solo collegamento in serie - Only serial connection

Outdoor

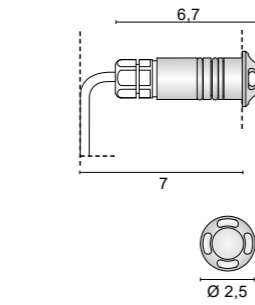

6735 Kross mini

.33 Acciaio satinato - Matt steel
Inox AISI 316L

Color temperature	LED Light source	lm source
/W 4000K	1W 350mA	158lm
/WW 3000K	1W 350mA	150lm
/XW 2700K	1W 350mA	143lm

IP67 30 cm 500 Kg Tc:40°C 0,07 Kg



Molla per cartongesso inclusa
Spring for plasterboard included
2,2 cm

Accessori - Accessories



0215
Controcassa in materiale plastico
Plastic box

Drivers

Cod.	Drivers ON/OFF		IP67 drivers	DIMMABLE drivers			
	0125	0128	0031/IP	0141/DIM	0141/DALI	0145	0145/DALI
	350mA	350mA	350mA	PUSH - 1...10V	DIM DALI	DIM	DIM DALI
6734	1-6	1-10	1-12	1-12	1-12	1-21	1-21

Solo collegamento in serie - Only serial connection



Outdoor

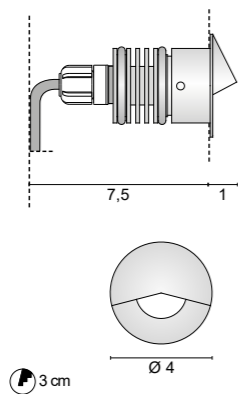

6362 Vista
 .33 Acciaio satinato - Matt steel
 Inox AISI 316L

Color temperature	LED Light source	lm source
/W 4000K	max 1,5W 500mA	221lm
/WW 3000K	max 1,5W 500mA	210lm
/XW 2700K	max 1,5W 500mA	199lm

IP67 30 cm Tc:40°C 500 kg 0,10 Kg

Versione ETL disponibile su richiesta
 ETL version available upon request



Molla per cartongesso inclusa
 Spring for plasterboard included

3,2 cm



Accessori - Accessories



0216
 Controcassa in materiale plastico
 Plastic box



0220
 KIT: cassaforma drenante + Connettore IP
 KIT: draining junction + IP connector

Drivers

Cod.	Drivers ON/OFF			IP67 drivers		DIMMABLE drivers			
	0125 350mA	0128 350mA	0127 500mA	0031/IP 350mA	0143/IP 500mA	0141/DIM PUSH - 1...10V	0141/DALI DIM DALI	0145/DALI DIM DALI	0145 DIM
6362	1-6	1-10	1-6	1-12	1-7	1-11	1-11	1-21	1-21

Solo collegamento in serie - Only serial connection



Outdoor

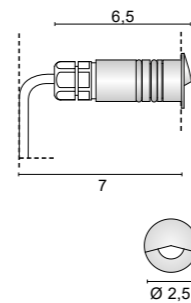

6734 Vista mini
 .33 Acciaio satinato - Matt steel
 Inox AISI 316L

Color temperature	LED Light source	lm source
/W 4000K	1W 350mA	158lm
/WW 3000K	1W 350mA	150lm
/XW 2700K	1W 350mA	143lm

IP67 30 cm Tc:40°C 500 kg 0,07 Kg



Molla per cartongesso inclusa
 Spring for plasterboard included

2,2 cm



Accessori - Accessories



0215
 Controcassa in materiale plastico
 Plastic box

Drivers

Cod.	Drivers ON/OFF		IP67 drivers	DIMMABLE drivers			
	0125 350mA	0128 350mA	0031/IP 350mA	0141/DIM PUSH - 1...10V	0141/DALI DIM DALI	0145 DIM	0145/DALI DIM DALI
6347	1-6	1-10	1-12	1-12	1-12	1-21	1-21

Solo collegamento in serie - Only serial connection

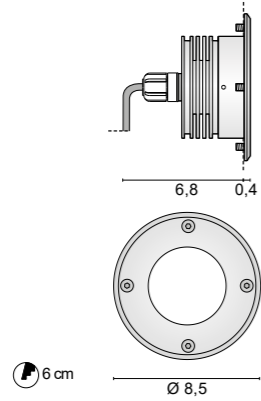

6729 Drive

.33 Acciaio satinato - Matt steel
Inox AISI 316L

Color temperature	LED Light source	lm source
/W 4000K	24V 4W	658lm
/WW 3000K	24V 4W	608lm
/XW 2700K	24V 4W	562lm

IP 67 0,40 Kg

Solo collegamento in parallelo
Only parallel connection

Faretto carrabile 2000Kg. Driveover recessed spot 2000Kg



Accessori - Accessories



0229

KIT: cassaforma drenante + Conettore IP
KIT: draining junction + IP connector

Drivers

Cod.	Drivers ON/OFF		DIMMABLE drivers		IP67 drivers	
	0155	0156	0717/DIM60/V	00717/DIM60	0033/IP	0037/IP
	24V - 13W	24V - 25W	1...10V	DALI - PUSH	24V - 14,4W	24V - 60W
6729	1-2	1-4	1-10	1-10	1-2	1-10

Solo collegamento in parallelo - Only parallel connection

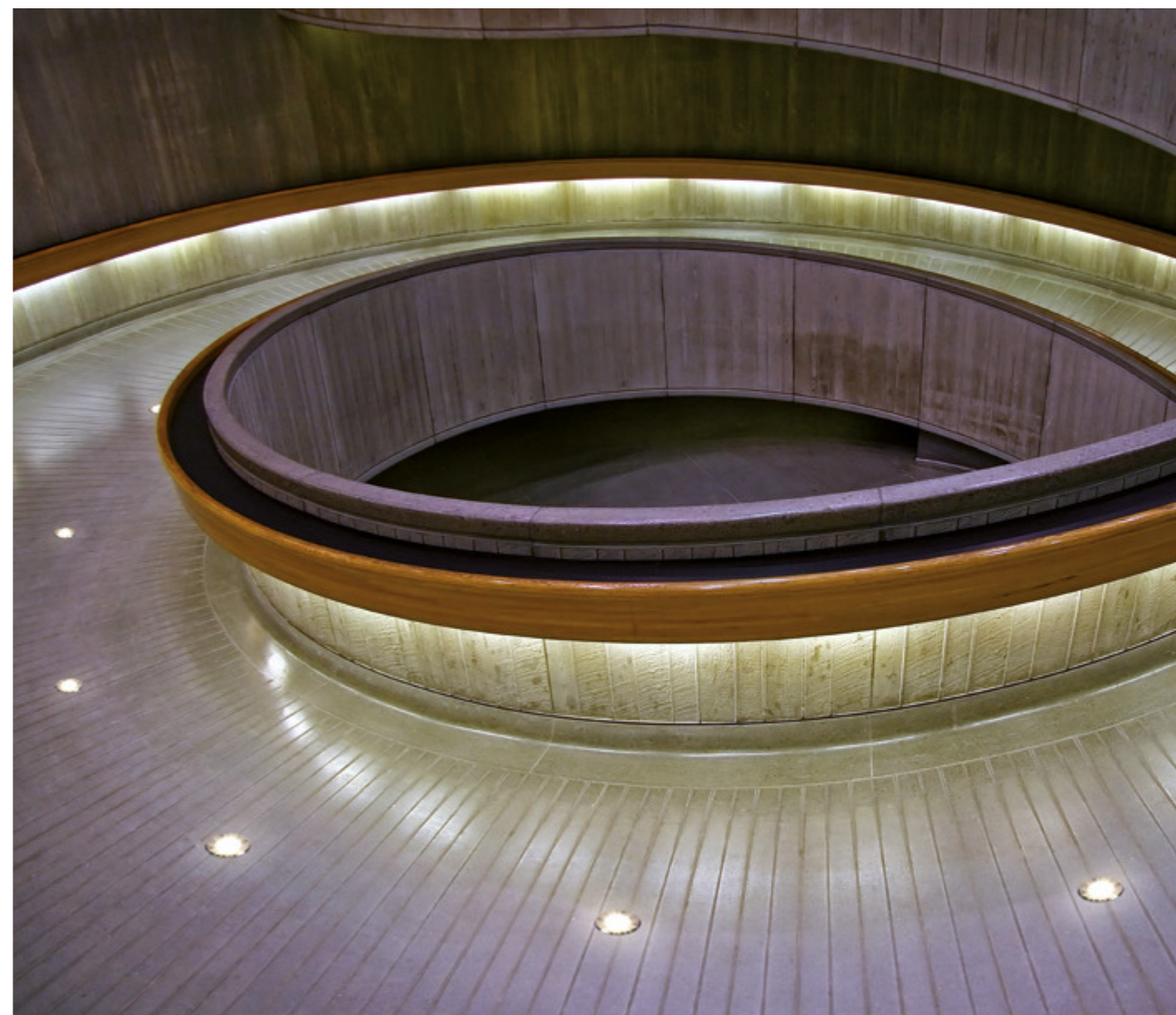



Outdoor

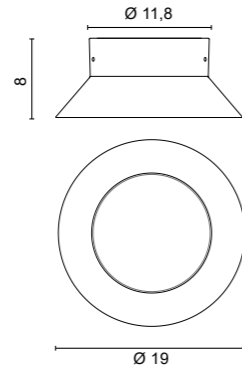

5538 Jazz

.01	Bianco - White
.02	Nero - Black
.38	Ramato lucido - Shiny copper

Color temperature	LED Light source	lm source
/WW 3000K	8,7W	670lm

IP 65 0,60 Kg



Outdoor

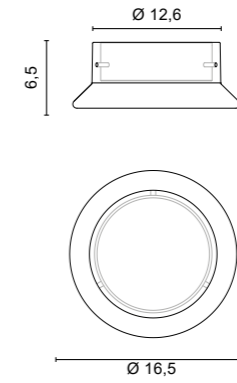

5539 Roc

.01	Bianco - White
-----	----------------

Color temperature	LED Light source	lm source
/WW 3000K	8,7W	670lm

IP 65 1,50 Kg





Outdoor

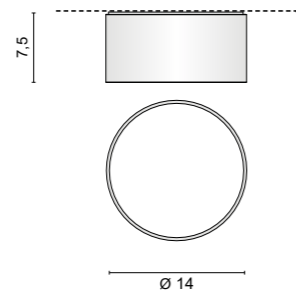

5520 Drum

.01	Bianco - White
.45	Alluminio anodizzato - Anodized aluminium

Color temperature	LED Light source	lm source
WW 3000K	10W	850lm

IP 65

1,30 Kg



Outdoor

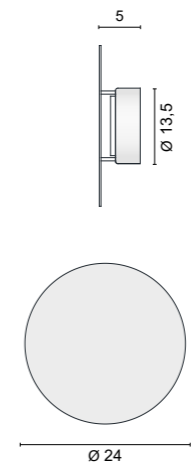

4625 Eclipse IP

.01	Bianco - White
.34	Verniciato corten Painted corten finishing
.39	Verniciato antracite Painted anthracite finishing

Color temperature	LED Light source	lm source
WW 3000K	8,7W	670lm

IP 65

1,50 Kg

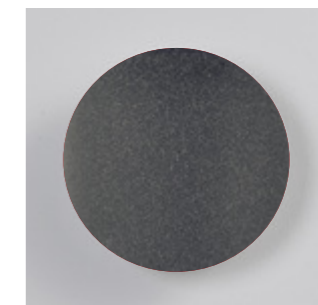
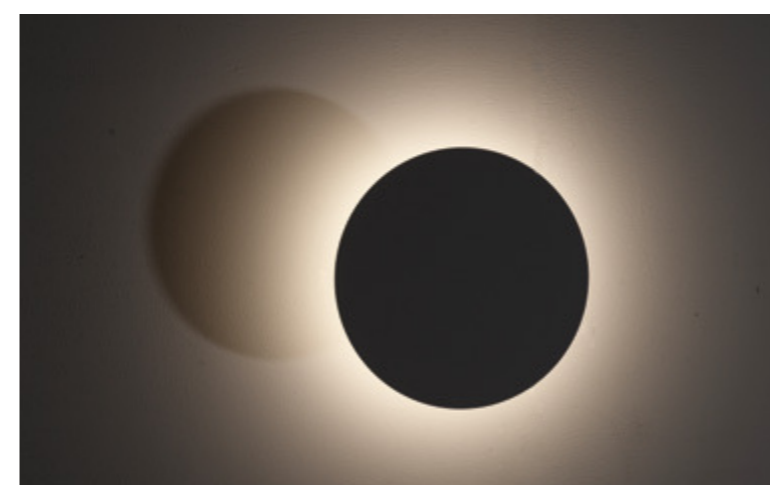

	<i>pag.</i>
DIMMERAZIONE 1...10V & PUSH PER COB E POWER LED	352
DIMMERAZIONE DALI COB E POWER LED	354
DIMMERAZIONE 12V/24V/48V PER LED STRIP E TRACK 48V	356
DIMMERAZIONE 24V PER LED STRIP	358
CONTROLLO RGB SMALL 22W	360
CONTROLLO RGB BIG 120W	362
CONTROLLO RGB PER LED STRIP SMALL 22W	364
CONTROLLO RGB PER LED STRIP SMALL BIG 120W	366
INTERFACCIA DMX	368
CONVERTITORE TENSIONE - CORRENTE COSTANTE PER COB LED	370
MODULO LED 24V	371
CONTROLLO EMERGENZA LED	372
CASAMBI	374
CONTROLLO RGB CASAMBI 120W	301
DRIVER CASAMBI IN CORRENTE 230V	376
ADATTATORI CASAMBI PER BINARI 230V	377

I nostri LED di potenza devono essere alimentati a bassa tensione SOLO con corrente continua e collegati IN SERIE. I nostri alimentatori sono predisposti per questo collegamento.

Our power LED must be powered ONLY with low voltage direct current ONLY IN SERIAL CONNECTION. Our converters are predisposed for this kind of connection.

Nos LED haute puissance doivent être alimentés SEULEMENT en courant direct en baisse tension et installés EN SERIE. Nos alimentateurs sont prévus pour cette liaison.

Nuestros LED de potencia se deben alimentar con baja tensión SOLO con corriente continua y conectados EN SERIE. Nuestros alimentadores están preparados para esta conexión.

Unser power LED sollen NUR mit niedervoltige D.C. Konverter als SERIENVERBINDUNG. Unsere Konverter sind für diese Verbindungsart vorgesehen.

Наши светодиоды высокой мощности должны запитываться только постоянным током низкого напряжения только при ПОСЛЕДОВАТЕЛЬНОМ ПОДКЛЮЧЕНИИ. Наши конвертеры предназначены для такого подключения.

Si consiglia di non superare i 20 mt. nella lunghezza dei cavi tra alimentatore e LED. Collegare tutti i faretti prima di alimentare il circuito.

We recommend not to exceed 20 m. of circuit length between converter and LED. Connect all elements before to give tension to the circuit.

On conseille de ne pas dépasser le 20 m. de longueur entre alimentateur et LED. Brancher tous les éléments avant d'alimenter le circuit.

Se aconseja no exceder en la longitud de los cables entre el alimentador y LED. Conectar todos los focos antes de alimentar el circuito.

Die Verkabelung zwischen Konverter und LED soll nicht länger als 20 m. sein. Alle Elemente anschließen vor den Stromkreis einzuschalten.

Мы рекомендуем, чтобы между конвертером и светильником было не более 20 метров. Подсоединить все светильники прежде, чем подавать напряжение.

Rispettare le polarità nel collegamento elettrico per un corretto funzionamento.

Respect correct polarity when connecting.

Respecter la polarité dans l'installation pour un correct fonctionnement.

Respetar la polaridad en la conexión para una buena instalación.

Beachten die richtige Polarisierung bei der Installation.

Соблюдать полярность подсоединений

E' vivamente sconsigliata l'installazione di interruttori tra alimentatore e led.

We strongly recommend to avoid installation of switches between converter and LED.

Ne pas installer des interrupteurs entre alimentateur et LED.

Es muy aconsejable la instalación de interruptores entre alimentador y LED.

Zwischen Konverter und LED muss Kein Schalter installiert werden.

Не монтировать выключатель между конвертером и светильником.

DIMMERAZIONE 1...10V & PUSH PER COB E POWER LED

1...10V & PUSH DIMMING FOR COB AND POWER LED

1...10V

Alimentatori multipotenza forniti di dip-switch per la selezione della corrente in uscita.

Regolazione della luminosità 0-100% mediante funzione PUSH, interfaccia 1...10V.

Art. 0133 cavetto di sincronizzazione fornito separatamente; max 10 alimentatori sincronizzati, di cui uno solo comandato. (1 Master + 9 Slaves) **Non per 0141/DIM**

Multi-power drivers supplied with dip-switch for selection of the output current.

Light regulation 0-100% by means of PUSH function, 1...10V interface.

Art. 0133 synchronization cable is sold separately, one commanded master driver can synchronize up to max. 9 slaves. **Not for 0141/DIM**

0129

Togliere JP3 per impostare Sync Port (art. 0133) e funzionamento 12-24V.
Remove JP3 to set Sync Port (art. 0133) and 12-24V operation.

Per la regolazione mediante 1...10V il sistema è provvisto di morsetto specifico attivo.

For light regulation 1...10V the control systems are provided of active terminal connection.

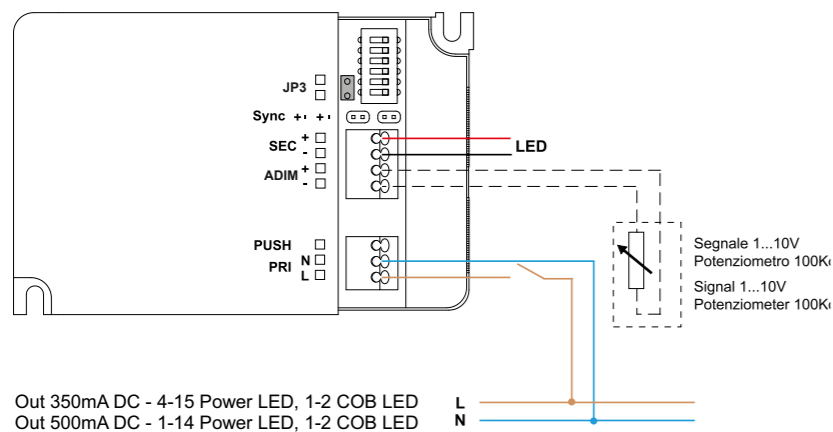

0145

Corto circuito NTC durante l'accensione per impostare la porta Sync (art 0133).
Short circuit NTC during switch on to set Sync port (art 0133).

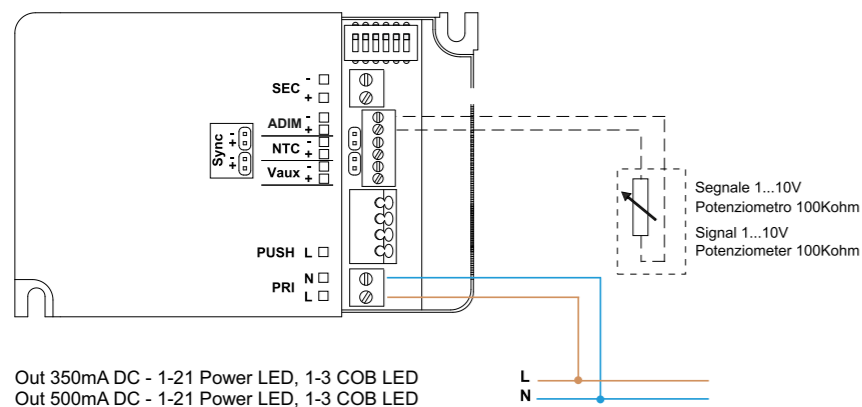

0141/DIM

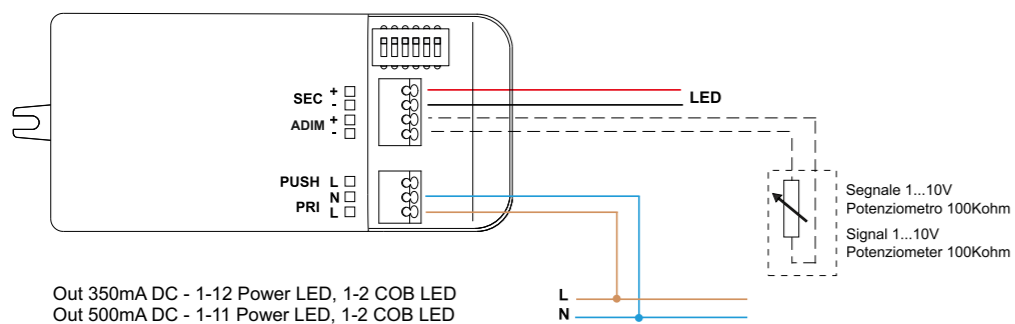

PUSH

Regolazione della luminosità mediante la funzione PUSH

Una breve pressione per accendere e spegnere; una pressione prolungata per aumentare o diminuire l'intensità luminosa. La regolazione si ferma automaticamente ai valori minimi e massimi. Per un nuovo comando accensione, regolazione o spegnimento, rilasciare il pulsante e dare nuovamente il comando desiderato.

Attenzione: Usare solo pulsanti di tipo normalmente aperto privi di spia luminosa incorporata.

Light regulation by means of PUSH function

A short push to turn on and off; a longer push to increase or decrease light intensity. Regulation automatically stops at minimum and maximum values. For another on, regulation or off command, release the push button and give the desired command again.

Attention: only use normally open push buttons with no incorporated warning light.

0129

Togliere JP3 per impostare Sync Port (art. 0133) e funzionamento 12-24V.
Remove JP3 to set Sync Port (art. 0133) and 12-24V operation.

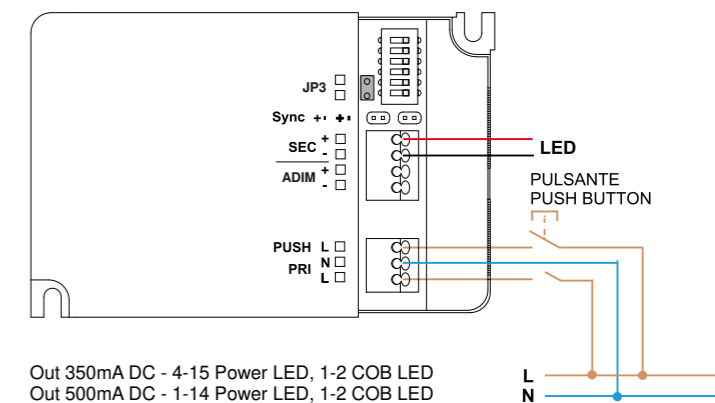

0145

Corto circuito NTC durante l'accensione per impostare la porta Sync (art 0133).
Short circuit NTC during switch on to set Sync port (art 0133).

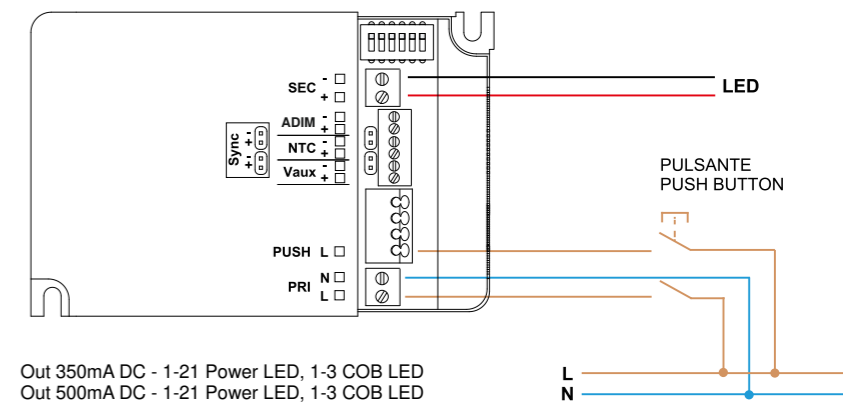

0141/DIM

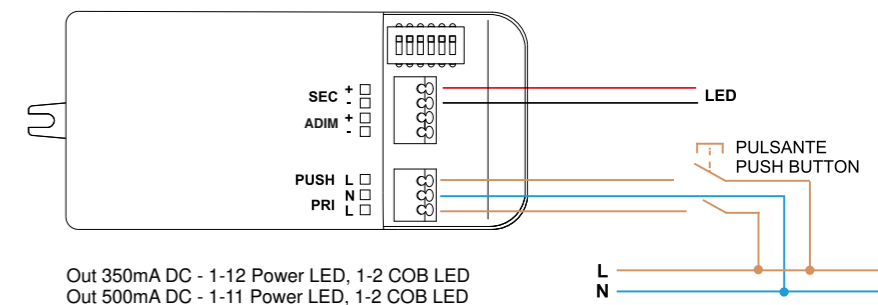

DIMMERAZIONE DALI COB E POWER LED

DALI DIMMING FOR COB AND POWER LED



Technology

Alimentatori multipotenza forniti di dip-switch per la selezione della corrente in uscita. Caratteristiche della regolazione DALI (0,5-100%):

- funzione di memoria per scenari o gruppi luminosi
- richiamo di funzioni memorizzate
- compatibilità con interfacce DALI standard

Art. 0133 cavetto di sincronizzazione fornito separatamente; max 10 alimentatori sincronizzati, di cui uno solo comandato.

Multi-power drivers supplied with dip-switch for selection of the output current.

Features DALI dimming (0,5-100%):

- memory function for sets or light groups
- recall of stored functions
- compatible with standard DALI interfaces

Art. 0133 synchronization cable is sold separately, one commanded master driver can synchronize up to max. 9 slaves



0129/DALI

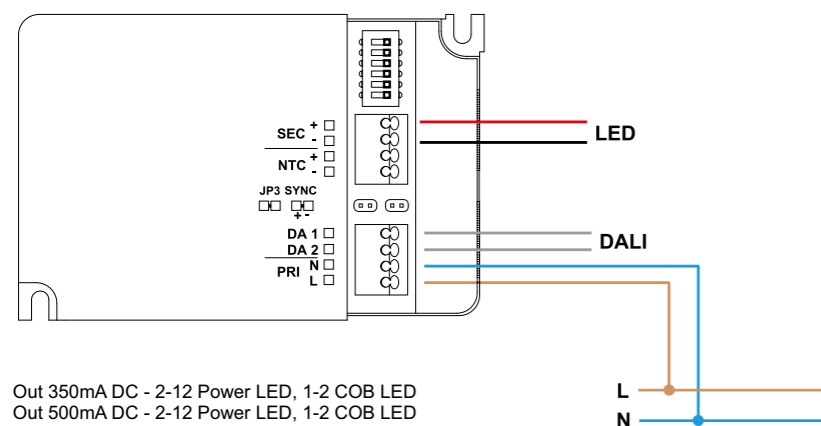

0145/DALI

Corto circuito NTC durante l'accensione per impostare la porta Sync (art 0133).
Short circuit NTC during switch on to set Sync port (art 0133).

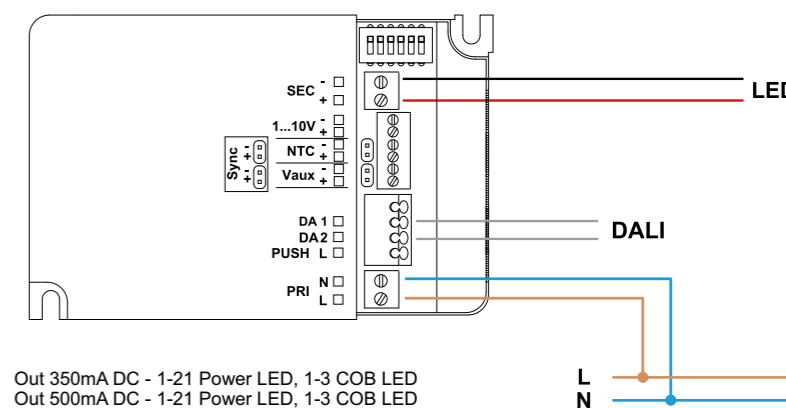

0141/DALI

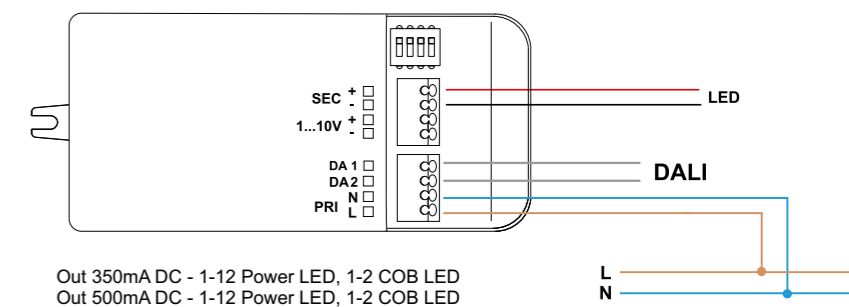

Technology

DIMMERAZIONE 12 - 24 - 48V PER LED STRIP E TRACK 48V

DIMMING 12V - 24 - 48V FOR LED STRIP AND TRACK 48V

REGOLATORE DI LUMINOSITÀ PER DRIVER LED CON USCITA IN TENSIONE 12-48V DC.

LIGHT DIMMER FOR VOLTAGE LED DRIVER 12-48V DC

Sono previste tre distinte modalità di funzionamento lette all'avvio (impostate tramite dip-switch prima dell'accensione):

- DALI - configurazione di fabbrica
Power ON: 100%
System fail level: 100%

- PUSH - impostazioni tramite DIP SWITCH
Funzionamento regolazione:
pressione breve del tasto per ON/OFF;
pressione lunga del tasto per dimmer.
Memorizzazione dell'ultimo dato di dimming.
In presenza rete ad ogni ON il driver parte dall'ultimo dato impostato.
Procedura di allineamento (necessaria per compensare gli errori di sincronizzazione quando si hanno tanti driver in parallelo): da posizione OFF/ON tenere premuto il tasto a lungo (30 sec.) i driver si porteranno al 100%; alla successiva pressione del tasto il flusso luminoso inizierà a diminuire in accordo al profilo impostato.
Massima lunghezza totali cavi PUSH: 15 mt.

- DIMMING 1...10V - 0...10V - impostazioni tramite DIP
Utilizzo di dimmer attivi o passivi (impostazione tramite Dip switch 5):
Impostare il ponticello sulla posizione OFF per potenziometri attivi e sistemi domotici: impedenza di ingresso 47K.
Impostare il Dip switch sulla posizione ON per potenziometri resistivi: Iout max 1,4mA.

3 different modality available before activation (set by DIP switch before switch-on).

- DALI - factory preset.
Power ON: 100%
System fail level: 100%

- PUSH - setting by DIP SWITCH
Regulation controls:
Short key push for on ON-OFF.
Long push for dimming;
Dimming memory sets on last dimming level.
When connected to main supply at each on-switching the driver will restart from last selected level.
Alignment procedure (required to compensate synchronization errors in case many drivers are connected in parallel):
from OFF-ON position hold the key pushed for a long time (30 sec.), all the drivers will go to 100%; at the next push light flux will decrease in conformity with selected setting.
Maximum cable length for PUSH 15 m.

- DIMMING 1...10V or 0...10V - setting by DIP
Use of active or passive dimmers (setting via Dip switch 5):
Set jumper to OFF position for active potentiometers and home automation systems: 47K input impedance.
Set the Dip switch to the ON position for resistive potentiometers: Iout max 1.4mA.



0110/DIM DALI

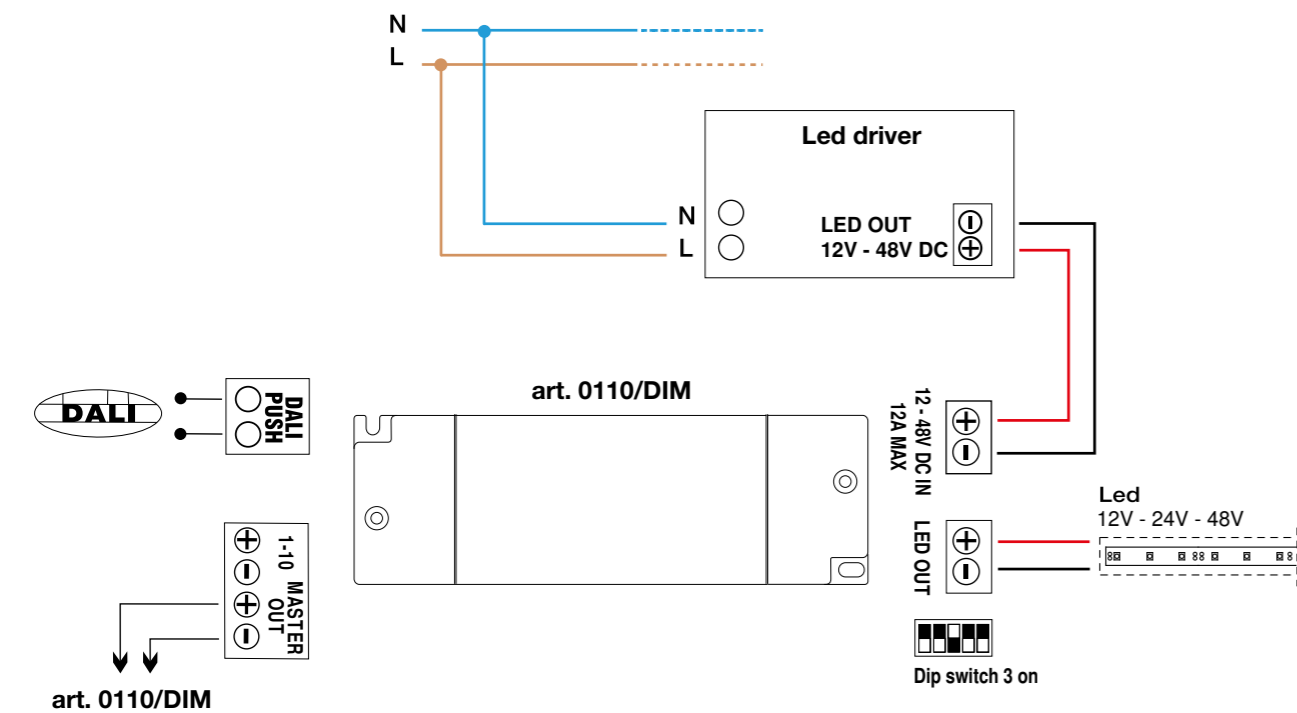

0110/DIM PUSH

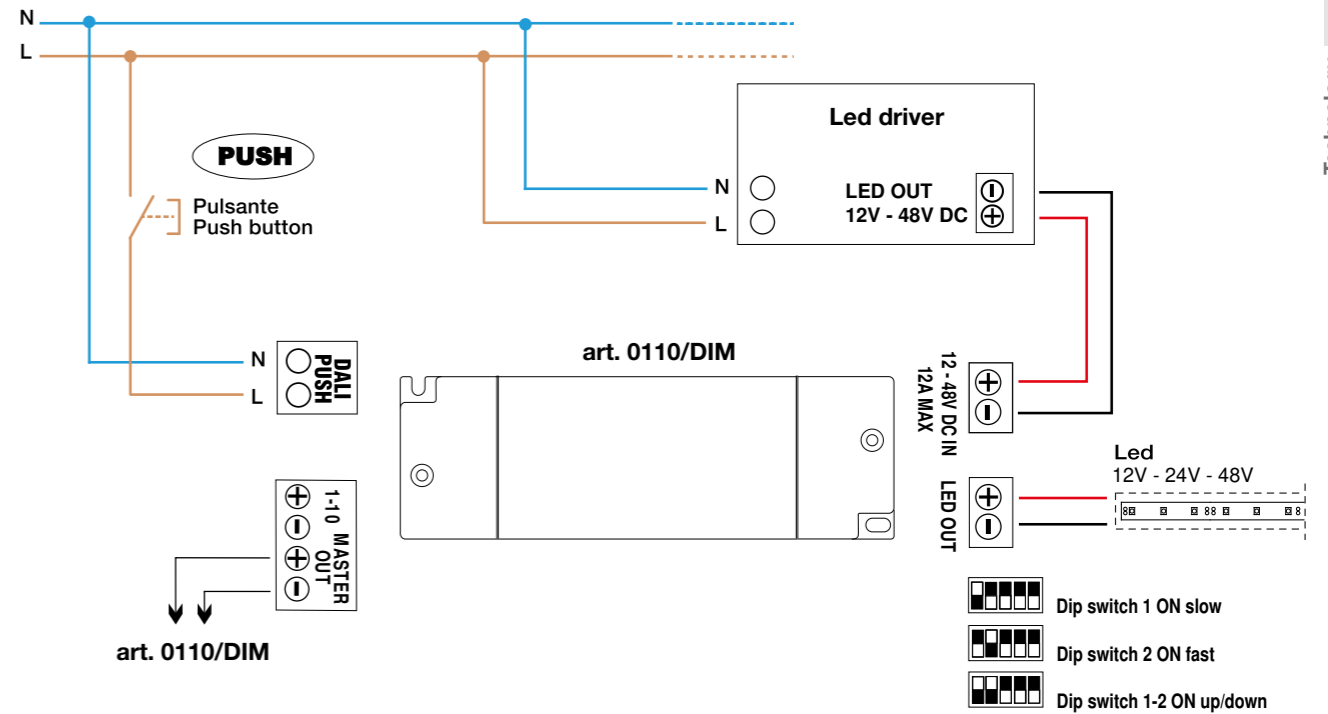

0110/DIM 1...10V

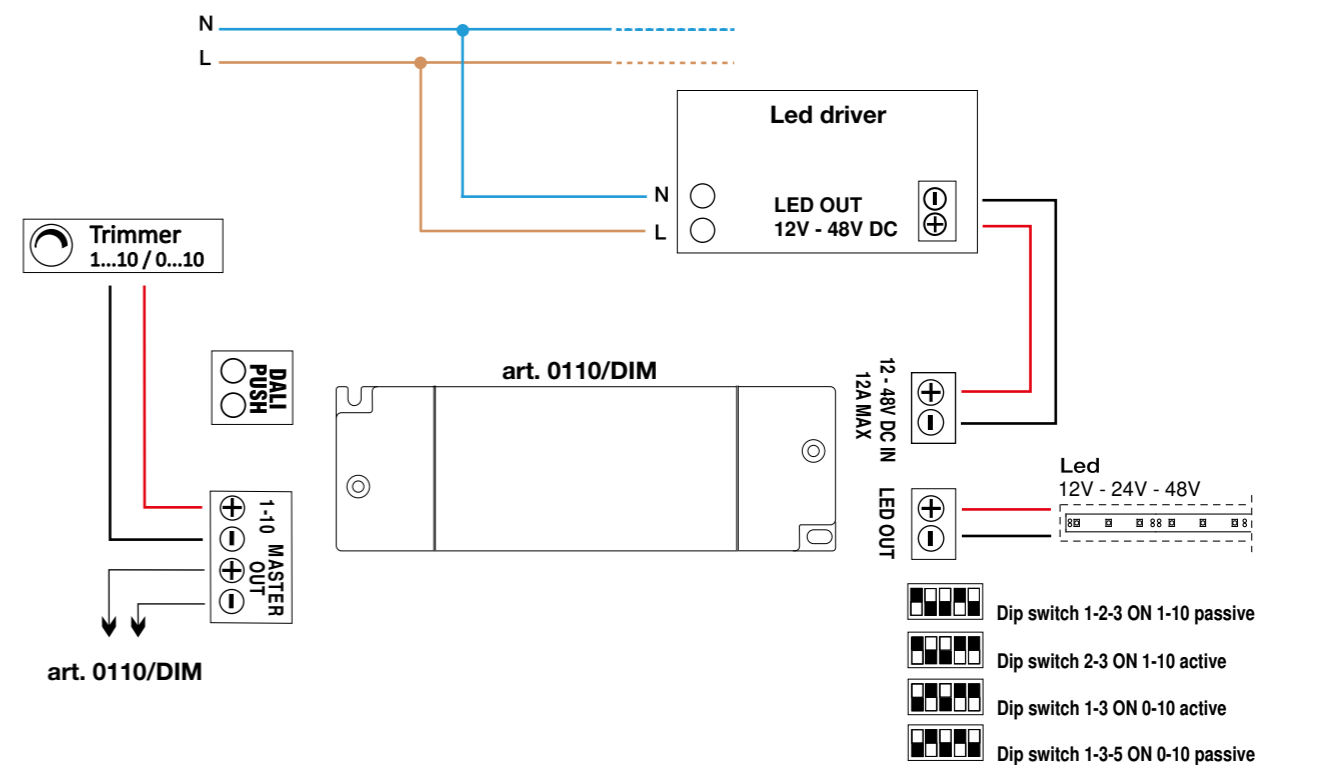

DIMMERAZIONE 24V PER LED STRIP

DIMMING 24V FOR LED STRIP

Technology



0717/DIM100
0717/DIM150

- Alimentatore indipendente IP20
- Fornito di coprimorsetto e serracavo
- Protezione in classe II contro le scosse elettriche per contatti diretti e indiretti
- Protezione auto ripristinante contro le sovratemperature, il circuito aperto e il cortocircuito sul secondario

- IP20 independent driver
- Supplied with terminal cover and cable retainer
- Class II protection against electric shock for direct or indirect contact
- Self-resetting protection against overtemperatures, open circuit and output short circuits

0717/DIM100

Technology

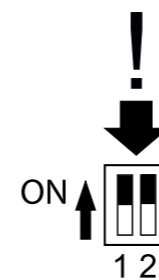

input selector

1	2	Mode
OFF	OFF	DALI/ Push 230V
OFF	ON	Push 24V
ON	OFF	0..10V
ON	ON	1..10V

Cambio impostazioni ad apparecchio spento
Settings can be changed ONLY when the device is OFF
Eteindre l'appareil pour changer les programmations.
Wechsel der Einstellungen nur wenn das System OFF ist.
La configuración se puede cambiar SOLAMENTE cuando el dispositivo está APAGADO

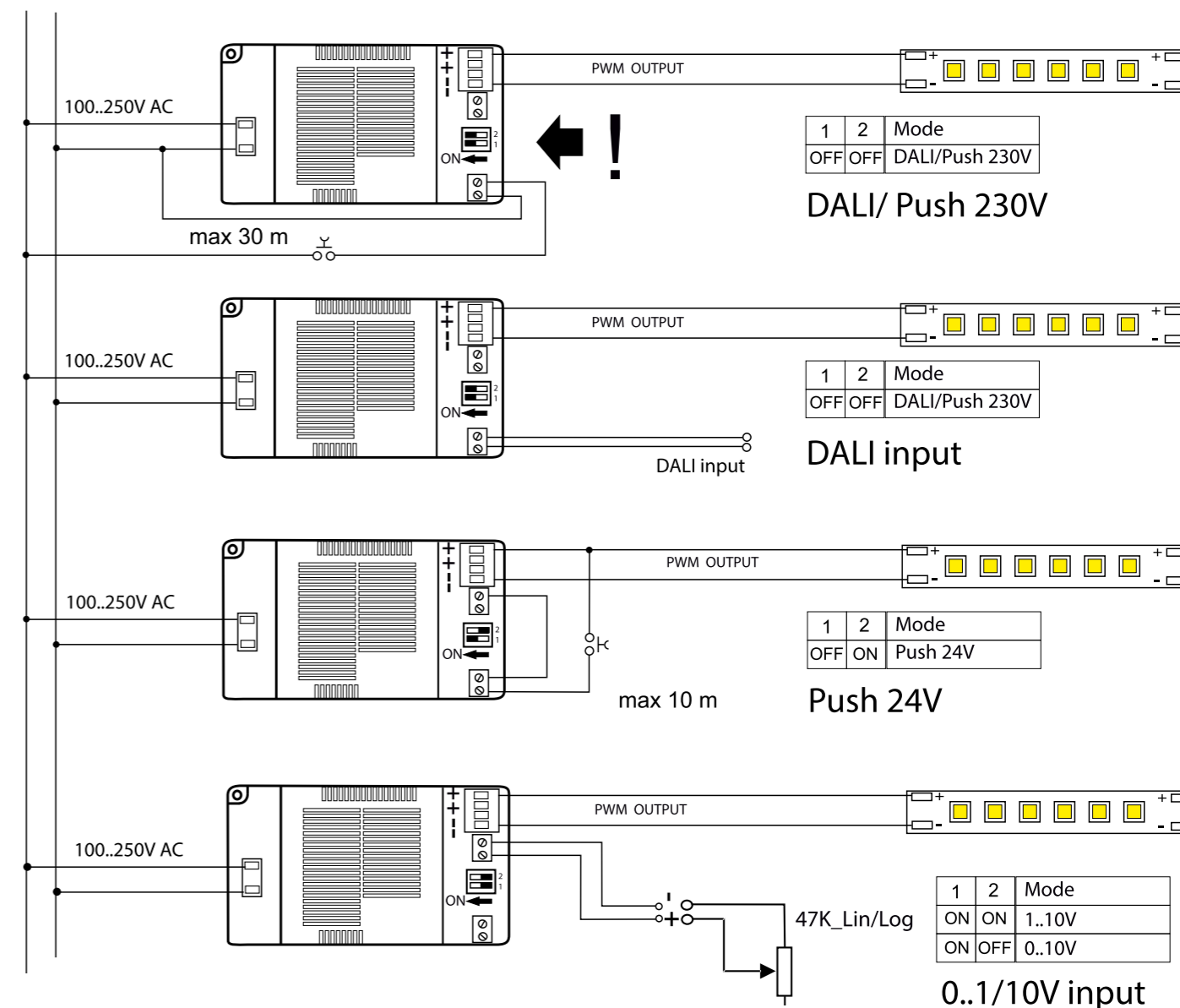

CONTROLLO RGB SMALL 22W

RGB CONTROL SMALL 22W

Technology

- 0167: alimentatore RGB master e slave uscita: 3 canali a 24V (max. 22W).
- 0168: converter RGB Ingresso 24V, uscita per moduli a 250mA (max. 5 Led per canale).
- 0166: cavo di sincronizzazione
- 0165: telecomando IR
- 0163: ricevitore IR

- 0167: RGB master and slave controller Output: 3 channels at 24V (max. 22W)
- 0168: RGB converter Input: 24V, modules output 250mA (max. 5 LED each channel)
- 0166: synchronization cable
- 0165: IR Remote controller
- 0163: IR Receiver



FUNZIONAMENTO REGOLAZIONE PUSH

- Pressione rapida da spento accensione con colore fisso ulteriori brevi pressioni attivano le scene luminose secondo la sequenza: RGB-WRGB-BG-YGR
- Pressione prolungata da spento (>2 sec.) attiva modalità scelta colore fisso; lentamente scorrono i colori, premendo brevemente si blocca scorrimento colori e una ulteriore pressione prolungata del tasto memorizza il colore e spegne il prodotto. Il colore scelto si ripresenterà come primo colore ad ogni accensione prodotto.

- Pressione prolungata spegne il prodotto.

HOW TO SELECT FUNCTIONS WITH PUSH BUTTON

- Short push with switched-off product Product will switch-on on a preselected fixed color, further short pushes will activate different lighting scenes following the sequence: RGB-WRGB-BG-YGR.

- Long push with switched-off product (>2 sec.) will activate choice of preselected fix color; colors changes slowly, a short push will stop on a selected color; a second long push will memorize this as preselected and then the product will switch off. Preselected color will be displayed as first any time you switch on the product.

- Long push with product switched on will switch off.

FUNZIONAMENTO TELECOMANDO

- Tasti regolazione singolo colore Premendo uno dei tasti colore si dimmerà il canale corrispondente. Se il canale (colore) non è alla massima intensità premendo il tasto si avrà un incremento di questa fino al massimo o fino al livello corrispondente al momento in cui si rilascia il tasto. Un ulteriore pressione del tasto inverte il verso di regolazione fino al totale spegnimento del canale o fino al livello corrispondente al momento in cui si rilascia il tasto. Se il canale (colore) è alla massima intensità premendo il tasto si avrà un decremento di questa fino allo spegnimento completo o fino al livello corrispondente al momento in cui si rilascia il tasto. Se si è nella funzione show, premere uno di questi tasti termina la funzione bloccando i colori nella condizione di quell'istante. Il tasto colore bianco regola l'intensità dei tre canali simultaneamente con la stessa modalità del singolo colore.

- Tasti tempo ciclo Sono disponibili i seguenti tasti: 30sec, 2min., 10min. Premere il tasto corrispondente al tempo ciclo desiderato.

- Tasto Show Permette la selezione di uno dei 4 show preimpostati: premendo il tasto si può scegliere lo show dal primo colore della sequenza Il tempo ciclo è di default 30 sec.

- Tasto accensione /spegnimento stand by Permette l'accensione e lo spegnimento del prodotto mettendolo in modalità stand by: alla prima accensione del prodotto i 3 canali saranno accessi alla massima intensità. Per le accensioni successive i canali saranno accessi all'intensità memorizzata allo spegnimento del prodotto.

REMOTE FUNCTIONS

- Single colour selection buttons Pushing one of those buttons dims corresponding channel (color). If the channel(color) is not at the max intensity, by pushing the button intensity will go up to maximum power or till the level reached when the button is released. A further push of the button will invert regulation mode and the intensity will fade up to total switch-off or till the level reached when the button is released. If the channel(color) is at the max intensity, the intensity will fade up to total switch-off or till the level reached when the button is released. If the show function is activated, pushing one of those buttons will terminate the show fixing the colors as they are. The white button dims all three channels simultaneously following same modality of color buttons.

- Cycle timing buttons Following buttons are available: 30sec, 2min., 10 min. Push the button corresponding at the desired cycle timing:

- Show button It allows selection among the 4 preset programs: first colour in a sequence can be selected by pushing this button. Default cycle duration is 30 sec.

- Switch on/off and stand-by button Controls on-off switching of the product activating standby mode: when switching on the product for the first time the 3 channels will activate at max power. After that each channel will switch-on at the intensity memorized during switch-off.

RGB push (22W)

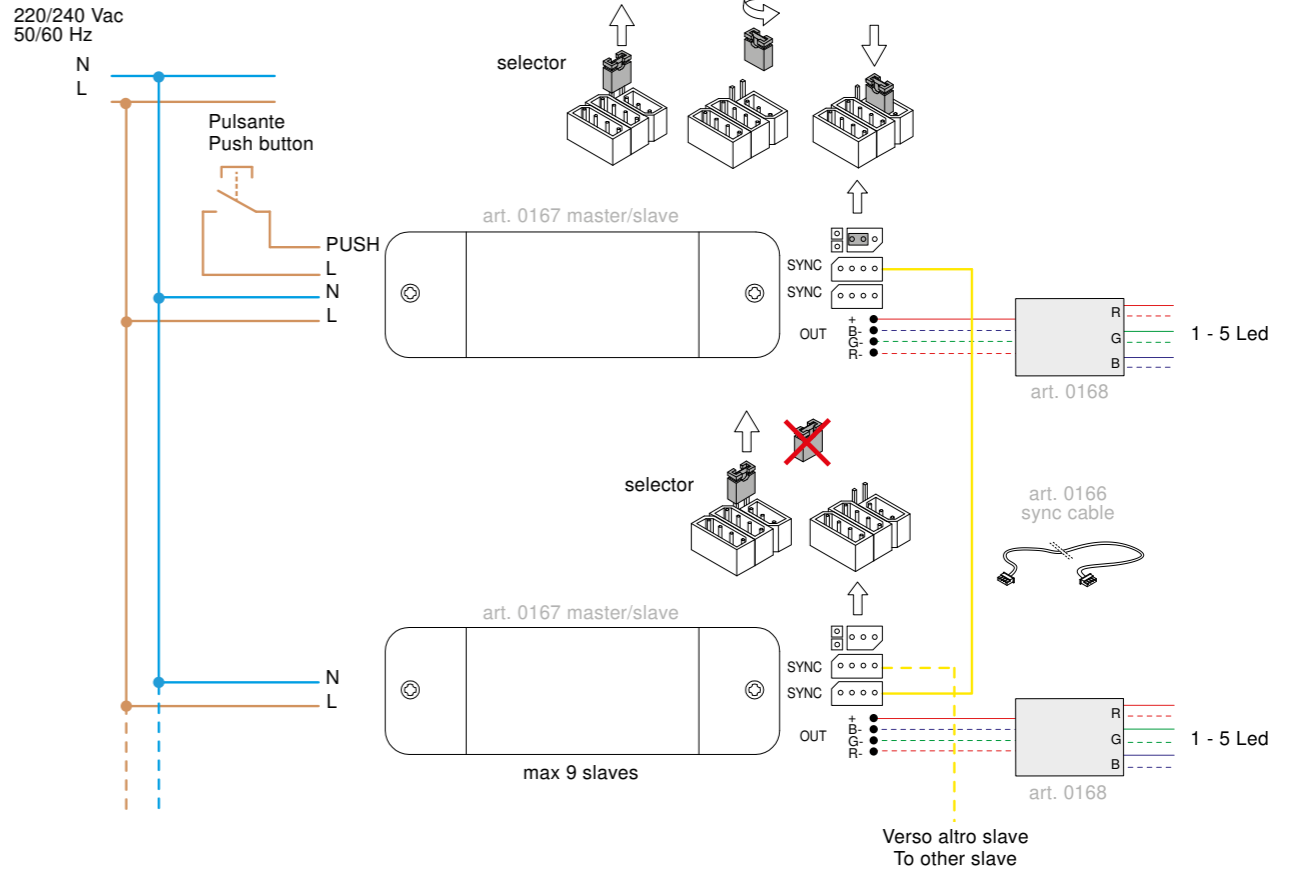

RGB remote (22W)

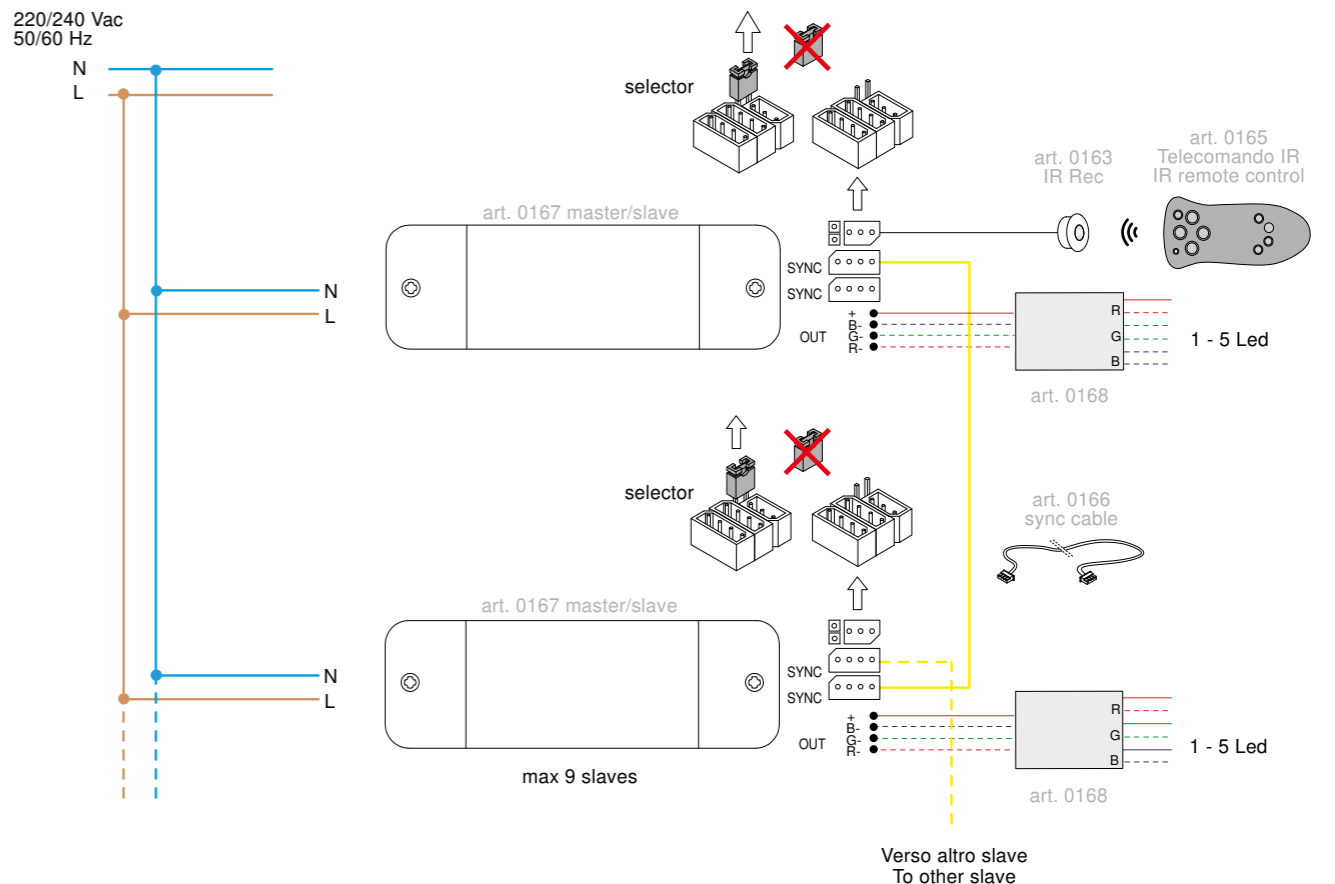

CONTROLLO RGB BIG 120W

RGB CONTROL BIG 120W

Technology

- 0164: alimentatore RGB master e slave uscita: 3 canali a 24V (max. 120W).
- 0168: converter RGB Ingresso 24V, uscita per moduli a 250mA (max. 5 Led per canale).
- 0166: cavo di sincronizzazione
- 0165: telecomando IR
- 0163: ricevitore IR

- 0164: RGB master and slave controller Output: 3 channels at 24V (max. 120W)
- 0168: RGB converter Input: 24V, modules output 250mA (max. 5 LED each channel)
- 0166: synchronization cable
- 0165: IR Remote control
- 0163: IR Receiver



FUNZIONAMENTO REGOLAZIONE PUSH

- Pressione rapida da spento accensione con colore fisso ulteriori brevi pressioni attivano le scene luminose secondo la sequenza: RGB-WRGB-BG-YGR

- Pressione prolungata da spento (>2 sec.) attiva modalità scelta colore fisso; lentamente scorrono i colori, premendo brevemente si blocca scorrimento colori e una ulteriore pressione prolungata del tasto memorizza il colore e spegne il prodotto. Il colore scelto si ripresenterà come primo colore ad ogni accensione prodotto.

- Pressione prolungata spegne il prodotto.

HOW TO SELECT FUNCTIONS WITH PUSH BUTTON

- Short push with switched-off product**
Product will switch-on on a preselected fixed color, further short pushes will activate different lighting scenes following the sequence: RGB-WRGB-BG-YGR.

- Long push with switched-off product (>2 sec.)**
will activate choice of preselected fix color; colors changes slowly, a short push will stop on a selected color; a second long push will memorize this as preselected and then the product will switch off. Preselected color will be displayed as first any time you switch on the product.

- Long push with product switched on**
will switch off.

FUNZIONAMENTO TELECOMANDO

- Tasti regolazione singolo colore
Premendo uno dei tasti colore si dimmerà il canale corrispondente.

Se il canale (colore) non è alla massima intensità premendo il tasto si avrà un incremento di questa fino al massimo o fino al livello corrispondente al momento in cui si rilascia il tasto. Un ulteriore pressione del tasto inverte il verso di regolazione fino al totale spegnimento del canale o fino al livello corrispondente al momento in cui si rilascia il tasto.

Se il canale (colore) è alla massima intensità premendo il tasto si avrà un decremento di questa fino allo spegnimento completo o fino al livello corrispondente al momento in cui si rilascia il tasto. Se si è nella funzione show, premere uno di questi tasti termina la funzione bloccando i colori nella condizione di quell'istante.

Il tasto colore bianco regola l'intensità dei tre canali simultaneamente con la stessa modalità del singolo colore.

- Tasti tempo ciclo**
Sono disponibili i seguenti tasti: 30sec, 2min., 10min. Premere il tasto corrispondente al tempo ciclo desiderato.

- Tasto Show**
Permette la selezione di uno dei 4 show preimpostati: premendo il tasto si può scegliere lo show dal primo colore della sequenza. Il tempo ciclo è di default 30 sec.

- Tasto accensione /spegnimento stand by**
Permette l'accensione e lo spegnimento del prodotto mettendolo in modalità stand by: alla prima accensione del prodotto i 3 canali saranno accessi alla massima intensità. Per le accensioni successive i canali saranno accessi all'intensità memorizzata allo spegnimento del prodotto.

REMOTE FUNCTIONS

- Single colour selection buttons**
Pushing one of those buttons dims corresponding channel (color). If the channel(color) is not at the max intensity, by pushing the button intensity will go up to maximum power or till the level reached when the button is released. A further push of the button will invert regulation mode and the intensity will fade up to total switch-off or till the level reached when the button is released.

If the channel(color) is at the max intensity, the intensity will fade up to total switch-off or till the level reached when the button is released. If the show function is activated, pushing one of those buttons will terminate the show fixing the colors as they are. The white button dims all three channels simultaneously following same modality of color buttons.

- Cycle timing buttons**
Following buttons are available: 30sec, 2min., 10 min. Push the button corresponding at the desired cycle timing:

- Show button**
It allows selection among the 4 preset programs: first colour in a sequence can be selected by pushing this button. Default cycle duration is 30 sec.

- Switch on/off and stand-by button**
Controls on-off switching of the product activating standby mode: when switching on the product for the first time the 3 channels will activate at the intensity memorized during switch-off.

RGB push (120W)

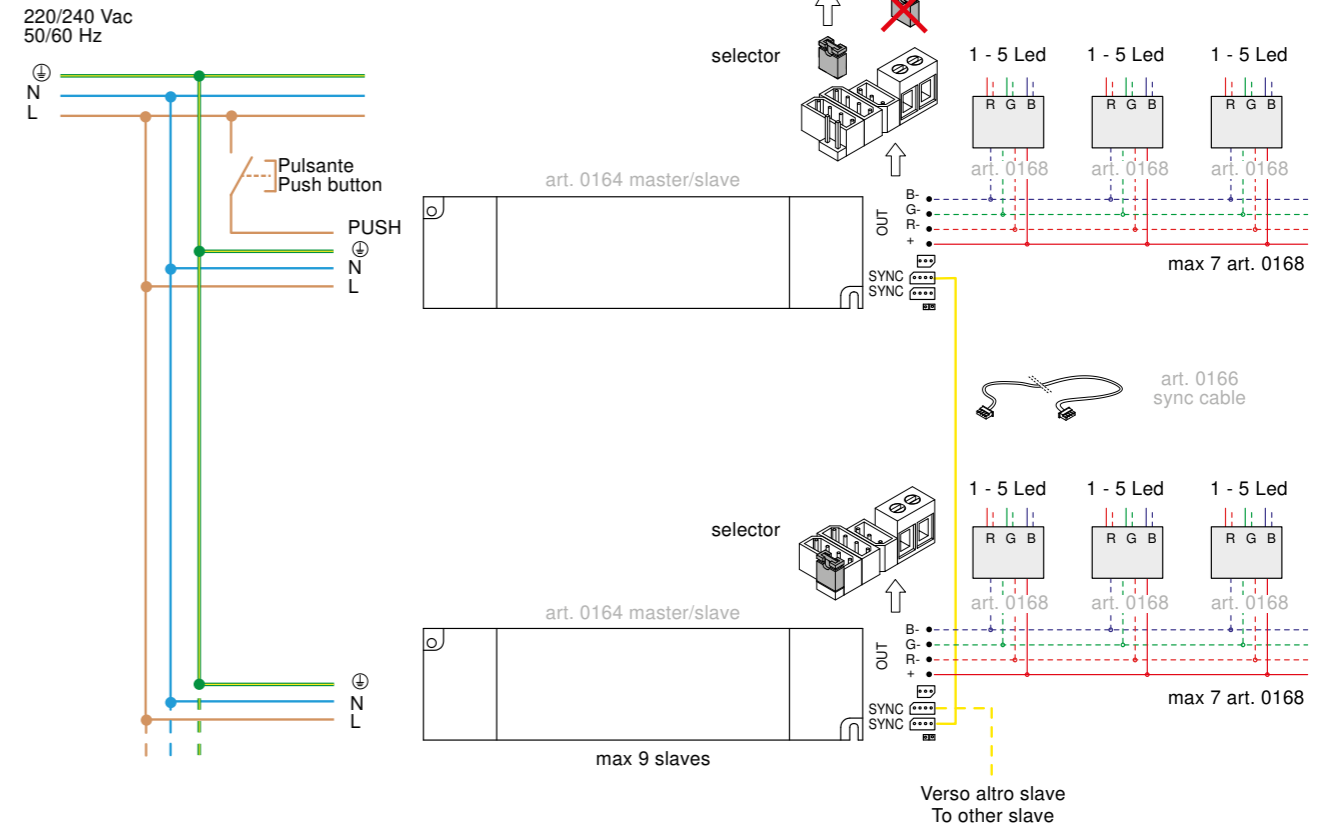

RGB remote (120W)

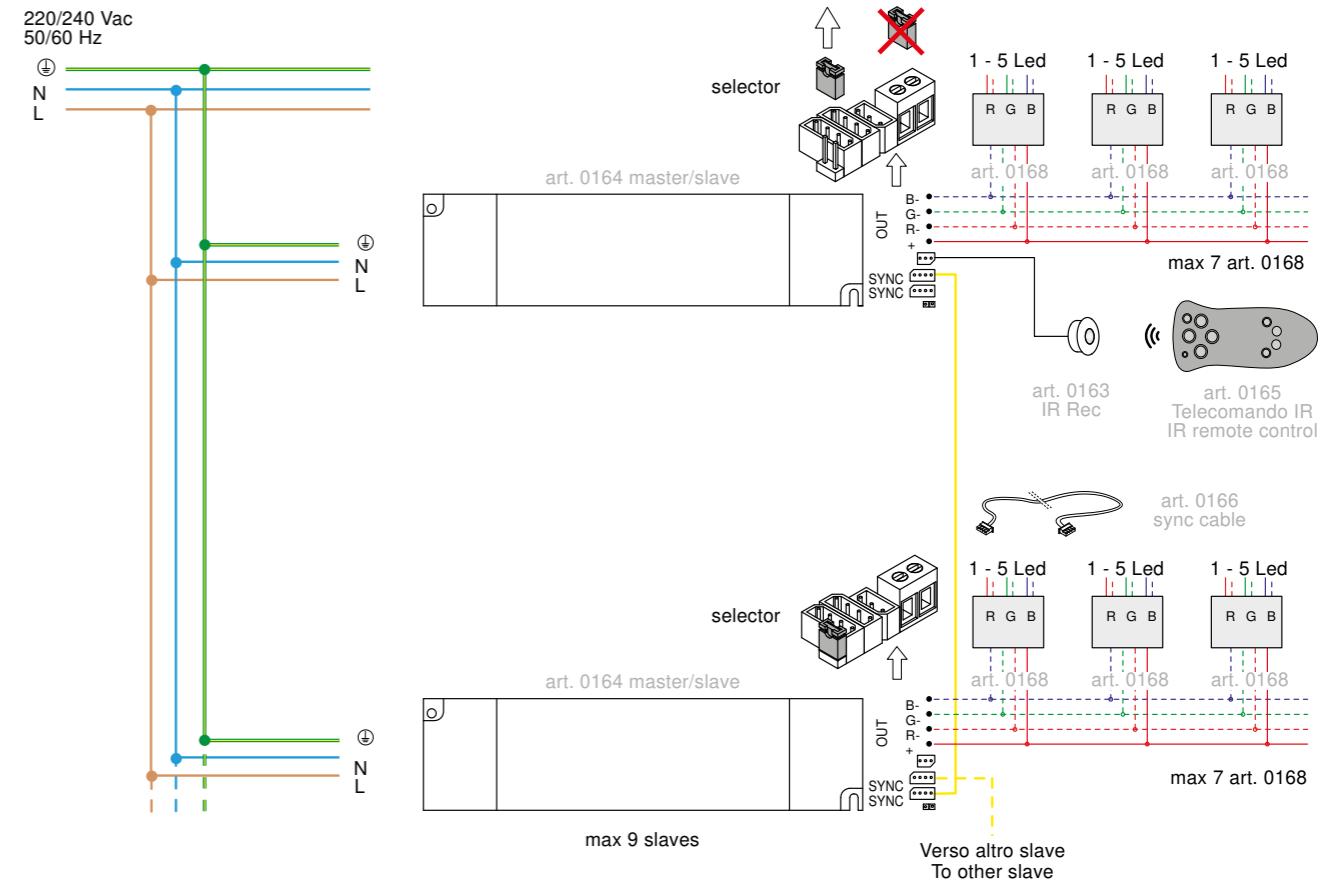

CONTROLLO RGB PER LED STRIP SMALL 22W 24V

RGB CONTROL SMALL 22W 24V FOR LED STRIP

Technology

- 0167: alimentatore RGB master e slave uscita: 3 canali a 24V (max. 22W).
 - 0166: cavo di sincronizzazione
 - 0165: telecomando IR
 - 0163: ricevitore IR
-
- 0167: RGB master and slave controller Output: 3 channels at 24V (max. 22W)
 - 0166: synchronization cable
 - 0165: IR Remote control
 - 0163: IR Receiver



FUNZIONAMENTO REGOLAZIONE PUSH

- Pressione rapida da spento accensione con colore fisso ulteriori brevi pressioni attivano le scene luminose secondo la sequenza: RGB-WRGR-BG-YGR
- Pressione prolungata da spento (>2 sec.) attiva modalità scelta colore fisso; lentamente scorrono i colori, premendo brevemente si blocca scorrimento colori e una ulteriore pressione prolungata del tasto memorizza il colore e spegne il prodotto. Il colore scelto si ripresenterà come primo colore ad ogni accensione prodotto.
- Pressione prolungata spegne il prodotto.

HOW TO SELECT FUNCTIONS WITH PUSH BUTTON

- **Short push with switched-off product**
Product will switch-on on a preselected fixed color, further short pushes will activate different lighting scenes following the sequence: RGB-WRGR-BG-YGR.
- **Long push with switched-off product (>2 sec.)**
will activate choice of preselected fix color; colors changes slowly, a short push will stop on a selected color; a second long push will memorize this as preselected and then the product will switch off.
Preselected color will be displayed as first any time you switch on the product.
- **Long push with product switched on**
will switch off.

FUNZIONAMENTO TELECOMANDO

- Tasti regolazione singolo colore
Premendo uno dei tasti colore si dimmerà il canale corrispondente.
Se il canale (colore) non è alla massima intensità premendo il tasto si avrà un incremento di questa fino al massimo o fino al livello corrispondente al momento in cui si rilascia il tasto. Un ulteriore pressione del tasto inverte il verso di regolazione fino al totale spegnimento del canale o fino al livello corrispondente al momento in cui si rilascia il tasto.
- Se il canale (colore) è alla massima intensità premendo il tasto si avrà un decremento di questa fino allo spegnimento completo o fino al livello corrispondente al momento in cui si rilascia il tasto. Se si è nella funzione show, premere uno di questi tasti termina la funzione bloccando i colori nella condizione di quell'istante.
- Il tasto colore bianco regola l'intensità dei tre canali simultaneamente con la stessa modalità del singolo colore.
- Tasti tempo ciclo
Sono disponibili i seguenti tasti: 30sec, 2min., 10min. Premere il tasto corrispondente al tempo ciclo desiderato.
- Tasto Show
Permette la selezione di uno dei 4 show preimpostati: premendo il tasto si può scegliere lo show dal primo colore della sequenza. Il tempo ciclo è di default 30 sec.
- Tasto accensione /spegnimento stand by
Permette l'accensione e lo spegnimento del prodotto mettendolo in modalità stand by:
alla prima accensione del prodotto i 3 canali saranno accesi alla massima intensità. Per le accensioni successive i canali saranno accesi all'intensità memorizzata allo spegnimento del prodotto.

REMOTE FUNCTIONS

- **Single colour selection buttons**
Pushing one of those buttons dims corresponding channel (color).
If the channel(color) is not at the max intensity, by pushing the button intensity will go up to maximum power or till the level reached when the button is released.
A further push of the button will invert regulation mode and the intensity will fade up to total switch-off or till the level reached when the button is released.
If the channel(color) is at the max intensity, the intensity will fade up to total switch-off or till the level reached when the button is released. If the show function is activated, pushing one of those buttons will terminate the show fixing the colors as they are. The white button dims all three channels simultaneously following same modality of color buttons.
- **Cycle timing buttons**
Following buttons are available:
30sec, 2min., 10 min. Push the button corresponding at the desired cycle timing:
- **Show button**
It allows selection among the 4 preset programs: first colour in a sequence can be selected by pushing this button. Default cycle duration is 30 sec.
- **Switch on/off and stand-by button**
Controls on-off switching of the product activating standby mode: when switching on the product for the first time the 3 channels will activate at max power. After that each channel will switch-on at the intensity memorized during switch-off.

RGB push (22W)

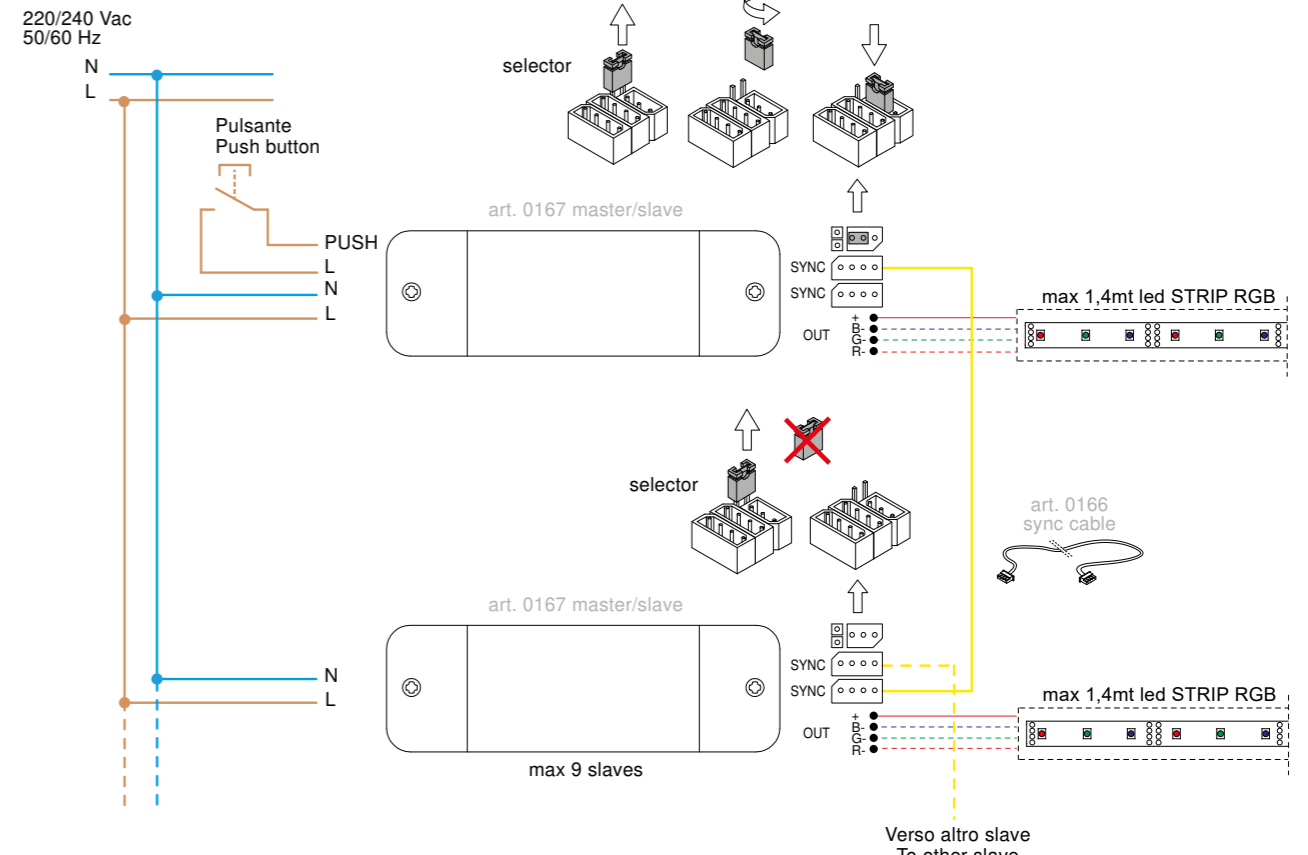

RGB remote (22W)

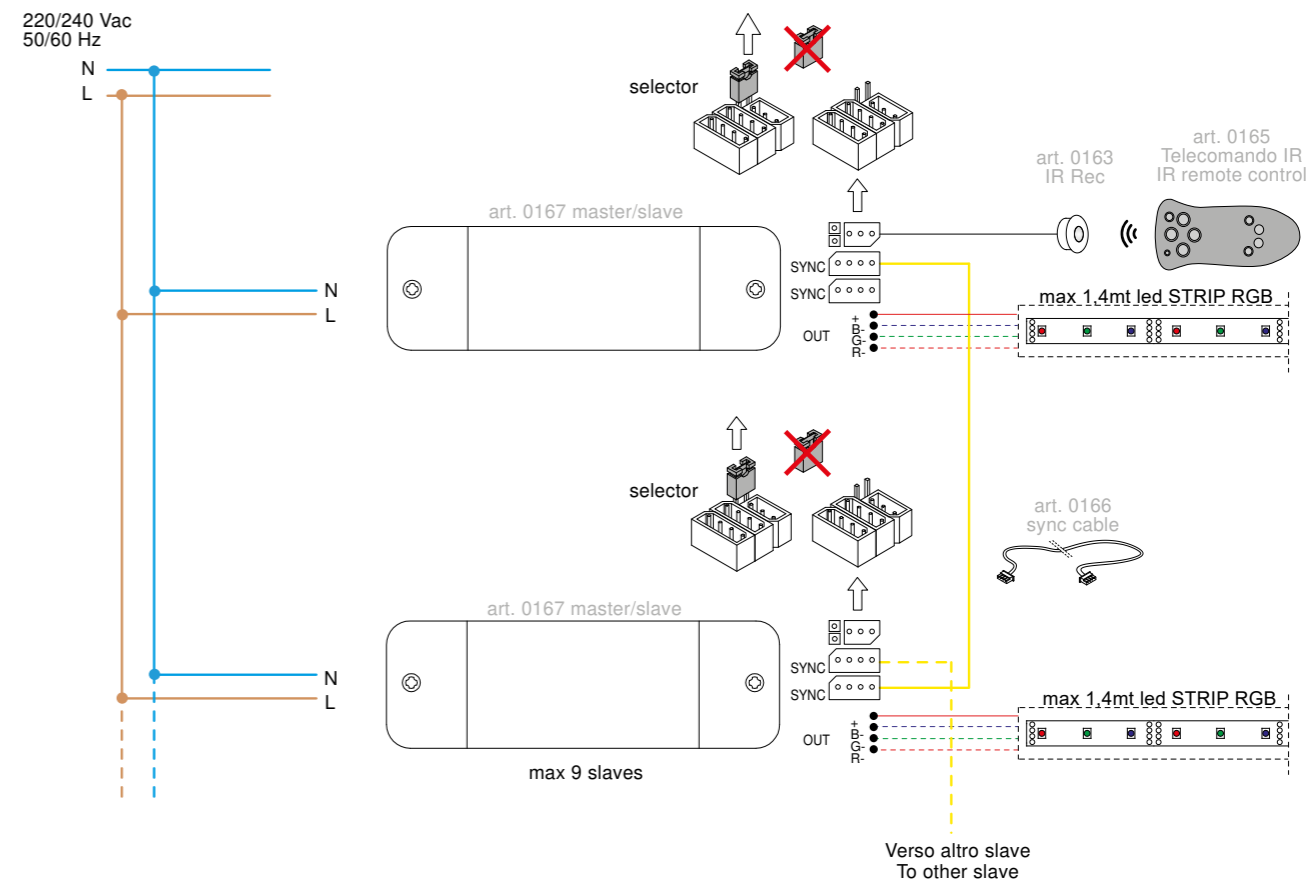

Technology

CONTROLLO RGB BIG 120W PER LED STRIP 24V

RGB CONTROL BIG 120W 24V FOR LED STRIP

0164: alimentatore RGB master e slave uscita: 3 canali a 24V (max. 120W).

0166: cavo di sincronizzazione

0165: telecomando IR

0163: ricevitore IR

0164: RGB master and slave controller Output: 3 channels at 24V (max. 120W)

0166: synchronization cable

0165: IR Remote control

0163: IR Receiver



FUNZIONAMENTO REGOLAZIONE PUSH

- Pressione rapida da spento accensione con colore fisso ulteriori brevi pressioni attivano le scene luminose secondo la sequenza: RGB-WRGB-BG-YGR

- Pressione prolungata da spento (>2 sec.) attiva modalità scelta colore fisso; lentamente scorrono i colori, premendo brevemente si blocca scorrimento colori e una ulteriore pressione prolungata del tasto memorizza il colore e spegne il prodotto. Il colore scelto si ripresenterà come primo colore ad ogni accensione prodotto.

- Pressione prolungata spegne il prodotto.

HOW TO SELECT FUNCTIONS WITH PUSH BUTTON

- **Short push with switched-off product**
Product will switch-on on a preselected fixed color, further short pushes will activate different lighting scenes following the sequence: RGB-WRGB-BG-YGR.

- **Long push with switched-off product (>2 sec.)**
will activate choice of preselected fix color; colors changes slowly, a short push will stop on a selected color; a second long push will memorize this as preselected and then the product will switch off. Preselected color will be displayed as first any time you switch on the product.

- **Long push with product switched on**
will switch off.

FUNZIONAMENTO TELECOMANDO

- **Tasti regolazione singolo colore**
Premendo uno dei tasti colore si dimmerà il canale corrispondente. Se il canale (colore) non è alla massima intensità premendo il tasto si avrà un incremento di questa fino al massimo o fino al livello corrispondente al momento in cui si rilascia il tasto. Un'ulteriore pressione del tasto inverte il verso di regolazione fino al totale spegnimento del canale o fino al livello corrispondente al momento in cui si rilascia il tasto. Se il canale (colore) è alla massima intensità premendo il tasto si avrà un decremento di questa fino allo spegnimento completo o fino al livello corrispondente al momento in cui si rilascia il tasto. Se si è nella funzione show, premere uno di questi tasti termina la funzione bloccando i colori nella condizione di quell'istante.

Il tasto colore bianco regola l'intensità dei tre canali simultaneamente con la stessa modalità del singolo colore.

- **Tasti tempo ciclo**
Sono disponibili i seguenti tasti: 30sec, 2min., 10min. Premere il tasto corrispondente al tempo ciclo desiderato.

- **Tasto Show**
Permette la selezione di uno dei 4 show preimpostati: premendo il tasto si può scegliere lo show dal primo colore della sequenza. Il tempo ciclo è di default 30 sec.

- **Tasto accensione /spegnimento stand by**
Permette l'accensione e lo spegnimento del prodotto mettendolo in modalità stand by: alla prima accensione del prodotto i 3 canali saranno accesi alla massima intensità. Per le accensioni successive i canali saranno accesi all'intensità memorizzata allo spegnimento del prodotto.

REMOTE FUNCTIONS

- **Single colour selection buttons**
Pushing one of those buttons dims corresponding channel (color).

If the channel(color) is not at the max intensity, by pushing the button intensity will go up to maximum power or till the level reached when the button is released. A further push of the button will invert regulation mode and the intensity will fade up to total switch-off or till the level reached when the button is released.

If the channel(color) is at the max intensity, the intensity will fade up to total switch-off or till the level reached when the button is released. If the show function is activated, pushing one of those buttons will terminate the show fixing the colors as they are. The white button dims all three channels simultaneously following same modality of color buttons.

- **Cycle timing buttons**
Following buttons are available: 30sec, 2min., 10 min. Push the button corresponding at the desired cycle timing:

- **Show button**
It allows selection among the 4 preset programs: first colour in a sequence can be selected by pushing this button. Default cycle duration is 30 sec.

- **Switch on/off and stand-by button**
Controls on-off switching of the product activating standby mode: when switching on the product for the first time the 3 channels will activate at max power. After that each channel will switch-on at the intensity memorized during switch-off.

RGB push (120W)

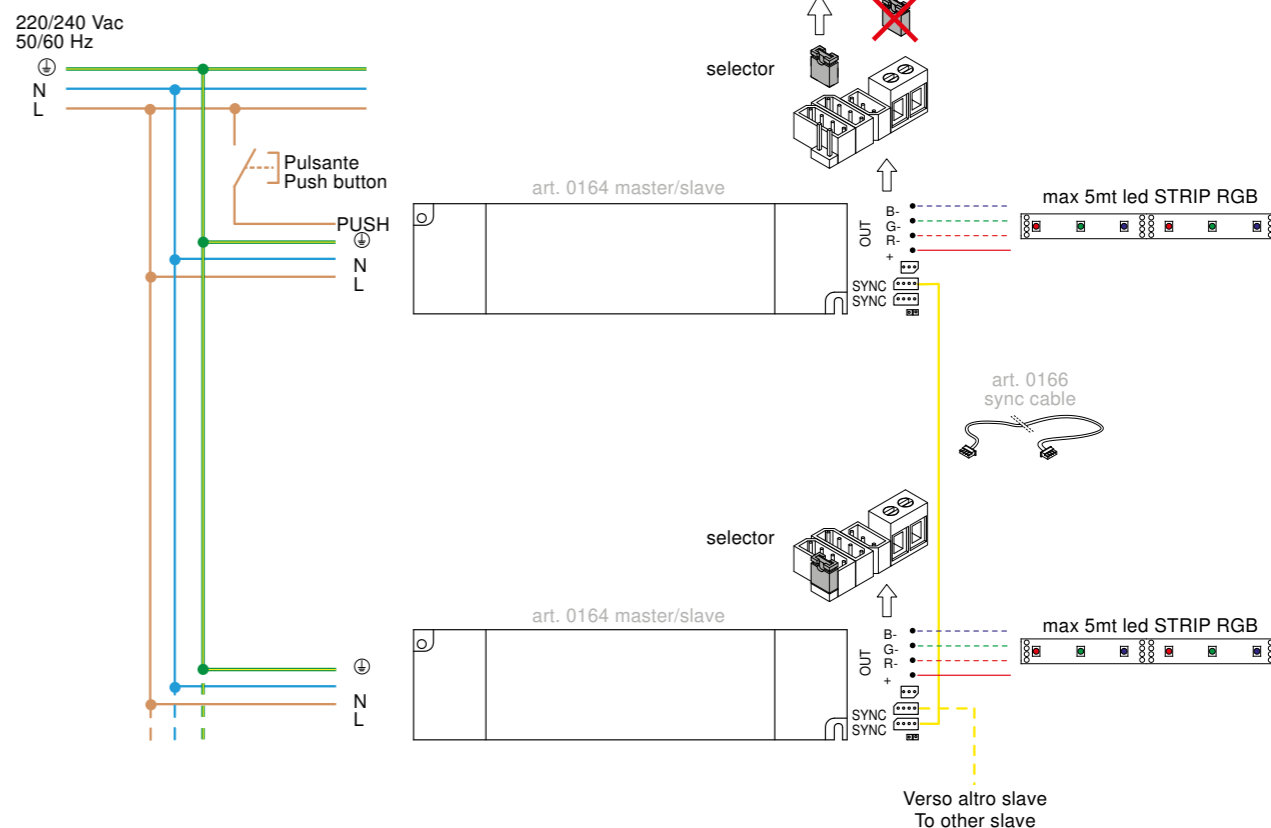

RGB remote (120W)

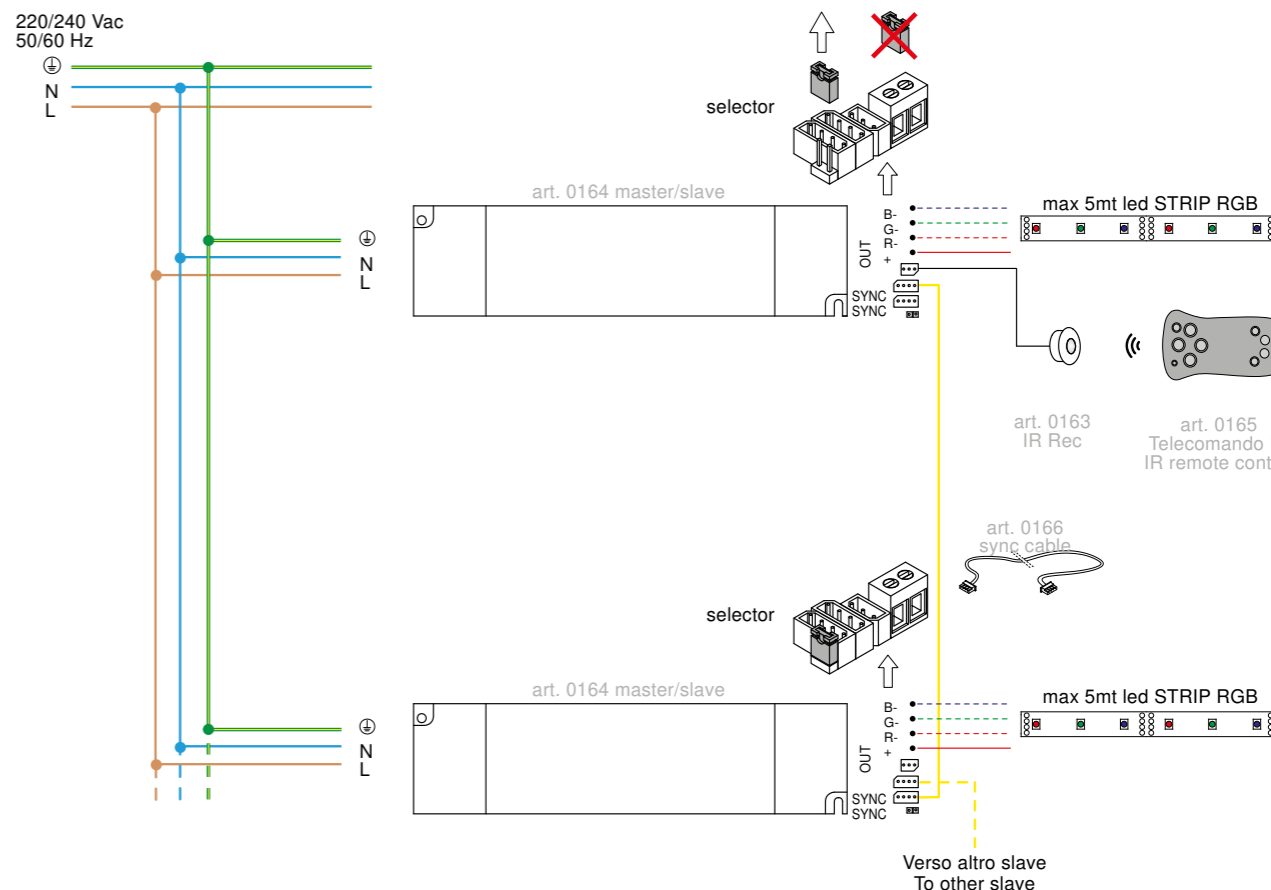

INTERFACCIA DMX - RGB

DMX - RGB INTERFACE

Technology



0729/DMX

Caratteristiche

- Interfaccia in grado di convertire il segnale con protocollo DMX in tre segnali PWM separati.
- Selezione indirizzo DMX tramite tre selettori rotativi posti sulla parte superiore dell'interfaccia.
- E' possibile inoltre utilizzare un unico cavo di sincronizzazione multicanale RGB (art.0166 fornito separatamente) per connettere fino a 10 alimentatori art. 0164, 0167.
- Il convertitore può essere alimentato direttamente dalla rete (100 ÷ 240 VAC).
- DMX mode tramite morsettiera per collegamento basato su protocollo DMX512A standard. Selettori rotativi tipo BCD per impostazione indirizzi e inserimento resistenza di terminazione linea.
- LED per indicazione dello stato della trasmissione DMX e velocità show.

Features

- Interface which can convert a signal with DMX protocol into three separated PWM signal.
- DMX address selection through 3 selectors on the upper side of the interface.
- It is possible to use one RGB multichannel sync cable (art.0166 supplied separated) to connect up to 10 drivers of 0164,0167
- The converter can be powered directly from the mains (100 ÷ 240 VAC). DMX mode based on DMX 512A Standard. BCD rotary switch for setting DMX address and line termination resistor.
- LED indicator of the state of DMX transmission and show speed.

0729/DMX + Art. 0167

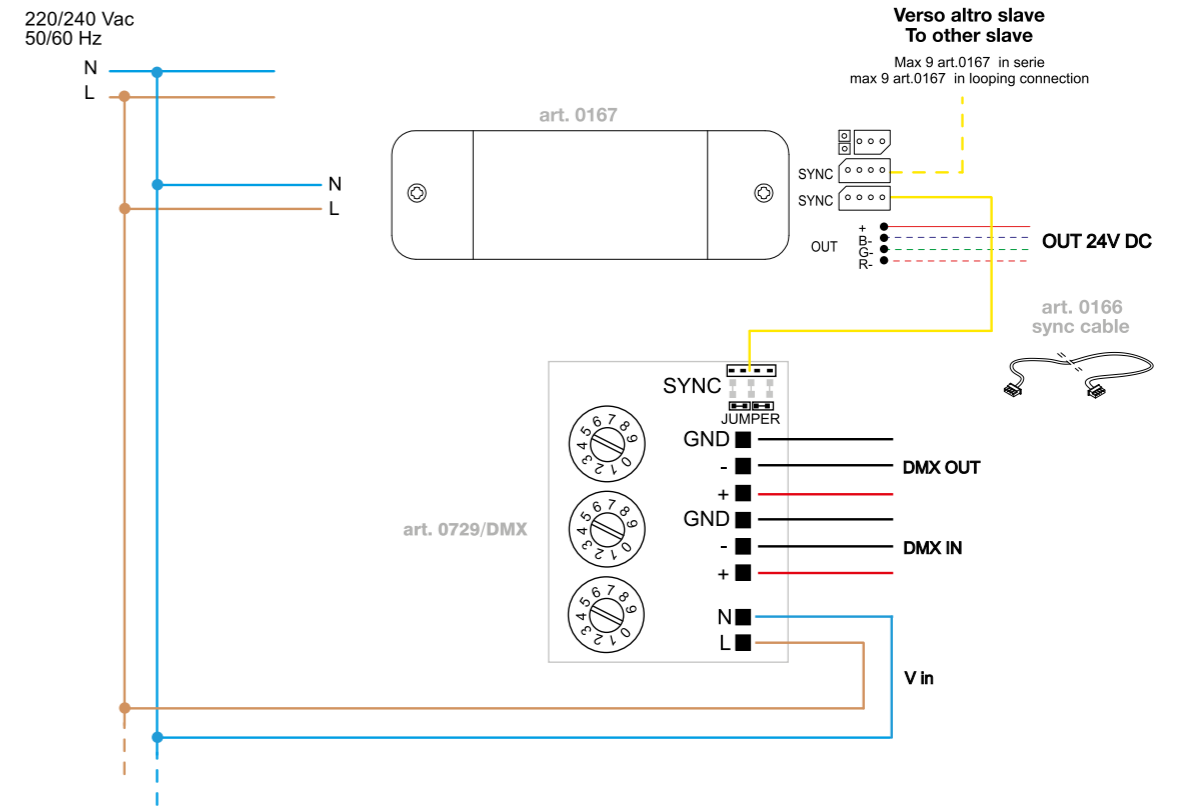

Technology

0729/DMX + Art. 0164

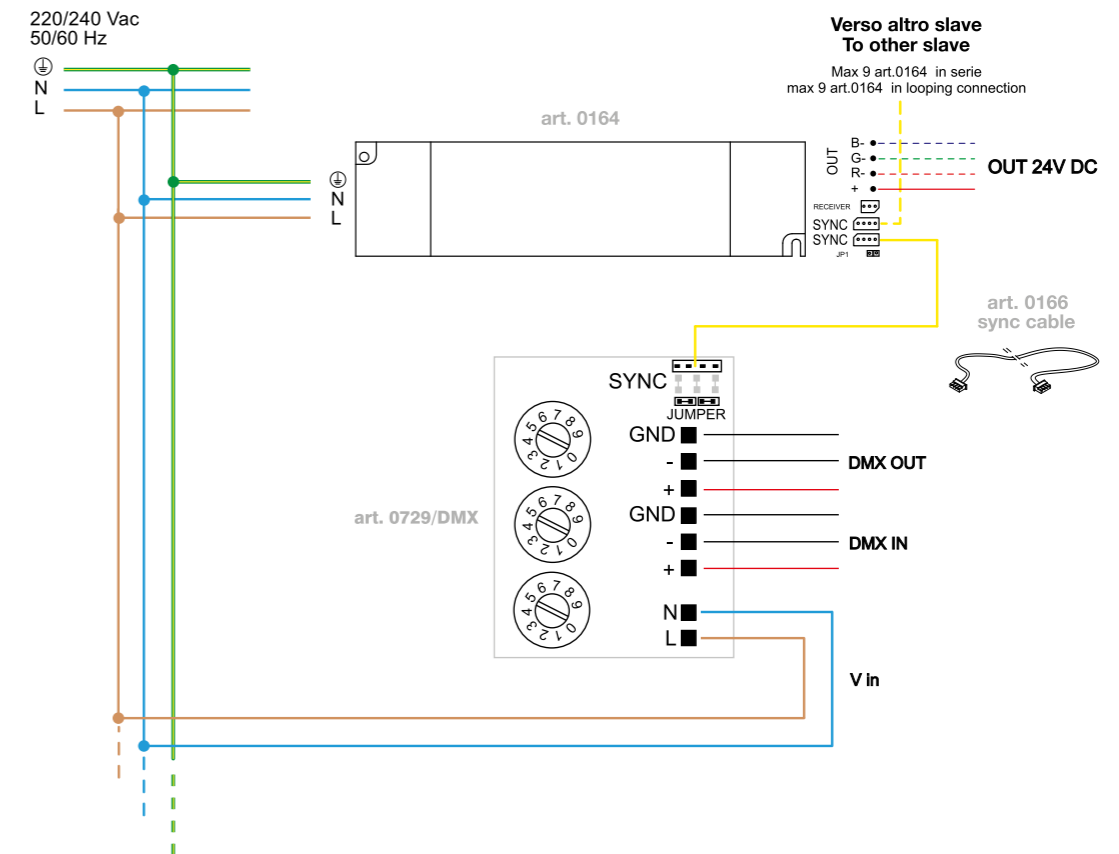

CONVERTITORE TENSIONE - CORRENTE COSTANTE PER COB LED

VOLTAGE - CURRENT CONVERTER FOR COB LED

Convertitore applicabile al modulo COB con ingresso in tensione costante e uscita in corrente costante 350mA (art. 0226) o 500mA (art. 0227). Regolazione della luminosità mediante PUSH 1...10V.

Da utilizzare con i seguenti articoli:

Converter applicable to the COB module with constant voltage input and constant current 350mA (art. 0226) or 500mA (art. 0227). Brightness adjustment via PUSH 1...10V. For use with the following items:

Technology

0226
Convertitore tensione - corrente
Voltage - current converter



IN: 24V
OUT: 350mA

0227
Convertitore tensione - corrente
Voltage - current converter



IN: 24V
OUT: 500mA

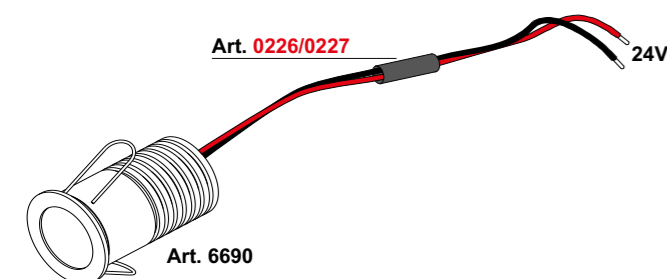

MODULO LED 24V

24V LED MODULE

Nuovissimo modulo LED a 24VDC 4W, ad alta efficienza.

Le dimensioni, 50 mm. di diametro, sono quelle delle tradizionali GU10 e ne consentono l'utilizzo in tutti gli spot della collezione EGOLUCE con simile attacco o dove sono utilizzati i moduli COB LED 0107 e 0108 (vedi tabelle)

Le peculiarità del modulo sono:

- lo spessore di soli 2,5 cm. che permette di ridurre notevolmente le altezze richieste per l'installazione dei faretti nei controsoffitti.
- Il collegamento che deve essere fatto in parallelo.

Brand new high efficiency 24VDC 4W LED module.

The dimensions, 50 mm. in diameter, are those of the traditional GU10 and allow their use in all the spots of the EGOLUCE collection with a similar connection or where the COB LED modules 0107 and 0108 are used (see tables)

The peculiarities of the module are:

- the thickness of only 2,5 cm. which allows to considerably reduce the heights required for the installation of spotlights in false ceilings.*
- The connection that must be made in parallel.*

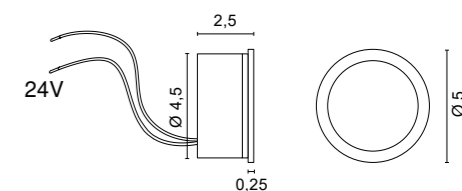

Color temperature	Optic	Light sources	lm
0107/24V/W	4000K	120° 24V 4W	658m
0107/24V/WW	3000K	120° 24V 4W	608lm
0107/24V/XW	2700K	120° 24V 4W	608lm

Solo collegamento in parallelo
Only parallel connection

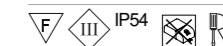

0,07 Kg

Elenco degli spot in cui è possibile utilizzare il modulo:
List of spots where the module can be used:

- Tappo
- Tappo adjustable
- Tappo quadro
- Geko
- Geko adjustable
- Easy
- Edy

Esempio di installazione modulo con 6460 Geko e con 6330 Tappo:
Example of module installation with 6460 Geko and with 6330 Tappo:

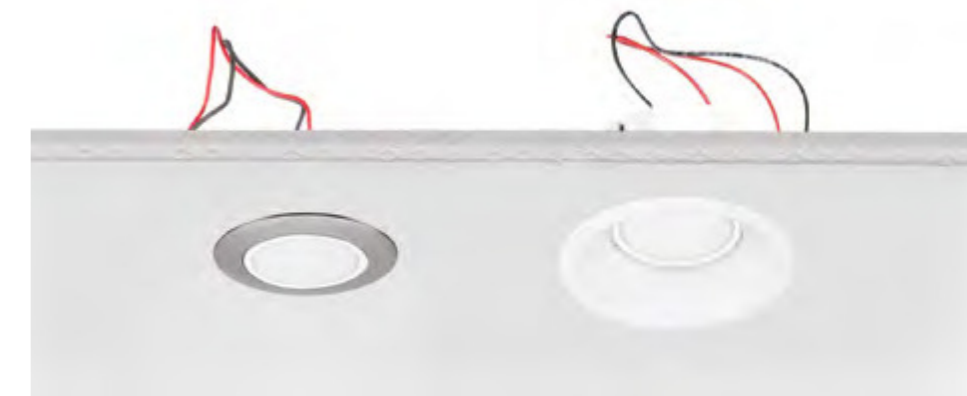
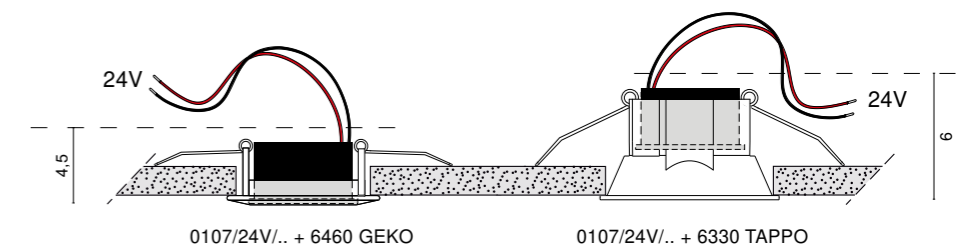

CONTROLLO EMERGENZA LED

LED EMERGENCY CONTROL

Technology



0115/EM (1h.) - 0115/EM/3 (3h.)

Gli alimentatori elettronici per illuminazione d'emergenza a funzionamento intermittente sono predisposti per alimentare LED di potenza (controllati in corrente) o moduli led (controllati in tensione) con la normale tensione di rete (220-240V - 50/60Hz), possono essere collegati per funzionamento permanente o non permanente, con qualsiasi tipo di alimentatore elettronico per LED. Tutti i modelli sono dotati di accumulatori ermetici al Ni-Cd in grado di garantire elevati rendimenti anche con alte temperature.

Caratteristiche tecniche:

- tensione di alimentazione: 220+240V - 50/60Hz
- tempo di funzionamento in emergenza: 1h o 3h
- tempo di ricarica: 24h
- collegabili ad alimentatori con tensione massima in uscita 90V, corrente massima in uscita 2A

Collegamenti:

- per non danneggiare i led collegare nell'ordine:
- sorgente LED
 - cavo batteria
 - alimentazione di rete
- non scollegare e ricollegare i LED con emergenza in funzione.

The electronic units for emergency lighting are suitable for power LED (current controlled) or LED modules (voltage controlled). They can be used indifferently for maintained (main, 220/240V - 50/60Hz, in combination with LED electronic driver), or emergency operation. All the models have sealed Ni-Cd batteries able to guarantee high efficiency with high temperatures.

Technical characteristics:

- supply voltage: 220+240V - 50/60Hz
- emergency light working time: 1h or 3h
- recharging time: 24h
- connected to power supplies 90V maximum output voltage 2A maximum output current

Wiring:

to not cause LED damage, please connect following this order:

- LED source
- battery cable
- mains connection

do not disconnect and connect the LED source during emergency operation.

0115/EM (1h.) - 0115/EM/3 (3h.)

Non permanente (solo emergenza) - Non-maintained (emergency only)

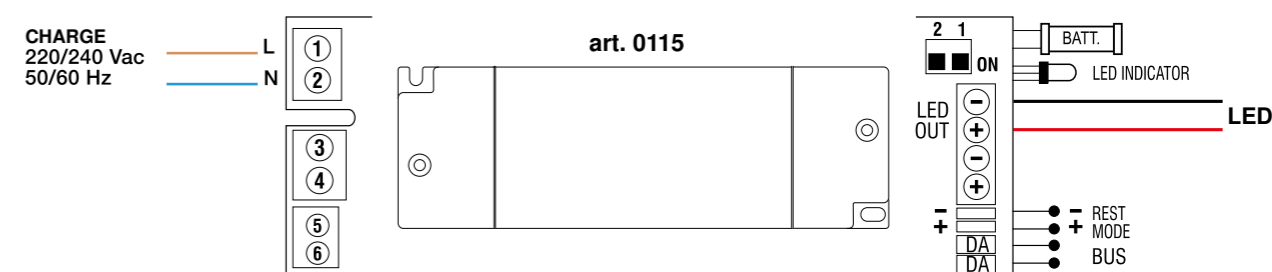

Technology

0115/EM (1h.) - 0115/EM/3 (3h.)

Permanente con alimentatore elettronico esterno (illuminazione ordinaria) - Maintained with external electronic driver

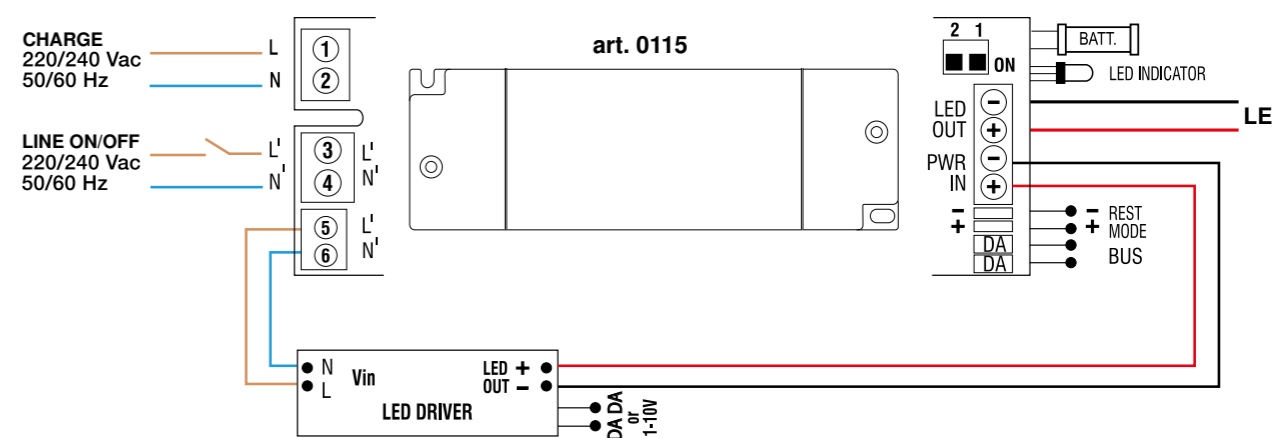



Technology

Tecnologia di comunicazione wireless per il controllo diretto da smartwatch, smartphone e tablet. Ideale per applicazioni residenziali e spazi commerciali.

CASAMBI è la giusta risposta ai clienti che cercano una soluzione che permetta la gestione semplice e User-friendly delle lampade, specialmente in ambito residenziale e commerciale.

CASAMBI consente di modificare l'intensità o il colore della luce in diversi modi. Questo sistema può essere usato per conseguire risparmi energetici, attivare scenari dinamici e fornire un'illuminazione incentrata sulle persone che ne promuovono il benessere.

Grazie alla funzione timer è possibile richiamare scene luminose in determinati orari. Oltretutto, i moduli **CASAMBI** sono provvisti della tecnologia beacon per cui la luce può essere impiegata come guida per individuare il percorso migliore per raggiungere una determinata meta o come funzione «seguiami». (la luce si accende solo quando l'utente è vicino alla lampada).

L'App **CASAMBI** è facile da usare, si scarica gratuitamente. Segui questi semplici passaggi.

1. Scarica l'App dall'Apple App Store o da Google Play Store.
2. Accendi i tuoi apparecchi **CASAMBI**.
3. Apri l'App.
4. L'app **CASAMBI** troverà automaticamente tutti gli apparecchi abilitati **CASAMBI** che sono accesi.
5. Tocca "Utilizza tutti gli apparecchi di illuminazione"
6. L'App **CASAMBI** aggiungerà automaticamente tutti gli apparecchi a una rete e apre la scheda "Apparecchi"

Se vuoi controllare i tuoi apparecchi da più di un dispositivo mobile devi farlo modificare le impostazioni di condivisione della rete.

Come impostazione predefinita, la rete creata non lo è condiviso e archiviato solo nel dispositivo che lo ha creato.

1. Vai alla scheda "Altro" e seleziona "Configurazione della rete" e "Impostazioni di condivisione".
2. Toccare la condivisione e si aprirà la schermata "Modalità di condivisione".
3. Esistono quattro diverse modalità di condivisione: non condivisa, solo amministratore, Protetto da password e Apri. Quando selezioni Solo amministratore, Protetto da password o modalità aperta la rete verrà caricata sul server cloud e quindi è possibile accedervi anche da altri dispositivi mobili.
4. Aggiungi un indirizzo e-mail e una password per la rete. L'indirizzo e-mail è necessario per l'accesso remoto e il recupero della password.
5. Confermare le impostazioni con "Salva".

Dispositivi supportati **CASAMBI** App per iOS:
Richiede iOS 9.0 o successivo. iPhone 4S, iPhone 5, iPhone 5S, iPhone 5C o modelli più recenti, iPad di terza generazione (2012, A14xx) o più recenti, iPad mini tutti i modelli, iPod touch di sesta generazione o più recente.

Dispositivi supportati App **CASAMBI** per Android:
Requisiti minimi: dispositivi con Android 4.4 KitKat e BLE (Bluetooth Low Energy, BT 4.0)
Requisiti consigliati: dispositivi con Android 5.0 Lollipop o successivo e BLE (Bluetooth Low Energy, BT 4.0)

Wireless communication technology for direct control from smartwatches, smartphones and tablets. Ideal for residential applications and commercial spaces.

CASAMBI is the right answer for customers looking for a mesh solution that allows management simple and user-friendly of the lamps, especially in residential and commercial environments.

CASAMBI allows you to change the intensity or color of light in different ways. This system can be used to achieve energy savings, activate dynamic scenarios and provide lighting focused on the people who promote their well-being.

Thanks to the timer function it is possible to recall light scenes at certain times. Moreover, **CASAMBI** modules are equipped with beacon technology whereby light can be used as guide to identify the best route to reach a certain destination or function "Follow me" (the light comes on only when the user is near the lamp).

It's very simple: download the **CASAMBI** app for free and follow these simple steps.

1. Download the app from Apple App Store or Google Play Store.
2. Turn on your **CASAMBI** enabled luminaires.
3. Open the app.
4. **CASAMBI** app will automatically find all **CASAMBI** enabled luminaires that are switched on.
5. Tap on the 'Take all luminaires into use'
6. **CASAMBI** app will automatically add all luminaires to one network and open the 'Luminaires' tab

If you want to control your luminaires from more than one mobile device you need to change the network sharing settings.

As a default the created network is not shared and only stored in the device that created it.

1. Go to 'More' tab and select 'Network setup' and 'Sharing settings'.
2. Tap on the Sharing and the 'Sharing mode' screen will open.
3. There are four different sharing modes: Not Shared, Administrator only, Password protected and Open. When you select Administrator only, Password protected or Open mode the network will be uploaded to cloud server and then it can be accessed also from other mobile devices.
4. Add an email address and a password for the network. Email address is needed for remote access and password recovery.
5. Confirm your settings with 'Save'.

Supported devices **CASAMBI** App for iOS:
Requires iOS 9.0 or later. iPhone 4S, iPhone 5, iPhone 5S, iPhone 5C or newer models, 3rd generation iPad (2012, A14xx) or newer, iPad mini all models, 6th generation iPod touch or newer.

Supported devices **CASAMBI** App for Android:
Minimum Requirements: Devices with Android 4.4 KitKat and BLE (Bluetooth Low Energy, BT 4.0)
Recommended Requirements: Devices with Android 5.0 Lollipop or Later and BLE (Bluetooth Low Energy, BT 4.0)



Technology

Alimentatore elettronico regolabile con uscita in tensione per moduli LED, tre uscite per moduli LED (RGB) con integrato modulo wireless CASAMBI.

Dimmable electronic driver with output voltage for LED modules, three outputs for LED modules (RGB) with integrated wireless CASAMBI module.



CASAMBI PROFILE	Channels
Independent channel mode Modalità canali indipendenti	CH 0 - 1 - 2
Tunable White mode Modalità Tunable White	CH 0 (W) - 1 (C)
RGB mode Modalità RGB	CH 0 - 1 - 2

0164/CASA - RGB (120W) FOR LED STRIP

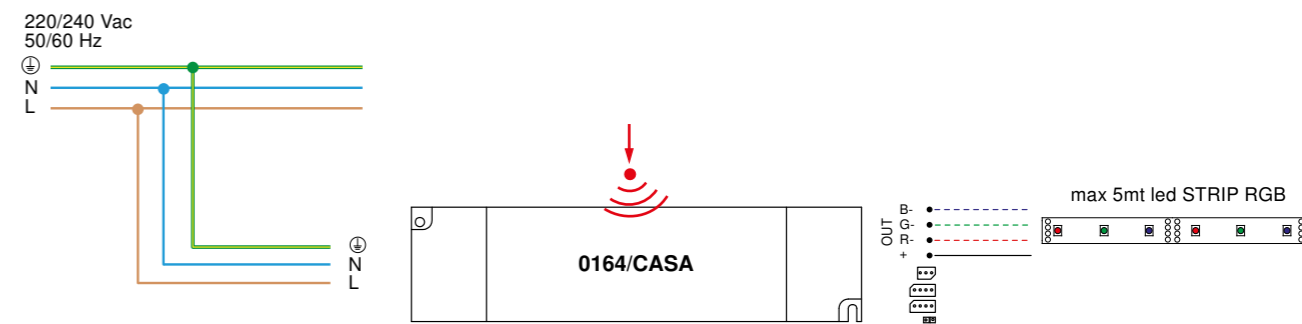

0164/CASA - RGB (120W)

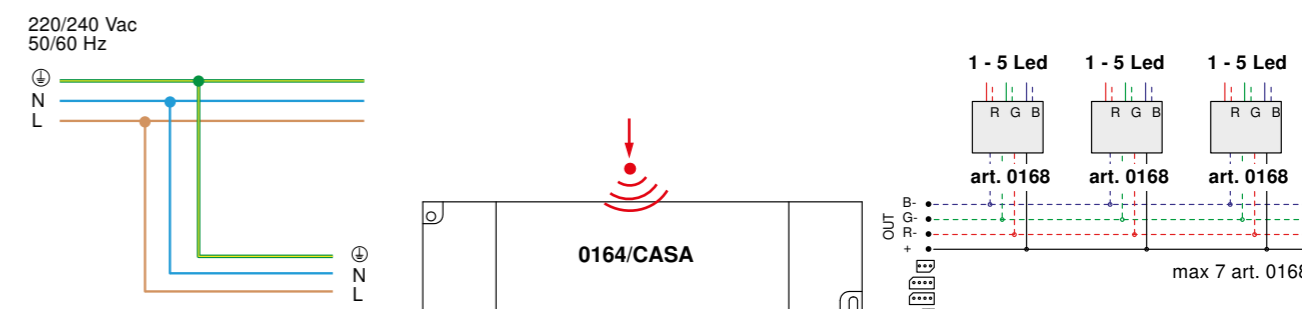



Technology

Oggi è possibile gestire numerose funzioni e differenti scenari luminosi in modo semplice e veloce tramite il proprio smartphone, smartwatches e tablet. Ne è un esempio l'applicazione CASAMBI che permette di accendere e spegnere la luce, impostare l'intensità ideale, creare scenari diversi nei luoghi di lavoro o all'interno di negozi in modo semplice e senza la presenza di installatori.

Today it is possible to manage numerous functions and different lighting scenarios quickly and easily using your smartphone, smartwatches and tablets. An example of this is the CASAMBI application that allows you to switch the light on and off, set the ideal intensity, create different scenarios in workplaces or inside shops in a simple way and without the presence of installers.

L'applicazione CASAMBI (disponibile per Android e Apple) si connette tramite bluetooth alle lampade. Anche l'utilizzo dell'APP è facile: basta scattare una foto delle stanze e collocare i controlli delle lampade nelle immagini stesse così da poter gestire il tutto in maniera intuitiva. Le APP possono essere utilizzate da uno o più utenti ed è possibile comandare un solo apparecchio, una stanza o un gruppo di elementi.

The CASAMBI application (available for Android and Apple) connects via bluetooth to the lamps. Even the use of the APP is easy: just take a photo of the rooms and place the lamp controls in the images themselves so that you can manage everything intuitively. APP can be used by one or more users and it is possible to control a single device, a room or a group of elements.

EGOLUCE propone una serie di driver TCI basati su queste tecnologie per controllare faretto, lampade ad incasso e proiettori su binario a tensione di rete 230V.

EGOLUCE proposes a series of TCI drivers based on these technologies to control spotlights, recessed lamps and 230V mains voltage track projectors.



0145/CASA

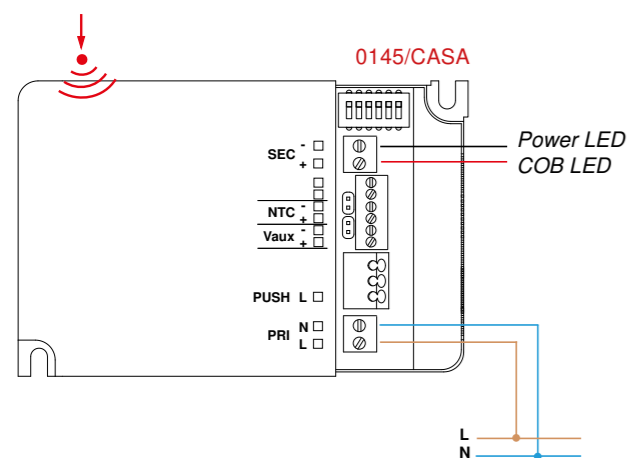

Download on the App Store | Get it on Google Play

To be used through APP available on Apple Store and Play Store for iOS and Android.
Utilizzabile tramite APP disponibile su Apple Store e Play Store per sistemi iOS e Android.



Technology



Dispositivo multipotenza fornito di dip-switch per la selezione della corrente in uscita con integrato modulo wireless CASAMBI. L'adattatore è da ordinare come articolo speciale e verrà fornito con l'apparecchio scelto. Può essere integrato con tutta la collezione NEWTON TRACK 230V e con tutte le soluzioni LED che lo permettono.

Multipower device supplied with dip-switch for the selection of the output current with integrated wireless CASAMBI module. The adapter is to be ordered as a special item and will be supplied with the chosen lamp. It can be integrated with the NEWTON TRACK 230V collection and with all the LED solutions that allow it.

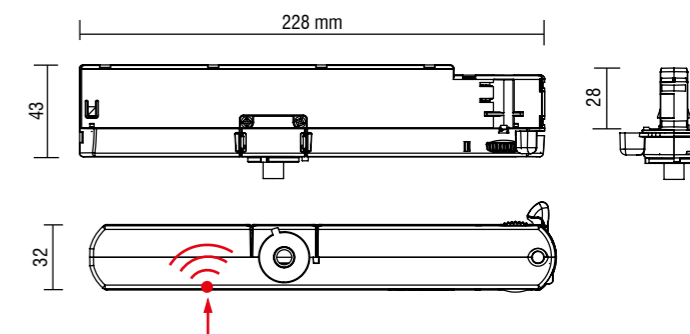

Download on the App Store | Get it on Google Play

To be used through APP available on Apple Store and Play Store for iOS and Android.
Utilizzabile tramite APP disponibile su Apple Store e Play Store per sistemi iOS e Android.

0199
Kit Vetro
Kit diffuser Glass

Edy



0200
Cassaforma per calcestruzzo
Wall box for concrete
15,5 x 12 x 9h cm.



0201
Plaster kit.
15 x 15 x 0,9h cm.
Edy



0281/O
Plaster kit.
Star Adjustable



0282/C
Plaster kit.
Star Medium tondo



0282/Q
Plaster kit.
Star Medium quadro



0206
Cassaforma tonda per installazione in cartongesso a scomparsa
Round wall box for installation in plasterboard false ceiling

.01 Bianco - White
.02 Nero - Black

Star 1 - Star 2 - Star IP - Star RGB

6,7 cm.



0207
Cassaforma quadrata per installazione in cartongesso a scomparsa
Square wall box for installation in plasterboard false ceiling

.01 Bianco - White
.02 Nero - Black

Star 1 - Star 2 - Star IP - Star RGB

5,5x5,5 cm.



0210/100 - 101,8 cm
0210/150 - 151,8 cm
0210/200 - 201,8 cm
0210/300 - 301,8 cm

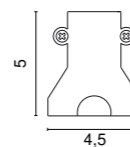

Cassaforma per calcestruzzo - Wall box for concrete
Linea

0208
Adattatore per doghe
Adapter for slats



Dot Tondo, Dot Quadro

0209
Adattatore per doghe
Adapter for slats



Pix Tondo, Pix Quadro, Pix RGB

0212 - ø 2
Box + Plaster

Alcor, Byte, Cruise, Dot,
Dot Plus, Sirio, Snorky,
Top Mini, Trim, Vega

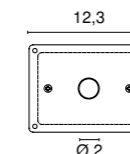
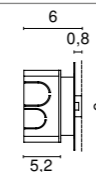

0213 - ø 3
Box + Plaster

Cerchietto, Fire, Ice,
Pix, Top, Snorky Maxi

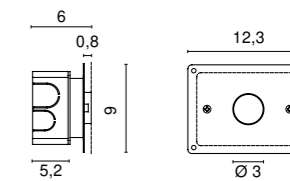

0214 - ø 3,8
Box + Plaster

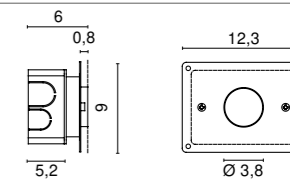

Spoon

0215 - ø 2
Plastic Box

Alcor, Byte, Cruise, Dot,
Dot Plus, Sirio, Snorky,
Top Mini, Trim, Vega

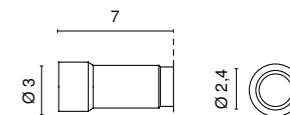

0216 - ø 3
Plastic box

Cerchietto, Ice, Kross, Top,
Vista, Fire, Zeppelin,
Zeppelin RGB, Zeppelin Plus,
Snorky Maxi

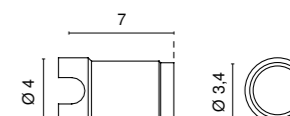

0217 - ø 3,8
Plastic box

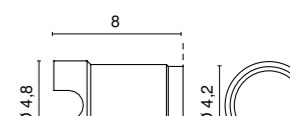

Cerchio, Cerchio RGB, Soft, Spoon

0218
Cassaforma per calcestruzzo
Wallbox for concrete

10 x 10,5 x 8,5h cm.
Edy Mini



0219
Plaster kit.

13 x 10 x 0,7h cm.
Edy Mini



0220 - ø 3
Kit cassaforma drenante
+ connettore stagno
Draining junction box
+ IP67 connector.



Kross, Zeppelin, Zeppelin Plus, Vista

0223
Cassaforma per calcestruzzo
Wall box for concrete



0224/C
Plaster kit.
Star 1 - Star 2
Star IP - Star RGB



0224/Q
Plaster kit.
Star 3 - Star 4



9,1 x 9,5 x 9h cm.
Star

0225
Cassaforma per muratura
Wall box for brick mounting



0224/C
Plaster kit
Star 1 - Star 2
Star IP - Star RGB



0224/Q
Plaster kit.
Star 3 - Star 4



9,5 x 6,5 x 9,5h cm.
Star

0228 - ø 3

Cassaforma drenante
Draining junction box

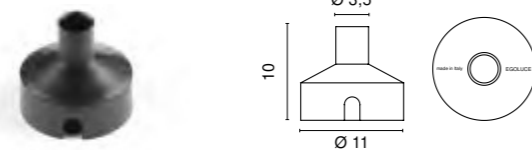

Zeppelin RGB

0229

Kit cassaforma drenante
+ connettore stagno
Draining junction box
+ IP67 connector.

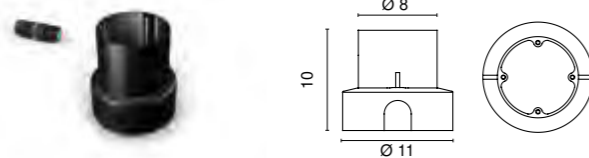

Drive

0230 - ø 6

Kit cassaforma drenante
+ connettore stagno
Draining junction box
+ IP67 connector.

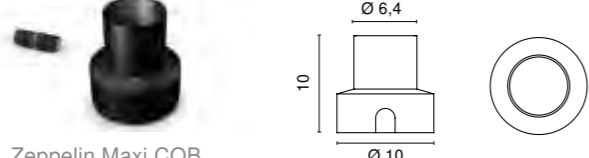

Zeppelin orientabile, Zeppelin Maxi, Zeppelin Maxi COB

0231

Kit cassaforma drenante
+ connettore stagno
Draining junction box
+ IP67 connector.

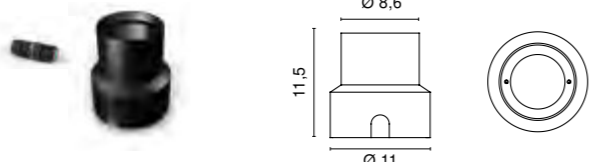

Tris

0232 - ø 6

Plastic box da parete
Wall plastic box

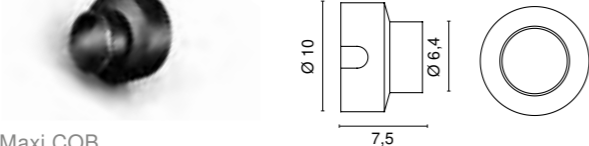

Zeppelin orientabile, Zeppelin Maxi,
Step, Zen Led, Modus Led, Zeppelin Maxi COB

0234

Plastic box RGB

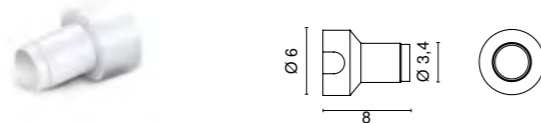

Pix, Pix RGB, Ice RGB, Vega Maxi RGB, Fire RGB, Alcor Maxi RGB

0235

Plastic box da parete
Wall plastic box

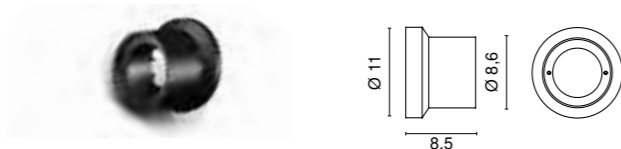

Tris

0243

Connettore IP per cavi Ø < 7.0 mm
IP Connector for cables Ø < 7.0 mm



Outdoor

0244/100 - 100 cm

0244/200 - 200 cm

0244/300 - 300 cm

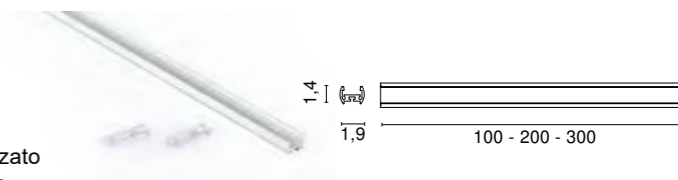

Profilo in alluminio anodizzato
Anodized aluminum profile

Picchetti per l'installazione temporanea a terreno
Stakes for temporary installation on field

0245 Agos - Spillo



0247 Vision1



0248 Vision3



0246/R

Box + Plate

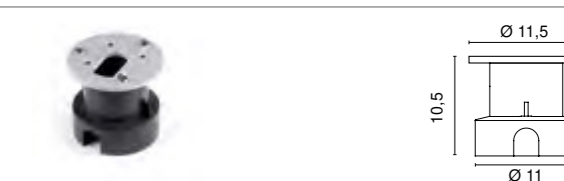

Raccordi di luce - Joy

0249

Box + Plaster

7x21x8,5 cm.



Slot

0250 - ø 3,8

Kit cassaforma drenante
+ connettore stagno
Draining junction box
+ IP67 connector.

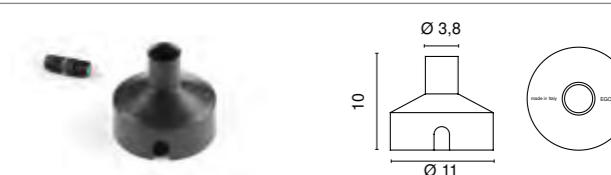

Soft, Cerchio

0251 - ø 3,8

Cassaforma drenante
Draining junction box

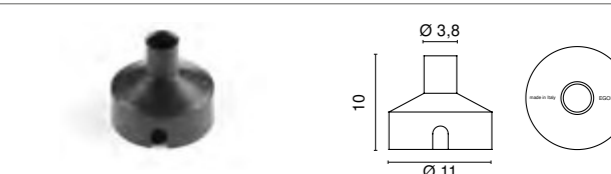

Cerchio RGB

0276

Connettore IP67
IP67 connector



Outdoor

LED DRIVERS IN CORRENTE CONTINUA - CONSTANT CURRENT

0125

IN: 100 - 240V
OUT: 350 mA - 1-6 Power LED 1W,
1 COB LED

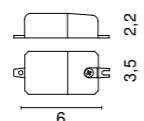

05 SELV 4,4 cm.

0125/250

IN: 100 - 240V
OUT: 350 mA

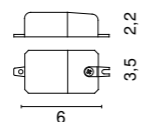

05 SELV 4,4 cm.

0126

IN: 110 - 240V
OUT: 700 mA

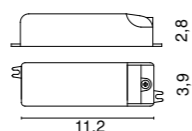

05 SELV 4,8 cm.

0127

IN: 100 - 240V
OUT: 500 mA - 1-6 Power LED 1,5W,
1 COB LED

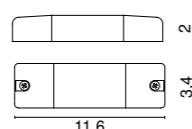

05 SELV 4 cm.

0128

IN: 100 - 240V
OUT: 350 mA - 1-10 Power LED 1W,
1-2 COB LED

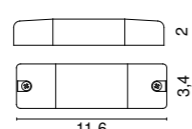

05 SELV 4 cm.

0136/15

IN: 100 - 240V
OUT: 350mA - 1-10 Power LED 1,5W,
1-2 COB LED



05 SELV 3,2 cm.

0147/COB

IN: 110 - 240V
OUT: 500 mA - 1-2 COB LED

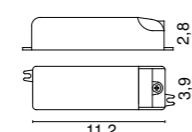

05 SELV 4,8 cm.

0148/COB

IN: 220 - 240V
OUT: 700 mA

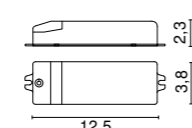

05 SELV 4,2 cm.

0149/COB

IN: 220 - 240V
OUT: 500 mA - 1 COB LED

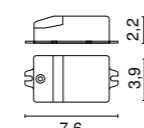

05 SELV 4,4 cm.

0151/150

IN: 220 - 240V
OUT: 150 mA - 1-2 Star IP

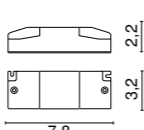

05 SELV 3,7 cm.

LED DRIVERS IN CORRENTE CONTINUA - CONSTANT CURRENT

0169/50

Multipower LED driver

IN: 220 - 240V
OUT: 350 mA
min. 4 max 22 Power LED 1W
1-3 COB LED

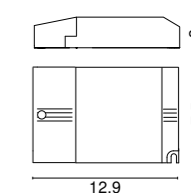

IN: 220 - 240V
OUT: 500 mA
min. 4 max 15 Power LED 2W
1-3 COB LED

IN: 220 - 240V
OUT: 700 mA

SELV 05 8,5 cm.

IP LED DRIVERS IN CORRENTE CONTINUA - CONSTANT CURRENT

0031/IP

IN: 220 - 240V
OUT: 350 mA - 1-12 Power LED 1W

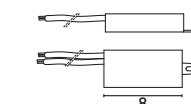

IP67 SELV 4,2 cm.

0143/IP

IN: 220 - 240V
OUT: 500 mA - 1-7 Power LED 1,5W

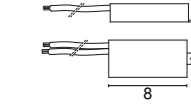

IP67 SELV 4,5 cm.

0129

IN: 110 - 240V
 OUT: 350 mA - 4-15 Power LED, 1-2 COB LED
 500 mA - 1-14 Power leds, 1-2 COB LED

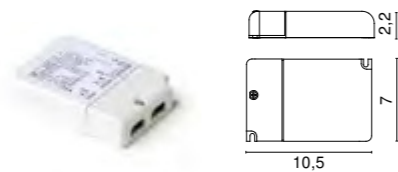

PUSH **1...10V** **C** **RU** **US** SELV 7,2 cm.

0129/DALI

IN: 110 - 240V
 OUT: 350 mA - 2-12 Power LED, 1-2 COB LED
 500 mA - 2-12 Power LED, 1-2 COB LED
 12V DC - 10W
 24V DC - 20W

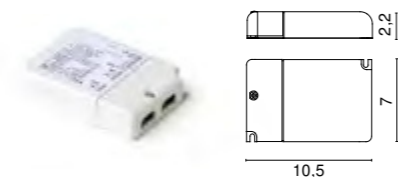

DALI SELV 7,2 cm.

0141/DALI

IN: 110 - 240V
 OUT: 350 mA - 1-12 Power LED, 1-2 COB LED
 500 mA - 1-11 Power LED, 1-2 COB LED

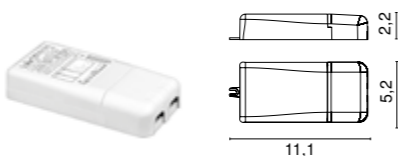

DALI SELV 5,5 cm.

0141/DIM

IN: 110 - 240V
 OUT: 350 mA - 1-12 Power LED, 1-2 COB LED
 500 mA - 1-11 Power LED, 1-2 COB LED

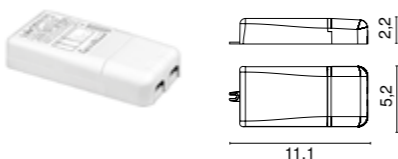

PUSH **1...10V** SELV 5,5 cm.

0145

IN: 110 - 240V
 OUT: 350 mA - 1- 21 Power LED, 1-3 COB LED
 500 mA - 1-21 Power LED, 1-3 COB LED

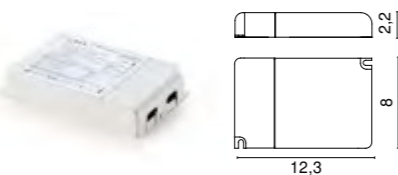

PUSH **1...10V** SELV 8,4 cm.

0145/DALI

IN: 110 - 240V
 OUT: 350 mA - 1- 21 Power LED, 1-3 COB LED
 500 mA - 1-21 Power LED, 1-3 COB LED

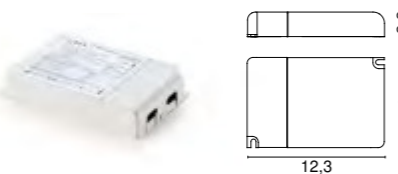

PUSH **1...10V** **DALI** SELV 8,4 cm.

0133

Cavo di sincronizzazione per dimmer LED
 Synchronization cable for dimmer LED



0129, 0129/DALI, 0145, 0145/DALI

0726/DIM

Dimmable driver
 TAGLIO DI FASE (IGBT-TRIAC, TRAILING EDGE-LEADING EDGE)
 PHASE CUT-OFF (IGBT-TRIAC, TRAILING EDGE-LEADING EDGE)
 IN: 220 - 240V
 OUT: 24V - 20W
 350 mA - 1-12 Power LED, 1-2 COB LED
 500 mA - 1-12 Power LED, 1-2 COB LED
 700 mA

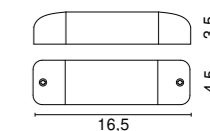

IGBT/TRIAC SELV 5,6 cm.

0733/DIM

Dimmable driver
 TAGLIO DI FASE (IGBT-TRIAC, TRAILING EDGE-LEADING EDGE)
 PHASE CUT-OFF (IGBT-TRIAC, TRAILING EDGE-LEADING EDGE)
 IN: 220 - 240V
 OUT: 350 mA - 1 COB LED

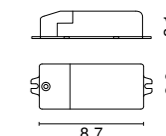

IGBT/TRIAC SELV 4,2 cm.

0734/DIM

Dimmable driver
 TAGLIO DI FASE (IGBT-TRIAC, TRAILING EDGE-LEADING EDGE)
 PHASE CUT-OFF (IGBT-TRIAC, TRAILING EDGE-LEADING EDGE)
 IN: 220 - 240V
 OUT: 500 mA - 1 COB LED

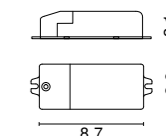

IGBT/TRIAC SELV 4,2 cm.

0130

IN: 220 - 240V
OUT: 8V - 1-40 Lucciola

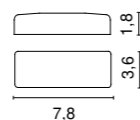

SELV 4,5 cm.

0155

IN: 100 - 240V
OUT: 24V - 13W



SELV 3,2 cm.

0156

IN: 100 - 240V
OUT: 24V - 25W

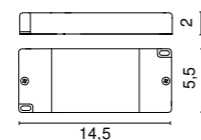

SELV 6 cm.

0157

IN: 220 - 240V
OUT: 24V - 75W

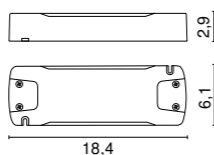

SELV 6,8 cm.

0157/48

IN: 220 - 240V
OUT: 48V - 70W

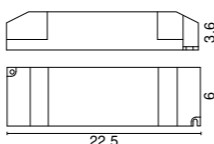

SELV 7 cm.

0159

IN: 100 - 240V
OUT: 12V - 25W

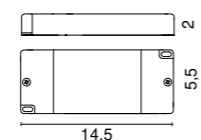

SELV 6 cm.

0160

IN: 220 - 240V
OUT: 24V - 60W

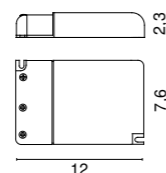

SELV 8 cm.

0160/48

IN: 220 - 240V
OUT: 48V - 70W

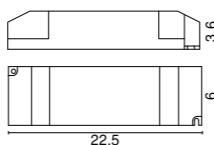

SELV 7 cm.

0161/100

IN: 220 - 240V
OUT: 24V - 100W

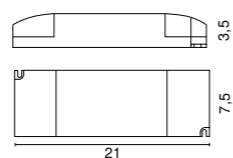

SELV 8 cm.

0161/150

IN: 220 - 240V
OUT: 24V - 150W

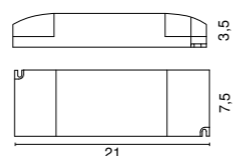

SELV 8 cm.

0162/48

IN: 220 - 240V
OUT: 48V - 150W

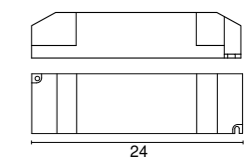

SELV 8 cm.

0173

IN: 100 - 240V
OUT: 12V - 50W

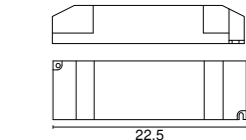

SELV 7 cm.

IP LED DRIVERS IN CORRENTE CONTINUA - CONSTANT CURRENT

0033/IP

IN: 220 - 240V
OUT: 24V - 14,4W

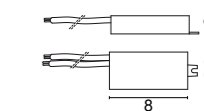

IP67 SELV 4,2 cm.

0034/IP

IN: 220 - 240V
OUT: 24V - 70W

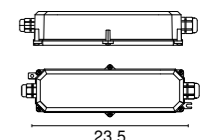

IP67 SELV

0035/IP

IN: 220 - 240V
OUT: 24V - 160W

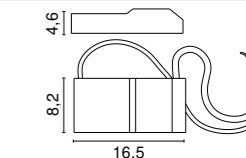

IP65 SELV 9,6 cm.

0036/IP

IN: 220 - 240V
OUT: 12V - 14,4W

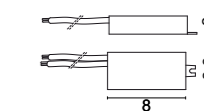

IP67 SELV 4,2 cm.

0038/IP

IN: 220 - 240V
OUT: 24V - 100W

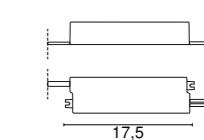

IP65 SELV 5,8 cm.

0039/IP

IN: 220 - 240V
OUT: 24V - 150W

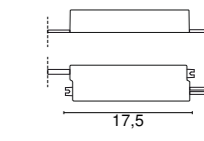

IP65 SELV 5,8 cm.

0717/DIM60

IN: 220 - 240V
OUT: 24V - 60W



PUSH **DALI** SELV 8 cm

0717/DIM60/V

IN: 220 - 240V
OUT: 24V - 60W



1...10V SELV 8 cm

0717/DIM100

IN: 220 - 240V
OUT: 24V - 100W

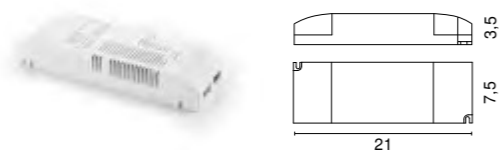

PUSH **1...10V** **DALI** SELV 8,2 cm

0717/DIM150

IN: 220 - 240V
OUT: 24V - 150W

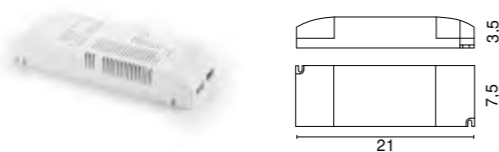

PUSH **1...10V** **DALI** SELV 8,2 cm

0727/DIM30

Dimmable driver
TAGLIO DI FASE (TRAILING EDGE-LEADING EDGE)
PHASE CUT-OFF (TRAILING EDGE-LEADING EDGE)
IN: 220 - 240V
OUT: 24V - 30W

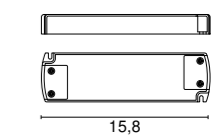

TRIAC SELV 4,9 cm

0727/DIM50

Dimmable driver
TAGLIO DI FASE (TRAILING EDGE-LEADING EDGE)
PHASE CUT-OFF (TRAILING EDGE-LEADING EDGE)
IN: 220 - 240V
OUT: 24V - 50W

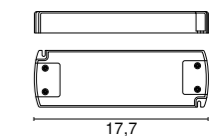

TRIAC SELV 6,1 cm

0727/DIM75

Dimmable driver
TAGLIO DI FASE (TRAILING EDGE-LEADING EDGE)
PHASE CUT-OFF (TRAILING EDGE-LEADING EDGE)
IN: 220 - 240V
OUT: 24V - 75W

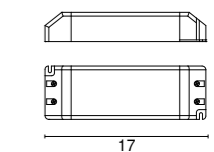

TRIAC SELV 6,3 cm

0727/DIM150

Dimmable driver
TAGLIO DI FASE (TRAILING EDGE-LEADING EDGE)
PHASE CUT-OFF (TRAILING EDGE-LEADING EDGE)
IN: 220 - 240V
OUT: 24V - 150W

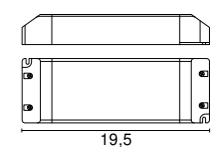

TRIAC SELV 7,4 cm

DMX INTERFACE

0729/DMX

Convertitore di segnale DMX - PWM
DMX - PWM Signal converter
IN: 100 - 240V

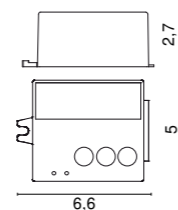

0164, 0167

0166

Cavo di sincronizzazione
Synchronization cable

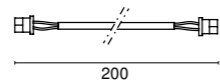

0164, 0167, 0729/DMX

UNITA' DI EMERGENZA LED - LED EMERGENCY UNIT

0115/EM

Kit Inverter + Battery

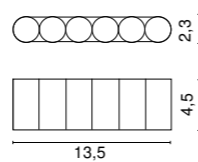
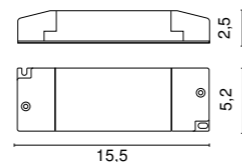

0115/EM/3

Kit Inverter + Battery 3h.

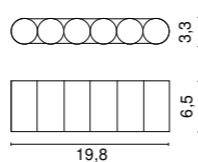
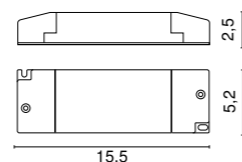

DIMMER PER DRIVER A TENSIONE COSTANTE - FOR CONSTANT VOLTAGE DRIVERS

I dimmer sono da installare con i driver A tensione costante ON/OFF da scegliere in base al carico del sistema.
The dimmers are to be installed with constant voltage ON/OFF drivers to be chosen according to the system load.

0110/DIM

IN: 12/24V 12A MAX
OUT: 12/24/48V

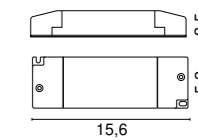

PUSH **1...10V** **DALI** SELV 5,6 cm

0110/DIM/MINI

IN: 12/24V 6A MAX
OUT: 12/24/48V

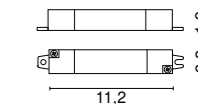

PUSH **1...10V** **DALI** SELV 2,8 cm

CONVERTITORE TENSIONE - CORRENTE COSTANTE PER COB LED VOLTAGE - CURRENT CONVERTER FOR COB LED

0226

Convertitore tensione - corrente
Voltage - current converter

IN: 24V
OUT: 350mA



0227

Convertitore tensione - corrente
Voltage - current converter

IN: 24V
OUT: 500mA



RGB DRIVERS

0167 Driver RGB 22W
IN: 220-240V
OUT: 3x24V

PUSH Remote 5,6 cm

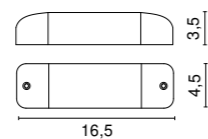

0164 Driver RGB 120W
IN: 220-240V
OUT: 3x24V

PUSH Remote 8 cm

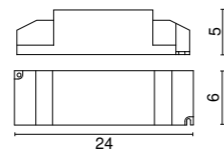

0168 Converter
IN: 3x24V
OUT: 3x250 mA 1-5 RGB

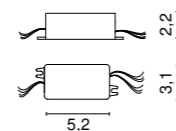

0163 IR Receiver

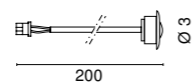

0164, 0167 2,5 cm

0165 IR Remote Controller

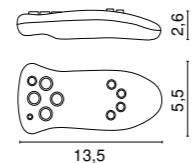

0166
Cavo di sincronizzazione
Synchronization cable

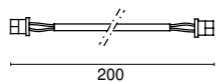

0164, 0167

0152
Kit Lucciola RGB - art. 6353
Centralina RGB + Telecomando
RGB controller + Remote control



Centraline RGB non sincronizzabili tra loro
RGB controller cannot be synchronized with each other

WIRELESS BLUETOOTH DRIVERS

0718/CASA

Alimentatori multipotenza in corrente continua regolabili wireless.

Direct current dimmable wireless multipower drivers.

IN: 220-240V
OUT: max 38W

CASAMBI **PUSH** SELV 60V 5,4 cm

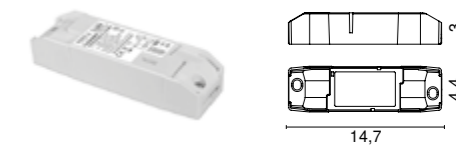

0145/CASA

Alimentatori multipotenza in corrente continua regolabili wireless.

Direct current dimmable wireless multipower drivers.

IN: 220-240V
OUT: max 60W

CASAMBI **PUSH** SELV 60V 8,4 cm

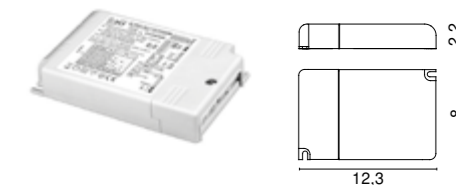

0164/CASA Driver RGB 120W

Alimentatori multipotenza in corrente continua regolabili wireless.

Direct current dimmable wireless multipower drivers.

IN: 220-240V
OUT: 3x24V
CASAMBI 8 cm



LED

POWER LED

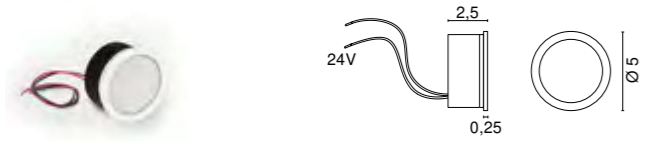

Color temperature	Optic	Light sources	lm
0107/24/W 4000K	120°	24V 4W	658lm
0107/24/W/W 3000K	120°	24V 4W	608lm
0107/24/W/XW 2700K	120°	24V 4W	608lm

COB LED CRI>90

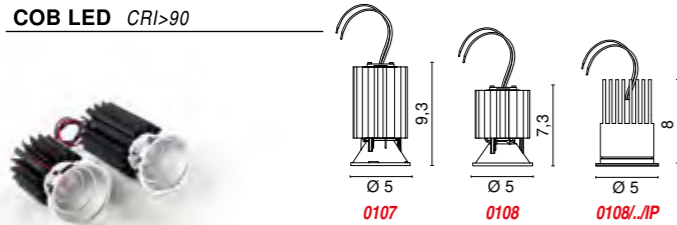





Color temperature	Optics	COB LED light source	lm source	lm output
0107/W 4000K	/24 /40 /60 /ST	5,9W 17V 350mA	885lm	695lm
0107/W/W 3000K	/24 /40 /60 /ST	5,9W 17V 350mA	836lm	657lm
0107/W/XW 2700K	/24 /40 /60 /ST	5,9W 17V 350mA	800lm	629lm

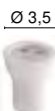

0108/W 4000K	/24 /40 /60 /ST	8,7W 17,5V 500mA	1223lm	957lm
0108/W/W 3000K	/24 /40 /60 /ST	8,7W 17,5V 500mA	1156lm	905lm
0108/W/XW 2700K	/24 /40 /60 /ST	8,7W 17,5V 500mA	1106lm	865lm

0108/W/IP 4000K	/24 /38 /58	IP44 8,7W 17,5V 500mA	1223lm	957lm
0108/W/W/IP 3000K	/24 /38 /58	IP44 8,7W 17,5V 500mA	1156lm	905lm
0108/W/XW/IP 2700K	/24 /38 /58	IP44 8,7W 17,5V 500mA	1106lm	865lm

0092/16  50/60Hz 220-240V
3,5W G9 LED 350lm 3000K

0093/19  Ø 3,5 50/60Hz 220-240V
3W GU10 LED 185lm 3000K 

0094  Ø 5 50/60Hz 220-240V
/W 4000K GU 10 LED 7W 630lm
/WW 3000K GU 10 LED 7W 600lm
/XW 2700K GU 10 LED 7W 580lm 

0104  Ø 5 50/60Hz 220-240V
/W 4000K GU 10 LED 7W 550lm
/WW 3000K GU 10 LED 7W 530lm
/XW 2700K GU 10 LED 7W 510lm
Dimmerabile - Dimmable 

ONLY FOR LED VERSIONS



Dischi reggi lampadina
Dischi in metacrilato per il fissaggio del modulo LED da utilizzare come alternativa alle molle a filo.
Disponibili in finitura trasparente (TR) o satinata (ST).

Bulb fixers
Methacrylate disks for fixing LED module to be used instead of the wire springs.
Available in clear finish (TR) or satin (ST).

AVAILABLE FOR:



EXAMPLES:



6330 - Standard



6330 - Con 0183/ST
With 0183/ST





6330 - Con 0183/TR
With 0183/TR

0105/12  Ø 6 11,7 50/60Hz 220-240V
12W E27 LED 1055lm 3000K

0105/15  Ø 7 12,8 50/60Hz 220-240V
15W E27 LED 1521lm 3000K

0105/30  Ø 11 20 50/60Hz 220-240V
30W E27 LED 3000lm 3000K

0105/MINI  Ø 4,5 8,5 50/60Hz 220-240V
6W E14 LED 600lm 3000K

0102  Ø 12,5 17,5 50/60Hz 220-240V
7,5W E27 LED 806lm 2700K

0109/8  Ø 7 12 50/60Hz 220-240V
/W 4000K E27 LED 8W 1055lm
/XW 2700K E27 LED 8W 1055lm

0109/12  Ø 7 12 50/60Hz 220-240V
/W 4000K E27 LED 12W 1800lm
/XW 2700K E27 LED 12W 1800lm

0109/15  Ø 7 12 50/60Hz 220-240V
/W 4000K E27 LED 15W 2200lm
/XW 2700K E27 LED 15W 2200lm

INDEX

CODICE	PRODOTTO	Pag	CODICE	PRODOTTO	Pag	CODICE	PRODOTTO	Pag	CODICE	PRODOTTO	Pag
3540	AGOS	298	6753	IRIS	34	6452	NEWTON SLIM TRACK 48V	131	6707	STAR MAXI 3	68
3541	AGOS	298	6754	IRIS	34	1591	NEWTON TRACK 230V	148	6708	STAR MAXI 4	68
4680	AGOS	300	6704	IRIS TRACK 48V	135	6370	NEWTON TRACK 230V	142	6710	STAR MEDIUM 1	58
4681	AGOS	301	6717	IRIS TRACK 48V	135	6466	NEWTON TRACK 230V	142	6711	STAR MEDIUM 2	59
6360	ALCOR	282	5538	JAZZ	346	6467	NEWTON TRACK 230V	142	6713	STAR MEDIUM 3	60
6379	ALCOR MAXI RGB	284	6314	KRONO	104	1591	NEWTON TRACK 48V	136	6714	STAR MEDIUM 4	61
6668	ALYA	172	6361	KROSS	340	6343	NEWTON TRACK 48V	130	6712	STAR MEDIUM ASYMMETRIC	62
6669	ALYA 230V	172	6735	KROSS MINI	341	6345	NEWTON TRACK 48V	130	6693	STAR RGB	55
1549	BALOOON TRACK 230V MONOFASE	154	6685	KUMA	176	6346	NEWTON TRACK 48V	130	6689	STAR ZERO	168
1549	BALOOON TRACK 230V TRIFASE	146	6686	KUMA 230V	176	6324	OCCHIO	109	6204	STELLA	111
6391	CERCHIETTO	292	1565	LANCIA CAVO	192	1568	PEVERA TRACK 230V	148	6739	STEP MINI QUADRO	339
6389	CERCHIO	336	1672	LANCIA NO LIMITS CAVO	194	1568	PEVERA TRACK 48V	136	6738	STEP MINI TONDO	339
6390	CERCHIO RGB	337	1171	LANCIA TONDA CAVO	200	6323	PIX QUADRO	288	6369	STEP QUADRO	338
6240	CORNO 12V	110	1172	LANCIA TONDA CAVO	200	6413	PIX RGB QUADRO	290	6387	STEP TONDO	338
6241	CORNO 230V	110	1173	LANCIA TONDA CAVO	200	6375	PIX RGB TONDO	290	1581	STICK TRACK 230V	149
6238	CORNO MINI 230V	110	2550	LARA	306	6322	PIX TONDO	288	1580	STICK TRACK 230V	149
6382	CRUISE	292	1690	LARA MAXI	308	4515	PLANA	250	1582	STICK TRACK 230V	149
6409	DISSY QUADRO	76	2552	LARA MAXI	307	1516	PRÈT-À-PORTER TRACK 230V MONOFASE	154	1580	STICK TRACK 48V	137
6410	DISSY TONDO	76	2553	LARA MAXI	307	1516	PRÈT-À-PORTER TRACK 230V TRIFASE	146	1581	STICK TRACK 48V	137
6317	DOT PLUS QUADRO	271	3551	LARA MAXI	309	4672	RACCORDI DI LUCE SYSTEM / JOY	24	1582	STICK TRACK 48V	137
6316	DOT PLUS TONDO	271	3552	LARA MAXI	309	4673	RACCORDI DI LUCE SYSTEM / JOY	24	6666	TANYA	170
6321	DOT QUADRO	270	6615	LINEA	236	5690	RACCORDI DI LUCE SYSTEM / JOY	25	6667	TANYA 230V	170
6320	DOT TONDO	270	6616	LINEA	236	7516	RACCORDI DI LUCE SYSTEM / JOY	14	6330	TAPPO	84
6729	DRIVE	344	6655	LINEA MAXI	240	5542	RAIL SYSTEM CEILING/WALL	210	6329	TAPPO 230V	85
5520	DRUM	348	6656	LINEA MAXI	240	5543	RAIL SYSTEM CEILING/WALL	210	6318	TAPPO ADJUSTABLE	86
6431	EASY QUADRO	80	6657	LINEA MAXI RGB	240	6660	RAIL SYSTEM RECESSED	230	6319	TAPPO ADJUSTABLE 230V	86
6432	EASY QUADRO 230V	80	6658	LINEA MAXI RGB	240	1543	RAIL SYSTEM SUSPENSION	216	6561	TAPPO EDISON	108
6441	EASY TONDO	81	6617	LINEA RGB	236	1544	RAIL SYSTEM SUSPENSION	216	6325	TAPPO MINI	87
6442	EASY TONDO 230V	81	6618	LINEA RGB	236	4580	RAIL SYSTEM WALL	224	6688	TAPPO QUADRO	88
4625	ECLIPSE IP	349	6372	LUCCIOLA	278	4581	RAIL SYSTEM WALL	224	6363	TOP	286
1598	EDISON SYSTEM	204	6353	LUCCIOLA RGB	279	5613	RIGA	258	6740	TOP IP	286
5612	EDISON SYSTEM	204	4522	MAGIKA	252	1684	RIGA SUSPENSION	259	6364	TOP MINI	287
1598	EDISON TRACK 230V MONOFASE	155	4523	MAGIKA	252	5539	ROC	347	1662	TRE&SESSANTA	188
1598	EDISON TRACK 230V TRIFASE	147	6687	MERAK	178	6725	SEGMENTO DARK MINI TRACK 24V TINY	164	6337	TRIM QUADRO BIEMISSION	272
6305	EDY	94	6688	MERAK 230V	178	6697	SEGMENTO DARK TRACK 48V	134	6339	TRIM QUADRO SINGLE EMISSION	272
6302	EDY 230V	95	1133	MIR TRACK 230V MONOFASE	154	6724	SEGMENTO MINI TRACK 24V TINY	164	6336	TRIM TONDO BIEMISSION	272
6298	EDY MINI	92	1133	MIR TRACK 230V TRIFASE	146	6699	SEGMENTO TRACK 48V	134	6338	TRIM TONDO SINGLE EMISSION	272
6299	EDY MINI 45°	92	6609	MIRAGE	175	6700	SEGMENTO TRACK 48V	134	6371	TRIS	334
1661	EGOTUBE TRACK 230V MONOFASE	155	6605	MIRAGE MINI	174	6359	SIRIO	282	6358	VEGA	282
1661	EGOTUBE TRACK 230V TRIFASE	147	6265	MODUS	107	6381	SLOT	293	6378	VEGA MAXI RGB	284
6263	EOS PIU'	111	6398	MODUS LED	106	6373	SNORKY	268	4589	VELA	256
4521	EXTRA	246	6342	NEWTON	44	6698	SNORKY INCASSO	109	4510	VISION 1	320
6340	FIRE	274	6344	NEWTON	44	6313	SNORKY MAXI	269	4511	VISION 3	321
6341	FIRE RGB	275	6326	NEWTON EASY	49	6388	SOFT	335	4555	VISION 3 COB	321
6249	GAMMA	111	6481	NEWTON EASY	45	0244/150/SOL1	SOLCO	182	6362	VISTA	342
6460	GEKO	100	6480	NEWTON EASY TRACK 230V MONOFASE	154	0244/300/SOL1	SOLCO	182	6734	VISTA MINI	343
6048	GEKO QUADRO ADJUSTABLE	102	6468	NEWTON FLAT	47	0244/150/SOL2	SOLCO MAXI	182	4536	WANDA	312
6290	GEKO 230V	99	6469	NEWTON FLAT	47	0244/300/SOL2	SOLCO MAXI	182	4537	WANDA	312
6447	GEKO ADJUSTABLE	101	6475	NEWTON FLAT RAIL	222	6030	SPECCHIO CORTO	112	4538	WANDA RGB	312
6455	GEKO ADJUSTABLE 230V	100	6461	NEWTON FLAT TRACK 230V	144	6024	SPECCHIO INCASSO	112	4539	WANDA RGB	312
6560	GEKO EDISON	108	6462	NEWTON FLAT TRACK 230V	144	6028	SPECCHIO LUNGO	112	6251	ZEN	107
6680	GEKO MINI	98	6463	NEWTON FLAT TRACK 230V	144	3542	SPILLO	302	6365	ZEN LED	106
6681	GEKO MINI ADJUSTABLE	98	6448	NEWTON FLAT TRACK 48V	132	3543	SPILLO	302	6394	ZEPPELIN 25 PLUS QUADRO	328
6056	GEKO QUADRO 230V ADJUSTABLE	103	6449	NEWTON FLAT TRACK 48V	132	6417	SPOOK	316	6384	ZEPPELIN 25 PLUS TONDO	328
6608	GHOST	181	6450	NEWTON FLAT TRACK 48V	132	6418	SPOOK	316	6411	ZEPPELIN ADJUSTABLE	332
6604	GHOST MINI	180	6720	NEWTON MAXI TRACK 230V	145	6419	SPOOK	316	6741	ZEPPELIN MAXI COB QUADRO	330
6355	ICE QUADRO	280	6721	NEWTON MAXI TRACK 230V	145	6351	SPOON QUADRO	276	6397	ZEPPELIN MAXI COB TONDO	330
6354	ICE TONDO	280	6722	NEWTON MICRO TRACK 24V TINY	162	6350	SPPON TONDO	276	6737	ZEPPELIN MAXI QUADRO	331
6661	INTO	254	6723	NEWTON MINI TRACK 24V TINY	162	6690	STAR 1	52	6736	ZEPPELIN MAXI TONDO	331
4640	IRIS	36	6347	NEWTON RAIL	220	6691	STAR 2	52	6733	ZEPPELIN MINI PLUS QUADRO	325
4641	IRIS	38	6328	NEWTON recessed	48	6695	STAR 3	56	6732	ZEPPELIN MINI PLUS TONDO	325
4642	IRIS	36	6470	NEWTON SLIM	46	6696	STAR 4	56	6731	ZEPPELIN MINI QUADRO	324
4643	IRIS	38	6471	NEWTON SLIM	46	6715	STAR ADJUSTABLE 1	64	6730	ZEPPELIN MINI TONDO	324
4655	IRIS	40	6474	NEWTON SLIM RAIL	223	6716	STAR ADJUSTABLE 2	64	6349	ZEPPELIN QUADRO	326
6750	IRIS	32	6464	NEWTON SLIM TRACK 230V	143	6692	STAR IP	54	6395	ZEPPELIN RGB QUADRO	327
6751	IRIS	32	6465	NEWTON SLIM TRACK 230V	143	6705	STAR MAXI 1	66	6376	ZEPPELIN RGB TONDO	327
6752	IRIS	34	6451	NEWTON SLIM TRACK 48V	131	6706	STAR MAXI 2	66	6348	ZEPPELIN TONDO	326



Gradi di protezione - IP

1a cifra protezione alla penetrazione di corpi solidi.
1st digit: protection against penetration by solid bodies.

0
Non protetto.
No protection.

1
Protetto da corpi solidi superiori a 50mm.
Protected against solid matters (over 50mm).

2
Protetto da corpi solidi superiori a 12mm.
Protected against solid matters (over 12mm).

3
Protetto da corpi solidi superiori a 2,5mm.
Protected against solid matters (over 2,5mm).

4
Protetto da corpi solidi superiori a 1mm.
Protected against solid matters (over 1mm).

5 
Protetto contro la polvere.
Dust proof.

6 
Totalmente protetto contro la polvere.
Fully dust proof.

2a cifra protezione contro la penetrazione d'acqua.
2nd digit: protection against penetration by water.

0
Non protetto.
No protection.

1 
Protetto contro la caduta verticale di gocce d'acqua.
Protected against drops of water falling vertically.

3 
Protetto contro la pioggia.
Rain proof fixture.

4 
Protetto contro gli spruzzi.
Splash proof fixture.

5 
Protetto contro getti d'acqua.
Water jet proof.

6
Protetto contro le ondate.
Wave proof.

7 
Protetto contro immersione.
Watertight immersion fixture.

Simboli - Signs



Foro incasso.
Cut out.



Apparecchi calpestabili - Apparecchi carrabili
Walk over fitting - Drive over fittings



Temperatura superficiale <.....°C
Surface temperature <.....°C



Alimentatore incluso - Alimentatore non incluso
Converter included - Converter not included



Lunghezza cavo
Cable length



Dimmer incluso
Dimmer included



CRI > Indice di resa cromatica
CRI > Color rendering index



Apparecchio riparabile
Fixture repairable



Batteria ricaricabile
Rechargeable battery



2700K-3000K
Tunable white

Marchi - Mark



Apparecchio in Classe II, munito di isolamento doppio o rinforzato.

Fixture on Class II, with double or reinforced insulation.



Apparecchio a bassissima tensione con trasformatore remoto.

SELV fixture with remote transformer.



Apparecchio adatto ad essere installato su superfici normalmente infiammabili.

Fixture ready for installation on normally inflammable surfaces.



MADE IN ITALY

EGOLUCE s.r.l. Via I. Newton, 12 - 20016 Pero - Milano - Italy - Tel. +39 02339586.1 - Italia fax +39 023535112
Int. fax +39 0233911087 E-mail: info@egoluce.com - Int. E-mail: infoworld@egoluce.com - www.egoluce.com