

design





Mission



LA NOSTRA MISSIONE: MADE IN ITALY

Da sempre l'Italia è la culla della creatività. Know-how e stile italiano sono identificati e apprezzati ovunque, tanto che il marchio Made in Italy ha sempre costituito un valore aggiunto ricercato in tutto il mondo.

Il prodotto italiano può essere immediatamente riconosciuto grazie ai dettagli, all'attenzione e ai valori estetici che sono da sempre il nostro biglietto da visita. Sulla scia di questa grande tradizione, dal 1978 EGOLUCE crea prodotti 100% Made in Italy, collaborando principalmente con aziende e artigiani italiani, per offrire ai propri clienti un prodotto di design con i più alti standard tecnologici. La scelta diligente e attenta dei componenti e dei materiali di migliore qualità e la lavorazione guidata da criteri di qualità totale, ci consente di produrre e offrire ai nostri clienti una vasta gamma di corpi illuminanti per diverse applicazioni.

Le soluzioni di progettazione illuminotecnica qualificate identificano EgoLuce come uno dei più importanti produttori mondiali di illuminazione. Prodotti 100% Made in Italy.

OLTRE 45 ANNI DI SUCCESSI

EgoLuce: 46 anni di esperienza per la tua illuminazione su misura. L'evoluzione del prodotto combinato con nuovi materiali, tecnologie e design, sono i reali risultati delle nostre collezioni. Il know-how e la cura dei dettagli in ogni fase della produzione sono stati una forza costante in questi 46 anni di attività di successo. La capacità nella risoluzione dei problemi, l'attenzione al cliente e a ogni singola domanda del mercato, sono una missione costante per tutti noi!

APPROCCIO UMANO

I sistemi di controllo degli apparecchi considerano il bioritmo umano e incidono positivamente sulla salute e sul benessere. Un'intelligente gestione dell'energia e del colore della luce danno la possibilità di creare nuovi spazi nel vuoto, regalando allo spettatore una diversa visione dello spazio. Una nuova esperienza sensoriale per la tua anima. Una luce capace di muoversi e variare nello spazio, in grado di fondersi, di stupire e di appassionare: una luce indimenticabile. La luce vive nell'ombra perché il suo flusso è regolato da soluzioni accattivanti in ogni versione.

OUR MISSION: MADE IN ITALY

Since ever Italy is the cradle of creativity. An aware production know how and style are identified and commended throughout the world, so much so that the Made in Italy mark has always constituted sought-after an added value.

An Italian product can immediately be recognized: details, attention and the aesthetic values are their business card. In the wake of this great tradition, since 1978 EGOLUCE has been creating 100% Made in Italy products, mostly collaborating with Italian companies and craftsmen, in order to offer its clients a design product with highest technology standard.

The diligent and careful selection of best quality components and materials and the processing guided by criteria such as total quality, enable us to produce and offer to our clients a vast range of light fixtures for several applications. Qualified Lighting design solutions identify EgoLuce as one of the most important player in the worldwide lighting producer. Products 100% Made in Italy.

OVER 45 SUCCESSFUL YEARS

EgoLuce 46 years of experiences for your tailored lighting solutions. Product evolution matches with new material, technologies and design, are actual achievements of Our collections. Know-how and care in details in every production phases has been a forceful constant in these 46 years of successful activity. Problem solving liability, customer care and attention to each and every markets demand are a permanent mission for us. All of us... This steady Blend!

HUMAN APPROACH

Modern lighting controls take account of the human biorhythm and impact positively on health and well-being. An intelligent energy and colour management of human light creates new spaces in empty, as only an emotional waterfall can do in You. A new sensorial experiences for your Soul. Light artful to Move, to Fly, to Melt itself, to Hit inside, to Engage a simply unforgettable Light. Light survives in the shadow because its Led glare is shaded by glamour solutions.

Design



DESIGN

Il design della luce è intrinsecamente funzionalità ed estetica e un approccio progettuale creativo e adattativo.

SUL PERCORSO DELL'INNOVAZIONE

Una luce senza tempo in grado di comprendere i nuovi bisogni umani in un mondo dinamico in continua rapida evoluzione. EgoLuce propone una luce vissuta come esperienza di vita per lighting designers, architetti, progettisti come partner e interlocutori.

QUALITÀ IN PRIMO LUOGO

Soluzioni di illuminazione che grazie ad un alto livello di CRI, offerta di temperatura colore, bianco dinamico e UGR, sono in grado di adattarsi a tutti i progetti di interni ed esterni. fornendo una luce come risposta ai tuoi nuovi progetti architettonici. Una luce capace di disegnare nuove forme nel vuoto per ottenere una esperienza visiva e sensoriale rinnovata.

LA TUA LUCE

Una concezione orientata alla semplificazione del concetto di design nella vita quotidiana: una luce che sa adattarsi alle esigenze. Il tempo vola così veloce che la vita si armonizza come la luce per condurre i tuoi sensi in un'unica sinfonia.

DESIGN

Lighting design is both inherently functional and innately aesthetic. Design approach: generative and adaptive creativities. Conceptual design based on metaphors as a heuristic tool.

ON THE INNOVATION PATH

Timeless light able to figure out new human needs in a dynamic surfers world in constant evolution. EgoLuce proposes a light lived as a life experience to: Lighting specialist, Designers, Architects, Specifiers as first partners.

QUALITY FIRST

Lighting solutions that because of: high CRI level, K° offer, dynamic white and UGR solutions, are able to adjust themselves to every interiors and exteriors projects. EgoLuce a Light as response to Your new architectural projects, light draws spaces in several shapes to get your own sensorial experience.

YOUR OWN LIGHT

A new tradition oriented to the contemporary context that simplifies the new design concept in our daily life: adjusting itself with Your needs. The time flies by so fast that the life tunes itself with the light to bless your senses in a symphony.

Production

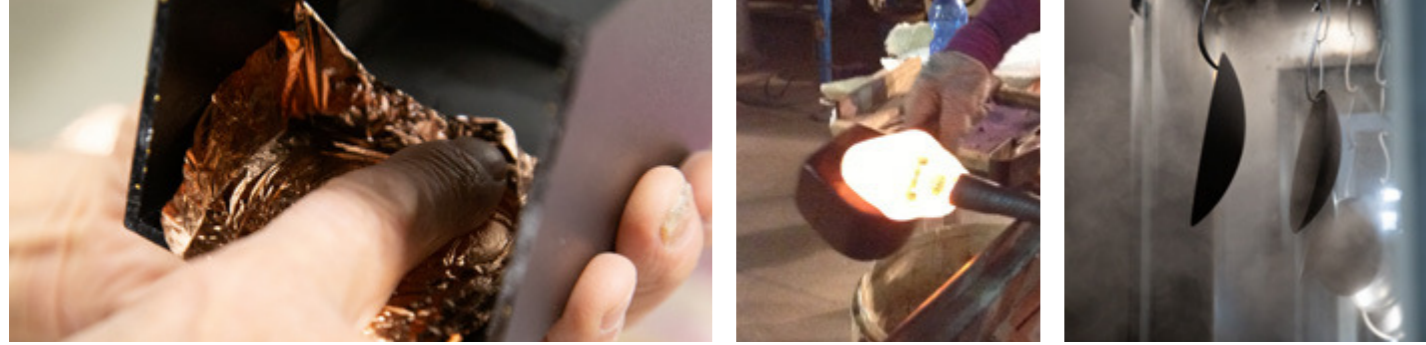

I modelli **EGOLUCE** sono progettati e prodotti attenendosi ai migliori standard qualitativi esistenti sul mercato illuminotecnico seguendo il criterio del "fatto bene" nel pieno rispetto di regole sia qualitative che normative:

- cura e precisione della progettazione finalizzata a una produzione di altissima qualità
- eccellente qualità nella fabbricazione dei prodotti grazie alla selezione di componenti di alta gamma, alla cura nelle finiture, all'assemblaggio preciso e puntuale, all'imballaggio impeccabile per ogni tipo di spedizione
- collaudi severissimi con test di durata e affidabilità sui singoli componenti e sugli apparecchi finiti

Il tutto assicura 5 anni di garanzia sui LED e sulla struttura dei prodotti **EGOLUCE** correttamente installati come da fogli d'istruzione.

EGOLUCE models are designed and manufactured to the highest quality standards on the lighting market, following the criterion of "done right" in full compliance with both quality and regulatory rules:

- *care and precision in design aimed at top-quality production*
- *excellent quality in the manufacture of products thanks to the selection of high-end components, care in finishes, precise and punctual assembly, impeccable packaging for every type of shipment*
- *stringent testing with durability and reliability tests on individual components and finished appliances*

*All this ensures a 5-year warranty on the LED and the structure of **EGOLUCE** products correctly installed according to the instruction sheets.*



Project

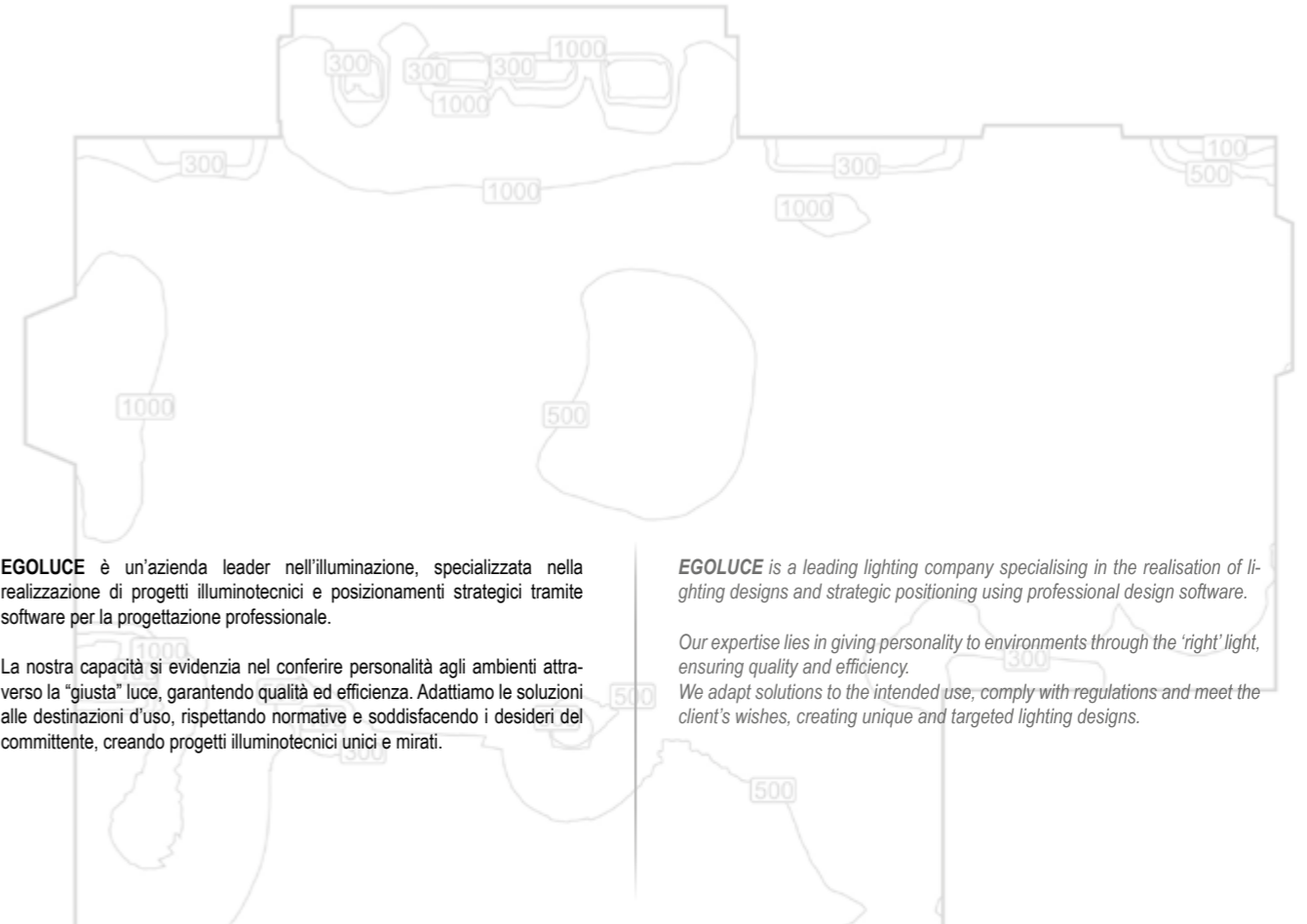

EGOLUCE è un'azienda leader nell'illuminazione, specializzata nella realizzazione di progetti illuminotecnici e posizionamenti strategici tramite software per la progettazione professionale.

La nostra capacità si evidenzia nel conferire personalità agli ambienti attraverso la "giusta" luce, garantendo qualità ed efficienza. Adattiamo le soluzioni alle destinazioni d'uso, rispettando normative e soddisfacendo i desideri del committente, creando progetti illuminotecnici unici e mirati.

EGOLUCE is a leading lighting company specialising in the realisation of lighting designs and strategic positioning using professional design software.

Our expertise lies in giving personality to environments through the 'right' light, ensuring quality and efficiency.

We adapt solutions to the intended use, comply with regulations and meet the client's wishes, creating unique and targeted lighting designs.

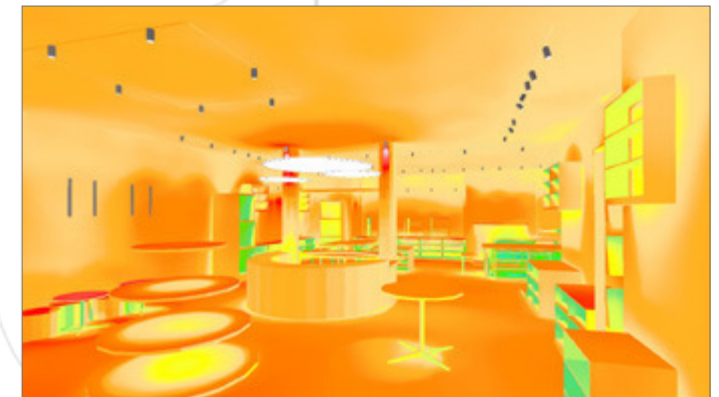
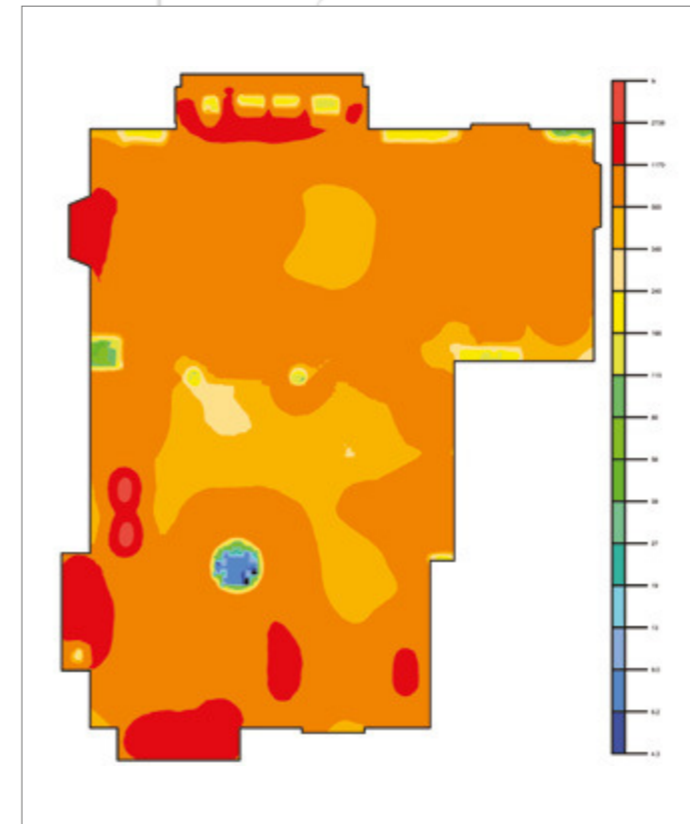

Solutions



SOLUZIONI DECORATIVE

I principali quesiti ai quali deve rispondere un professionista nella scelta di un apparecchio per la realizzazione di un buon progetto con lampade decorative sono:

- tipologia dell'apparecchio
- finitura del corpo illuminante
- temperatura di colore
- emissione luminosa
- rapporto lumen/watt
- indice di resa cromatica
- controllo dell'abbagliamento
- lunghezza dei cavi per evitare le cadute di tensione
- controllo e dimmerazione della luce
- rosone di diverse forme e caratteristiche
- dimensioni custom

Il Catalogo Design, con un'infinità di Soluzioni Tecnico Decorative, aiuta il progettista a fare tutto ciò.

DECORATIVE SOLUTIONS

The main questions a professional has to answer when choosing a luminaire for the realisation of a good decorative luminaire project are:

- luminaire type
- luminaire finish
- colour temperature
- light emission
- lumen/watt ratio
- colour rendering index
- glare control
- cable length to avoid voltage drops
- light control and dimming
- ceiling rose of different shapes and characteristics
- custom dimensions

The Design Catalogue, with an infinite variety of Technical Decorative Solutions, helps the designer to do all this.

Plus



5 anni di garanzia
5 years warranty

5 anni per i LED COB e strip LED montate sul prodotto
5 anni sulla struttura del prodotto
2 anni per gli alimentatori

*5 years for the LED COB and stripes LED mounted on the product
5 years on the product structure
2 years for the drivers*



Apparecchio riparabile
Fixture repairable

La maggior parte dei prodotti EGOLUCE sono riparabili perché progettati per durare nel tempo. Le nostre unità LED sono progettate per una facile sostituzione, garantendoti di goderti la tua illuminazione per gli anni a venire minimizzando gli sprechi e sostenendo così un futuro più green.

Most EGOLUCE products are serviceable because they are designed to last. Our LED units are designed for easy replacement, ensuring you can enjoy your lighting for years to come while minimising waste and supporting a greener future.



Buona parte dei nostri apparecchi sono forniti con sorgente LED con Indice di Resa Cromatica maggiore di 90

The majority of our luminaires are supplied with LED sources with Rendering Colour Index greater than 90



Finiture disponibili
Available finishes

- .34 Verniciato corten - Painted corten finishing
- .35 Verniciato sabbia - Painted sand finishing
- .39 Verniciato antracite - Painted anthracite finishing
- .85 Verniciato argento - Painted silver finishing
- .86 Verniciato oro - Painted gold finishing
- .87 Verniciato rame - Painted copper finishing
- .88 Verniciato bronzo - Painted bronze finishing

4 buone ragioni per scegliere EGOLUCE

4 good reasons to choose EGOLUCE

1. LED

I prodotti EGOLUCE sono dotati di sorgenti LED di ultima generazione. Le diverse tecnologie applicate garantiscono ottime prestazioni:

- eccellente resa luminosa
- ottimo valore di resa cromatica
- svariate temperature di colore
- sorgenti progettate per durare nel tempo

2. MATERIALI

Abbiamo selezionato i migliori materiali per apparecchi che devono durare nel tempo:

- ALLUMINIO - duttile ed inalterabile assicura un'ottima dispersione del calore (importante per ottimizzare la vita del LED)
- ACCIAIO INOX - la migliore garanzia per apparecchi che devono resistere ad agenti atmosferici o chimici (sale, cloro, etc.)
- CLEAR CRYSTAL - per creare oggetti con effetti e proiezioni di luce unici
- METACRILATO - per diffondere ed al tempo stesso mascherare la luce puntiforme del LED

3. CARATTERISTICHE GENERALI

Piccoli particolari che fanno grande un prodotto:

- facile sostituzione del LED, la sorgente luminosa può essere rimpiazzata senza problemi come una comune lampadina
- presenza di adeguati dissipatori di calore su tutti i prodotti per garantire la durata dei LED
- possibilità, per la maggior parte dei prodotti, di essere alimentati sia a 350mA che a 500mA
- ottimizzazione della resa luminosa tramite
- l'utilizzo di lenti o parabole

4. SICUREZZA

Una qualità garantita:

- tutti i modelli vengono sottoposti a prove termiche e test funzionali
- tutti i componenti elettronici proposti in catalogo, come alimentatori e dimmer, sono dotati di marchio europeo di qualità (ENEC)
- il 100% della produzione viene sottoposto a test qualitativi e funzionali prima di essere immesso sul mercato

1. LED

EGOLUCE products are equipped with the latest generation of LED sources. The different technologies applied guarantee excellent performance:

- excellent light yield
- excellent colour rendering value
- various colour temperatures
- sources designed to last over time

2. MATERIALS

We have selected the best materials for luminaires that must last:

- ALUMINIUM - ductile and unalterable ensures excellent heat dispersion (important for optimising LED life)
- STAINLESS STEEL - the best guarantee for luminaires that must resist atmospheric or chemical agents (salt, chlorine, etc.)
- CLEAR CRYSTAL - to create objects with unique light effects and projections
- METACRYLATE - to diffuse and at the same time mask the LED's point light

3. GENERAL FEATURES

Small details that make a product great

- easy LED replacement, the light source can be replaced as easily as an ordinary bulb
- presence of adequate heat sinks on all products to ensure LED lifetime
- possibility for most products to be powered at either 350mA or 500mA
- optimisation of light output through the use of lenses or reflectors

4. SAFETY

Guaranteed quality:

- all models are subjected to thermal and functional tests
- all electronic components offered in the catalogue, such as drivers and dimmers, have the European quality mark (ENEC)
- 100% of production undergoes quality and functional tests before being placed on the market

Foto - Ambientazione Picture - Setting	Codice Code	Nome Name	Tipologia Typology
	Raccordi di luce - Joy	3547 Raccordi di luce .33 Acciaio - Stell (Inox AISI 316L) .34 Verniciato corten - Painted corten	Raccordi di luce - Joy
		Color temperature LED Light source Im source /W 4000K 1,5W 500mA 221lm /WW 3000K 1,5W 500mA 210lm /XW 2700K 1,5W 500mA 199lm IP65 R 0,60 Kg Solo collegamento in serie - Only serial connection	
			
	Drivers	Accessori - Accessories	
.33 .34	Cod. LED 3547 ON/OFF 0143IP 500mA 1V 0127 500mA 1V	0246/R Cassafornia drenante con piastra Drainage formwork with plate 0276 Connettore con gel IP67 IP67 connector with gel	
286	287		
Finiture Finishes	Drivers Drivers	Accessori Accessories	

I caratteri in rosso sono utilizzati per il codice e le specifiche che concorrono alla definizione del prodotto da indicare negli ordini

Red characters are used for code and specifications needed to identify the product code to be indicated in orders

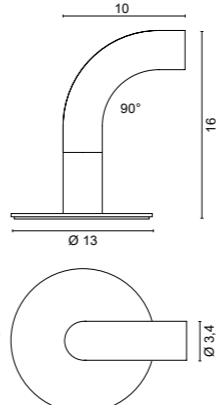
Disegno Tecnico Technical Drawing	Finitura Finishes	Codice Prodotto Product Code	Dati Tecnici Technical Data	Lumen Nominali Gross Lumen Package
	.33 Acciaio - Stell (Inox AISI 316L) .34 Verniciato corten - Painted corten	3547 Raccordi di luce	Color temperature LED Light source Im source /W 4000K 1,5W 500mA 221lm /WW 3000K 1,5W 500mA 210lm /XW 2700K 1,5W 500mA 199lm IP65 R 0,60 Kg Solo collegamento in serie - Only serial connection	
			Temperatura di Colore Light Color	Specifiche Tecniche Technical specifications

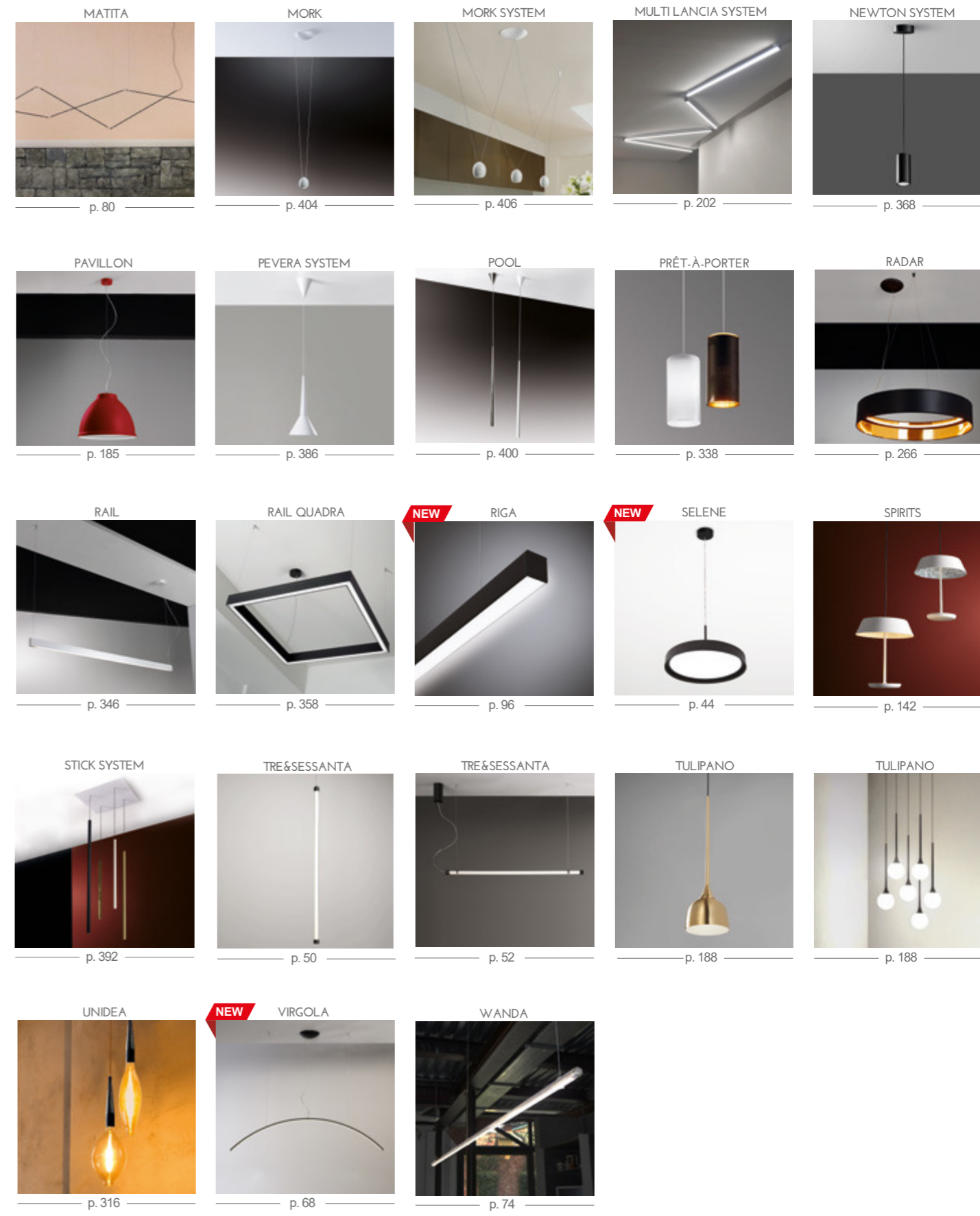
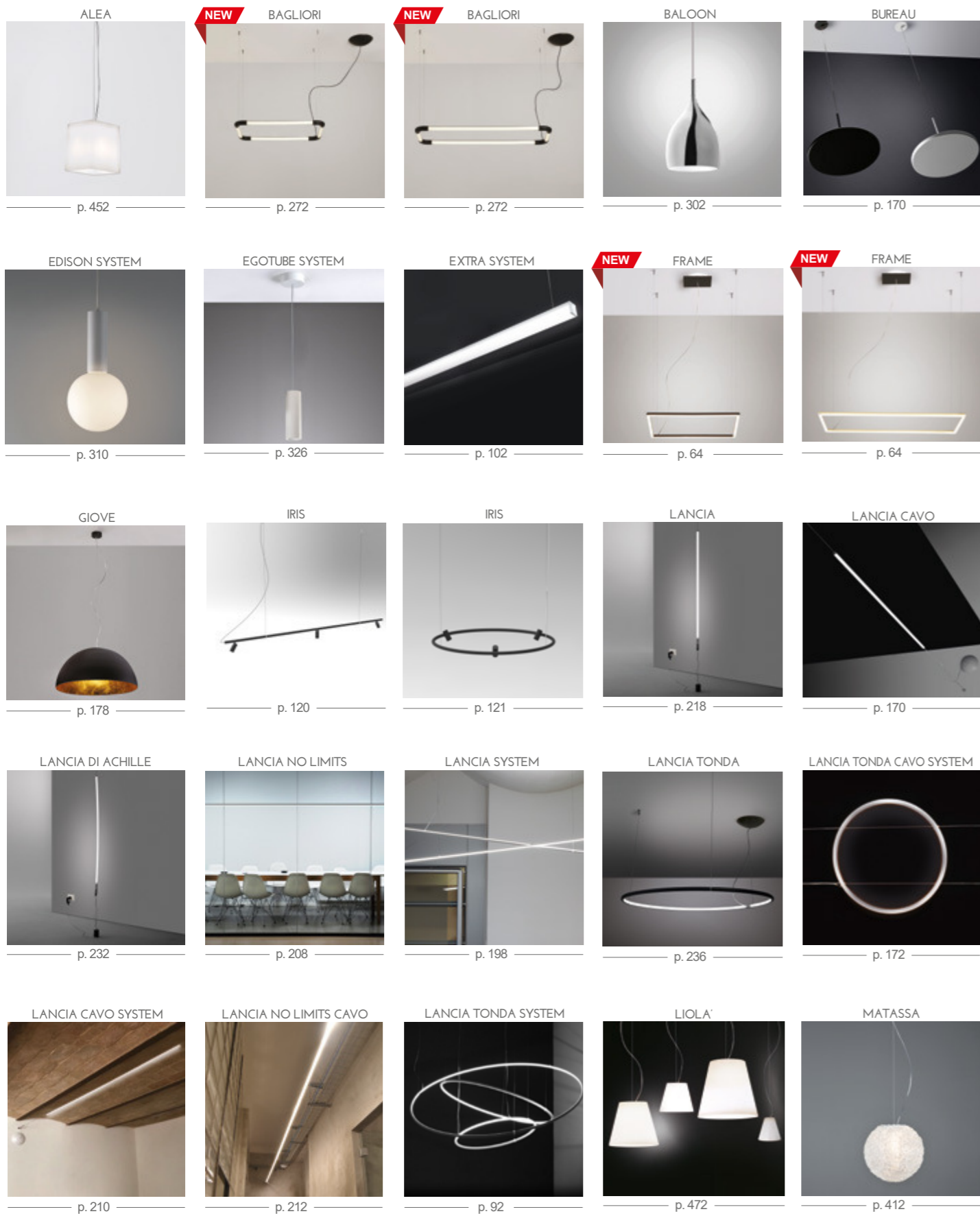



AGOS

p. 486



ALBA

p. 420



BALOON

p. 304



BI LANCIA

p. 222



BUREAU

p. 172



DAMA

p. 469



NEW FARO

p. 116



IRIS

p. 122



LANCIA

p. 220

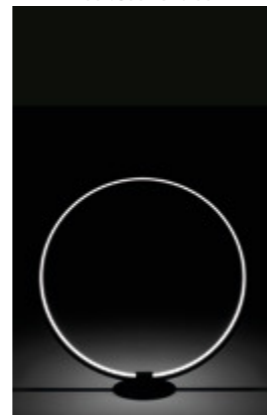

LANCIA TONDA

p. 254

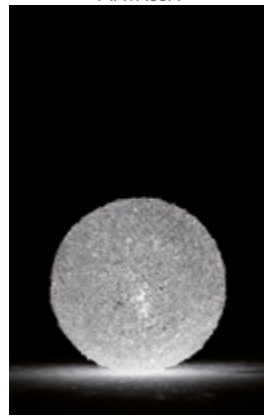

MATASSA

p. 414

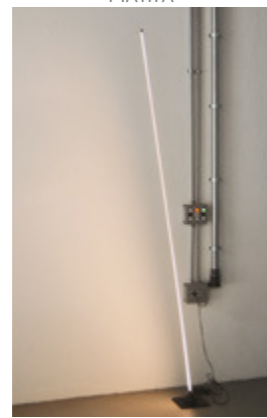

MATITA

p. 84

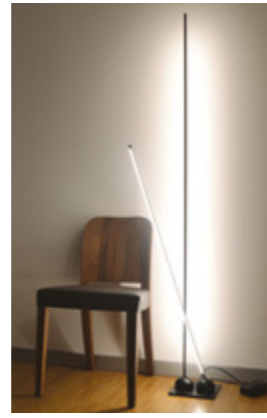

MATITA

p. 84



NEWTON

p. 374



NEW RACCORDI DI LUCE - JOY

p. 286



NEW RACCORDI DI LUCE - JOY

p. 288



NEW RACCORDI DI LUCE - JOY

p. 288



SILHOUETTE

p. 166



SPILLO

p. 492



NEW TRE&SESSANTA

p. 54



NEW TRILLI

p. 20



UNIDEA

p. 321



VIRGOLA

p. 70

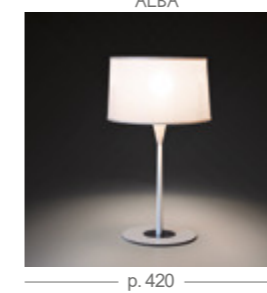

ALBA

p. 420

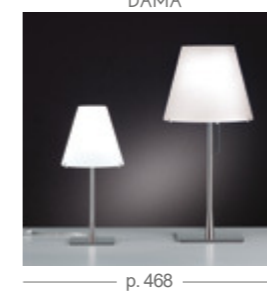

DAMA

p. 468

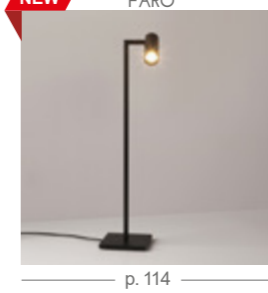

NEW FARO

p. 114



KALLA

p. 428

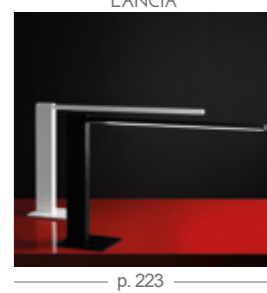

LANCIA

p. 223



LANCIA TONDA

p. 252

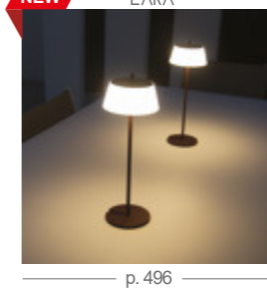

NEW LARA

p. 496

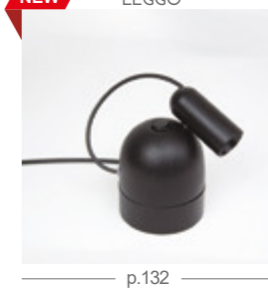

NEW LEGGO

p. 132

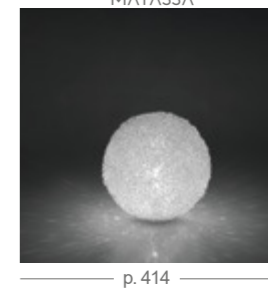

MATASSA

p. 414

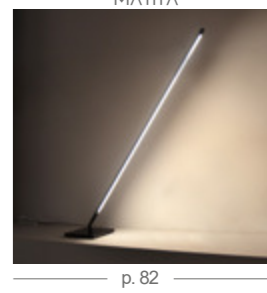

MATITA

p. 82

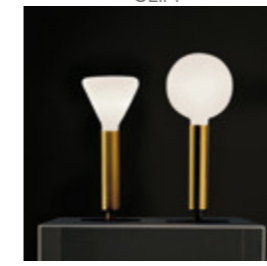

OLIM

p. 324



UNIDEA

p. 320



NEW ZETA

p. 440

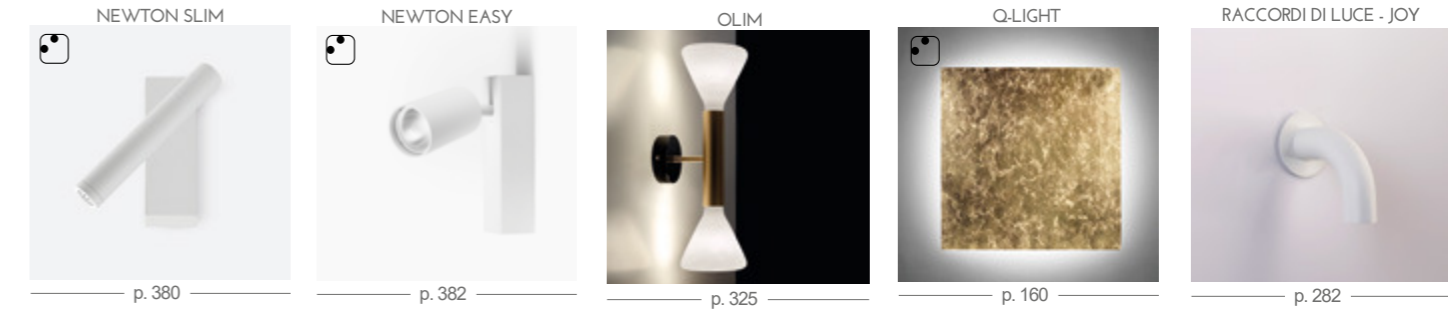
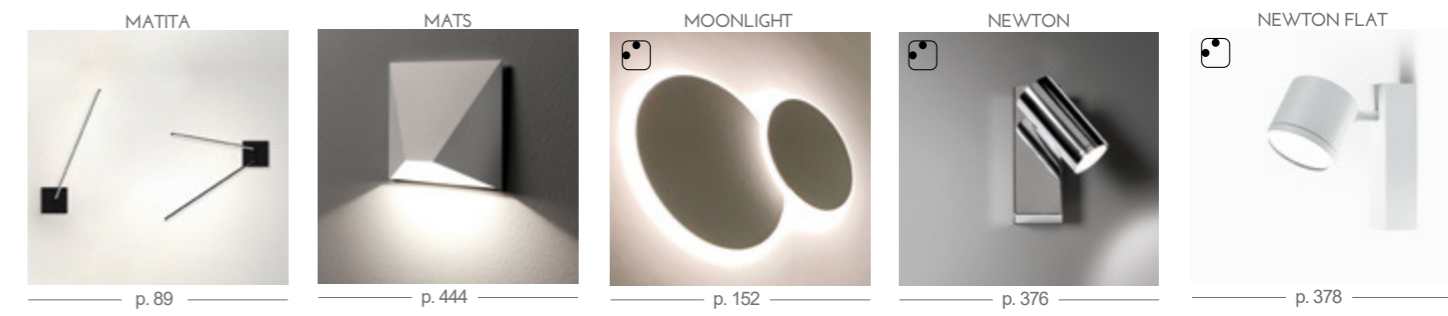
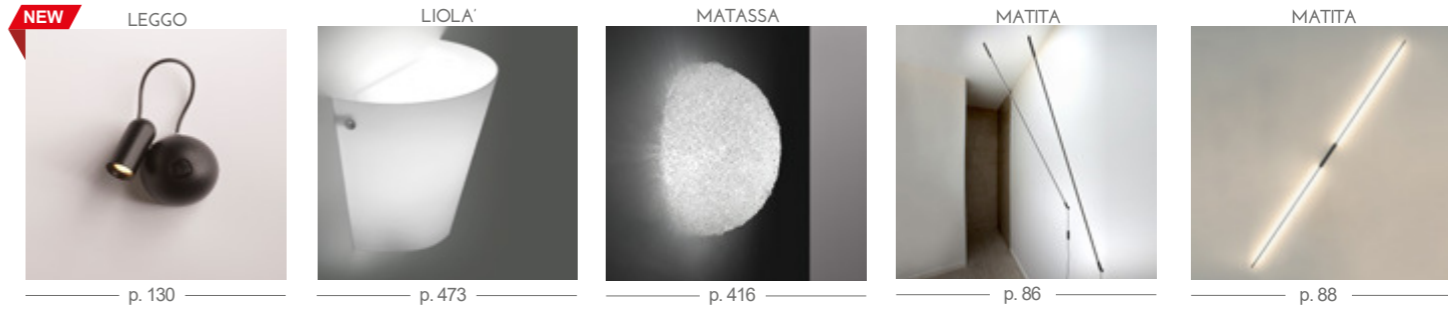
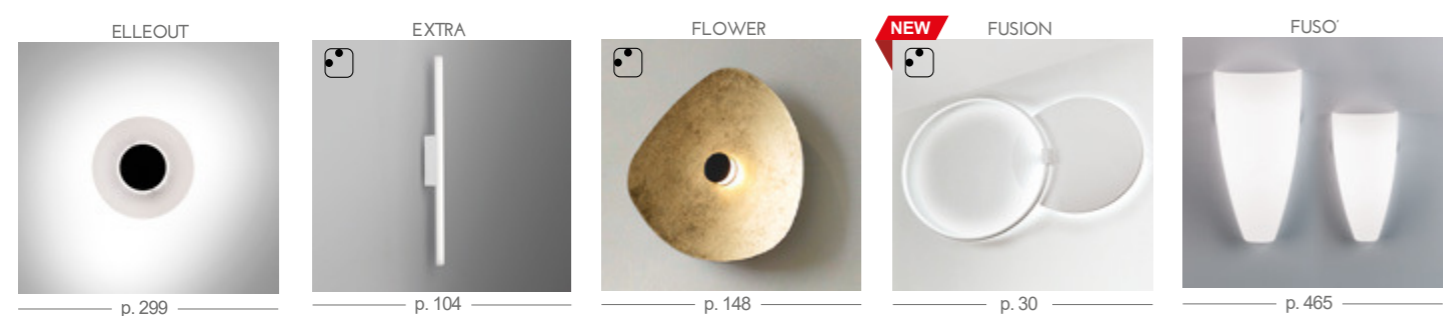
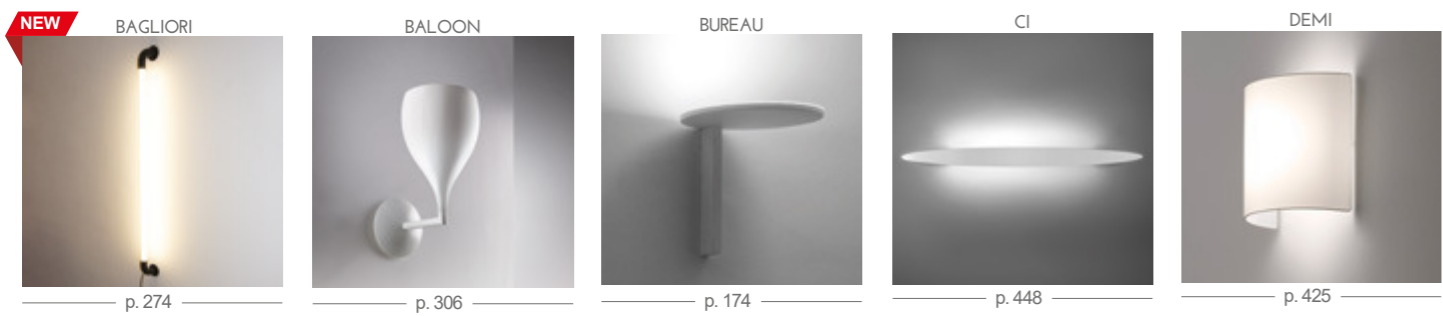

Modelli per montaggio sia a parete che a plafone
Model for mounting both wall and ceiling

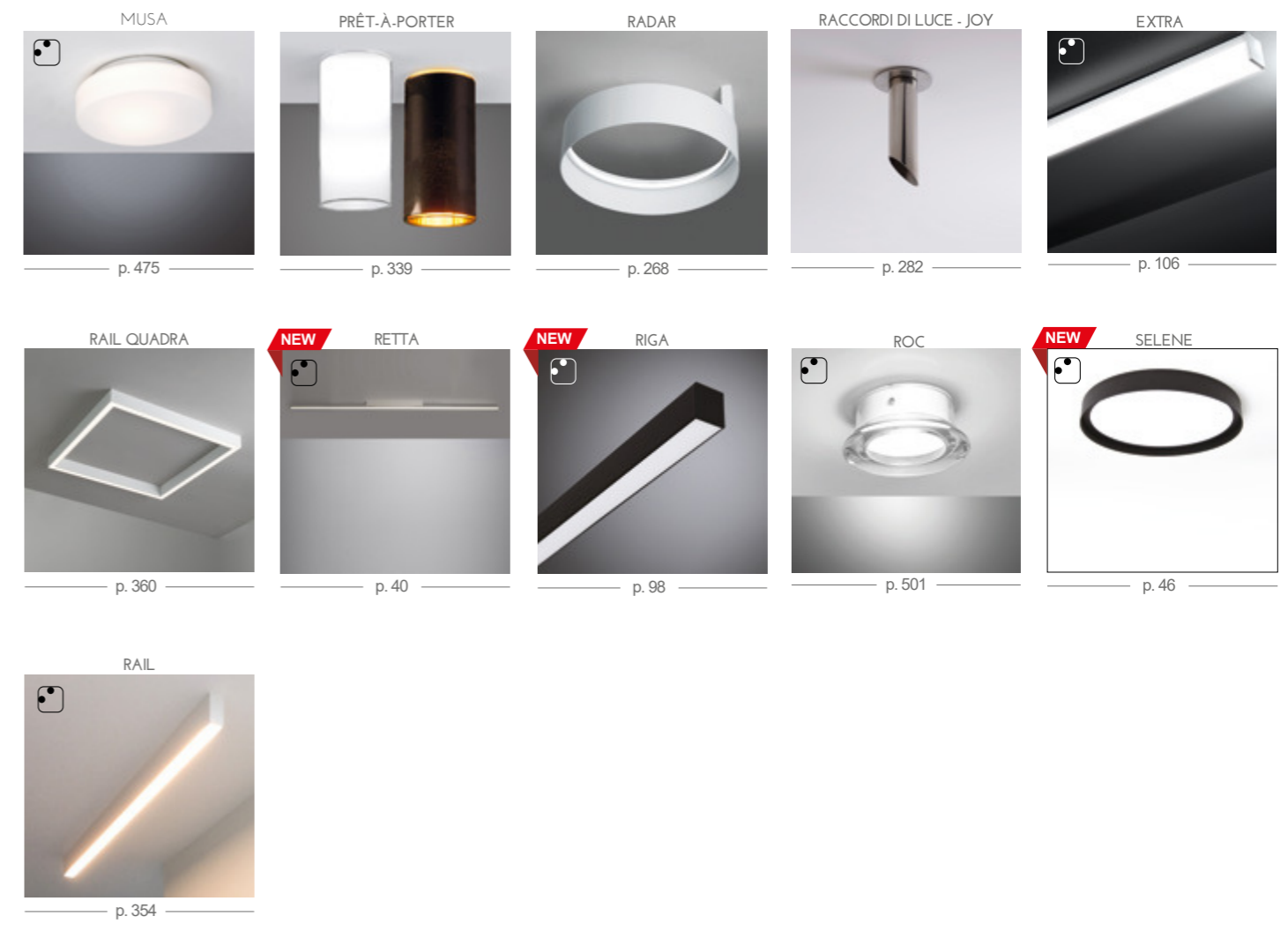
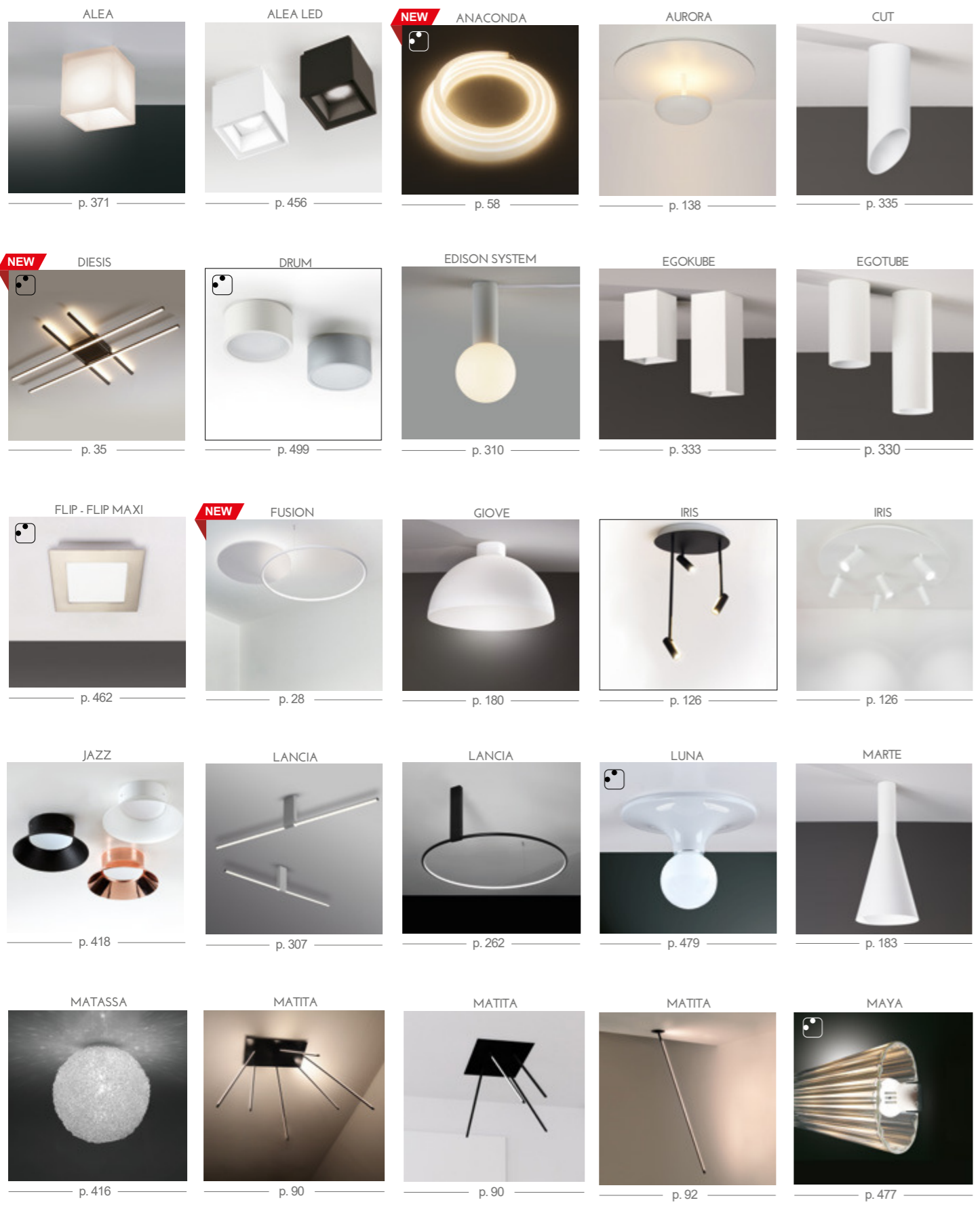

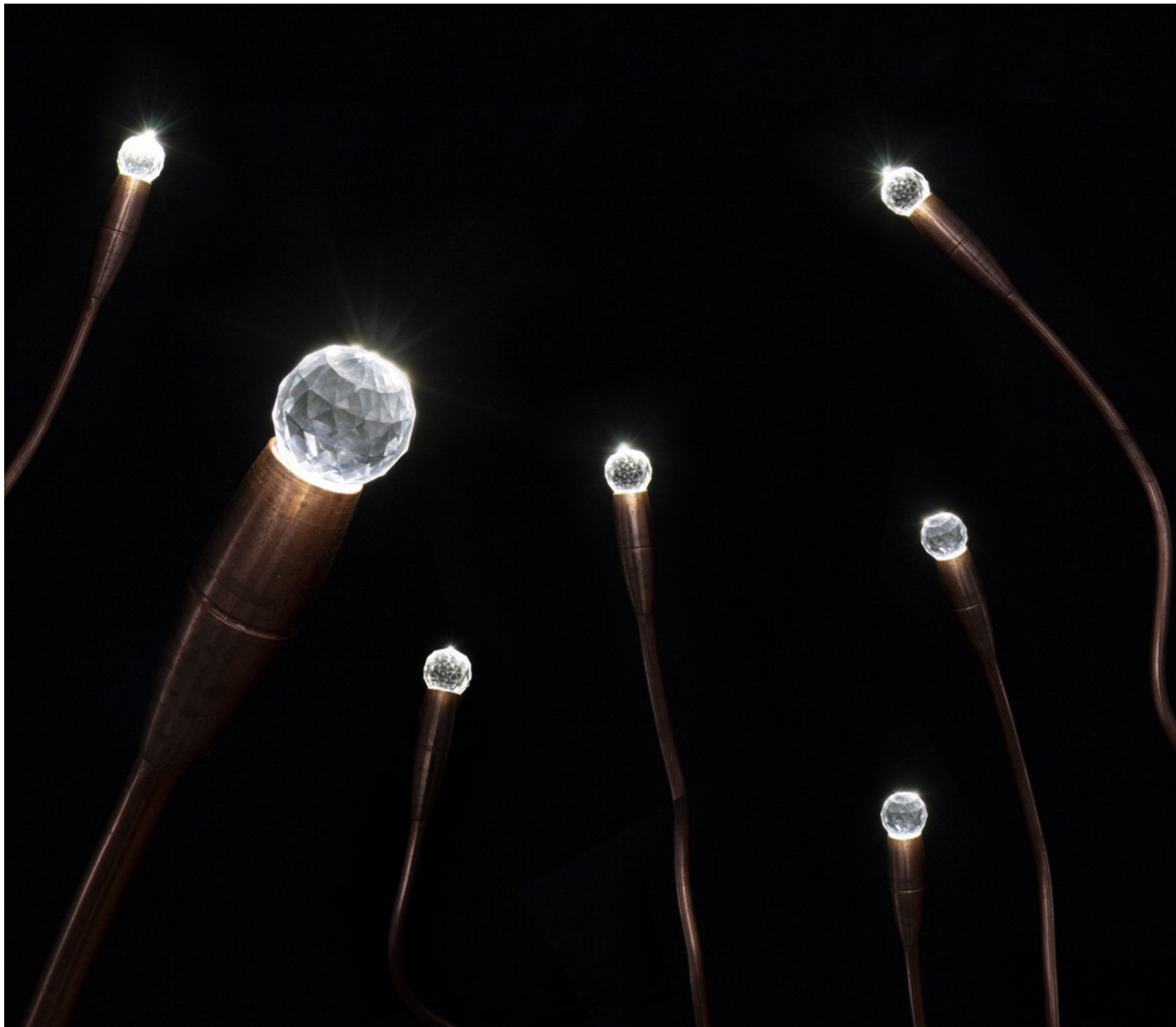

design **Mati**
2024

20

Lampada da terra IP67 a luce diffusa con stelo in rame naturale e diffusore in cristallo. Può essere installato con base per lampada singola o multipla oppure a picchetto. Gli accessori, e l'alimentatore da posizionare in remoto, sono da ordinare separatamente.

IP67 floor lamp providing diffused light with natural copper stem and crystal diffuser. It can be installed with a single or multiple lamp base or with a spike. Accessories, and the driver to be remotely positioned, are to be ordered separately.

Lampadaire IP67 à lumière diffuse avec tige en cuivre naturel et diffuseur en cristal. Il peut être installé avec un culot à une ou plusieurs lampes ou avec une pointe. Les accessoires et le driver à positionner à distance doivent être commandés séparément.

Lámpara de pie IP67 de luz difusa con vástago de cobre natural y difusor de cristal. Puede instalarse con una base de una o varias lámparas o con un pincho. Los accesorios, así como el driver que se coloca a distancia, deben pedirse por separado.

Stehleuchte IP67 mit diffusem Licht, Stiel aus natürlichem Kupfer und Kristalldiffusor. Sie kann mit einem einzelnen oder mehreren Lampensockeln oder mit einem Erdspeiß installiert werden. Das Zubehör und das Driver für die entfernte Positionierung sind separat zu bestellen.

•
|
|
|
•
|
|
|
|

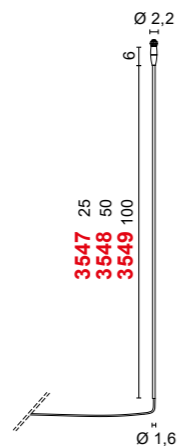

Trilli è modellabile e orientabile
Trilli is mouldable and adjustable

3547 Trilli
.38 Ramato lucido - Shiny copper

Color temperature	LED Light source	lm source
/W 4000K	1W 350mA	129lm
/WW 3000K	1W 350mA	117lm
/XW 2700K	1W 350mA	110lm

IP67
0,15 Kg

Solo collegamento in serie - Only serial connection

3548 Trilli
.38 Ramato lucido - Shiny copper

Color temperature	LED Light source	lm source
/W 4000K	1W 350mA	129lm
/WW 3000K	1W 350mA	117lm
/XW 2700K	1W 350mA	110lm

IP67
0,25 Kg

Solo collegamento in serie - Only serial connection

3549 Trilli
.38 Ramato lucido - Shiny copper

Color temperature	LED Light source	lm source
/W 4000K	1W 350mA	129lm
/WW 3000K	1W 350mA	117lm
/XW 2700K	1W 350mA	110lm

IP67
0,40 Kg

Solo collegamento in serie - Only serial connection



Il tubo di rame cotto, quando installato in esterno, inizierà una reazione spontanea con l'ossigeno e l'acqua per formare il proprio strato protettivo naturale di ossido di rame sulla superficie.
A seconda della composizione dell'acqua il colore di questo strato varierà dal blu turchese al verde intenso.

*When installed outdoors, the baked copper pipe will initiate a spontaneous reaction with oxygen and water to form its own natural protective layer of copper oxide on the surface.
Depending on the composition of the water, the colour of this layer will vary from turquoise blue to deep green.*

Codici finiture - Finishes codes



.38



Drivers

Cod.	Drivers ON/OFF			DIMMABLE drivers				
	0031/IP 350mA	0125 350mA	0128 350mA	0141/DIM PUSH - 1...10V	0141/DALI DIM DALI	0145 DIM	0145/DALI DIM DALI	0733/DIM PHASE CUT
3547	1-12	1-6	1-10	4-14	5-14	1-21	1-21	1
3548	1-12	1-6	1-10	4-14	5-14	1-21	1-21	1
3549	1-12	1-6	1-10	4-14	5-14	1-21	1-21	1

Esempio di installazione temporanea a terreno, la scelta del driver è determinata dalla somma delle potenze delle singole lampade
I drivers, da ordinare separatamente, devono essere collocati in remoto

Example of temporary installation on the ground, the choice of the driver depends on total power consumption
The drivers, to be ordered separately, must be placed remotely

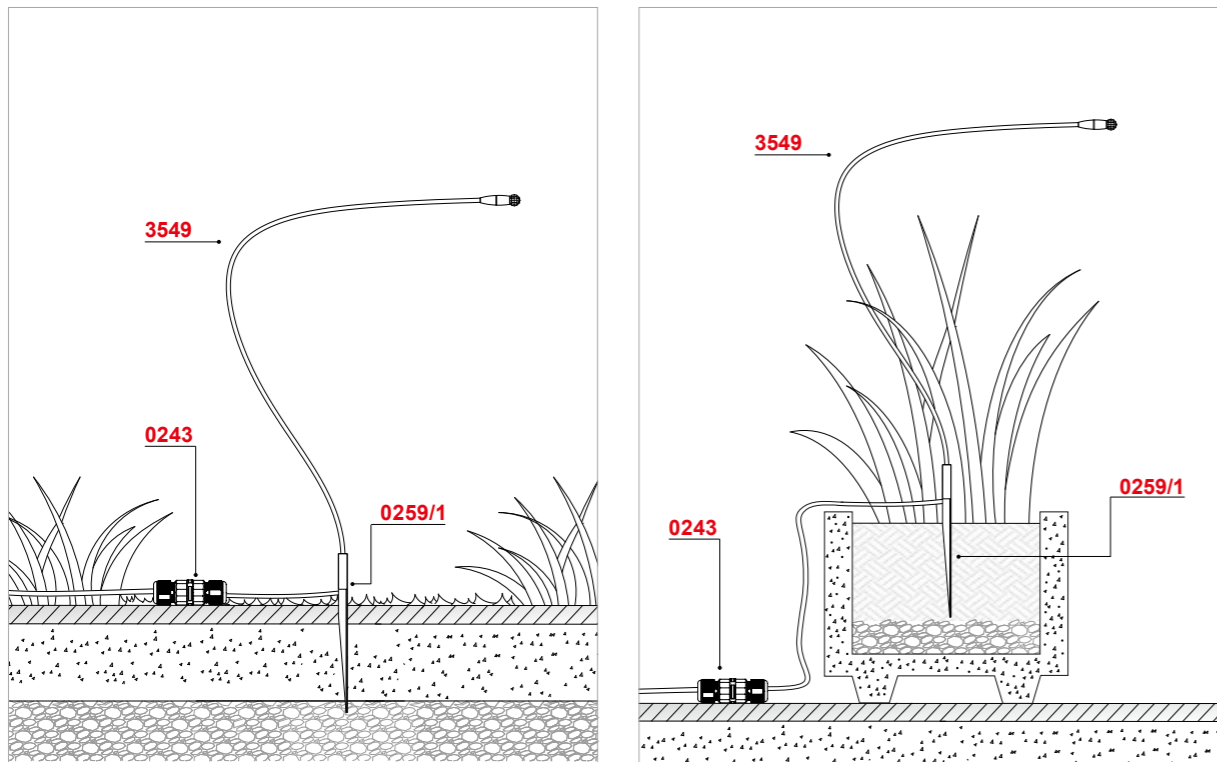

Esempio di installazione multipla, la scelta del driver è determinata dalla somma delle potenze delle singole lampade
I drivers, da ordinare separatamente, devono essere collocati in remoto

Example of multiple installation, the choice of the driver depends on total power consumption
The drivers, to be ordered separately, must be placed remotely

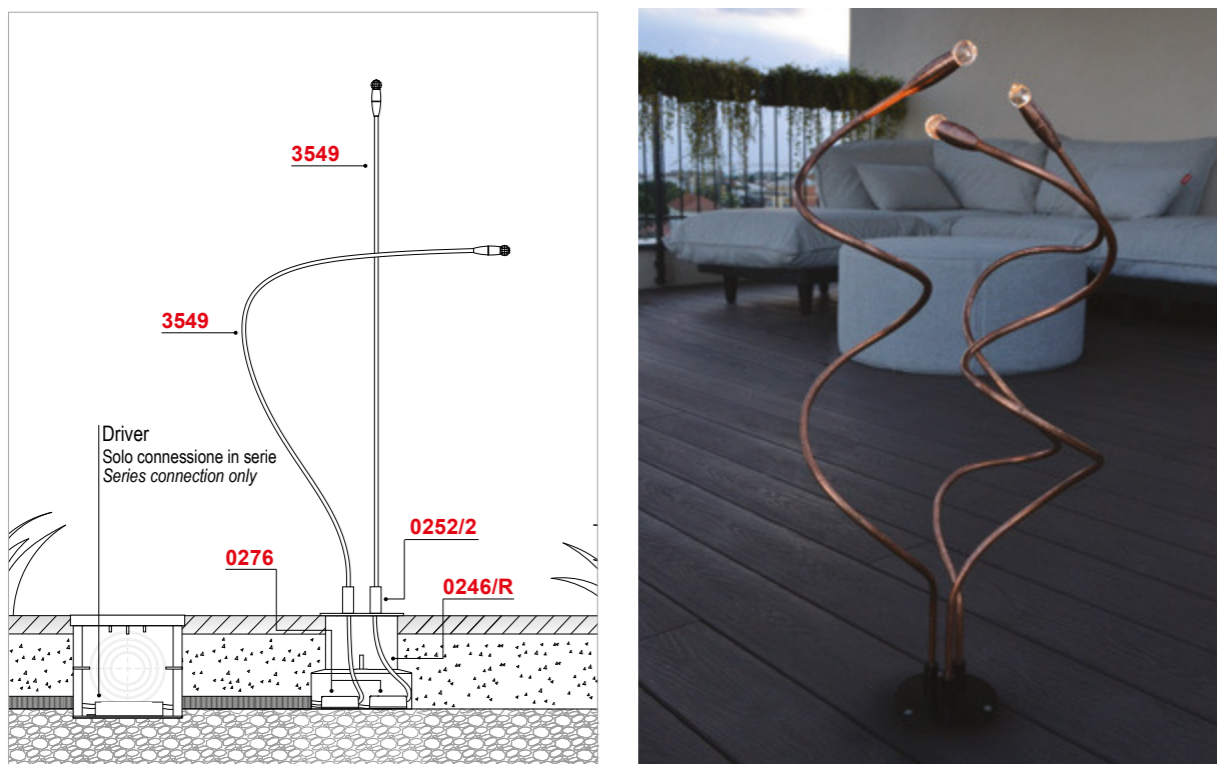

Accessori - Accessories

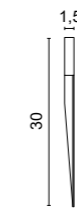

0259/1
Picchetto per installazione temporanea a terreno
Stake for temporary installation on field

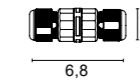

0243
Connettore IP su cavo
IP connector on cable

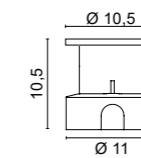

0246/R
Cassaforma drenante con piastra
Draining formwork with plate

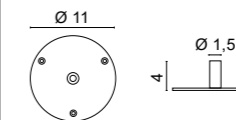

0252/1
Base per installazione 1 Trilli
Installation base for 1 Trilli

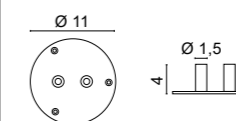

0252/2
Base per installazione 2 Trilli
Installation base for 2 Trilli

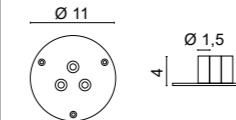

0252/3
Base per installazione 3 Trilli
Installation base for 3 Trilli

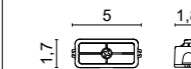

0276
Connettore con gel IP67
IP67 connector with gel





design **LUX Studio**
2022

28 30

Lampada da plafone e da parete con alimentatore integrato caratterizzata da due corpi illuminanti, uno a luce radiale con struttura in MDF e l'altro a luce diffusa con corpo in trafilata di alluminio calandrata e diffusore in policarbonato opalino.

Ceiling and wall lamp with integrated driver characterised by two luminaire bodies, one with radial light with an MDF structure and the other with diffused light with a calendered aluminium body and opal polycarbonate diffuser.

Plafonnier et applique avec driver intégré caractérisé par deux corps d'appareil, l'un à lumière radiale avec une structure en MDF et l'autre à lumière diffuse avec un corps en aluminium calandré et un diffuseur en polycarbonate opalin.

Lámpara de techo y aplique con driver integrado caracterizado por dos cuerpos de luminaria, uno de luz radial con estructura de MDF y otro de luz difusa con cuerpo de aluminio calandrado y difusor de policarbonato opalino.

Decken- und Wandleuchte mit integriertem Driver, gekennzeichnet durch zwei Leuchtenkörper, einen mit radialem Licht mit MDF-Struktur und einen mit diffusem Licht mit kalandriertem Aluminiumkörper und opalem Polycarbonatdiffusor.

FUSION



5590 Fusion

Codici finitura disco - Disc finishes codes

- .01** Bianco - *White*
- .14** Lavagna - *Blackboard*

Codici finitura anello - Ring finishes codes

- .01** Bianco - *White*
- .02** Nero - *Black*
- .85** Verniciato argento - *Painted silver*
- .86** Verniciato oro - *Painted gold*
- .87** Verniciato rame - *Painted copper*
- .88** Verniciato bronzo - *Painted bronze*

Color temperature	LED Light source	lm source
/W 4000K	52,8W	6586lm
/WW 3000K	52,8W	5892lm
/XW 2700K	52,8W	5529lm

IP40 3,40 Kg

Dimmerazione PUSH - 1...10V - DALI - TRIAC su richiesta
 PUSH - 1...10V - DALI - TRIAC dimming on request

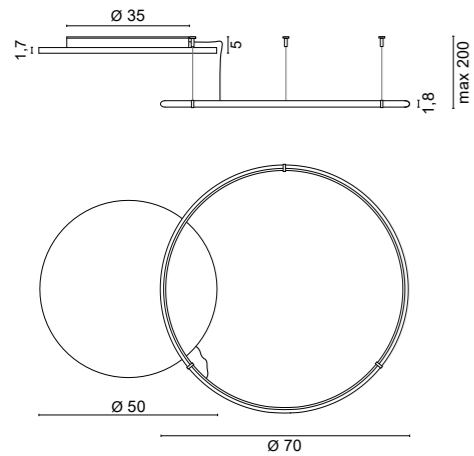

Codici finiture disco - Disc finishes codes

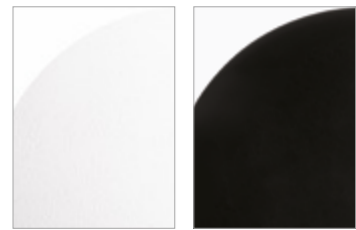

.01

.14

Codici finiture anello - Ring finishes codes



.01

.02

.85

.86

.87

.88

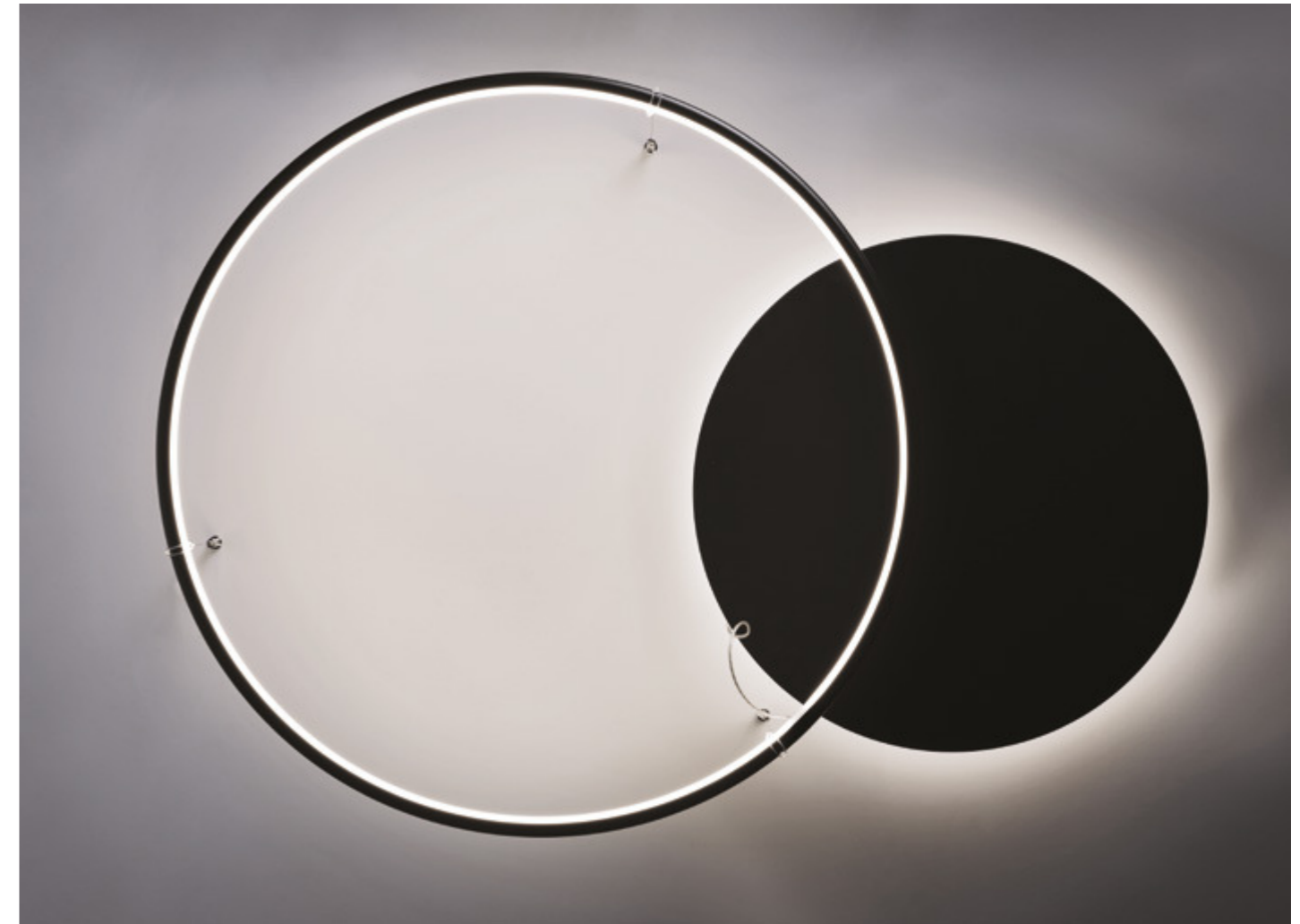



4340 Fusion

Codici finitura disco - Disc finishes codes

- .01** Bianco - White
- .14** Lavagna - Blackboard

Codici finitura anello - Ring finishes codes

- .01** Bianco - White
- .02** Nero - Black
- .85** Verniciato argento - Painted silver
- .86** Verniciato oro - Painted gold
- .87** Verniciato rame - Painted copper
- .88** Verniciato bronzo - Painted bronze

Color temperature	LED Light source	lm source
/W 4000K	52,8W	6586lm
/WW 3000K	52,8W	5892lm
/XW 2700K	52,8W	5529lm

3,70 Kg

Dimmerazione PUSH - 1...10V - DALI - TRIAC su richiesta
 PUSH - 1...10V - DALI - TRIAC dimming on request

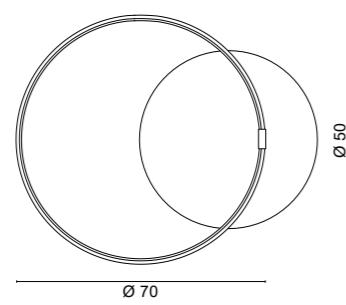
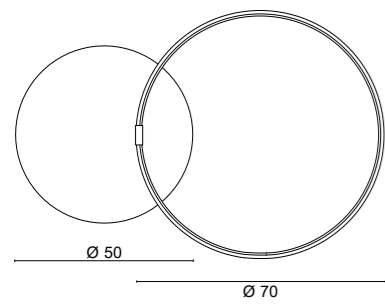
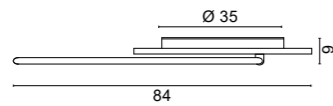
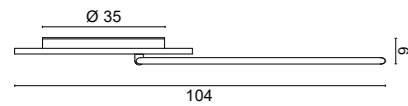

Codici finiture disco - Disc finishes codes

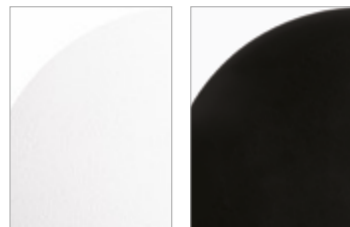

.01 **.14**

Codici finiture anello - Ring finishes codes

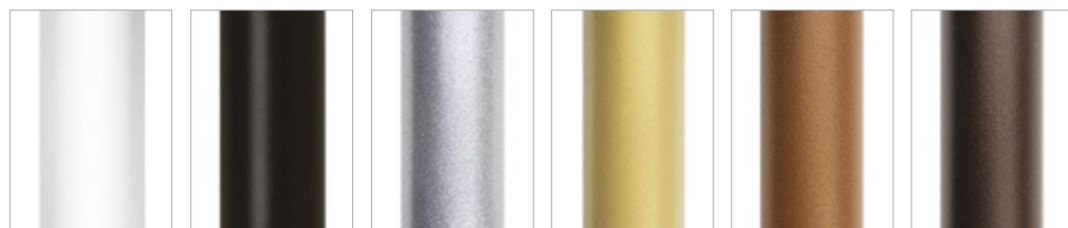

.01 **.02** **.85** **.86** **.87** **.88**



Fusion 4340 può essere installata con l'anello rivolto verso l'esterno oppure verso l'interno rispetto al disco - Fusion 4340 can be installed with the ring facing outwards or inwards from the disc



design **LUX Studio**
2023

34 36

Lampade da parete e da plafone a luce diffusa e indiretta con corpo in trafilata di alluminio, diffusore in policarbonato opalino e alimentatore integrato. L'elevato flusso luminoso rende Diesis ideale per l'illuminazione generale di un locale considerando un solo punto luce.

Wall and ceiling lamps providing diffuse and indirect light with an aluminium die-cast body, opal polycarbonate diffuser and integrated driver. The high luminous flux makes Diesis ideal for general lighting of a room considering only one lighting point.

Appliques et plafonniers à lumière diffuse et indirecte avec un corps en aluminium moulé sous pression, un diffuseur en polycarbonate opale et driver intégré. Grâce à son flux lumineux élevé, Diesis est idéal pour l'éclairage général d'une pièce ne comportant qu'un seul point d'éclairage.

Apliques y plafones de luz difusa e indirecta con cuerpo de aluminio fundido a presión, difusor de policarbonato opalino y driver integrado. Gracias a su elevado flujo luminoso, Diesis es ideal para la iluminación general de una habitación con un solo punto de luz.

Wand- und Deckenleuchten für diffuses und indirektes Licht mit einem Gehäuse aus Aluminiumdruckguss, einer opalen Polycarbonatabdeckung und einem integrierten Driver. Der hohe Lichtstrom macht Diesis ideal für die allgemeine Beleuchtung eines Raumes mit nur einem Lichtpunkt.

D
i
e
s
i
s

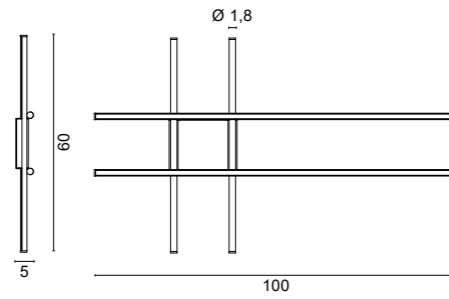
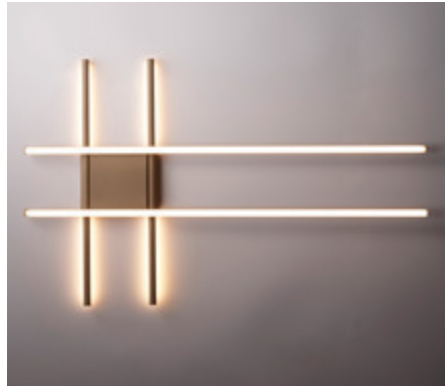

4636 Diesis

.01	Bianco - <i>White</i>
.02	Nero - <i>Black</i>
.35	Verniciato sabbia - <i>Painted sand finishing</i>

Color temperature	LED Light source	lm source
/W 4000K	50,4W	6328lm
/WW 3000K	50,4W	5656lm
/XW 2700K	50,4W	5292lm

1,50 Kg

Dimmerazione PUSH - 1...10V - DALI su richiesta
 PUSH - 1...10V - DALI dimming on request



Codici finiture - *Finishes codes*

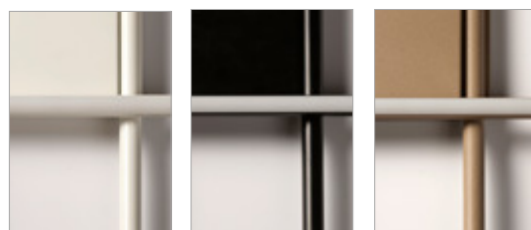

.01

.02

.35



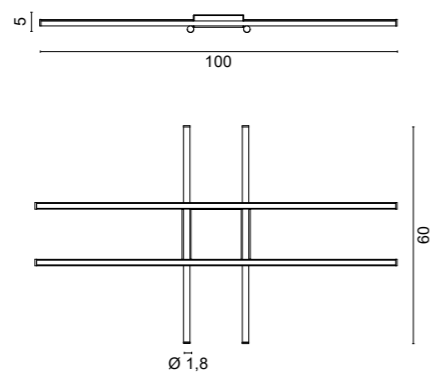
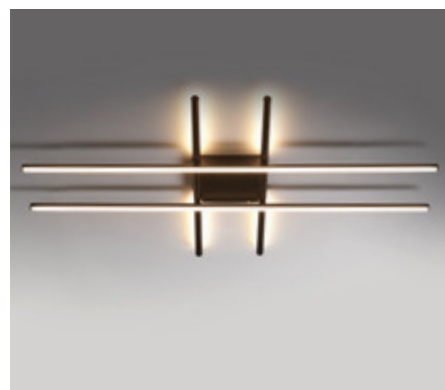

5691 Diesis

.01 Bianco - White
.02 Nero - Black
.35 Verniciato sabbia - Painted sand finishing

Color temperature	LED Light source	lm source
/W 4000K	50,4W	6328lm
/WW 3000K	50,4W	5656lm
/XW 2700K	50,4W	5292lm

IP40 1,50 Kg

Dimmerazione PUSH - 1...10V - DALI su richiesta
 PUSH - 1...10V - DALI dimming on request



Codici finiture - Finishes codes

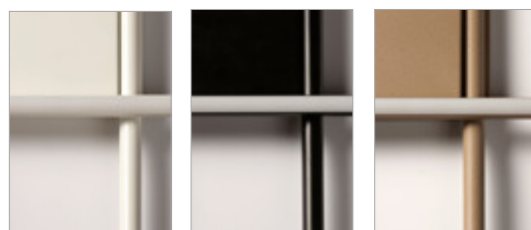

.01 **.02** **.35**





design **LUX Studio**
2023



Lampada da parete o plafone a luce diffusa con corpo in alluminio, diffusore in policarbonato opalino e alimentatore integrato. L'elevato flusso luminoso rende Retta ideale per l'illuminazione generale di un locale considerando un solo punto luce.

Wall or ceiling lamp providing diffused light with aluminium body, opal polycarbonate diffuser and integrated driver. The high luminous flux makes Retta ideal for general lighting of a room considering only one lighting point.

Applique ou plafonnier à lumière diffuse avec corps en aluminium, diffuseur en polycarbonate opale et driver intégré. Grâce à son flux lumineux élevé, Retta est idéale pour l'éclairage général d'une pièce ne comportant qu'un seul point d'éclairage.

Aplique o plafón de luz difusa con cuerpo de aluminio, difusor de policarbonato opalino y driver integrado. Gracias a su elevado flujo luminoso, Retta es ideal para la iluminación general de una habitación con un solo punto de luz.

Wand- oder Deckenleuchte für diffuses Licht mit Aluminiumgehäuse, opalem Polycarbonatdiffusor und integriertem Driver. Der hohe Lichtstrom macht Retta ideal für die allgemeine Beleuchtung eines Raumes mit nur einem Lichtpunkt.

Retta



5694 Retta
 .01 Bianco - White
 .02 Nero - Black
 .35 Verniciato sabbia - Painted sand finishing

Color temperature	LED Light source	lm source
/W 4000K	36W	4520lm
/WW 3000K	36W	4040lm
/XW 2700K	36W	3780lm

IP40 CRI >90 R 1,00 Kg

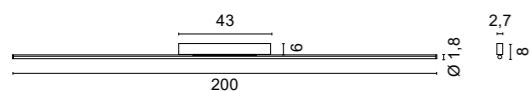

5695 Retta
 .01 Bianco - White
 .02 Nero - Black
 .35 Verniciato sabbia - Painted sand finishing

Color temperature	LED Light source	lm source
/W 4000K	45W	5650lm
/WW 3000K	45W	5050lm
/XW 2700K	45W	4725lm

IP40 CRI >90 R 1,15 Kg



5696 Retta
 .01 Bianco - White
 .02 Nero - Black
 .35 Verniciato sabbia - Painted sand finishing

Color temperature	LED Light source	lm source
/W 4000K	54W	6780lm
/WW 3000K	54W	6060lm
/XW 2700K	54W	5670lm

IP40 CRI >90 R 1,30 Kg

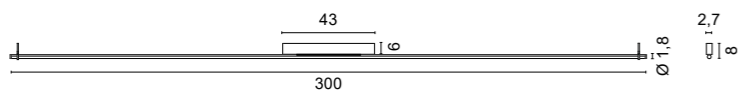

Codici finiture - Finishes codes



.01 .02 .35



Aggancio a plafone in dotazione alle lampade art. 5695 - 5696
 Ceiling connection supplied with lamps art. 5695 - 5696





design **LUX Studio**
2024



Lampada da parete/plafone a luce diffusa con struttura in alluminio, schermo in metacrilato e alimentatore integrato. Temperatura di colore selezionabile. È possibile creare gruppi di tre lampade grazie ad un apposito accessorio da ordinare separatamente.

Wall/ceiling lamp providing diffused light with aluminium frame, methacrylate screen and integrated driver. Selectable colour temperature. It is possible to create groups of three lamps thanks to a special accessory to be ordered separately.

Applique/plafonnier à lumière diffuse avec cadre en aluminium, écran en méthacrylate et driver intégré. Température de couleur sélectionnable.

Il est possible de créer des groupes de trois lampes grâce à un accessoire spécial à commander séparément.

Applique/plafón de luz difusa con marco de aluminio, pantalla de metacrilato y driver integrado. Temperatura de color seleccionable. Es posible crear grupos de tres lámparas gracias a un accesorio especial que debe pedirse por separado.

Wand-/Deckenleuchte für diffuses Licht mit Aluminiumrahmen, Methacrylatschirm und integriertem Driver. Wählbare Farbtemperatur.

Dank eines separat zu bestellenden Sonderzubehörs können Gruppen von drei Lampen gebildet werden.

Selene

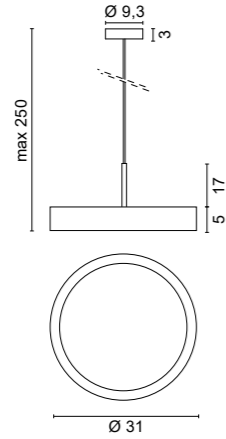

1586 Selene

- .01** Bianco - *White*
- .02** Nero - *Black*
- .35** Verniciato sabbia - *Painted sand finishing*

20W - 2300lm impostata a 4000K
20W - 2300lm set to 4000K

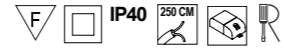

1,22 Kg

Luce bianca impostabile in tre tonalità: 2700K - 3000K - 4000K
White light that can be set in three shades: 2700K - 3000K - 4000K

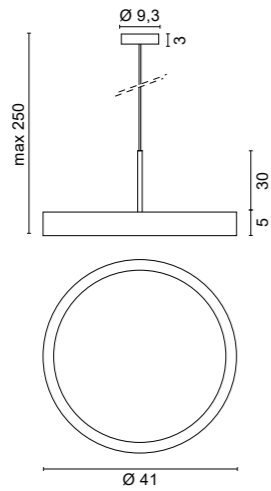

1587 Selene

- .01** Bianco - *White*
- .02** Nero - *Black*
- .35** Verniciato sabbia - *Painted sand finishing*

24W - 2520lm impostata a 4000K
24W - 2520lm set to 4000K

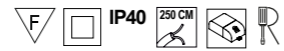

1,85 Kg

Luce bianca impostabile in tre tonalità: 2700K - 3000K - 4000K
White light that can be set in three shades: 2700K - 3000K - 4000K

Codici finiture - *Finishes codes*

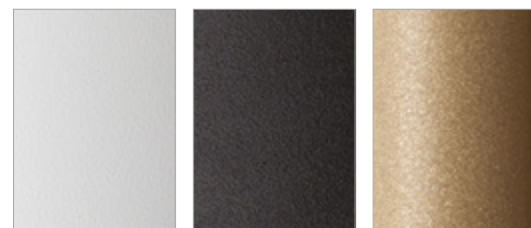

.01 **.02** **.35**



Luce bianca impostabile in tre tonalità - *White light that can be set in three shades*

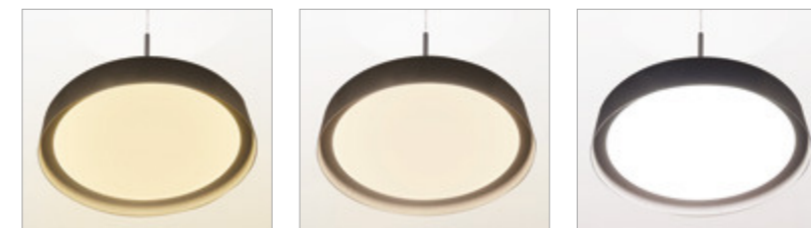

2700K **3000K** **4000K**

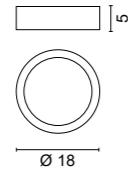

5544 Selene
 .01 Bianco - White
 .02 Nero - Black
 .35 Verniciato sabbia - Painted sand finishing

12W - 1260lm impostata a 4000K
 12W - 1260lm set to 4000K

0,50 Kg

Luce bianca impostabile in tre tonalità: 2700K - 3000K - 4000K
 White light that can be set in three shades: 2700K - 3000K - 4000K

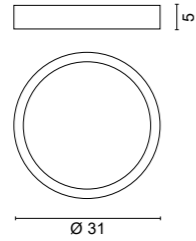

5545 Selene
 .01 Bianco - White
 .02 Nero - Black
 .35 Verniciato sabbia - Painted sand finishing

20W - 2300lm impostata a 4000K
 20W - 2300lm set to 4000K

1,05 Kg

Luce bianca impostabile in tre tonalità: 2700K - 3000K - 4000K
 White light that can be set in three shades: 2700K - 3000K - 4000K

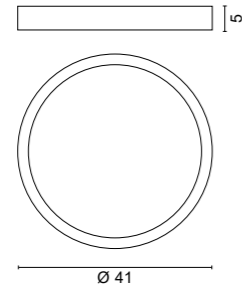

5546 Selene
 .01 Bianco - White
 .02 Nero - Black
 .35 Verniciato sabbia - Painted sand finishing

24W - 2520lm impostata a 4000K
 24W - 2520lm set to 4000K

1,68 Kg

Luce bianca impostabile in tre tonalità: 2700K - 3000K - 4000K
 White light that can be set in three shades: 2700K - 3000K - 4000K



Codici finiture - Finishes codes

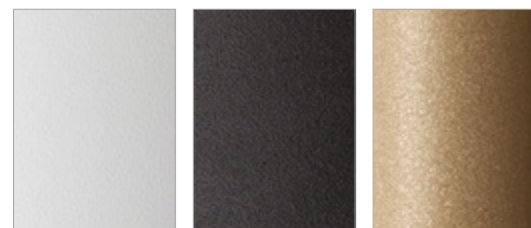

.01 .02 .35



Luce bianca impostabile in tre tonalità - White light that can be set in three shades



2700K 3000K 4000K



design **U.T. EGOLUCE**
2023

50 54
52

Famiglia di lampade a luce diffusa, caratterizzate da un'emissione luminosa a 360 gradi, con corpo in metacrilato trasparente e tappi di chiusura in alluminio. Nella versione a sospensione il rosone con alimentatore integrato è da ordinare separatamente.

Family of diffused light lamps, characterised by a 360 degree light emission, with a transparent methacrylate body and aluminium end caps. In the suspension version, the ceiling rose with integrated driver must be ordered separately.

Famille de lampes à lumière diffuse, caractérisées par une émission de lumière à 360 degrés, avec un corps en méthacrylate transparent et des embouts en aluminium. Dans la version suspendue, la rosace avec driver intégré doit être commandée séparément.

Familia de lámparas de luz difusa, caracterizadas por una emisión luminosa de 360 grados, con cuerpo de metacrilato transparente y terminales de aluminio. En la versión colgante, el florón a techo con driver integrado debe pedirse por separado.

Familie von Lampen mit diffusem Licht, die sich durch einen 360-Grad-Lichtaustritt auszeichnen, mit einem transparenten Methacrylat-Körper und Aluminium-Endkappen. Bei der Pendelversion muss die Rosette mit integriertem Driver separat bestellt werden.

Tre & Sessantotto

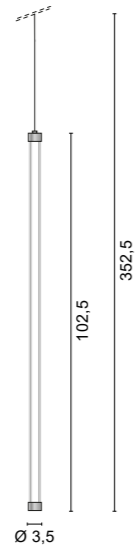

1662 Tre&Sessanta

- .01** Bianco - *White*
- .02** Nero - *Black*
- .23** Alluminio satinato - *Satin aluminium*

Color temperature	LED Light source	lm source
/WW 3000K	24V 20W	1920lm



2700K su richiesta
2700K on request

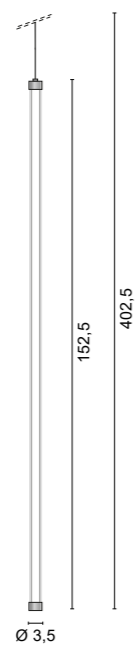

1663 Tre&Sessanta

- .01** Bianco - *White*
- .02** Nero - *Black*
- .23** Alluminio satinato - *Satin aluminium*

Color temperature	LED Light source	lm source
/WW 3000K	24V 30W	2880lm



2700K su richiesta
2700K on request



1 elemento per decentramento incluso
1 displacement component included

Codici finiture - *Finishes codes*



.01 **.02** **.23**



Esempio di installazione
1662 con rosone 0990/30.02
Example of installation 1662
with ceiling rose 0990/30.02





1666 Tre&Sessanta

- .01** Bianco - *White*
- .02** Nero - *Black*
- .23** Alluminio satinato - *Satin aluminium*

Color temperature	LED Light source	lm source
WW 3000K	24V 20W	1920lm



2700K su richiesta
2700K on request

Kit di fissaggio a sospensione fornito con la lampada
Suspension fixing kit supplied with the lamp

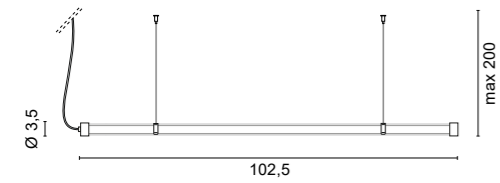

1667 Tre&Sessanta

- .01** Bianco - *White*
- .02** Nero - *Black*
- .23** Alluminio satinato - *Satin aluminium*

Color temperature	LED Light source	lm source
WW 3000K	24V 30W	2880lm



2700K su richiesta
2700K on request

Kit di fissaggio a sospensione fornito con la lampada
Suspension fixing kit supplied with the lamp

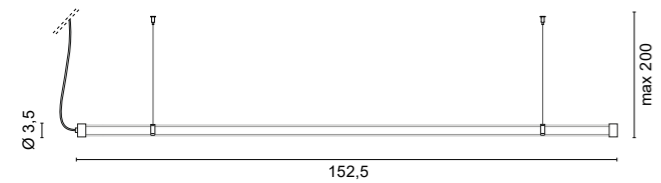

Codici finiture - *Finishes codes*

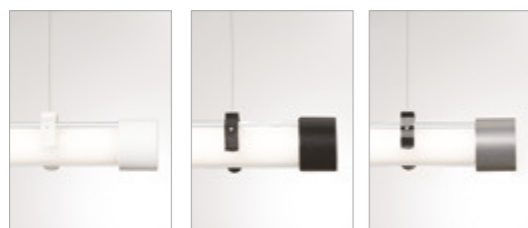

.01 **.02** **.23**



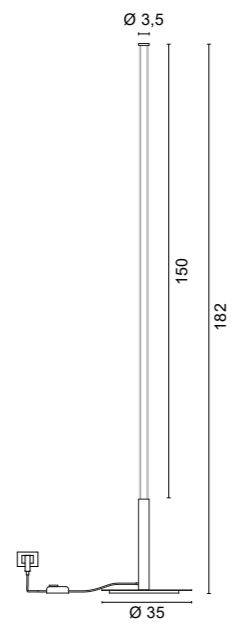

3546 Tre&Sessanta

- .01** Bianco - *White*
- .02** Nero - *Black*

Color temperature	LED Light source	lm source
MW 3000K	24V 30W	2880lm

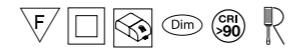

5,00 Kg

2700K su richiesta
2700K on request

Completa di DIMMER su cavo nero
With DIMMER on black cable

Codici finiture - *Finishes codes*



.01

.02

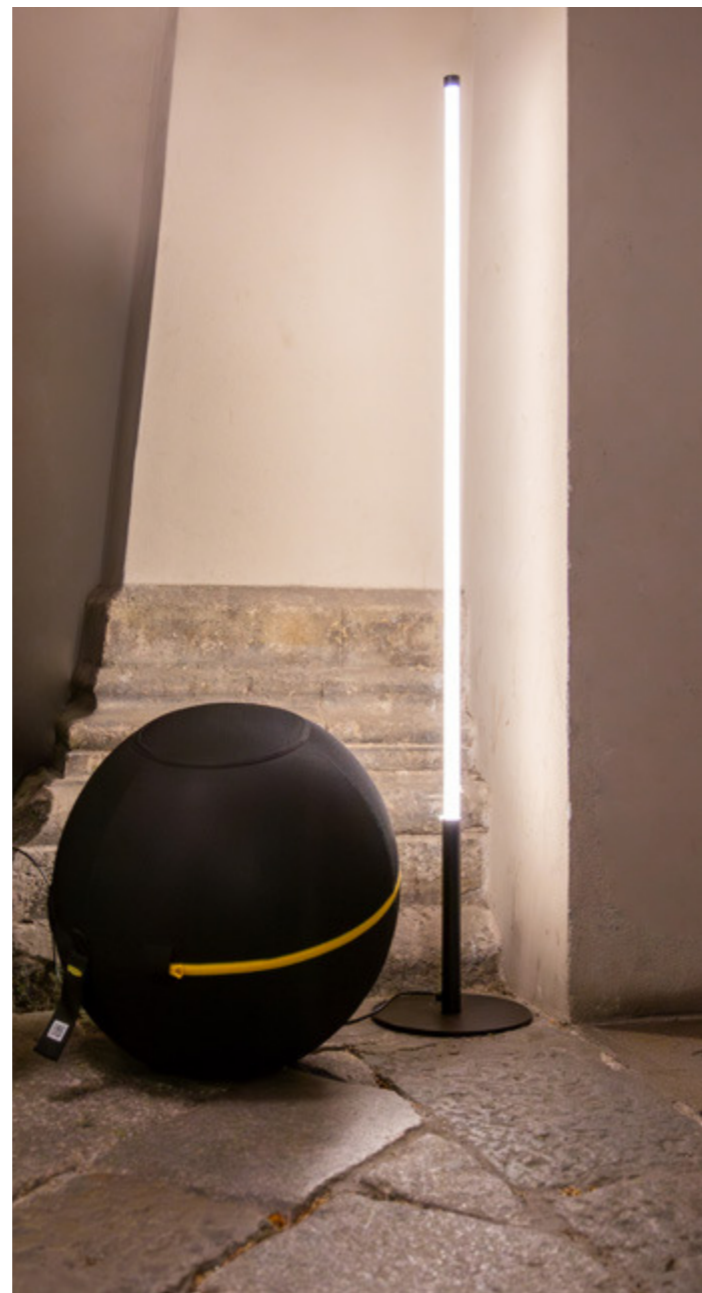

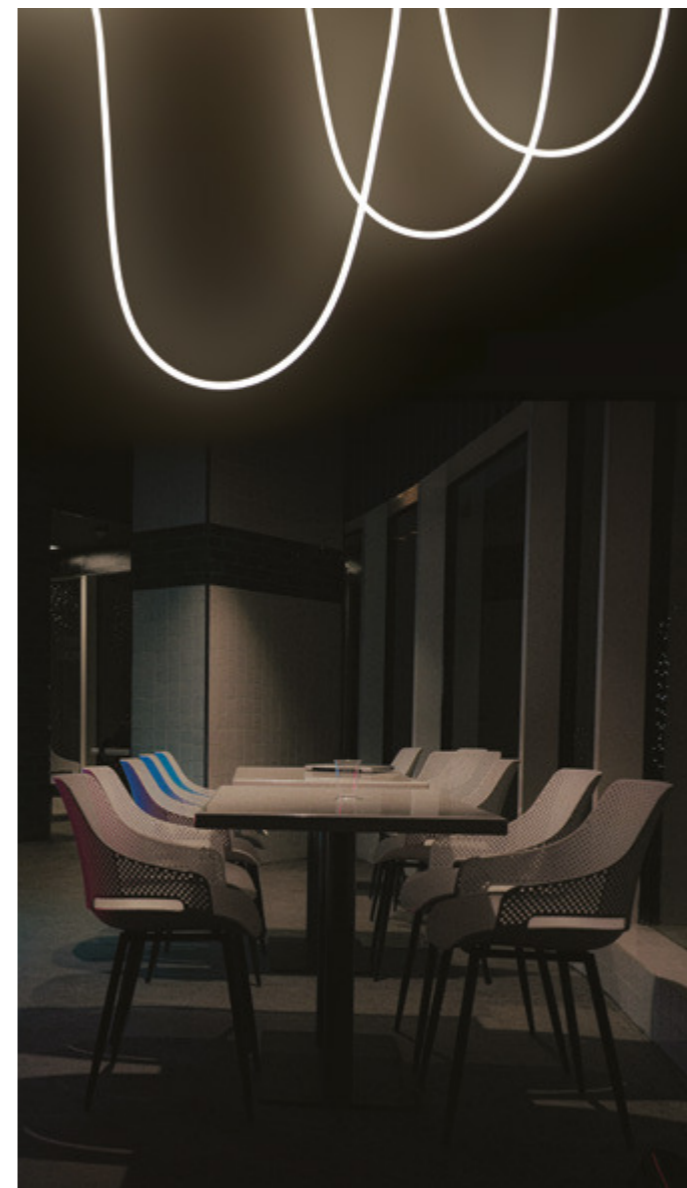

design **U.T. EGOLUCE**
2024

58 58

Sistema di illuminazione da parete e da plafone caratterizzato dalla modellabilità del corpo tubolare in silicone e dalla luce diffusa a 360 gradi. Il corpo illuminante viene fissato tramite sostegni verniciati in svariati colori che ne determinano la conformazione. L'alimentatore o il rosone sono da ordinare separatamente.

Wall and ceiling lighting system characterized by the moldability of the tubular silicone body and the 360 degree diffused light. The lighting body is fixed using supports painted in various colors which determine its shape. The driver or ceiling rose must be ordered separately.

Système d'éclairage pour murs et plafonds caractérisé par la moulabilité du corps tubulaire en silicone et la lumière diffuse à 360 degrés. Le corps lumineux est fixé à l'aide de supports peints de différentes couleurs qui déterminent sa forme. Le driver ou la rosace de plafond doivent être commandés séparément.

Sistema de iluminación de pared y techo caracterizado por la moldeabilidad del cuerpo tubular de silicona y la luz difusa de 360 grados. El cuerpo de iluminación se fija mediante soportes pintados en varios colores que determinan su forma. El driver o el florón a techo deben pedirse por separado.

Wand- und Deckenbeleuchtungssystem, das sich durch die Formbarkeit des röhrenförmigen Silikonkörpers und das diffuse 360-Grad-Licht auszeichnet. Der Leuchtenkörper wird mit verschiedenfarbig lackierten Stützen befestigt, die seine Form bestimmen. Das Driver oder der Rosette müssen separat bestellt werden.

A n d a c c o n d o

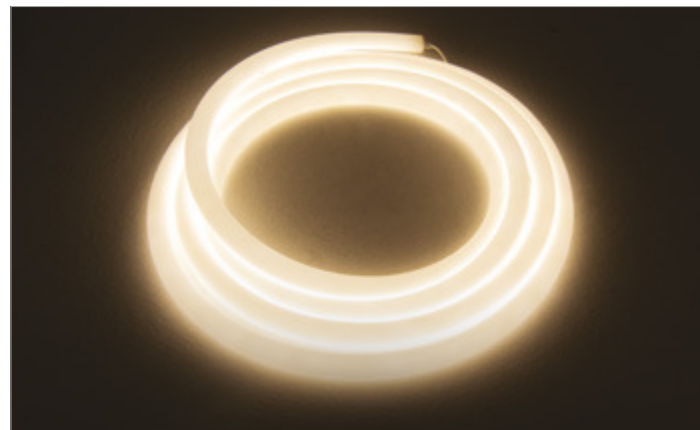

5565 Anaconda

.01 Bianco - White

Color temperature	LED Light source	lm source
WW 3000K	24V 72W	4950lm
F III IP65	150 CM	CR1-90
		3,40 Kg

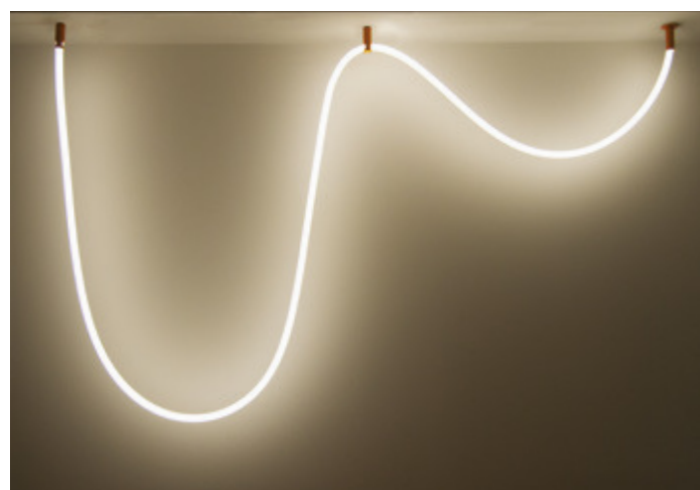
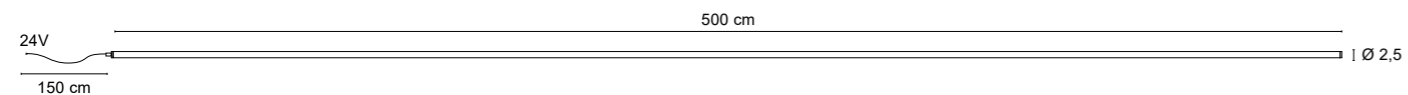

Esempio di installazione a plafone con Anaconda 5565.01 + 7531.09 + 2 x 7533.09
Example of ceiling installation with Anaconda 5565.01 + 7531.09 + 2 x 7533.09

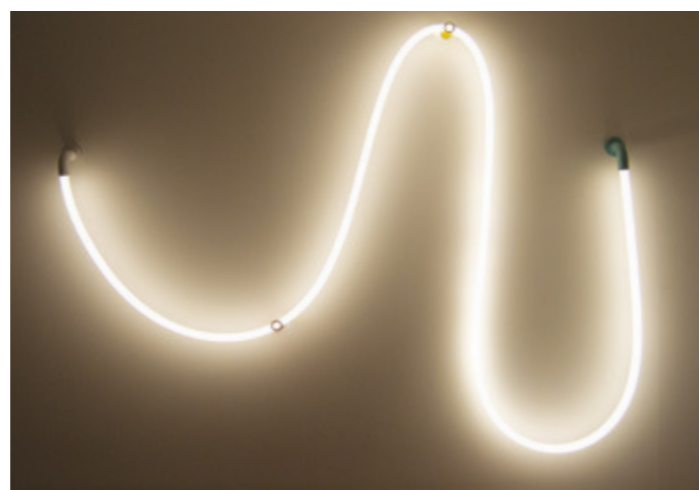

Esempio di installazione a parete con Anaconda 5565.01 + 7530.01 + 7533.08 + 7533.09 + 7530.10
Example of wall installation with Anaconda 5565.01 + 7530.01 + 7533.08 + 7533.09 + 7530.10

Codici finiture - Finishes codes

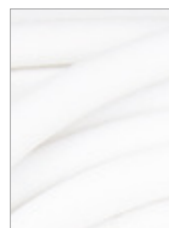

.01

Rosoni con alimentatori da ordinare separatamente (p. 108) - Ceiling roses with drivers are to be ordered separately (p. 108)

Accessori - Accessories

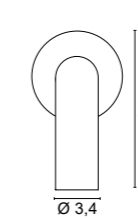
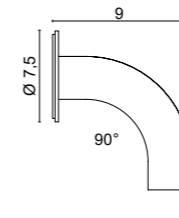

7530

Elemento di partenza a L
L-shaped starting element

- .01** Bianco - White
- .02** Nero - Black
- .08** Giallo - Yellow
- .09** Arancione - Orange
- .10** Azzurro - Light blue

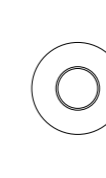
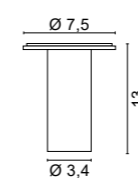

7531

Elemento di partenza
Starting element

- .01** Bianco - White
- .02** Nero - Black
- .08** Giallo - Yellow
- .09** Arancione - Orange
- .10** Azzurro - Light blue

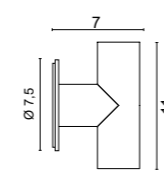

7532

Elemento di partenza a T
T-shaped starting element

- .01** Bianco - White
- .02** Nero - Black
- .08** Giallo - Yellow
- .09** Arancione - Orange
- .10** Azzurro - Light blue



7533

Elemento per decentramento
Displacement component

- .01** Bianco - White
- .02** Nero - Black
- .08** Giallo - Yellow
- .09** Arancione - Orange
- .10** Azzurro - Light blue



Codici finiture - Finishes codes



.01



.02

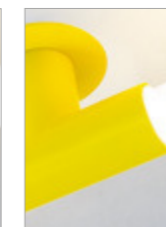

.08

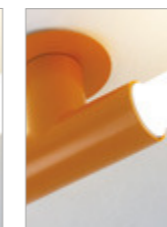

.09



.10

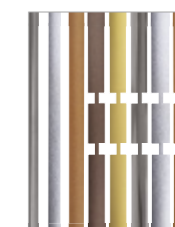



Drivers

Drivers ON/OFF

Cod.	0161/100	0161/150
	24V-100W	24V-150W

IP67 drivers

Cod.	0038/IP	0035/IP
	24V-100W	24V-160W

DIMMABLE drivers

Cod.	0717/DIM100	0717/DIM150
	24V-100W 1...10V - PUSH - DALI	24V-150W 1...10V - PUSH - DALI

DIMMABLE drivers TAGLIO DI FASE - PHASE CUT-OFF

Cod.	0717/DIM100/T	0717/DIM150/T
	24V-100W TRIAC	24V-150W TRIAC



Lampade a sospensione quadrata e rettangolare a luce diffusa con corpo in alluminio e diffusore in policarbonato opalino. La particolarità del flusso luminoso rivolto verso il basso garantisce un ottimo illuminamento esaltando ancora di più la leggerezza della struttura. Il rosone con l'alimentatore è da ordinare separatamente.

Square and rectangular pendant lamps with diffused light with aluminum body and opal polycarbonate diffuser. The particularity of the luminous flux directed downwards guarantees excellent illumination, further enhancing the lightness of the structure. The ceiling rose with the integrated driver must be ordered separately.

Suspensions carrées et rectangulaires à lumière diffuse avec corps en aluminium et diffuseur en polycarbonate opale. La particularité du flux lumineux dirigé vers le bas garantit un excellent éclairage, renforçant encore la légèreté de la structure. La rosace avec driver intégré doit être commandée séparément.

Lámparas colgantes cuadradas y rectangulares de luz difusa con cuerpo de aluminio y difusor de policarbonato opalino. La particularidad del flujo luminoso orientado hacia abajo garantiza una excelente iluminación, realizando aún más la ligereza de la estructura. El florón a techo con driver debe pedirse por separado.

Quadratische und rechteckige Pendelleuchten mit diffusem Licht mit Aluminiumgehäuse und opalem Polycarbonat-Diffusor. Die Besonderheit des nach unten gerichteten Lichtstroms garantiert eine hervorragende Ausleuchtung und erhöht die Leichtigkeit der Struktur zusätzlich. Die Rosette mit Netzteil muss separat bestellt werden.

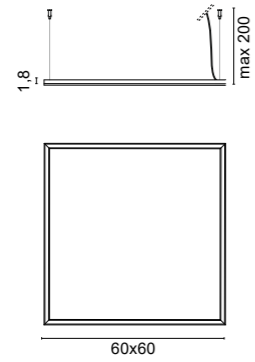
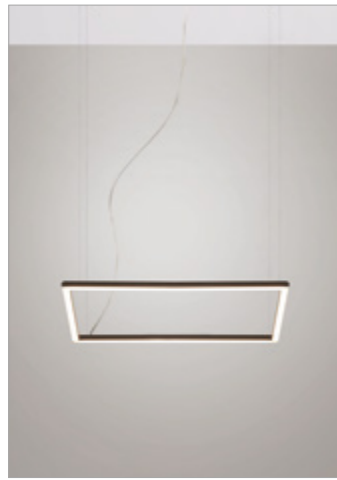

- 1608** Frame
- .01 Bianco - White
 - .02 Nero - Black
 - .25 Dorato satinato - Satin golded
 - .31 Cromato - Chromed

Color temperature	LED Light source	lm source
/W 4000K	24V 43,2W	5420lm
/WW 3000K	24V 43,2W	4848lm
/XW 2700K	24V 43,2W	4536lm



0,30 Kg

Cavo di sospensione in nylon trasparente
Transparent nylon suspension cable

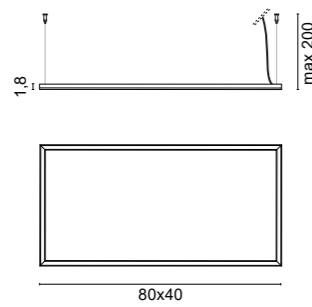

- 1609** Frame
- .01 Bianco - White
 - .02 Nero - Black
 - .25 Dorato satinato - Satin golded
 - .31 Cromato - Chromed

Color temperature	LED Light source	lm source
/W 4000K	24V 43,2W	5420lm
/WW 3000K	24V 43,2W	4848lm
/XW 2700K	24V 43,2W	4536lm



0,30 Kg

Cavo di sospensione in nylon trasparente
Transparent nylon suspension cable

Codici finiture - Finishes codes

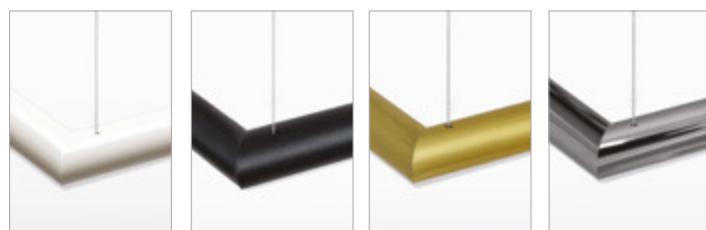

.01

.02

.25

.31

Rosoni con alimentatori da ordinare separatamente (p. 108) - Ceiling roses with drivers are to be ordered separately (p. 108)

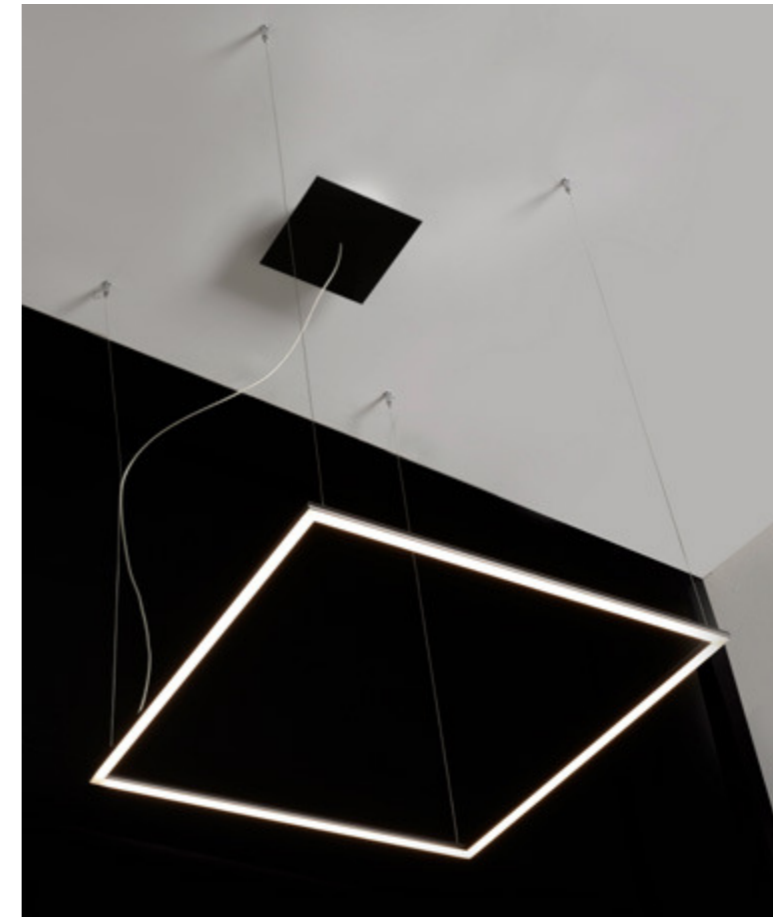

Esempio di installazione con rosone 0993/60.02
Example of installation with ceiling rose 0993/60.02





Lampade a sospensione e da terra a luce diffusa con corpo in alluminio e diffusore in policarbonato opalino. La particolarità del flusso luminoso rivolto verso l'interno dell'arco garantisce un buon confort visivo e contribuisce ad esaltare la leggerezza della struttura. Nella versione a sospensione il rosone con l'alimentatore è da ordinare separatamente.

Suspension and floor lamps with diffused light with aluminum body and opaline polycarbonate diffuser. The particularity of the luminous flux directed towards the inside of the arch guarantees good visual comfort and helps to enhance the lightness of the structure. In the pendant version, the ceiling rose with the integrated driver must be ordered separately.

Lampes à suspension et lampadaires à lumière diffuse avec corps en aluminium et diffuseur en polycarbonate opalin. La particularité du flux lumineux dirigé vers l'intérieur de la voûte garantit un bon confort visuel et contribue à valoriser la légèreté de la structure. Dans la version suspendue, la rosace avec driver doit être commandée séparément.

Lámparas de suspensión y de pie de luz difusa con cuerpo de aluminio y difusor de policarbonato opalino. La particularidad del flujo luminoso dirigido hacia el interior del arco garantiza un buen confort visual y contribuye a realzar la ligereza de la estructura. En la versión Suspensión, el florón a techo con driver debe pedirse por separado.

Hänge und Stehleuchten mit Aluminiumgehäuse und opalem Polycarbonatdiffusor für diffuses Licht. Die Besonderheit des Lichtstroms, der in das Innere des Bogens gerichtet ist, garantiert einen guten Sehkomfort und trägt dazu bei, die Leichtigkeit der Struktur zu verstärken. Bei der Version mit Aufhängung muss die Rosette mit Driver separat bestellt werden.

Virgola



1584 Virgola

- .01** Bianco - *White*
- .02** Nero - *Black*
- .35** Verniciato sabbia - *Painted sand finishing*

Color temperature	LED Light source	lm source
W 4000K	24V 27W	3390lm
WW 3000K	24V 27W	3030lm
XW 2700K	24V 27W	2835lm



0,45 Kg

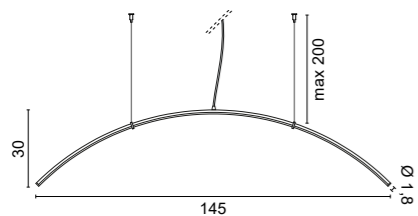

1585 Virgola

- .01** Bianco - *White*
- .02** Nero - *Black*
- .35** Verniciato sabbia - *Painted sand finishing*

Color temperature	LED Light source	lm source
W 4000K	24V 41,4W	5198lm
WW 3000K	24V 41,4W	4646lm
XW 2700K	24V 41,4W	4347lm



0,70 Kg

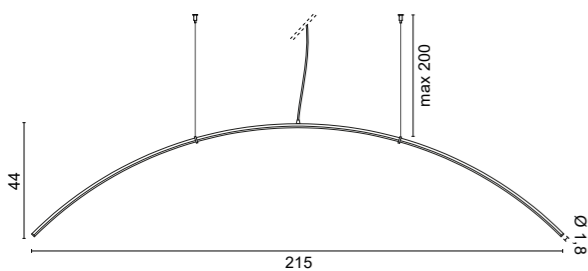

Codici finiture - *Finishes codes*



.01 **.02** **.35**

Rosoni con alimentatori da ordinare separatamente (p. 108) - *Ceiling roses with drivers are to be ordered separately (p. 108)*



Esempio di installazione con rosone 0990/60.02
Example of installation with ceiling rose 0990/60.02

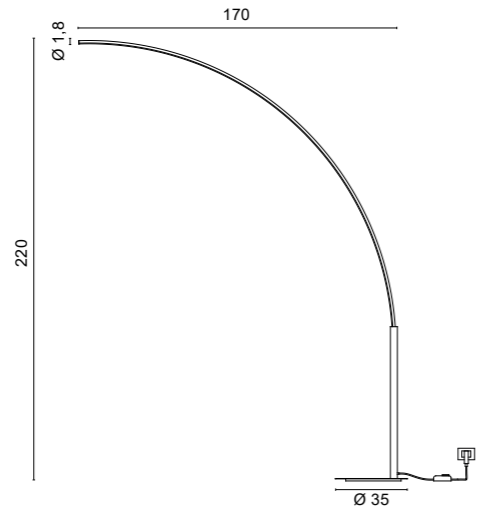

- 3535** Virgola
- .01** Bianco - *White*
 - .02** Nero - *Black*
 - .35** Verniciato sabbia - *Painted sand finishing*

Color temperature	LED Light source	lm source
W 4000K	33W	4048lm
WW 3000K	33W	3630lm
XW 2700K	33W	3432lm

7,00 Kg

Completa di DIMMER su cavo nero
 With DIMMER on black cable



Codici finiture - *Finishes codes*

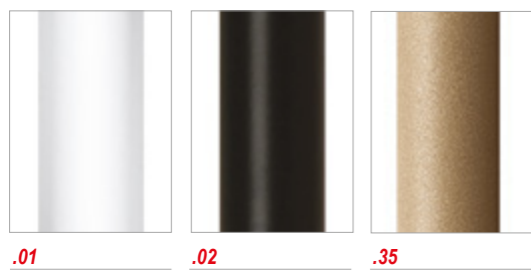



design **U.T. EgoIuce**
2013

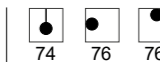

Famiglia di lampade orientabili IP54 o IP67 a luce diffusa con struttura in metacrilato trasparente anti-UV, terminali in acciaio INOX AISI 316L e cavo in neoprene. Disponibili in diverse lunghezze. Il rosone con l'alimentatore per la versione a sospensione o gli alimentatori per le versioni da plafone e da parete sono da ordinare separatamente.

Family of IP54 or IP67 adjustable lamps with diffused light with transparent anti-UV methacrylate structure, AISI 316L stainless steel terminals and neoprene cable. Available in different lengths. The ceiling rose with driver for the suspension version or drivers for the ceiling and wall versions must be ordered separately.

Famille de lampes orientables IP54 ou IP67 à lumière diffuse avec structure transparente en méthacrylate anti-UV, bornes en acier inoxydable AISI 316L et câble en néoprène. Disponibles en différentes longueurs. La rosace avec driver pour la version suspension ou les drivers pour les versions plafond et murale doivent être commandés séparément.

Familia de lámparas orientables de luz difusa IP54 o IP67 con estructura de metacrilato transparente anti-UV, terminales de acero inoxidable AISI 316L y cable de neopreno. Disponibles en diferentes longitudes. El florón a techo con driver para la versión de suspensión o los drivers para las versiones de techo y pared deben pedirse por separado.

Familie verstellbarer IP54- oder IP67-Leuchten mit diffusem Licht mit transparenter Anti-UV-Methacrylatstruktur, Anschlüssen aus Edelstahl AISI 316L und Neoprenkabel. Erhältlich in verschiedenen Längen. Die Rosette mit Driver für die Hängeversion oder die Drivers für die Decken- und Wandversionen müssen separat bestellt werden.



popuW



1665 Wanda System
128 cm
.33 Acciaio satinato - Matt steel
 Inox AISI 316L

Color temperature	LED Light source	Im source
/128/W 4000K	18W	2208lm
/128/WW 3000K	18W	1980lm
/128/XW 2700K	18W	1872lm

1,10 Kg

158 cm
.33 Acciaio satinato - Matt steel
 Inox AISI 316L

Color temperature	LED Light source	Im source
/158/W 4000K	22,5W	2760lm
/158/WW 3000K	22,5W	2475lm
/158/XW 2700K	22,5W	2340lm

1,36 Kg

178 cm
.33 Acciaio satinato - Matt steel
 Inox AISI 316L

Color temperature	LED Light source	Im source
/178/W 4000K	25,5W	3128lm
/178/WW 3000K	25,5W	2805lm
/178/XW 2700K	25,5W	2652lm

1,53 Kg

208 cm
.33 Acciaio satinato - Matt steel
 Inox AISI 316L

Color temperature	LED Light source	Im source
/208/W 4000K	30W	3680lm
/208/WW 3000K	30W	3300lm
/208/XW 2700K	30W	3120lm

1,79 Kg



Kit di fissaggio a sospensione fornito con la lampada
 Suspension fixing kit supplied with the lamp

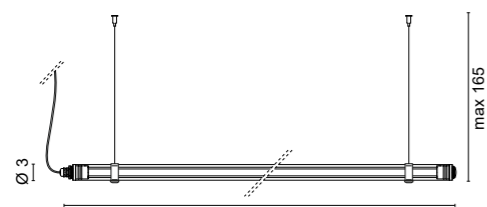

- 1565/128** 128
- 1565/158** 158
- 1565/178** 178
- 1565/208** 208

Codici finiture - Finishes codes



.33

Rosoni con alimentatori da ordinare separatamente (p. 108) - Ceiling roses with drivers are to be ordered separately (p. 108)

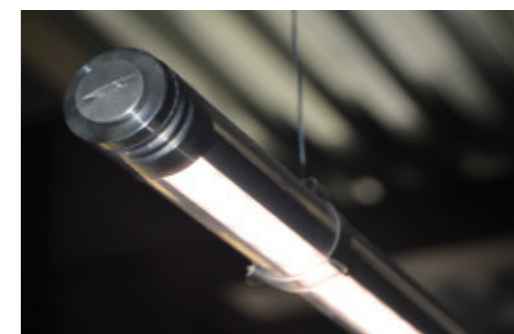

Il profilo può ruotare sul suo asse di 360° per orientare la luce
 The profile can rotate on its axis of 360° to direct the light

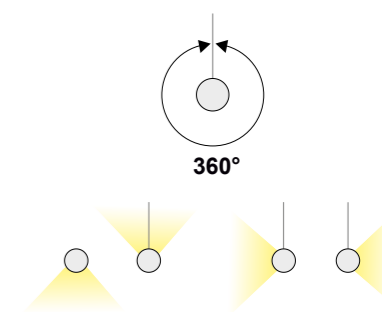

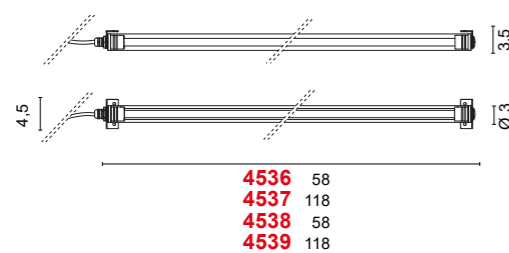

4536 58
4537 118
4538 58
4539 118

Codici finiture - Finishes codes

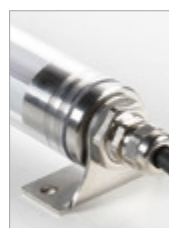

.33

4536 Wanda
.33 Acciaio satinato - Matt steel
Inox AISI 316L

Color temperature	LED Light source	lm source
/W 4000K	24V 7,5W	920lm
/WW 3000K	24V 7,5W	825lm
/XW 2700K	24V 7,5W	780lm

IK10 IP67 100 CM CRI-90 R 0,50 Kg

Versione ETL disponibile su richiesta
ETL version available on request

Solo collegamento in parallelo - Only parallel connection

4537 Wanda
.33 Acciaio satinato - Matt steel
Inox AISI 316L

Color temperature	LED Light source	lm source
/W 4000K	24V 16,5W	2024lm
/WW 3000K	24V 16,5W	1815lm
/XW 2700K	24V 16,5W	1716lm

IK10 IP67 100 CM CRI-90 R 1,00 Kg

Versione ETL disponibile su richiesta
ETL version available on request

Solo collegamento in parallelo - Only parallel connection

4538 Wanda RGB
.33 Acciaio satinato - Matt steel
Inox AISI 316L

LED Light source
24V 7,2W

IK10 IP67 100 CM CRI-90 R 0,50 Kg

Versione ETL disponibile su richiesta
ETL version available on request

Solo collegamento in parallelo - Only parallel connection

4539 Wanda RGB
.33 Acciaio satinato - Matt steel
Inox AISI 316L

LED Light source
24V 15,8W

IK10 IP67 100 CM CRI-90 R 1,00 Kg

Versione ETL disponibile su richiesta
ETL version available on request

Solo collegamento in parallelo - Only parallel connection

CUSTOM SIZE

Tabella lunghezze disponibili. Le misure si riferiscono alle lunghezze totali delle lampade complete di tappi.
Table of available lengths. Measures are referred to complete fixtures including closing heads.

cm	watt	2700K (XW)	lm source	3000K (WW)	lm source	4000K (W)	lm source	RGB
18	1,5W	A4536.33/18/XW	156	A4536.33/18/WW	165	A4536.33/18/W	184	A4536.33/18RGB
28	3W	A4536.33/28/XW	312	A4536.33/28/WW	330	A4536.33/28/W	368	A4536.33/28RGB
38	4,5W	A4536.33/38/XW	468	A4536.33/38/WW	495	A4536.33/38/W	552	A4536.33/38RGB
48	6W	A4536.33/48/XW	624	A4536.33/48/WW	660	A4536.33/48/W	736	A4536.33/48RGB
* 58	7,5W	4536.33/XW	780	4536.33/WW	825	4536.33/W	920	4538.33
68	9W	A4536.33/68/XW	936	A4536.33/68/WW	990	A4536.33/68/W	1104	A4536.33/68RGB
78	10,5W	A4536.33/78/XW	1092	A4536.33/78/WW	1155	A4536.33/78/W	1288	A4536.33/78RGB
88	12W	A4536.33/88/XW	1248	A4536.33/88/WW	1320	A4536.33/88/W	1472	A4536.33/88RGB
98	13,5W	A4536.33/98/XW	1404	A4536.33/98/WW	1485	A4536.33/98/W	1656	A4536.33/98RGB
108	15W	A4536.33/108/XW	1560	A4536.33/108/WW	1650	A4536.33/108/W	1840	A4536.33/108RGB
* 118	16,5W	4537.33/XW	1716	4537.33/WW	1815	4537.33/W	2024	4539.33
128	18W	A4536.33/128/XW	1872	A4536.33/128/WW	1980	A4536.33/128/W	2208	A4536.33/128RGB
138	19,5W	A4536.33/138/XW	2028	A4536.33/138/WW	2145	A4536.33/138/W	2392	A4536.33/138RGB
148	21W	A4536.33/148/XW	2184	A4536.33/148/WW	2310	A4536.33/148/W	2576	A4536.33/148RGB
158	22,5W	A4536.33/158/XW	2340	A4536.33/158/WW	2475	A4536.33/158/W	2760	A4536.33/158RGB
168	24W	A4536.33/168/XW	2496	A4536.33/168/WW	2640	A4536.33/168/W	2944	A4536.33/168RGB
178	25,5W	A4536.33/178/XW	2652	A4536.33/178/WW	2805	A4536.33/178/W	3128	A4536.33/178RGB
188	27W	A4536.33/188/XW	2808	A4536.33/188/WW	2970	A4536.33/188/W	3312	A4536.33/188RGB
198	28,5W	A4536.33/198/XW	2964	A4536.33/198/WW	3135	A4536.33/198/W	3396	A4536.33/198RGB
208	30W	A4536.33/208/XW	3120	A4536.33/208/WW	3300	A4536.33/208/W	3680	A4536.33/208RGB
218	31,5W	A4536.33/218/XW	3276	A4536.33/218/WW	3465	A4536.33/218/W	3864	A4536.33/218RGB
228	33W	A4536.33/228/XW	3432	A4536.33/228/WW	3630	A4536.33/228/W	4048	A4536.33/228RGB
238	34,5W	A4536.33/238/XW	3588	A4536.33/238/WW	3795	A4536.33/238/W	4232	A4536.33/238RGB
248	36W	A4536.33/248/XW	3744	A4536.33/248/WW	3960	A4536.33/248/W	4416	A4536.33/248RGB
258	37,5W	A4536.33/258/XW	3900	A4536.33/258/WW	4125	A4536.33/258/W	4600	A4536.33/258RGB
268	39W	A4536.33/268/XW	4056	A4536.33/268/WW	4290	A4536.33/268/W	4784	A4536.33/268RGB
278	40,5W	A4536.33/278/XW	4212	A4536.33/278/WW	4455	A4536.33/278/W	4968	A4536.33/278RGB
288	42W	A4536.33/288/XW	4368	A4536.33/288/WW	4620	A4536.33/288/W	5152	A4536.33/288RGB
298	43,5W	A4536.33/298/XW	4524	A4536.33/298/WW	4785	A4536.33/298/W	5336	A4536.33/298RGB

* Articolo standard a catalogo - Standard catalogue item

Drivers

Drivers ON/OFF

Cod.	0155	0156	0160	0157	0161/100	0161/150
	24V-13W	24V-25W	24V-60W	24V-75W	24V-100W	24V-150W

IP67 drivers

Cod.	0033/IP	0034/IP	0038/IP	0035/IP
	24V-14,4W	24V-70W	24V-100W	24V-160W

DIMMABLE drivers

Cod.	0717/DIM60/V	0717/DIM60	0717/DIM100	0717/DIM150
	24V-60W 1...10V	24V-60W PUSH - DALI	24V-100W 1...10V - PUSH - DALI	24V-150W 1...10V - PUSH - DALI

DIMMABLE drivers TAGLIO DI FASE - PHASE CUT-OFF

Cod.	0727/DIM30	0727/DIM50	0717/DIM100/T	0717/DIM150/T
	24V-30W TRIAC	24V-50W TRIAC	24V-100W TRIAC	24V-150W TRIAC

RGB drivers

Cod.	0164	0167	0163	0165	0166
	120W	22W	IR Sensor	IR Remote controller	Sync. Cable
IN:230V - OUT: 3x24V					

LED emergency unit

Cod.	0115/EM
	Inverter + Battery + LED indicator



design **Mati**
2021

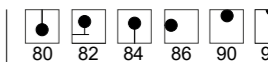

Collezione di lampade orientabili a luce diffusa caratterizzate dall'esile profilo, con struttura in alluminio e diffusore in policarbonato, e dal micro circuito LED ad alta efficienza luminosa. Gli alimentatori per la versione ad incasso ed i rosoni con alimentatore per le versioni a sospensione sono da ordinare separatamente.

Collection of adjustable lamps with diffused light characterised by their slender profile, with an aluminium structure and polycarbonate diffuser, and by the highly efficient LED micro circuit. The drivers for the recessed version and the ceiling roses with driver for the pendant versions must be ordered separately.

Collection de lampes orientables à lumière diffuse caractérisées par leur profil élancé, avec un cadre en aluminium et un diffuseur en polycarbonate, et par le micro-circuit LED à haute efficacité. Les drivers pour la version encastrée et les rosaces avec drivers pour les versions suspendues doivent être commandés séparément.

Colección de lámparas orientables de luz difusa caracterizadas por su perfil esbelto, con marco de aluminio y difusor de policarbonato, y por el microcircuito LED de alta eficiencia luminosa. Las fuentes de alimentación para la versión empotrada y el florón a techo con driver integrado para las versiones colgantes deben pedirse por separado.

Eine Kollektion verstellbarer Leuchten mit diffusem Licht, die sich durch ihr schlankes Profil mit Aluminiumrahmen und Polycarbonat-Diffusor sowie einen hocheffizienten LED-Mikroschaltkreis auszeichnen. Die Driver für die Unterputzversion und die Rosetten mit Driver für die hängenden Versionen müssen separat bestellt werden.

rotito
Mati



1674 Matita
.02 Nero - Black
 2x150 cm

Color temperature	LED Light source	lm source
/W 4000K	37,5W	4440lm
/WW 3000K	37,5W	4050lm
/XW 2700K	37,5W	3600lm

0,50 Kg

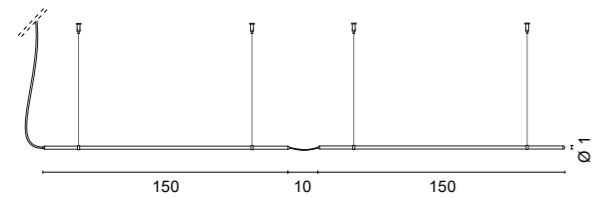

Kit di fissaggio a sospensione fornito con la lampada
Suspension fixing kit supplied with the lamp

1675 Matita
.02 Nero - Black
 3x100 cm

Color temperature	LED Light source	lm source
/W 4000K	37,5W	4440lm
/WW 3000K	37,5W	4050lm
/XW 2700K	37,5W	3600lm

0,60 Kg

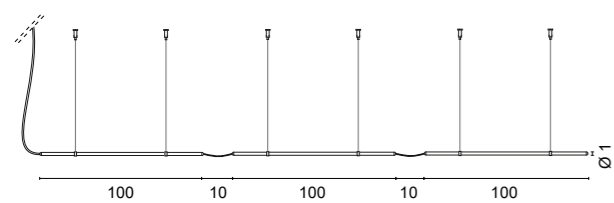

Kit di fissaggio a sospensione fornito con la lampada
Suspension fixing kit supplied with the lamp



Codici finiture - Finishes codes



.02

Rosoni con alimentatori da ordinare separatamente (p. 108) - Ceiling roses with drivers are to be ordered separately (p. 108)



Cavo di sospensione in nylon. Su ogni singolo cavo è possibile inserire e far scorrere più clips di fissaggio.
Nylon suspension cable. On each single cable it is possible to insert and slide more fixing clips.

Il profilo può ruotare sul suo asse di 360° per orientare la luce
The profile can rotate on its axis of 360° to direct the light

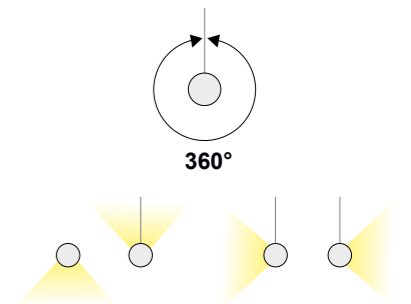

Esempi di installazione multipla, la scelta del driver è determinata dalla somma delle potenze delle singole lampade
Examples of multiple installation, the choice of the driver depends on total power consumption

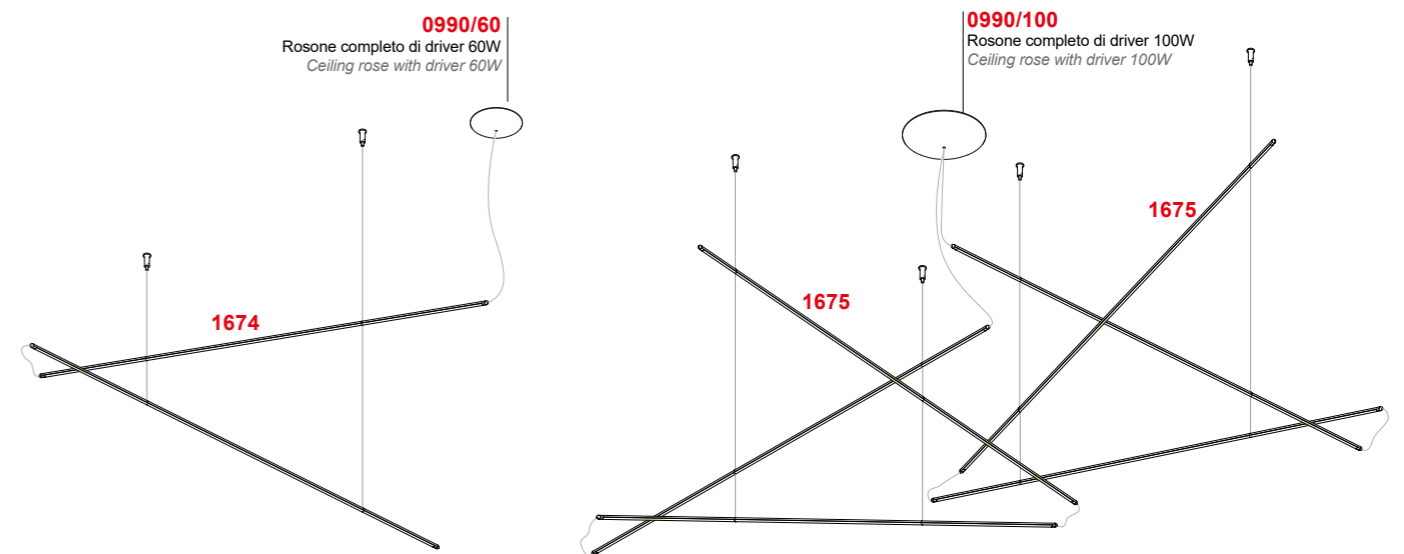

Rosoni con alimentatori da ordinare separatamente (p. 108) - Ceiling roses with drivers are to be ordered separately (p. 108)

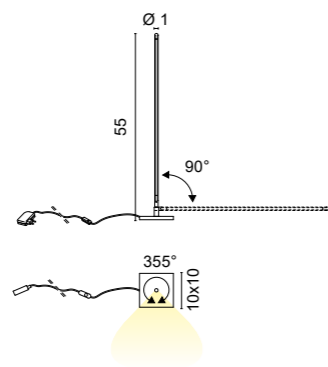

2520 Matita
.02 Nero - Black

Color temperature	LED Light source	lm source
/W 4000K	6,2W	740lm
/WW 3000K	6,2W	675lm
/XW 2700K	6,2W	600lm

F □ ⊞ Dim CR-90 R 0,50 Kg

Completa di DIMMER su cavo nero
 With DIMMER on black cable



Il profilo di luce può essere inclinato sulla base fino a disporsi parallelo al tavolo
 The light profile can be tilted on the base until it becomes parallel to the table

Codici finiture - Finishes codes



.02

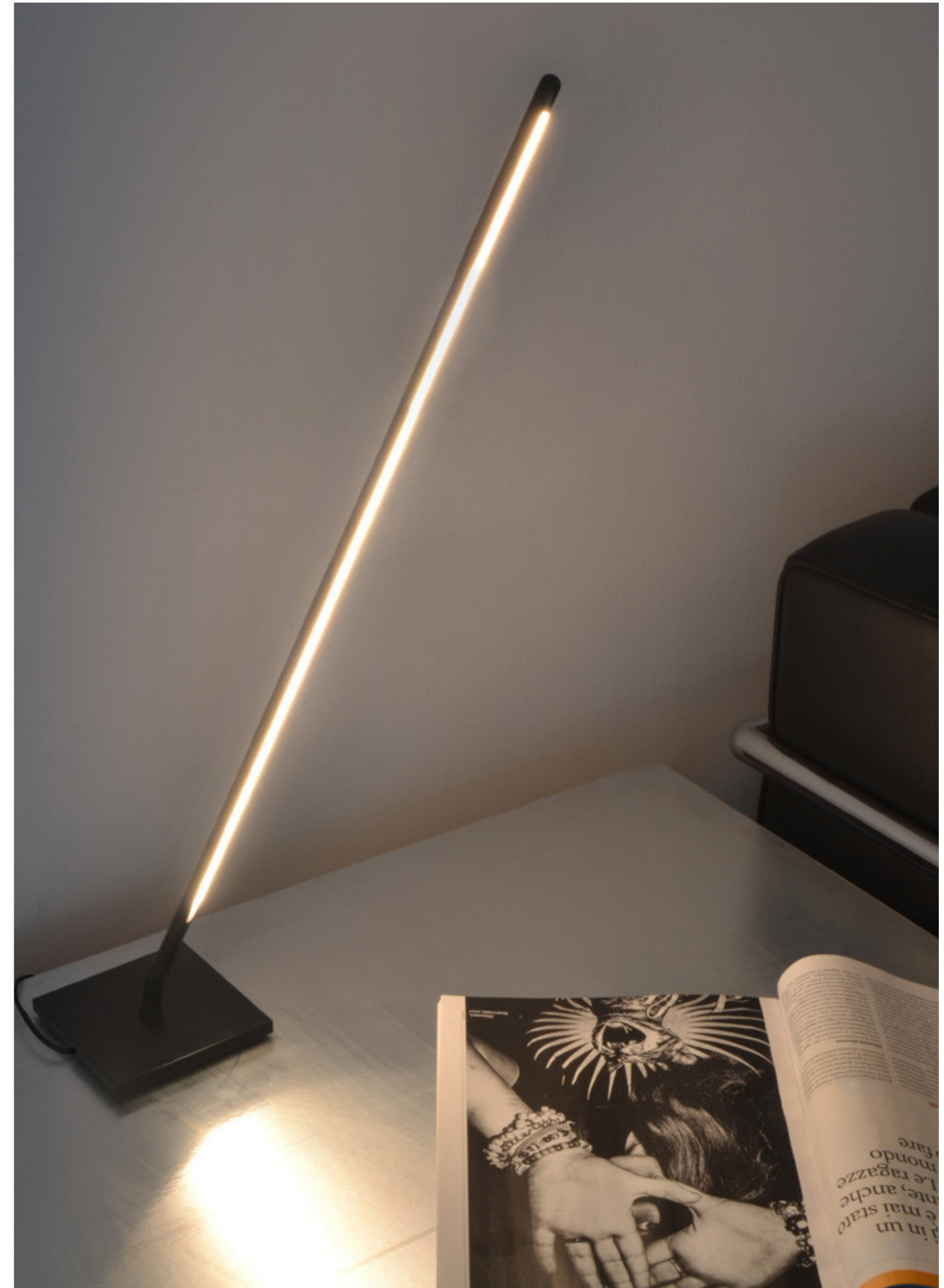

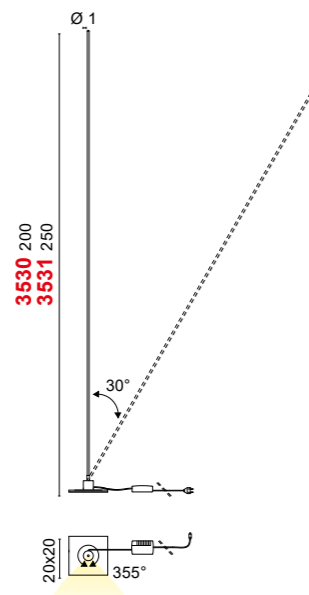

3530 Matita
.02 Nero - Black

Color temperature	LED Light source	lm source
/W 4000K	24W	2812lm
/WW 3000K	24W	2565lm
/XW 2700K	24W	2280lm

3,50 Kg

Completa di DIMMER su cavo nero
With DIMMER on black cable

3531 Matita
.02 Nero - Black

Color temperature	LED Light source	lm source
/W 4000K	30W	3552lm
/WW 3000K	30W	3240lm
/XW 2700K	30W	2880lm

3,60 Kg

Completa di DIMMER su cavo nero
With DIMMER on black cable

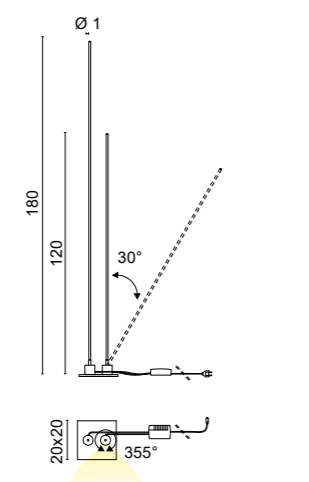

3532 Matita
.02 Nero - Black

Color temperature	LED Light source	lm source
/W 4000K	35W	4144lm
/WW 3000K	35W	3780lm
/XW 2700K	35W	3360lm

4,10 Kg

Completa di DIMMER su cavo nero
With DIMMER on black cable

Codici finiture - Finishes codes



.02



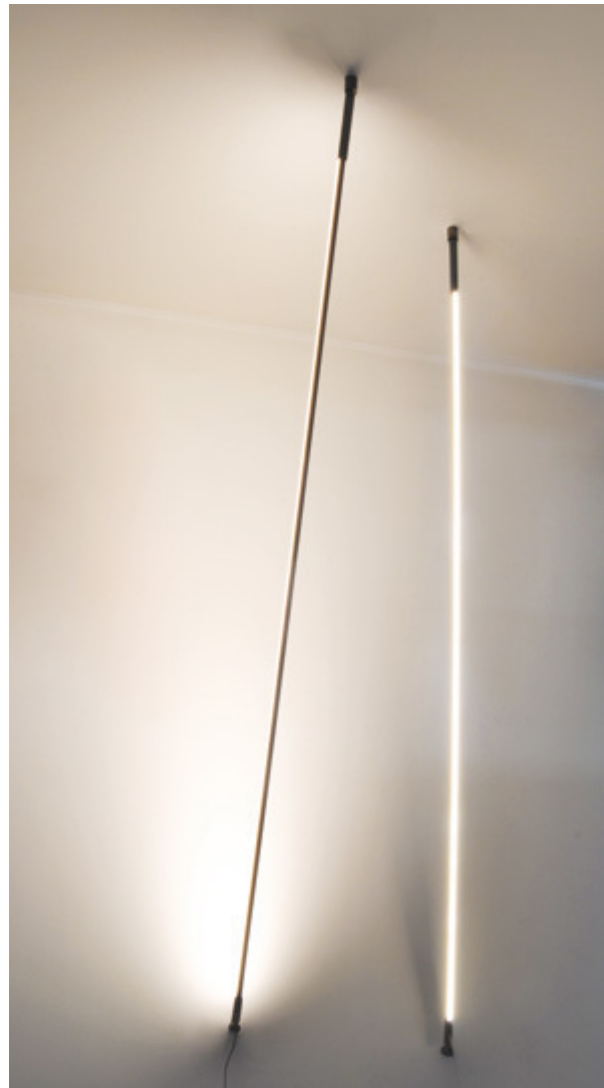

Una nuova tipologia di lampada che può essere installata tra parete e plafone per creare segni di luce liberi nello spazio
A new type of lamp that can be installed between the wall and ceiling to create free signs of light in the space

Codici finiture - Finishes codes



.02

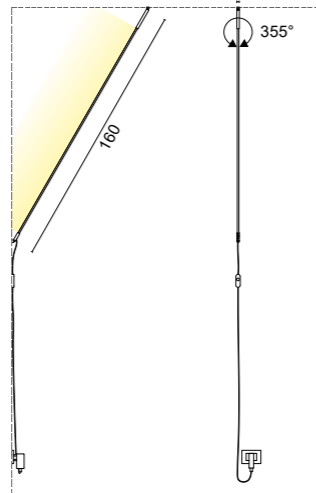

4633 Matita
.02 Nero - Black

Color temperature	LED Light source	lm source
W 4000K	19W	2020lm
WW 3000K	19W	2025lm
XW 2700K	19W	1800lm

F 200 CM Dim CRI >90 R 0,30 Kg

Completa di PUSH DIMMER su cavo nero
With PUSH DIMMER on black cable

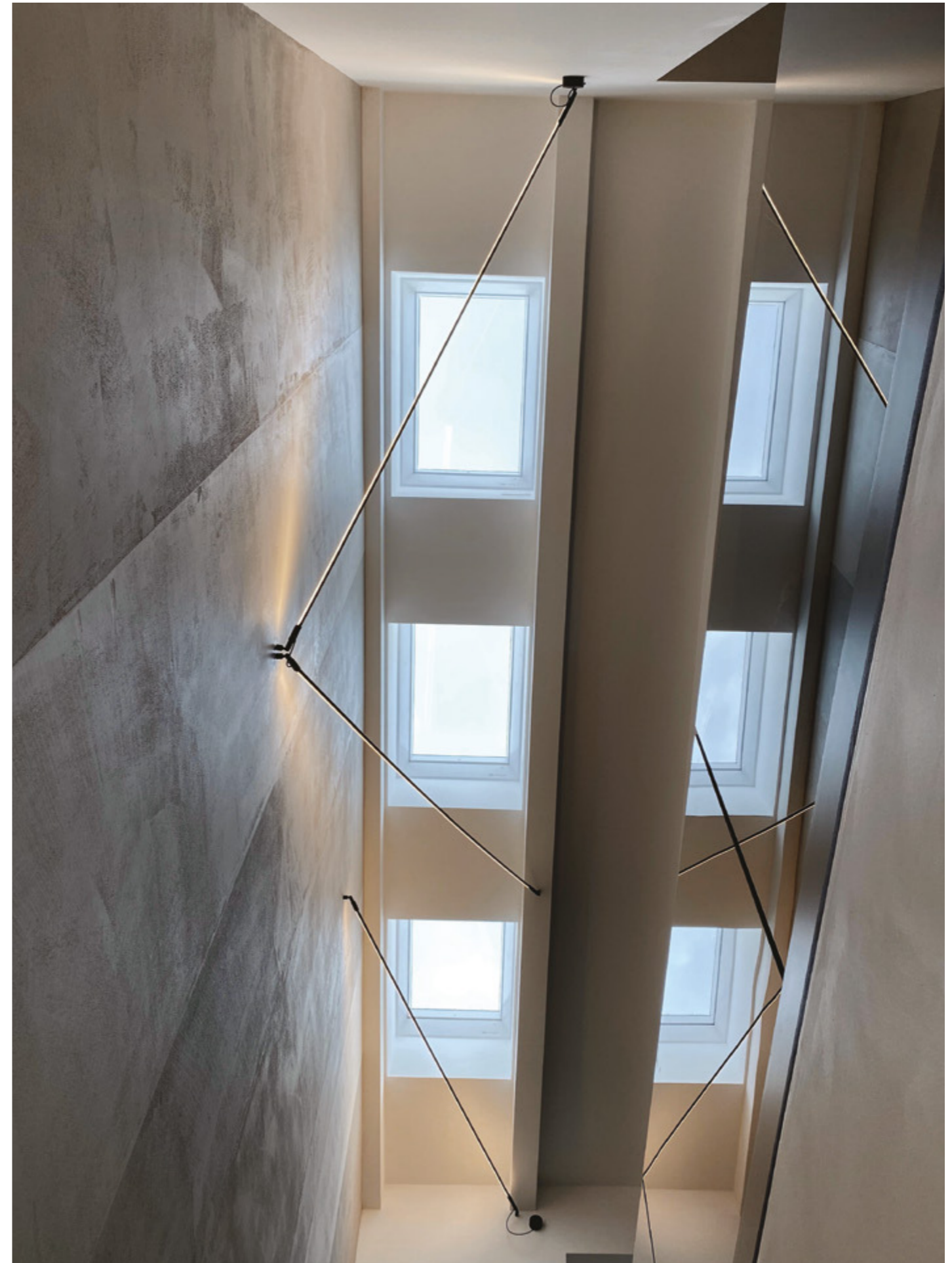

Installazione speciale con driver remoto e collegamento passante tra due profili
Special installation with remote driver and pass-through connection between two profiles



4634 Matita
.02 Nero - Black

Color temperature	LED Light source	lm source
/W 4000K	27,5W	3256m
/WW 3000K	27,5W	2970lm
/XW 2700K	27,5W	2640lm

0,80 Kg

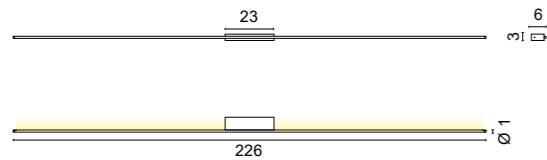

Non orientabile - Dimmerazione TRIAC su richiesta
 Not adjustable - TRIAC dimming on request

Codici finiture - Finishes codes



.02

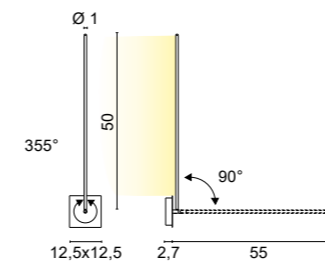

4631 Matita
.02 Nero - Black

Color temperature	LED Light source	lm source
/W 4000K	6,2W	740m
/WW 3000K	6,2W	675lm
/XW 2700K	6,2W	600lm

0,80 Kg

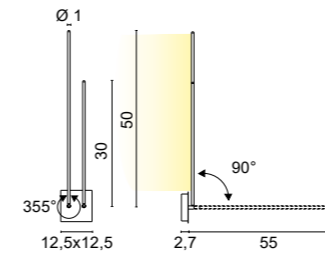

4632 Matita
.02 Nero - Black

Color temperature	LED Light source	lm source
/W 4000K	10,2W	1184lm
/WW 3000K	10,2W	1084lm
/XW 2700K	10,2W	960lm

1,00 Kg



Codici finiture - Finishes codes



.02

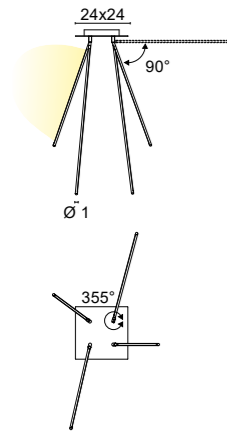

5671 Matita
.02 Nero - Black

Color temperature	LED Light source	lm source
/W 4000K	20,4W	2368lm
/WW 3000K	20,4W	2106lm
/XW 2700K	20,4W	1920lm



1,50 Kg

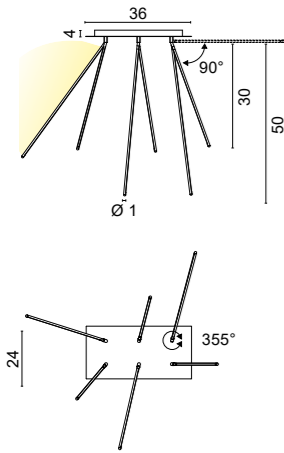

5672 Matita
.02 Nero - Black

Color temperature	LED Light source	lm source
/W 4000K	30,6W	3552lm
/WW 3000K	30,6W	3240lm
/XW 2700K	30,6W	2880lm



2,50 Kg



Codici finiture - Finishes codes



.02

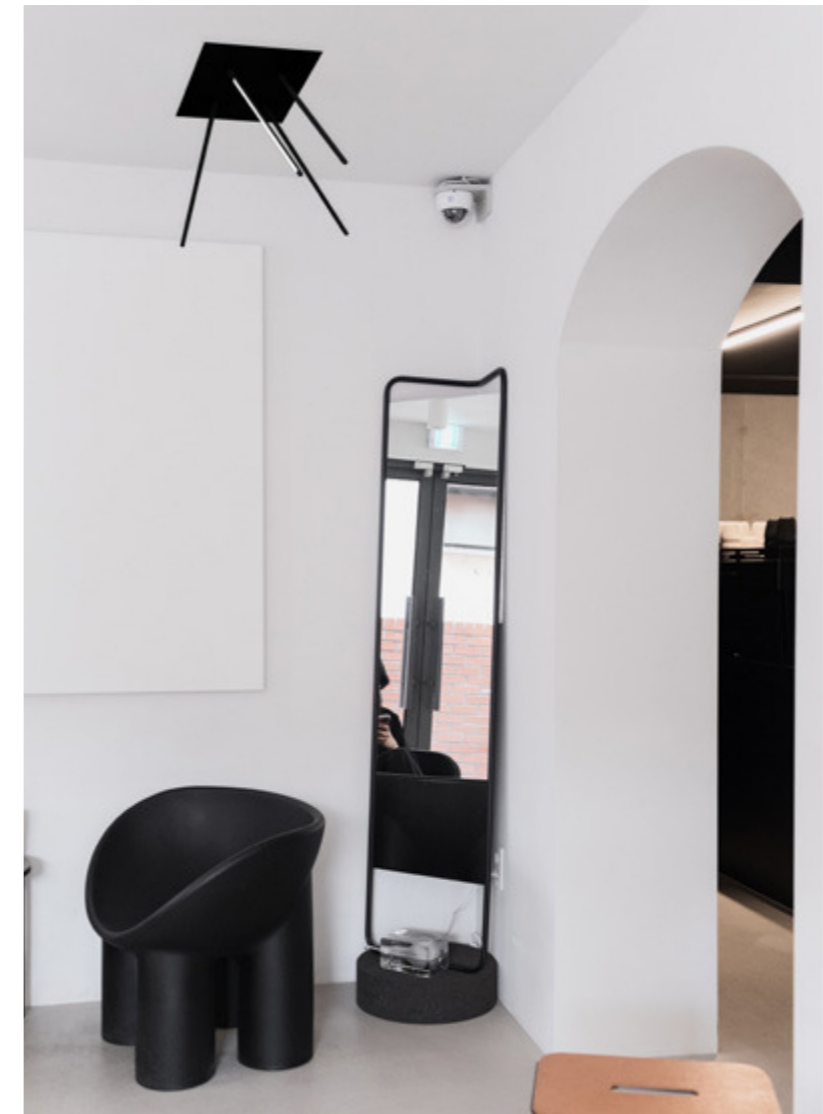

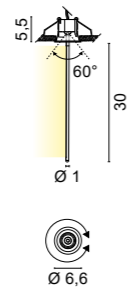
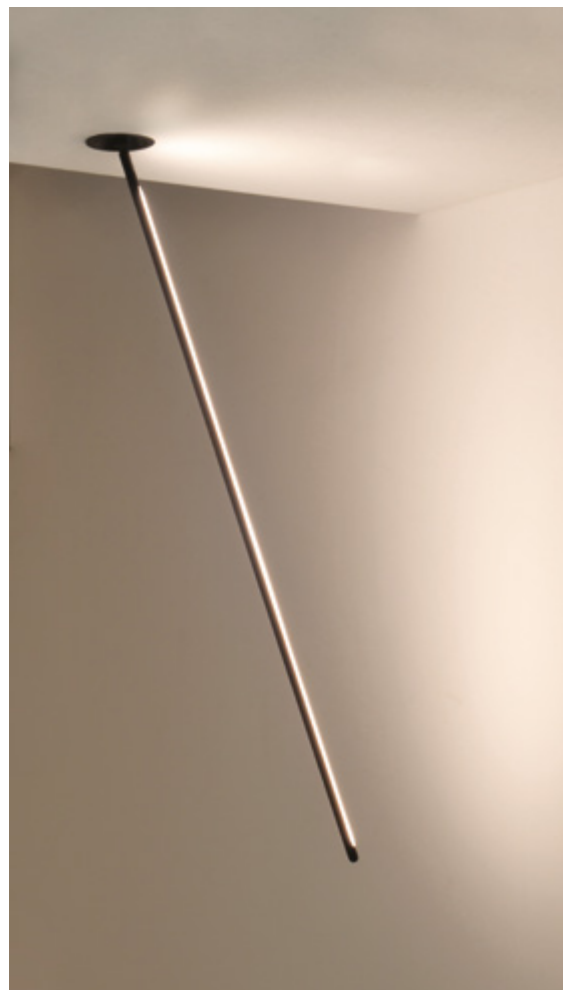

6701 Matita
.02 Nero - Black

Color temperature	LED Light source	lm source
/W 4000K	24V 4W	444lm
/WW 3000K	24V 4W	405lm
/XW 2700K	24V 4W	360lm

0,20 Kg

Solo collegamento in parallelo - *Only parallel connection*

5,9 cm

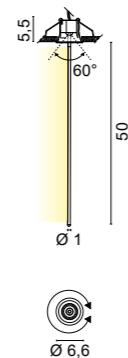
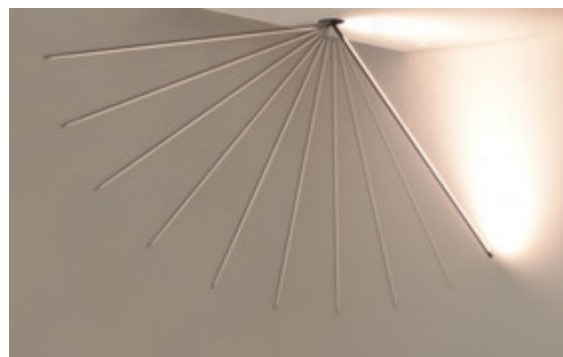

6702 Matita
.02 Nero - Black

Color temperature	LED Light source	lm source
/W 4000K	24V 6,2W	740lm
/WW 3000K	24V 6,2W	675lm
/XW 2700K	24V 6,2W	600lm

0,30 Kg

Solo collegamento in parallelo - *Only parallel connection*

5,9 cm



6703 Matita
.02 Nero - Black

Color temperature	LED Light source	lm source
/W 4000K	24V 9W	1036lm
/WW 3000K	24V 9W	945lm
/XW 2700K	24V 9W	940lm

0,40 Kg

Solo collegamento in parallelo - *Only parallel connection*

5,9 cm

Codici finiture - *Finishes codes*



.02



Drivers

Drivers **ON/OFF**

Cod.	0155	0156	0160	0157	0161/100	0161/150
24V-13W		24V-25W	24V-60W	24V-75W	24V-100W	24V-150W

DIMMABLE drivers

Cod.	0717/DIM60/V	0717/DIM60	0717/DIM100	0717/DIM100/T
24V-60W 1...10V		24V-60W PUSH - DALI	24V-100W 1...10V - PUSH - DALI	24V-100W TRIAC

LED emergency unit

Cod.	0115/EM
	Inverter + Battery + LED indicator



design **U.T. EgoIuce**
2023

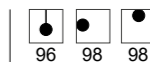

Lampade lineari a luce diffusa con struttura in alluminio e diffusore in metacrilato satinato realizzabili in diverse lunghezze. I rosoni con alimentatori per la versione a sospensione o gli alimentatori per le versioni da plafone e da parete sono da ordinare separatamente.

Linear lamps providing diffused light with aluminium frame and satin methacrylate diffuser available in different lengths. The ceiling rose with integrated driver for the suspension version or the drivers for the ceiling and wall versions must be ordered separately.

Lampes linéaires à lumière diffuse avec cadre en aluminium et diffuseur en méthacrylate satiné disponibles en différentes longueurs. La rosace de plafond avec driver intégré pour la version suspension ou les driver pour les versions plafond et murale doivent être commandés séparément.

Lámparas lineales de luz difusa con estructura de aluminio y difusor de metacrilato satinado disponibles en diferentes longitudes. El florón a techo con driver integrado para la versión de suspensión o los drivers para las versiones de techo y pared deben pedirse por separado.

Lineare Leuchten für diffuses Licht mit Aluminiumstruktur und satiniertem Methacrylat-Diffusor, erhältlich in verschiedenen Längen. Der Deckenbaldachin mit integriertem Driver für die Hängversion oder die Drivers für die Decken- und Wandversionen müssen separat bestellt werden.

R i g g o

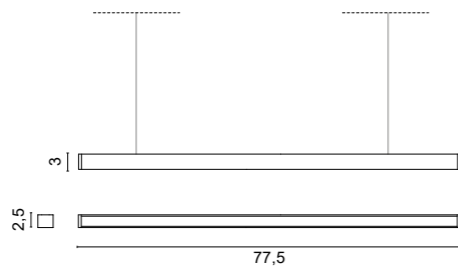

1684 Riga

.01	Bianco - White
.02	Nero - Black

Color temperature	LED Light source	lm source
/W 4000K	24V 14,4W	1860lm
/WW 3000K	24V 14,4W	1732lm
/XW 2700K	24V 14,4W	1642lm

0,20 Kg

CUSTOM SIZE

Tabella lunghezze disponibili. Le misure si riferiscono alle lunghezze totali delle lampade complete di tappi.
 Table of available lengths. Measures are referred to complete fixtures including closing heads.

cm	watt	2700K (XW)	lm source	3000K (WW)	lm source	4000K (W)	lm source
** 77,5	14,4W	1684 * /XW	1642	1684 * /WW	1732	1684 * /W	1860
102,5	19,2W	A1684 * /100/XW	2190	A1684 * /100/WW	2310	A1684 * /100/W	2480
127,5	24W	A1684 * /125/XW	2737	A1684 * /125/WW	2890	A1684 * /125/W	3100
152,5	28,8W	A1684 * /150/XW	3285	A1684 * /150/WW	3465	A1684 * /150/W	3720
177,5	33,6W	A1684 * /175/XW	3832	A1684 * /175/WW	4042	A1684 * /175/W	4340
202,5	38,4W	A1684 * /200/XW	4380	A1684 * /200/WW	4620	A1684 * /200/W	4960
227,5	43,2W	A1684 * /225/XW	4927	A1684 * /225/WW	5197	A1684 * /225/W	5580
252,5	48W	A1684 * /250/XW	5474	A1684 * /250/WW	5775	A1684 * /250/W	6200
277,5	52,8W	A1684 * /275/XW	6022	A1684 * /275/WW	6352	A1684 * /275/W	6820
302,5	57,6W	A1684 * /300/XW	6570	A1684 * /300/WW	6930	A1684 * /300/W	7440

* Finiture - Finishes:
 .01 Bianco - White
 .02 Nero - Black

** Articolo standard a catalogo - Standard catalogue item

Codici finiture - Finishes codes

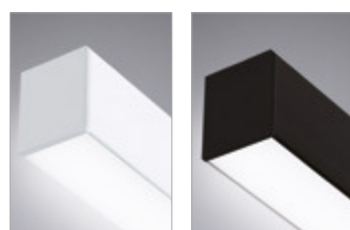

.01

.02



Rosoni con alimentatori da ordinare separatamente (p. 108) - Ceiling roses with drivers are to be ordered separately (p. 108)

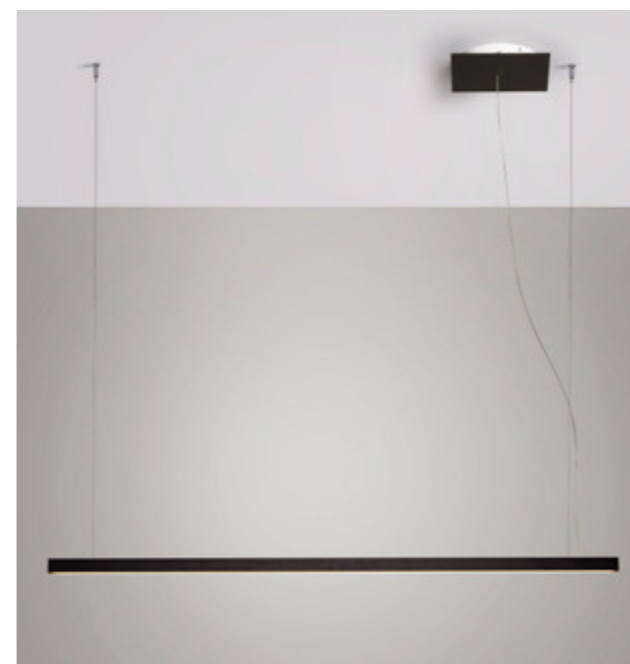

Esempio di installazione con rosone 0993/60.02
 Example of installation with ceiling rose 0993/60.02

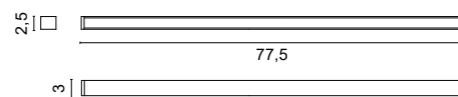
**5613** Riga

.01 Bianco - White

.02 Nero - Black

Color temperature	LED Light source	lm source
/W 4000K	24V 14,4W	1860lm
/WW 3000K	24V 14,4W	1732lm
/XW 2700K	24V 14,4W	1642lm

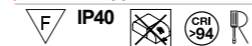

0,20 Kg

Solo collegamento in parallelo - Only parallel connection

CUSTOM SIZE

Tabella lunghezze disponibili. Le misure si riferiscono alle lunghezze totali delle lampade complete di tappi.

Table of available lengths. Measures are referred to complete fixtures including closing heads.

cm	watt	2700K (XW)	lm source	3000K (WW)	lm source	4000K (W)	lm source
** 77,5	14,4W	5613 * /XW	1642	5613 * /WW	1732	5613 * /W	1860
102,5	19,2W	A5613 * /100/XW	2190	A5613 * /100/WW	2310	A5613 * /100/W	2480
127,5	24W	A5613 * /125/XW	2737	A5613 * /125/WW	2890	A5613 * /125/W	3100
152,5	28,8W	A5613 * /150/XW	3285	A5613 * /150/WW	3465	A5613 * /150/W	3720
177,5	33,6W	A5613 * /175/XW	3832	A5613 * /175/WW	4042	A5613 * /175/W	4340
202,5	38,4W	A5613 * /200/XW	4380	A5613 * /200/WW	4620	A5613 * /200/W	4960
227,5	43,2W	A5613 * /225/X W	4927	A5613 * /225/WW	5197	A5613 * /225/W	5580
252,5	48W	A5613 * /250/XW	5474	A5613 * /250/WW	5775	A5613 * /250/W	6200
277,5	52,8W	A5613 * /275/XW	6022	A5613 * /275/WW	6352	A5613 * /275/W	6820
302,5	57,6W	A5613 * /300/XW	6570	A5613 * /300/WW	6930	A5613 * /200/W	7440

* Finiture - Finishes:

.01 Bianco - White

.02 Nero - Black

** Articolo standard a catalogo - Standard catalogue item

Codici finiture - Finishes codes

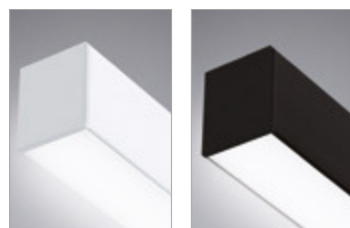

.01

.02

**Drivers****Drivers ON/OFF**

Cod.	0155	0156	0160	0157	0161/100	0161/150
	24V-13W	24V-25W	24V-60W	24V-75W	24V-100W	24V-150W

DIMMABLE drivers

Cod.	0717/DIM60/V	0717/DIM60	0717/DIM100
	24V-60W 1...10V	24V-60W PUSH - DALI	24V-100W 1...10V - PUSH - DALI

DIMMABLE drivers TAGLIO DI FASE - PHASE CUT-OFF

Cod.	0727/DIM30	0727/DIM50	0717/DIM100/T	0717/DIM150/T
	24V-30W TRIAC	24V-50W TRIAC	24V-100W TRIAC	24V-150W TRIAC

LED emergency unit

Cod.	0115/EM
	Inverter + Battery + LED indicator



design **U.T. EgoIuce**
2017

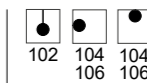

Famiglia di lampade lineari a luce diffusa con struttura in alluminio e diffusore in metacrilato satinato realizzabili in diverse lunghezze. Gli alimentatori per alcune versioni a parete/plafone ed i rosoni con alimentatore per la versione a sospensione sono da ordinare separatamente.

Family of linear lamps providing diffused light with an aluminium structure and satin methacrylate diffuser available in different lengths. Drivers for some wall/ceiling versions and ceiling roses with drivers for the suspension version must be ordered separately.

Famille de lampes linéaires à lumière diffuse avec cadre en aluminium et diffuseur en méthacrylate satiné disponible en différentes longueurs. Les drivers pour certaines versions mur/plafond et les rosaces de plafond avec driver pour la version suspension doivent être commandés séparément.

Familia de lámparas lineales de luz difusa con marco de aluminio y difusor de metacrilato satinado disponibles en diferentes longitudes. Los drivers para algunas versiones de pared/techo y el florón de techo con driver para la versión de suspensión deben pedirse por separado.

Lineare Leuchtenfamilie für diffuses Licht mit Aluminiumrahmen und satiniertem Methacrylatdifusor, erhältlich in verschiedenen Längen. Driver für einige Wand-/Deckenversionen und Deckenrosetten mit Driver für die Hängeversion müssen separat bestellt werden.

EXTRO

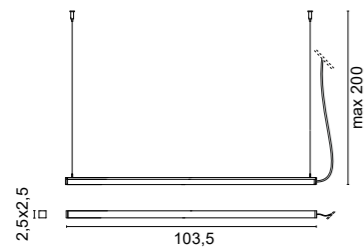

1559 Extra System
.01 Bianco - White

Color temperature	LED Light source	lm source
/W 4000K	24V 15W	1840lm
/WW 3000K	24V 15W	1650lm
/XW 2700K	24V 15W	1560lm



1,10 Kg



Codici finiture - Finishes codes



.01

Rosoni con alimentatori da ordinare separatamente (p. 108) - Ceiling roses with drivers are to be ordered separately (p. 108)

CUSTOM SIZE

Tabella lunghezze disponibili - Table of available lengths

cm	watt	2700K (XW)	lm source	3000K (WW)	lm source	4000K (W)	lm source
* 103	15W	1559.01/XW	1560	1559.01/WW	1650	1559.01/100/W	1840
128	18,5W	A1559.01/125/XW	1955	A1559.01/125/WW	2068	A1559.01/125/W	2306
153	22W	A1559.01/150/XW	2340	A1559.01/150/WW	2475	A1559.01/150/W	2760
178	26,5W	A1559.01/175/XW	2735	A1559.01/175/WW	2893	A1559.01/175/W	3226
203	30W	A1559.01/200/XW	3120	A1559.01/200/WW	3300	A1559.01/200/W	3680
228	33,5W	A1559.01/225/XW	3515	A1559.01/225/WW	3718	A1559.01/225/W	4146
253	37,5W	A1559.01/250/XW	3900	A1559.01/250/WW	4125	A1559.01/250/W	4600
278	41,5W	A1559.01/275/XW	4295	A11559.01/275/WW	4543	A1559.01/275/W	5066
303	45W	A1559.01/300/XW	4680	A1559.01/300/WW	4950	A1559.01/300/W	5220

* Articolo standard a catalogo - Standard catalogue item

Rosoni con alimentatori da ordinare separatamente (p. 108) - Ceiling roses with drivers are to be ordered separately (p. 108)



4601 Extra
.31 Cromato - Chromed

Color temperature	LED Light source	lm source
/W 4000K	9W	1104lm
/WW 3000K	9W	990lm
/XW 2700K	9W	936lm

IP40 0,80 Kg

Dimmerazione TRIAC su richiesta
TRIAC dimming on request

4602 Extra
.31 Cromato - Chromed

Color temperature	LED Light source	lm source
/W 4000K	12,5W	1472lm
/WW 3000K	12,5W	1320lm
/XW 2700K	12,5W	1248lm

IP40 0,90 Kg

Dimmerazione TRIAC su richiesta
TRIAC dimming on request

4603 Extra
.31 Cromato - Chromed

Color temperature	LED Light source	lm source
/W 4000K	18W	2208lm
/WW 3000K	18W	1980lm
/XW 2700K	18W	1872lm

IP40 1,00 Kg

Dimmerazione TRIAC su richiesta
TRIAC dimming on request

4604 Extra
.31 Cromato - Chromed

Color temperature	LED Light source	lm source
/W 4000K	24W	2944lm
/WW 3000K	24W	2640lm
/XW 2700K	24W	2496lm

IP40 1,20 Kg

Dimmerazione TRIAC su richiesta
TRIAC dimming on request

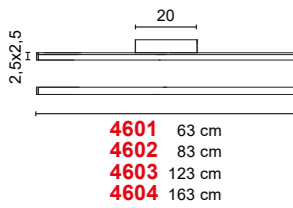

Codici finiture - Finishes codes

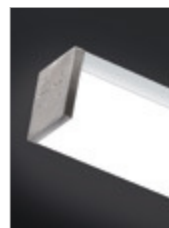

.31



Corpo lampada bianco e terminali in ABS cromato e bianco in dotazione
White lamp body and chrome-plated and white ABS terminals supplied



2,5x2,5

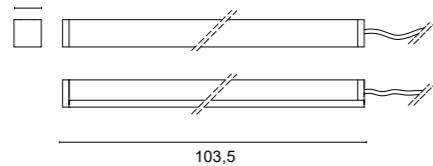

103,5

4521 Extra
.01 Bianco - White

Color temperature	LED Light source	lm source
/W 4000K	24V 15W	1840lm
/WW 3000K	24V 15W	1650lm
/XW 2700K	24V 15W	1560lm



0,15 Kg

Versione ETL disponibile su richiesta
 ETL version available on request

Solo collegamento in parallelo - Only parallel connection



Codici finiture - Finishes codes



.01

CUSTOM SIZE

Tabella lunghezze disponibili - Table of available lengths

cm	watt	2700K (XW)	lm source	3000K (WW)	lm source	4000K (W)	lm source
13,5	1,5W	A4521.01/10/XW	156	A4521.01/10/WW	165	A4521.01/10/W	184
23,5	3W	A4521.01/20/XW	312	A4521.01/20/WW	330	A4521.01/20/W	368
33,5	4,5W	A4521.01/30/XW	468	A4521.01/30/WW	495	A4521.01/30/W	552
43,5	6W	A4521.01/40/XW	624	A4521.01/40/WW	660	A4521.01/40/W	736
53,5	7,5W	A4521.01/50/XW	780	A4521.01/50/WW	825	A4521.01/50/W	920
63,5	9W	A4521.01/60/XW	936	A4521.01/60/WW	990	A4521.01/60/W	1104
73,5	10,5W	A4521.01/70/XW	1092	A4521.01/70/WW	1155	A4521.01/70/W	1288
83,5	12W	A4521.01/80/XW	1248	A4521.01/80/WW	1320	A4521.01/80/W	1472
93,5	13,5W	A4521.01/90/XW	1404	A4521.01/90/WW	1485	A4521.01/90/W	1656
* 103,5	15W	A4521.01/XW	1560	A4521.01/WW	1650	A4521.01/W	1840
113,5	16,5W	A4521.01/110/XW	1716	A4521.01/110/WW	1815	A4521.01/110/W	2024
123,5	18W	A4521.01/120/XW	1872	A4521.01/120/WW	1980	A4521.01/120/W	2208
133,5	19,5W	A4521.01/130/XW	2028	A4521.01/130/WW	2145	A4521.01/130/W	2392
143,5	21W	A4521.01/140/XW	2184	A4521.01/140/WW	2310	A4521.01/140/W	2576
153,5	22,5W	A4521.01/150/XW	2340	A4521.01/150/WW	2475	A4521.01/150/W	2760
163,5	24W	A4521.01/160/XW	2496	A4521.01/160/WW	2640	A4521.01/160/W	2944
173,5	25,5W	A4521.01/170/XW	2652	A4521.01/170/WW	2805	A4521.01/170/W	3128
183,5	27W	A4521.01/180/XW	2808	A4521.01/180/WW	2970	A4521.01/180/W	3312
193,5	28,5W	A4521.01/190/XW	2964	A4521.01/190/WW	3135	A4521.01/190/W	3496
203,5	30W	A4521.01/200/XW	3120	A4521.01/200/WW	3300	A4521.01/200/W	3680
213,5	31,5W	A4521.01/210/XW	3276	A4521.01/210/WW	3465	A4521.01/210/W	3864
223,5	33W	A4521.01/220/XW	3432	A4521.01/220/WW	3630	A4521.01/220/W	4048
233,5	34,5W	A4521.01/230/XW	3588	A4521.01/230/WW	3795	A4521.01/230/W	4232
243,5	36W	A4521.01/240/XW	3744	A4521.01/240/WW	3960	A4521.01/240/W	4416
253,5	37,5W	A4521.01/250/XW	3900	A4521.01/250/WW	4125	A4521.01/250/W	4600
263,5	39W	A4521.01/260/XW	4056	A4521.01/260/WW	4290	A4521.01/260/W	4784
273,5	40,5W	A4521.01/270/XW	4212	A4521.01/270/WW	4455	A4521.01/270/W	4968
283,5	42W	A4521.01/280/XW	4368	A4521.01/280/WW	4620	A4521.01/280/W	5152
293,5	43,5W	A4521.01/290/XW	4524	A4521.01/290/WW	4785	A4521.01/290/W	5336
303,5	45W	A4521.01/300/XW	4680	A4521.01/300/WW	4950	A4521.01/300/W	5520

* Articolo standard a catalogo - Standard catalogue item

Drivers

Drivers ON/OFF

Cod.	0155	0156	0160	0157	0161/100	0161/150
	24V-13W	24V-25W	24V-60W	24V-75W	24V-100W	24V-150W

DIMMABLE drivers

Cod.	0717/DIM60/V	0717/DIM60	0717/DIM100
	24V-60W 1...10V	24V-60W PUSH - DALI	24V-100W 1...10V - PUSH - DALI

DIMMABLE drivers TAGLIO DI FASE - PHASE CUT-OFF

Cod.	0727/DIM30	0727/DIM50	0717/DIM100/T	0717/DIM150/T
	24V-30W TRIAC	24V-50W TRIAC	24V-100W TRIAC	24V-150W TRIAC

LED emergency unit

Cod.	0115/EM
	Inverter + Battery + LED indicator

Rosoni - Ceiling rose



50/60Hz 220-230V - 30W

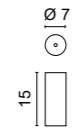

ROSONE COMPLETO DI DRIVER 30W
CEILING ROSE WITH DRIVER 30W

Code	W	Codici finiture - Finishes codes
0990/30	30W	.01 Bianco - White
0990/30	30W	.02 Nero - Black
0990/30	30W	.23 Alluminio satinato - Satin Aluminium



0,50 Kg



50/60Hz 220-230V - 60W

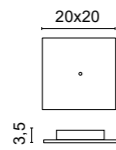

ROSONE COMPLETO DI DRIVER 60W
CEILING ROSE WITH DRIVER 60W

Code	W	Codici finiture - Finishes codes
0993/60	60W	.01 Bianco - White
0993/60	60W	.02 Nero con base bianca - Black with white base



0,60 Kg



50/60Hz 220-230V - 60W

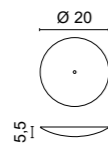

ROSONE COMPLETO DI DRIVER 60W
CEILING ROSE WITH DRIVER 60W

Code	W	Codici finiture - Finishes codes
0990/60	60W	.01 Bianco - White
0990/60	60W	.02 Nero - Black
0990/60	60W	.85 Verniciato argento - Painted silver finishing
0990/60	60W	.86 Verniciato oro - Painted gold finishing
0990/60	60W	.87 Verniciato rame - Painted copper finishing
0990/60	60W	.88 Verniciato bronzo - Painted bronze finishing



0,60 Kg



50/60Hz 220-230V - 100W

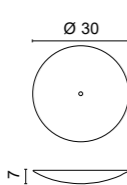

ROSONE COMPLETO DI DRIVER 100W
CEILING ROSE WITH DRIVER 100W

Code	W	Codici finiture - Finishes codes
0990/100	100W	.01 Bianco - White
0990/100	100W	.02 Nero - Black
0990/100	100W	.85 Verniciato argento - Painted silver finishing
0990/100	100W	.86 Verniciato oro - Painted gold finishing
0990/100	100W	.87 Verniciato rame - Painted copper finishing
0990/100	100W	.88 Verniciato bronzo - Painted bronze finishing



1,30 Kg



50/60Hz 220-230V - 150W

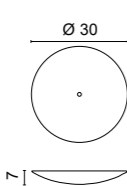

ROSONE COMPLETO DI DRIVER 150W
CEILING ROSE WITH DRIVER 150W

Code	W	Codici finiture - Finishes codes
0990/150	150W	.01 Bianco - White
0990/150	150W	.02 Nero - Black
0990/150	150W	.85 Verniciato argento - Painted silver finishing
0990/150	150W	.86 Verniciato oro - Painted gold finishing
0990/150	150W	.87 Verniciato rame - Painted copper finishing
0990/150	150W	.88 Verniciato bronzo - Painted bronze finishing



1,30 Kg



50/60Hz 220-230V - 200W

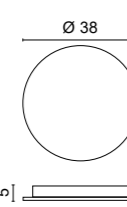

ROSONE COMPLETO DI DRIVER 200W (2x100W)
CEILING ROSE WITH DRIVER 200W (2x100W)

Code	W	Codici finiture - Finishes codes
0990/200	200W	.01 Bianco - White
0990/200	200W	.02 Nero - Black
0990/200	200W	.85 Verniciato argento - Painted silver finishing
0990/200	200W	.86 Verniciato oro - Painted gold finishing
0990/200	200W	.87 Verniciato rame - Painted copper finishing
0990/200	200W	.88 Verniciato bronzo - Painted bronze finishing



2,00 Kg

Esempi di installazione multipla, la scelta del driver è determinata dalla somma delle potenze delle singole lampade
Examples of multiple installation, the choice of the driver depends on total power consumption

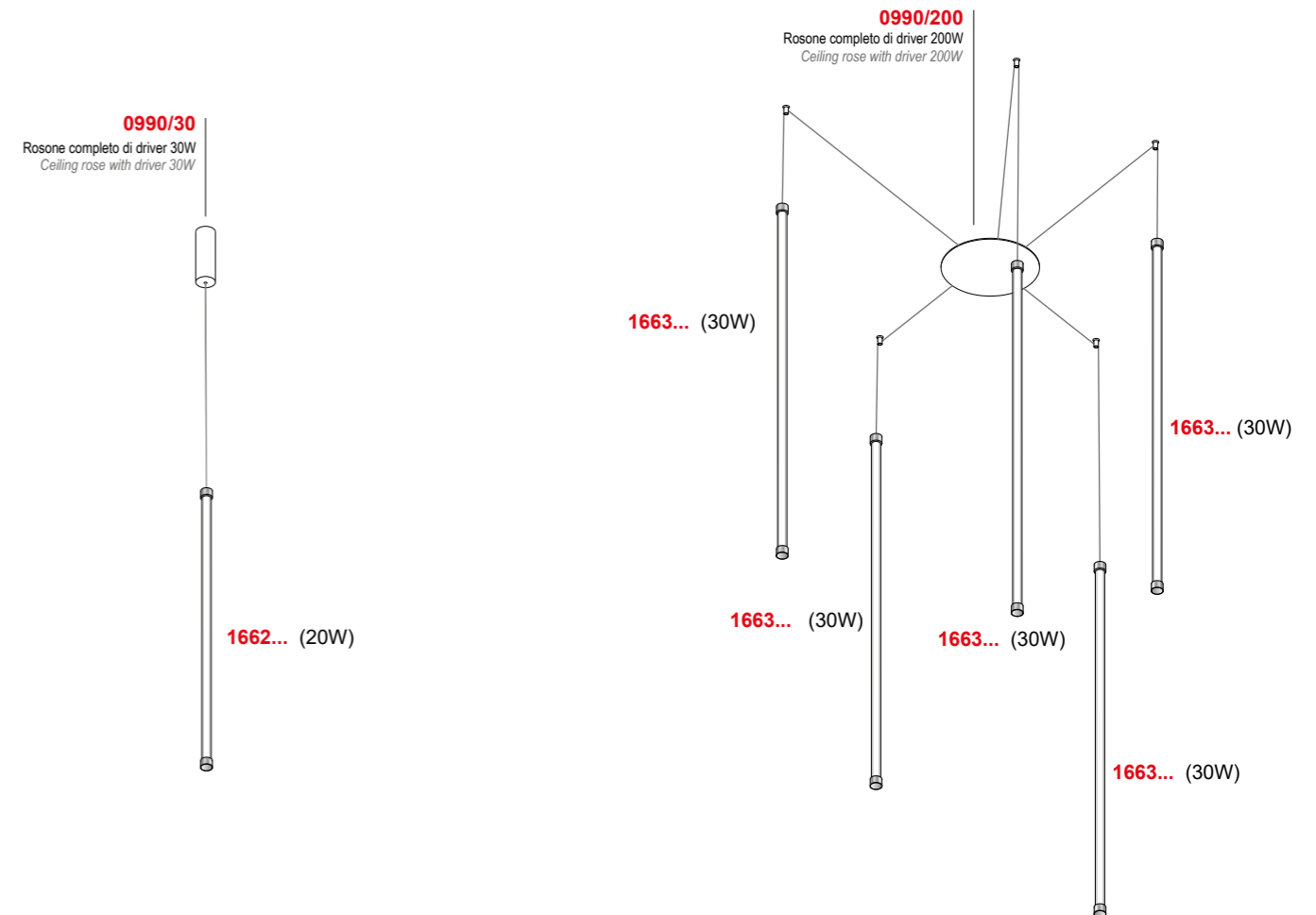
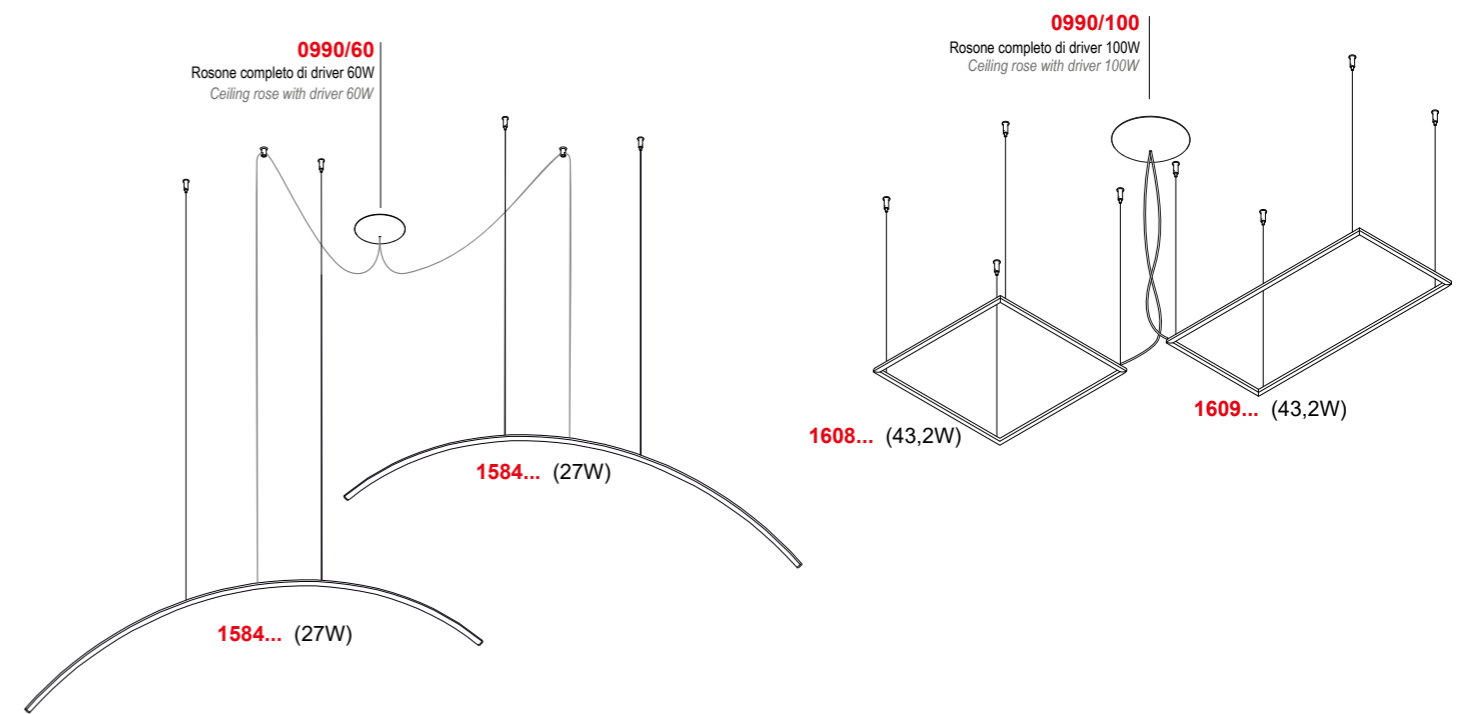

Rosoni - Ceiling rose

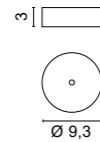

ROSONE SENZA DRIVER
CEILING ROSE WITHOUT

Code	Codici finiture - Finishes codes
0607	.01 Bianco - White
0607	.02 Nero - Black



Rosoni per incassi - Recessed ceiling rose

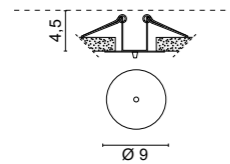

ROSONE SENZA DRIVER PER CARTOGESSO
CEILING ROSE WITHOUT DRIVER FOR PLASTERBOARD

Code	Codici finiture - Finishes codes
0947	.01 Bianco - White
0947	.02 Nero - Black



7,5 cm

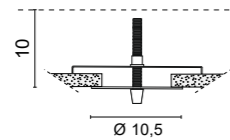

ROSONE SENZA DRIVER PER CARTOGESSO
CEILING ROSE WITHOUT DRIVER FOR PLASTERBOARD

Code	Codici finiture - Finishes codes
0959	.01 Bianco - White
0959	.02 Nero - Black



9,5 cm

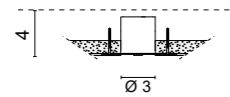
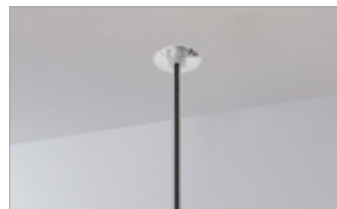

ROSONE A SCOMPARS A EUREKA SENZA DRIVER PER CARTOGESSO
EUREKA CEILING ROSE WITHOUT DRIVER FOR PLASTERBOARD

Code	Codici finiture - Finishes codes
E1001	.01 Bianco - White
E1001	.02 Nero - Black



4,1 cm

Drivers

Drivers ON/OFF

Cod.	0160	0161/100	0161/150	0161/200	0161/320
	24V-60W	24V-100W	24V-150W	24V-200W	24V-320W
	8 cm	8 cm	8 cm	8 cm	8 cm

DIMMABLE drivers

Cod.	0717/DIM60	0717/DIM60/V	0717/DIM100	0717/DIM150	0717/DIM100/T	0717/DIM150/T
	24V-60W	24V-60W	24V-100W	24V-100W	24V-100W	24V-150W
	PUSH - DALI	1...10V	1...10V - PUSH - DALI	1...10V - PUSH - DALI	TRIAC	TRIAC
	8 cm	8 cm	8,2 cm	8,2 cm	8,2 cm	8,2 cm

Esempi di installazione multipla, la scelta del driver è determinata dalla somma delle potenze delle singole lampade
Examples of multiple installation, the choice of the driver depends on total power consumption

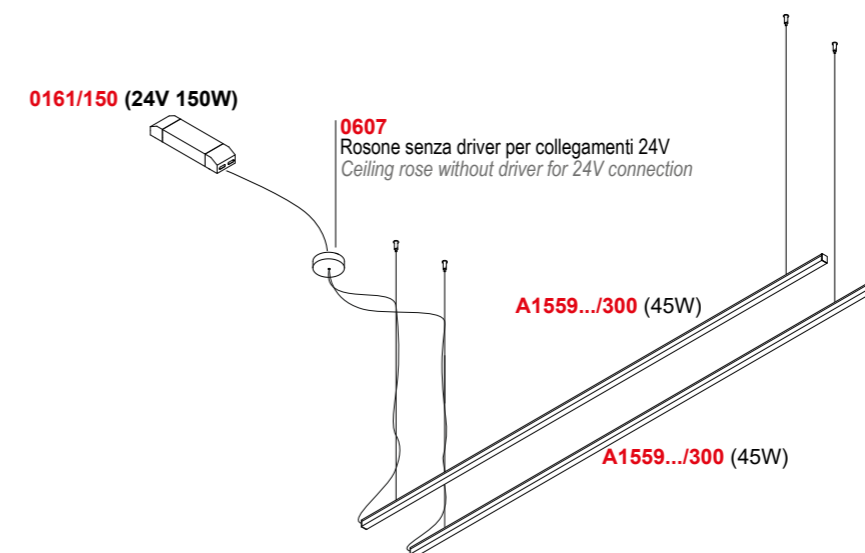
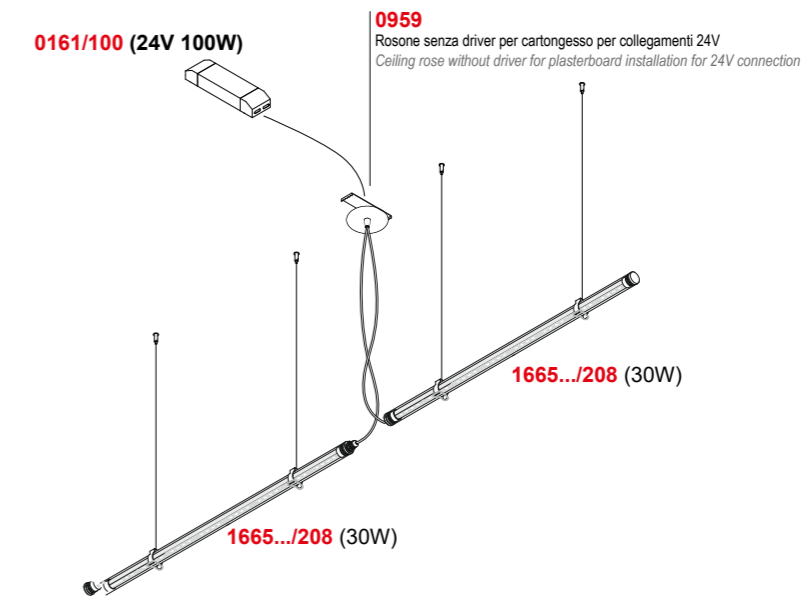
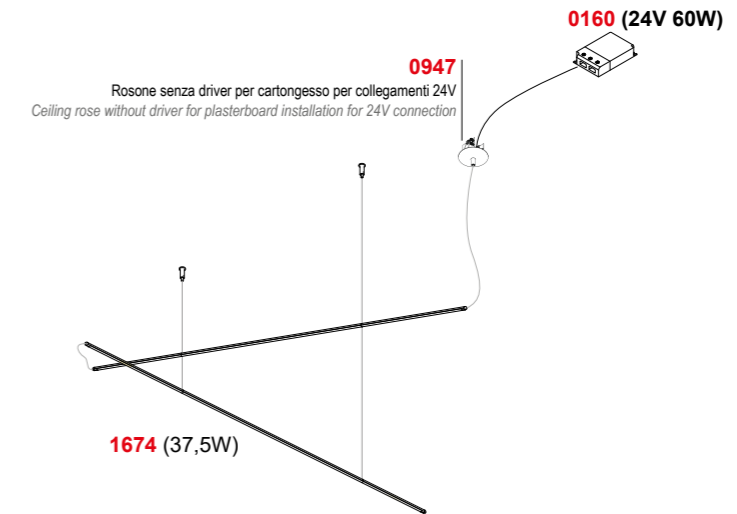



design **LUX Studio**
2023



Lampade da tavolo e da terra dimmerabili con struttura in alluminio caratterizzate da piccoli proiettori orientabili per poter sfruttare al massimo la qualità della luce d'accento. Il posizionamento arretrato della sorgente luminosa garantisce un perfetto confort visivo.

Dimmable table and floor lamps with an aluminium frame characterised by small, adjustable spotlights to maximise the quality of accent lighting. The recessed positioning of the light source ensures perfect visual comfort.

Lampes de table et lampadaires gradables avec une structure en aluminium, caractérisées par de petits spots orientables pour maximiser la qualité de l'éclairage d'accentuation. Le positionnement encastré de la source lumineuse assure un confort visuel parfait.

Lámparas de sobremesa y de pie regulables con marco de aluminio caracterizadas por pequeños focos regulables para maximizar la calidad de la iluminación de acento. La posición empotrada de la fuente de luz garantiza un confort visual perfecto.

Dimmbare Tisch- und Stehleuchten mit Aluminiumrahmen, die sich durch kleine, verstellbare Strahler auszeichnen, die die Qualität der Akzentbeleuchtung maximieren. Die versenkte Positionierung der Lichtquelle sorgt für perfekten Sehkombfort.

FORO

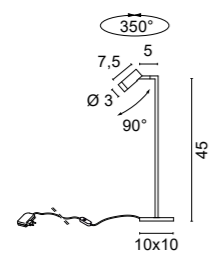

2525 Faro

- .01** Bianco - White
- .02** Nero - Black

Color temperature	LED Light source	lm source
/W 4000K	5,9W	885lm
/WW 3000K	5,9W	836lm
/XW 2700K	5,9W	800lm



0,95 Kg

Completa di DIMMER su cavo nero
With DIMMER on black cable

Differenti ottiche su richiesta
Different optics on request



Accessori - Accessories



0267/S

Frangiluce
Louvres

- .01** Bianco - White
- .02** Nero - Black

Codici finiture - Finishes codes



.01

.02



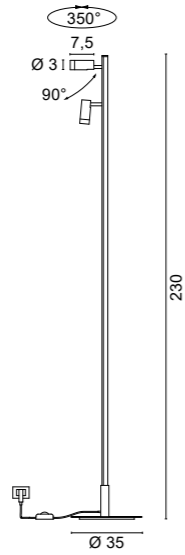

3536 Faro

- .01** Bianco - *White*
- .02** Nero - *Black*
- .02.25** Nero, dorato satrinato - *Black, satin gold*

Color temperature	LED Light source	lm source
/W 4000K	11,8W	1770lm
/WW 3000K	11,8W	1672lm
/XW 2700K	11,8W	1600lm

5,40 Kg

Completa di DIMMER su cavo nero
 With DIMMER on black cable

Differenti ottiche su richiesta
 Different optics on request



Accessori - *Accessories*



0267/S

Frangiluce
Louvres

- .01** Bianco - *White*
- .02** Nero - *Black*

Codici finiture - *Finishes codes*



.01

.02

.02.25



Dettaglio Faro 3536.02.25 - *Detail Faro 3536.02.25*



design **LUX Studio**
2022

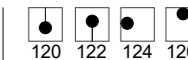

Collezione di lampade a luce diretta con struttura in alluminio e caratterizzate da piccoli proiettori orientabili per poter sfruttare al massimo la qualità della luce d'accento. Iris è disponibile anche con differenti aperture ottiche e con doppio snodo per sottolineare e disegnare con la luce ogni tipo di ambiente.

Collection of direct-light lamps with an aluminium structure and characterised by small adjustable projectors to make the most of accent lighting. Iris is also available with different optical beams and with a double joint to emphasise and design any kind of environment with light.

Collection de lampes à lumière directe avec une structure en aluminium et caractérisées par de petits projecteurs orientables pour optimiser l'éclairage d'accentuation. Iris est également disponible avec différentes ouvertures optiques et avec un double joint pour souligner et concevoir tout type d'environnement avec de la lumière.

Colección de lámparas de luz directa con estructura de aluminio y caracterizadas por pequeños proyectores orientables para aprovechar al máximo la iluminación de acento. Iris también está disponible con diferentes aperturas ópticas y con doble articulación para enfatizar y diseñar con luz cualquier tipo de ambiente.

Kollektion von Direktlichtlampen mit Aluminiumstruktur, die sich durch kleine, verstellbare Projektoren auszeichnen, um die Akzentbeleuchtung zu optimieren. Iris ist auch mit verschiedenen optischen Aperturen und mit einem Doppelgelenk erhältlich, um jede Art von Umgebung mit Licht zu betonen und zu gestalten.

Iris

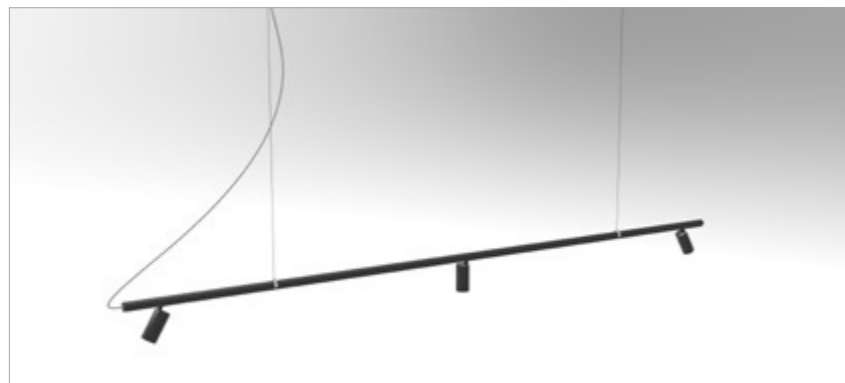
**1678** Iris

- .01** Bianco - White
.02 Nero - Black

Color temperature	LED Light source	lm source
/W 4000K	17,7W	2655lm
/WW 3000K	17,7W	2508lm
/XW 2700K	17,7W	2400lm

**Dimmerabile PUSH - 1...10V - PUSH - 1...10V dimming**

Color temperature	LED Light source	lm source
/W/DIM 4000K	17,7W	2655lm
/WW/DIM 3000K	17,7W	2508lm
/XW/DIM 2700K	17,7W	2400lm

**Dimmerabile DALI - DALI dimming**

Color temperature	LED Light source	lm source
/W/DALI 4000K	17,7W	2655lm
/WW/DALI 3000K	17,7W	2508lm
/XW/DALI 2700K	17,7W	2400lm

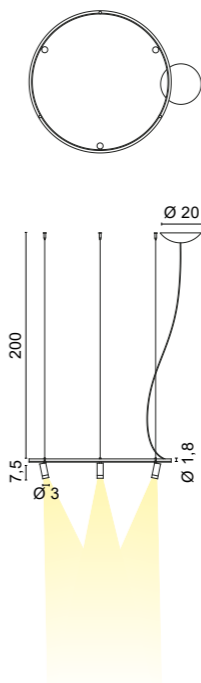
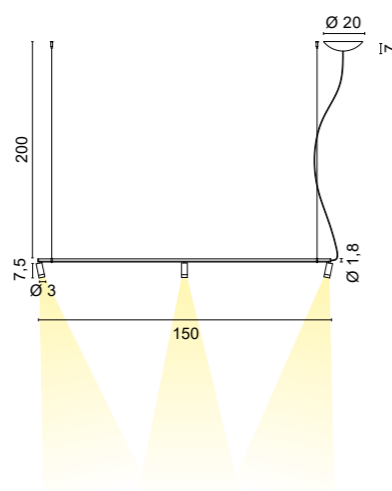

Differenti ottiche su richiesta
Different optics on request

**1679** Iris

- .01** Bianco - White
.02 Nero - Black

Color temperature	LED Light source	lm source
/W 4000K	17,7W	2655lm
/WW 3000K	17,7W	2508lm
/XW 2700K	17,7W	2400lm

**Dimmerabile PUSH - 1...10V - PUSH - 1...10V dimming**

Color temperature	LED Light source	lm source
/W/DIM 4000K	17,7W	2655lm
/WW/DIM 3000K	17,7W	2508lm
/XW/DIM 2700K	17,7W	2400lm

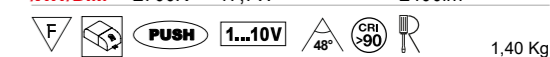
**Dimmerabile DALI - DALI dimming**

Color temperature	LED Light source	lm source
/W/DALI 4000K	17,7W	2655lm
/WW/DALI 3000K	17,7W	2508lm
/XW/DALI 2700K	17,7W	2400lm

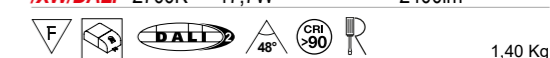

Differenti ottiche su richiesta
Different optics on request

Accessori - Accessories

**0267/S**

Frangiluce
Louvres

- .01** Bianco - White
.02 Nero - Black

Codici finiture - Finishes codes



.01

.02



Accessori - Accessories

**0267/S**

Frangiluce
Louvres

- .01** Bianco - White
.02 Nero - Black

Codici finiture - Finishes codes



.01

.02



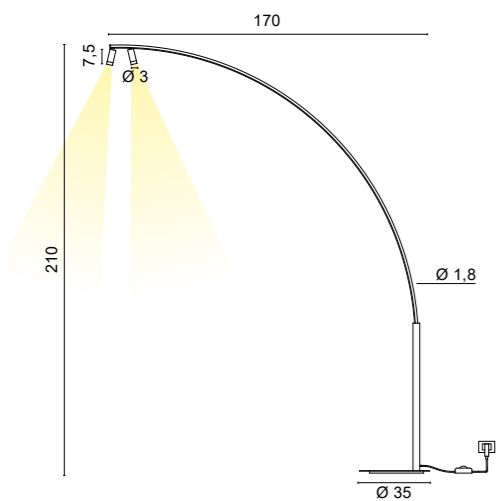

3533 Iris

.01	Bianco - White
.02	Nero - Black
.02.25	Nero, dorato satinato - Black, satin gold

Color temperature	LED Light source	lm source
/W 4000K	11,8W	1770lm
/WW 3000K	11,8W	1672lm
/XW 2700K	11,8W	1600lm

7,00 Kg

Completa di DIMMER su cavo nero
 With DIMMER on black cable

Differenti ottiche su richiesta
 Different optics on request



Dettaglio Iris 3533.02.25 - Detail Iris 3533.02.25

Accessori - Accessories



0267/S
Frangiluce
Louvres

.01	Bianco - White
.02	Nero - Black

Codici finiture - Finishes codes



.01 **.02** **.02.25**



**4650** Iris

- .01** Bianco - White
.02 Nero - Black

Color temperature	Optics	LED Light source	lm source
/W 4000K	/25 /48 /63	5,9W	885lm
/W 4000K	/ST Satinato - Satin	5,9W	885lm
/WW 3000K	/25 /48 /63	5,9W	836lm
/WW 3000K	/ST Satinato - Satin	5,9W	836lm
/XW 2700K	/25 /48 /63	5,9W	800lm
/XW 2700K	/ST Satinato - Satin	5,9W	800lm

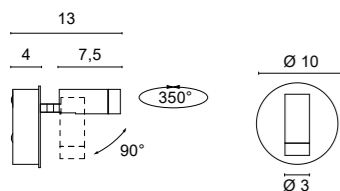

0,30 Kg

**4651** Iris

- .01** Bianco - White
.02 Nero - Black

Color temperature	Optics	LED Light source	lm source
/W 4000K	/25 /48 /63	5,9W	885lm
/W 4000K	/ST Satinato - Satin	5,9W	885lm
/WW 3000K	/25 /48 /63	5,9W	836lm
/WW 3000K	/ST Satinato - Satin	5,9W	836lm
/XW 2700K	/25 /48 /63	5,9W	800lm
/XW 2700K	/ST Satinato - Satin	5,9W	800lm

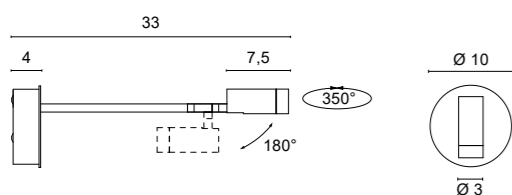

0,35 Kg

**4652** Iris

- .01** Bianco - White
.02 Nero - Black

Color temperature	Optics	LED Light source	lm source
/W 4000K	/25 /48 /63	5,9W	885lm
/W 4000K	/ST Satinato - Satin	5,9W	885lm
/WW 3000K	/25 /48 /63	5,9W	836lm
/WW 3000K	/ST Satinato - Satin	5,9W	836lm
/XW 2700K	/25 /48 /63	5,9W	800lm
/XW 2700K	/ST Satinato - Satin	5,9W	800lm



0,40 Kg

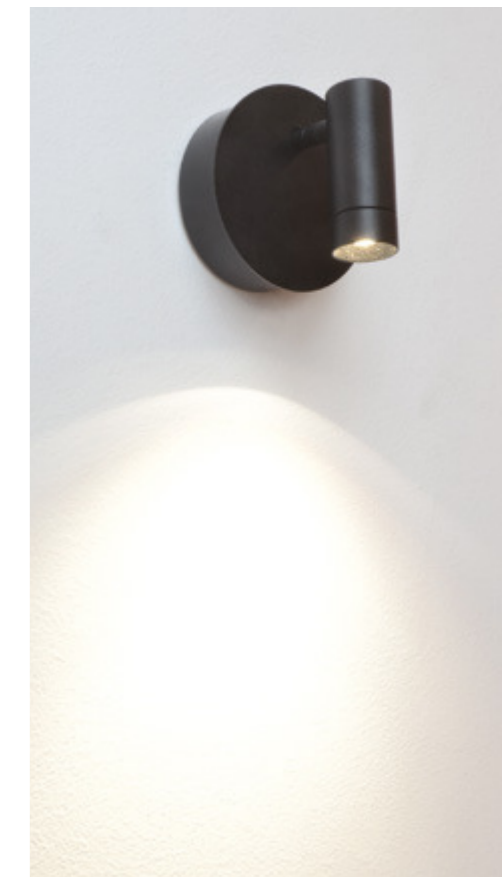
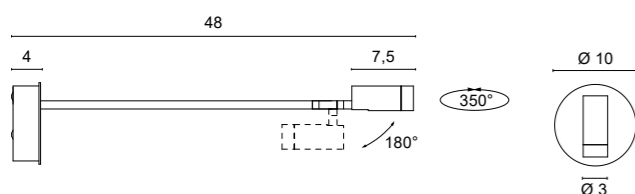

I modelli con la basetta hanno il driver integrato e possono essere installati sia a parete che a plafone. Iris 4651 e 4652 sono costruiti con doppio snodo che consente di indirizzare la luce anche sulla superficie di installazione.

The models with the base have an integrated driver and can be installed either on the wall or on the ceiling. Iris 4651 and 4652 are constructed with a double joint that also allows light to be directed onto the installation surface.

Accessori - Accessories

**0267/S**Frangiluce
Louvres

- .01** Bianco - White
.02 Nero - Black

Codici finiture - Finishes codes

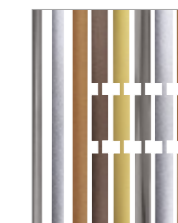
**.01****.02**

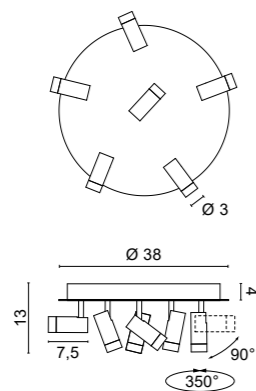
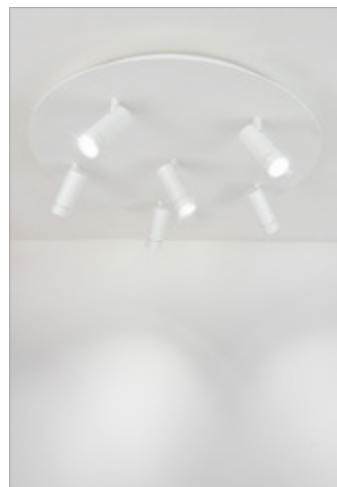
**5680** Iris

.01	Bianco - White
.02	Nero - Black

Color temperature	Optics	LED Light source	lm source
/W 4000K	/25 /48 /63	35,4W	5310lm
/W 4000K	/ST Satinato - Satin	35,4W	5310lm
/WW 3000K	/25 /48 /63	35,4W	5016lm
/WW 3000K	/ST Satinato - Satin	35,4W	5016lm
/XW 2700K	/25 /48 /63	35,4W	4800lm
/XW 2700K	/ST Satinato - Satin	35,4W	4800lm



2,80 Kg

Dimmerazione PUSH - 1...10V - DALI - TRIAC su richiesta
 PUSH - 1...10V - DALI - TRIAC dimming on request

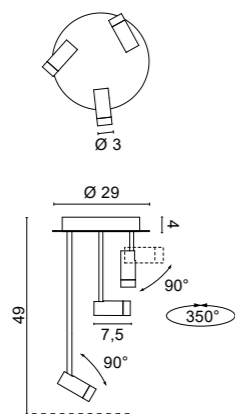
**5681** Iris

.01	Bianco - White
.02	Nero - Black

Color temperature	Optics	LED Light source	lm source
/W 4000K	/25 /48 /63	17,7W	2655lm
/W 4000K	/ST Satinato - Satin	17,7W	2655lm
/WW 3000K	/25 /48 /63	17,7W	2508lm
/WW 3000K	/ST Satinato - Satin	17,7W	2508lm
/XW 2700K	/25 /48 /63	17,7W	2400lm
/XW 2700K	/ST Satinato - Satin	17,7W	2400lm



1,70 Kg

Dimmerazione PUSH - 1...10V - DALI - TRIAC su richiesta
 PUSH - 1...10V - DALI - TRIAC dimming on request

Iris a plafone è realizzata nelle versioni
 con 3 o 6 proiettori

Iris ceiling lamp are made in two versions
 with 3 or 6 projectors



Accessori - Accessories

**0267/S**Frangiluce
Louvres

.01	Bianco - White
.02	Nero - Black

Codici finiture - Finishes codes

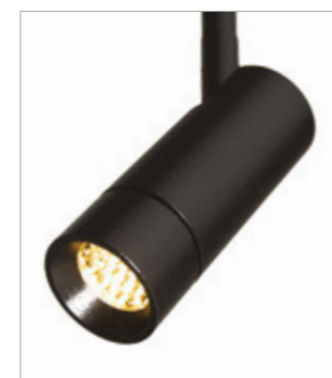
**.01****.02**

Esempio di installazione
 con frangiluce 0267/S

Example of installation
 with louvre 0267/S



design **Mati**
2023

130 132

Lampade da parete e da tavolo orientabili a luce diretta con struttura in alluminio e metallo. Nonostante le ridotte dimensioni l'interruttore e l'alimentatore sono integrati nel corpo del prodotto. La calamita posta all'interno del corpo del proiettore permette un facile orientamento della luce in tutte le direzioni.

Direct-light adjustable wall and table lamps with aluminium and metal construction. Despite its small dimensions, the switch and driver are integrated in the body of the product. The magnet inside the body allows easy orientation of the light in all directions.

Appliques et lampes de table réglables à lumière directe, fabriquées en aluminium et en métal. Malgré ses dimensions réduites, l'interrupteur et le driver sont intégrés dans le corps. L'aimant situé à l'intérieur du corps permet d'orienter facilement la lampe dans toutes les directions.

Apliques de pared y sobremesa regulables de luz directa con estructura de aluminio y metal. A pesar de sus reducidas dimensiones, el interruptor y el driver están integrados en el cuerpo. El imán del interior del cuerpo permite orientar fácilmente la luz en todas las direcciones.

Direktlichtverstellbare Wand- und Tischleuchten aus Aluminium und Metall. Trotz der geringen Abmessungen sind der Schalter und die Stromversorgung in das Gehäuse integriert. Der Magnet im Inneren des Gehäuses ermöglicht eine einfache Ausrichtung der Leuchte in alle Richtungen.

lebedio

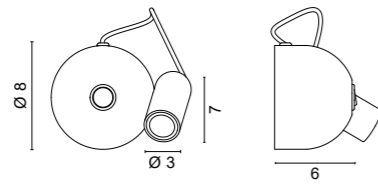
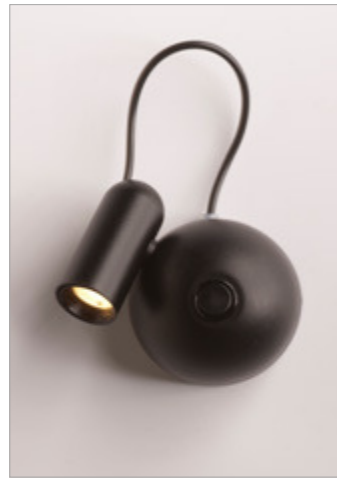

4670 Leggo

- .01** Bianco - White
- .02** Nero - Black

Color temperature	LED Light source	lm source
/W 4000K	2,4W	400lm
/WW 3000K	2,4W	380lm
/XW 2700K	2,4W	365lm





0,35 Kg

Completa di pulsante ON-OFF
Complete with ON-OFF button

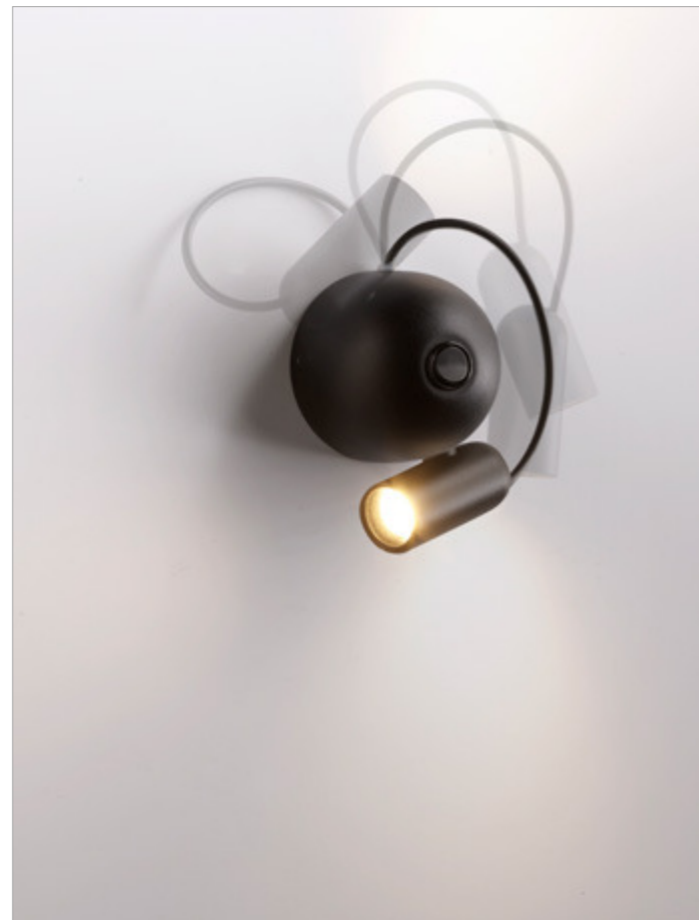

Il fissaggio magnetico dello spot permette di orientare la luce in ogni direzione
The magnetic fixing of the spot allows you to direct the light in any direction

Codici finiture - Finishes codes



.01

.02



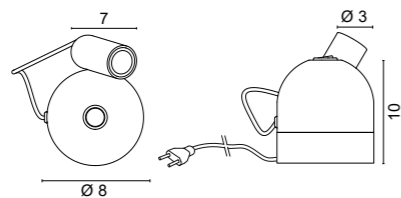

2539 Leggo

- .01** Bianco - White
- .02** Nero - Black

Color temperature	LED Light source	lm source
/W 4000K	2,4W	400lm
/WW 3000K	2,4W	380lm
/XW 2700K	2,4W	365lm

F 0,50 Kg

Completa di pulsante ON-OFF
Complete with ON-OFF button



Il fissaggio magnetico dello spot permette di orientare la luce in ogni direzione
The magnetic fixing of the spot allows you to direct the light in any direction

Codici finiture - Finishes codes



.01

.02



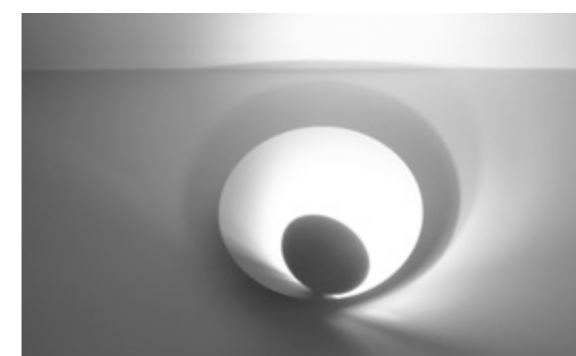
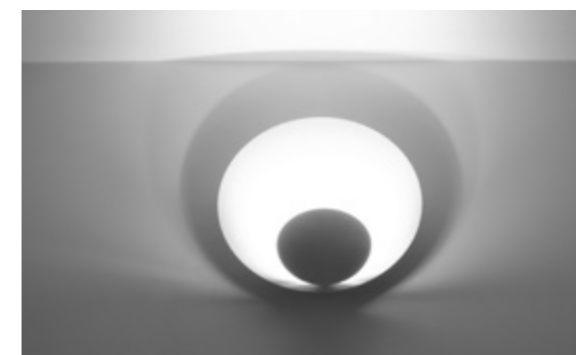
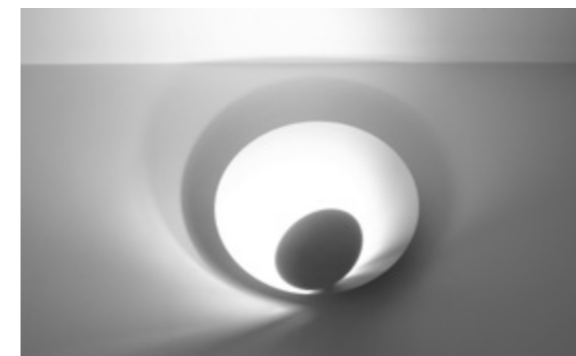
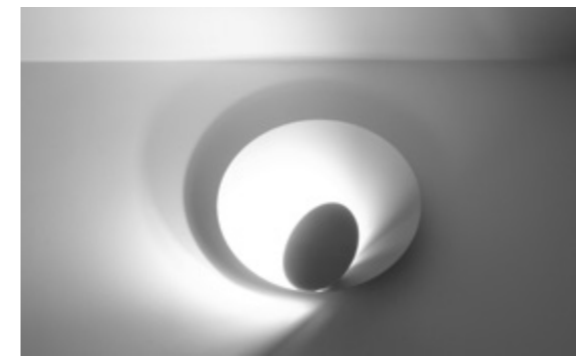
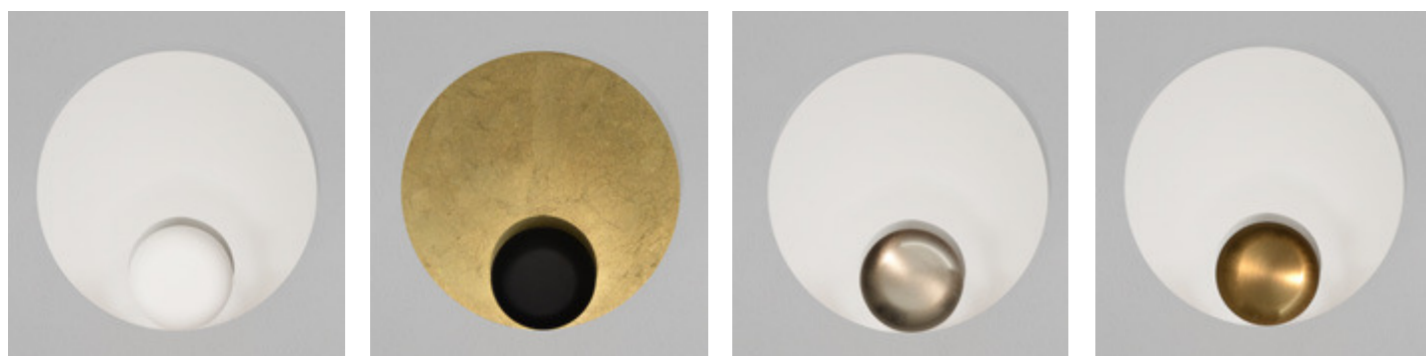

design Lux Studio
2021

136 138

Lampade da parete e da plafone a luce indiretta con struttura in alluminio e metallo con alimentatore integrato. Le finiture proposte per Aurora da parete sono il bianco e la foglia oro per gli schermi riflettenti, il bianco, il nero, l'oro e il nichel satinato per la parte orientabile. Aurora da plafone è disponibile in bianco.

Indirect light wall and ceiling lamps with an aluminium and metal structure and integrated driver. The finishes offered for Aurora wall-mounted are white and gold leaf for the reflective screens, white, black, gold and satin nickel for the adjustable part. Aurora ceiling light is available in white.

Appliques et plafonniers à éclairage indirect avec structure en aluminium et métal et driver intégré. Les finitions proposées pour l'applique Aurora sont le blanc et la feuille d'or pour les écrans réfléchissants, le blanc, le noir, l'or et le nickel satiné pour la partie orientable. Le plafonnier Aurora est disponible en blanc.

Appliques y plafones de luz indirecta con estructura de aluminio y metal y driver integrado. Los acabados ofrecidos para Aurora de pared son blanco y pan de oro para las pantallas reflectantes, blanco, negro, oro y níquel satinado para la parte orientable. La lámpara de techo Aurora está disponible en blanco.

Indirekt leuchtende Wand- und Deckenleuchten mit einer Struktur aus Aluminium und Metall und integriertem Driver. Die für Aurora Wandleuchten angebotenen Oberflächen sind Weiß und Blattgold für die reflektierenden Schirme, Weiß, Schwarz, Gold und Nickel satiniert für den verstellbaren Teil. Die Deckenleuchte Aurora ist in Weiß erhältlich.

AURORA

4627 Aurora

- .01** Bianco - *White*
- .02.29** Nero, foglia oro - *Black, gold leaf*
- .25.01** Dorato satinato, bianco - *Satin gold, white*
- .32.01** Nickel satinato, bianco - *Nickel mat, white*

Color temperature	LED Light source	lm source
/W 4000K	12,6W	2255lm
/WW 3000K	12,6W	2104lm
/XW 2700K	12,6W	1955lm





1,50 Kg

4628 Aurora

- .01** Bianco - *White*
- .02.29** Nero, foglia oro - *Black, gold leaf*
- .25.01** Dorato satinato, bianco - *Satin gold, white*
- .32.01** Nickel satinato, bianco - *Nickel mat, white*

Dimmerabile PUSH - 1...10V - PUSH - 1...10V dimming

Color temperature	LED Light source	lm source
/W 4000K	12,6W	2255lm
/WW 3000K	12,6W	2104lm
/XW 2700K	12,6W	1955lm







1,50 Kg

4629 Aurora

- .01** Bianco - *White*
- .02.29** Nero, foglia oro - *Black, gold leaf*
- .25.01** Dorato satinato, bianco - *Satin gold, white*
- .32.01** Nickel satinato, bianco - *Nickel mat, white*

Dimmerabile DALI - DALI dimming

Color temperature	LED Light source	lm source
/W 4000K	12,6W	2255lm
/WW 3000K	12,6W	2104lm
/XW 2700K	12,6W	1955lm





1,50 Kg

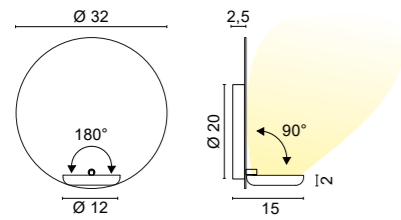

Codici finiture - *Finishes codes*





5675 Aurora

.01 Bianco - White

Color temperature	LED Light source	lm source
/W 4000K	12,6W	2255lm
/WW 3000K	12,6W	2104lm
/XW 2700K	12,6W	1955lm



1,50 Kg



5676 Aurora

.01 Bianco - White

Dimmerabile PUSH - 1...10V - PUSH - 1...10V dimming

Color temperature	LED Light source	lm source
/W 4000K	12,6W	2255lm
/WW 3000K	12,6W	2104lm
/XW 2700K	12,6W	1955lm



1,50 Kg

5677 Aurora

.01 Bianco - White

Dimmerabile DALI - DALI dimming

Color temperature	LED Light source	lm source
/W 4000K	12,6W	2255lm
/WW 3000K	12,6W	2104lm
/XW 2700K	12,6W	1955lm



1,50 Kg

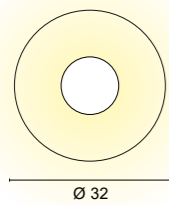
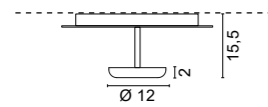

Codici finiture - Finishes codes



.01

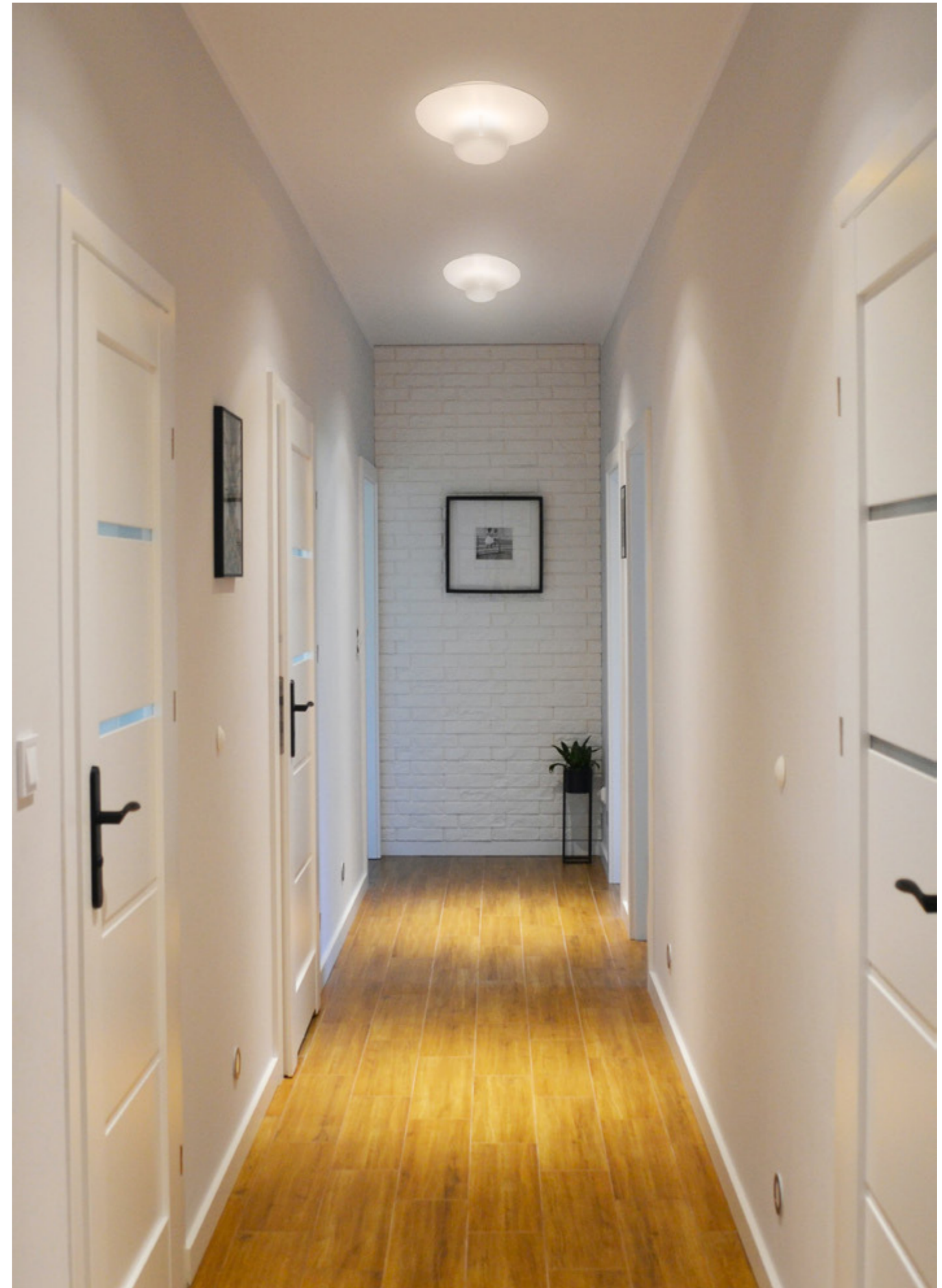



design **S. Cornelissen**
2015

142

Lampada a sospensione a luce indiretta con diffusore in alluminio tornito in lastra, stelo in metallo, disco di chiusura della base/dissipatore in metacrilato e cavo di alimentazione di 250 centimetri nero. Il rosone con alimentatore è da ordinare separatamente in funzione alla tipologia della composizione scelta.

Indirect light pendant lamp with turned sheet aluminium diffuser, metal stem, methacrylate base/shutter disc and 250 cm black power cable. The ceiling rose with driver must be ordered separately depending on the type of composition chosen.

Lampe suspendue à éclairage indirect avec diffuseur en tôle d'aluminium tournée, tige en métal, base/disque d'obturation en méthacrylate et câble d'alimentation noir de 250 cm. La rosace avec driver doit être commandée séparément en fonction du type de composition choisi.

Lámpara colgante de luz indirecta con difusor de chapa de aluminio torneada, vástago metálico, base de metacrilato/disco obturador y cable de alimentación negro de 250 cm. El florón de techo con driver debe pedirse por separado en función del tipo de composición elegida.

Indirekte Hängeleuchte mit Diffusor aus gedrehtem Aluminiumblech, Metallstiel, Sockel/Scheibe aus Methacrylat und 250 cm langem schwarzem Stromkabel. Die Rosette mit Driver muss separat bestellt werden, je nach Art der Zusammensetzung gewählt.

Spirits

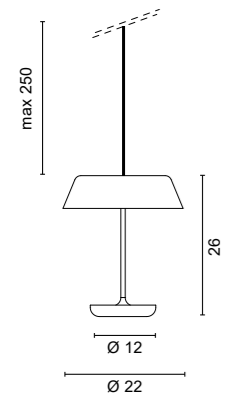

1535 Spirits

- .01** Bianco - White
- .01.30** Bianco / foglia argento - Out white / in silver leaf
- .02.29** Nero / foglia oro - Out black / in gold leaf

Color temperature	LED Light source	lm source
/W 4000K	51V 250mA 12,6W	2255lm
/WW 3000K	51V 250mA 12,6W	2104lm
/XW 2700K	51V 250mA 12,6W	1955lm



1,00 Kg

Solo collegamento in serie - Only serial connection



Codici finiture - Finishes codes



.01 **.01.30** **.02.29**

Rosoni - Ceiling rose

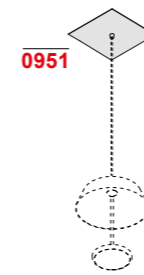

0951

IN: 50/60Hz 220-230V

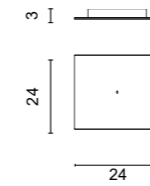

ROSONE COMPLETO DI DRIVER 1 SPIRITS
CEILING ROSE WITH DRIVER 1 SPIRITS

Code	Codici finiture - Finishes codes
0951	.01 Bianco - White
0951	.02 Nero - Black



DIMMERAZIONE
DIMMING



1,00 Kg

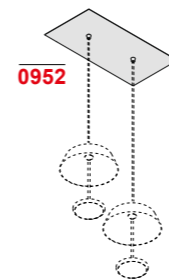

0952

IN: 50/60Hz 220-230V

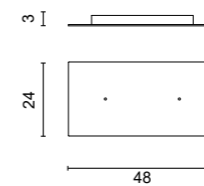

ROSONE COMPLETO DI DRIVER 2 SPIRITS
CEILING ROSE WITH DRIVER 2 SPIRITS

Code	Codici finiture - Finishes codes
0952	.01 Bianco - White
0952	.02 Nero - Black



DIMMERAZIONE
DIMMING



2,00 Kg

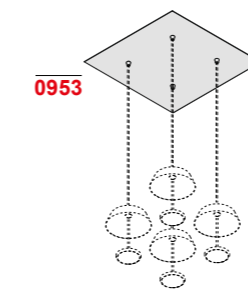

0953

IN: 50/60Hz 220-230V

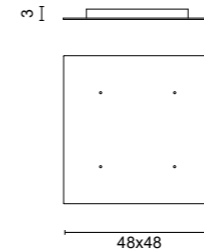

ROSONE COMPLETO DI DRIVER 4 SPIRITS
CEILING ROSE WITH DRIVER 4 SPIRITS

Code	Codici finiture - Finishes codes
0953	.01 Bianco - White
0953	.02 Nero - Black



DIMMERAZIONE
DIMMING

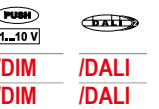

3,80 Kg

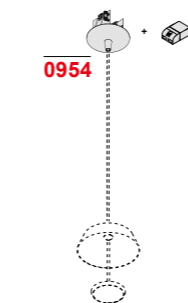

0954

IN: 50/60Hz 220-230V

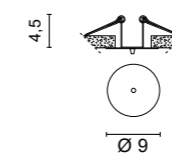

PIASTRA PER CARTONGESSO CON ALIMENTATORE 1 SPIRITS
PLASTERBOARD CEILING ROSE WITH DRIVER 1 SPIRITS

Code	Codici finiture - Finishes codes
0954	.01 Bianco - White
0954	.02 Nero - Black



DIMMERAZIONE
DIMMING



0,20 Kg

Il driver fornito passa dal foro di incasso della piastra per cartongesso 0954
The supplied driver passes through the recessed hole of the plasterboard ceiling rose 0954

Accessori - Accessories

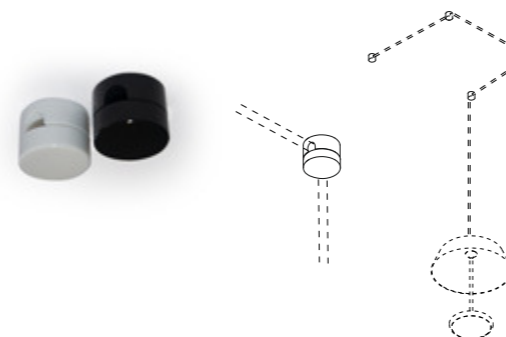

0605

Ø 1,7 cm
H 2,2 cm

1 Deviatore e decentratore
1 Displacement element

.01	Bianco - White
.02	Nero - Black



Spirits 1535.01 + 1535.01.30 + 0952.01



design **S. Cornelissen**
2018

148 148

Lampada da parete e plafone a luce diffusa con corpo in alluminio, disco frontale nero e alimentatore integrato. Il riflettore dal taglio asimmetrico caratterizza la lampada facendola apparire diversa da ogni angolazione. Flower può essere installata in composizione di più elementi partendo da un unico punto luce.

Wall and ceiling lamp providing diffused light with aluminium body, black front disc and integrated driver. The asymmetrically cut reflector characterises the lamp, making it appear different from every angle. Flower can be installed as a composition of several elements from a single light point.

Applique et plafonnier à lumière diffuse avec un corps en aluminium et driver intégré. Le réflecteur asymétrique caractérise la lampe, la faisant apparaître différente sous tous les angles. Flower peut être installé comme une composition de plusieurs éléments à partir d'un seul point lumineux.

Aplicue y plafón de luz difusa con cuerpo de aluminio y driver integrado. El reflector de corte asimétrico caracteriza la lámpara, haciéndola parecer diferente desde cualquier ángulo. Flower puede instalarse como una composición de varios elementos a partir de un único punto de luz.

Wand- und Deckenleuchte mit Aluminiumgehäuse und integriertem Driver für diffuses Licht. Der asymmetrisch geschliffene Reflektor charakterisiert die Leuchte und lässt sie aus jedem Blickwinkel anders erscheinen. Flower kann als Komposition aus mehreren Elementen von einem einzigen Lichtpunkt aus installiert werden.

FLOWER

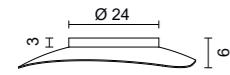
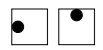

4584 Flower

- .01** Bianco - *White*
- .29** Foglia oro - *Gold leaf*
- .30** Foglia argento - *Silver leaf*

Light sources

LED 12,9W 3000K 1650lm

F IP40 R 1,60 Kg

Dimmerabile su richiesta
Dimmable on request

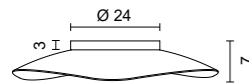
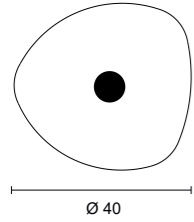

4585 Flower

- .01** Bianco - *White*
- .29** Foglia oro - *Gold leaf*
- .30** Foglia argento - *Silver leaf*

Light sources

LED 12,9W 3000K 1650lm

F IP40 R 2,10 Kg

Dimmerabile su richiesta
Dimmable on request

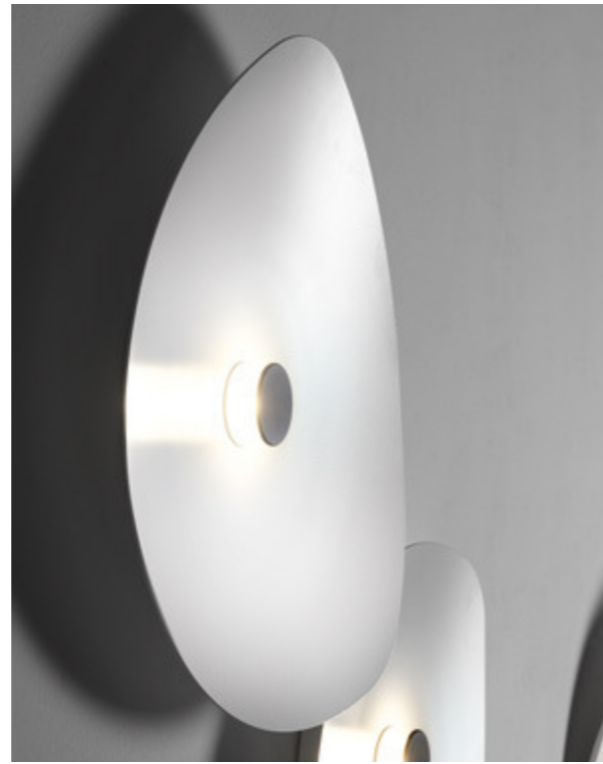
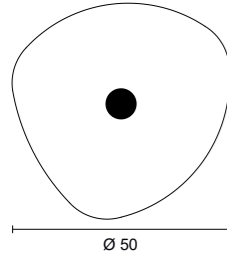

Codici finiture - *Finishes codes*

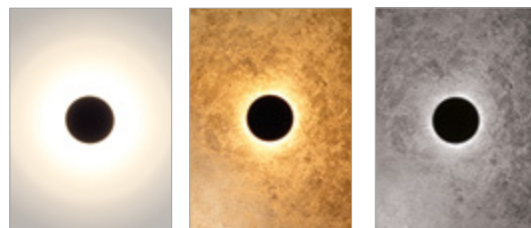

.01 **.29** **.30**





design **ABS Studio**
2016

152 152

Lampada da parete e plafone a luce radiale con frontale in MDF, struttura in alluminio e alimentatore integrato. Il disco in MDF bianco grezzo deve essere verniciato, decorato o rivestito. Moonlight può essere installata in composizione di più elementi partendo da un unico punto luce. Disponibile anche con specchio e dimmerazione.

Wall and ceiling lamp providing radial light with MDF front, aluminium structure and integrated driver. The raw white MDF disc must be painted, decorated or coated. Moonlight can be installed as a composition of several elements from a single light point. Also available with mirror and dimming.

Applique et plafonnier à lumière radiale avec façade en MDF, cadre en aluminium et driver intégré. Le disque MDF blanc brut doit être peint, décoré ou enduit. Moonlight peut être installé comme une composition de plusieurs éléments à partir d'un seul point lumineux. Également disponible avec miroir et variateur de lumière.

Aplique y plafón de luz radial con frente de MDF, marco de aluminio y driver integrado. El disco de MDF blanco en bruto debe pintarse, decorarse o revestirse. Moonlight puede instalarse como composición de varios elementos a partir de un único punto de luz. También disponible con espejo y regulación.

Wand- und Deckenleuchte mit Radiallicht mit MDF-Front, Aluminiumrahmen und integriertem Driver. Die rohe weiße MDF-Scheibe muss gestrichen, dekoriert oder beschichtet werden. Moonlight kann als Komposition aus mehreren Elementen von einem einzigen Lichtpunkt aus installiert werden. Auch mit Spiegel und Dimmer erhältlich.

moonlight

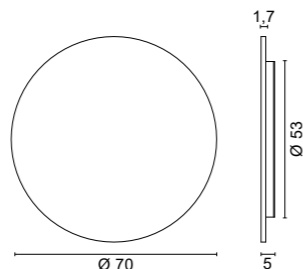
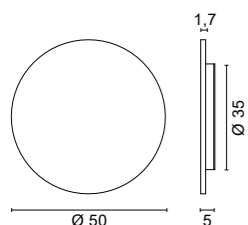

4582 Moonlight

.01	Bianco grezzo - Raw White
.14	Lavagna - Blackboard
.29	Foglia oro - Gold leaf
.30	Foglia argento - Silver leaf
.56	Specchio - Mirror

On-Off

Color temperature	LED Light source	lm source
/W 4000K	15W	1840lm
/WW 3000K	15W	1650lm
/XW 2700K	15W	1560lm

IP40 CRI >90 2,75 Kg

Dimmerabile 1...10V - 1...10V dimming

Color temperature	LED Light source	lm source
/W/DIM 4000K	15W	1840lm
/WW/DIM 3000K	15W	1650lm
/XW/DIM 2700K	15W	1560lm

IP40 1...10V CRI >90 2,75 Kg

Dimmerabile PUSH, DALI - PUSH, DALI dimming

Color temperature	LED Light source	lm source
/W/DALI 4000K	15W	1840lm
/WW/DALI 3000K	15W	1650lm
/XW/DALI 2700K	15W	1560lm

IP40 PUSH DALI CRI >90 2,75 Kg

Codici finiture - Finishes codes

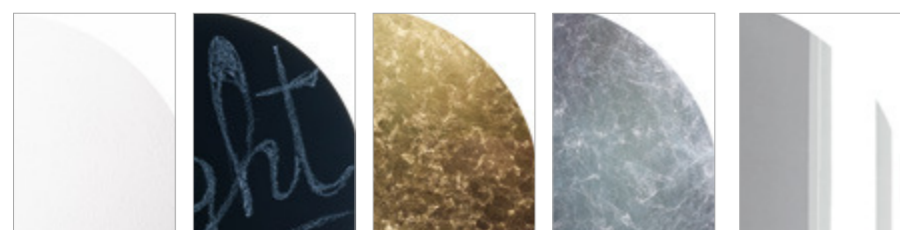

.01 .14 .29 .30 .56

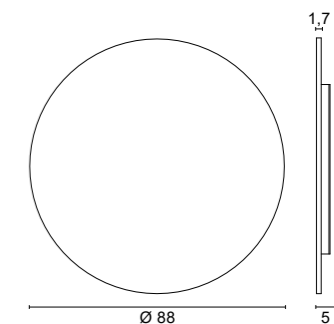

4620 Moonlight

.01	Bianco grezzo - Raw White
.14	Lavagna - Blackboard
.29	Foglia oro - Gold leaf
.30	Foglia argento - Silver leaf

On-Off

Color temperature	LED Light source	lm source
/W 4000K	33W	4150lm
/WW 3000K	33W	3700lm
/XW 2700K	33W	3640lm

IP40 CRI >90 5,85 Kg

Dimmerabile 1...10V - 1...10V dimming

Color temperature	LED Light source	lm source
/W/DIM 4000K	33W	4150lm
/WW/DIM 3000K	33W	3700lm
/XW/DIM 2700K	33W	3640lm

IP40 1...10V CRI >90 5,85 Kg

Dimmerabile PUSH, DALI - PUSH, DALI dimming

Color temperature	LED Light source	lm source
/W/DALI 4000K	33W	4150lm
/WW/DALI 3000K	33W	3700lm
/XW/DALI 2700K	33W	3640lm

IP40 PUSH DALI CRI >90 5,85 Kg

Moonlight 4620 è possibile utilizzarla in installazioni multiple purché sia posizionata come lampada di partenza sulla parete
Moonlight 4620 can be used in multiple installations as long as it is positioned as a starting lamp on the wall

Codici finiture - Finishes codes



.01 .14 .29 .30



Arch. Laura Verdi, DEMO HOTEL
Ph. Fabio Bascetta



Accessori - Accessories

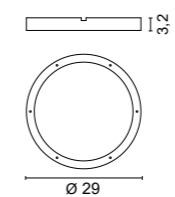

0963

Distanziale per installazioni multiple solo per Moonlight 4582 e 4583
Kit for overlapping only for Moonlight 4582 and 4583

.01 Bianco - White

0,30 Kg

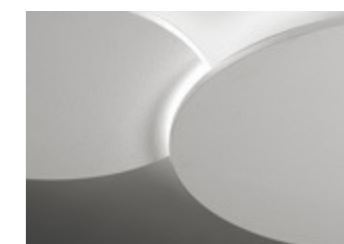

Moonlight 4620 è possibile utilizzarla in installazioni multiple purché sia posizionata come lampada di partenza sulla parete
Moonlight 4620 can be used in multiple installations as long as it is positioned as a starting lamp on the wall he magnetic

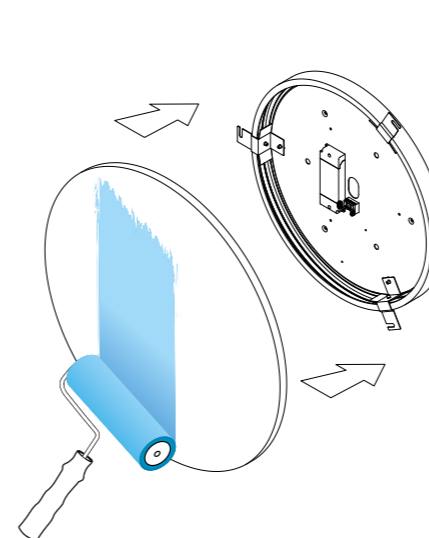
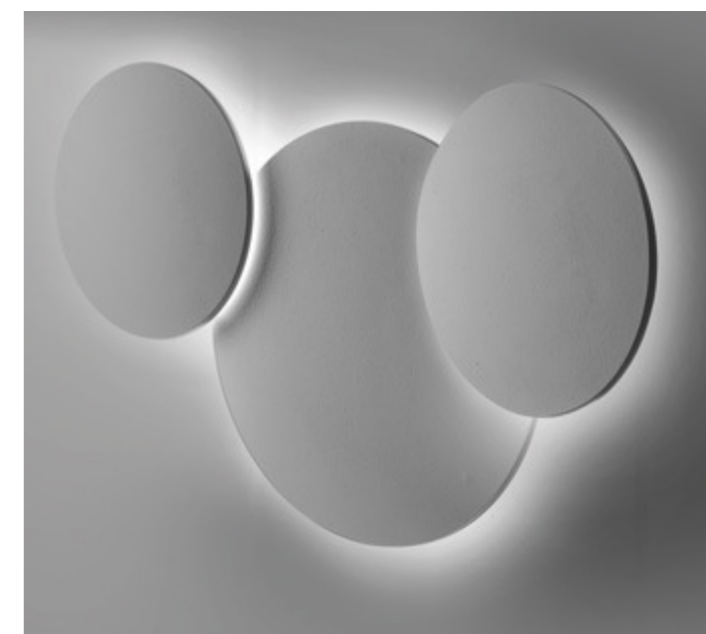
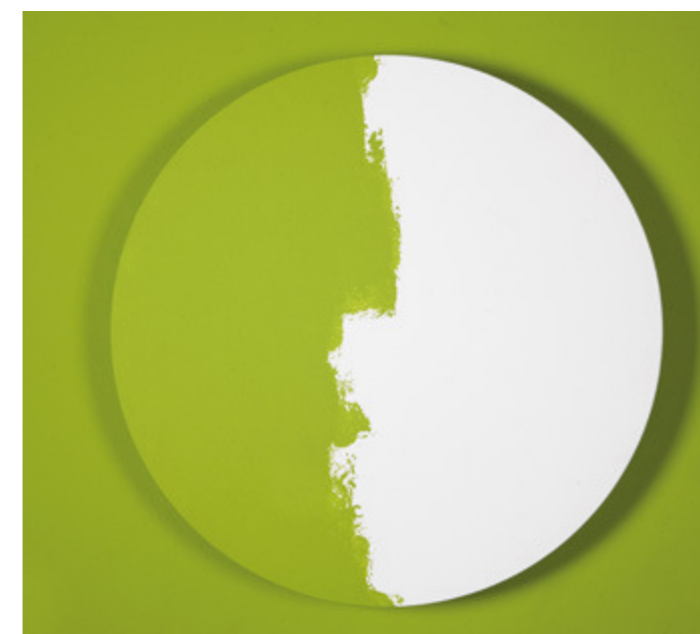

Esempio di installazione singola
Example of single installation

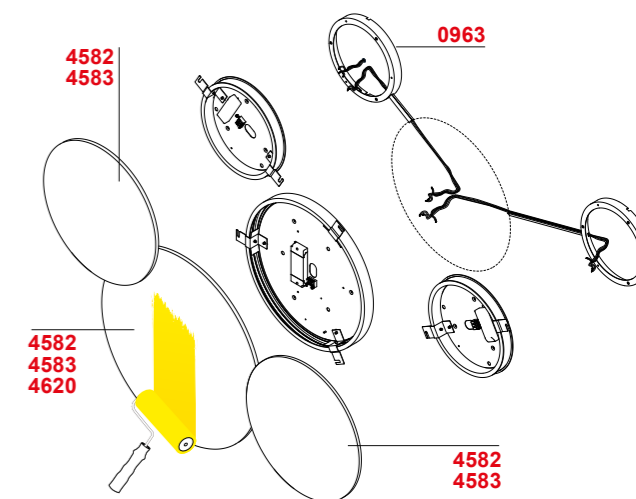

Esempio di installazione multipla con distanziali 0963
Example of multiple installation with spacers 0963



Arch. Laura Verdi, DEMO HOTEL
Ph. Flavio Ricci



Arch. Laura Verdi, DEMO HOTEL
Ph. Fabio Baschetta

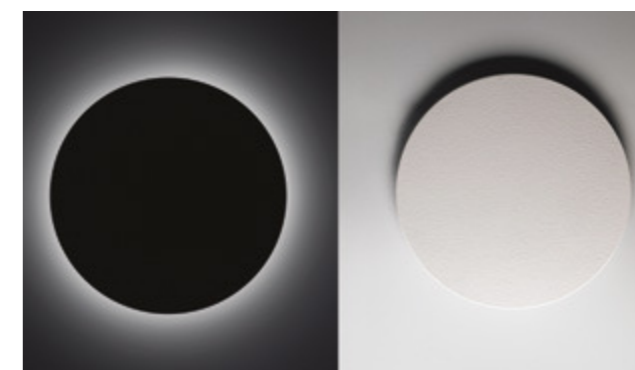



design **ABS Studio**
2016

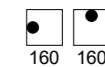

160 160

Lampada da parete e plafone a luce radiale con frontale in MDF, struttura in alluminio e alimentatore integrato. Il frontale in MDF bianco grezzo deve essere verniciato, decorato o rivestito. Q-light può essere installata in composizione di più elementi partendo da un unico punto luce. Disponibile anche con specchio e dimmerazione.

Wall and ceiling lamp providing radial light with MDF front, aluminium structure and integrated driver. The raw white MDF front must be painted, decorated or coated. Q-Light can be installed as a composition of several elements from a single light point. Also available with mirror and dimming.

Applique et plafonnier à lumière radiale avec façade en MDF, cadre en aluminium et driver intégré. La façade en MDF blanc brut doit être peinte, décorée ou revêtue. Q-Light peut être installé comme une composition de plusieurs éléments à partir d'un seul point lumineux. Également disponible avec miroir et variateur de lumière.

Aplique y plafón de luz radial con frente de MDF, marco de aluminio y driver integrado. El frontal de MDF blanco en bruto debe pintarse, decorarse o revestirse. Q-Light puede instalarse como composición de varios elementos a partir de un único punto de luz. También disponible con espejo y regulación.

Wand- und Deckenleuchte mit Radiallicht mit MDF-Front, Aluminiumrahmen und integriertem Driver. Die rohe weiße MDF-Front muss gestrichen, dekoriert oder beschichtet werden. Q-Light kann als Komposition aus mehreren Elementen von einem einzigen Lichtpunkt aus installiert werden. Auch mit Spiegel und Dimmer erhältlich.

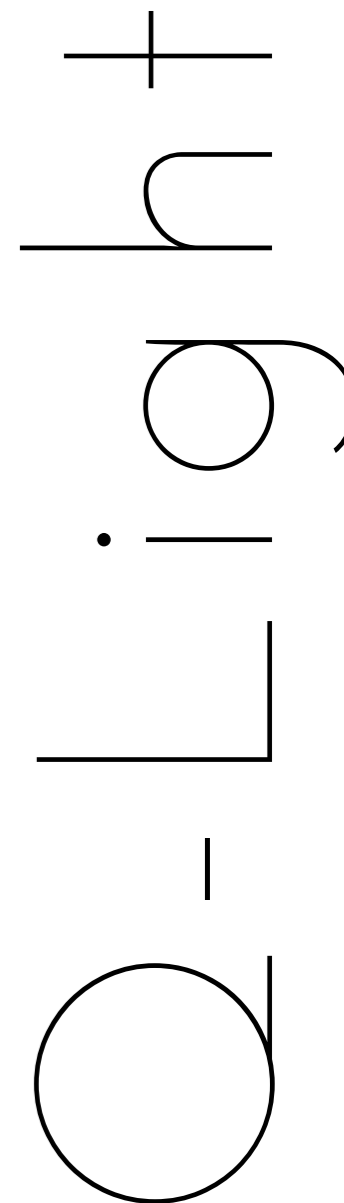

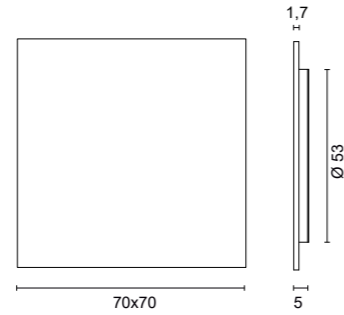
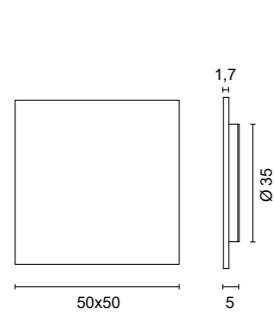

4590 Q-Light

.01	Bianco grezzo - Raw White
.14	Lavagna - Blackboard
.29	Foglia oro - Gold leaf
.30	Foglia argento - Silver leaf
.56	Specchio - Mirror

4,90 Kg

On-Off

Color temperature	LED Light source	lm source
/W 4000K	15W	1840lm
/WW 3000K	15W	1650lm
/XW 2700K	15W	1560lm

IP40 CRI >90

3,30 Kg

Dimmerabile 1...10V - 1...10V dimming

Color temperature	LED Light source	lm source
/W/DIM 4000K	15W	1840lm
/WW/DIM 3000K	15W	1650lm
/XW/DIM 2700K	15W	1560lm

IP40 1...10V CRI >90

3,30 Kg

Dimmerabile PUSH, DALI - PUSH, DALI dimming

Color temperature	LED Light source	lm source
/W/DALI 4000K	15W	1840lm
/WW/DALI 3000K	15W	1650lm
/XW/DALI 2700K	15W	1560lm

IP40 PUSH DALI CRI >90

3,30 Kg

4591 Q-Light

.01	Bianco grezzo - Raw White
.14	Lavagna - Blackboard
.29	Foglia oro - Gold leaf
.30	Foglia argento - Silver leaf

On-Off

Color temperature	LED Light source	lm source
/W 4000K	24W	2944lm
/WW 3000K	24W	2640lm
/XW 2700K	24W	2496lm

IP40 CRI >90

6,00 Kg

Dimmerabile 1...10V - 1...10V dimming

Color temperature	LED Light source	lm source
/W/DIM 4000K	24W	2944lm
/WW/DIM 3000K	24W	2640lm
/XW/DIM 2700K	24W	2496lm

IP40 1...10V CRI >90

6,00 Kg

Dimmerabile PUSH, DALI - PUSH, DALI dimming

Color temperature	LED Light source	lm source
/W/DALI 4000K	24W	2944lm
/WW/DALI 3000K	24W	2640lm
/XW/DALI 2700K	24W	2496lm

IP40 PUSH DALI CRI >90

6,00 Kg

Codici finiture - Finishes codes

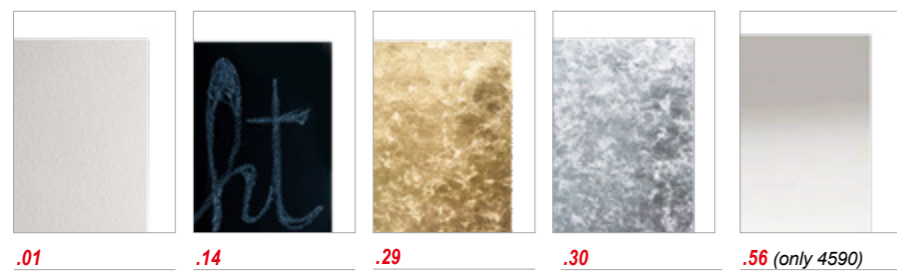

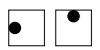

Accessori - Accessories

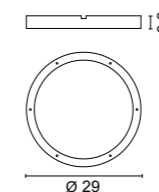

0963

Distanziale per installazioni multiple
Kit for overlapping

.01 Bianco - White

0,30 Kg

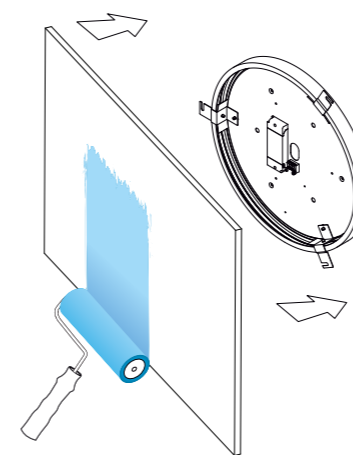

Esempio di installazione singola
Example of single installation

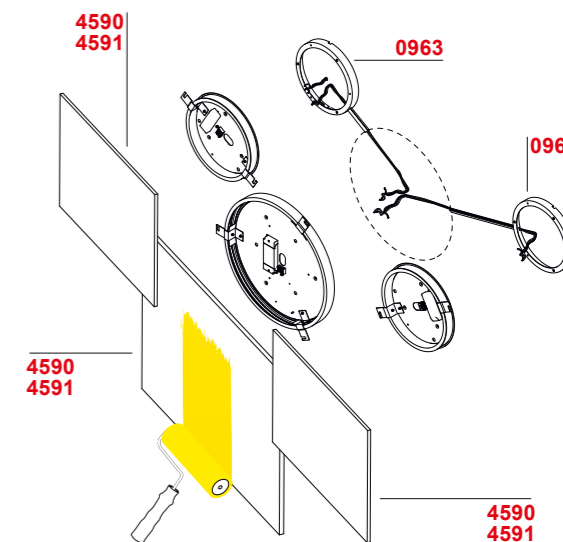

Esempio di installazione multipla con distanziali 0963
Example of multiple installation with spacers 0963



design **ABS Studio**
2020

Lampada da terra a luce indiretta con struttura in alluminio e diffusore in metacrilato satinato. Il design minimalista, risultato di un'estrema ricerca geometrica, ben si adatta a qualsiasi ambiente. Disponibile anche in versione dimmerabile.

Indirect light floor lamp with aluminium structure and satin methacrylate diffuser. The minimalist design, the result of extreme geometric research, is well suited to any environment. Also available in a dimmable version.

Lampadaire à lumière indirecte avec structure en aluminium et diffuseur en méthacrylate satiné. Le design minimaliste, fruit d'une recherche géométrique extrême, s'adapte à tous les environnements. Disponible également dans une version à variateur d'intensité.

Lámpara de pie de luz indirecta con estructura de aluminio y difusor de metacrilato satinado. Su diseño minimalista, fruto de una investigación geométrica extrema, se adapta a cualquier ambiente. Disponible también en versión regulable.

Stehleuchte mit indirektem Licht, Struktur aus Aluminium und Diffusor aus satiniertem Methacrylat. Das minimalistische Design, das Ergebnis extremer geometrischer Forschung, passt zu jeder Umgebung. Auch in einer dimmbaren Version erhältlich.

Silhouettes



3520 Silhouette

- .01** Bianco - *White*
- .02** Nero - *Black*

Color temperature	LED Light source	lm source
W 4000K	25,3W	4080lm
MW 3000K	25,3W	3880lm
XW 2700K	25,3W	3720lm

8,50 Kg

Accensione ON-OFF
ON-OFF switch

3521 Silhouette DIM

- .01** Bianco - *White*
- .02** Nero - *Black*

Color temperature	LED Light source	lm source
W 4000K	25,3W	4080lm
MW 3000K	25,3W	3880lm
XW 2700K	25,3W	3720lm

8,50 Kg

Completa di PUSH DIMMER su cavo
With PUSH DIMMER on cable

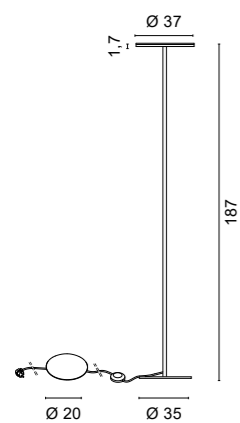

Codici finiture - *Finishes codes*

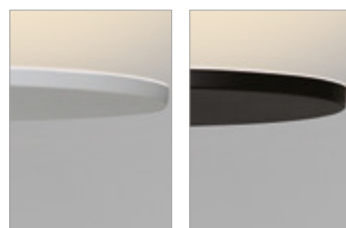

.01

.02



design **Mati**
2017

170 172 174

Collezione di lampade a luce indiretta con struttura in alluminio e diffusore in metacrilato satinato. Il design minimalista, risultato di un'estrema ricerca geometrica, ben si adatta a qualsiasi ambiente. Disponibile anche in versione dimmerabile. Nella versione a sospensione il rosone con alimentatore è da ordinare separatamente.

Collection of indirect light lamps with aluminium structure and satin methacrylate diffuser. The minimalist design, the result of extreme geometric research, is well suited to any environment. Also available in a dimmable version. In the suspension version the ceiling rose with driver must be ordered separately.

Collection de lampes à lumière indirecte avec structure en aluminium et diffuseur en méthacrylate satiné. Le design minimaliste, résultat d'une recherche géométrique extrême, s'adapte à tous les environnements. Disponible également en version dimmable. Dans la version suspension, la rosace avec le driver doit être commandée séparément.

Colección de lámparas de luz indirecta con estructura de aluminio y difusor de metacrilato satinado. Su diseño minimalista, fruto de una investigación geométrica extrema, se adapta a cualquier ambiente. Disponible también en versión regulable. En la versión de suspensión, el florón a techo con driver debe pedirse por separado.

Kollektion von Lampen für indirektes Licht mit Aluminiumstruktur und satiniertem Methacrylatdiffusor. Das minimalistische Design, das Ergebnis extremer geometrischer Forschung, ist für jede Umgebung geeignet. Auch in einer dimmbaren Version erhältlich. Für die Version mit Aufhängung muss die Rosette mit Driver separat bestellt werden.

BURBORN

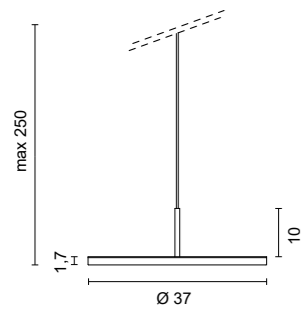

1554 Bureau

- .01** Bianco - White
- .02** Nero - Black

Color temperature	LED Light source	lm source
/W 4000K	25,3W	4080lm
/WW 3000K	25,3W	3880lm
/XW 2700K	25,3W	3620lm



1,20 Kg



Esempio d'installazione con piastra per cartongesso 0959 - Example of installation with plate for plasterboard false ceilings 0959

Codici finiture - Finishes codes

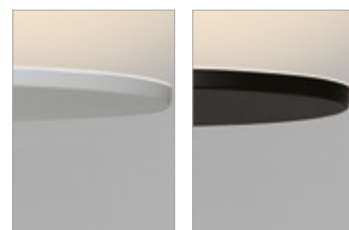

.01

.02



Rosoni - Ceiling rose

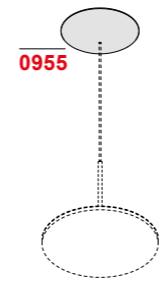

IN: 50/60Hz 220-230V

ROSONE COMPLETO DI DRIVER 1 BUREAU
CEILING ROSE WITH DRIVER 1 BUREAU

Code Codici finiture - Finishes codes

- 0955** **.01** Bianco - White
- 0955** **.02** Nero - Black



DIMMERAZIONE
DIMMING



0,60 Kg

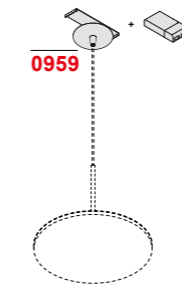

IN: 50/60Hz 220-230V

PIASTRA PER CARTONGESSO CON ALIMENTATORE 1 BUREAU
PLASTERBOARD CEILING ROSE WITH DRIVER 1 BUREAU

Code Codici finiture - Finishes codes

- 0959** **.01** Bianco - White
- 0959** **.02** Nero - Black



9,5 cm

DIMMERAZIONE
DIMMING



0,30 Kg

Il driver fornito passa dal foro incasso della piastra per cartongesso 0959

The supplied driver passes through the recessed hole of the plasterboard ceiling rose 0959





3508 Bureau

- .01** Bianco - *White*
- .02** Nero - *Black*
- .05** Rosso - *Red*

Color temperature	LED Light source	lm source
/W 4000K	25,3W	4080lm
/WW 3000K	25,3W	3880lm
/XW 2700K	25,3W	3720lm



Accensione ON-OFF
ON-OFF switch

3509 Bureau DIM

- .01** Bianco - *White*
- .02** Nero - *Black*
- .05** Rosso - *Red*

Color temperature	LED Light source	lm source
/W 4000K	25,3W	4080lm
/WW 3000K	25,3W	3880lm
/XW 2700K	25,3W	3720lm



Completa di PUSH DIMMER su cavo
With PUSH DIMMER on cable

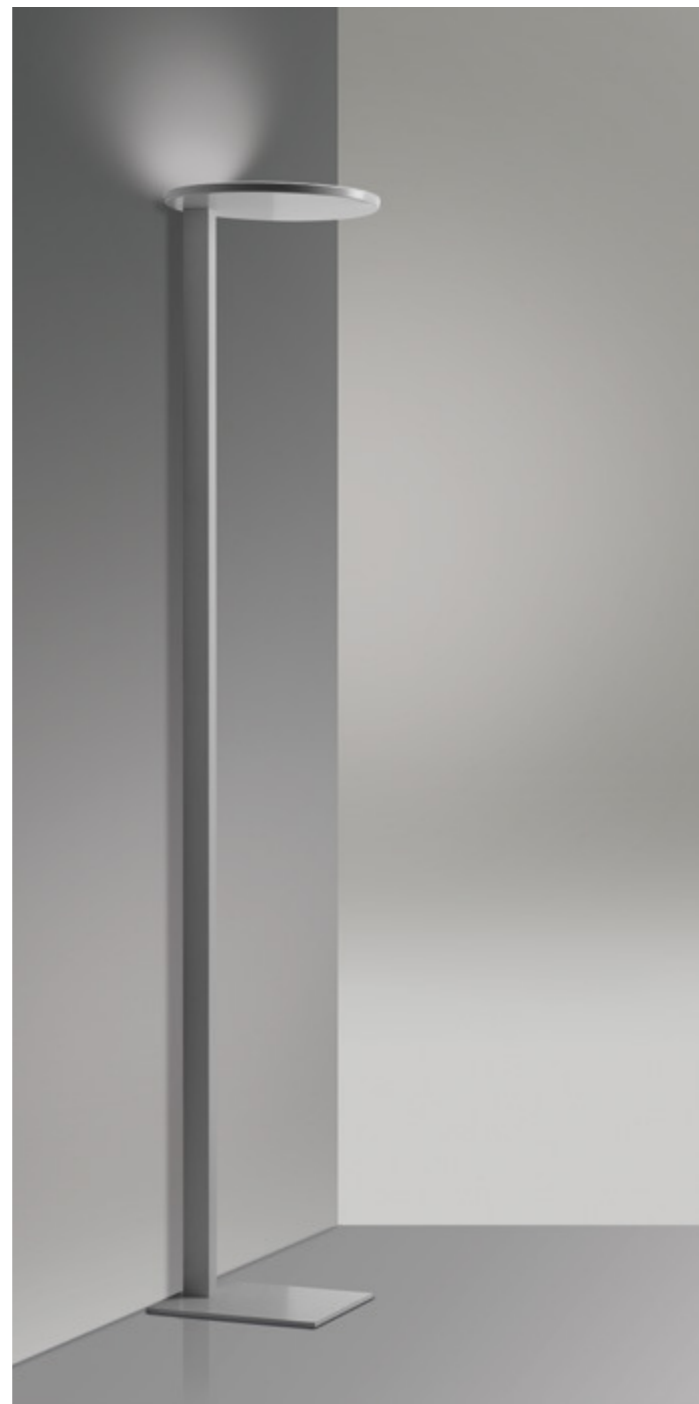
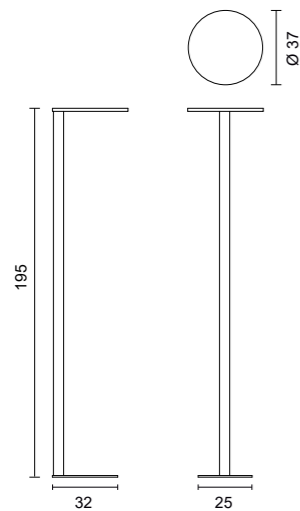

Codici finiture - *Finishes codes*

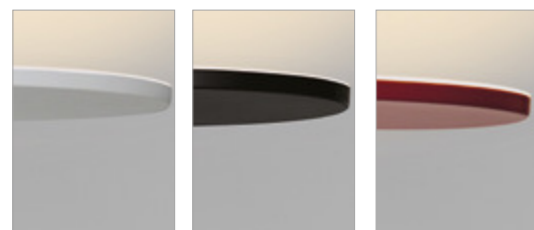

- .01**
- .02**
- .05**



4587 Bureau

- .01** Bianco - White
- .02** Nero - Black
- .05** Rosso - Red

Color temperature	LED Light source	lm source
/W 4000K	25,3W	4080lm
/WW 3000K	25,3W	3880lm
/XW 2700K	25,3W	3720lm

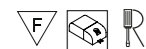

1,70 Kg

4588 Bureau DIM 1...10V

- .01** Bianco - White
- .02** Nero - Black
- .05** Rosso - Red

Dimmerabile 1...10V - 1...10V dimming

Color temperature	LED Light source	lm source
/W/DIM 4000K	25,3W	4080lm
/WW/DIM 3000K	25,3W	3880lm
/XW/DIM 2700K	25,3W	3720lm



2,00 Kg

Dimmerazione PUSH su richiesta
 PUSH dimming on request

4588 Bureau DIM DALI

- .01** Bianco - White
- .02** Nero - Black
- .05** Rosso - Red

Dimmerabile DALI - DALI dimming

/W/DALI 4000K	25,3W	4080lm
/WW/DALI 3000K	25,3W	3880lm
/XW/DALI 2700K	25,3W	3720lm



2,00 Kg

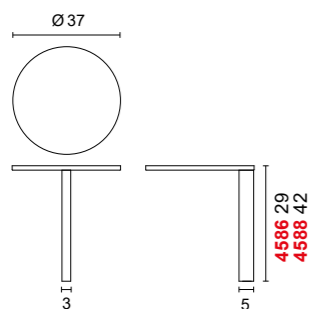

Codici finiture - Finishes codes

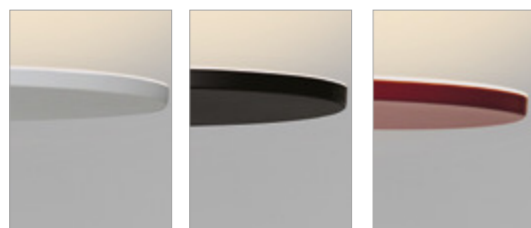

.01 **.02** **.05**

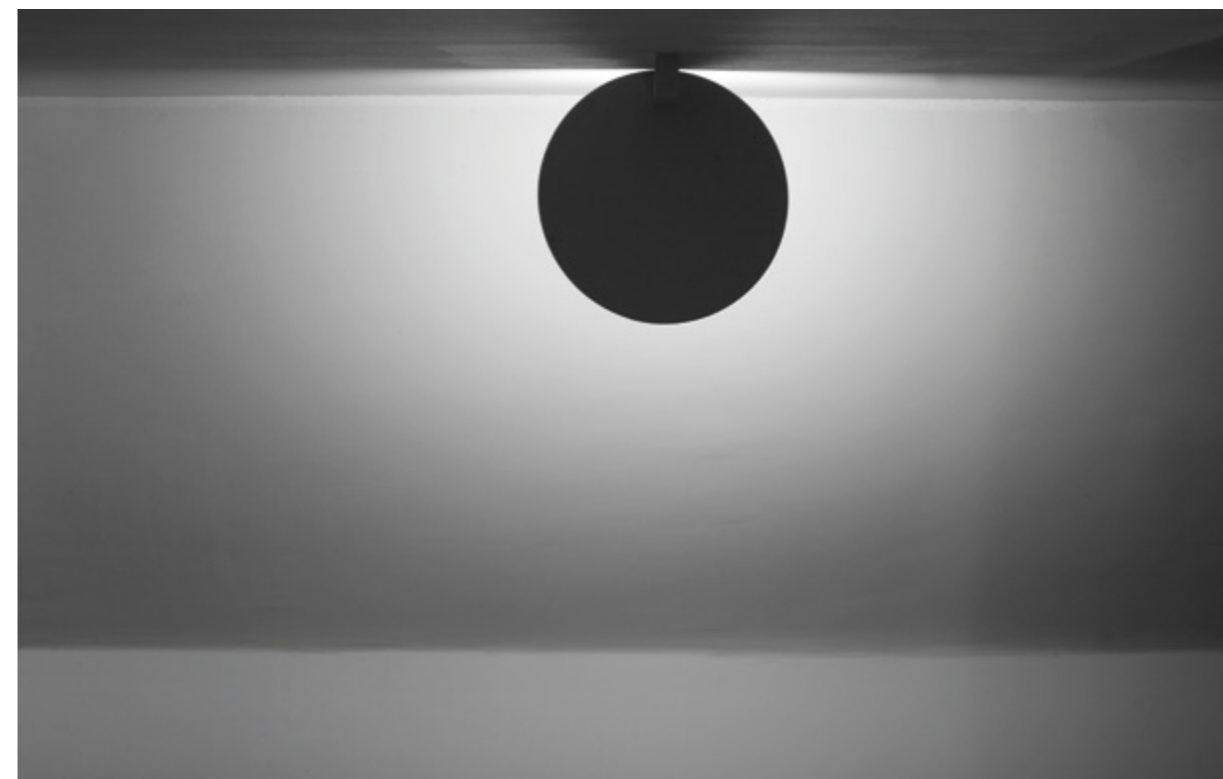



design **ABS Studio**
2020

178 180

Lampada a sospensione e da plafone a luce diretta con forma a mezza sfera di grande dimensione, struttura in alluminio tornito, portalampada con attacco E27 e disponibile in varie finiture.

Suspension and ceiling lamp providing direct light with a large half sphere shape, turned aluminium structure, lamp holder with E27 socket and available in various finishes.

Suspension et plafonnier à lumière directe avec une grande demi-sphère, structure en aluminium tourné, douille avec prise E27 et disponible en différentes finitions.

Lámpara de suspensión y techo de luz directa con forma de media esfera grande, estructura de aluminio torneado, portalámparas con casquillo E27 y disponible en varios acabados.

Hänge- und Deckenleuchte für direktes Licht mit großer Halbkugelform, gedrehter Aluminiumstruktur, Lampenfassung mit E27-Fassung und in verschiedenen Ausführungen erhältlich.

Giove



- 1599** Giove
- .01** Bianco - *White*
 - .02** Nero - *Black*
 - .02.01** Nero, interno bianco - *Black, white inside*
 - .02.29** Nero, interno foglia oro - *Black, gold leaf inside*

Light source not included
 E27 LED
 11W 1521lm (art. 0106/ML...)

 3,50 Kg

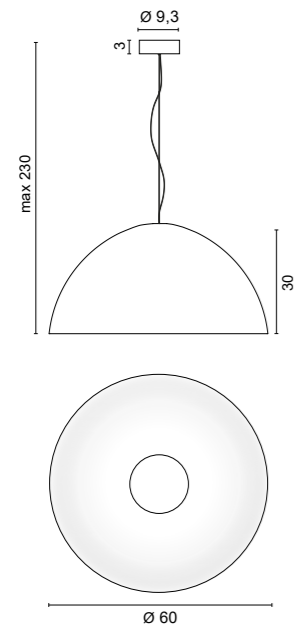

Codici finiture - *Finishes codes*



Accessori - *Accessories*



- 0532**
 Ø 1 cm
 H 3,5 cm
 Elemento per decentramento
Displacement element
-
- .31** Cromato lucido - *Chromed*



- 5650** Giove
- .01** Bianco - *White*
- .02** Nero - *Black*
- .02.01** Nero, interno bianco - *Black, white inside*
- .02.29** Nero, interno foglia oro - *Black, gold leaf inside*

Light source not included
 E27 LED
 11W 1521lm (art. 0106/ML...)

3,00 Kg

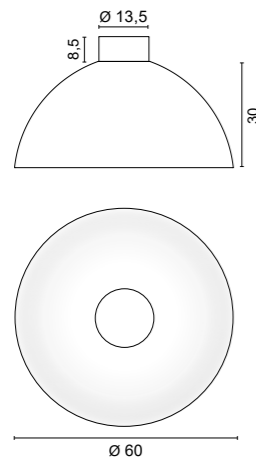

Codici finiture - *Finishes codes*



.01 **.02** **.02.01** **.02.29**



design **ABS Studio**
2020

Lampada da plafone o da incasso a luce diretta con struttura conica in alluminio e portalampada con attacco E27. Disponibile in due altezze. La forma caratterizza l'emissione della Luce creando coni luminosi d'effetto. La sorgente è arretrata e non abbagliante.

Ceiling or recessed direct light lamp with conical aluminium structure and lamp holder with E27 socket. Available in two heights. The shape characterises the light emission, creating impressive light cones. The source is recessed and non-dazzling.

Plafonnier ou encastré à lumière directe avec structure conique en aluminium et douille E27. Disponible en deux hauteurs. La forme caractérise l'émission de lumière, créant des cônes de lumière impressionnants. La source est encastrée et non éblouissante.

Lámpara de techo o empotrada de luz directa con estructura cónica de aluminio y portalámparas con casquillo E27. Disponible en dos alturas. La forma caracteriza la emisión de luz, creando impresionantes conos de luz. La fuente está empotrada y no deslumbra.

Direkt strahlende Decken- oder Einbauleuchte mit konischer Aluminiumstruktur und E27-Lampenfassung. Erhältlich in zwei Höhen. Die Form charakterisiert den Lichtaustritt und erzeugt eindrucksvolle Lichtkegel. Die Quelle ist versenkt und blendfrei.

Marte



Marte 5651.02 + 0923

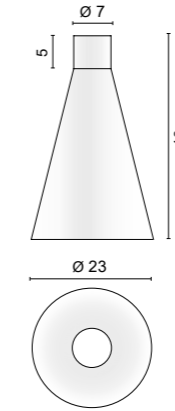

5651 Marte
.01 Bianco - White
.02 Nero - Black
Light source not included
 E27 LED
 11W 1521lm (art. 0109/11/...)
 F R 0,85 Kg

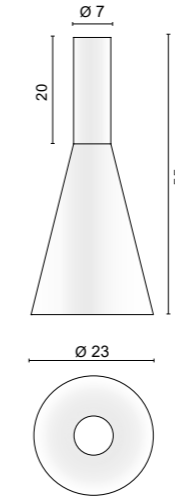

5652 Marte
.01 Bianco - White
.02 Nero - Black
Light source not included
 E27 LED
 11W 1521lm (art. 0109/11/...)
 F R 1,00 Kg

Accessori - Accessories

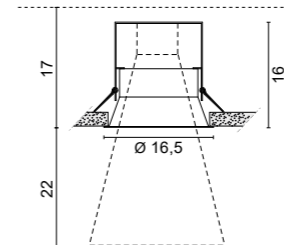

5651 + 0923

0923
 Incasso per cartongesso
 Recessed for plasterboard

.01 Bianco - White

15,2 cm



Codici finiture - Finishes codes



.01

.02

design **ABS Studio**
2017

Lampada a sospensione a luce diretta con corpo di grandi dimensioni in alluminio tornito, rosone in ABS, portalampada con attacco E27 e cavo di alimentazione trasparente. La sua linea semplice richiama i modelli classici utilizzati nell'illuminazione di capannoni e grandi spazi industriali. Disponibile in diverse finiture.

Direct light pendant lamp with a large turned aluminium body, ABS ceiling rose, lamp holder with E27 socket and transparent power cable. Its simple line recalls classic models used in the lighting of warehouses and large industrial spaces. Available in various finishes.

Suspension à éclairage direct avec un grand corps en aluminium tourné, une rosace en ABS, une douille avec prise E27 et un câble d'alimentation transparent. Sa ligne simple rappelle les modèles classiques utilisés dans l'éclairage des entrepôts et des grands espaces industriels. Disponible en différentes finitions.

Lámpara colgante de luz directa con un gran cuerpo de aluminio torneado, florón de techo de ABS, portalámparas con casquillo E27 y cable de alimentación transparente. Su línea sencilla recuerda los modelos clásicos utilizados en la iluminación de almacenes y grandes espacios industriales. Disponible en varios acabados.

Direkt beleuchtete Hängeleuchte mit einem großen gedrehten Aluminiumkörper, ABS-Deckenrosette, Lampenfassung mit E27-Fassung und transparentem Stromkabel. Ihre schlichte Linie erinnert an klassische Modelle, die bei der Beleuchtung von Lagerhallen und großen Industrieräumen verwendet werden. Erhältlich in verschiedenen Ausführungen.

Pavillon

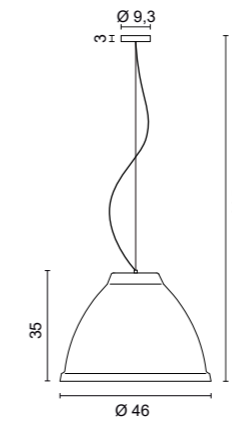
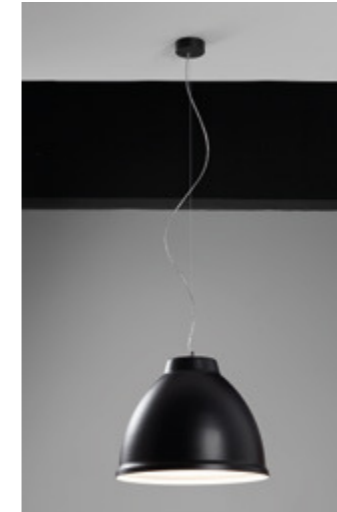

1558 Pavillon

.01 Bianco - White
.02.01 Nero, interno bianco - Black white inside
.05.01 Rosso, interno bianco - Red white inside
.35 Verniciato sabbia - Painted sand finishing

Light source not included

E27 LED
11W 1521lm (art. 0109/11/...)



1,10 Kg



Accessori - Accessories



0532

Ø 1 cm
H 3,5 cm

Elemento per decentramento
Displacement element

.31 Cromato lucido - Chromed

Codici finiture - Finishes codes



.01

.02.01

.05.01

.35



design **LUX Studio**
2021

Sistema di piccole lampade a sospensione a luce diffusa o diretta con corpo alluminio, diffusori in vetro opalino soffiato e acidato o in metallo stampato. I sistemi sono componibili in svariate configurazioni. Sono disponibili una serie di rosoni con alimentatore integrato per composizioni multiple e vari accessori da ordinare separatamente.

System of small pendant lamps providing diffused or direct light with aluminium body, blown and etched opal glass or pressed metal diffusers. The systems are modular in various configurations. A series of ceiling roses with driver are available for multiple compositions and various accessories to be ordered separately.

Système de petites lampes suspendues à lumière diffuse ou directe avec corps en aluminium, diffuseurs en verre opalin soufflé et gravé ou en métal pressé. Les systèmes sont modulables en plusieurs configurations. Une série de rosaces avec driver intégré pour des compositions multiples et divers accessoires à commander séparément sont disponibles.

Sistema de pequeñas lámparas colgantes de luz difusa o directa con cuerpo de aluminio, difusores de vidrio opalino soplado y grabado o de metal prensado. Los sistemas son modulares en varias configuraciones. Hay disponible una serie de florón a techo con driver integrado para composiciones múltiples y diversos accesorios que se piden por separado.

System von kleinen Pendelleuchten für diffuses oder direktes Licht mit Aluminiumkörper, geblasenem und geätzttem Opalglas oder gepressten Metalldiffusoren. Die Systeme sind modular in verschiedenen Konfigurationen aufgebaut. Eine Reihe von Rosetten mit integriertem Driver für mehrere Kompositionen und verschiedene, separat zu bestellende Zubehörteile sind erhältlich.

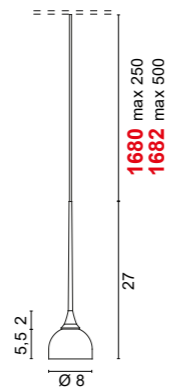

1680 Tulipano
.02 Nero, interno bianco - *Black, white inside*
.25 Dorato satinato, interno bianco - *Satin gold, white inside*

Color temperature	LED Light source	lm source
/WW 3000K	350mA 2W	296lm
/XW 2700K	350mA 2W	284lm

4000K su richiesta - *4000K on request* 0,15 Kg

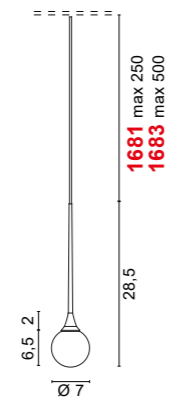

1681 Tulipano
.02 Nero - *Black*
.25 Dorato satinato - *Satin gold*

Color temperature	LED Light source	lm source
/WW 3000K	350mA 2W	296lm
/XW 2700K	350mA 2W	284lm

4000K su richiesta - *4000K on request* 0,20 Kg

1683 Tulipano
.02 Nero - *Black*
.25 Dorato satinato - *Satin gold*

Color temperature	LED Light source	lm source
/WW 3000K	350mA 2W	296lm
/XW 2700K	350mA 2W	284lm

4000K su richiesta - *4000K on request* 0,30 Kg

Codici finiture - *Finishes codes*



.02

.25



Hotel Langrein
 Ph. Hannes Niederkofler



Esempio d'installazione con 2 Tulipano 1680.02 + 0302.02 - Example of installation with 2 Tulipano 1680.02 + 0302.02



Esempio d'installazione con 2 Tulipano 1681.02 + 0614/2.02
Example of installation with 2 Tulipano 1681.02 + 0614/2.02



Esempio d'installazione con 4 Tulipano 1680.02 + 0614/4.02
Example of installation with 4 Tulipano 1680.02 + 0614/4.02

Rosoni e accessori per composizioni a cascata - Ceiling roses and accessories for cascade compositions

Rosoni - Ceiling rose

<p>0614/1</p>	<p>IN: 50/60Hz 220-240V OUT: 350mA DC</p>	<p>ROSONE COMPLETO DI DRIVER SENZA CAVO 1 TULIPANO CEILING ROSE WITH DRIVER WITHOUT CABLE 1 TULIPANO</p> <p>Code Codici finiture - Finishes codes 0614/1 .01 Bianco - White 0614/1 .02 Nero - Black</p> <p> </p> <p>0,13 Kg</p>
<p>0614/2</p>	<p>IN: 50/60Hz 220-240V OUT: 350mA DC</p>	<p>ROSONE COMPLETO DI DRIVER SENZA CAVO 2 TULIPANO CEILING ROSE WITH DRIVER WITHOUT CABLE 2 TULIPANO</p> <p>Code Codici finiture - Finishes codes 0614/2 .01 Bianco - White 0614/2 .02 Nero - Black</p> <p> </p> <p>0,20 Kg</p>
<p>0614/R</p>	<p>IN: 50/60Hz 220-240V OUT: 350mA DC</p>	<p>PIASTRA PER CARTONGESSO CON ALIMENTATORE 1 TULIPANO PLASTERBOARD CEILING ROSE WITH DRIVER 1 TULIPANO</p> <p>Code Codici finiture - Finishes codes 0614/R .01 Bianco - White 0614/R .02 Nero - Black</p> <p> 7,5 cm</p> <p>3,80 Kg</p>
<p>0614/4</p>	<p>IN: 50/60Hz 220-240V OUT: 350mA DC</p> <p>Dimmerazione PUSH, 1...10V, DALI su richiesta PUSH, 1...10V, DALI dimming on request</p>	<p>ROSONE COMPLETO DI DRIVER SENZA CAVO 4 TULIPANO CEILING ROSE WITH DRIVER WITHOUT CABLE 4 TULIPANO</p> <p>Code Codici finiture - Finishes codes 0614/4 .01 Bianco - White 0614/4 .02 Nero - Black</p> <p> </p> <p>1,20 Kg</p>
<p>0614/6</p>	<p>IN: 50/60Hz 220-240V OUT: 350mA DC</p> <p>Dimmerazione PUSH, 1...10V, DALI su richiesta PUSH, 1...10V, DALI dimming on request</p>	<p>ROSONE COMPLETO DI DRIVER SENZA CAVO 6 TULIPANO CEILING ROSE WITH DRIVER WITHOUT CABLE 6 TULIPANO</p> <p>Code Codici finiture - Finishes codes 0614/6 .01 Bianco - White 0614/6 .02 Nero - Black</p> <p> </p> <p>1,20 Kg</p>
<p>0614/9</p>	<p>IN: 50/60Hz 220-240V OUT: 350mA DC</p> <p>Dimmerazione PUSH, 1...10V, DALI su richiesta PUSH, 1...10V, DALI dimming on request</p>	<p>ROSONE COMPLETO DI DRIVER SENZA CAVO 9 TULIPANO CEILING ROSE WITH DRIVER WITHOUT CABLE 9 TULIPANO</p> <p>Code Codici finiture - Finishes codes 0614/9 .01 Bianco - White 0614/9 .02 Nero - Black</p> <p> </p> <p>2,40 Kg</p>
<p>Accessori - Accessories</p>		<p>0302 Ø 50 cm H 1 cm Arco in metallo per composizioni a 2 lampade Metal arch for compositions with 2 lamps</p> <p>.02 Nero - Black</p>



Esempio d'installazione con rosone 0615/12 + 9 Tulipano 1681.02 - Installation example with ceiling rose 0615/12 + 9 Tulipano 1681.02



Esempio d'installazione con anello 0304.02 + 6 Tulipano 1681.02 - Example of installation with ring 0304.02 + 6 Tulipano 1681.02

Rosoni e accessori per composizioni radiali - Ceiling roses and accessories for radial compositions

Rosoni - Ceiling rose

0615/6

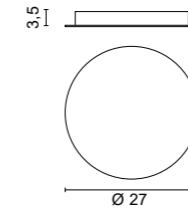
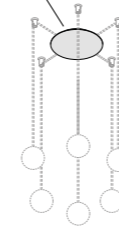

IN: 50/60Hz 220-240V
OUT: 350mA DC

ROSONE COMPLETO DI DRIVER SENZA CAVO 3-6 TULIPANO
CEILING ROSE WITH DRIVER WITHOUT CABLE 3-6 TULIPANO

Code Codici finiture - Finishes codes

0615/6 .01 Bianco - White

0615/6 .02 Nero - Black



0,50 Kg

Dimmerazione PUSH, 1...10V, DALI su richiesta
PUSH, 1...10V, DALI dimming on request

0615/12

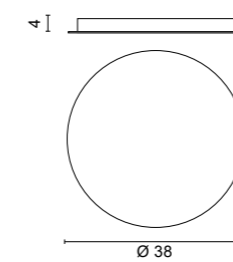
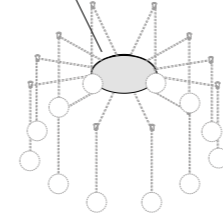

IN: 50/60Hz 220-240V
OUT: 350mA DC

ROSONE COMPLETO DI DRIVER SENZA CAVO 7-12 TULIPANO
CEILING ROSE WITH DRIVER WITHOUT CABLE 7-12 TULIPANO

Code Codici finiture - Finishes codes

0615/12 .01 Bianco - White

0615/12 .02 Nero - Black



1,80 Kg

Dimmerazione PUSH, 1...10V, DALI su richiesta
PUSH, 1...10V, DALI dimming on request

Accessori - Accessories

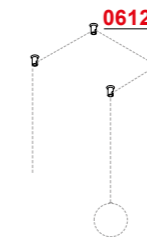

0612

0612

Ø 1,4 cm

H 2,2 cm

1 Deviatore e decentratore

1 Displacement element

.01 Bianco - White

.02 Nero - Black

0304

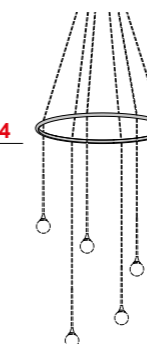

0304

Ø 50 cm

H 1 cm

Anello in metallo per composizioni da 3 a 6 lampade
Metal ring for compositions from 3 to 6 lamps

.02 Nero - Black



Rosoni e accessori per composizioni lineari - Ceiling roses and accessories roses for linear compositions

Rosoni - Ceiling rose

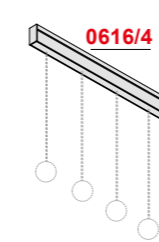
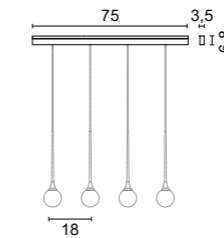
**0616/4**

IN: 50/60Hz 220-240V
OUT: 350mA DC

ROSONE COMPLETO DI DRIVER SENZA CAVO 4 TULIPANO
CEILING ROSE WITH DRIVER WITHOUT CABLE 4 TULIPANO

Code Codici finiture - Finishes codes

0616/4 .01 Bianco - White

0616/4 .02 Nero - Black



1,10 Kg

Dimmerazione PUSH, 1...10V, DALI su richiesta
PUSH, 1...10V, DALI dimming on request

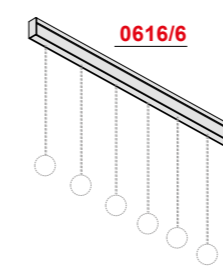
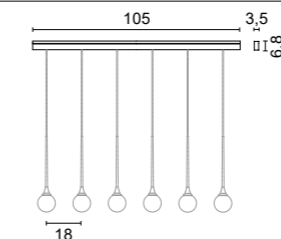
**0616/6**

IN: 50/60Hz 220-240V
OUT: 350mA DC

ROSONE COMPLETO DI DRIVER SENZA CAVO 6 TULIPANO
CEILING ROSE WITH DRIVER WITHOUT CABLE 6 TULIPANO

Code Codici finiture - Finishes codes

0616/6 .01 Bianco - White

0616/6 .02 Nero - Black



1,30 Kg

Dimmerazione PUSH, 1...10V, DALI su richiesta
PUSH, 1...10V, DALI dimming on request

Accessori - Accessories

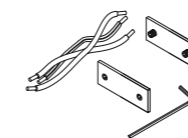
**0305**

Kit elemento di giunzione tra rosioni con cavi
Kit: connectors with wires



design **P. Pepere**
2017

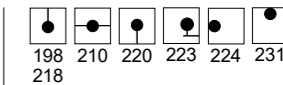

Collezione di lampade a luce diffusa con corpo in trafilata di alluminio e diffusore in policarbonato opalino. Disponibile in varie tipologie, differenti formati, diverse misure e svariate finiture.

Collection of diffused light lamps with die-cast aluminium body and opal polycarbonate diffuser. Available in different types, sizes, models and finishes.

Collection de lampes à lumière diffuse avec corps en aluminium moulé sous pression et diffuseur en polycarbonate opale. Disponible en différents types, tailles, modèles et finitions.

Colección de lámparas de luz difusa con cuerpo de aluminio fundido a presión y difusor de policarbonato opalino. Disponible en diferentes tipos, tamaños, modelos y acabados.

Kollektion von Lampen mit diffusem Licht, mit Gehäuse aus Aluminiumdruckguss und Diffusor aus opalem Polycarbonat. Erhältlich in verschiedenen Typen, Größen, Modellen und Ausführungen.

Lancio

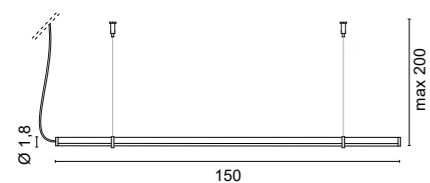

1539 Lancia System

- .01** Bianco - *White*
- .02** Nero - *Black*
- .85** Verniciato argento - *Painted silver finishing*
- .86** Verniciato oro - *Painted gold finishing*
- .87** Verniciato rame - *Painted copper finishing*
- .88** Verniciato bronzo - *Painted bronze finishing*

Color temperature	LED Light source	lm source
/W 4000K	24V 27W	3390lm
/WW 3000K	24V 27W	3030lm
/XW 2700K	24V 27W	2835lm



0,30 Kg

Kit di fissaggio a sospensione fornito con la lampada
Suspension fixing kit supplied with the lamp



Il profilo può ruotare sul suo asse di 360° per orientare la luce
The profile can rotate on its axis of 360° to direct the light

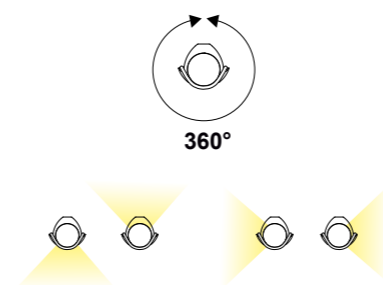

Esempio di installazione con rosone 0990/60.01
Example of installation with ceiling rose 0990/60.01

CUSTOM SIZE Tabella lunghezze disponibili - *Table of available lengths*

cm	watt	2700K (XW)	lm source	3000K (WW)	lm source	4000K (W)	lm source
102	18W	A1539 * /100/XW	1890	A1539 * /100/WW	2020	A1539 * /100/W	2260
127	22,5W	A1539 * /125/XW	2362	A1539 * /125/WW	2525	A1539 * /125/W	2825
** 152	27W	1539 * /XW	2835	1539 * /WW	3030	1539 * /W	3390
177	31,5W	A1539 * /175/XW	3307	A1539 * /175/WW	3535	A1539 * /175/W	3955
202	36W	A1539 * /200/XW	3780	A1539 * /200/WW	4040	A1539 * /200/W	4520
227	40,5W	A1539 * /225/XW	4252	A1539 * /225/WW	4545	A1539 * /225/W	5085
252	45W	A1539 * /250/XW	4725	A1539 * /250/WW	5050	A1539 * /250/W	5650
277	49,5W	A1539 * /275/XW	5197	A1539 * /275/WW	5555	A1539 * /275/W	6215
302	54W	A1539 * /300/XW	5670	A1539 * /300/WW	6060	A1539 * /300/W	6780

** Articolo standard a catalogo - *Standard catalogue item*

* Codici finiture - *Finishes codes*

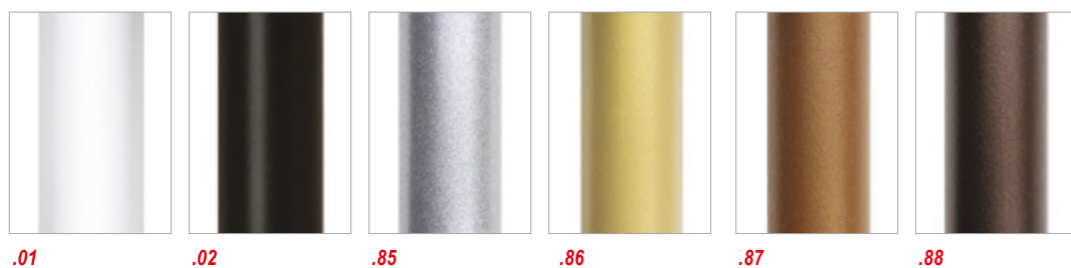

Rosoni con alimentatori da ordinare separatamente (p. 216) - *Ceiling roses with drivers are to be ordered separately (p. 216)*



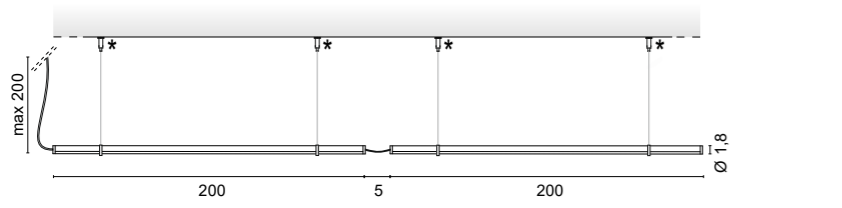

* Installazione sospesa con art. 0991/C - Suspended installation with art. 0991/C

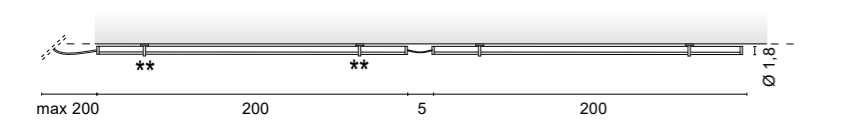

** Installazione soffitto/parete con art. 0093 - Ceiling/wall installation with art. 0093

1670 Multi Lancia System 2x200 cm

- .01 Bianco - White
- .02 Nero - Black

Color temperature	LED light source	lm source
/W 4000K	72W CRI>90	9040lm
/WW 3000K	72W CRI>90	8080lm
/XW 2700K	72W CRI>90	7560lm



Kit di fissaggio e clip da ordinare separatamente
Fixing kit and clip to be ordered separately

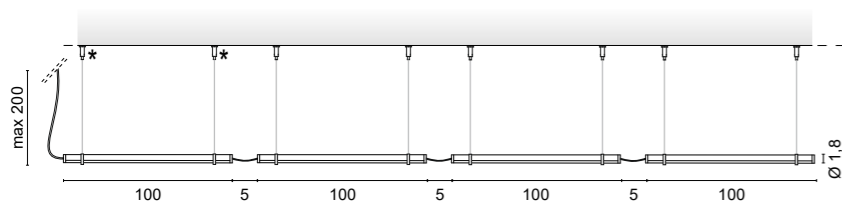

* Installazione sospesa con art. 0991/C - Suspended installation with art. 0991/C

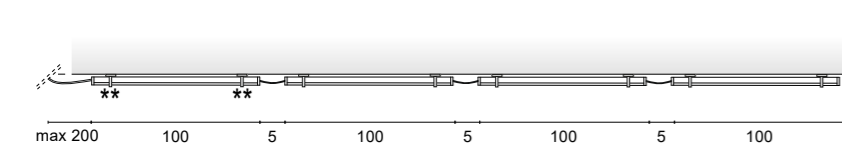

** Installazione soffitto/parete con art. 0093 - Ceiling/wall installation with art. 0093

1671 Multi Lancia System 4x100 cm

- .01 Bianco - White
- .02 Nero - Black

Color temperature	LED light source	lm source
/W 4000K	72W CRI>90	9040lm
/WW 3000K	72W CRI>90	8080lm
/XW 2700K	72W CRI>90	7560lm



Kit di fissaggio e clip da ordinare separatamente
Fixing kit and clip to be ordered separately

Codici finiture - Finishes codes

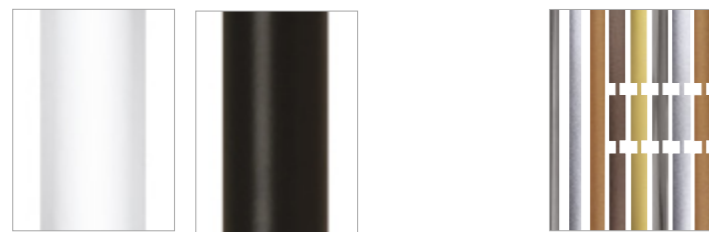

.01

.02

Il profilo può ruotare sul suo asse di 360° per orientare la luce
The profile can rotate on its axis of 360° to direct the light

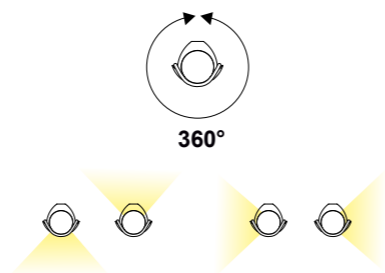

Accessori - Accessories



0991/C

Kit fissaggio singola lampada
1 Cavo acciaio 2 mt
1 Decentratore fissaggio cavo
1 Clip reggi lampada

Single lamp cable kit
1 Steel cable 2 mt
1 Element for cable fixing
1 Suspension clip

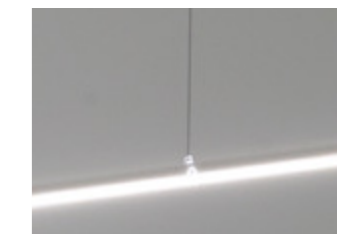

0092

Kit di fissaggio tra lampade
Fixing kit between lamp

.00 Trasparente - Clear



0093

Clip di fissaggio a soffitto
Ceiling fixing clip

.00 Trasparente - Clear

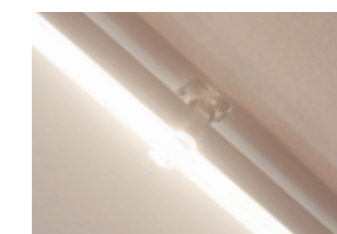

Esempi di installazioni - Example of installations

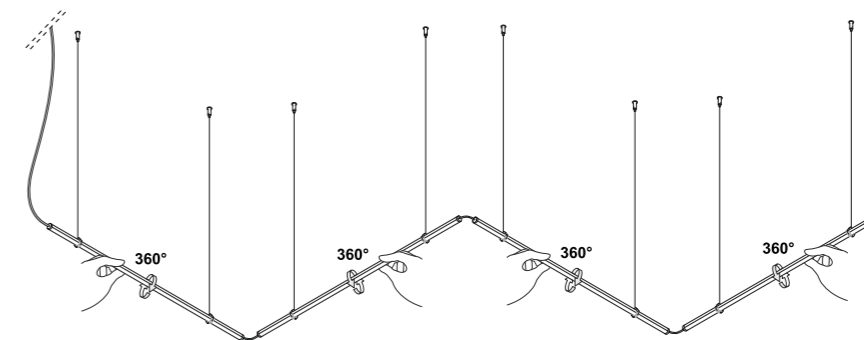
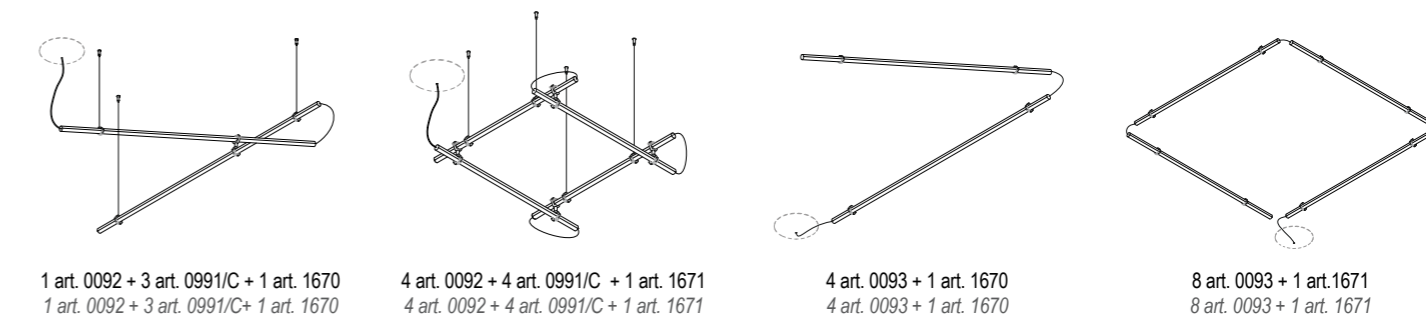

8 art. 0991/C + 1 art. 1671
8 art. 0991/C + 1 art. 1671



Esempio di installazione a sospensione con art.1670 e 0991/C - Example of suspended installation with art.1670 and 0991/C



Esempio di installazione a sospensione con 2 art.1670 e 0991/C - Example of suspended installation with 2 art.1670 and 0991/C



Esempio di installazione a plafone con art. 1670 e 0093 - Example of ceiling installation with art. 1670 and 0093

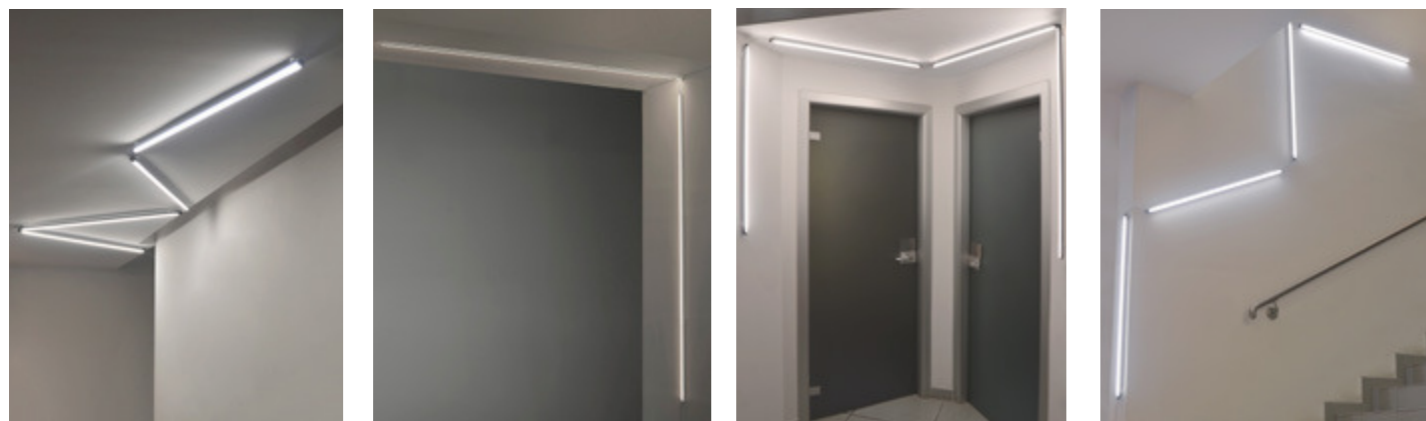

Esempio di installazione parete/plafone con art. 1670 e 0093 - Example of wall/ceiling installation with art. 1670 and 0093



1673 Lancia no Limits

- .01** Bianco - White
- .02** Nero - Black

500 cm

Color temperature	LED Light source	lm source
/500/W 4000K	24V 60W	9200lm
/500/WW 3000K	24V 60W	8250lm
/500/XW 2700K	24V 60W	7800lm

1,50 Kg

900 cm

Color temperature	LED Light source	lm source
/900/W 4000K	24V 108W	16560lm
/900/WW 3000K	24V 108W	14850lm
/900/XW 2700K	24V 108W	14040lm

2,70 Kg



Kit di fissaggio e clip da ordinare separatamente
Fixing kit and clip to be ordered separately

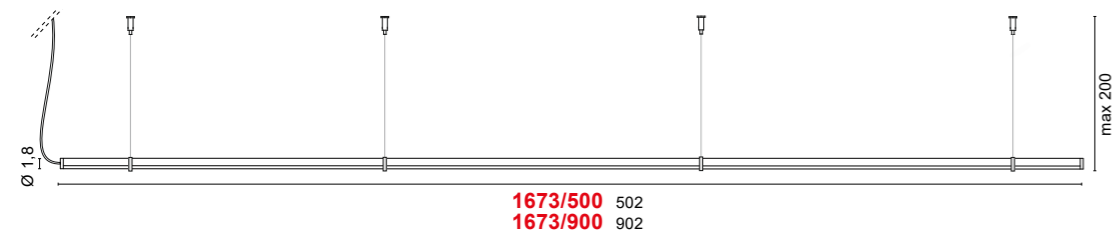

Codici finiture - Finishes codes



.01

.02

Il profilo può ruotare sul suo asse di 360° per orientare la luce
The profile can rotate on its axis of 360° to direct the light

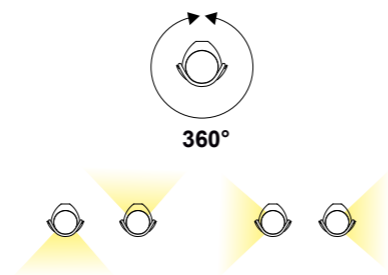

Accessori - Accessories



0991/C

Kit fissaggio singola lampada
1 Cavo acciaio 2 mt
1 Decentratore fissaggio cavo
1 Clip reggi lampada

Single lamp cable kit
1 Steel cable 2 mt
1 Element for cable fixing
1 Suspension clip

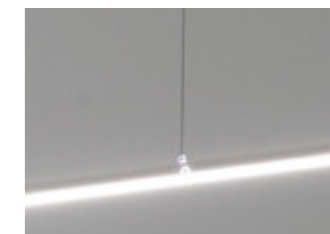

0092

Kit di fissaggio tra lampade
Fixing kit between lamp

.00 Trasparente - Clear

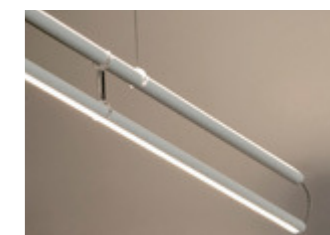

0093

Clip di fissaggio a soffitto
Ceiling fixing clip

.00 Trasparente - Clear

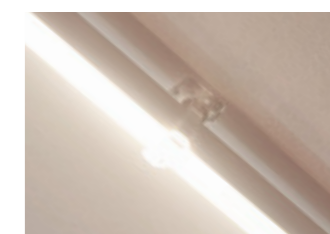

Indicazioni per una corretta installazione - Instructions for correct installation

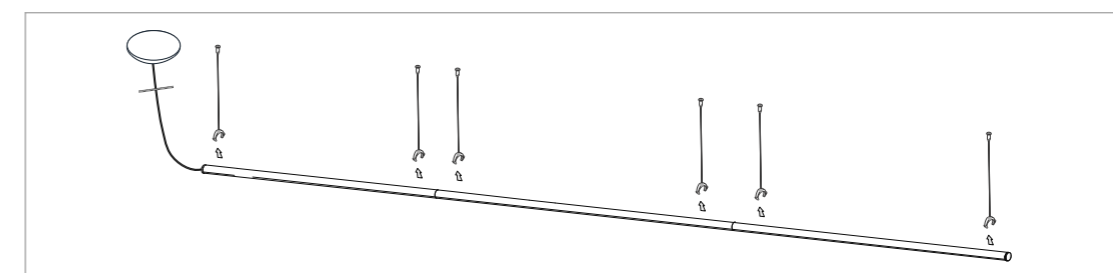
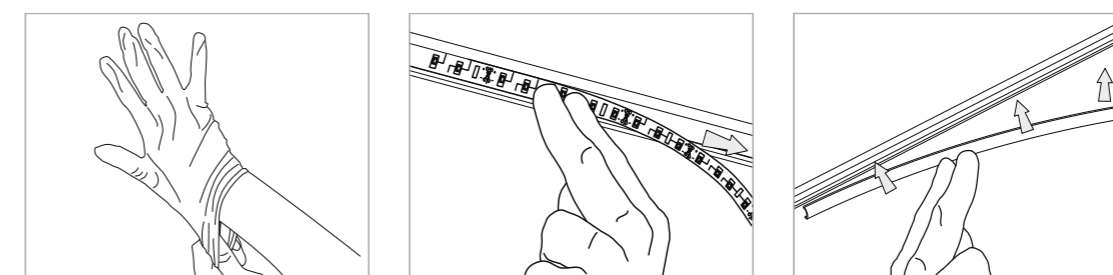
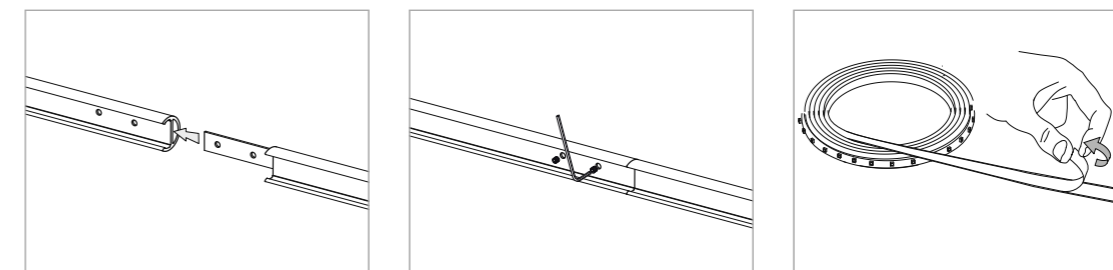



Esempio di installazione con rosone 0990/60.01 - Example of installation with ceiling rose 0990/60.01

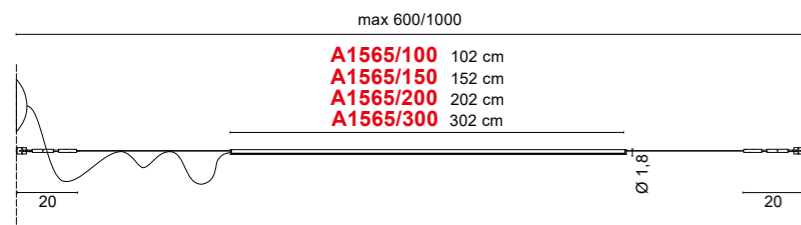

A1565 Lancia Cavo System senza rosone
Lancia Cavo System without ceiling rose

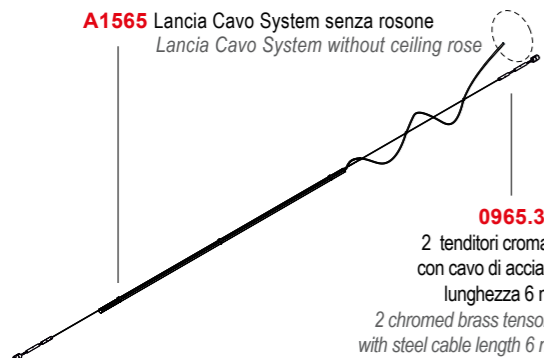

0965.31
2 tenditori cromati
con cavo di acciaio
lunghezza 6 mt
2 chromed brass tensors
with steel cable length 6 mt

0965.31/10
2 tenditori cromati
con cavo di acciaio
lunghezza 10 mt
2 chromed brass tensors
with steel cable length 10 mt

A1565 Lancia Cavo System

- .01** Bianco - White
- .02** Nero - Black
- .85** Verniciato argento - Painted silver finishing
- .86** Verniciato oro - Painted gold finishing
- .87** Verniciato rame - Painted copper finishing
- .88** Verniciato bronzo - Painted bronze finishing

100 cm

Color temperature	LED Light source	Im source
/100/W 4000K	18W	2260lm
/100/WW 3000K	18W	2020lm
/100/XW 2700K	18W	1890lm

500 CM 0,30 Kg

150 cm

Color temperature	LED Light source	Im source
/150/W 4000K	27W	3390lm
/150/WW 3000K	27W	3030lm
/150/XW 2700K	27W	2835lm

450 CM 0,45 Kg

200 cm

Color temperature	LED Light source	Im source
/200/W 4000K	36W	4520lm
/200/WW 3000K	36W	4040lm
/200/XW 2700K	36W	3780lm

400 CM 0,60 Kg

300 cm

Color temperature	LED Light source	Im source
/300/W 4000K	54W	6780lm
/300/WW 3000K	54W	6060lm
/300/XW 2700K	54W	5670lm

300 CM 0,90 Kg



Tenditori da ordinare separatamente
Tensors are to be ordered separately

Accessori - Accessories



0991/C

Kit fissaggio singola lampada
1 Cavo acciaio 2 mt
1 Decentratore fissaggio cavo
1 Clip reggi lampada

Single lamp cable kit
1 Steel cable 2 mt
1 Element for cable fixing
1 Suspension clip

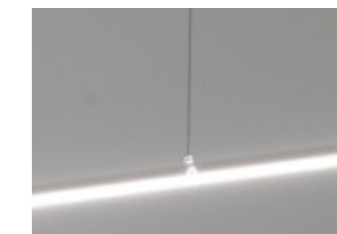

0965.31

Coppia di tenditori cromati con cavo di acciaio lunghezza 6 mt
2 chromed brass tensors with steel cable length 6 mt

0965.31/10

Coppia di tenditori cromati con cavo di acciaio lunghezza 10 mt
2 chromed brass tensors with steel cable length 10 mt

Codici finiture - Finishes codes

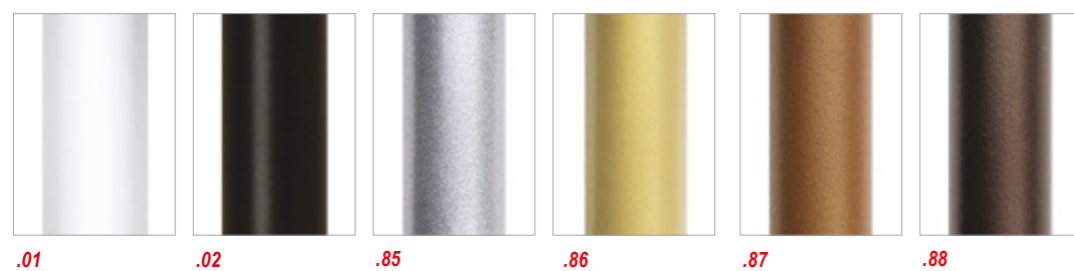

Rosoni con alimentatori da ordinare separatamente (p. 216) - Ceiling roses with drivers are to be ordered separately (p. 216)

Il profilo può ruotare sul suo asse di 360° per orientare la luce
The profile can rotate on its axis of 360° to direct the light

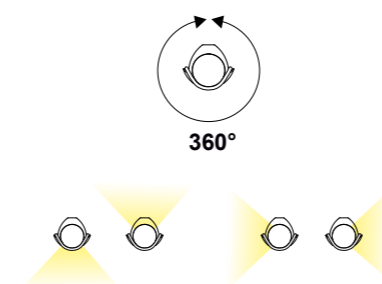



1672 Lancia no Limits Cavo

- .01 Bianco - White
- .02 Nero - Black

500 cm

Color temperature	LED Light source	lm source
/500/W 4000K	24V 60W	9200lm
/500/WW 3000K	24V 60W	8250lm
/500/XW 2700K	24V 60W	7800lm

1,50 Kg

900 cm

Color temperature	LED Light source	lm source
/900/W 4000K	24V 108W	16560lm
/900/WW 3000K	24V 108W	14850lm
/900/XW 2700K	24V 108W	14040lm

2,70 Kg



Kit di fissaggio e clip da ordinare separatamente
Fixing kit and clip to be ordered separately

Codici finiture - Finishes codes

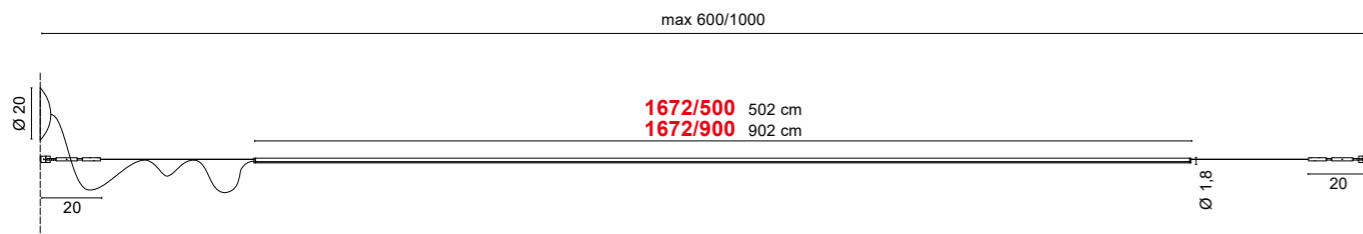
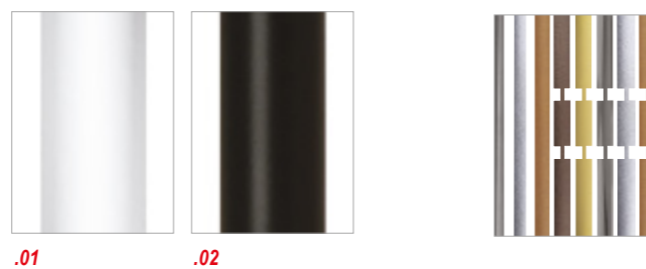

Rosoni con alimentatori da ordinare separatamente (p. 216) - Ceiling roses with drivers are to be ordered separately (p. 216)

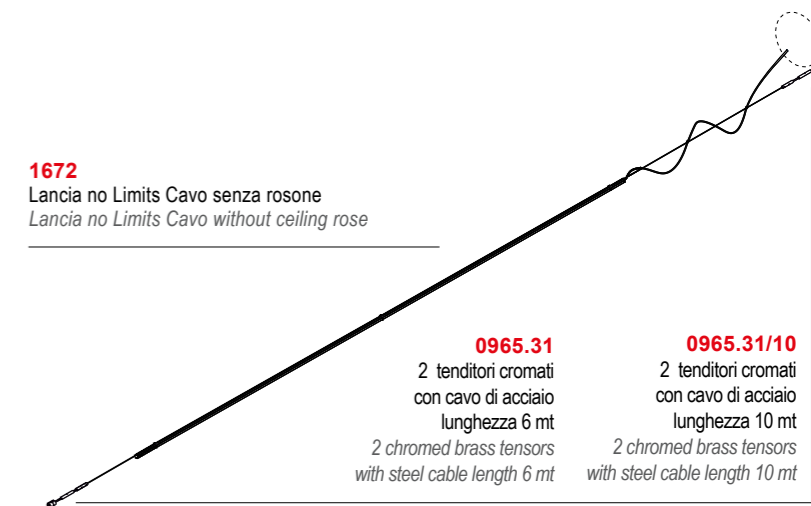

1672
Lancia no Limits Cavo senza rosone
Lancia no Limits Cavo without ceiling rose

- 0965.31**
2 tenditori cromati con cavo di acciaio lunghezza 6 mt
2 chromed brass tensors with steel cable length 6 mt
- 0965.31/10**
2 tenditori cromati con cavo di acciaio lunghezza 10 mt
2 chromed brass tensors with steel cable length 10 mt

Accessori - Accessories



0991/C

Kit fissaggio singola lampada
1 Cavo acciaio 2 mt
1 Decentratore fissaggio cavo
1 Clip reggi lampada

Single lamp cable kit
1 Steel cable 2 mt
1 Element for cable fixing
1 Suspension clip



0965.31/10

Coppia di tenditori cromati con cavo di acciaio lunghezza 10 mt
2 chromed brass tensors with steel cable length 10 mt



0965.31

Coppia di tenditori cromati con cavo di acciaio lunghezza 6 mt
2 chromed brass tensors with steel cable length 6 mt

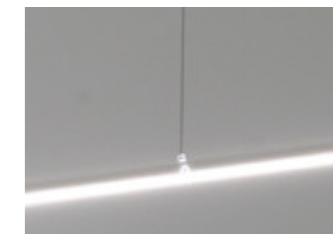

Il profilo può ruotare sul suo asse di 360° per orientare la luce
The profile can rotate on its axis of 360° to direct the light

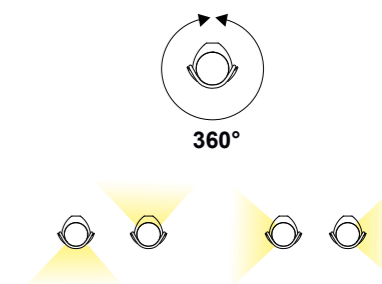



Indicazioni per una corretta installazione - Instructions for correct installation

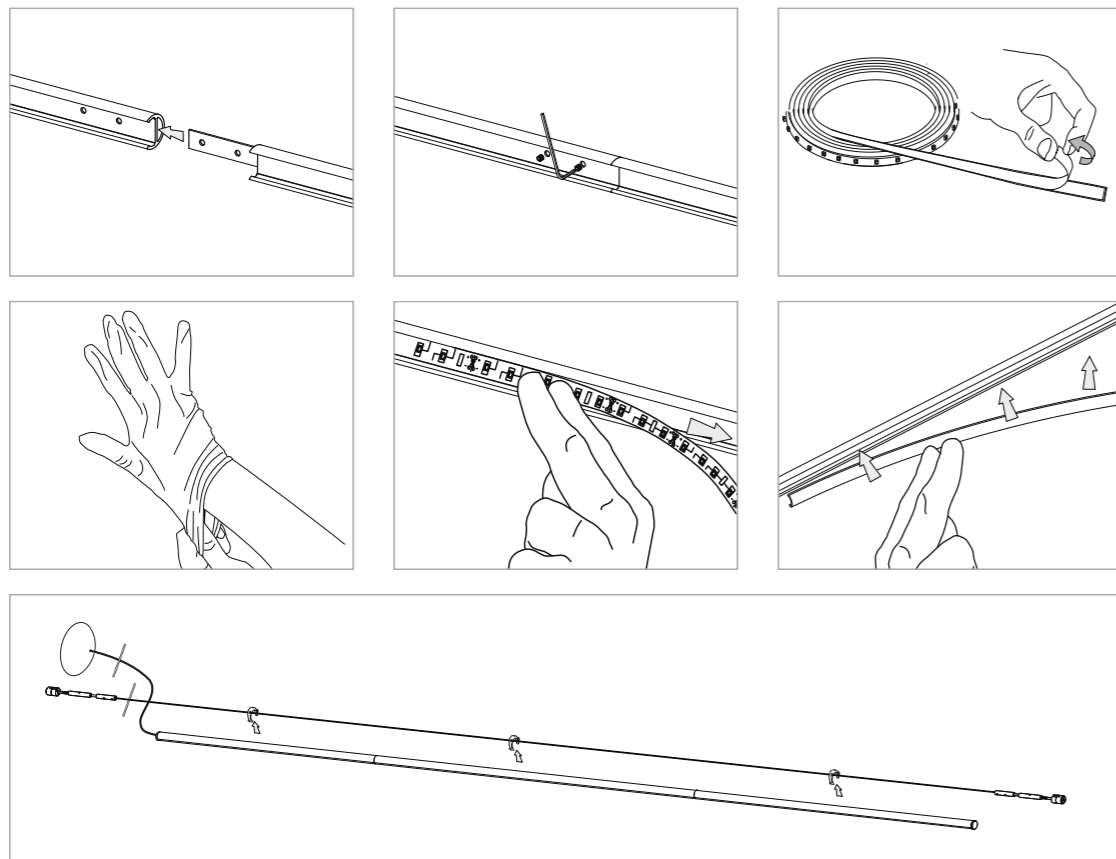

Rosoni - Ceiling rose



50/60Hz 220-230V - 30W

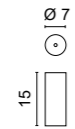

ROSONE COMPLETO DI DRIVER 30W
CEILING ROSE WITH DRIVER 30W

Code	W	Codici finiture - Finishes codes
0990/30	30W	.01 Bianco - White
0990/30	30W	.02 Nero - Black
0990/30	30W	.23 Alluminio satinato - Satin Aluminium



0,50 Kg



50/60Hz 220-230V - 60W

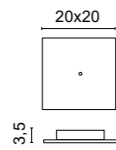

ROSONE COMPLETO DI DRIVER 60W
CEILING ROSE WITH DRIVER 60W

Code	W	Codici finiture - Finishes codes
0993/60	60W	.01 Bianco - White
0993/60	60W	.02 Nero con base bianca - Black with white base



0,60 Kg



50/60Hz 220-230V - 60W

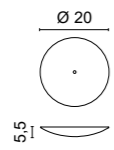

ROSONE COMPLETO DI DRIVER 60W
CEILING ROSE WITH DRIVER 60W

Code	W	Codici finiture - Finishes codes
0990/60	60W	.01 Bianco - White
0990/60	60W	.02 Nero - Black
0990/60	60W	.85 Verniciato argento - Painted silver finishing
0990/60	60W	.86 Verniciato oro - Painted gold finishing
0990/60	60W	.87 Verniciato rame - Painted copper finishing
0990/60	60W	.88 Verniciato bronzo - Painted bronze finishing



0,60 Kg



50/60Hz 220-230V - 100W

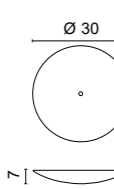

ROSONE COMPLETO DI DRIVER 100W
CEILING ROSE WITH DRIVER 100W

Code	W	Codici finiture - Finishes codes
0990/100	100W	.01 Bianco - White
0990/100	100W	.02 Nero - Black
0990/100	100W	.85 Verniciato argento - Painted silver finishing
0990/100	100W	.86 Verniciato oro - Painted gold finishing
0990/100	100W	.87 Verniciato rame - Painted copper finishing
0990/100	100W	.88 Verniciato bronzo - Painted bronze finishing



1,30 Kg



50/60Hz 220-230V - 150W

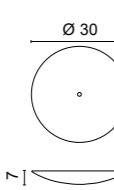

ROSONE COMPLETO DI DRIVER 150W
CEILING ROSE WITH DRIVER 150W

Code	W	Codici finiture - Finishes codes
0990/150	150W	.01 Bianco - White
0990/150	150W	.02 Nero - Black
0990/150	150W	.85 Verniciato argento - Painted silver finishing
0990/150	150W	.86 Verniciato oro - Painted gold finishing
0990/150	150W	.87 Verniciato rame - Painted copper finishing
0990/150	150W	.88 Verniciato bronzo - Painted bronze finishing



1,30 Kg



50/60Hz 220-230V - 200W

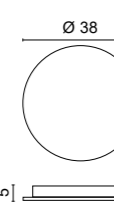

ROSONE COMPLETO DI DRIVER 200W (2x100W)
CEILING ROSE WITH DRIVER 200W (2x100W)

Code	W	Codici finiture - Finishes codes
0990/200	200W	.01 Bianco - White
0990/200	200W	.02 Nero - Black
0990/200	200W	.85 Verniciato argento - Painted silver finishing
0990/200	200W	.86 Verniciato oro - Painted gold finishing
0990/200	200W	.87 Verniciato rame - Painted copper finishing
0990/200	200W	.88 Verniciato bronzo - Painted bronze finishing



2,00 Kg

Esempi di installazione multipla, la scelta del driver è determinata dalla somma delle potenze delle singole lampade
Examples of multiple installation, the choice of the driver depends on total power consumption

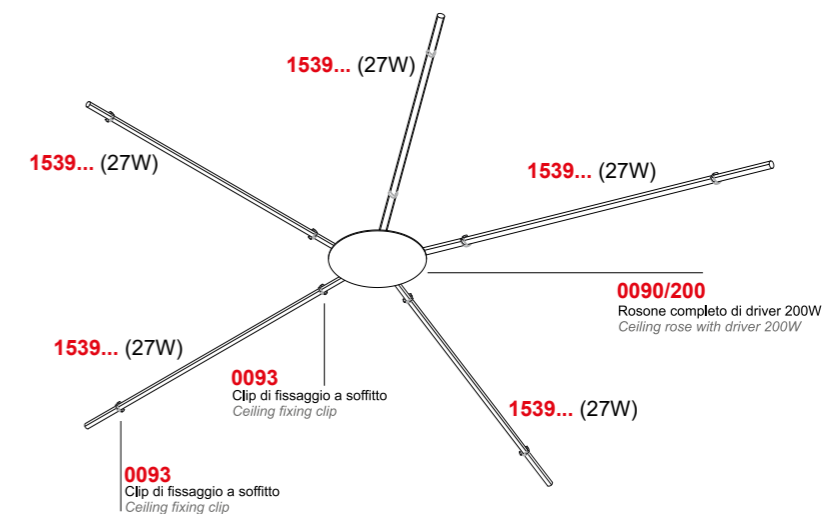
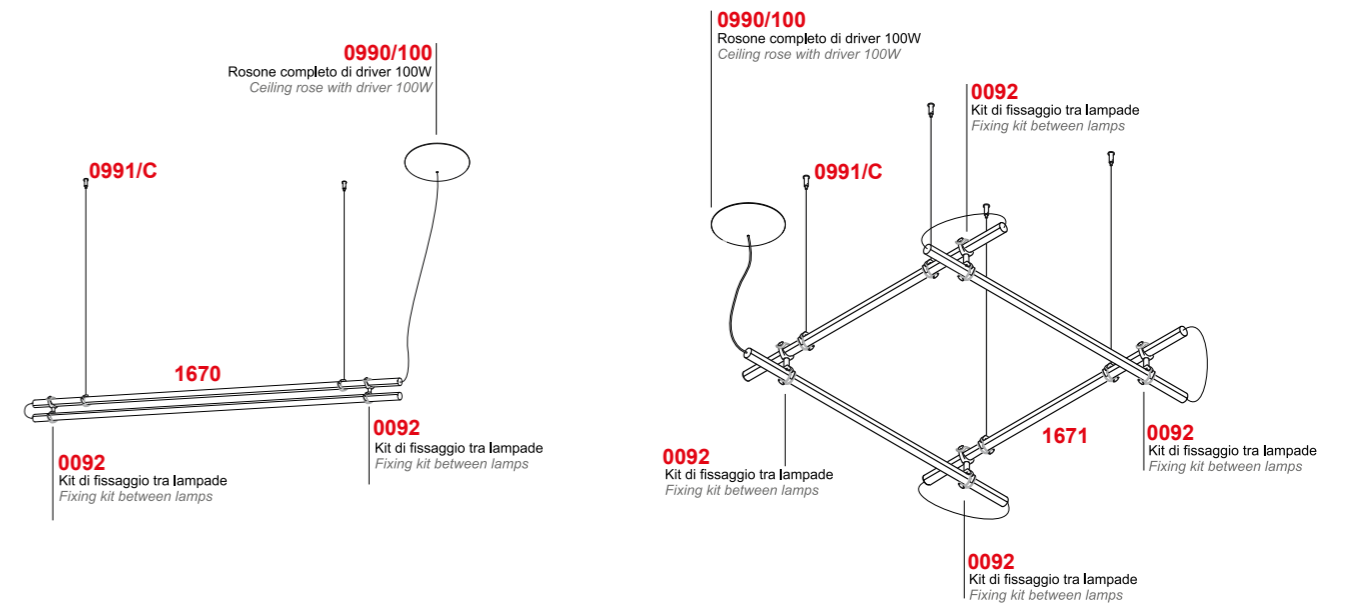
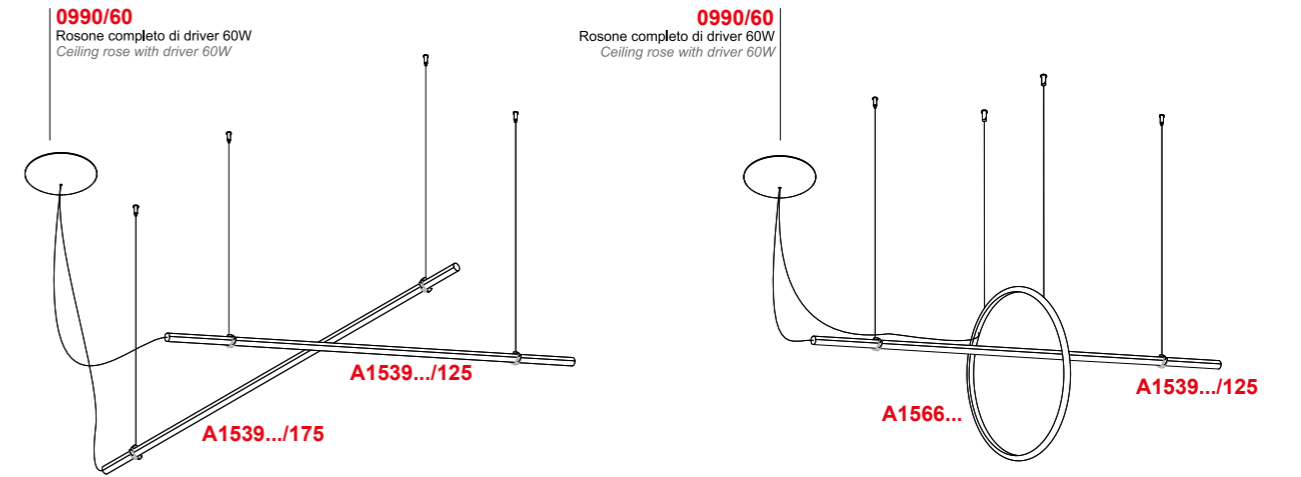

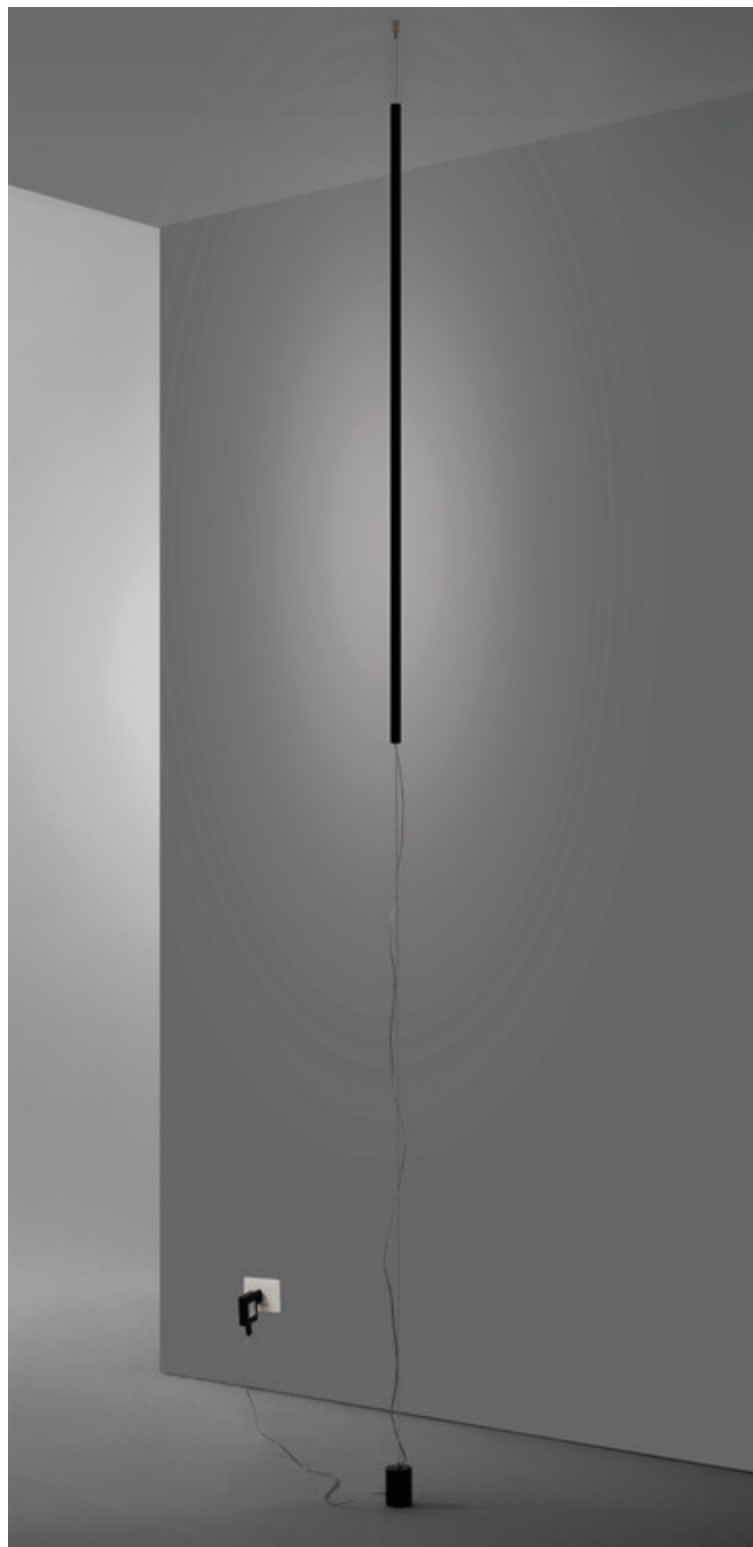

1577 Lancia
 .01 Bianco - White
 .02 Nero - Black
 .31 Cromato - Chromed

	Color temperature	LED Light source	lm source
/W	4000K	19,5W	2486lm
/WW	3000K	19,5W	2222lm
/XW	2700K	19,5W	2079lm

2,80 Kg

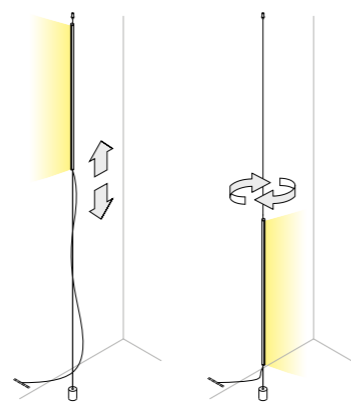
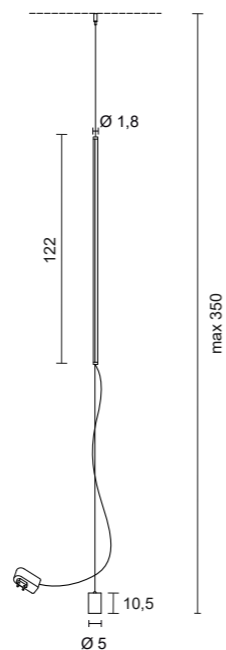

L'interruttore dimmer touch con memoria è integrato nel profilo
 The dimmer-switch with memory is integrated in the stem

Codici finiture - Finishes codes



.01 **.02** **.31**

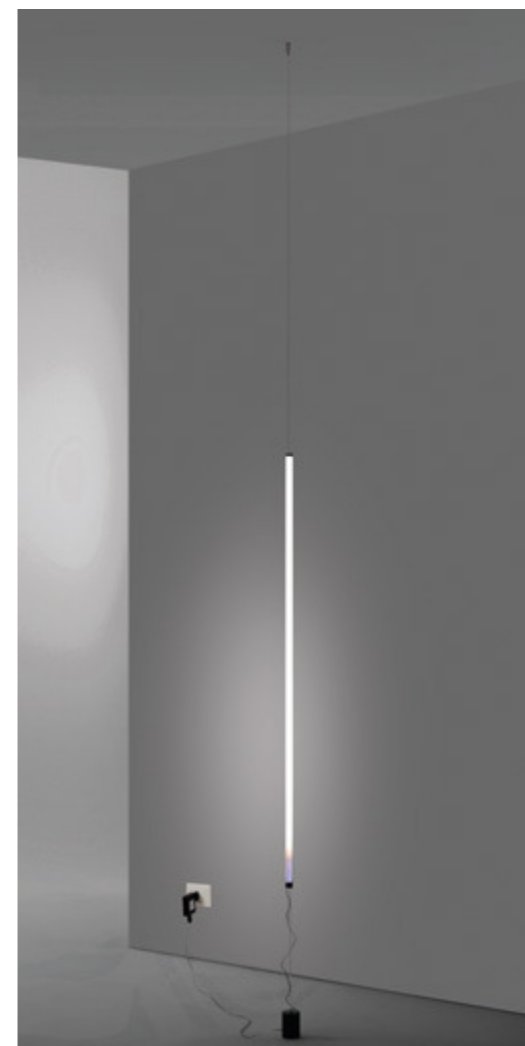

Particolare della lampada: il contrappeso
 Detail of the lamp: the counterweight

Lampada orientabile e scorrevole su cavo
 posizionabile all'altezza desiderata grazie ad un
 dispositivo di blocco

Adjustable and sliding lamp on cable that can be
 positioned at the desired height thanks to a locking
 device

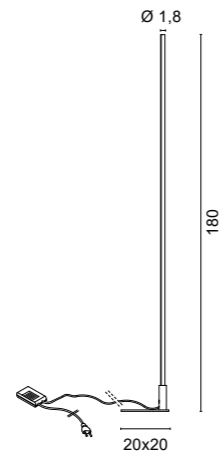

3522 Lancia

- .01** Bianco - White
- .02** Nero - Black

Color temperature	LED Light source	lm source
/W 4000K	31,5W	3955lm
/WW 3000K	31,5W	3535lm
/XW 2700K	31,5W	3308lm



2,50 Kg

Completa di DIMMER su cavo nero
With DIMMER on black cable

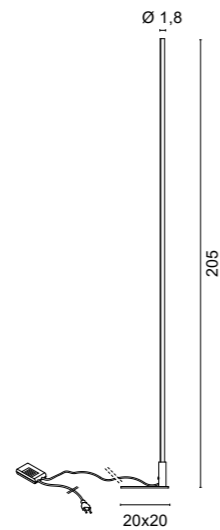

3523 Lancia

- .01** Bianco - White
- .02** Nero - Black

Color temperature	LED Light source	lm source
/W 4000K	36W	4520lm
/WW 3000K	36W	4040lm
/XW 2700K	36W	3780lm

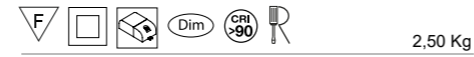

2,50 Kg

Completa di DIMMER su cavo nero
With DIMMER on black cable

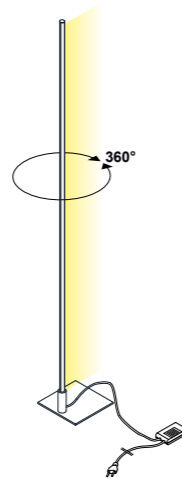

Codici finiture - Finishes codes



.01

.02



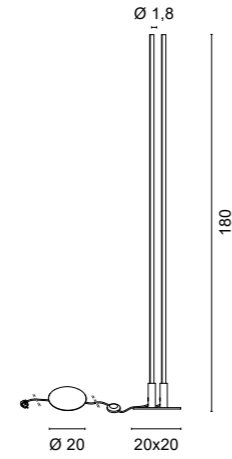

3524 Bi Lancia

- .01** Bianco - White
- .02** Nero - Black

Color temperature	LED Light source	lm source
/W 4000K	52,5W	6400lm
/WW 3000K	52,5W	5770lm
/XW 2700K	52,5W	5460lm



Completa di DIMMER su cavo nero
With DIMMER on black cable

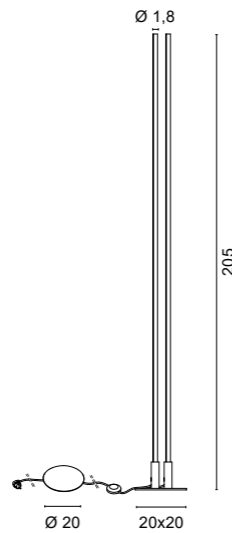

3525 Bi Lancia

- .01** Bianco - White
- .02** Nero - Black

Color temperature	LED Light source	lm source
/W 4000K	60W	7360lm
/WW 3000K	60W	6600lm
/XW 2700K	60W	6240lm

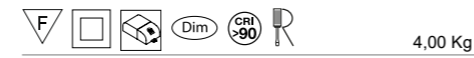

Completa di DIMMER su cavo nero
With DIMMER on black cable

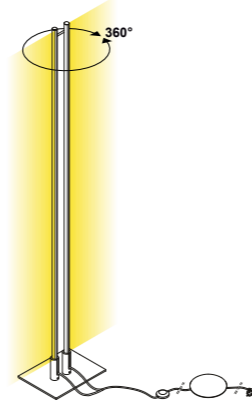

Codici finiture - Finishes codes



.01

.02

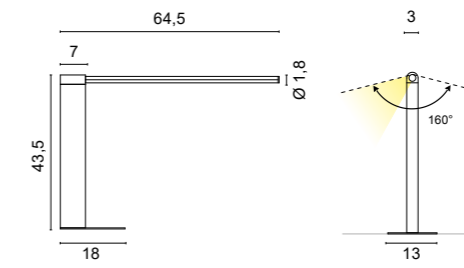

2506 Lancia

- .01** Bianco - White
- .02** Nero - Black

Color temperature	LED Light source	lm source
/W 4000K	9W	1130lm
/WW 3000K	9W	1010lm
/XW 2700K	9W	945lm



Completa di PUSH DIMMER
With PUSH DIMMER



La lampada è fornita con dimmer touch integrato nel profilo
The lamp is supplied with a touch dimmer integrated in the profile

Codici finiture - Finishes codes

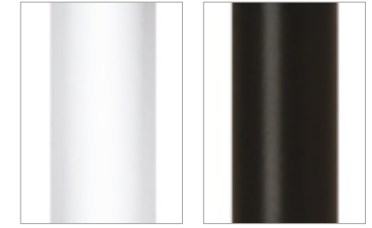

.01

.02



4567 Lancia

- .01** Bianco - *White*
- .02** Nero - *Black*
- .24** Cromo nero - *Black chrome*
- .25** Dorato satinato - *Satin gold*
- .31** Cromato lucido - *Chromed*
- .32** Nickel satinato - *Nickel mat*

Color temperature	LED Light source	lm source
/W 4000K	9W	1130lm
/WW 3000K	9W	1010lm
/XW 2700K	9W	945lm

IP40 0,80 Kg

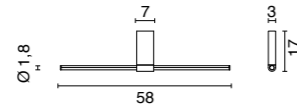

Art. 4567
Art. 4568

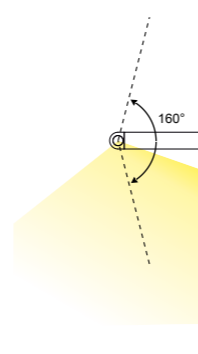

4568 Lancia

- .01** Bianco - *White*
- .02** Nero - *Black*
- .24** Cromo nero - *Black chrome*
- .25** Dorato satinato - *Satin gold*
- .31** Cromato lucido - *Chromed*
- .32** Nickel satinato - *Nickel mat*

Color temperature	LED Light source	lm source
/W 4000K	18W	2260lm
/WW 3000K	18W	2020lm
/XW 2700K	18W	1980lm

IP40 1,00 Kg

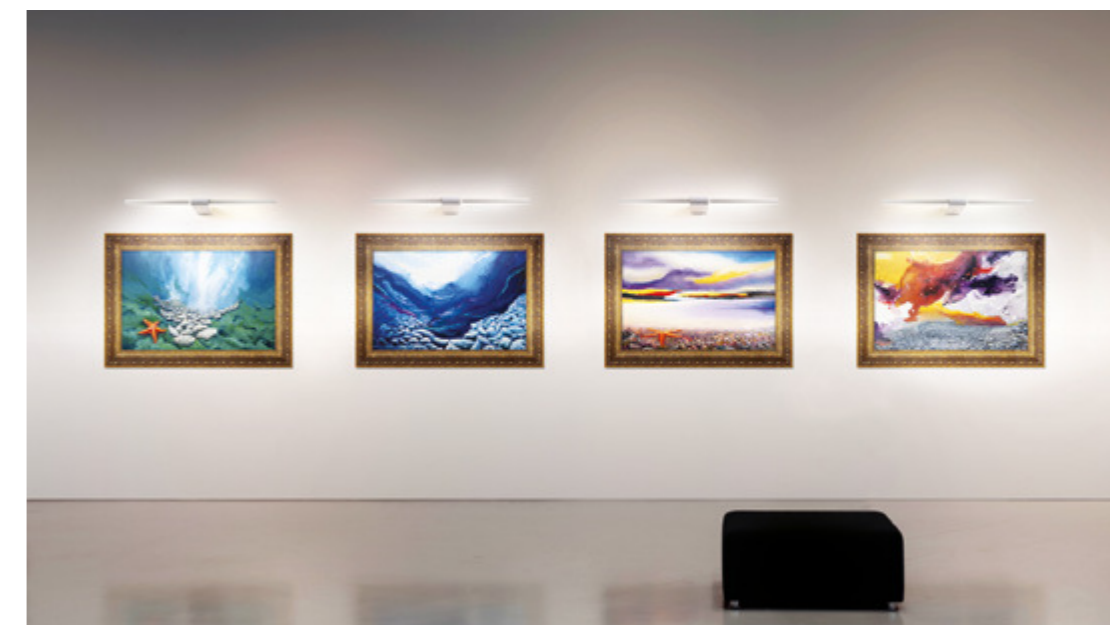
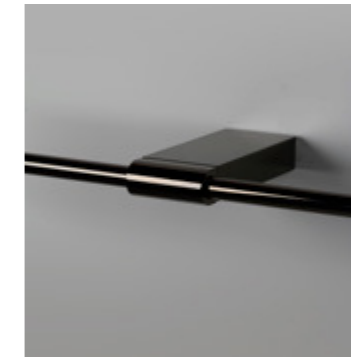
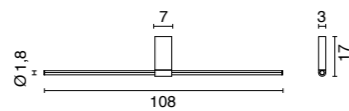

Codici finiture - *Finishes codes*

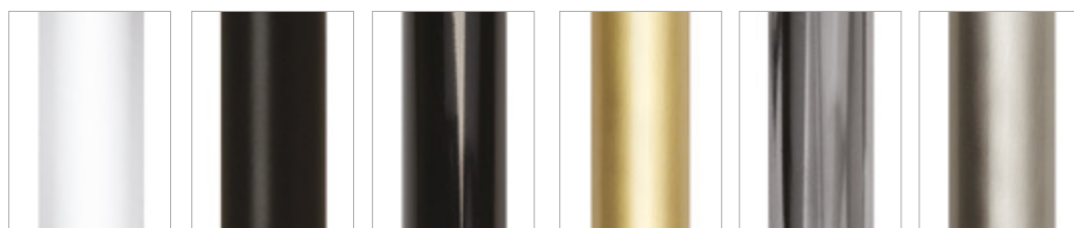

.01 **.02** **.24** **.25** **.31** **.32**



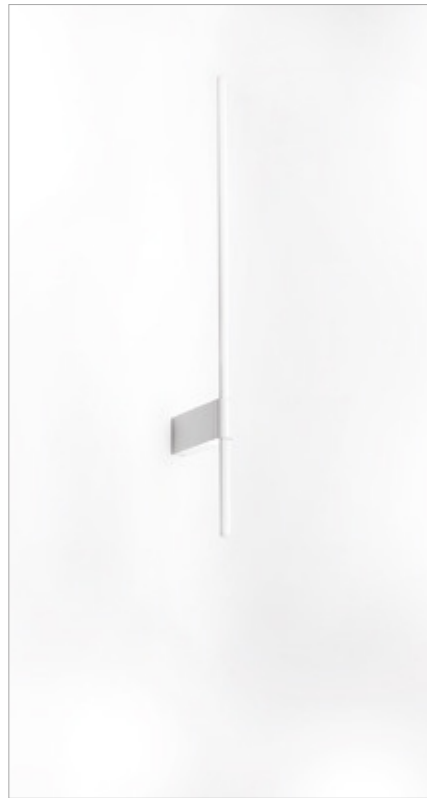

4569 Lancia

- .01** Bianco - *White*
- .02** Nero - *Black*
- .24** Cromo nero - *Black chrome*
- .25** Dorato satinato - *Satin gold*
- .31** Cromato lucido - *Chromed*
- .32** Nickel satinato - *Nickel mat*

Color temperature	LED Light source	lm source
/W 4000K	16,5W	2072lm
/WW 3000K	16,5W	1852lm
/XW 2700K	16,5W	1732lm

IP40 0,90 Kg

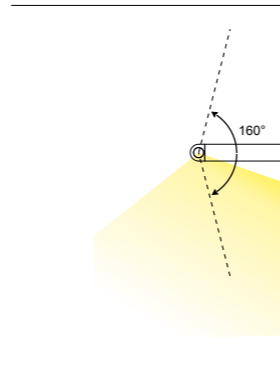
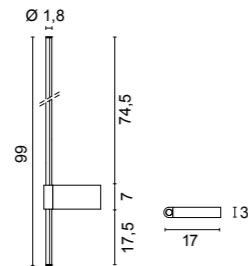

Codici finiture - *Finishes codes*

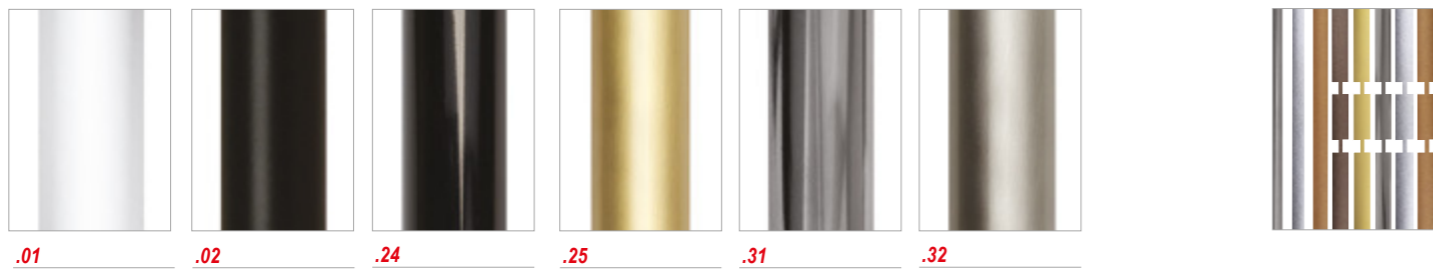

Arch. Laura Verdi, DEMO HOTEL
Ph. Fabio Bascetta



4566 Lancia Mini

- .01** Bianco - *White*
- .02** Nero - *Black*
- .25** Dorato satinato - *Satin gold*

Color temperature	LED Light source	lm source
/W 4000K	5,4W	600lm
/WW 3000K	5,4W	595lm
/XW 2700K	5,4W	537lm

F IP40    0,40 Kg

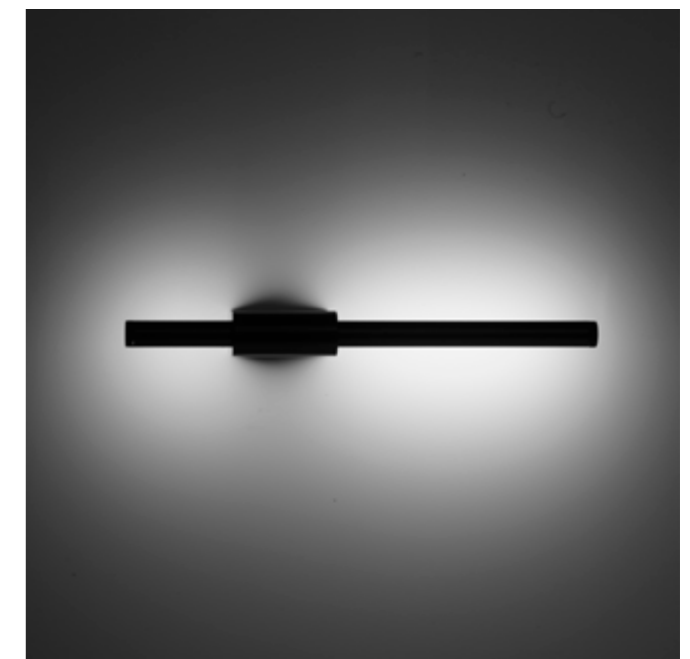
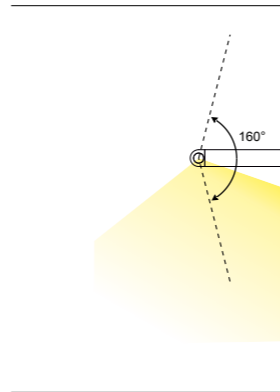
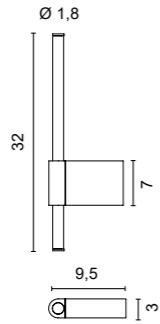

Codici finiture - *Finishes codes*



.01 **.02** **.25**





Diffusore non orientabile - Diffuser not orientable

4570 Lancia

- .01** Bianco - White
- .02** Nero - Black

Color temperature	LED Light source	lm source
/W 4000K	22,5W	2825lm
/WW 3000K	22,5W	2525lm
/XW 2700K	22,5W	2362lm



1,10 Kg

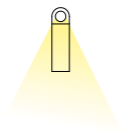
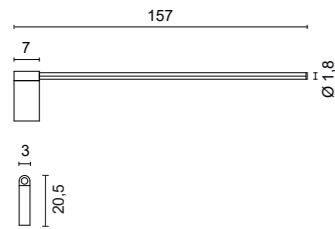

Codici finiture - Finishes codes



.01 **.02**



Diffusore non orientabile - Diffuser not orientable

5567 Lancia

- .01** Bianco - White
- .02** Nero - Black
- .31** Cromato lucido - Chromed

Color temperature	LED Light source	lm source
/W 4000K	9W	1130lm
/WW 3000K	9W	1010lm
/XW 2700K	9W	945lm



0,80 Kg

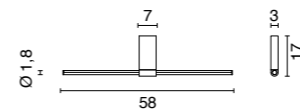

5568 Lancia

- .01** Bianco - White
- .02** Nero - Black
- .31** Cromato lucido - Chromed

Color temperature	LED Light source	lm source
/W 4000K	18W	2260lm
/WW 3000K	18W	2020lm
/XW 2700K	18W	1980lm



1,00 Kg

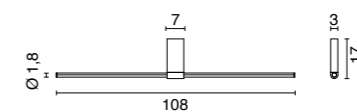

Art. 5567
Art. 5568

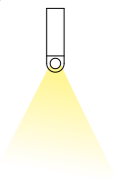

Codici finiture - Finishes codes

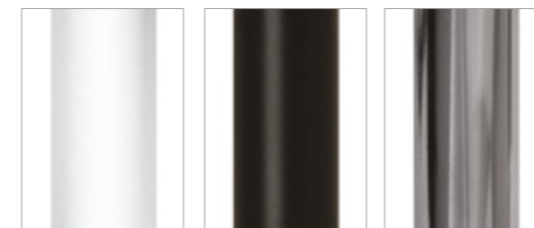

.01 **.02** **.31**





design **P. Peperè**
2017

Lampada da sospensione, scorrevole ed orientabile su cavo, a luce diffusa con corpo in trafilata di alluminio e diffusore in policarbonato opalino: un omaggio ad un'icona del design. La lampada è fornita con alimentatore su spina e interruttore dimmer touch con memoria integrato nel profilo.

Suspension lamp, sliding and adjustable on a cable, with diffused light with an aluminium drawn body and opal polycarbonate diffuser: a tribute to a design icon.

The lamp is supplied with driver on plug and touch dimmer switch with memory integrated in the profile.

Suspension coulissante et réglable sur câble, à lumière diffuse, avec corps en aluminium étiré et diffuseur en polycarbonate opalin: un hommage à une icône du design.

La lampe est fournie avec driver à brancher et un variateur tactile à mémoire intégré dans le profil.

Lámpara de suspensión, deslizante y orientable sobre cable, de luz difusa con cuerpo de aluminio trefilado y difusor de policarbonato opalino: un homenaje a un icono del diseño. La lámpara se suministra con driver enchufable y regulador de intensidad táctil con memoria integrado en el perfil.

An einem Kabel verschiebbare und verstellbare Hängeleuchte mit diffusem Licht mit gezogenem Aluminiumkörper und opalem Polycarbonatdiffusor: eine Hommage an eine Designikone. Die Leuchte wird mit einem Driver und einem in das Profil integrierten Touch-Dimmschalter mit Speicher geliefert.

Lancia di Achille



L'interruttore dimmer touch con memoria è integrato nel profilo
The dimmer-switch with memory is integrated in the stem



Particolare della lampada: il contrappeso
Detail of the lamp: the counterweight



La lampada scorre in verticale sul cavo e può essere orientata
The stem can move and be orientated along the vertical steel cable

1567 Lancia di Achille

.01 Bianco - White

.02 Nero - Black

.31 Cromato - Chromed

	Color temperature	LED Light source	lm source
/W	4000K	19,5W	2486lm
/WW	3000K	19,5W	2222lm
/XW	2700K	19,5W	2079lm

IP40 300 CM Dim S90 2,80 Kg

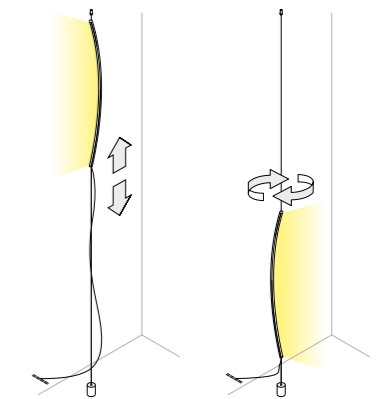
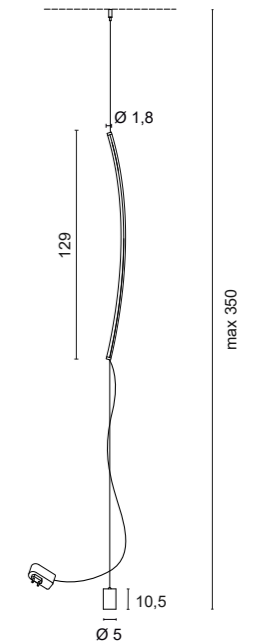

Codici finiture - Finishes codes



.01

.02

.31

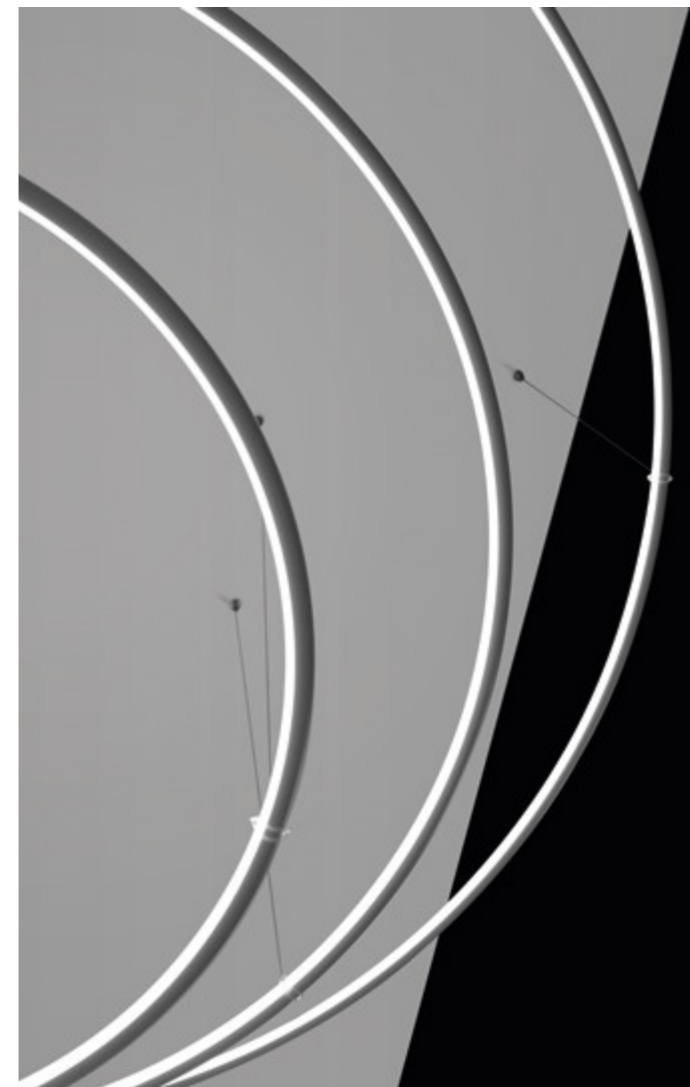

design P. Pepere
2017



Collezione di lampade a luce diffusa con corpo in trafilata di alluminio calandrata e diffusore in policarbonato opalino. Disponibile in varie tipologie, diverse misure e svariate finiture.

Collection of diffused light lamps with a calendered aluminium body and opal polycarbonate diffuser. Available in various types, sizes and finishes.

Collection de lampes à lumière diffuse avec un corps en aluminium calandré et un diffuseur en polycarbonate opalin. Disponibles en différents types, tailles et finitions.

Colección de lámparas de luz difusa con cuerpo de aluminio calandrado y difusor de policarbonato opalino. Disponible en varios tipos, tamaños y acabados.

Kollektion von Lampen mit diffusem Licht mit einem Gehäuse aus kalandriertem Aluminium und einem Diffusor aus opalem Polycarbonat. Erhältlich in verschiedenen Typen, Größen und Ausführungen.

Lancio

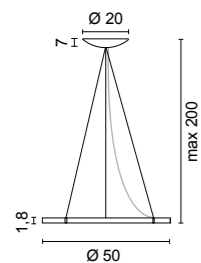

1566 Lancia Tonda

- .01** Bianco - *White*
- .02** Nero - *Black*
- .25** Dorato satinato - *Satin gold*
- .31** Cromato - *Chromed*
- .85** Verniciato argento - *Painted silver finishing*
- .86** Verniciato oro - *Painted gold finishing*
- .87** Verniciato rame - *Painted copper finishing*
- .88** Verniciato bronzo - *Painted bronze finishing*

	Color temperature	LED Light source	lm source
/W	4000K	27W	3390lm
/WW	3000K	27W	3030lm
/XW	2700K	27W	2835lm



1,20 Kg

Dimmerazione PUSH - 1...10V - DALI su richiesta
 PUSH - 1...10V - DALI dimming on request

1562 Lancia Tonda

- .01** Bianco - *White*
- .02** Nero - *Black*
- .25** Dorato satinato - *Satin gold*
- .31** Cromato - *Chromed*
- .85** Verniciato argento - *Painted silver finishing*
- .86** Verniciato oro - *Painted gold finishing*
- .87** Verniciato rame - *Painted copper finishing*
- .88** Verniciato bronzo - *Painted bronze finishing*

	Color temperature	LED Light source	lm source
/W	4000K	37,8W	4746lm
/WW	3000K	37,8W	4242lm
/XW	2700K	37,8W	3969lm



1,40 Kg

Dimmerazione PUSH - 1...10V - DALI su richiesta
 PUSH - 1...10V - DALI dimming on request

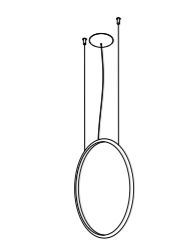
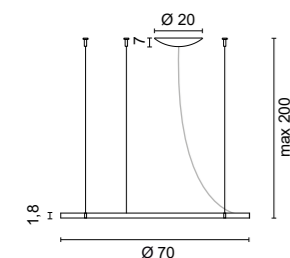

Installabile in verticale
 Can be installed vertically

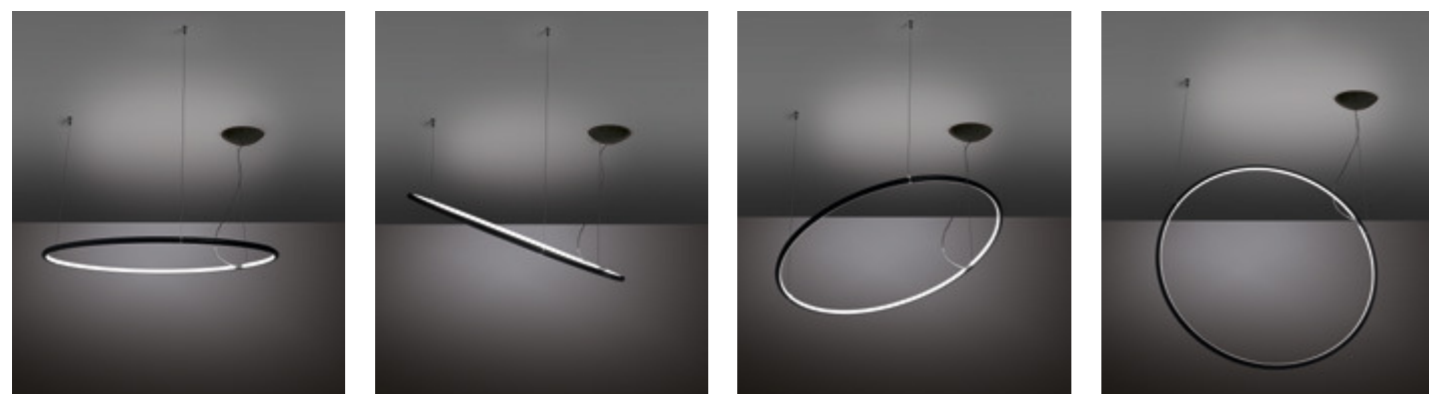

Codici finiture - *Finishes codes*

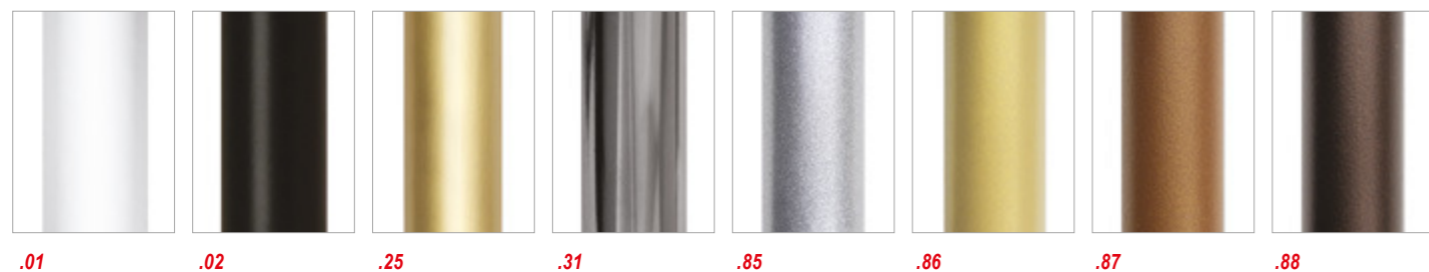

Optional



0536

Elemento di fissaggio per 3 cavi
 Fixing element for 3 cables
 Ø 1,7 cm - H 5 cm

- .01** Bianco - *White*
- .02** Nero - *Black*
- .25** Dorato satinato - *Satin gold*
- .31** Cromato lucido - *Chromed*



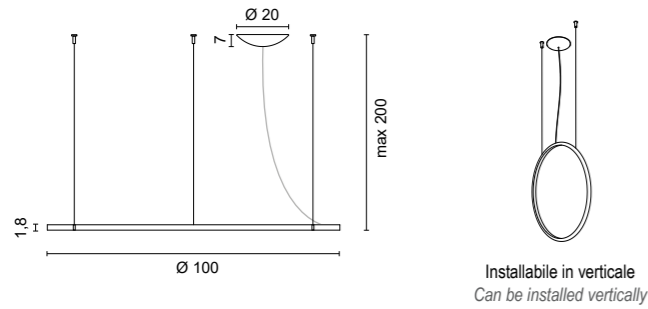

- 1563** Lancia Tonda
- .01** Bianco - *White*
 - .02** Nero - *Black*
 - .85** Verniciato argento - *Painted silver finishing*
 - .86** Verniciato oro - *Painted gold finishing*
 - .87** Verniciato rame - *Painted copper finishing*
 - .88** Verniciato bronzo - *Painted bronze finishing*

Color temperature	LED Light source	lm source
/W 4000K	54W	6780lm
/WW 3000K	54W	6060lm
/XW 2700K	54W	5670lm

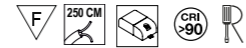

1,70 Kg

Dimmerazione PUSH - 1...10V - DALI su richiesta
 PUSH - 1...10V - DALI dimming on request

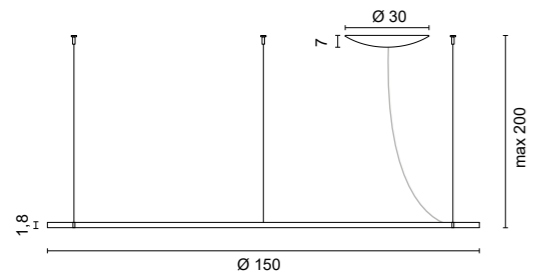

- 1564** Lancia Tonda
- .01** Bianco - *White*
 - .02** Nero - *Black*
 - .85** Verniciato argento - *Painted silver finishing*
 - .86** Verniciato oro - *Painted gold finishing*
 - .87** Verniciato rame - *Painted copper finishing*
 - .88** Verniciato bronzo - *Painted bronze finishing*

Color temperature	LED Light source	lm source
/W 4000K	81W	10170lm
/WW 3000K	81W	9090lm
/XW 2700K	81W	9505lm



2,50 Kg

Dimmer PUSH - 1...10V - DALI - TRIAC su richiesta
 PUSH - 1...10V - DALI - TRIAC dimming on request

Codici finiture - *Finishes codes*

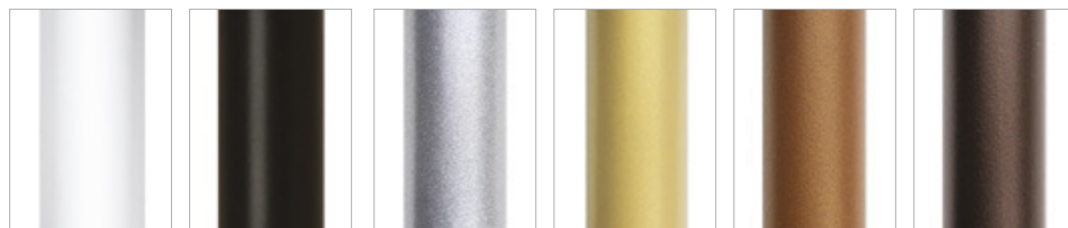

.01 **.02** **.85** **.86** **.87** **.88**

Optional



0536

Elemento di fissaggio per 3 cavi

Fixing element for 3 cables

Ø 1,7 cm - H 5 cm

- .01** Bianco - *White*
- .02** Nero - *Black*
- .25** Dorato satinato - *Satin gold*
- .31** Cromato lucido - *Chromed*





Lancia Tonda 1562 e 1563 sono installabili in verticale - Lancia Tonda 1562 and 1563 can be installed vertically





1575 Lancia Tonda XL

- .01** Bianco - White
- .02** Nero - Black

Color temperature	LED Light source	lm source
/W 4000K	67W	7660lm
/WW 3000K	67W	7140lm
/XW 2700K	67W	6720lm



Dimmer PUSH - 1...10V - DALI - TRIAC su richiesta
PUSH - 1...10V - DALI - TRIAC dimming on request

1576 Lancia Tonda XXL

- .01** Bianco - White
- .02** Nero - Black

Color temperature	LED Light source	lm source
/W 4000K	97W	10800lm
/WW 3000K	97W	10120lm
/XW 2700K	97W	9600lm



Dimmer PUSH - 1...10V - DALI - TRIAC su richiesta
PUSH - 1...10V - DALI - TRIAC dimming on request

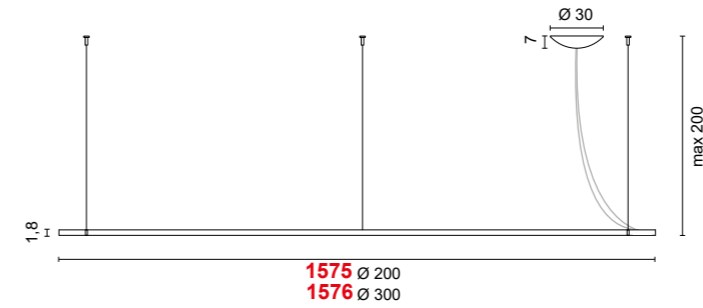

Lancia Tonda Ø 400 cm disponibile su richiesta - Lancia Tonda Ø 400 cm available on request

Schema di montaggio - Assembly scheme

La lampada viene fornita in 4 settori separati da assemblare in fase di installazione - The lamp is supplied in 4 separate sectors to be assembled during installation

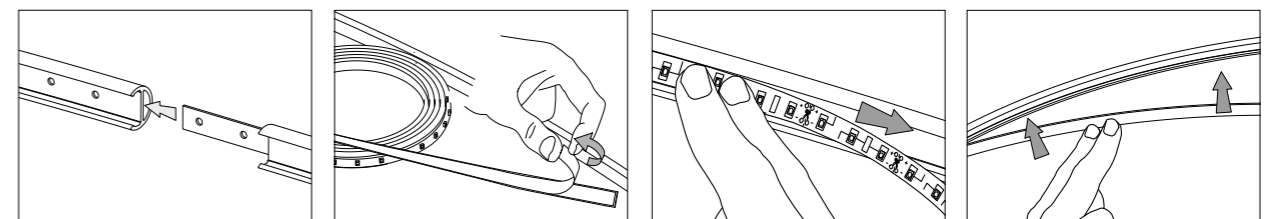
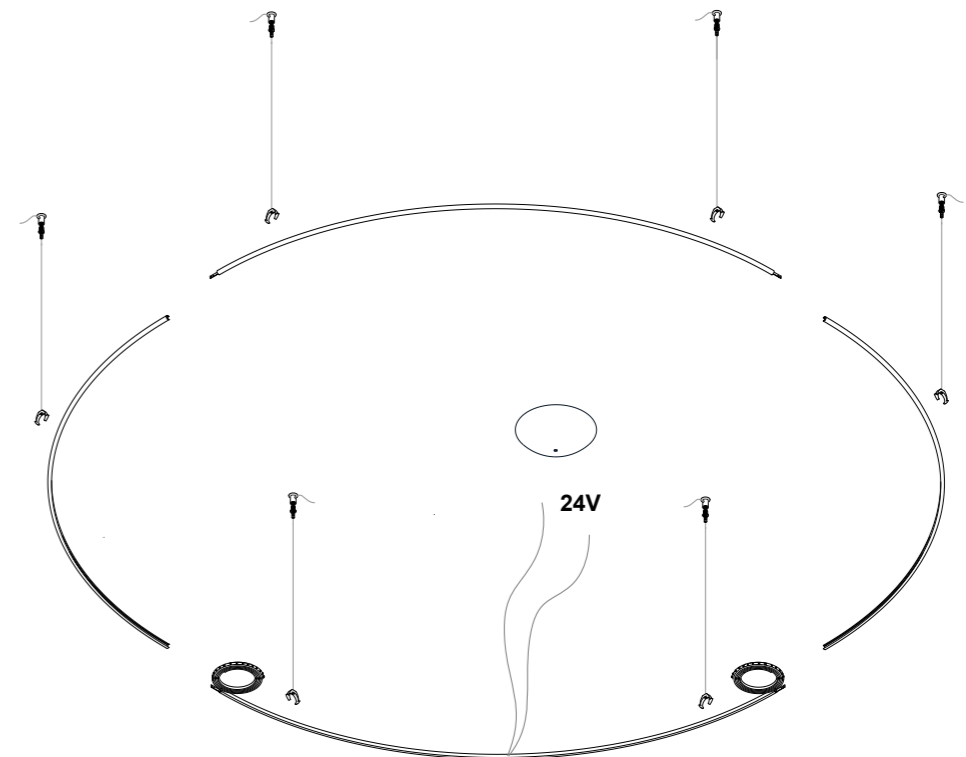

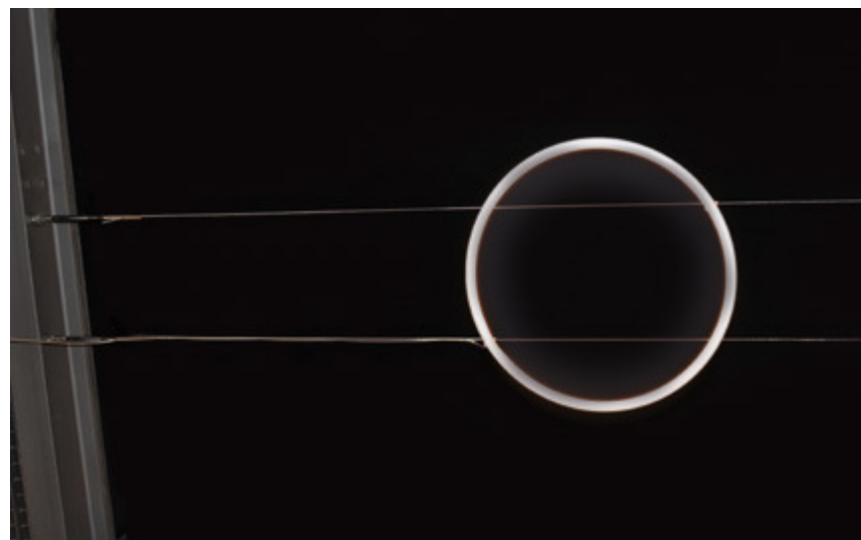

A1171 Lancia Tonda Cavo System

- .01** Bianco - *White*
- .02** Nero - *Black*
- .25** Dorato satinato - *Satin gold*
- .31** Cromato - *Chromed*

Color temperature	LED Light source	lm source
/W 4000K	18W	2260lm
/WW 3000K	18W	2020lm
/XW 2700K	18W	1890lm



0,40 Kg

Tenditori da ordinare separatamente
Tensors are to be ordered separately

A1172 Lancia Tonda Cavo System

- .01** Bianco - *White*
- .02** Nero - *Black*
- .25** Dorato satinato - *Satin gold*
- .31** Cromato - *Chromed*

Color temperature	LED Light source	lm source
/W 4000K	27W	3390lm
/WW 3000K	27W	3030lm
/XW 2700K	27W	2835lm



0,50 Kg

Tenditori da ordinare separatamente
Tensors are to be ordered separately

A1173 Lancia Tonda Cavo System

- .01** Bianco - *White*
- .02** Nero - *Black*
- .25** Dorato satinato - *Satin gold*
- .31** Cromato - *Chromed*

Color temperature	LED Light source	lm source
/W 4000K	37,5W	4633lm
/WW 3000K	37,5W	4141lm
/XW 2700K	37,5W	3874lm



0,80 Kg

Tenditori da ordinare separatamente
Tensors are to be ordered separately

Accessori - *Accessories*



0970.31

4 tenditori cromati con 2 cavi di acciaio
lunghezza 6 mt
4 chromed brass tensors
with s steel cables length 6 mt

0970.31/10

4 tenditori cromati con 2 cavi di acciaio
lunghezza 10 mt
4 chromed brass tensors
with 2 steel cables length 10 mt

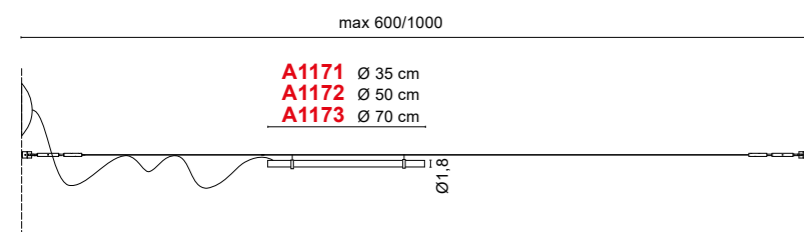

A1172

Lancia Tonda Cavo System Ø 50 senza rosone
Lancia Tonda Cavo System Ø 50 without ceiling rose

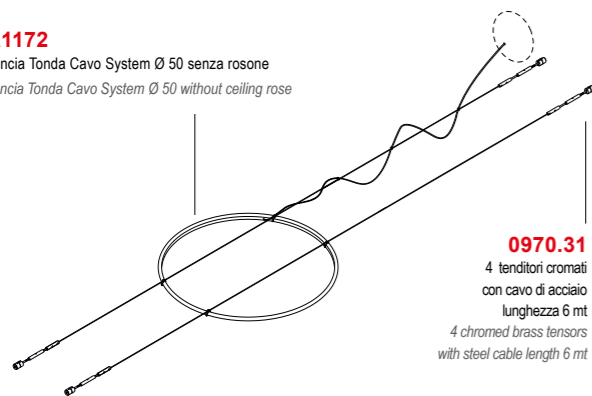

0970.31

4 tenditori cromati
con cavo di acciaio
lunghezza 6 mt
4 chromed brass tensors
with steel cable length 6 mt

0970.31/10

4 tenditori cromati
con cavo di acciaio
lunghezza 10 mt
4 chromed brass tensors
with steel cable length 10 mt

Codici finiture - *Finishes codes*

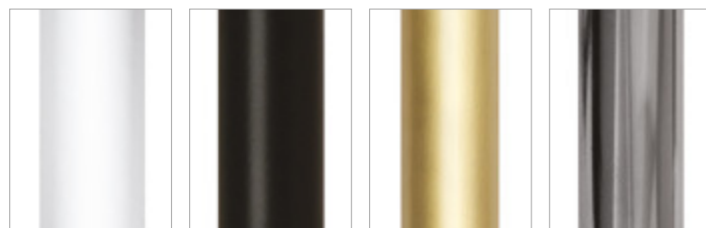

.01 **.02** **.25** **.31**



Rosoni con alimentatori da ordinare separatamente (p. 247) - *Ceiling roses with drivers are to be ordered separately (p. 247)*



LED source 24V-18W/mt
 Lunghezza del cavo elettrico 250 cm - Electric cable length 250 cm

CUSTOM SIZE Tabella lunghezze disponibili - Table of available lengths

Codice - Code	Ø cm	watt	Finitura - Finishes	2700K - lm source	3000K - lm source	4000K - lm source
A1566	50	27	.01 Bianco - White	/XW 2835	/WWW 3030	/W 3390
A1566	50	27	.02 Nero - Black	/XW 2835	/WWW 3030	/W 3390
A1566	50	27	.25 Dorato satinato - Satin gold	/XW 2835	/WWW 3030	/W 3390
A1566	50	27	.31 Cromato - Chromed	/XW 2835	/WWW 3030	/W 3390
A1566	50	27	.85 Verniciato argento - Painted silver finishing	/XW 2835	/WWW 3030	/W 3390
A1566	50	27	.86 Verniciato oro - Painted gold finishing	/XW 2835	/WWW 3030	/W 3390
A1566	50	27	.87 Verniciato rame - Painted copper finishing	/XW 2835	/WWW 3030	/W 3390
A1566	50	27	.88 Verniciato bronzo - Painted bronze finishing	/XW 2835	/WWW 3030	/W 3390
A1562	70	37,8	.01 Bianco - White	/XW 3969	/WWW 4242	/W 4776
A1562	70	37,8	.02 Nero - Black	/XW 3969	/WWW 4242	/W 4776
A1562	70	37,8	.25 Dorato satinato - Satin gold	/XW 3969	/WWW 4242	/W 4776
A1562	70	37,8	.31 Cromato - Chromed	/XW 3969	/WWW 4242	/W 4776
A1562	70	37,8	.85 Verniciato argento - Painted silver finishing	/XW 3969	/WWW 4242	/W 4776
A1562	70	37,8	.86 Verniciato oro - Painted gold finishing	/XW 3969	/WWW 4242	/W 4776
A1562	70	37,8	.87 Verniciato rame - Painted copper finishing	/XW 3969	/WWW 4242	/W 4776
A1562	70	37,8	.88 Verniciato bronzo - Painted bronze finishing	/XW 3969	/WWW 4242	/W 4776
A1563	100	54	.01 Bianco - White	/XW 5670	/WWW 6060	/W 6780
A1563	100	54	.02 Nero - Black	/XW 5670	/WWW 6060	/W 6780
A1563	100	54	.85 Verniciato argento - Painted silver finishing	/XW 5670	/WWW 6060	/W 6780
A1563	100	54	.86 Verniciato oro - Painted gold finishing	/XW 5670	/WWW 6060	/W 6780
A1563	100	54	.87 Verniciato rame - Painted copper finishing	/XW 5670	/WWW 6060	/W 6780
A1563	100	54	.88 Verniciato bronzo - Painted bronze finishing	/XW 5670	/WWW 6060	/W 6780
A1564	150	81	.01 Bianco - White	/XW 8505	/WWW 9090	/W 10170
A1564	150	81	.02 Nero - Black	/XW 8505	/WWW 9090	/W 10170
A1564	150	81	.85 Verniciato argento - Painted silver finishing	/XW 8505	/WWW 9090	/W 10170
A1564	150	81	.86 Verniciato oro - Painted gold finishing	/XW 8505	/WWW 9090	/W 10170
A1564	150	81	.87 Verniciato rame - Painted copper finishing	/XW 8505	/WWW 9090	/W 10170
A1564	150	81	.88 Verniciato bronzo - Painted bronze finishing	/XW 8505	/WWW 9090	/W 10170



Kit di fissaggio da ordinare separatamente - Fixing kit to be ordered separately

Esempi di installazioni multiple a pag. 248 - Examples of multiple installations on page 248

Codici finiture - Finishes codes

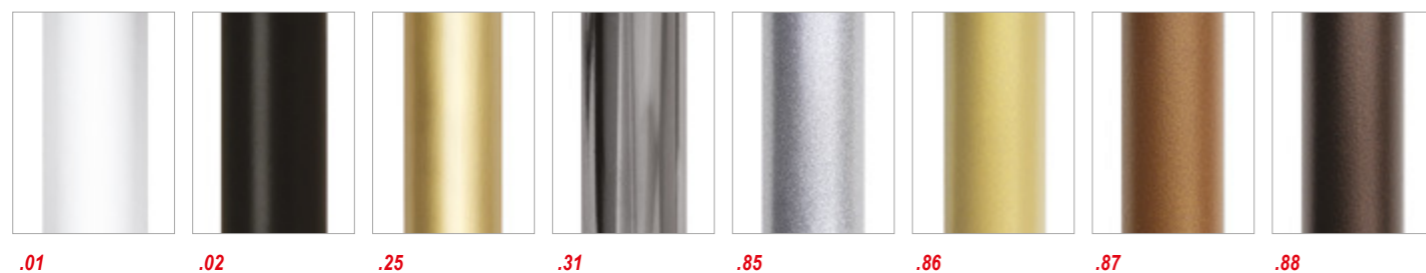

Rosoni con alimentatori da ordinare separatamente (p. 247) - Ceiling roses with drivers are to be ordered separately (p. 247)

Rosoni - Ceiling rose



50/60Hz 220-230V - 60W

ROSONE COMPLETO DI DRIVER 60W
 CEILING ROSE WITH DRIVER 60W

Code	W	Codici finiture - Finishes codes
0990/60	60W	.01 Bianco - White
0990/60	60W	.02 Nero - Black
0990/60	60W	.85 Verniciato argento - Painted silver finishing
0990/60	60W	.86 Verniciato oro - Painted gold finishing
0990/60	60W	.87 Verniciato rame - Painted copper finishing
0990/60	60W	.88 Verniciato bronzo - Painted bronze finishing

DIMMERAZIONE DIMMING

PUHM	1...10 V	0-10V	TRIAC
/P	/N	/D	/I
/P	/N	/D	/I
/P	/N	/D	/I
/P	/N	/D	/I
/P	/N	/D	/I
/P	/N	/D	/I

0,60 Kg



50/60Hz 220-230V - 100W

ROSONE COMPLETO DI DRIVER 100W
 CEILING ROSE WITH DRIVER 100W

Code	W	Codici finiture - Finishes codes
0990/100	100W	.01 Bianco - White
0990/100	100W	.02 Nero - Black
0990/100	100W	.85 Verniciato argento - Painted silver finishing
0990/100	100W	.86 Verniciato oro - Painted gold finishing
0990/100	100W	.87 Verniciato rame - Painted copper finishing
0990/100	100W	.88 Verniciato bronzo - Painted bronze finishing

DIMMERAZIONE DIMMING

PUHM	1...10 V	0-10V	TRIAC
/P	/N	/D	/I
/P	/N	/D	/I
/P	/N	/D	/I
/P	/N	/D	/I
/P	/N	/D	/I
/P	/N	/D	/I

1,30 Kg



50/60Hz 220-230V - 150W

ROSONE COMPLETO DI DRIVER 150W
 CEILING ROSE WITH DRIVER 150W

Code	W	Codici finiture - Finishes codes
0990/150	150W	.01 Bianco - White
0990/150	150W	.02 Nero - Black
0990/150	150W	.85 Verniciato argento - Painted silver finishing
0990/150	150W	.86 Verniciato oro - Painted gold finishing
0990/150	150W	.87 Verniciato rame - Painted copper finishing
0990/150	150W	.88 Verniciato bronzo - Painted bronze finishing

DIMMERAZIONE DIMMING

PUHM	1...10 V	0-10V	TRIAC
/P	/N	/D	/I
/P	/N	/D	/I
/P	/N	/D	/I
/P	/N	/D	/I
/P	/N	/D	/I
/P	/N	/D	/I

1,30 Kg



50/60Hz 220-230V - 200W

ROSONE COMPLETO DI DRIVER 200W (2x100W)
 CEILING ROSE WITH DRIVER 200W (2x100W)

Code	W	Codici finiture - Finishes codes
0990/200	200W	.01 Bianco - White
0990/200	200W	.02 Nero - Black
0990/200	200W	.85 Verniciato argento - Painted silver finishing
0990/200	200W	.86 Verniciato oro - Painted gold finishing
0990/200	200W	.87 Verniciato rame - Painted copper finishing
0990/200	200W	.88 Verniciato bronzo - Painted bronze finishing

DIMMERAZIONE DIMMING

PUHM	1...10 V	0-10V	TRIAC
/P	/N	/D	/I
/P	/N	/D	/I
/P	/N	/D	/I
/P	/N	/D	/I
/P	/N	/D	/I
/P	/N	/D	/I

2,00 Kg

La scelta del rosone è determinata dalla somma delle potenze delle singole lampade - The choice of the ceiling rose depends on total power consumption

Elementi di sistema per attacchi multipli - System elements for multiple attacks

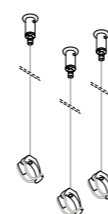

0991/A

Kit fissaggio singola lampada - Single lamp cable kit

- 3 Cavi acciaio 2 mt - 3 Steel cables 2 mt
- 3 Decentratori fissaggio cavo - 3 Element for cable fixing
- 3 Clip reggi lampada - 3 Suspension clips

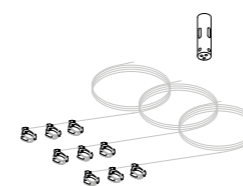

0991/B

Kit fissaggio 3 lampade - 3 lamps cable kit

- 3 Cavi acciaio 4 mt - 3 Steel cables 4 mt
- 1 Decentratore fissaggio cavi - 1 Displacement element for cable fixing
- 3 Clip reggi lampada - 3 Suspension clips

Esempi di composizioni con kit di fissaggio singole lampade, la scelta del rosone è determinata dalla somma delle potenze delle singole lampade
 Examples of compositions with individual lamps fixing kits, the choice of the ceiling rose depends on total power consumption

Kit fissaggio singola lampada
 Single lamp cable kit

- 0991/A**
 3 Cavi acciaio 2 mt
 3 Decentratori fissaggio cavo
 3 Clip reggi lampada

- 3 Stell cables 2 mt
 3 Element for cable fixing
 3 Suspension clips

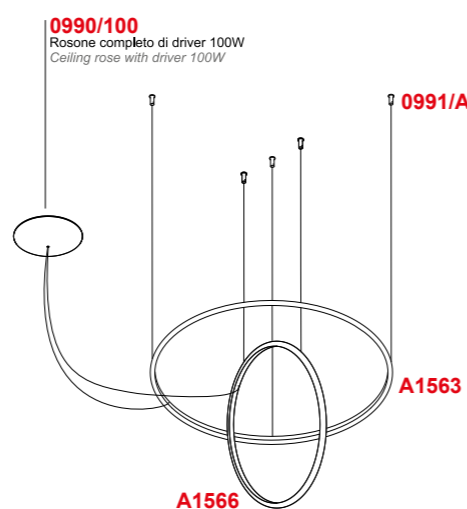
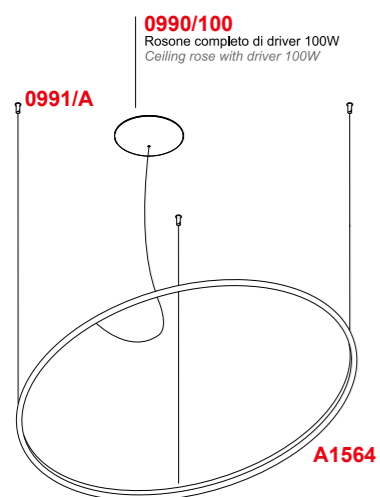
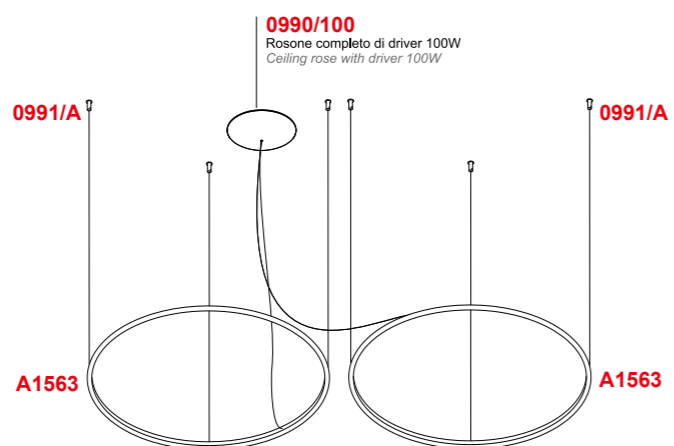

Esempi di composizioni con kit di fissaggio con 3 lampade, la scelta del rosone è determinata dalla somma delle potenze delle singole lampade
 Examples of compositions with 3 lamps fixing kits the choice of the ceiling rose depends on total power consumption

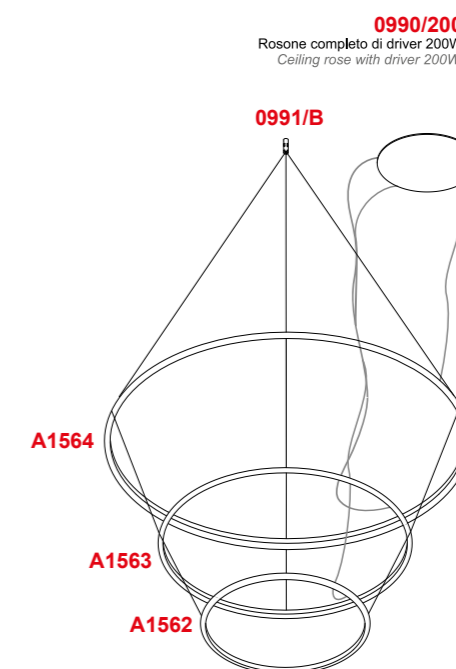
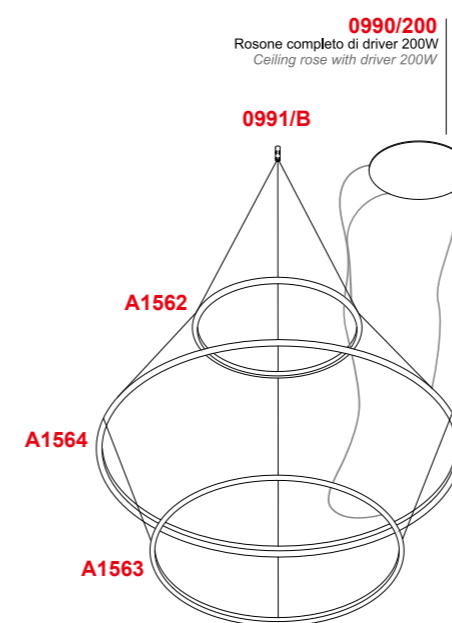
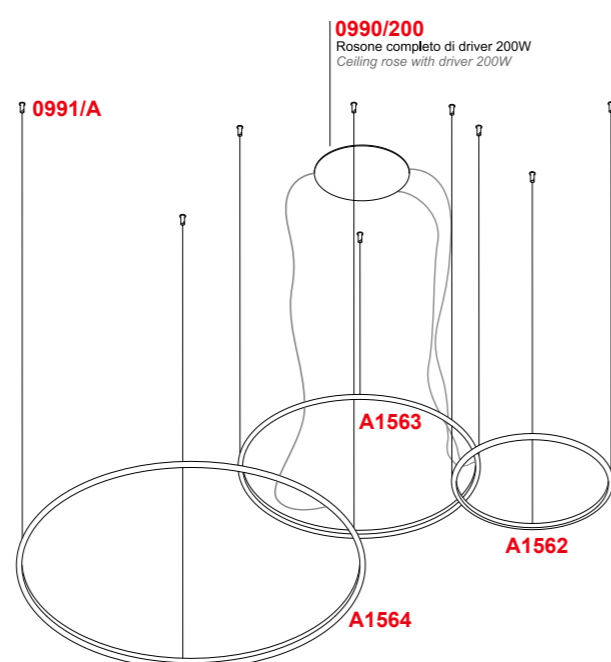
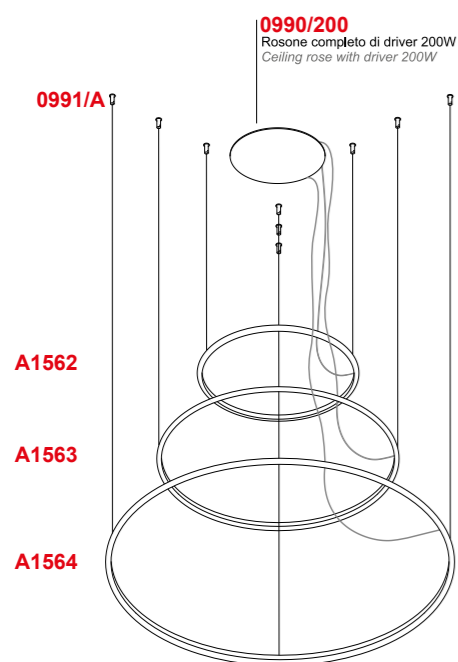

Kit fissaggio 3 lampade
 3 lamps cable kit

- 0991/B**
 3 Cavi acciaio 4 mt
 1 Decentratore fissaggio cavi
 3 Clip reggi lampada
 3 Stell cables 4 mt
 1 Displacement element for cable fixing
 3 Suspension clips

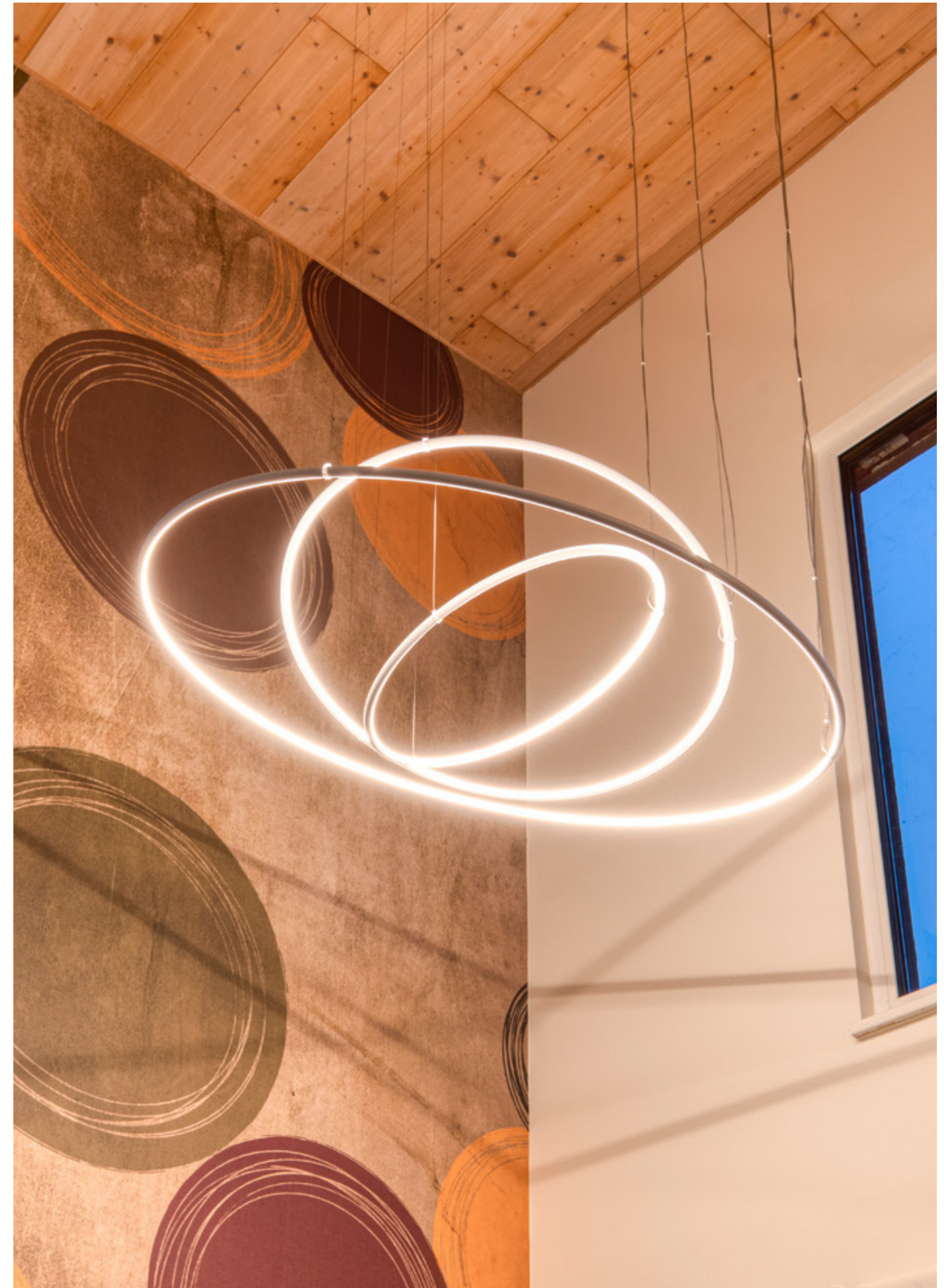



2513 Lancia

- .01** Bianco - *White*
- .02** Nero - *Black*
- .25** Dorato satinato - *Golded satin*
- .31** Cromato lucido - *Chromed*

Color temperature	LED Light source	lm source
/W 4000K	9,6W	1080lm
/WW 3000K	9,6W	1020lm
/XW 2700K	9,6W	960lm

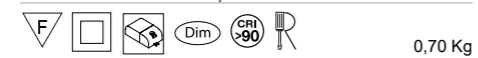

Completa di PUSH DIMMER su cavo
With PUSH DIMMER on cable

0,70 Kg

2514 Lancia

- .01** Bianco - *White*
- .02** Nero - *Black*
- .25** Dorato satinato - *Golded satin*
- .31** Cromato lucido - *Chromed*

Color temperature	LED Light source	lm source
/W 4000K	14W	1620lm
/WW 3000K	14W	1530lm
/XW 2700K	14W	1440lm



Completa di PUSH DIMMER su cavo
With PUSH DIMMER on cable

1,00 Kg



Codici finiture - *Finishes codes*

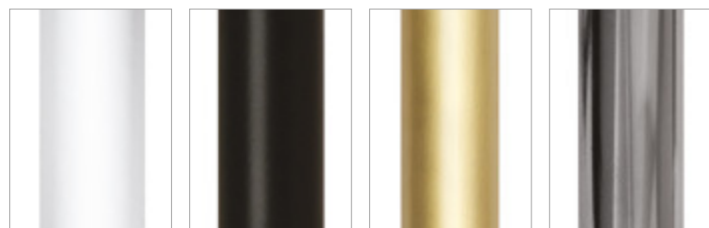

.01

.02

.25

.31



3513 Lancia Tonda

- .01** Bianco - *White*
- .02** Nero - *Black*
- .25** Dorato satinato - *Golded satin*
- .31** Cromato lucido - *Chromed*

Color temperature	LED Light source	lm source
/W 4000K	20W	2268lm
/WW 3000K	20W	2142lm
/XW 2700K	20W	2016lm

Completa di PUSH DIMMER su cavo
With PUSH DIMMER on cable

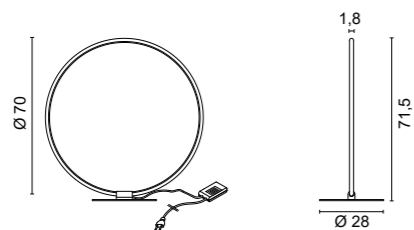

3514 Lancia Tonda

- .01** Bianco - *White*
- .02** Nero - *Black*

Color temperature	LED Light source	lm source
/W 4000K	29W	3240lm
/WW 3000K	29W	3060lm
/XW 2700K	29W	2880lm

Completa di PUSH DIMMER su cavo
With PUSH DIMMER on cable

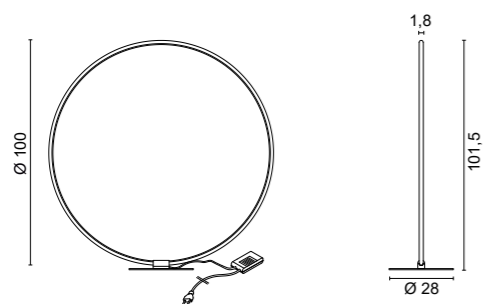

3515 Lancia Tonda

- .01** Bianco - *White*
- .02** Nero - *Black*

Color temperature	LED Light source	lm source
/W 4000K	43W	4860lm
/WW 3000K	43W	4590lm
/XW 2700K	43W	4224lm

Completa di PUSH DIMMER su cavo
With PUSH DIMMER on cable

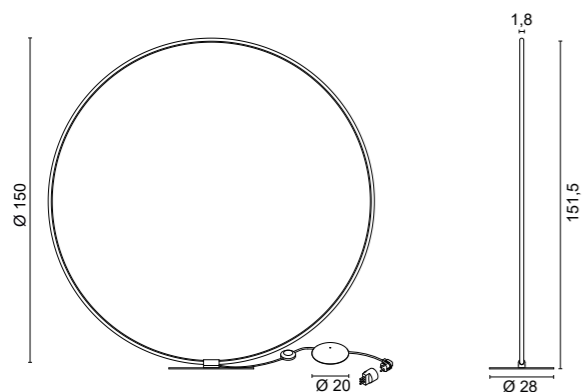

Codici finiture - *Finishes codes*

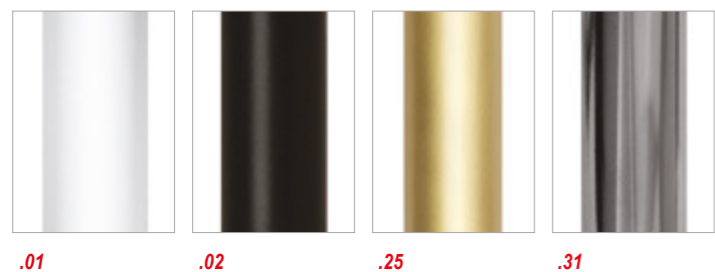

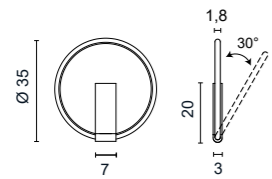

4605 Lancia Tonda

- .01** Bianco - *White*
- .02** Nero - *Black*
- .25** Dorato satinato - *Satin gold*
- .31** Cromato - *Chromed*
- .85** Verniciato argento - *Painted silver finishing*
- .86** Verniciato oro - *Painted gold finishing*
- .87** Verniciato rame - *Painted copper finishing*
- .88** Verniciato bronzo - *Painted bronze finishing*

Color temperature	LED Light source	lm source
/W 4000K	18W	2260lm
/WW 3000K	18W	2020lm
/XW 2700K	18W	1890lm



0,75 Kg

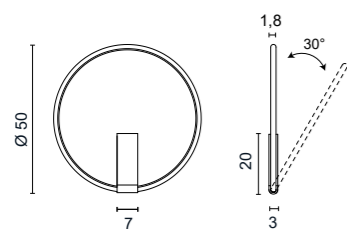

4606 Lancia Tonda

- .01** Bianco - *White*
- .02** Nero - *Black*
- .25** Dorato satinato - *Satin gold*
- .31** Cromato - *Chromed*
- .85** Verniciato argento - *Painted silver finishing*
- .86** Verniciato oro - *Painted gold finishing*
- .87** Verniciato rame - *Painted copper finishing*
- .88** Verniciato bronzo - *Painted bronze finishing*

Color temperature	LED Light source	lm source
/W 4000K	27W	3390lm
/WW 3000K	27W	3030lm
/XW 2700K	27W	2835lm



1,10 Kg

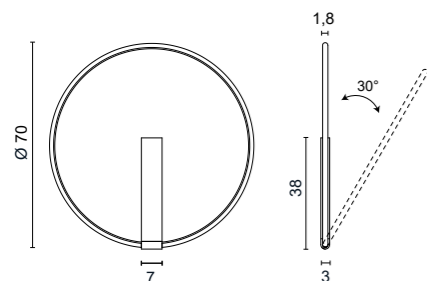

4607 Lancia Tonda

- .01** Bianco - *White*
- .02** Nero - *Black*
- .25** Dorato satinato - *Satin gold*
- .31** Cromato - *Chromed*
- .85** Verniciato argento - *Painted silver finishing*
- .86** Verniciato oro - *Painted gold finishing*
- .87** Verniciato rame - *Painted copper finishing*
- .88** Verniciato bronzo - *Painted bronze finishing*

Color temperature	LED Light source	lm source
/W 4000K	36W	4520lm
/WW 3000K	36W	4040lm
/XW 2700K	36W	3780lm



2,30 Kg

Dimmerabile PUSH - 1...10V - DALI su richiesta
Dimmable PUSH - 1...10V - DALI on request

Codici finiture - *Finishes codes*

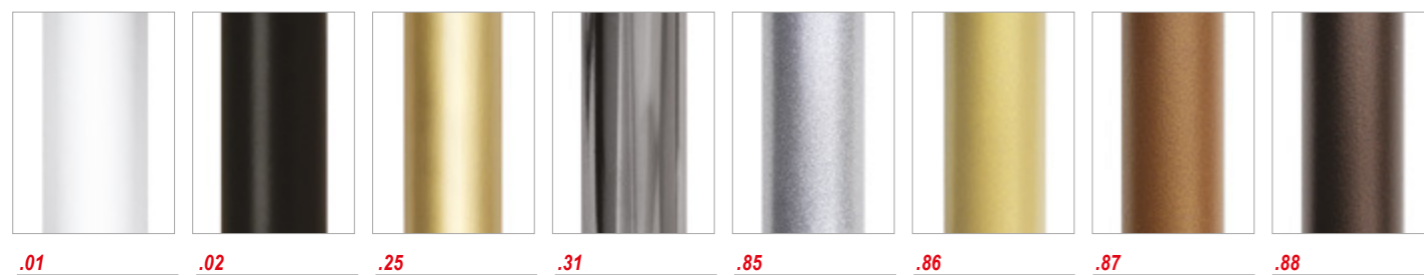



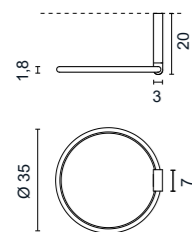

5602 Lancia Tonda

- .01** Bianco - *White*
- .02** Nero - *Black*
- .25** Dorato satinato - *Satin gold*
- .31** Cromato - *Chromed*
- .85** Verniciato argento - *Painted silver finishing*
- .86** Verniciato oro - *Painted gold finishing*
- .87** Verniciato rame - *Painted copper finishing*
- .88** Verniciato bronzo - *Painted bronze finishing*

Color temperature	LED Light source	lm source
/W 4000K	18W	2260lm
/WW 3000K	18W	2020lm
/XW 2700K	18W	1890lm



0,75 Kg

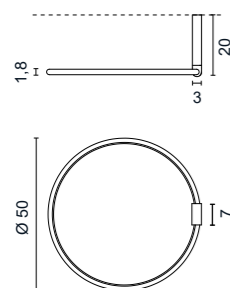

5603 Lancia Tonda

- .01** Bianco - *White*
- .02** Nero - *Black*
- .25** Dorato satinato - *Satin gold*
- .31** Cromato - *Chromed*
- .85** Verniciato argento - *Painted silver finishing*
- .86** Verniciato oro - *Painted gold finishing*
- .87** Verniciato rame - *Painted copper finishing*
- .88** Verniciato bronzo - *Painted bronze finishing*

Color temperature	LED Light source	lm source
/W 4000K	27W	3390lm
/WW 3000K	27W	3030lm
/XW 2700K	27W	2835lm



1,10 Kg

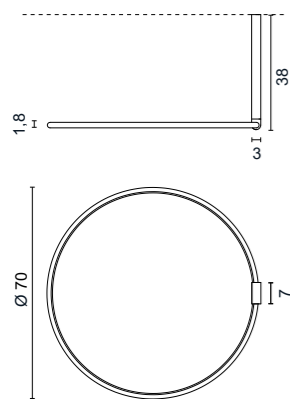

5604 Lancia Tonda

- .01** Bianco - *White*
- .02** Nero - *Black*
- .25** Dorato satinato - *Satin gold*
- .31** Cromato - *Chromed*
- .85** Verniciato argento - *Painted silver finishing*
- .86** Verniciato oro - *Painted gold finishing*
- .87** Verniciato rame - *Painted copper finishing*
- .88** Verniciato bronzo - *Painted bronze finishing*

Color temperature	LED Light source	lm source
/W 4000K	36W	4520lm
/WW 3000K	36W	4040lm
/XW 2700K	36W	3780lm



2,30 Kg

Dimmerabile PUSH - 1...10V - DALI su richiesta
Dimmable PUSH - 1...10V - DALI on request

Codici finiture - *Finishes codes*

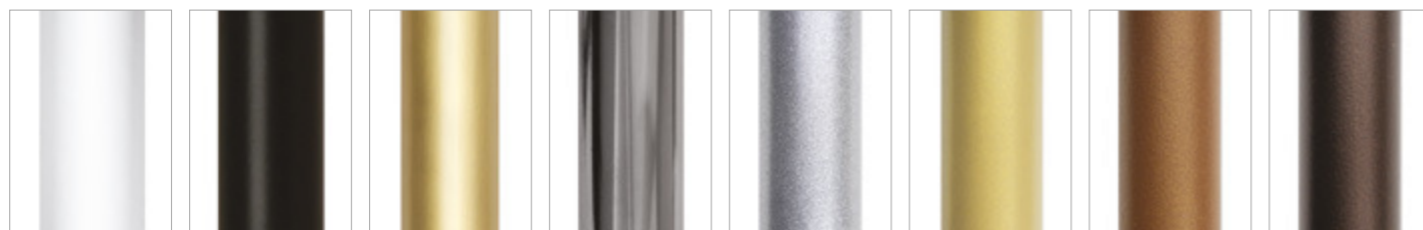

.01 **.02** **.25** **.31** **.85** **.86** **.87** **.88**

Optional



0995

Piastra per installazione accoppiata
Plate for coupled installation

Ø 9,5 cm - H 3,5 cm 0,20 Kg

- .01** Bianco - *White*
- .02** Nero - *Black*

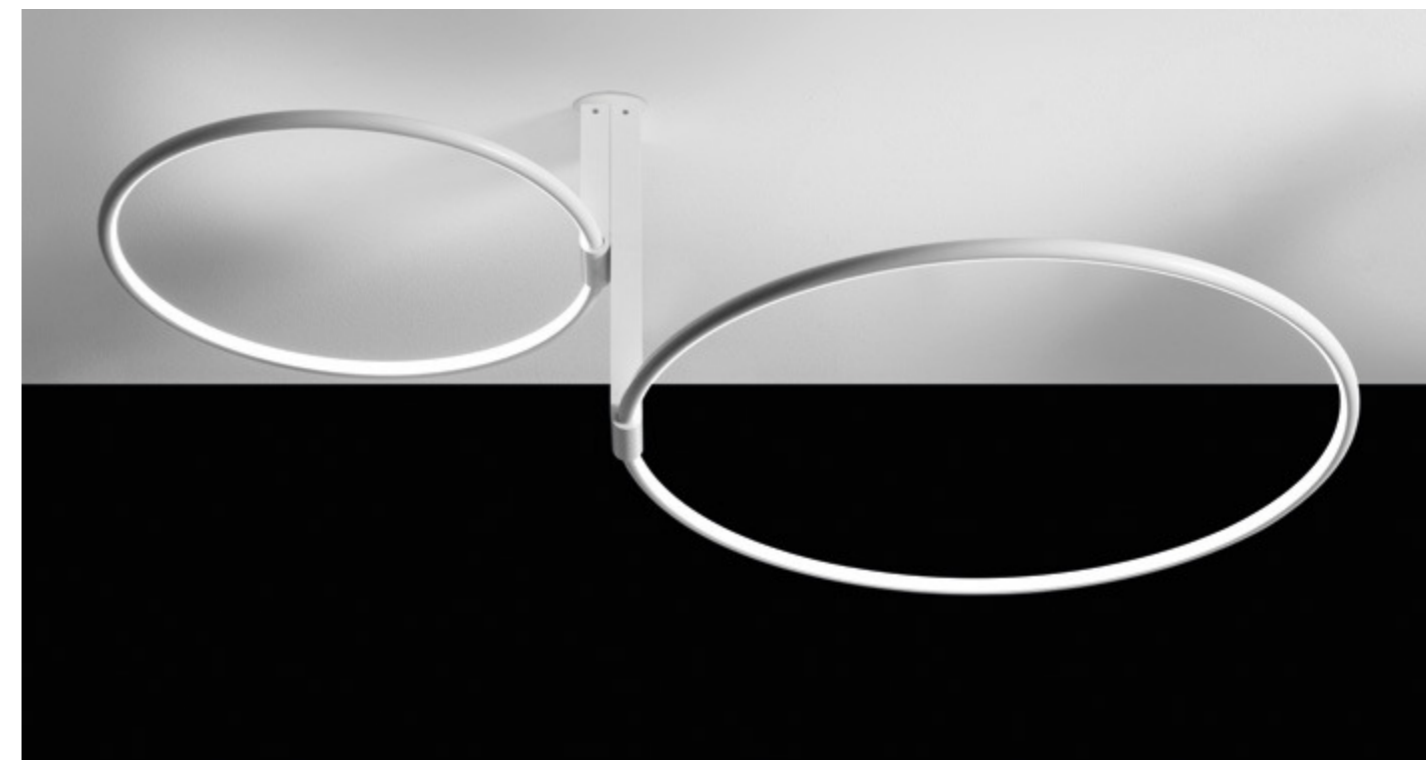

Esempio di installazione con optional art. 0995.01 - *Example of installation with art. 0995.01*



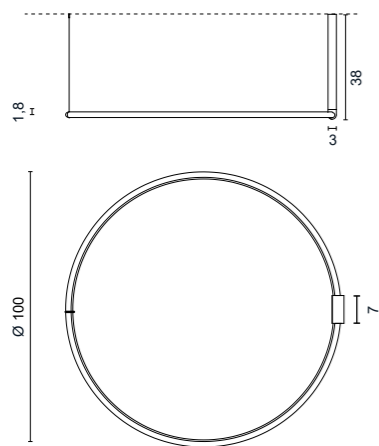

5605 Lancia Tonda

- .01** Bianco - *White*
- .02** Nero - *Black*
- .85** Verniciato argento - *Painted silver finishing*
- .86** Verniciato oro - *Painted gold finishing*
- .87** Verniciato rame - *Painted copper finishing*
- .88** Verniciato bronzo - *Painted bronze finishing*

Color temperature	LED Light source	lm source
/W 4000K	54W	6780lm
/WW 3000K	54W	6060lm
/XW 2700K	54W	5670lm



Dimmerabile PUSH - 1...10V - DALI su richiesta
 Dimmable PUSH - 1...10V - DALI on request



Optional



0995

Piastra per installazione accoppiata
 Plate for coupled installation

Ø 9,5 cm - H 3,5 cm 0,20 Kg

- .01** Bianco - *White*
- .02** Nero - *Black*



Codici finiture - *Finishes codes*

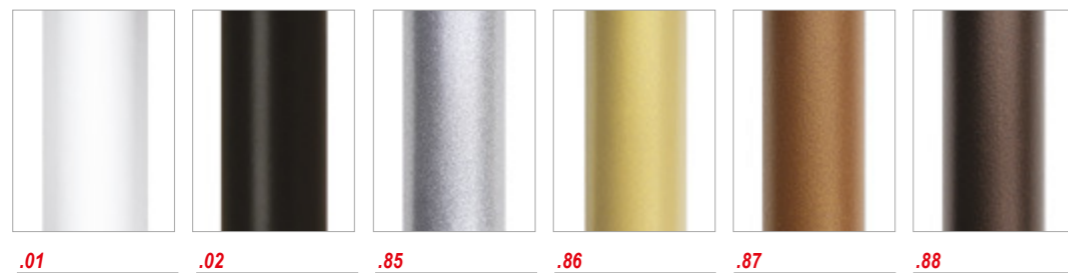

Aggancio a plafone in dotazione alla Lancia Tonda 5605
 Ceiling hook provided with Lancia Tonda 5605



design **ABS Studio**
2017

267 268

Famiglia di lampade a sospensione e da plafone a luce diffusa con paralume circolare in tessuto e PVC autoestinguente, struttura in alluminio, diffusore in policarbonato opalino e alimentatore integrato. Disponibile in varie misure e diverse finiture.

Family of pendant and ceiling lamps providing diffused light with circular shade made of fabric and self-extinguishing PVC, aluminium structure, opal polycarbonate diffuser and integrated driver. Available in various sizes and finishes.

Famille de lampes suspendues et de plafonniers à lumière diffuse avec abat-jour circulaire en tissu auto-extinguible et PVC, structure en aluminium, diffuseur en polycarbonate opale et driver intégré. Disponible en différentes tailles et finitions.

Familia de lámparas de suspensión y techo de luz difusa con pantalla circular de tejido autoextinguible y PVC, estructura de aluminio, difusor de policarbonato opalino y driver integrado. Disponible en varios tamaños y acabados.

Familie von Pendel- und Deckenleuchten für diffuses Licht mit kreisförmigem Schirm aus selbstverlöschendem Stoff und PVC, Aluminiumrahmen, opalem Polycarbonatdiffusor und integriertem Driver. Erhältlich in verschiedenen Größen und Ausführungen.

Raddor

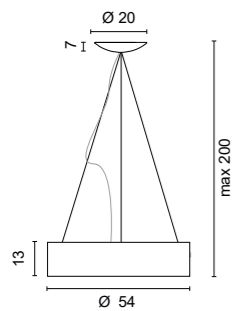

1572 Radar

- .01** Bianco - *White*
- .02.01** Nero, interno bianco - *Black, white inside*
- .02.21** Nero, interno dorato lucido - *Black, shiny gold inside*

Color temperature	LED Light source	lm source
/W 4000K	27W	3390lm
/WW 3000K	27W	3030lm
/XW 2700K	27W	2835lm



1,80 Kg

Dimmerabile PUSH - 1...10V - DALI su richiesta
 Dimmable PUSH - 1...10V - DALI on request

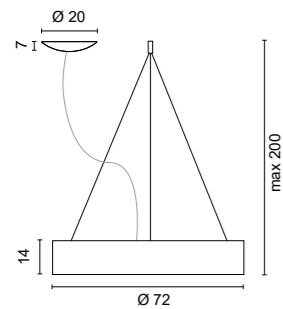

1570 Radar

- .01** Bianco - *White*
- .02.01** Nero, interno bianco - *Black, white inside*
- .02.21** Nero, interno dorato lucido - *Black, shiny gold inside*

Color temperature	LED Light source	lm source
/W 4000K	37,8W	4746lm
/WW 3000K	37,8W	4242lm
/XW 2700K	37,8W	3969lm



2,50 Kg

Dimmerabile PUSH - 1...10V - DALI su richiesta
 Dimmable PUSH - 1...10V - DALI on request

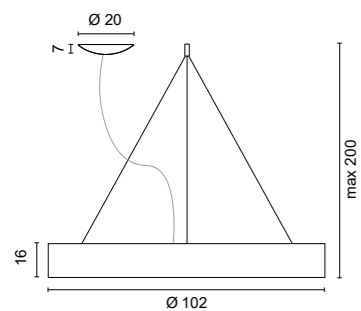

1571 Radar

- .01** Bianco - *White*
- .02.01** Nero, interno bianco - *Black, white inside*
- .02.21** Nero, interno dorato lucido - *Black, shiny gold inside*

Color temperature	LED Light source	lm source
/W 4000K	54W	6780lm
/WW 3000K	54W	6060lm
/XW 2700K	54W	5670lm

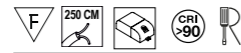

3,00 Kg

Dimmerabile PUSH - 1...10V - DALI su richiesta
 Dimmable PUSH - 1...10V - DALI on request

Codici finiture - *Finishes codes*



.01 **.02.01** **.02.21**

Optional solo per Radar 1572 - *Optional only for Radar 1572*



0536

Elemento di fissaggio per 3 cavi
Fixing element for 3 cables

Ø 1,7 cm - H 5 cm

- .01** Bianco - *White*
- .02** Nero - *Black*
- .25** Dorato satinato - *Satin gold*
- .31** Cromato lucido - *Chromed*



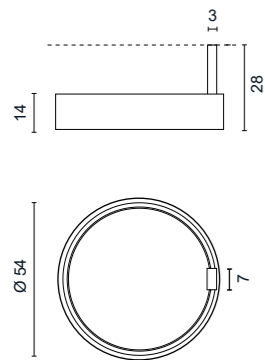

5607 Radar

- .01** Bianco - *White*
- .02.01** Nero, interno bianco - *Black, white inside*
- .02.21** Nero, interno dorato lucido - *Black, shiny gold inside*

Color temperature	LED Light source	lm source
/W 4000K	27W	3390lm
/WW 3000K	27W	3030lm
/XW 2700K	27W	2835lm





1,80 Kg

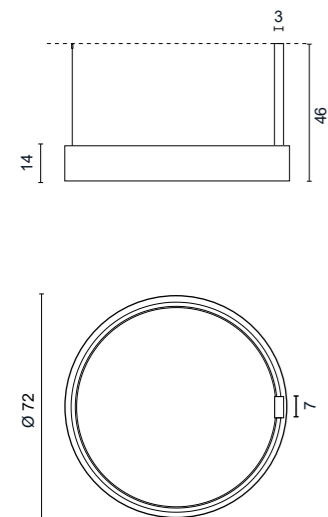

5608 Radar

- .01** Bianco - *White*
- .02.01** Nero, interno bianco - *Black, white inside*
- .02.21** Nero, interno dorato lucido - *Black, shiny gold inside*

Color temperature	LED Light source	lm source
/W 4000K	36W	4520lm
/WW 3000K	36W	4040lm
/XW 2700K	36W	3780lm





3,70 Kg

Dimmerabile PUSH - 1...10V - DALI su richiesta
 Dimmable PUSH - 1...10V - DALI on request

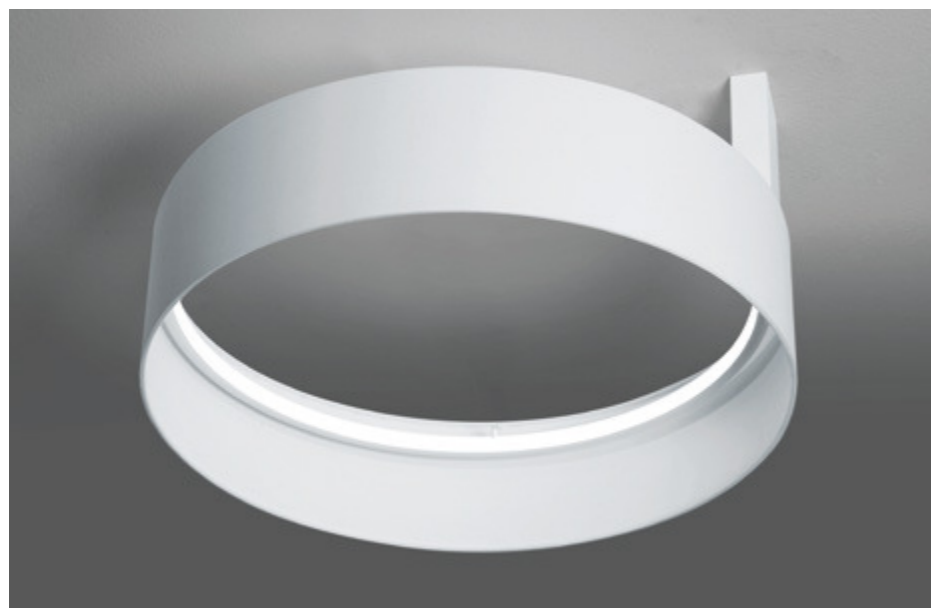

Radars 5607.01 bianco, interno bianco
Radars 5607.01 white, white inside

Codici finiture - *Finishes codes*



.01 **.02.01** **.02.21**



Radars 5607.02.01 nero, interno bianco - Radars 5607.02.01 black, white inside



Radars 5607.02.21 nero, interno dorato lucido - Radars 5607.02.21 black, shiny gold inside



design
officinadiarchitettura&design
2022

272 274

Famiglia di lampade a luce diffusa, caratterizzate da un'emissione luminosa a 360 gradi, con corpo in acciaio INOX e diffusore in metacrilato trasparente. Per alcune versioni a parete l'alimentatore è da ordinare separatamente.

Family of diffused light lamps, characterised by a 360° light emission, with a stainless steel body and transparent methacrylate diffuser. For some wall-mounted versions, the driver must be ordered separately.

Famille de lampes à lumière diffuse, caractérisée par une émission de lumière à 360 degrés, avec corps en acier inoxydable et diffuseur en méthacrylate transparent. Pour certaines versions murales, le driver doit être commandé séparément.

Familia de lámparas de luz difusa, caracterizadas por una emisión luminosa de 360 grados, con cuerpo de acero inoxidable y difusor de metacrilato transparente. Para algunas versiones murales, el driver debe pedirse por separado.

Leuchtenfamilie mit diffusem Licht, die sich durch einen 360-Grad-Lichtaustritt auszeichnet, mit Gehäuse aus Edelstahl und transparentem Methacrylat-Diffusor. Für einige Wandversionen muss das Driver separat bestellt werden.

• i
• o
B a g
i o i r i

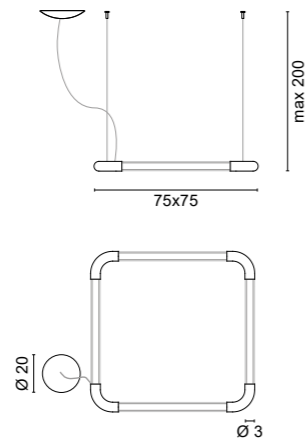

1668 Bagliori
.02 Nero - Black

Color temperature	LED Light source	lm source
WW 3000K	55W	4170lm

4,00 Kg

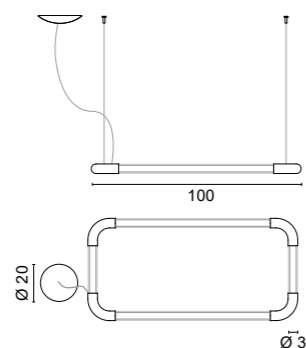

1669 Bagliori
.02 Nero - Black

Color temperature	LED Light source	lm source
WW 3000K	55W	4170lm

4,00 Kg



Codici finiture - Finishes codes



.02

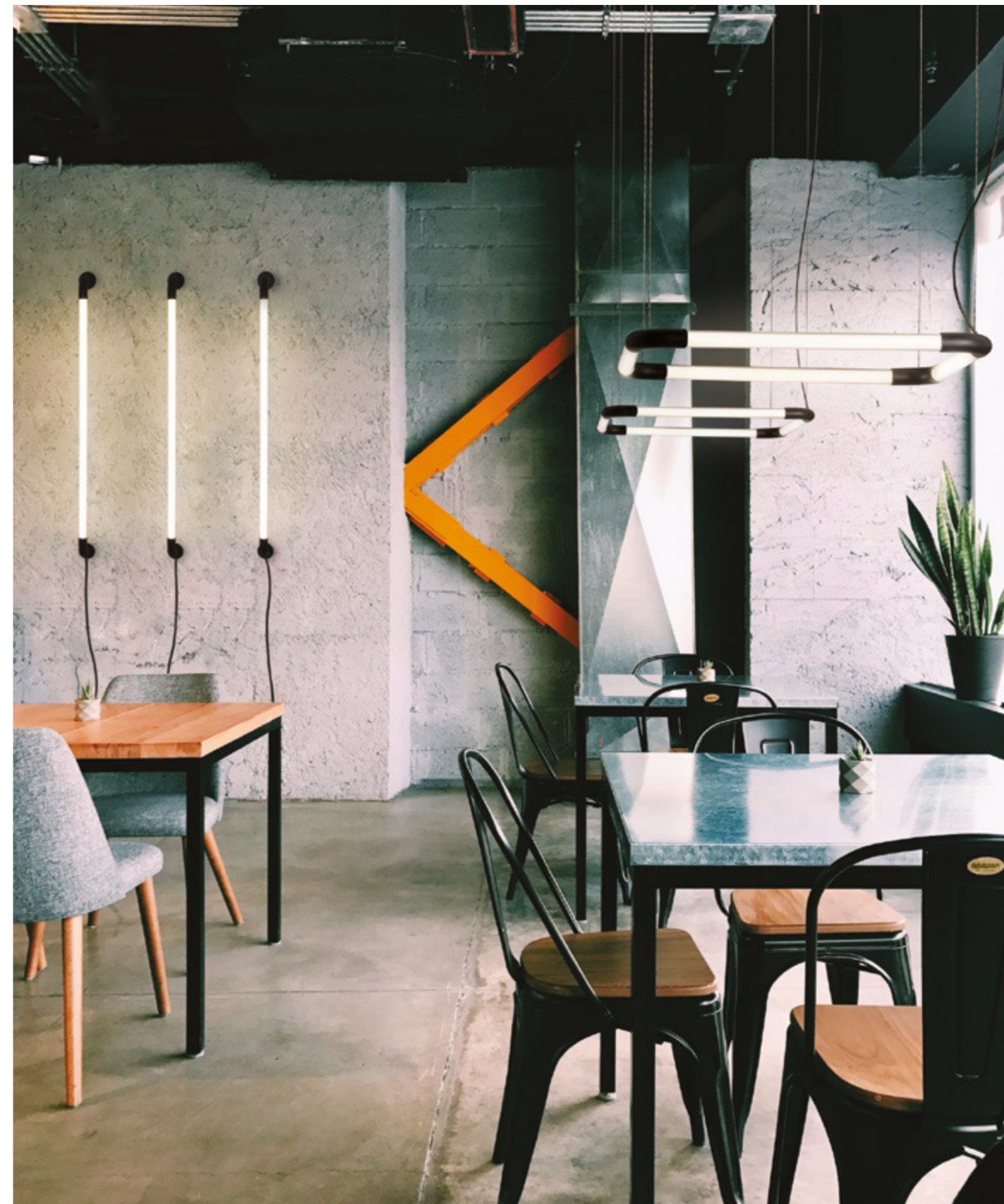

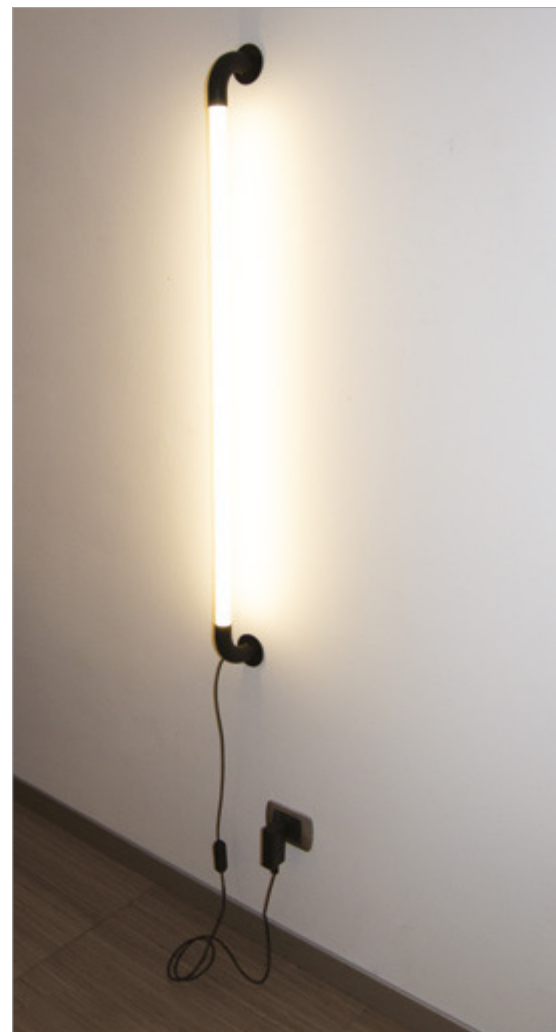

4648 Bagliori
.02 Nero - Black

Color temperature LED Light source lm source
WW 3000K 20W 1949lm

IP40 200 CM Dim CRI >90 R 1,30 Kg

Completa di PUSH DIMMER su cavo nero
 With PUSH DIMMER on black cable

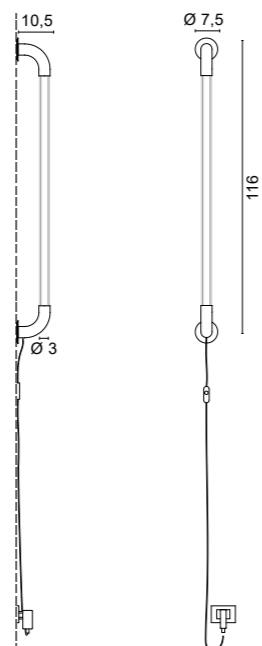

Codici finiture - Finishes codes



.02

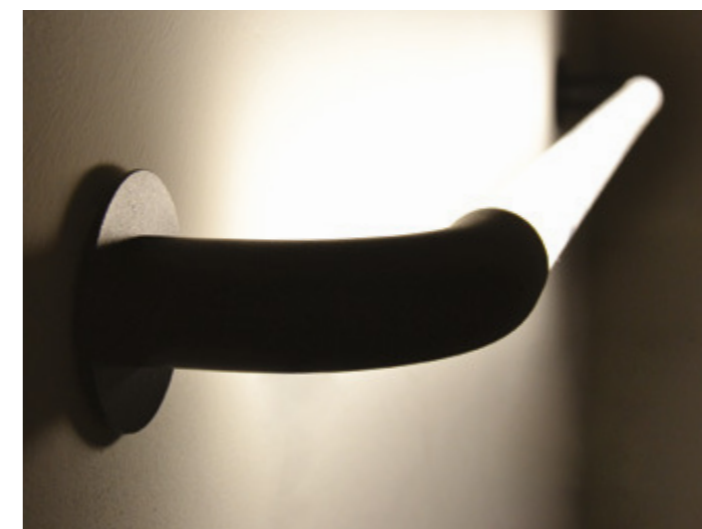



4645 Bagliori

- .01** Bianco - *White*
- .02** Nero - *Black*
- .09** Arancione - *Orange*
- .10** Azzurro - *Light blue*
- .33** Acciaio satinato - *Matt stell*

Color temperature	LED Light source	lm source
WW 3000K	24V 8W	796lm

IP44
0,55 Kg

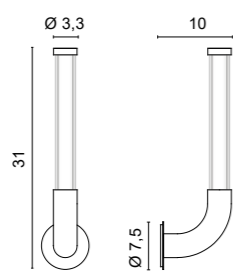
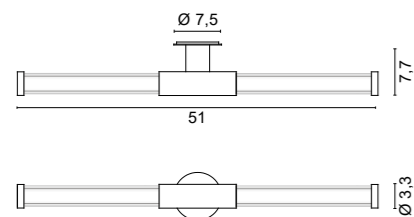

4647 Bagliori

- .01** Bianco - *White*
- .02** Nero - *Black*
- .09** Arancione - *Orange*
- .10** Azzurro - *Light blue*
- .33** Acciaio satinato - *Matt stell*

Color temperature	LED Light source	lm source
WW 3000K	24V 4W	398lm

IP44
0,40 Kg



Drivers

Drivers **ON/OFF**

Cod. **0155**
24V-13W

DIMMABLE drivers

Cod. **0717/DIM60/V** **0717/DIM60**
24V-60W 1...10V 24V-60W **PUSH - DALI**

Codici finiture - *Finishes codes*



.01

.02

.09

.10

.33



- 4644** Bagliori
- .01** Bianco - *White*
 - .02** Nero - *Black*
 - .09** Arancione - *Orange*
 - .10** Azzurro - *Light blue*
 - .33** Acciaio satinato - *Matt stell*

Color temperature	LED Light source	lm source
WW 3000K	8W	796lm

IP40
0,75 Kg

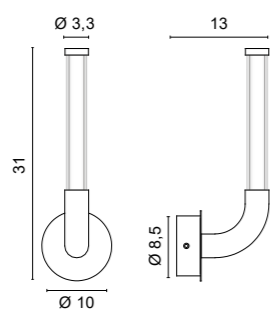
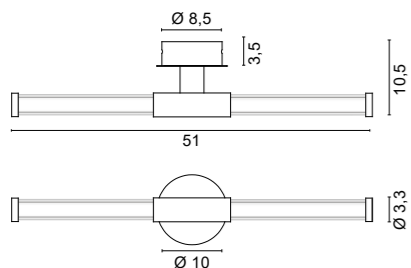

- 4646** Bagliori
- .01** Bianco - *White*
 - .02** Nero - *Black*
 - .09** Arancione - *Orange*
 - .10** Azzurro - *Light blue*
 - .33** Acciaio satinato - *Matt stell*

Color temperature	LED Light source	lm source
WW 3000K	4W	398lm

IP40
0,60 Kg

Codici finiture - *Finishes codes*



.01 **.02** **.09** **.10** **.33**





design
officinadiarchitettura&design
 2022

282 282 286

Famiglia di lampade IP65 a luce diretta con struttura in acciaio INOX AISI 316L o acciaio INOX con verniciatura rinforzata per esterni. Caratterizzate da semplici forme possono essere utilizzate anche per ambienti interni. L'alimentatore è da posizionare in remoto ed è da ordinare separatamente.

Family of IP65 direct-light lamps with an AISI 316L stainless steel or stainless steel structure with reinforced paintwork for outdoor use. Characterised by simple shapes, they can also be used indoors. The driver is to be positioned remotely and must be ordered separately.

Famille de lampes à lumière directe IP65 avec une structure en acier inoxydable AISI 316L ou en acier inoxydable avec une peinture renforcée pour une utilisation en extérieur. Caractérisées par des formes simples, elles peuvent également être utilisées à l'intérieur. Le driver doit être positionné à distance et doit être commandé séparément.

Familia de luminarias de luz directa IP65 con estructura de acero inoxidable AISI 316L o acero inoxidable con pintura reforzada para uso exterior. Caracterizadas por sus formas sencillas, también pueden utilizarse en interiores. El driver debe colocarse a distancia y debe pedirse por separado.

Familie von IP65-Leuchten mit direktem Licht und einer Struktur aus rostfreiem Stahl AISI 316L oder aus rostfreiem Stahl mit verstärkter Lackierung für die Verwendung im Freien. Sie zeichnen sich durch einfache Formen aus und können auch in Innenräumen verwendet werden. Das Driver ist entfernt zu positionieren und muss separat bestellt werden..

Raccordi di luce - Joy

archiproducts®
 AWARDS
 WINNER

Siamo lieti di annunciare che Raccordi di Luce Joy ha vinto il premio Archiproducts Awards 2023 nella sezione Lighting Innovation.

We are thrilled to share that the Raccordi di Luce Joy has won the Archiproducts Awards 2023 section Lighting Innovation.



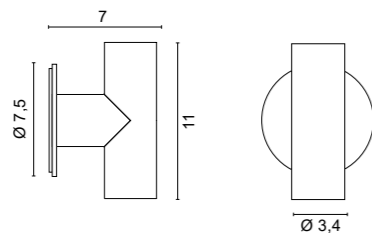
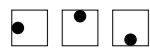

- 4672** Raccordi di luce
- .01 Bianco - White
 - .02 Nero - Black
 - .33 Acciaio - Stell (Inox AISI 316L)
 - .34 Verniciato corten - Painted corten

Color temperature	LED Light source	lm source
/W 4000K	3W 500mA	360lm
/WW 3000K	3W 500mA	324lm
/XW 2700K	3W 500mA	306lm



0,31 Kg

Solo collegamento in serie - Only serial connection

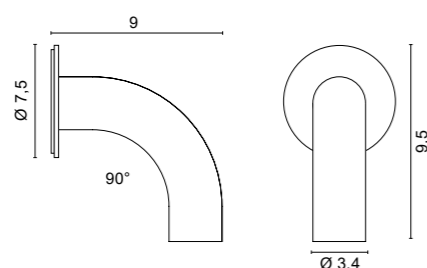

- 4673** Raccordi di luce
- .01 Bianco - White
 - .02 Nero - Black
 - .33 Acciaio - Stell (Inox AISI 316L)
 - .34 Verniciato corten - Painted corten

Color temperature	LED Light source	lm source
/W 4000K	1,5W 500mA	180lm
/WW 3000K	1,5W 500mA	162lm
/XW 2700K	1,5W 500mA	153lm



0,25 Kg

Solo collegamento in serie - Only serial connection

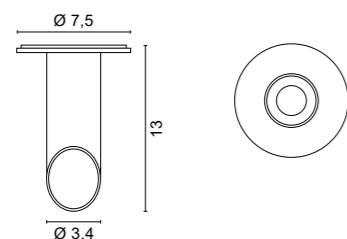

- 5690** Raccordi di luce
- .01 Bianco - White
 - .02 Nero - Black
 - .33 Acciaio - Stell (Inox AISI 316L)
 - .34 Verniciato corten - Painted corten

Color temperature	LED Light source	lm source
/W 4000K	1,5W 500mA	180lm
/WW 3000K	1,5W 500mA	162lm
/XW 2700K	1,5W 500mA	153lm



0,25 Kg

Solo collegamento in serie - Only serial connection



Codici finiture - Finishes codes

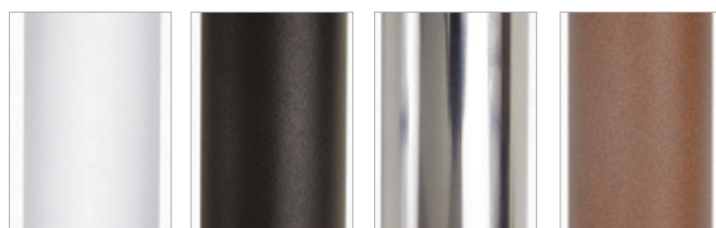

.01 .02 .33 .34



Drivers

Cod.	Drivers ON/OFF	
	0143/IP	0127
	500mA	500mA
4672	1-3	1-3
4673	1-7	1-6
5690	1-7	1-6

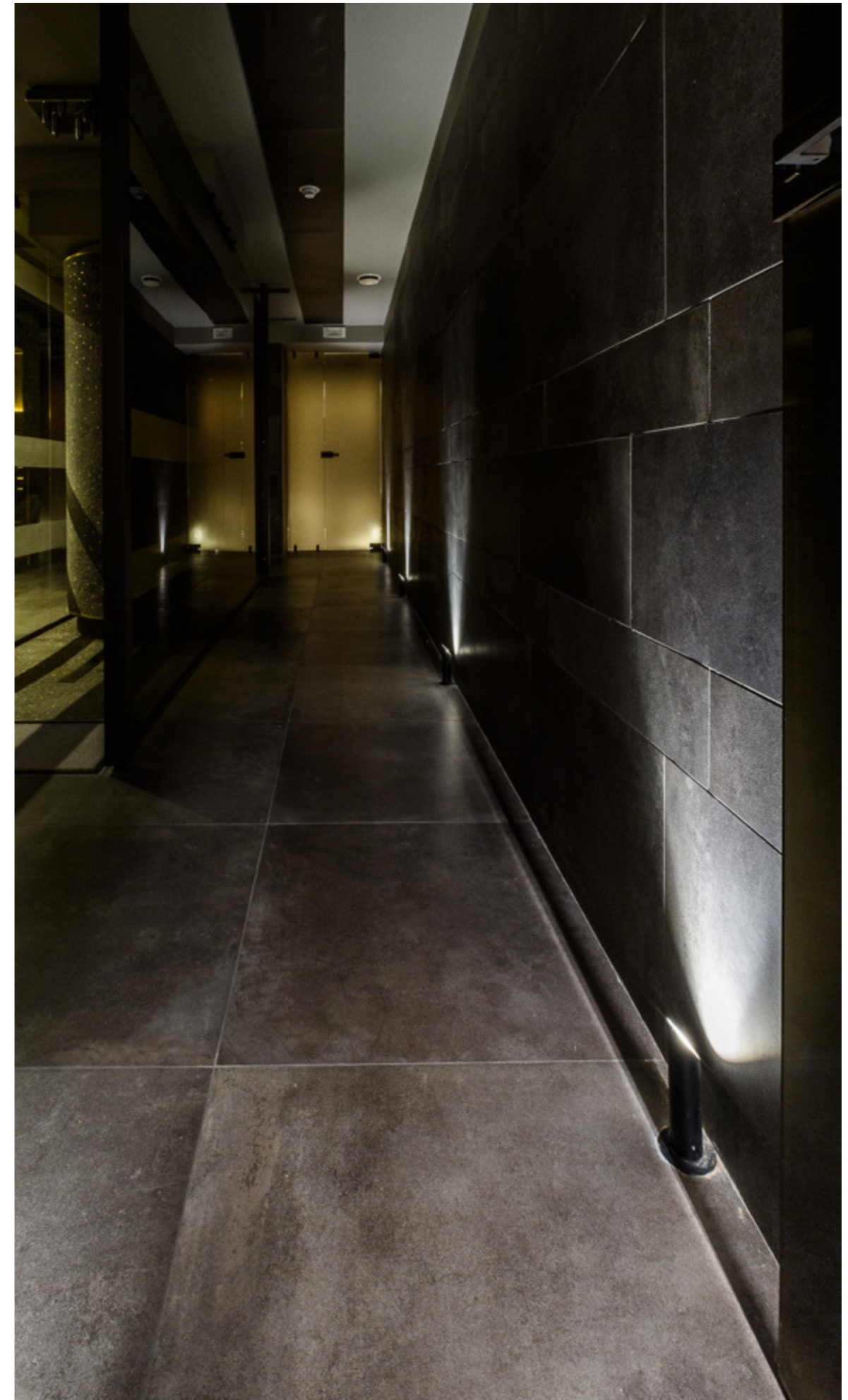
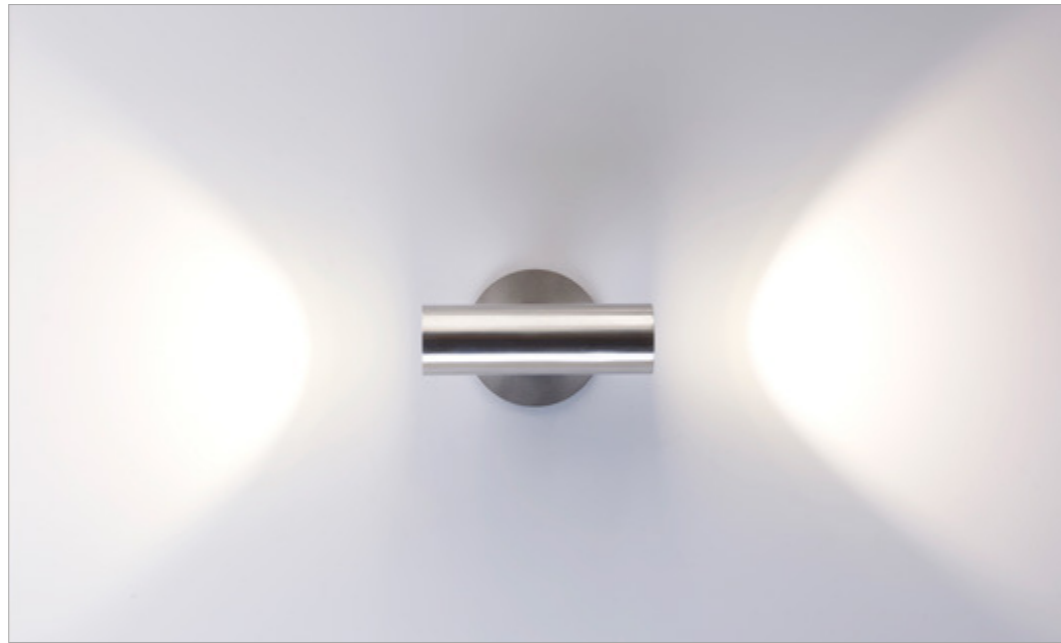

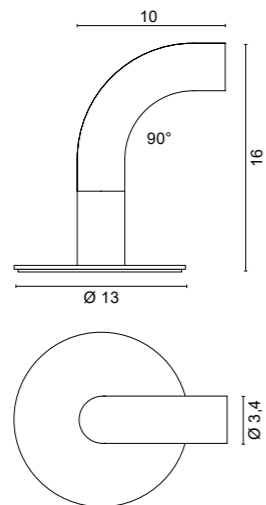

3555 Raccordi di luce

.33	Acciaio - Stell (Inox AISI 316L)
.34	Verniciato corten - <i>Painted corten</i>

Color temperature	LED Light source	lm source
/W 4000K	1,5W 500mA	180lm
/WW 3000K	1,5W 500mA	162lm
/XW 2700K	1,5W 500mA	153lm

IP65

Solo collegamento in serie - *Only serial connection*

0,60 Kg

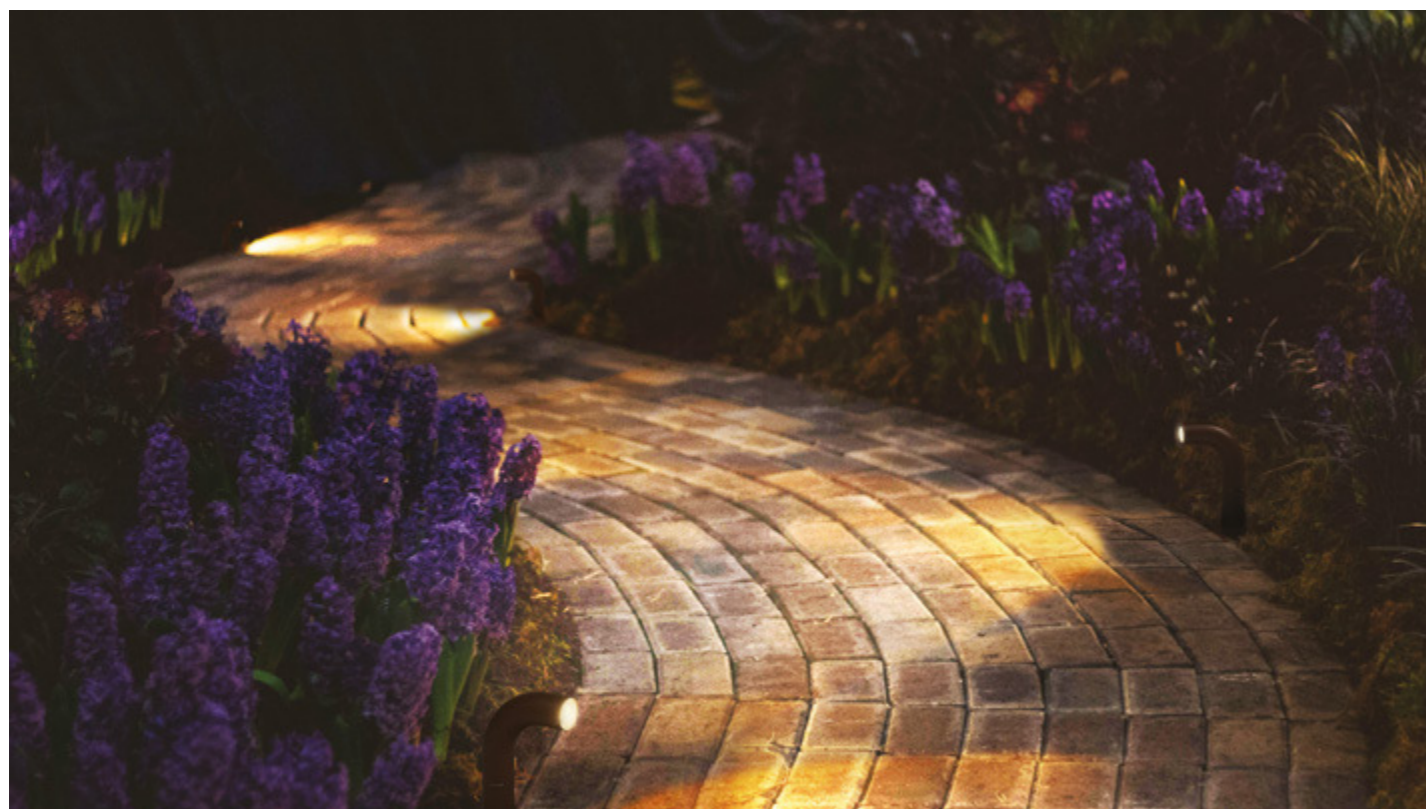

Codici finiture - *Finishes codes*



.33

.34

Drivers

Cod. LED	Drivers ON/OFF	
	0143/IP	0127
	500mA	500mA
3547	1-7	1-7

Accessori - *Accessories*



0246/R
Cassaforma drenante con piastra
Draining formwork with plate



0276
Connettore con gel IP67
IP67 connector with gel

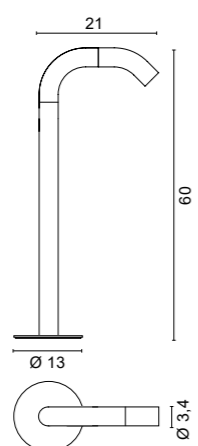

3556 Raccordi di luce

.33 Acciaio - Stell (*Inox AISI 316L*)
.34 Verniciato corten - Painted corten

Color temperature	LED Light source	lm source
/W 4000K	1,5W 500mA	180lm
/WW 3000K	1,5W 500mA	162lm
/XW 2700K	1,5W 500mA	153lm

IP65
1,50 Kg

Solo collegamento in serie - *Only serial connection*

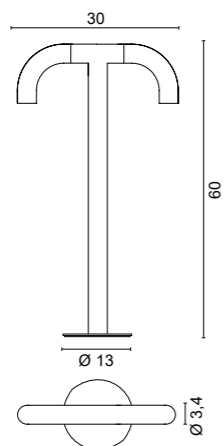
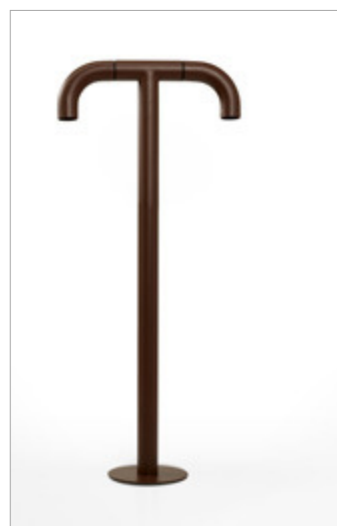

3557 Raccordi di luce

.33 Acciaio - Stell (*Inox AISI 316L*)
.34 Verniciato corten - Painted corten

Color temperature	LED Light source	lm source
/W 4000K	3W 500mA	360lm
/WW 3000K	3W 500mA	324lm
/XW 2700K	3W 500mA	306lm

IP65
2,00 Kg

Solo collegamento in serie - *Only serial connection*

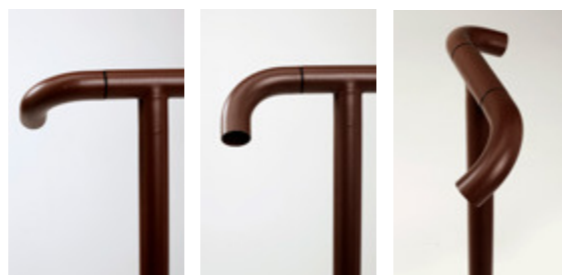

Codici finiture - *Finishes codes*



.33

.34



Accessori - *Accessories*



0246/R
 Cassaforma drenante con piastra
Draining formwork with plate



0276
 Connettore con gel IP67
IP67 connector with gel



Lampade da parete a luce radiale con struttura in alluminio. La versione con portalampada GX53, tonda o quadrata, è disponibile in varie finiture ed a richiesta è possibile personalizzare lo schermo con lavorazioni a taglio laser. La versione IP65, con anodizzazione rinforzata per esterni, è dotata di circuito LED e alimentatore integrato.

Radial light wall lamps with an aluminium structure. The version with GX53 lamp holder, round or square, is available in various finishes and on request it is possible to customise the screen with laser-cut machining. The IP65 version, with reinforced anodising for outdoor use, is equipped with LED circuit and integrated driver.

Appliques à lumière radiale avec structure en aluminium. La version avec douille GX53, ronde ou carrée, est disponible dans différentes finitions et, sur demande, il est possible de personnaliser l'écran avec un usinage au laser. La version IP65, avec anodisation renforcée pour l'extérieur, est dotée d'un circuit LED et d'une driver intégrée.

Appliques de luz radial con estructura de aluminio. La versión con portalámparas GX53, redondo o cuadrado, está disponible en varios acabados y, bajo pedido, es posible personalizar la pantalla con mecanizado por corte láser. La versión IP65, con anodizado reforzado para uso exterior, dispone de circuito LED y driver integrado.

Wandleuchten mit Radiallicht und Aluminiumstruktur. Die runde oder quadratische Version mit GX53 Lampenfassung ist in verschiedenen Ausführungen erhältlich und auf Anfrage ist es möglich, den Schirm durch Laserbearbeitung individuell zu gestalten. Die IP65-Version mit verstärkter Eloxierung für den Außeneinsatz ist mit einer LED-Schaltung und integrierter Stromversorgung ausgestattet.

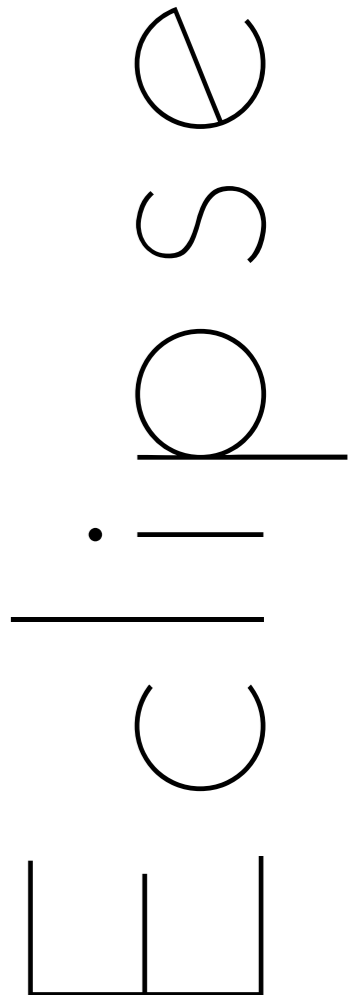

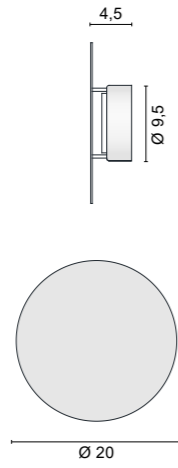

4592 Eclipse Tonda

- .01** Bianco - White
- .02** Nero - Black
- .25** Dorato satinato - Satin gold
- .28** Foglia rame - Copper leaf
- .29** Foglia oro - Gold leaf
- .32** Nickel satinato - Nickel mat
- .35** Sabbia - Sand
- .56** Specchio - Mirror

Light source not included

- GX53 LED
- 8W 4000K 700lm (art. 0103/W) Dim
- 8W 3000K 680lm (art. 0103/WW) Dim
- 8W 2700K 650lm (art. 0103/XW) Dim



0,45 Kg



Codici finiture - Finishes codes

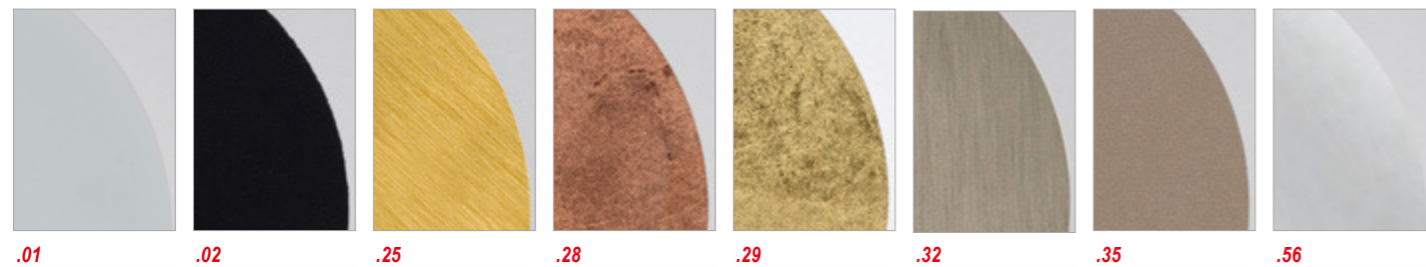

Su richiesta è possibile personalizzare lo schermo con lavorazioni laser
On request, the screen can be customised with laser processing

Eclipse IP

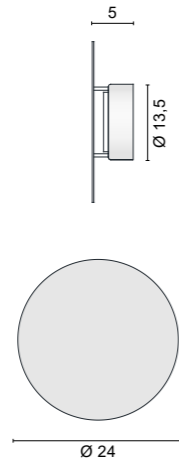

4625 Eclipse IP

- .01** Bianco - White
- .34** Verniciato corten - Painted corten finishing
- .39** Verniciato antracite - Painted anthracite finishing

Color temperature	LED Light source	lm source
/WW 3000K	8,7W	670lm

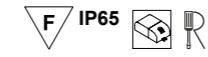

1,50 Kg

Eclipse Quadra

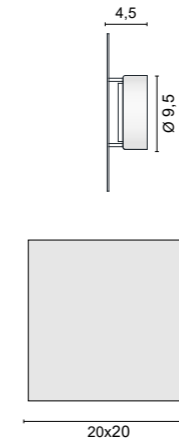

4593 Eclipse Quadra

- .01** Bianco - White
- .02** Nero - Black
- .35** Sabbia - Sand

Light source not included
GX53 LED

8W 4000K 700lm	(art. 0103/W)	Dim
8W 3000K 680lm	(art. 0103/WW)	Dim
8W 2700K 650lm	(art. 0103/XW)	Dim



0,45 Kg



Codici finiture - Finishes codes

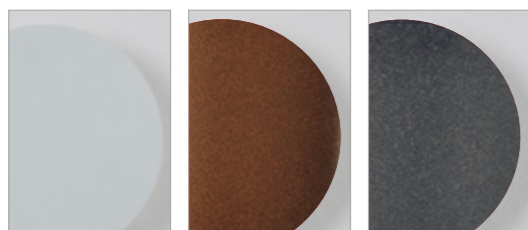

.01

.34

.39

Codici finiture - Finishes codes

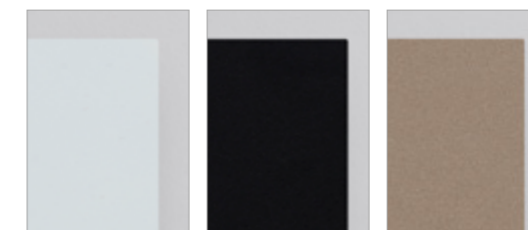

.01

.02

.35



design **ABS Studio**
2020

Lampada da parete a luce diretta/radiale con struttura e disco radiale in alluminio verniciato, diffusore centrale in metacrilato e portalamada con attacco per lampadine LED GX53.

Direct/radial light wall lamp with painted aluminium frame, central methacrylate diffuser and lamp holder with GX53 LED bulb socket.



Applique à lumière directe/radiale avec structure en aluminium peint, diffuseur central en méthacrylate et douille avec ampoule LED GX53.

Aplicque de luz directa/radial con marco de aluminio pintado, difusor central de metacrilato y portalamparas con casquillo para bombilla LED GX53.

Wandleuchte für direktes/radiales Licht mit lackiertem Aluminiumrahmen, zentralem Methacrylatdiffusor und Lampenfassung mit GX53 LED-Glühbirnenfassung.

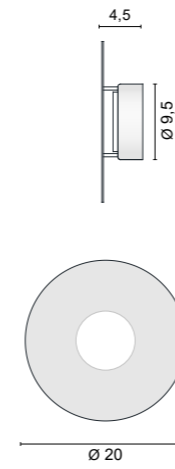
Ellein



4596	Ellein
.01	Bianco - White
.02	Nero - Black
.35	Sabbia - Sand
<i>Light source not included</i>	
GX53 LED	
8W 4000K 700lm	(art. 0103/W) <small>Dim</small>
8W 3000K 680lm	(art. 0103/WW) <small>Dim</small>
8W 2700K 650lm	(art. 0103/XW) <small>Dim</small>
  	0,45 Kg



Codici finiture - Finishes codes

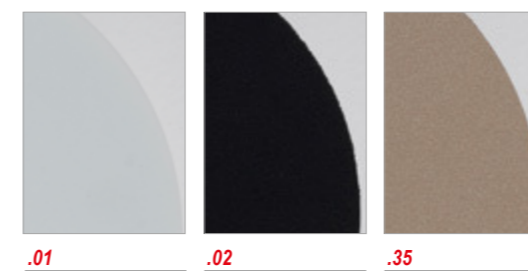



design **ABS Studio**
2020

Lampada da parete a luce diretta/
radiale con struttura e disco
centrale in alluminio verniciato,
diffusore in metacrilato e
portalampana con attacco per
lampadine LED GX53.

*Direct/radial light wall lamp
with painted aluminium frame,
methacrylate diffuser and lamp
holder with GX53 LED bulb
socket.*

*Applique à lumière directe/radiale
avec structure en aluminium
peint, diffuseur en méthacrylate
et douille avec douille pour
ampoule LED GX53.*

*Applique de luz directa/radial
con marco de aluminio pintado,
difusor de metacrilato y
portalámparas con casquillo para
bombilla LED GX53.*

*Wandleuchte mit direktem/
radialem Licht, Rahmen
aus lackiertem Aluminium,
Diffusor aus Methacrylat und
Lampenfassung mit GX53 LED-
Glühbirnenfassung.*

Elleout

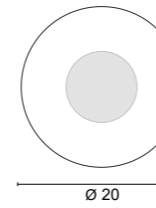
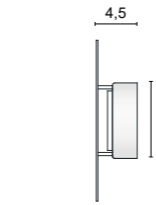
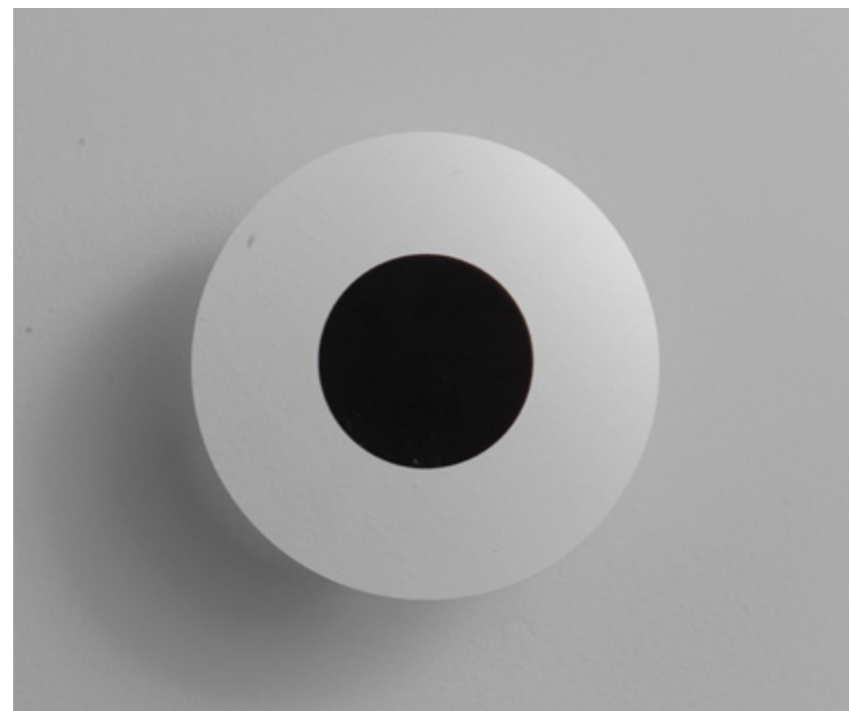

4599 Elleout

.01 Bianco - White

.02 Nero - Black

.35 Sabbia - Sand

Light source not included

GX53 LED

8W 4000K 700lm (art. 0103/W) Dim

8W 3000K 680lm (art. 0103/WW) Dim

8W 2700K 650lm (art. 0103/XW) Dim



0,35 Kg



Codici finiture - Finishes codes



.01

.02

.35



design **ABS Studio**
2017

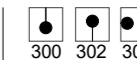

Collezione di lampade, dalla linea che si ispira al calice per la degustazione del cognac, con struttura in alluminio tornito in lastra e con portalampada con attacco E27. La versione a sospensione può essere installata su una serie di rosoni, da ordinare separatamente, oppure, con apposito accessorio, su binari elettrificati (pag. 340).

Collection of lamps, with a line inspired by the cognac tasting goblet, with a structure in turned sheet aluminium and with lamp holder with E27 socket. The suspension version can be installed on a series of ceiling roses, to be ordered separately, or, with a special accessory, on electrified tracks (p. 340).

Collection de lampes, dont la ligne s'inspire du gobelet de dégustation de cognac, avec une structure en tôle d'aluminium tournée et une douille avec prise E27. La version suspendue peut être installée sur une série de rosaces, à commander séparément, ou, avec un accessoire spécial, sur des rails électrifiés (p. 340).

Colección de lámparas, con una línea inspirada en la copa de degustación de coñac, con estructura de chapa de aluminio torneada y con portalámparas con casquillo E27. La versión suspendida puede instalarse sobre una serie de florones a techo, que se piden por separado, o, con un accesorio especial, sobre raíles electrificados (p. 340).

Lampenkollektion mit einer vom Cognacbecher inspirierten Linie, mit einer in ein Blech verwandelten Aluminiumstruktur und mit einer Lampenfassung mit E27-Fassung. Die hängende Version kann auf einem separat zu bestellenden Rosettensatz oder, mit einem speziellen Zubehör, auf elektrifizierten Schienen installiert werden (S. 340).

U
O
O
|
B
B

**1549** Baloon

.01	Bianco - <i>White</i>
.02	Nero, interno bianco - <i>Black, white inside</i>
.31	Cromato lucido, interno bianco - <i>Chromed, white inside</i>

Light source not included

E27 LED

8W 1055lm (art. 0109/8/...)

11W 1521lm (art. 0109/11/...)



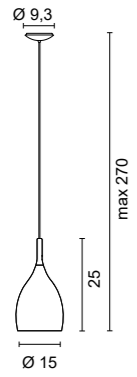
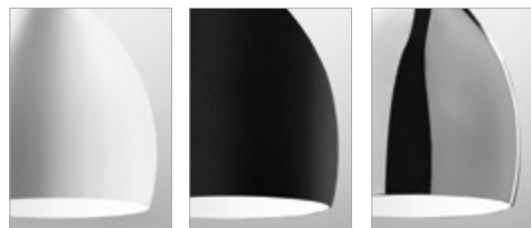

1,60 Kg

Codici finiture - *Finishes codes***.01****.02****.31**



3517 Baloon
.01 Bianco - *White*
.02 Nero, interno bianco - *Black, white inside*

Light source not included
 E27 LED
 8W 1055lm (art. 0109/8/...)
 11W 1521lm (art. 0109/11/...)

   4,20 Kg

Accensione ON-OFF
 ON-OFF switch

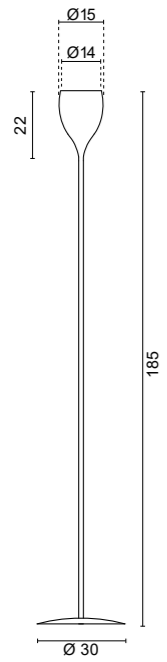

Codici finiture - *Finishes codes*



.01

.02

4524 Baloon

.01 Bianco - *White*

.02 Nero, interno bianco - *Black, white inside*

Light source not included

E27 LED

8W 1055lm (art. 0109/8/...)

11W 1521lm (art. 0109/11/...)

 1,80 Kg

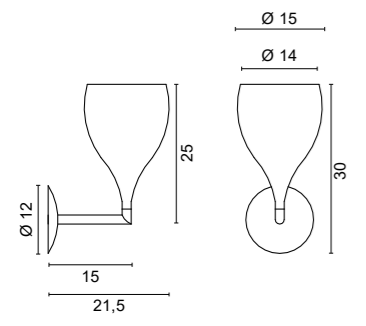

Codici finiture - *Finishes codes*

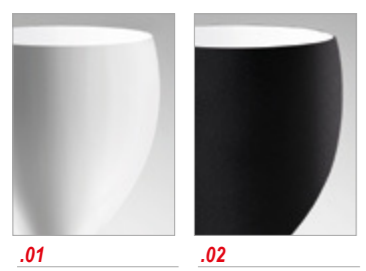



design **U.T. EgoLucè**
2020

68

Sistema di lampade a sospensione e da plafone con corpo in alluminio e portalampada con attacco E27. Edison System permette di moltiplicare i punti luce partendo da un'unica alimentazione e si completa con una serie di accessori, da ordinare separatamente, per creare infinite configurazioni. La versione a sospensione può essere installata anche su binari elettrificati (pag. 340).

Suspension and ceiling light system with aluminium body and lamp holder with E27 socket. Edison System makes it possible to multiply the lighting points from a single power supply and is completed with a series of accessories, to be ordered separately, to create infinite configurations. The suspension version can also be installed on electrified tracks c.

Système de suspension et de plafonnier avec corps en aluminium et douille avec prise E27. Edison System permet de multiplier les points d'éclairage à partir d'une seule alimentation et est complété par une série d'accessoires, à commander séparément, pour créer des configurations infinies. La version suspension peut également être installée sur des voies électrifiées (p. 340).

Sistema de suspensión y plafón con cuerpo de aluminio y portalámparas con casquillo E27. Edison System permite multiplicar los puntos de luz a partir de una única fuente de alimentación y se completa con una serie de accesorios, que deben pedirse por separado, para crear infinitas configuraciones. La versión de suspensión también puede instalarse en carriles electrificados (p. 340).

System für Hänge- und Deckenleuchten mit Aluminiumgehäuse und Lampenfassung mit E27-Fassung. Edison System ermöglicht die Vervielfachung der Beleuchtungspunkte mit einer einzigen Stromversorgung und wird durch eine Reihe von separat zu bestellenden Zubehörteilen ergänzt, um unendliche Konfigurationen zu schaffen. Die Hängeversion kann auch auf Stromschienen installiert werden (S. 340).

Edison System



EDISON System con lampadina 01LCR1 - EDISON System with bulb 01LCR1



5612 Edison System Ceiling

.01	Bianco - <i>White</i>
.02	Nero - <i>Black</i>
.25	Dorato satinato - <i>Satin gold</i>
.32	Nickel satinato - <i>Nickel mat</i>

Light source not included
E27 LED max 7W

 0,35 Kg

Predisposto per 4 collegamenti
Prepared for 4 connections

Edison System 5612.01 + 01LP8

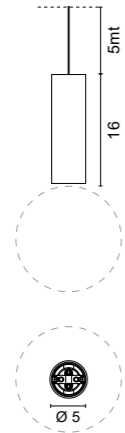

1598 Edison System Suspension

.01	Bianco - <i>White</i>
.02	Nero - <i>Black</i>
.25	Dorato satinato - <i>Satin gold</i>
.32	Nickel satinato - <i>Nickel mat</i>

Light source not included
E27 LED max 7W

 0,40 Kg

Lunghezza cavo 500 cm
Cable length 500 cm

Edison System 1598.01 + 01LP8



Edison System 5612.01 + 01LP7



Edison System 5612.01 + 01LCR2

Codici finiture - *Finishes codes*

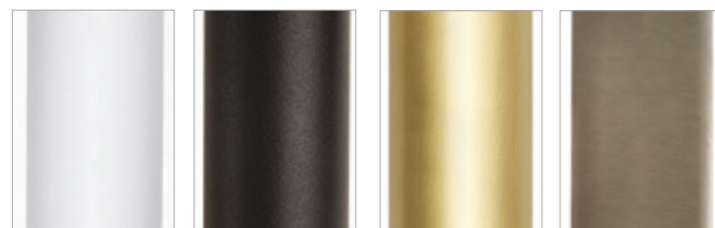

.01 **.02** **.25** **.32**

Lampadine decorative E27 da ordinare separatamente (p. 507) - *E27 decorative filament bulbs to be ordered separately (p. 507)*



Edison System con lampadina 01LP8 - *Edison System with bulb 01LP8*



Rosoni - Ceiling rose



50/60Hz 220-240V

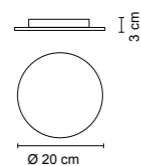

ROSONE DA 1 A 4 USCITE
CEILING ROSE WITH 1 - 4 HOLES

Code Codici finiture - Finishes codes
0603 .01 Bianco - White
0603 .02 Nero - Black



0,40 Kg



50/60Hz 220-240V

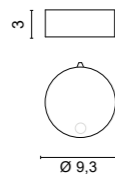

ROSONE DA 1 USCITA
CEILING ROSE WITH 1 HOLE

Code Codici finiture - Finishes codes
0604 .01 Bianco - White
0604 .02 Nero - Black



0,15 Kg



50/60Hz 220-240V

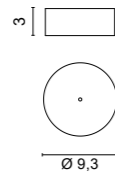

ROSONE PER SOSPENSIONE DA 1 USCITA
CEILING ROSE FOR SUSPENSION WITH 1 HOLE

Code Codici finiture - Finishes codes
0607 .01 Bianco - White
0607 .02 Nero - Black



Accessori - Accessories



0605

Deviatore e decentratore
Displacement element

Ø 1,7 H 2,2

.01 Bianco - White
.02 Nero - Black



0606

Cavo con rivestimento in tessuto 5 mt
Textile covered cable 5 mt

5 mt

.01 Bianco - White
.02 Nero - Black



Esempi di installazioni - Example of installations

0605
Deviatore e decentratore
Displacement element

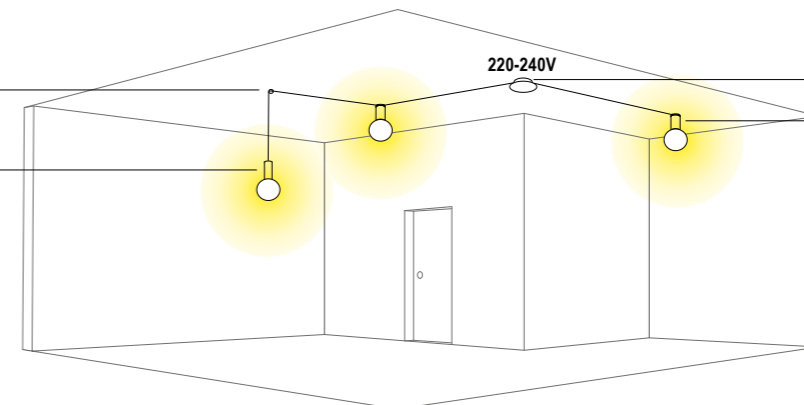

0603
Rosone da 1 a 4 uscite
50/60Hz 220-240V
Ceiling rose with 1 - 4 holes
50/60Hz 220-240V

1598
Edison System Suspension
Lunghezza cavo 5 mt
Cable length 5 mt

5612
Edison System Ceiling
Predisposto per 4 collegamenti
Prepared for 4 connections

0603
Rosone da 1 a 4 uscite
50/60Hz 220-240V
Ceiling rose with 1 - 4 holes
50/60Hz 220-240V

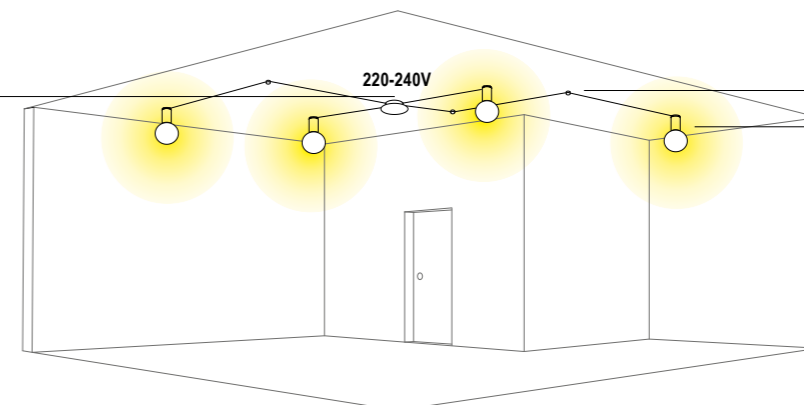

0605
Deviatore e decentratore
Displacement element

5612
Edison System Ceiling
Predisposto per 4 collegamenti
Prepared for 4 connections

5612
Edison System Ceiling
Predisposto per 4 collegamenti
Prepared for 4 connections

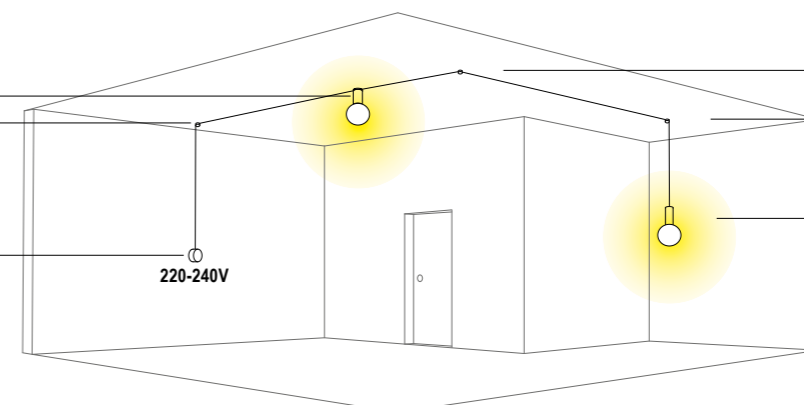

0605
Deviatore e decentratore
Displacement element

0605
Deviatore e decentratore
Displacement element

0605
Deviatore e decentratore
Displacement element

0604
Rosone - 1 uscita
50/60Hz 220-240V
Ceiling rose with 1 hole
50/60Hz 220-240V

1598
Edison System Suspension
Lunghezza cavo 500 cm
Cable length 500 cm

5612
Edison System Ceiling
Predisposto per 4 collegamenti
Prepared for 4 connections

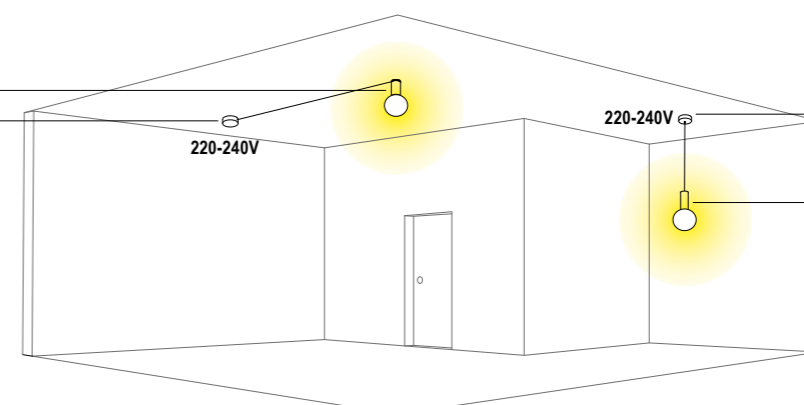

0946
Rosone per sospensione - 1 uscita
50/60Hz 220-240V
Ceiling rose for suspension - 1 hole
50/60Hz 220-240V

0604
Rosone - 1 uscita
50/60Hz 220-240V
Ceiling rose with 1 hole
50/60Hz 220-240V

1598
Edison System Suspension
Lunghezza cavo 500 cm
Cable length 500 cm

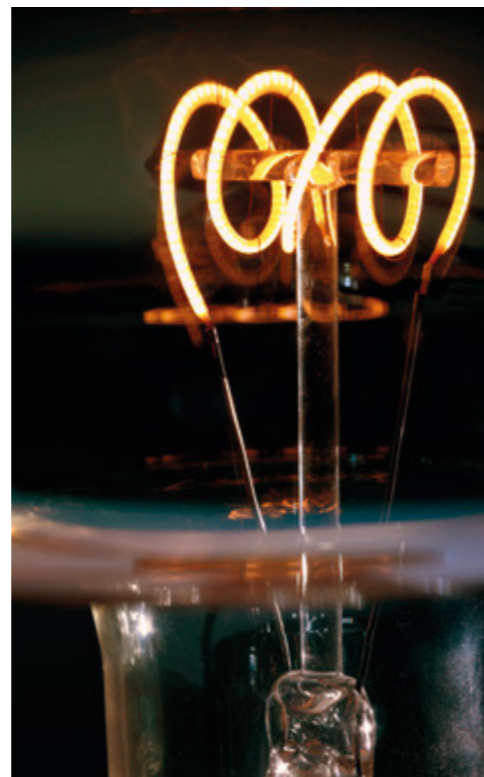

design ABS Studio
2018

314 318 319

Famiglia di lampade con struttura in ferro grezzo sfiammato che utilizza come elemento decorativo lampadine a filamento LED in vetro soffiato. La forma e l'effetto fumé e retrò delle lampadine conferiscono a Unidea quel surplus di eleganza evocativa ed emozionale che rende unico un progetto luminoso. Nella versione a sospensione il rosone con l'alimentatore integrato è da ordinare separatamente.

Family of lamps with a raw, flamed iron structure using blown glass LED filament bulbs as a decorative element. The shape and the smoky, retro effect of the bulbs give Unidea that surplus of evocative and emotional elegance that makes a lighting design unique. In the pendant version, the ceiling rose with integrated driver must be ordered separately.

Famille de lampes avec une structure en fer brut et flammé qui utilise des ampoules à filament LED en verre soufflé comme élément décoratif. La forme et l'effet fumé et rétro des ampoules confèrent à Unidea ce surplus d'élégance évocatrice et émotionnelle qui rend un projet d'éclairage unique. Dans la version suspendue, la rosace avec driver intégré doit être commandée séparément.

Familia de lámparas con estructura de hierro bruto flameado que utilizan bombillas de filamento LED de vidrio soplado como elemento decorativo. La forma y el efecto ahumado y retro de las bombillas confieren a Unidea ese plus de elegancia evocadora y emocional que hace único un diseño de iluminación. En la versión colgante, el florón a techo con driver integrado debe pedirse por separado.

Eine Leuchtenfamilie mit einer Struktur aus rohem, geflammtem Eisen, die LED-Glühbirnen aus geblasenem Glas als dekoratives Element verwendet. Die Form und der rauchige Retro-Effekt der Glühbirnen verleihen Unidea jenes Plus an stimmungsvoller und emotionaler Eleganz, das ein Beleuchtungsdesign einzigartig macht. Bei der Pendelversion muss die Rosette mit integriertem Driver separat bestellt werden.

Unidea

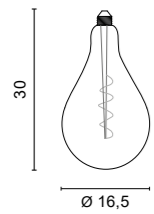

1600 Unidea
 .70 Retrò
 .71 Fumè

Light source
 E27 LED
 .70 - 4,5W 300lm 1800K
 .71 - 5W 110lm 1800K

0,20 Kg

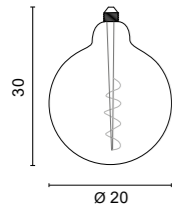

1601 Unidea
 .70 Retrò
 .71 Fumè

Light source
 E27 LED
 .70 - 4,5W 300lm 1800K
 .71 - 5W 110lm 1800K

0,20 Kg

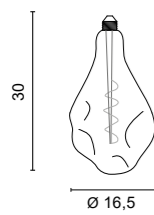

1602 Unidea
 .70 Retrò
 .71 Fumè

Light source
 E27 LED
 .70 - 4,5W 300lm 1800K
 .71 - 5W 110lm 1800K

0,20 Kg

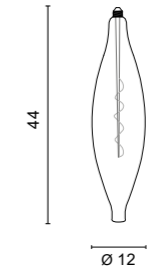

1603 Unidea
 .70 Retrò

Light source
 E27 LED
 10W 1000lm 2200K

0,50 Kg

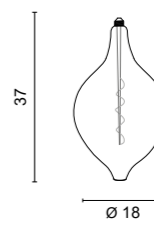

1604 Unidea
 .70 Retrò

Light source
 E27 LED
 10W 1000lm 2200K

0,50 Kg

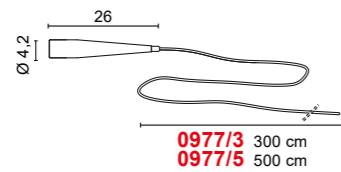

0977/3
 Portalampada E27 con cavo 300 cm
 Lamp holder E27 with cable 300 cm
 .71 Fumè

0977/5
 Portalampada E27 con cavo 500 cm
 Lamp holder E27 with cable 500 cm
 .71 Fumè

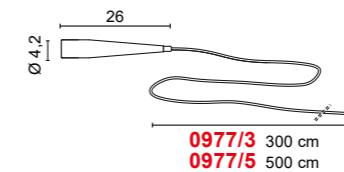
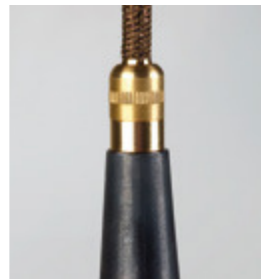

0977/3
 Portalampada E27 con cavo 300 cm
 Lamp holder E27 with cable 300 cm
 .71 Fumè

0977/5
 Portalampada E27 con cavo 500 cm
 Lamp holder E27 with cable 500 cm
 .71 Fumè

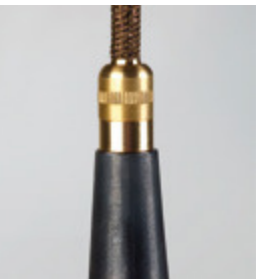

1600.70 + 0977/... 1600.71 + 0977/... 1601.70 + 0977/... 1601.71 + 0977/... 1602.70 + 0977/... 1602.71 + 0977/...



1603.70 + 0977/... 1604.70 + 0977/...



Rosoni - Ceiling roses

0976/1



IN: 50/60Hz 220-240V

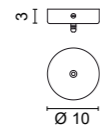

ROSONE IN METALLO PER SOSPENSIONE SENZA CAVO - 1 UNIDEA
METALL CEILING ROSE FOR SUSPENSION WITHOUT CABLE - 1 UNIDEA

Code Codici finiture - Finishes codes
0976/1 .71 Fumè con bloccacavo in ottone - Fumè with brass cable lock



0,20 Kg

0976/2

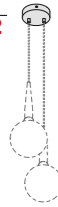

IN: 50/60Hz 220-240V

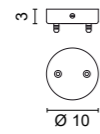

ROSONE IN METALLO PER SOSPENSIONE SENZA CAVO - 2 UNIDEA
METALL CEILING ROSE FOR SUSPENSION WITHOUT CABLE - 2 UNIDEA

Code Codici finiture - Finishes codes
0976/2 .71 Fumè con bloccacavo in ottone - Fumè with brass cable lock



0,20 Kg

0976/3



IN: 50/60Hz 220-240V

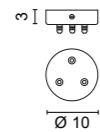

ROSONE IN METALLO PER SOSPENSIONE SENZA CAVO - 3 UNIDEA
METALL CEILING ROSE FOR SUSPENSION WITHOUT CABLE - 3 UNIDEA

Code Codici finiture - Finishes codes
0976/3 .71 Fumè con bloccacavo in ottone - Fumè with brass cable lock



0,20 Kg

0978/2

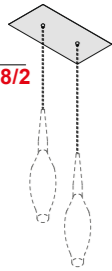

IN: 50/60Hz 220-240V

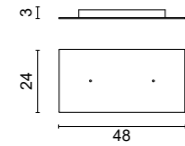

ROSONE PER SOSPENSIONE DA 2 USCITE
CEILING ROSE FOR SUSPENSION WITH 4 HOLES

Code Codici finiture - Finishes codes
0978/2 .02 Nero - Black



2,00 Kg

0978/4

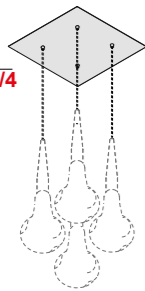

IN: 50/60Hz 220-240V

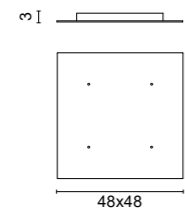

ROSONE PER SOSPENSIONE DA 4 USCITE
CEILING ROSE FOR SUSPENSION WITH 4 HOLES

Code Codici finiture - Finishes codes
0978/4 .02 Nero - Black



3,80 Kg

Accessori - Accessories

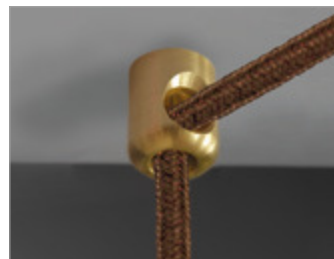

0975/1

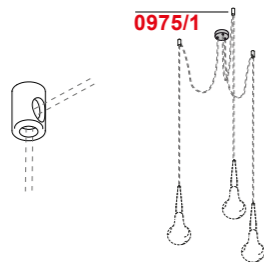



0975/1
1 Decentratore per soffitto
in ottone satinato
1 Satin brass displacement
element for ceiling fixing





2512 Unidea
.70 Retro'

Light source included
 E27 LED
 5W 250lm 1800K

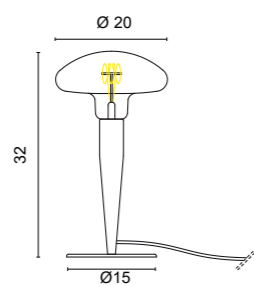

   1,00 Kg

Accensione ON-OFF
 ON-OFF switch



3511 Unidea
.70 Retro'

Light source included
 E27 LED
 10W 1000lm 2200K

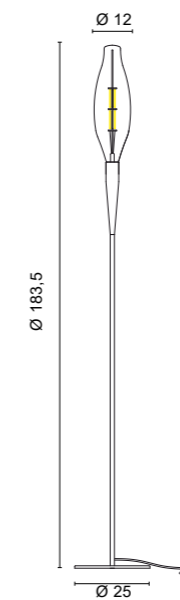

  4,30 Kg

Accensione ON-OFF
 ON-OFF switch



3512 Unidea
.70 Retro'

Light source included
 E27 LED
 10W 1000lm 2200K

  4,30 Kg

Accensione ON-OFF
 ON-OFF switch

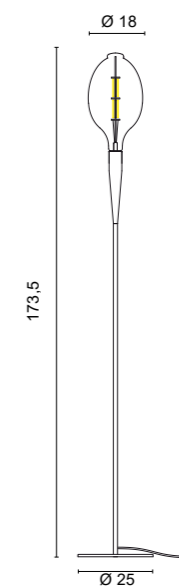



design **Mati**
2019

Lampade da parete e da tavolo con struttura in ottone e portalam-pada con attacco E27. Una rivisitazione delle lampade degli anni '60 e '70 realizzate con gli stessi materiali: ottone lucido o satinato. Le lampadine LED con effetto ceramico bianco, da ordinare separatamente, ricreano l'impressione del vetro opale in voga all'epoca.

Wall and table lamps with brass frame and E27 lamp holder. A reinterpretation of the lamps of the 1960s and 1970s made of the same materials: polished or satin-finished brass. The LED bulbs with white ceramic effect, to be ordered separately, recreate the impression of opal glass in vogue at the time.

Appliques et lampes de table avec structure en laiton et douille E27. Reprise des lampes des années 1960 et 1970 réalisées dans les mêmes matériaux : laiton poli ou satiné. Les ampoules LED à effet céramique blanc, à commander séparément, recréent l'impression de verre opale en vogue à l'époque.

Lámparas de pared y sobremesa con marco de latón y portalam-paras E27. Un revival de las lámparas de los años 60 y 70 fabricadas con los mismos materiales: latón pulido o satinado. Las bombillas LED con efecto de cerámica blanca, que se piden por separado, recrean la impresión del cristal opalino de moda en la época.

Wand- und Tischleuchten mit Messingrahmen und E27-Fassung. Eine Neuinterpretation der Lampen der 1960er und 1970er Jahre aus den gleichen Materialien: poliertes oder satiniertes Messing. Die LED-Glühbirnen mit weißem Keramikeffekt, die separat zu bestellen sind, erzeugen den Eindruck von Opalglas, das damals in Mode war.

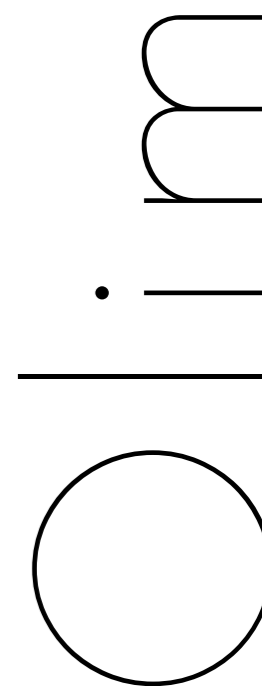

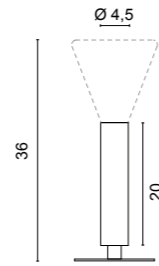

2515 Olim
 .21 Dorato lucido - Shiny gold
 .25 Dorato satinato - Satin gold

Light source not included
 E27 LED
 6W 2700K 600lm CRI>90 (01LP2)
 6W 2700K 600lm CRI>90 (01LP8)

1,00 Kg

Accensione ON-OFF
 ON-OFF switch

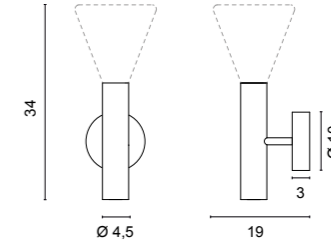
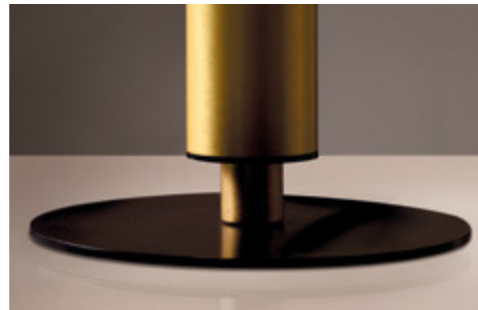

4608 Olim
 .21 Dorato lucido - Shiny gold
 .25 Dorato satinato - Satin gold

Light source not included
 E27 LED
 6W 2700K 600lm CRI>90 (01LP2)
 6W 2700K 600lm CRI>90 (01LP8)

0,60 Kg

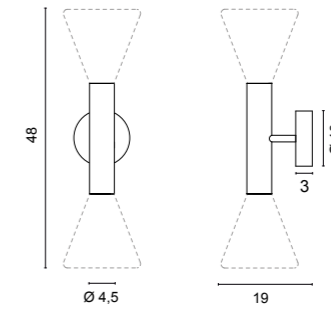

4609 Olim
 .21 Dorato lucido - Shiny gold
 .25 Dorato satinato - Satin gold

Light source not included
 E27 LED
 6W 2700K 600lm CRI>90 (01LP2)
 6W 2700K 600lm CRI>90 (01LP8)

0,70 Kg

Sorgenti - Bulbs



01LP2
 Porcellana - Porcelain

Color temperature	Light source	lm source
2700K	E27 LED 6W	600lm

CRI >90 Dim



01LP8
 Porcellana - Porcelain

Color temperature	Light source	lm source
2700K	E27 LED 6W	600lm

CRI >90 Dim

Codici finiture - Finishes codes



.21 .25

Sorgenti - Bulbs



01LP2
 Porcellana - Porcelain

Color temperature	Light source	lm source
2700K	E27 LED 6W	600lm

CRI >90 Dim



01LP8
 Porcellana - Porcelain

Color temperature	Light source	lm source
2700K	E27 LED 6W	600lm

CRI >90 Dim

Codici finiture - Finishes codes

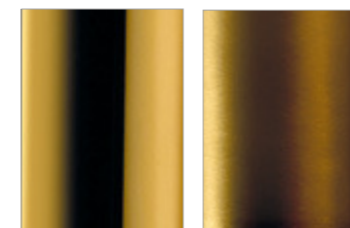

.21 .25



design **UT EgoLuce**
2020

328 330

Lampada a sospensione o da plafone a luce diretta con portalampada con attacco GU10 caratterizzata dallo spessore dell'alluminio e dall'assenza di viti. Disponibile in due lunghezze e in diverse finiture. La versione a sospensione può essere installata su una serie di rosone, da ordinare separatamente, oppure, con apposito accessorio, su binari elettrificati.

Suspension or ceiling lamp providing direct light with GU10 lamp holder characterised by the thickness of the aluminium and the absence of screws. Available in two lengths and different finishes. The suspension version can be installed on a series of ceiling roses, to be ordered separately, or, with a special accessory, on electrified tracks.

Suspension ou plafonnier à lumière directe avec douille GU10 caractérisé par l'épaisseur de l'aluminium et l'absence de vis. Disponible en deux longueurs et en différentes finitions. La version suspendue peut être installée sur une série de rosaces, à commander séparément, ou, avec un accessoire spécial, sur des rails électrifiés.

Lámpara de suspensión o techo de luz directa con portalámparas GU10 caracterizada por el grosor del aluminio y la ausencia de tornillos. Disponible en dos longitudes y diferentes acabados. La versión suspendida puede instalarse sobre una serie de florones a techo, que se piden por separado, o, con un accesorio especial, sobre railes electrificados.

Hänge- oder Deckenleuchte für direktes Licht mit GU10-Lampenfassung, die sich durch die Dicke des Aluminiums und das Fehlen von Schrauben auszeichnet. Erhältlich in zwei Längen und verschiedenen Ausführungen. Die hängende Version kann auf einem separat zu bestellenden Rosettensatz oder, mit einem speziellen Zubehör, auf elektrifizierten Schienen installiert werden.

egob
E

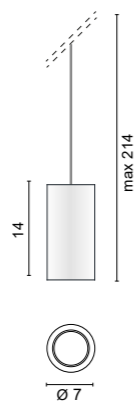

1660 Egotube System

- .01** Bianco - White
- .02** Nero - Black
- .35** Verniciato sabbia - Painted sand finishing
- .02.28** Nero, interno foglia rame - Black, copper leaf inside
- .02.29** Nero, interno foglia oro - Black, gold leaf inside
- .31.01** Cromato, interno bianco - Chromed, white inside

Light source not included

GU10 LED

7W 4000K 630lm (art. 0094/W)

7W 3000K 600lm (art. 0094/WW)

7W 2700K 580lm (art. 0094/XW)

7W 4000K 550lm (art. 0104/W) Dim

7W 3000K 530lm (art. 0104/WW) Dim

7W 2700K 510lm (art. 0104/XW) Dim



0,30 Kg

1661 Egotube System

- .01** Bianco - White
- .02** Nero - Black
- .35** Verniciato sabbia - Painted sand finishing
- .02.28** Nero, interno foglia rame - Black, copper leaf inside
- .02.29** Nero, interno foglia oro - Black, gold leaf inside
- .31.01** Cromato, interno bianco - Chromed, white inside

Light source not included

GU10 LED

7W 4000K 630lm (art. 0094/W)

7W 3000K 600lm (art. 0094/WW)

7W 2700K 580lm (art. 0094/XW)

7W 4000K 550lm (art. 0104/W) Dim

7W 3000K 530lm (art. 0104/WW) Dim

7W 2700K 510lm (art. 0104/XW) Dim



0,40 Kg

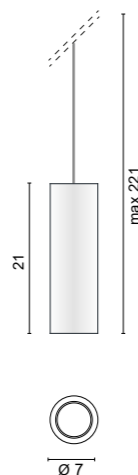

Codici finiture - Finishes codes



.01 **.02** **.35** **.02.28** **.02.29** **.31.01**



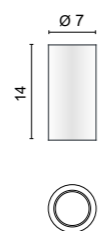

5660 Egotube

- .01** Bianco - *White*
- .02** Nero - *Black*
- .35** Verniciato sabbia - *Painted sand finishing*
- .02.28** Nero, interno foglia rame - *Black, copper leaf inside*
- .02.29** Nero, interno foglia oro - *Black, gold leaf inside*
- .31.01** Cromato, interno bianco - *Chromed, white inside*

Light source not included

GU10 LED

7W 4000K 630lm (art. 0094/W)

7W 3000K 600lm (art. 0094/WW)

7W 2700K 580lm (art. 0094/XW)

7W 4000K 550lm (art. 0104/W) Dim

7W 3000K 530lm (art. 0104/WW) Dim

7W 2700K 510lm (art. 0104/XW) Dim



0,30 Kg

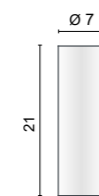

5661 Egotube

- .01** Bianco - *White*
- .02** Nero - *Black*
- .35** Verniciato sabbia - *Painted sand finishing*
- .02.28** Nero, interno foglia rame - *Black, copper leaf inside*
- .02.29** Nero, interno foglia oro - *Black, gold leaf inside*
- .31.01** Cromato, interno bianco - *Chromed, white inside*

Light source not included

GU10 LED

7W 4000K 630lm (art. 0094/W)

7W 3000K 600lm (art. 0094/WW)

7W 2700K 580lm (art. 0094/XW)

7W 4000K 550lm (art. 0104/W) Dim

7W 3000K 530lm (art. 0104/WW) Dim

7W 2700K 510lm (art. 0104/XW) Dim



0,40 Kg



Codici finiture - *Finishes codes*



.01 **.02** **.35** **.02.28** **.02.29** **.31.01**





design **ABS Studio**
2020

Lampada da plafone a luce diretta con portalampada con attacco GU10 caratterizzata dallo spessore dell'alluminio e dall'assenza di viti. Disponibile in due lunghezze e in diverse finiture.

Direct light ceiling lamp with GU10 socket characterised by the thickness of the aluminium and the absence of screws. Available in two lengths and different finishes.

Plafonnier à lumière directe avec douille GU10 caractérisé par l'épaisseur de l'aluminium et l'absence de vis. Disponible en deux longueurs et en différentes finitions.

Lámpara de techo de luz directa con casquillo GU10 caracterizada por el grosor del aluminio y la ausencia de tornillos. Disponible en dos longitudes y diferentes acabados.

Direkt beleuchtete Deckenleuchte mit GU10-Fassung, die sich durch die Dicke des Aluminiums und das Fehlen von Schrauben auszeichnet. Erhältlich in zwei Längen und verschiedenen Ausführungen.

Egokube

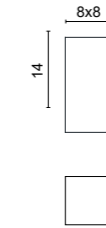
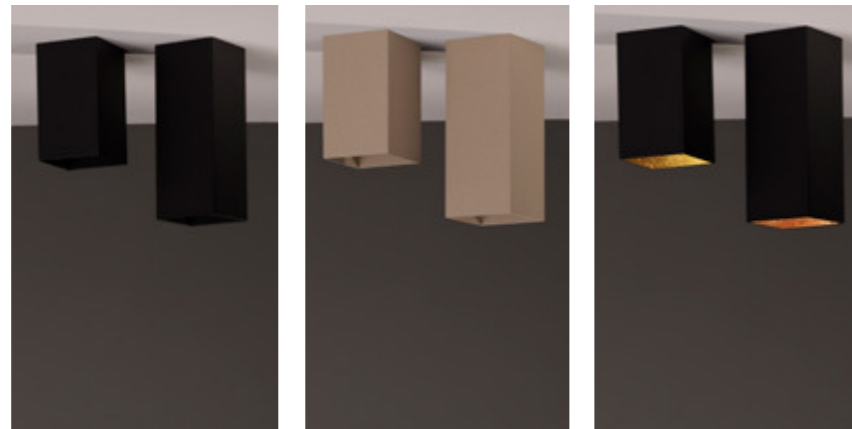

5664 Egokube

- .01 Bianco - White
- .02 Nero - Black
- .35 Verniciato sabbia - Painted sand finishing
- .02.28 Nero, interno foglia rame - Black, copper leaf inside
- .02.29 Nero, interno foglia oro - Black, gold leaf inside

Light source not included

GU10 LED

7W 4000K 630lm (art. 0094/W)

7W 3000K 600lm (art. 0094/WW)

7W 2700K 580lm (art. 0094/XW)

7W 4000K 550lm (art. 0104/W) Dim

7W 3000K 530lm (art. 0104/WW) Dim

7W 2700K 510lm (art. 0104/XW) Dim



0,30 Kg



5665 Egokube

- .01 Bianco - White
- .02 Nero - Black
- .35 Verniciato sabbia - Painted sand finishing
- .02.28 Nero, interno foglia rame - Black, copper leaf inside
- .02.29 Nero, interno foglia oro - Black, gold leaf inside

Light source not included

GU10 LED

7W 2700K 580lm (art. 0094/XW)

7W 3000K 600lm (art. 0094/WW)

7W 4000K 630lm (art. 0094/W)

7W 2700K 510lm (art. 0104/XW) Dim

7W 3000K 530lm (art. 0104/WW) Dim

7W 4000K 550lm (art. 0104/W) Dim



0,40 Kg

Codici finiture - Finishes codes

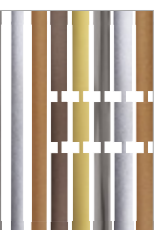
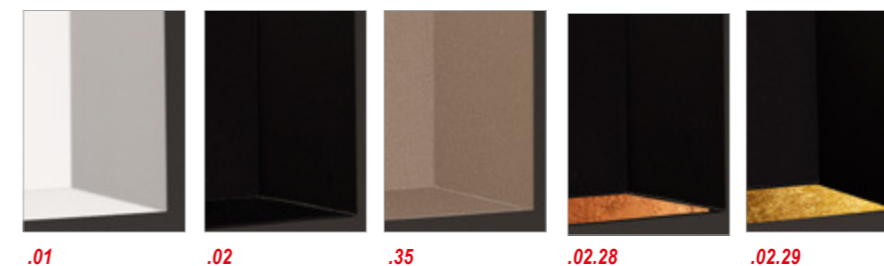

design **ABS Studio**
2020

Lampada da plafone di facile installazione a luce diretta con portalampana con attacco GU10 e caratterizzata dallo spessore dell'alluminio e dall'assenza delle viti. La forma a taglio la rende ideale per creare un semplice effetto wall-washer.

Easy-to-install ceiling lamp providing direct light with a GU10 socket and characterised by the thickness of the aluminium and the absence of screws. The cut-out shape makes it ideal for creating a wall-washer effect.

Plafonnier à lumière directe, facile à installer, doté d'une douille GU10 et caractérisé par l'épaisseur de l'aluminium et l'absence de vis. La forme découpée est idéale pour créer un effet wall-washer.

Lámpara de techo de fácil instalación que proporciona luz directa con una toma GU10 y se caracteriza por el grosor del aluminio y la ausencia de tornillos. La forma recortada la hace ideal para crear un efecto wall-washer.

Einfach zu installierende Deckenleuchte für direktes Licht mit einer GU10-Fassung, die sich durch die Dicke des Aluminiums und das Fehlen von Schrauben auszeichnet. Die Form des Ausschnitts ist ideal, um einen wall-washer effekt zu erzielen.

Cut

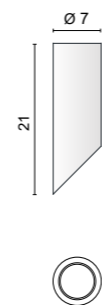
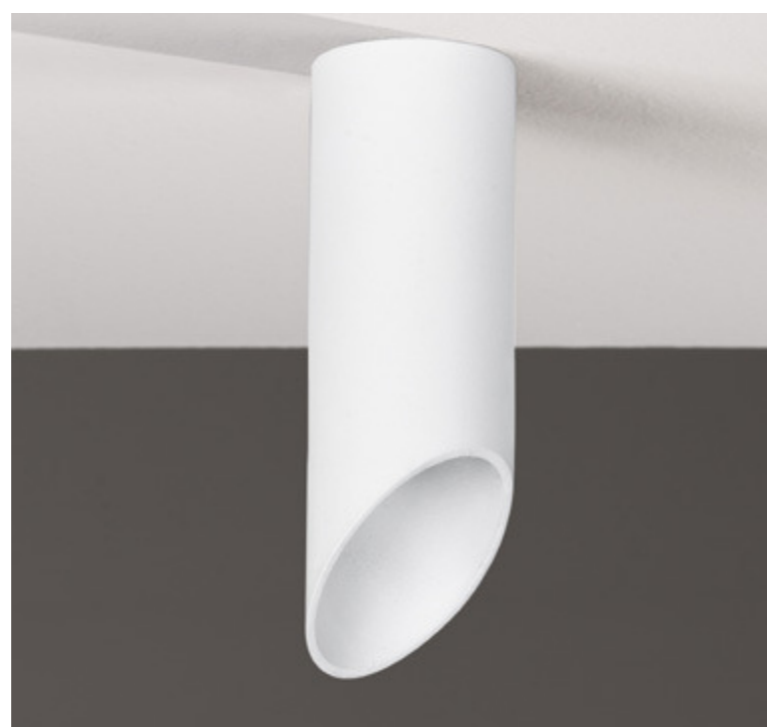

5662 Cut

- .01 Bianco - White
- .02 Nero - Black

Light source not included

GU10 LED

7W 4000K 630lm (art. 0094/W)

7W 3000K 600lm (art. 0094/WW)

7W 2700K 580lm (art. 0094/XW)

7W 4000K 550lm (art. 0104/W) Dim

7W 3000K 530lm (art. 0104/WW) Dim

7W 2700K 510lm (art. 0104/XW) Dim



0,35 Kg



Codici finiture - Finishes codes



.01

.02

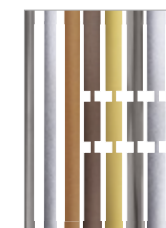

Cut





design F. Renzi
2013

338 339

Lampada a sospensione o da plafone in vetro Pyrex trasparente con inserto bianco o nero/oro e portalampada con attacco E27. La versione a sospensione può essere installata su una serie di rosoni, da ordinare separatamente, oppure, con apposito accessorio, su binari elettrificati (p. 340).

Suspension or ceiling lamp in transparent Pyrex glass with white or black/gold insert and lamp holder with E27 socket. The suspension version can be installed on a series of ceiling roses, to be ordered separately, or, with a special accessory, on electrified tracks (p. 340).

Suspension ou plafonnier en verre Pyrex transparent avec insert blanc ou noir/doré et douille avec prise E27. La version suspendue peut être installée sur une série de rosaces, à commander séparément, ou, avec un accessoire spécial, sur des rails électrifiés (p. 340).

Lámpara de suspensión o de techo de cristal Pyrex transparente con inserto blanco o negro/oro y portalámparas con casquillo E27. La versión suspendida puede instalarse sobre una serie de florones a techo, que se piden por separado, o, con un accesorio especial, sobre raíles electrificados (p. 340).

Hänge- oder Deckenleuchte aus transparentem Pyrexglas mit weißem oder schwarz/goldenem Einsatz und Lampenfassung mit E27-Fassung. Die hängende Version kann auf einem separat zu bestellenden Rosettensatz oder, mit einem speziellen Zubehör, auf elektrifizierten Schienen installiert werden (S. 340).

Prêt-à-Porter

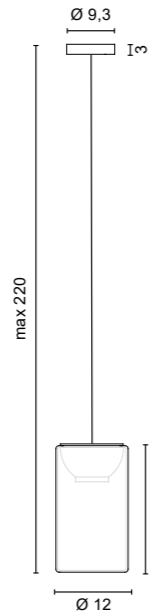

1516 Prêt-à-Porter

- .01** Vetro Pyrex trasparente con inserto bianco
Clear Pyrex glass with white insert
- .02.21** Vetro Pyrex trasparente con inserto nero, interno oro
Transparent Pyrex glass with black insert, gold inside

Light source not included

E27 LED

8W 1055lm (art. 0109/8/...)

11W 1521lm (art. 0109/11/...)



1,00 Kg

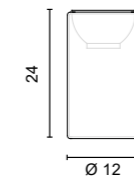

5233 Prêt-à-Porter

- .01** Vetro Pyrex trasparente con inserto bianco
Clear Pyrex glass with white insert
- .02.21** Vetro Pyrex trasparente con inserto nero, interno oro
Transparent Pyrex glass with black insert, gold inside

Light source not included

E27 LED

8W 1055lm (art. 0109/8/...)

11W 1521lm (art. 0109/11/...)



1,00 Kg

Codici finiture - Finishes codes



.01

.02.21



Codici finiture - Finishes codes



.01

.02.21

Rosoni - Ceiling rose

0607 

IN: 50/60Hz 220-240V

ROSONE IN POLICARBONATO - 1 LAMPADA
POLYCARBONATE CEILING ROSE - 1 LAMP

Code Codici finiture - Finishes codes
0607 .01 Bianco - White
0607 .02 Nero - Black
0607 .35 Verniciato sabbia - Painted sand finishing

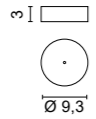





0976/1 

IN: 50/60Hz 220-240V

ROSONE IN METALLO - 1 LAMPADA
METALL CEILING ROSE - 1 LAMP

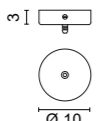
Code Codici finiture - Finishes codes
0976/1 .01 Bianco - White
0976/1 .02 Nero - Black
0976/1 .71 Fumè con bloccacavo in ottone - Fumè with brass cable lock



 0,20 Kg

0976/2 

IN: 50/60Hz 220-240V

ROSONE IN METALLO - 2 LAMPADE
METALL CEILING ROSE - 2 LAMPS

Code Codici finiture - Finishes codes
0976/2 .01 Bianco - White
0976/2 .02 Nero - Black
0976/2 .71 Fumè con bloccacavo in ottone - Fumè with brass cable lock

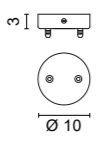

 0,20 Kg

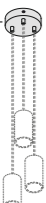
0976/3 

IN: 50/60Hz 220-240V

ROSONE IN METALLO - 3 LAMPADE
METALL CEILING ROSE - 3 LAMPS

Code Codici finiture - Finishes codes
0976/3 .01 Bianco - White
0976/3 .02 Nero - Black
0976/3 .71 Fumè con bloccacavo in ottone - Fumè with brass cable lock

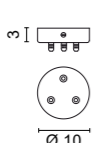

 0,20 Kg



0947 

IN: 50/60Hz 220-240V

ROSONE PER CARTONGESSO - 1 LAMPADA
PLASTERBOARD CEILING ROSE - 1 LAMPS

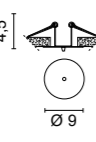
Code Codici finiture - Finishes codes
0947 .01 Bianco - White
0947 .02 Nero - Black
0947 .35 Verniciato sabbia - Painted sand finishing



  7,5 cm

0604 

IN: 50/60Hz 220-240V

ROSONE SENZA INTERRUTTORE - 1 LAMPADA
CEILING ROSE WITHOUT SWITCH - 1 LAMP

Code Codici finiture - Finishes codes
0604 .01 Bianco - White
0604 .02 Nero - Black

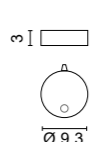





E1000 

ROSONE A SCOMPRSA EUREKA SENZA DRIVER PER CARTONGESSO
EUREKA CEILING ROSE WITHOUT DRIVER FOR PLASTERBOARD

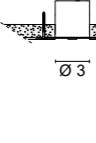
Code Codici finiture - Finishes codes
E1000 .01 Bianco - White
E1000 .02 Nero - Black



Adattatore /osospensione per binari - Track adapter/suspension



0985 

IN: 50/60Hz 220-240V

ADATTATORE PER BINARIO 230V MONOFASE - 1 LAMPADA
ADAPTER FOR 230V SINGLE-PHASE TRACK - 1 LAMP

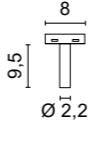
Code Codici finiture - Finishes codes
0985 .01 Bianco - White
0985 .02 Nero - Black



  



0989 

IN: 50/60Hz 220-240V

ADATTATORE PER BINARIO 230V TRIFASE - 1 LAMPADA
ADAPTER FOR 230V THREE-PHASE TRACK - 1 LAMP

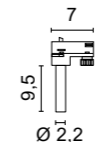
Code Codici finiture - Finishes codes
0989 .01 Bianco - White
0989 .02 Nero - Black



Accessori - Accessories

0605 

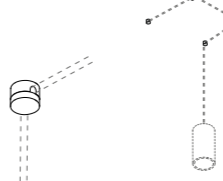
Deviatore e decentratore
Displacement element

Ø 1,7 H 2,2

.01 Bianco - White
.02 Nero - Black

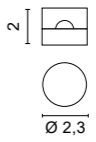

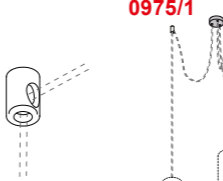
0975/1 

1 Decentratore per soffitto in ottone satinato
1 Satin brass displacement element for ceiling fixing

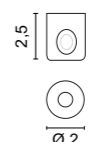



Art. 0607.01



Art. 0976/3.01

Rosoni - Ceiling rose

0613/3

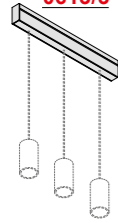

IN: 50/60Hz 220-240V

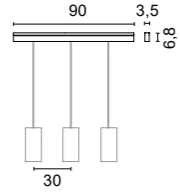

ROSONE - 3 LAMPADE
CEILING ROSE - 3 LAMPS

Code	Codici finiture - Finishes codes
0613/3	.01 Bianco - White
0613/3	.02 Nero - Black
0613/3	.35 Verniciato sabbia - Painted sand finishing



1,10 Kg

0613/4

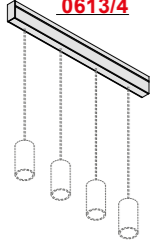

IN: 50/60Hz 220-240V

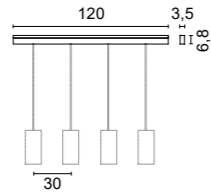

ROSONE - 4 LAMPADE
CEILING ROSE - 4 LAMPS

Code	Codici finiture - Finishes codes
0613/4	.01 Bianco - White
0613/4	.02 Nero - Black
0613/4	.35 Verniciato sabbia - Painted sand finishing



1,30 Kg

0613/6

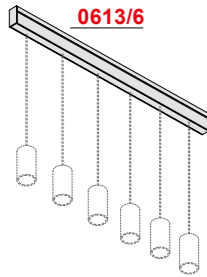

IN: 50/60Hz 220-240V

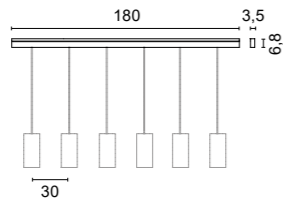

ROSONE - 6 LAMPADE
CEILING ROSE - 6 LAMPS

Code	Codici finiture - Finishes codes
0613/6	.01 Bianco - White
0613/6	.02 Nero - Black
0613/6	.35 Verniciato sabbia - Painted sand finishing



1,50 Kg



Art. 0613/3.01



Art. 0978/2.01



Art. 0600.01

Rosoni - Ceiling rose

0603

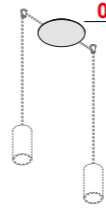

IN: 50/60Hz 220-240V

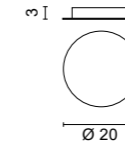

ROSONE 1-4 LAMPADE
CEILING ROSE - 1-4 LAMPS

Code	Codici finiture - Finishes codes
0603	.01 Bianco - White
0603	.02 Nero - Black



0,50 Kg

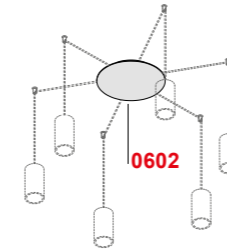

IN: 50/60Hz 220-240V

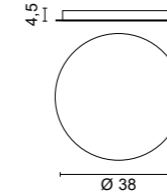

ROSONE - 1-12 LAMPADE
CEILING ROSE - 1-12 LAMPS

Code	Codici finiture - Finishes codes
0602	.01 Bianco - White
0602	.02 Nero - Black



1,70 Kg

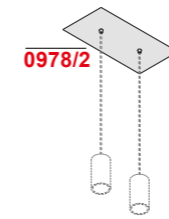

IN: 50/60Hz 220-240V

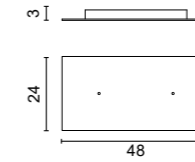

ROSONE - 2 LAMPADE
CEILING ROSE - 2 LAMPS

Code	Codici finiture - Finishes codes
0978/2	.01 Bianco - White
0978/2	.02 Nero - Black



2,00 Kg

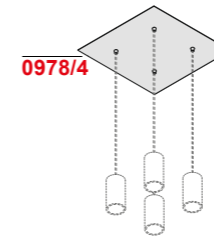

IN: 50/60Hz 220-240V

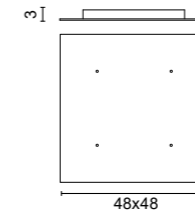

ROSONE - 4 LAMPADE
CEILING ROSE - 4 LAMPS

Code	Codici finiture - Finishes codes
0978/4	.01 Bianco - White
0978/4	.02 Nero - Black



3,80 Kg

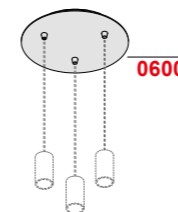

IN: 50/60Hz 220-240V

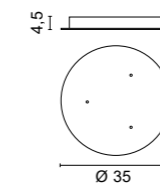

ROSONE - 3 LAMPADE
CEILING ROSE - 3 LAMPS

Code	Codici finiture - Finishes codes
0600	.01 Bianco - White
0600	.02 Nero - Black
0600	.35 Verniciato sabbia - Painted sand finishing



0,50 Kg

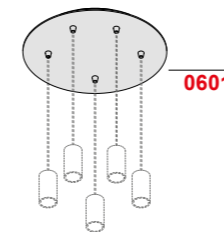

IN: 50/60Hz 220-240V

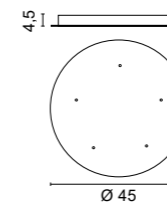

ROSONE - 5 LAMPADE
CEILING ROSE - 5 LAMPS

Code	Codici finiture - Finishes codes
0601	.01 Bianco - White
0601	.02 Nero - Black
0601	.35 Verniciato sabbia - Painted sand finishing



1,70 Kg



design **ABS Studio**
2015

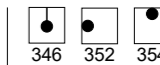

346 352 354

Famiglia di lampade di facile installazione a luce diffusa con struttura in estruso d'alluminio, diffusore in metacrilato e alimentatore integrato. Disponibile in diverse tipologie, dimensioni, finiture, potenze. Realizzabile in versione mono o doppia emissione, con schermo UGR o con proiettori Newton integrati.

Family of easy-to-install diffused light lamps with an extruded aluminium structure, methacrylate diffuser and integrated driver. Available in different types, sizes, finishes, wattages. Realizable in single or double emission version, with UGR screen or with integrated Newton projectors.

Famille de lampes à lumière diffuse faciles à installer, avec une structure en aluminium extrudé, un diffuseur en méthacrylate et driver intégré. Disponibles en différents types, tailles, finitions et puissances. Existe en version simple ou double émission, avec écran UGR ou avec projecteurs Newton intégrés.

Familia de lámparas de luz difusa de fácil instalación con estructura de aluminio extruido, difusor de metacrilato y driver integrado. Disponibles en diferentes tipos, tamaños, acabados y potencias. Existe en versiones de emisión simple o doble, con pantalla UGR o con proyectores Newton integrados.

Familie von leicht zu installierenden Streulichtlampen mit einer Struktur aus stranggepresstem Aluminium, Methacrylat-Diffusor und integriertem Driver. Erhältlich in verschiedenen Typen, Größen, Ausführungen und Wattagen. Erhältlich in Versionen mit einfacher oder doppelter Emission, mit UGR-Bildschirm oder mit integrierten Newton-Projektoren.

Rail

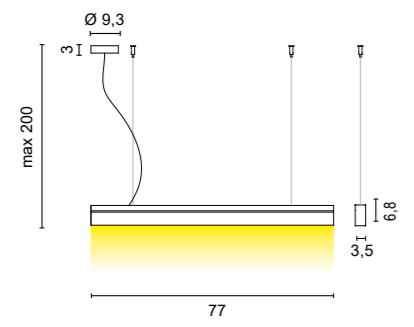

- 1541 Rail**
- .01 Bianco - White
 - .02 Nero - Black
 - .85 Verniciato argento - Painted silver
 - .85 Verniciato oro - Painted gold
 - .87 Verniciato rame - Painted copper
 - .88 Verniciato bronzo - Painted bronze

Color temperature	LED Light source	lm source
/W 4000K	13,5W	1695lm
/WW 3000K	13,5W	1515lm
/XW 2700K	13,5W	1417lm

1,10 Kg

Dimmerabile PUSH - 1...10V - DALI su richiesta
 Dimmable PUSH - 1...10V - DALI on request

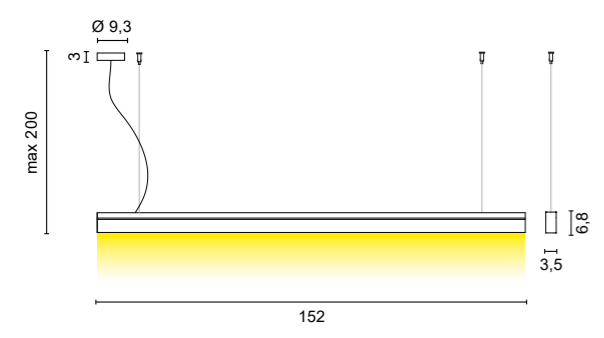

- 1542 Rail**
- .01 Bianco - White
 - .02 Nero - Black
 - .85 Verniciato argento - Painted silver
 - .85 Verniciato oro - Painted gold
 - .87 Verniciato rame - Painted copper
 - .88 Verniciato bronzo - Painted bronze

Color temperature	LED Light source	lm source
/W 4000K	27W	3390lm
/WW 3000K	27W	3030lm
/XW 2700K	27W	2835lm

2,10 Kg

Dimmerabile PUSH - 1...10V - DALI su richiesta
 Dimmable PUSH - 1...10V - DALI on request



CUSTOM SIZE Tabella lunghezze disponibili - Table of available lengths

cm	watt	2700K (XW)	lm source	3000K (WW)	lm source	4000K (W)	lm source
** 77	13,5W	1541 * /XW	1417	1541 * /WW	1515	1541 * /W	1695
102	18W	A1541 * /100/XW	1890	A1541 * /100/WW	2020	A1541 * /100/W	2260
127	22,5W	A1541 * /125/XW	2362	A1541 * /125/WW	2525	A1541 * /125/W	2825
** 152	27W	1542 * /XW	2835	1542 * /WW	3030	1542 * /W	3390
177	31,5W	A1541 * /175/XW	3307	A1541 * /175/WW	3535	A1541 * /175/W	3955
202	36W	A1541 * /200/XW	3780	A1541 * /200/WW	4040	A1541 * /200/W	4520
227	40,5W	A1541 * /225/XW	4252	A1541 * /225/WW	4545	A1541 * /225/W	5085
252	45W	A1541 * /250/XW	4725	A1541 * /250/WW	5050	A1541 * /250/W	5650
277	49,5W	A1541 * /275/XW	5197	A1541 * /275/WW	5555	A1541 * /275/W	6215
302	54W	A1541 * /300/XW	5670	A1541 * /300/WW	6060	A1541 * /300/W	6780

** Articolo standard a catalogo - Standard catalogue item
 Il codice prodotto si riferisce alla lampada completa di diffusore in metacrilato satinato e di 2 testate di chiusura
 The product code refers to the lamp complete with satin methacrylate diffuser and 2 end caps

* Codici finiture - Finishes codes

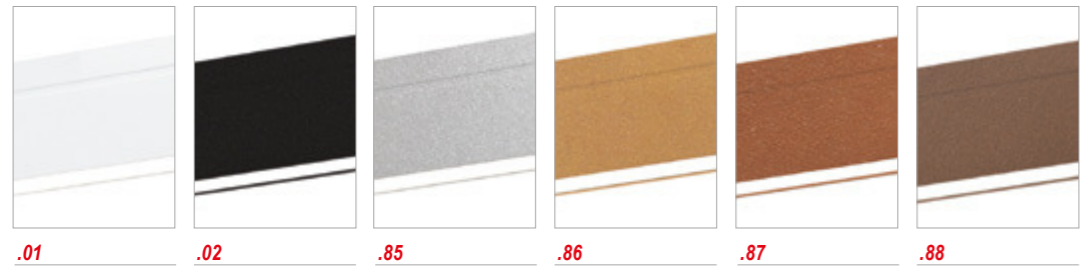

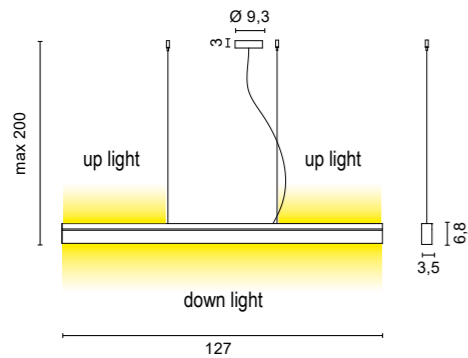

1545 Rail Biemission

- .01** Bianco - *White*
- .02** Nero - *Black*
- .85** Verniciato argento - *Painted silver*
- .85** Verniciato oro - *Painted gold*
- .87** Verniciato rame - *Painted copper*
- .88** Verniciato bronzo - *Painted bronze*

Color temperature	LED Light source	lm source
/W 4000K	37,5W	1883lm up light + 2825lm down light
/WW 3000K	37,5W	1683lm up light + 2525lm down light
/XW 2700K	37,5W	1575lm up light + 2362lm down light

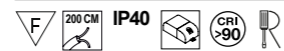

1,90 Kg

Dimmerabile PUSH - 1...10V - DALI su richiesta
 Dimmable PUSH - 1...10V - DALI on request



CUSTOM SIZE Tabella lunghezze disponibili - *Table of available lengths*

cm	watt	2700K (XW)	lm up	lm down	3000K (WW)	lm up	lm down	4000K (W)	lm up	lm down
** 127	37,5W	1545 * /XW	1575	2362	1545 * /WW	1683	2525	1545 * /W	1883	2825
152	45W	A1545 * /150XW	1890	2835	A1545 * /150WW	2020	3030	A1545 * /150W	2260	3390
177	55,5W	A1545 * /175XW	2520	3307	A1545 * /175WW	2693	3535	A1545 * /175W	3013	3955
202	60W	A1545 * /200XW	2520	3780	A1545 * /200WW	2693	4040	A1545 * /200W	3013	4520
227	67,5W	A1545 * /225XW	2835	4252	A1545 * /225WW	3030	4545	A1545 * /225W	3390	5085
252	75W	A1545 * /250XW	3150	4725	A1545 * /250WW	3366	5050	A1545 * /250W	3797	5650
277	82,5W	A1545 * /275XW	3465	5197	A1545 * /275WW	3703	5555	A1545 * /275W	4143	6215
302	93W	A1545 * /300XW	4095	5670	A1545 * /300WW	4377	6060	A1545 * /300W	4897	6780

** Articolo standard a catalogo - *Standard catalogue item*

Il codice prodotto si riferisce alla lampada completa di diffusore in metacrilato satinato e di 2 testate di chiusura
 The product code refers to the lamp complete with satin methacrylate diffuser and 2 end caps

* Codici finiture - *Finishes codes*

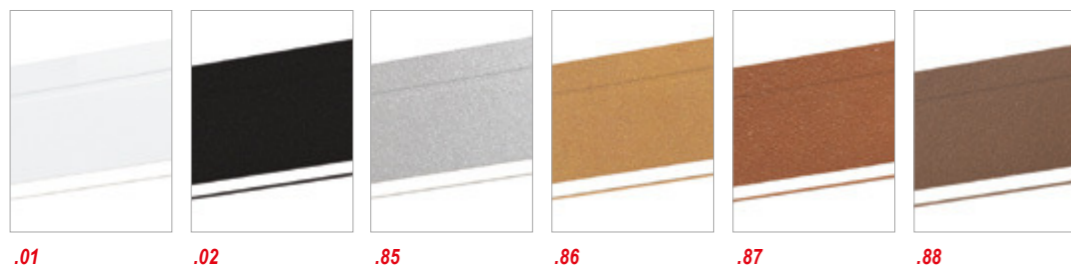

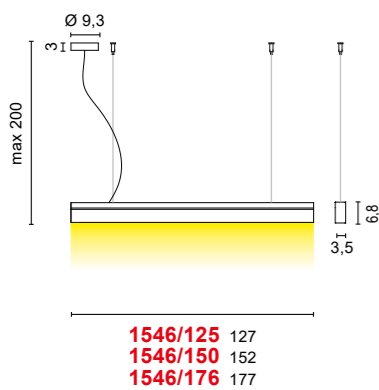

1547 Rail UGR
.01 Bianco - White

127 cm		1,80 Kg
Color temperature	LED Light source	lm source
/125/W 4000K	31W	3440lm
/125/MW 3000K	31W	3000lm
/125/XW 2700K	31W	2860lm

152 cm		2,10 Kg
Color temperature	LED Light source	lm source
/150/W 4000K	37,5W	4130lm
/150/MW 3000K	37,5W	3600lm
/150/XW 2700K	37,5W	3440lm

177 cm		2,50 Kg
Color temperature	LED Light source	lm source
/175/W 4000K	44W	4800lm
/175/MW 3000K	44W	4200lm
/175/XW 2700K	44W	4000lm



Dimmerabile PUSH - 1...10V - DALI su richiesta
Dimmable PUSH - 1...10V - DALI on request

Con schermo microprismato ad alta efficienza
Whit high efficiency microprismatic diffuser

Codici finiture - Finishes codes



.01

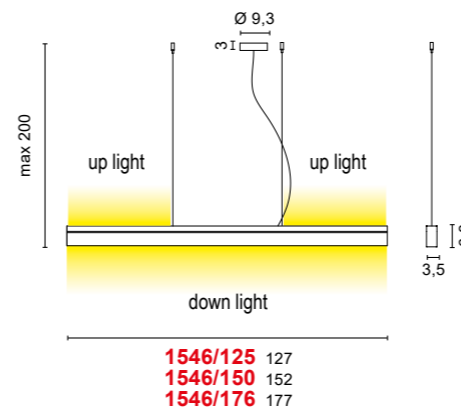

1546 Rail Biemission UGR
.01 Bianco - White

127 cm		1,90 Kg
Color temperature	LED Light source	lm source
/125/W 4000K	46W	1883lm up light + 3440lm down light
/125/MW 3000K	46W	1683lm up light + 3000lm down light
/125/XW 2700K	46W	1575lm up light + 2860lm down light

152 cm		2,30 Kg
Color temperature	LED Light source	lm source
/150/W 4000K	55,5W	2260lm up light + 4130lm down light
/150/MW 3000K	55,5W	2020lm up light + 3600lm down light
/150/XW 2700K	55,5W	1890lm up light + 3440lm down light

177 cm		2,70 Kg
Color temperature	LED Light source	lm source
/175/W 4000K	68W	3013lm up light + 4800lm down light
/175/MW 3000K	68W	2693lm up light + 4200lm down light
/175/XW 2700K	68W	2520lm up light + 4000lm down light



Dimmerabile PUSH - 1...10V - DALI su richiesta
Dimmable PUSH - 1...10V - DALI on request

Con schermo microprismato ad alta efficienza
Whit high efficiency microprismatic diffuser

Codici finiture - Finishes codes



.01



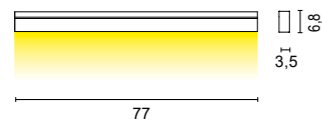

4578 Rail

.01 Bianco - White

Color temperature	LED Light source	lm source
/W 4000K	13,5W	1695lm
/WW 3000K	13,5W	1515lm
/XW 2700K	13,5W	1417lm



1,10 Kg

Dimmerabile PUSH - 1...10V - DALI su richiesta
Dimmable PUSH - 1...10V - DALI on request

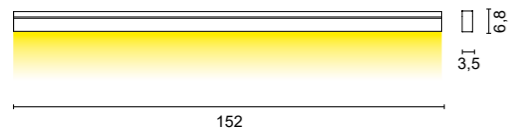

4579 Rail

.01 Bianco - White

Color temperature	LED Light source	lm source
/W 4000K	27W	3390lm
/WW 3000K	27W	3030lm
/XW 2700K	27W	2835lm

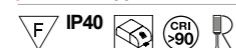

2,00 Kg

Dimmerabile PUSH - 1...10V - DALI su richiesta
Dimmable PUSH - 1...10V - DALI on request



CUSTOM SIZE Tabella lunghezze disponibili - Table of available lengths

cm	watt	2700K (XW)	lm source	3000K (WW)	lm source	4000K (W)	lm source
** 77	13,5W	4578 * /XW	1417	4578 * /WW	1515	4578 * /W	1695
102	18W	A4578 * /100/XW	1890	A4578 * /100/WW	2020	A4578 * /100/W	2260
127	22,5W	A4578 * /125/XW	2362	A4578 * /125/WW	2525	A4578 * /125/W	2825
** 152	27W	4579 * /XW	2835	4579 * /WW	3030	4579 * /W	3390
177	31,5W	A4578 * /175/XW	3307	A4578 * /175/WW	3535	A4578 * /175/W	3955
202	36W	A4578 * /200/XW	3780	A4578 * /200/WW	4040	A4578 * /200/W	4520
227	40,5W	A4578 * /225/XW	4252	A4578 * /225/WW	4545	A4578 * /225/W	5085
252	45W	A4578 * /250/XW	4725	A4578 * /250/WW	5050	A4578 * /250/W	5650
277	49,5W	A4578 * /275/XW	5197	A4578 * /275/WW	5555	A4578 * /275/W	6215
302	54W	A4578 * /300/XW	5670	A4578 * /300/WW	6060	A4578 * /300/W	6780

** Articolo standard a catalogo - Standard catalogue item

Il codice prodotto si riferisce alla lampada completa di diffusore in policarbonato satinato e di 2 testate di chiusura
The product code refers to the lamp complete with satin polycarbonate diffuser and 2 end caps

* Codici finiture - Finishes codes



.01



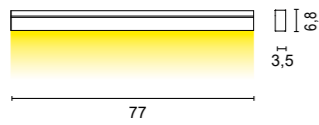

5540 Rail

.01	Bianco - White
.02	Nero - Black
.85	Verniciato argento - Painted silver
.85	Verniciato oro - Painted gold
.87	Verniciato rame - Painted copper
.88	Verniciato bronzo - Painted bronze

Color temperature	LED Light source	lm source
/W 4000K	13,5W	1695lm
/WW 3000K	13,5W	1515lm
/XW 2700K	13,5W	1417lm



Dimmerabile PUSH - 1...10V - DALI su richiesta
Dimmable PUSH - 1...10V - DALI on request

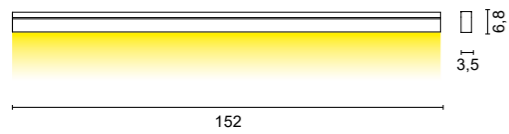

5541 Rail

.01	Bianco - White
.02	Nero - Black
.85	Verniciato argento - Painted silver
.85	Verniciato oro - Painted gold
.87	Verniciato rame - Painted copper
.88	Verniciato bronzo - Painted bronze

Color temperature	LED Light source	lm source
/W 4000K	27W	3390lm
/WW 3000K	27W	3030lm
/XW 2700K	27W	2835lm



Dimmerabile PUSH - 1...10V - DALI su richiesta
Dimmable PUSH - 1...10V - DALI on request

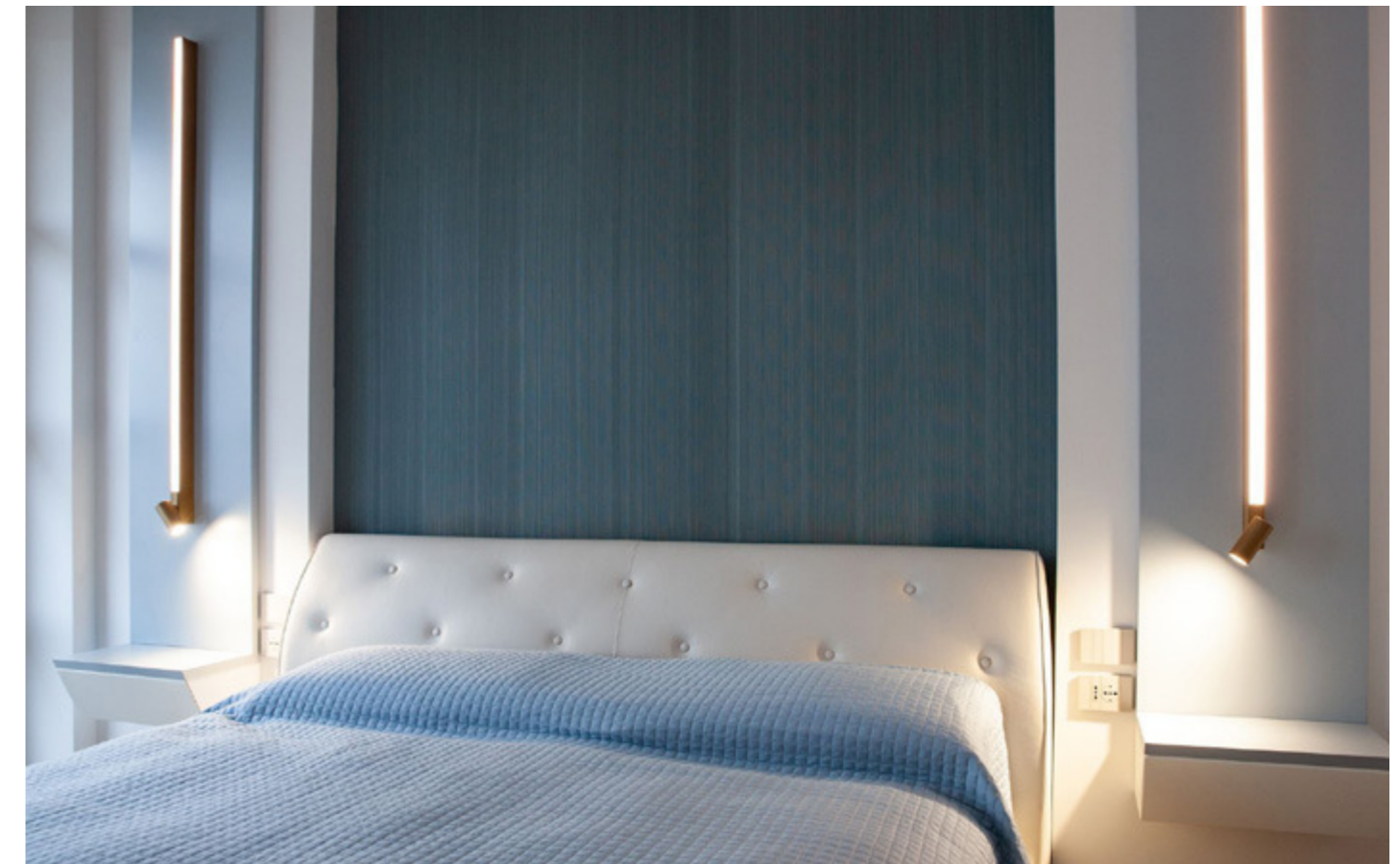

Esempio di installazione con Rail 5541 + Newton 6347
Installation example with Rail 5541 + Newton 6347

CUSTOM SIZE Tabella lunghezze disponibili - Table of available lengths

cm	watt	2700K (XW)	lm source	3000K (WW)	lm source	4000K (W)	lm source
** 77	13,5W	5540 * /XW	1417	5540 * /WW	1515	5540 * /W	1695
102	18W	A5540 * /100/XW	1890	A5540 * /100/WW	2020	A5540 * /100/W	2260
127	22,5W	A5540 * /125/XW	2362	A5540 * /125/WW	2525	A5540 * /125/W	2825
** 152	27W	5541 * /XW	2835	5541 * /WW	3030	5541 * /W	3390
177	31,5W	A5540 * /175/XW	3307	A5540 * /175/WW	3535	A5540 * /175/W	3955
202	36W	A5540 * /200/XW	3780	A5540 * /200/WW	4040	A5540 * /200/W	4520
227	40,5W	A5540 * /225/XW	4252	A5540 * /225/WW	4545	A5540 * /225/W	5085
252	45W	A5540 * /250/XW	4725	A5540 * /250/WW	5050	A5540 * /250/W	5650
277	49,5W	A5540 * /275/XW	5197	A5540 * /275/WW	5555	A5540 * /275/W	6215
302	54W	A5540 * /300/XW	5670	A5540 * /300/WW	6060	A5540 * /300/W	6780

** Articolo standard a catalogo - Standard catalogue item

Il codice prodotto si riferisce alla lampada completa di diffusore in policarbonato satinato e di 2 testate di chiusura
The product code refers to the lamp complete with satin polycarbonate diffuser and 2 end caps

* Codici finiture - Finishes codes

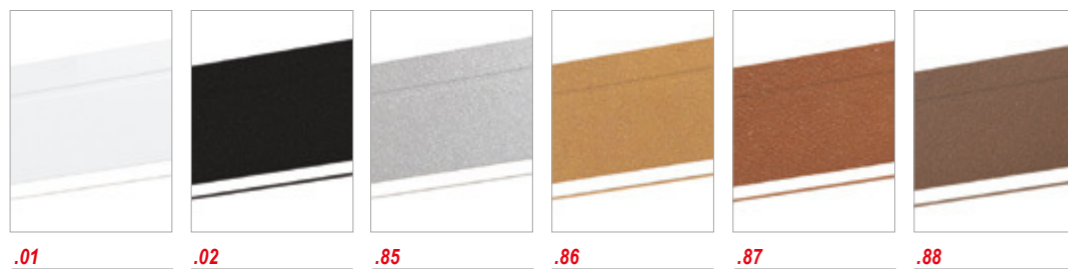



design **ABS Studio**
2017

358 360

Lampada a luce diffusa con struttura in estruso d'alluminio, diffusore in metacrilato e alimentatore integrato. Rail Quadra è pensata come un'unica grande cornice, un percorso chiuso di luce che definisce e sottolinea lo spazio sottostante. Disponibile a sospensione e da plafone, in diverse finiture e, su richiesta, in versione dimmerabile.

Diffused light lamp with an extruded aluminium structure, methacrylate diffuser and integrated driver. Rail Quadra is designed as a single large frame, a closed path of light that defines and emphasises the space below. Available as a pendant and surface mounted luminaire, in various finishes and, on request, in a dimmable version.

Lampe à lumière diffuse avec une structure en aluminium extrudé, un diffuseur en méthacrylate et driver intégré. Rail Quadra est conçu comme un seul grand cadre, un chemin de lumière fermé qui définit et met en valeur l'espace situé en dessous. Disponible en tant que luminaire suspendu ou apparent, dans différentes finitions et, sur demande, dans une version à gradation.

Lámpara de luz difusa con estructura de aluminio extruido, difusor de metacrilato y driver integrado. Rail Quadra está diseñada como un único gran marco, una trayectoria cerrada de luz que define y enfatiza el espacio inferior. Disponible como luminaria de suspensión y de superficie, en varios acabados y, bajo pedido, en versión regulable.

Leuchte mit diffusem Licht mit einer Struktur aus stranggepresstem Aluminium, einem Diffusor aus Methacrylat und integriertem Driver. Rail Quadra ist als ein einziger großer Rahmen konzipiert, ein geschlossener Lichtweg, der den darunter liegenden Raum definiert und hervorhebt. Erhältlich als Pendel- und Anbauleuchte, in verschiedenen Ausführungen und auf Anfrage auch in einer dimmbaren Version.

Rail Quadra

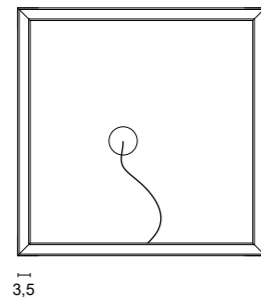
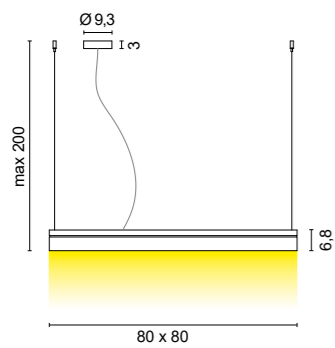

1561 Rail Quadra

- .01** Bianco - *White*
- .02** Nero - *Black*
- .85** Verniciato argento - *Painted silver*
- .85** Verniciato oro - *Painted gold*
- .87** Verniciato rame - *Painted copper*
- .88** Verniciato bronzo - *Painted bronze*

Color temperature	LED Light source	lm source
/W 4000K	54W	6780lm
/WW 3000K	54W	6060lm
/XW 2700K	54W	5670lm



3,80 Kg

Dimmerabile PUSH - 1...10V - DALI su richiesta
 Dimmable PUSH - 1...10V - DALI on request

Biemissione su richiesta
 Biemission on request

Codici finiture - *Finishes codes*

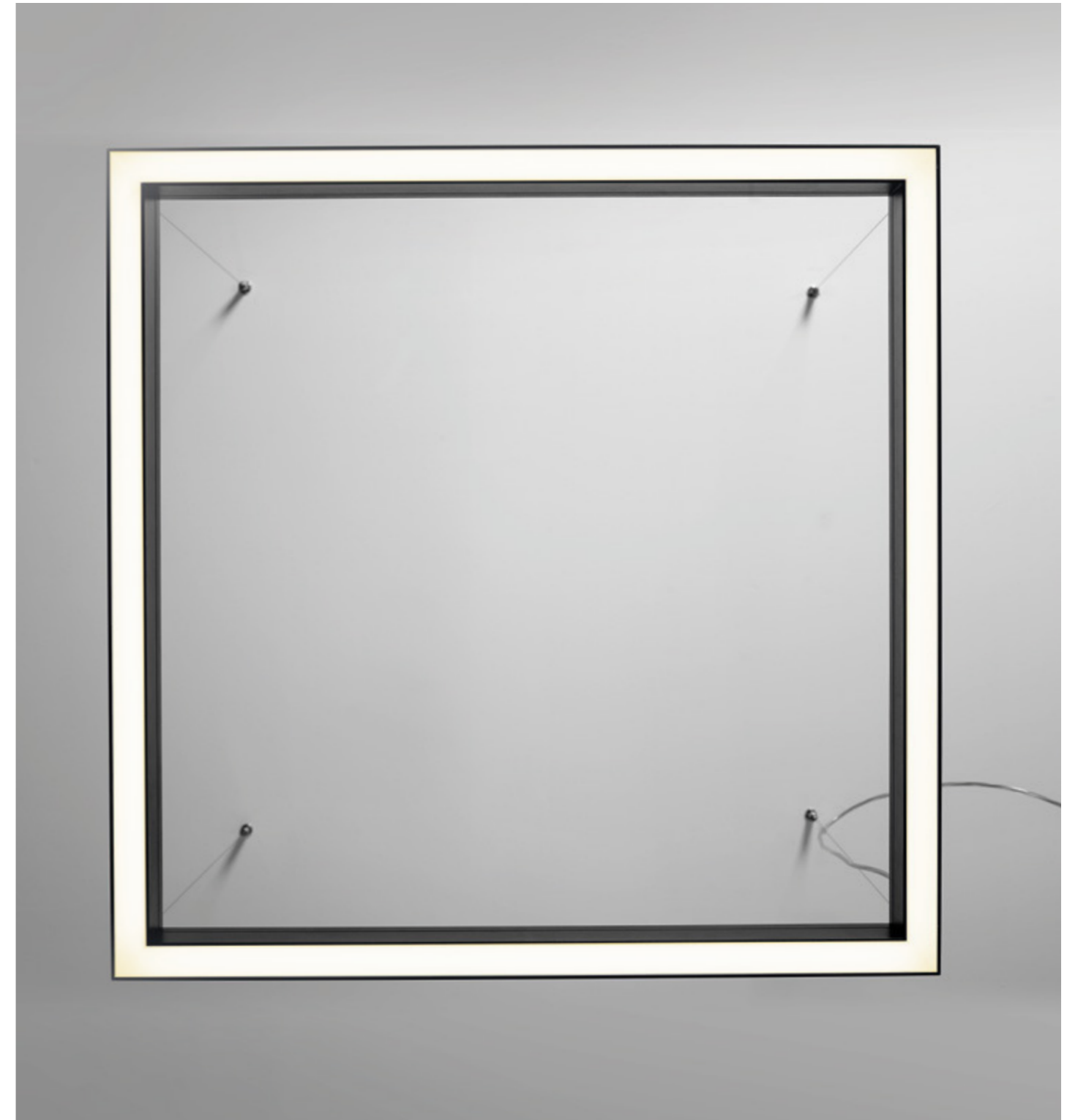
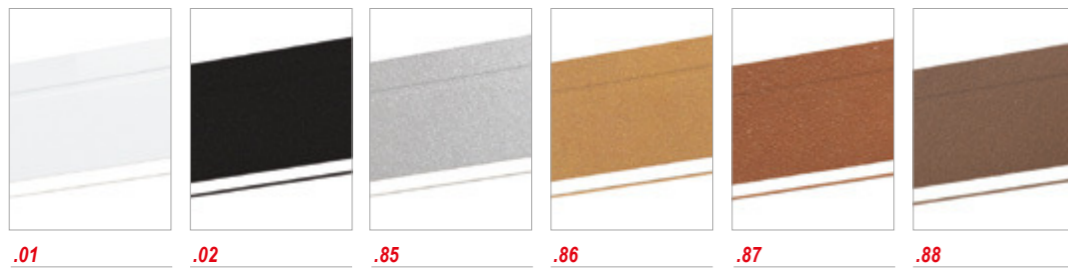

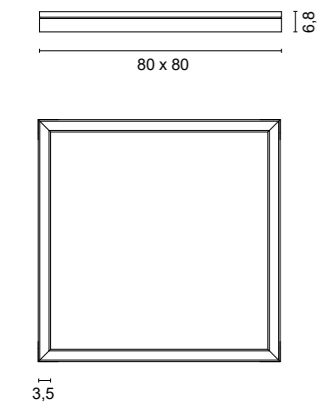

5562 Rail Quadra

- .01** Bianco - *White*
- .02** Nero - *Black*
- .85** Verniciato argento - *Painted silver*
- .85** Verniciato oro - *Painted gold*
- .87** Verniciato rame - *Painted copper*
- .88** Verniciato bronzo - *Painted bronze*

	Color temperature	LED Light source	lm source
/W	4000K	54W	6780lm
/WW	3000K	54W	6060lm
/XW	2700K	54W	5670lm

3,50 Kg

Dimmerabile PUSH - 1...10V - DALI su richiesta
 Dimmable PUSH - 1...10V - DALI on request

Codici finiture - *Finishes codes*

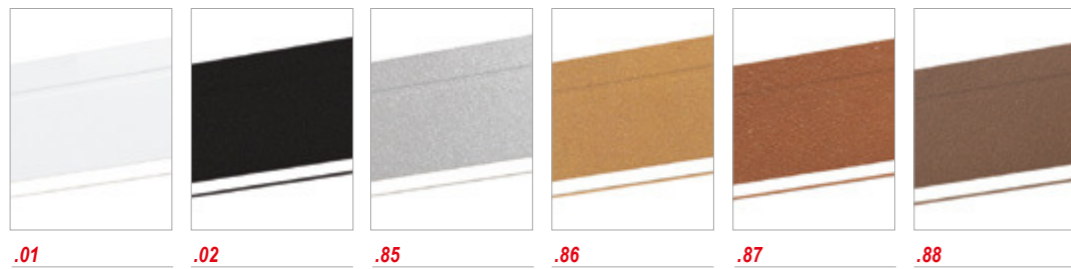



design **U.T. EgoIuce**
2023

364

Lampada da parete a doppia emissione luminosa, struttura in alluminio e alimentatore integrato. Il ridotto spessore e le diverse lunghezze disponibili rendono VELA estremamente utile per diverse soluzioni progettuali.

Wall lamp with double light emission, aluminium structure and integrated driver. The reduced thickness and the different available lengths make VELA extremely useful for different design solutions.

Applique avec double émission de lumière, structure en aluminium et driver intégré. L'épaisseur réduite et les différentes longueurs disponibles rendent VELA extrêmement utile pour différentes solutions d'aménagement.

Lámpara de pared con doble emisión de luz, estructura de aluminio y driver integrado. El reducido grosor y las diferentes longitudes disponibles hacen que VELA sea extremadamente útil para diferentes soluciones de diseño.

Wandleuchte mit doppeltem Lichtaustritt, Aluminiumstruktur und integriertem Driver. Die reduzierte Dicke und die verschiedenen verfügbaren Längen machen VELA äußerst nützlich für verschiedene Designlösungen.

VELA

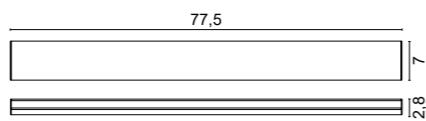
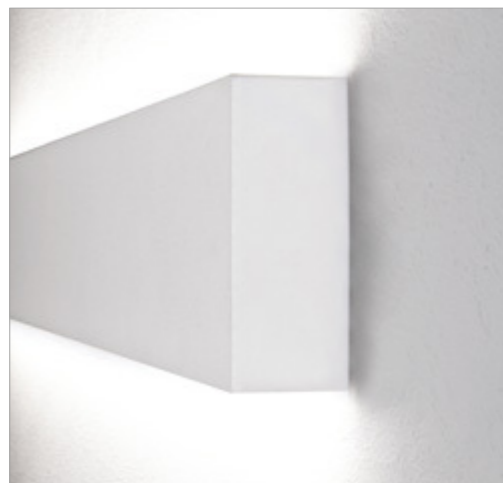

4589 Vela
.01 Bianco - White

Color temperature	LED Light source	lm source
/W 4000K	28,8W	3720 lm
/WW 3000K	28,8W	3465 lm
/XW 2700K	28,8W	3285 lm

IP40 1,00 Kg

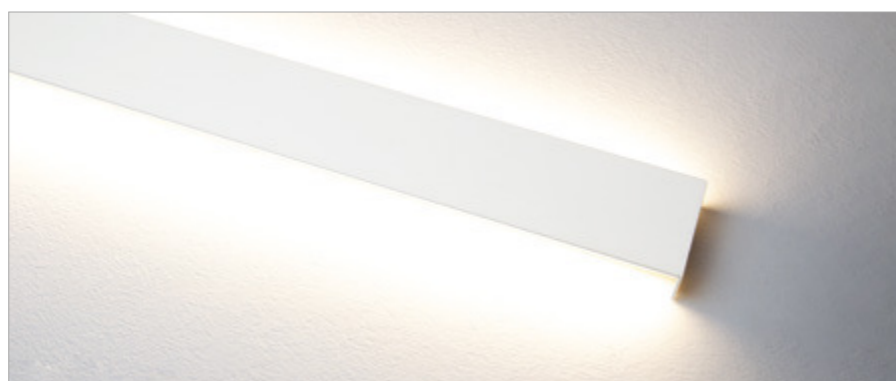

Codici finiture - Finishes codes



.01

CUSTOM SIZE Tabella lunghezze disponibili - Table of available lengths

cm	watt	2700K (XW)	lm source	3000K (WW)	lm source	4000K (W)	lm source
* 77,5	28,8W	4589.01/XW	3285	4589.01/WW	3465	4589.01/W	3720
102,5	38,4W	A4589.01/100/XW	4380	A4589.01/100/WW	4620	A4589.01/100/W	4960
127,5	48W	A4589.01/125/XW	5474	A4589.01/125/WW	5775	A4589.01/125/W	6200
152,5	57,6W	A4589.01/150/XW	6570	A4589.01/150/WW	6930	A4589.01/150/W	7440
177,5	67,2W	A4589.01/175/XW	7664	A4589.01/175/WW	8084	A4589.01/175/W	8690
202,5	76,8W	A4589.01/200/XW	8760	A4589.01/200/WW	9240	A4589.01/200/W	9920

* Articolo standard a catalogo - Standard catalogue item

Il codice prodotto si riferisce alla lunghezza totale della lampada completa di testate di chiusura
 The product code refers to the total length of the lamp complete with end caps





design **U.T. EgoIuce**
2016

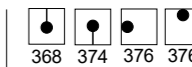

Collezione di lampade a luce diretta con struttura in alluminio, COB LED integrato e varie aperture ottiche. Disponibile in varie tipologie, formati e finiture. Gli accessori sono da ordinare separatamente. La versione a sospensione può essere installata su una serie di rosoni, da ordinare separatamente, oppure, con apposito accessorio, su binari elettrificati.

Collection of direct light lamps with aluminium structure, integrated COB LED and various optical beans. Available in various types, formats and finishes. Accessories are to be ordered separately. The suspension version can be installed on a series of ceiling roses, to be ordered separately, or, with a special accessory, on electrified tracks.

Collection de lampes à lumière directe avec structure en aluminium, LED COB intégrées et différentes ouvertures optiques. Disponible en différents types, formats et finitions. Les accessoires sont à commander séparément. La version suspendue peut être installée sur une série de rosaces, à commander séparément, ou, avec un accessoire spécial, sur des rails électrifiés.

Colección de lámparas de luz directa con estructura de aluminio, LED COB integrado y varias aperturas ópticas. Disponible en varios tipos, formatos y acabados. Los accesorios deben pedirse por separado. La versión suspendida puede instalarse sobre una serie de florones a techo, que se piden por separado, o, con un accesorio especial, sobre raíles electrificados.

Kollektion von Direktlichtlampen mit Aluminiumstruktur, integrierter COB-LED und verschiedenen optischen Öffnungen. Erhältlich in verschiedenen Typen, Formaten und Ausführungen. Das Zubehör ist separat zu bestellen. Die hängende Version kann auf einem separat zu bestellenden Rosettensatz oder, mit einem speziellen Zubehör, auf elektrifizierten Schiene installiert werden.

Newton

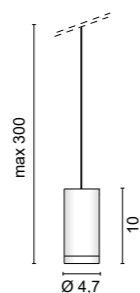
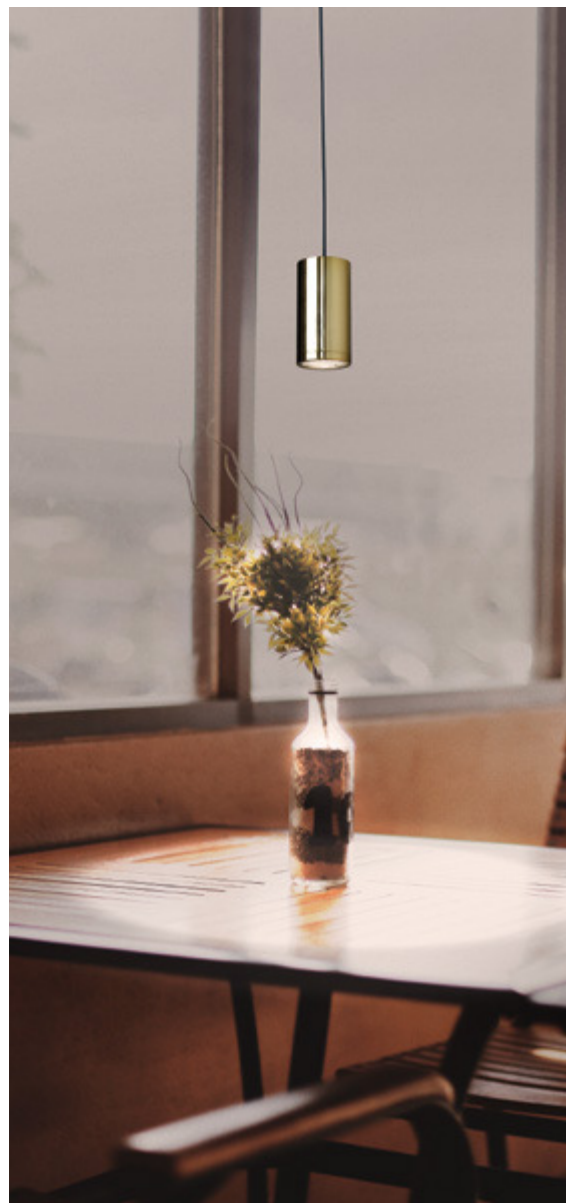

1591 Newton System

- .02** Nero - Black
- .25** Dorato satinato - Satin gold
- .32** Nickel satinato - Nickel mat

Color temperature	LED Light source	lm source
/W 4000K	5,9W 17V 350mA	885lm
/W 4000K /ST Satinato - Satin	5,9W 17V 350mA	885lm
/WW 3000K	5,9W 17V 350mA	836lm
/WW 3000K /ST Satinato - Satin	5,9W 17V 350mA	836lm
/XW 2700K	5,9W 17V 350mA	800lm
/XW 2700K /ST Satinato - Satin	5,9W 17V 350mA	800lm



0,50 Kg

2 elementi per decentramento inclusi
2 displacement component included

Su richiesta fascio di apertura: 24° o 58°
On request beam angles: 24° o 58°

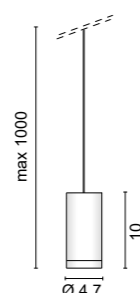

1592 Newton System

- .02** Nero - Black
- .25** Dorato satinato - Satin gold
- .32** Nickel satinato - Nickel mat

Color temperature	LED Light source	lm source
/W 4000K	5,9W 17V 350mA	885lm
/W 4000K /ST Satinato - Satin	5,9W 17V 350mA	885lm
/WW 3000K	5,9W 17V 350mA	836lm
/WW 3000K /ST Satinato - Satin	5,9W 17V 350mA	836lm
/XW 2700K	5,9W 17V 350mA	800lm
/XW 2700K /ST Satinato - Satin	5,9W 17V 350mA	800lm



0,70 Kg

4 elementi per decentramento inclusi
4 displacement component included

Su richiesta fascio di apertura: 24° o 58°
On request beam angles: 24° o 58°

Ottiche disponibili - Available optics

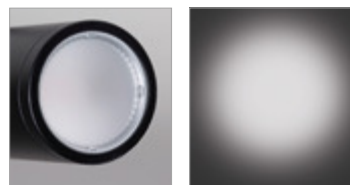

/ST
Ottica fascio diffuso per illuminazione generale
Diffused light optic for general lighting

Codici finiture - Finishes codes



.02 **.25** **.32**

Accessori decorativi - Decorative accessories



Newton 1591.02 + 0547.02

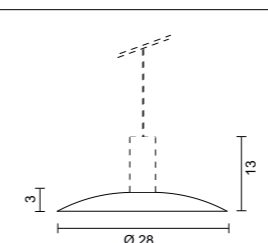

SCHERMO IN METALLO VERNICIATO NERO
SCREEN IN BLACK PAINTED METAL

Code	Codici finiture - Finishes codes
0547	.02 Nero - Black

0,24 Kg



Newton 1591.02 + 0549.02.00

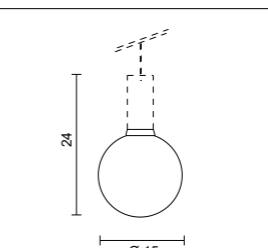

DIFFUSORE IN VETRO SOFFIATO TRASPARENTE
TRANSPARENT BLOWN GLASS DIFFUSER

Code	Codici finiture - Finishes codes
0549	.02.00 Nero - Black
0549	.25.00 Dorato satinato - Satin gold
0549	.32.00 Nickel satinato - Nickel mat

0,35 Kg



Newton 1591.02 + 0549.02.57

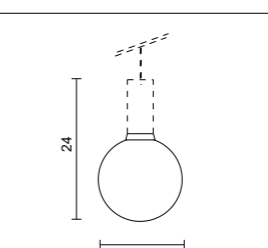

DIFFUSORE IN VETRO SOFFIATO BIANCO
WHITE BLOWN GLASS DIFFUSER

Code	Codici finiture - Finishes codes
0549	.02.57 Nero - Black
0549	.25.57 Dorato satinato - Satin gold
0549	.32.57 Nickel satinato - Nickel mat

0,35 Kg



Newton 1591.01 + 0274.01



0274

Ø 4,7 cm
H 3,8 cm

Schermo antiabbagliamento
Anti-glare screen

.01	Bianco - White
.02	Nero - Black



Newton 1591.01 + 0274.01



0267

Ø 4,7 cm
H 1 cm

Frangiluce
Louvres

.01	Bianco - White
.02	Nero - Black

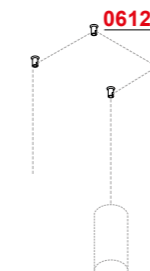

0612

Ø 1,4 cm
H 2,2 cm

1 Deviatore e decentratore
1 Displacement element

.01	Bianco - White
.02	Nero - Black



Newton System 1591.02 + 0549.02.00



Repond & Nyckees Architectes Sàrl
Ph. David Boraley

Newton 1592.02 + 0547.02

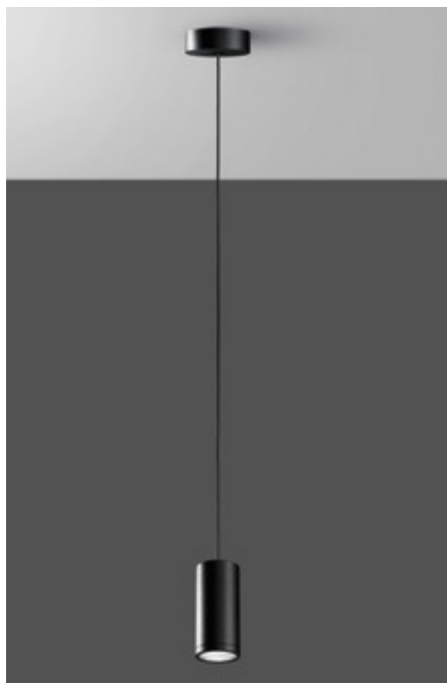

Newton 1591.02 + 0967.02



Newton 1591.02 + 0967.02



Newton 1591.02 + 0969.02



Newton 1592.02 + 0968.02





3510 Newton

- .01** Bianco - *White*
- .02** Nero - *Black*

Color temperature	Optics	LED light sources	lm source
/W 4000K	/24 /38 /58	34,8W	4892lm
/W 4000K	/ST Satinato - <i>Satin</i>	34,8W	4892lm
/WW 3000K	/24 /38 /58	34,8W	4624lm
/WW 3000K	/ST Satinato - <i>Satin</i>	34,8W	4624lm
/XW 2700K	/24 /38 /58	34,8W	4424lm
/XW 2700K	/ST Satinato - <i>Satin</i>	34,8W	4424lm



9,50 Kg

Accensione ON-OFF
ON-OFF switch

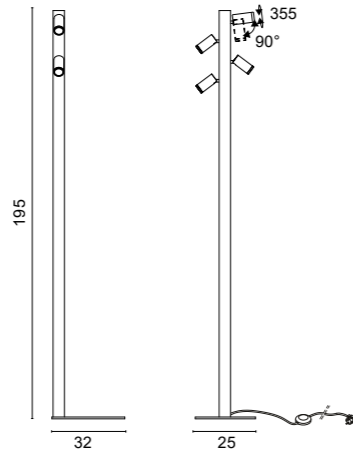

Ottiche disponibili - *Available optics*



- /24**
Ottica fascio stretto per luce d'accento
Narrow beam optic for accent lighting
- /38**
Ottica fascio medio
Medium beam optic
- /58**
Ottica fascio largo
Wide beam optic
- /ST**
Ottica fascio diffuso per illuminazione generale
Diffused light optic for general lighting

Codici finiture - *Finishes codes*

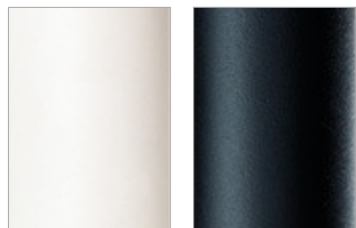

.01

.02



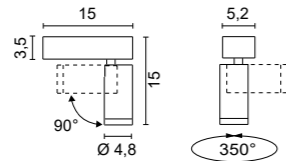

- 4562** Newton
- .01** Bianco - *White*
 - .02** Nero - *Black*
 - .31** Cromato lucido - *Chromed*

Color temperature	Optics	LED light sources	lm source
/W 4000K	/24 /38 /58	8,7W	1223lm
/W 4000K	/ST Satinato - <i>Satin</i>	8,7W	1223lm
/WW 3000K	/24 /38 /58	8,7W	1156lm
/WW 3000K	/ST Satinato - <i>Satin</i>	8,7W	1156lm
/XW 2700K	/24 /38 /58	8,7W	1106lm
/XW 2700K	/ST Satinato - <i>Satin</i>	8,7W	1106lm



0,60 Kg

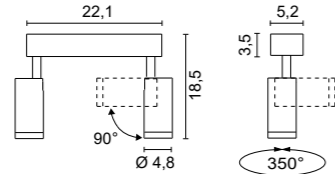

- 4612** Newton
- .01** Bianco - *White*
 - .02** Nero - *Black*
 - .31** Cromato lucido - *Chromed*

Color temperature	Optics	LED light sources	lm source
/W 4000K	/24 /38 /58	17,4W	2446lm
/W 4000K	/ST Satinato - <i>Satin</i>	17,4W	2446lm
/WW 3000K	/24 /38 /58	17,4W	2312lm
/WW 3000K	/ST Satinato - <i>Satin</i>	17,4W	2312lm
/XW 2700K	/24 /38 /58	17,4W	2212lm
/XW 2700K	/ST Satinato - <i>Satin</i>	17,4W	2212lm



1,25 Kg



Ottiche disponibili - Available optics



- /24**
Ottica fascio stretto per luce d'accento
Narrow beam optic for accent lighting
- /38**
Ottica fascio medio
Medium beam optic
- /58**
Ottica fascio largo
Wide beam optic
- /ST**
Ottica fascio diffuso per illuminazione generale
Diffused light optic for general lighting

Codici finiture - Finishes codes

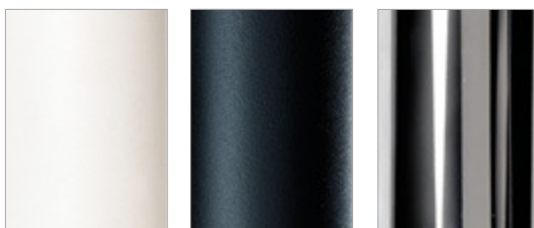

- .01**
- .02**
- .31**

Accessori - Accessories



Newton + 0274.01

- 0274**
- Ø 4,7 cm
H 3,8 cm
- Schermo antiabbagliamento
Anti-glare screen
- .01** Bianco - *White*
 - .02** Nero - *Black*



Newton + 0274.01

- 0267**
- Ø 4,7 cm
H 1 cm
- Frangiluce
Louvers
- .01** Bianco - *White*
 - .02** Nero - *Black*

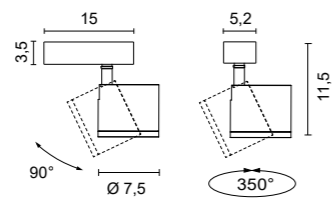

4611 Newton Flat

- .01** Bianco - *White*
- .02** Nero - *Black*
- .31** Cromato lucido - *Chromed*

Color temperature	Optics	LED light sources	lm source
/W 4000K	/13 /40	8,7W	1223lm
/W 4000K	/ST Satinato - <i>Satin</i>	8,7W	1223lm
/WW 3000K	/13 /40	8,7W	1156lm
/WW 3000K	/ST Satinato - <i>Satin</i>	8,7W	1156lm
/XW 2700K	/13 /40	8,7W	1106lm
/XW 2700K	/ST Satinato - <i>Satin</i>	8,7W	1106lm



0,60 Kg

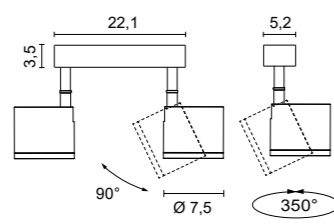

4614 Newton Flat

- .01** Bianco - *White*
- .02** Nero - *Black*
- .31** Cromato lucido - *Chromed*

Color temperature	Optics	LED light sources	lm source
/W 4000K	/13 /40	17,4W	2446lm
/W 4000K	/ST Satinato - <i>Satin</i>	17,4W	2446lm
/WW 3000K	/13 /40	17,4W	2312lm
/WW 3000K	/ST Satinato - <i>Satin</i>	17,4W	2312lm
/XW 2700K	/13 /40	17,4W	2212lm
/XW 2700K	/ST Satinato - <i>Satin</i>	17,4W	2212lm



1,25 Kg



Ottiche disponibili - *Available optics*

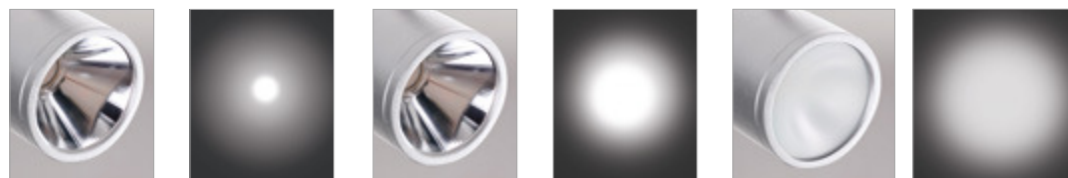

- /13** Ottica fascio stretto per luce d'accento
Narrow beam optic for accent lighting
- /40** Ottica fascio largo
Wide beam optic
- /ST** Ottica fascio diffuso per illuminazione generale
Diffused light optic for general lighting

Codici finiture - *Finishes codes*

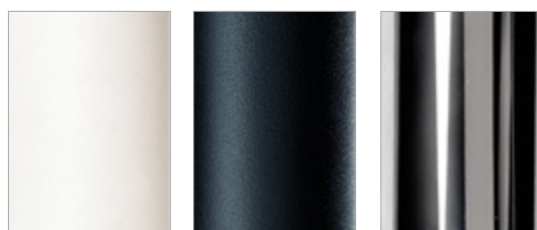

.01 **.02** **.31**



Accessori - *Accessories*



0264

Ø 10 cm
H 3,6 cm

Parabola decorativa
Decorative parabolic reflector

- .01** Bianco - *White*
- .02** Nero - *Black*

Newton Flat + 0264.02

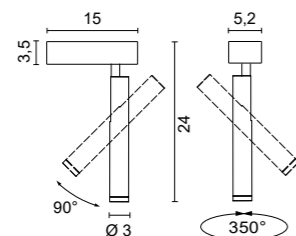

- 4610** Newton Slim
- .01** Bianco - *White*
 - .02** Nero - *Black*
 - .31** Cromato lucido - *Chromed*

Color temperature	Optics	LED light sources	lm source
/W 4000K	/35 /48 /63	8,7W	1223lm
/W 4000K	/ST Satinato - <i>Satin</i>	8,7W	1223lm
/WW 3000K	/35 /48 /63	8,7W	1156lm
/WW 3000K	/ST Satinato - <i>Satin</i>	8,7W	1156lm
/XW 2700K	/35 /48 /63	8,7W	1106lm
/XW 2700K	/ST Satinato - <i>Satin</i>	8,7W	1106lm



0,60 Kg

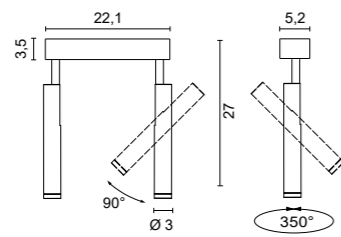

- 4613** Newton Slim
- .01** Bianco - *White*
 - .02** Nero - *Black*
 - .31** Cromato lucido - *Chromed*

Color temperature	Optics	LED light sources	lm source
/W 4000K	/35 /48 /63	17,4W	2446lm
/W 4000K	/ST Satinato - <i>Satin</i>	17,4W	2446lm
/WW 3000K	/35 /48 /63	17,4W	2312lm
/WW 3000K	/ST Satinato - <i>Satin</i>	17,4W	2312lm
/XW 2700K	/35 /48 /63	17,4W	2212lm
/XW 2700K	/ST Satinato - <i>Satin</i>	17,4W	2212lm



1,25 Kg



Ottiche disponibili - Available optics

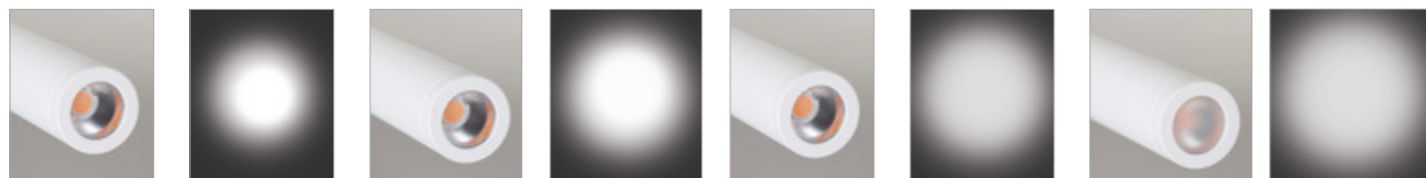

- /35** Ottica fascio stretto per luce d'accento
Narrow beam optic for accent lighting
- /48** Ottica fascio medio
Medium beam optic
- /63** Ottica fascio largo
Wide beam optic
- /ST** Ottica fascio diffuso per illuminazione generale
Diffused light optic for general lighting

Codici finiture - Finishes codes

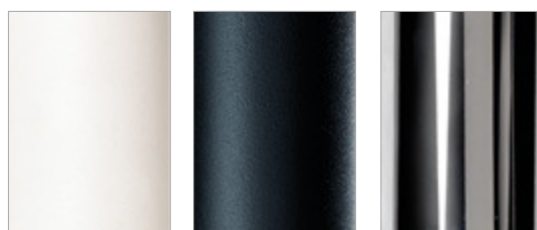

- .01**
- .02**
- .31**

Accessori - Accessories



- 0267/S**
Frangiluce
Louvres

- .01** Bianco - *White*
- .02** Nero - *Black*



Newton + 0265.01



- 0265**
Ø 3,6 cm
H 20 cm
Diffusore in vetro Pyrex sabbato
Sand blasted Pyrex glass diffuser
- .01** Ghiera bianca - *White ferrule*
 - .02** Ghiera nera - *Black ferrule*

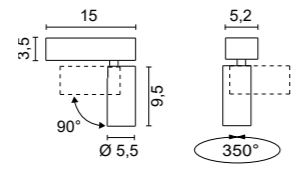

4618 Newton Easy

- .01 Bianco - White
- .02 Nero - Black

Light source not included

GU10 LED

7W 4000K 630lm (art. 0094/W)

7W 3000K 600lm (art. 0094/WW)

7W 2700K 580lm (art. 0094/XW)

7W 4000K 550lm (art. 0104/W)



7W 3000K 530lm (art. 0104/WW)



7W 2700K 510lm (art. 0104/XW)



0,50 Kg

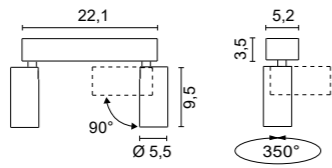
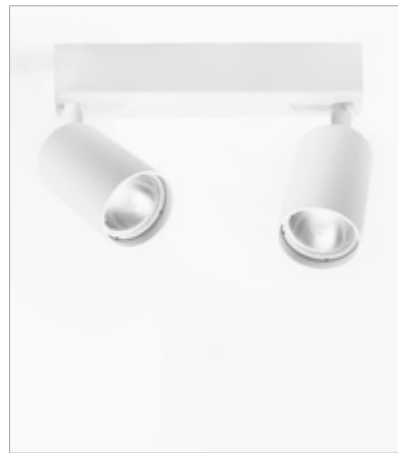

4619 Newton Easy

- .01 Bianco - White
- .02 Nero - Black

Light source not included

GU10 LED

7W 4000K 630lm (art. 0094/W)

7W 3000K 600lm (art. 0094/WW)

7W 2700K 580lm (art. 0094/XW)

7W 4000K 550lm (art. 0104/W)



7W 3000K 530lm (art. 0104/WW)



7W 2700K 510lm (art. 0104/XW)



0,80 Kg

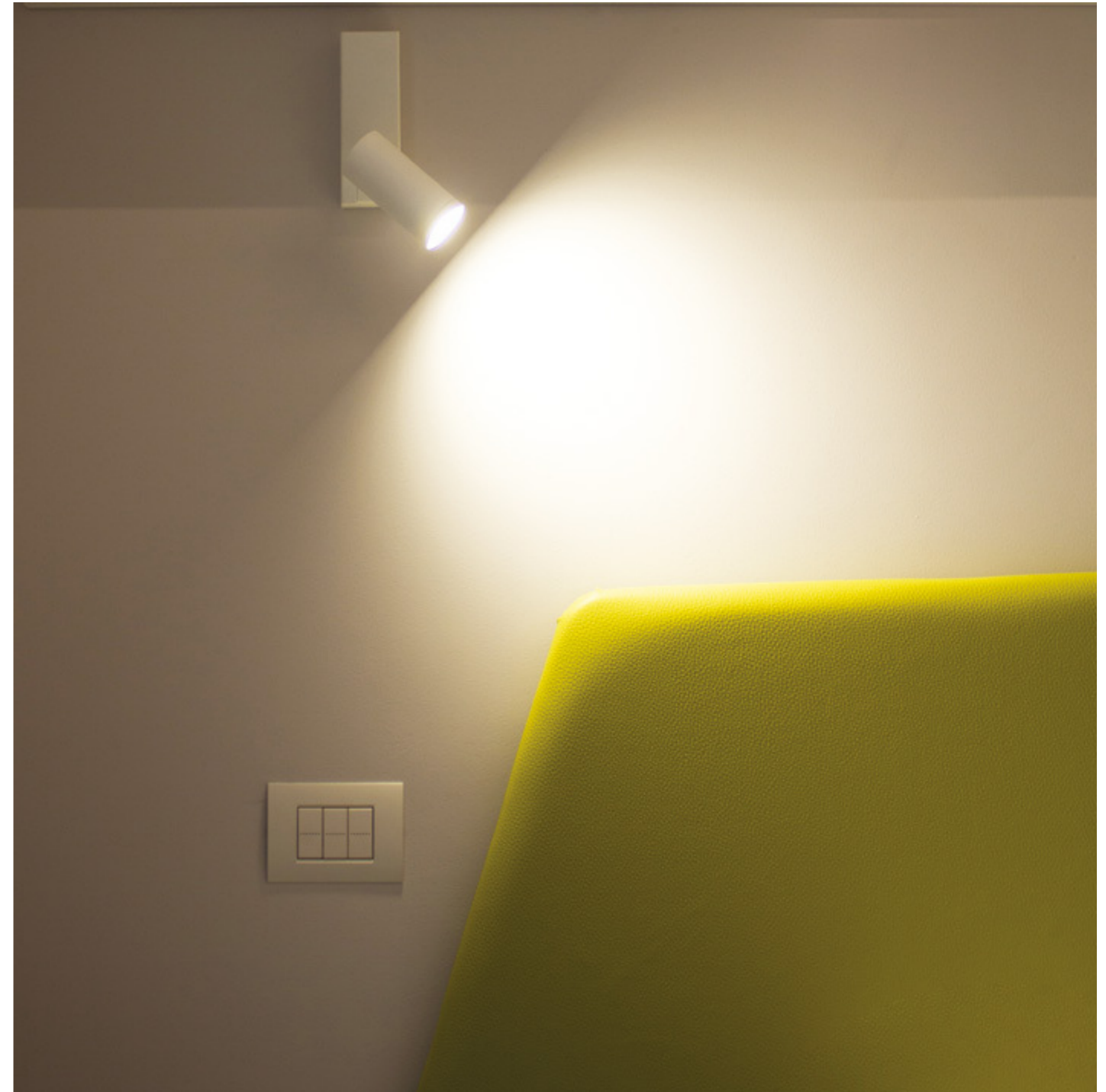

Codici finiture - Finishes codes

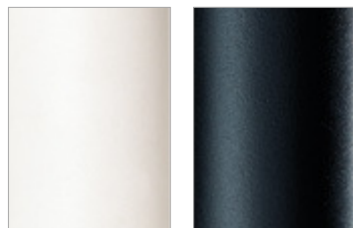

.01

.02



design **Mati**
2017

Lampada a sospensione a luce diretta con corpo in alluminio e legno di faggio, COB LED integrato e cavo coassiale di 3 o 10 metri. Pevera può essere installata su una serie di rosoni, da ordinare separatamente, oppure, con apposito accessorio, su binari elettrificati.

Direct light pendant lamp with aluminium and beech wood body, integrated COB LED and 3 or 10 metre coaxial cable. Pevera can be installed on a series of ceiling roses, to be ordered separately, or, with a special accessory, on electrified tracks.

Suspension à éclairage direct avec corps en aluminium et hêtre, LED COB intégrées et câble coaxial de 3 ou 10 mètres. Pevera peut être installée sur un jeu de rosaces, à commander séparément, ou, avec un accessoire spécial, sur des rails électrifiés.

Lámpara colgante de luz directa con cuerpo de aluminio y madera de haya, LED COB integrado y cable coaxial de 3 ó 10 metros. Pevera puede instalarse sobre una serie de florones a techo, que se piden por separado, o, con un accesorio especial, sobre raíles electrificados.

Pendelleuchte mit direktem Licht, Gehäuse aus Aluminium und Buchenholz, integrierte COB-LED und 3 oder 10 Meter Koaxialkabel. Pevera kann auf einem separat zu bestellenden Rosettensatz oder, mit einem speziellen Zubehör, auf Stromschienen installiert werde.

386

Pevero System

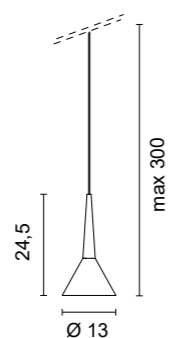
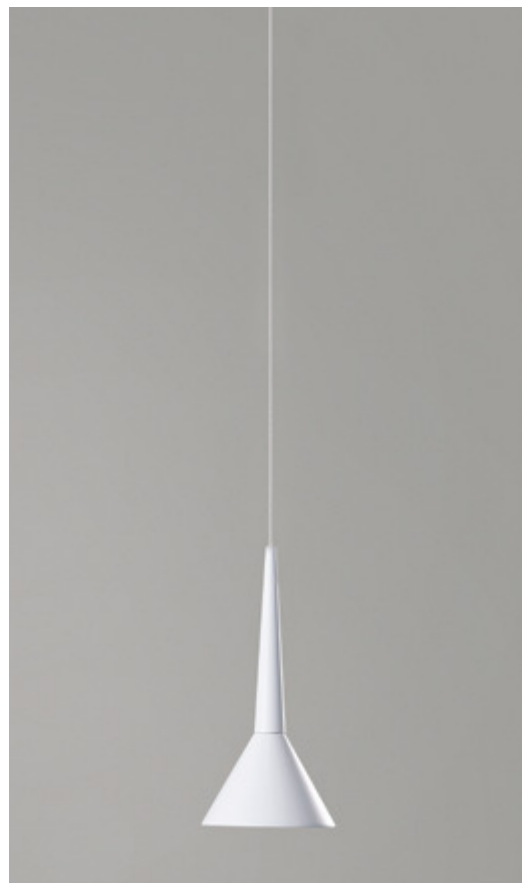

1568 Pevera System

- .01** Bianco - White
- .02** Nero - Black
- .05** Rosso - Red

Color temperature	LED Light source	lm source
/W 4000K	6W 17,2V 350mA	966lm
/WW 3000K	6W 17,2V 350mA	910lm
/XW 2700K	6W 17,2V 350mA	873lm



0,50 Kg

2 elementi per decentramento inclusi
2 displacement component included

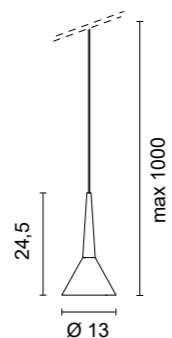

1569 Pevera System

- .01** Bianco - White
- .02** Nero - Black
- .05** Rosso - Red

Color temperature	LED Light source	lm source
/W 4000K	6W 17,2V 350mA	966lm
/WW 3000K	6W 17,2V 350mA	910lm
/XW 2700K	6W 17,2V 350mA	873lm



0,70 Kg

4 elementi per decentramento inclusi
4 displacement component included



Codici finiture - Finishes codes

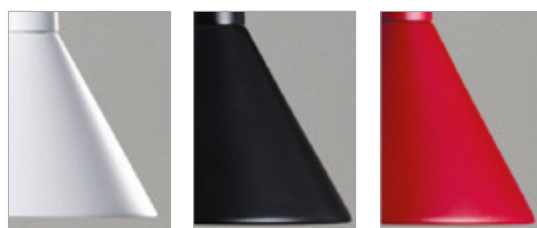

.01

.02

.05



Rosoni con alimentatori e accessori da ordinare separatamente (p. 394) - Ceiling roses with drivers and accessories to be ordered separately (p. 394)

Accessori - Accessories

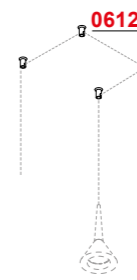
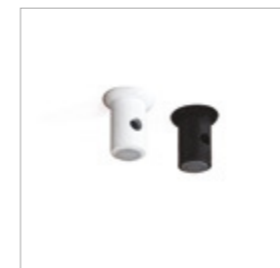

0612

Ø 1,4 cm
H 2,2 cm

1 Deviatore e decentratore
1 Displacement element

- .01** Bianco - White
- .02** Nero - Black

Rosoni con alimentatori e accessori da ordinare separatamente (p. 394) - Ceiling roses with drivers and accessories to be ordered separately (p. 394)



Pevera System 1568.05 + 0535.05



Pevera System 1568.02 + 0968.02



Pevera System 1569.02 + 0969/S.02



3 Pevera System 1568.01 + 0557/3.01



3 Pevera System 1568.01 + 0556/3.01



2 Pevera System 1568.02 + 0557/2.02



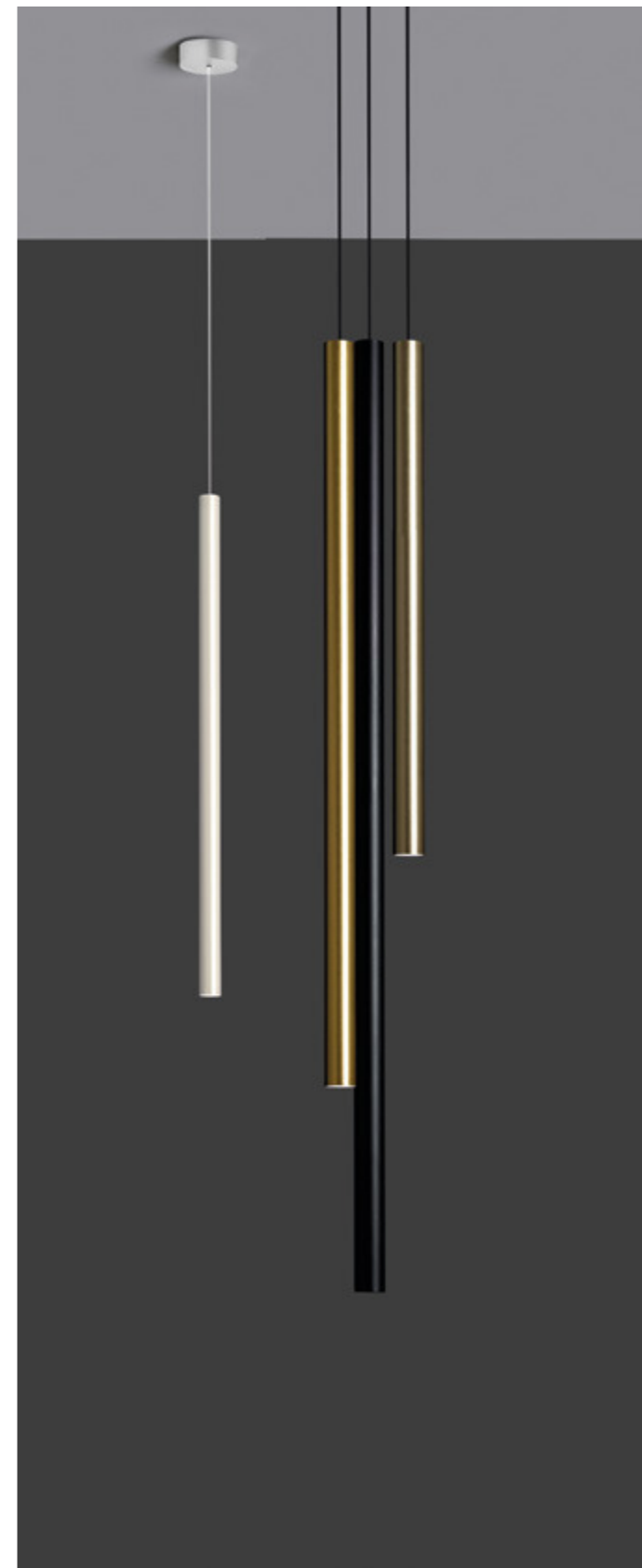

design **ABS Studio**
2019

Lampada a sospensione a luce diretta con corpo in ottone, dissipatore in alluminio, COB LED integrato e varie aperture ottiche. Disponibile in tre lunghezze e varie finiture. Stick può essere installata su una serie di rosoni, da ordinare separatamente, oppure, con apposito accessorio, su binari elettrificati.

Direct light pendant lamp with brass body, aluminium heat sink, integrated COB LED and various optical beams. Available in three lengths and various finishes. Stick can be installed on a series of ceiling roses, to be ordered separately, or, with a special accessory, on electrified tracks.

Suspension à éclairage direct avec corps en laiton, dissipateur thermique en aluminium, LED COB intégrée et différentes ouvertures optiques. Disponible en trois longueurs et en différentes finitions. Stick peut être installé sur un jeu de rosaces, à commander séparément, ou, avec un accessoire spécial, sur des rails électrifiés.

Lámpara colgante de luz directa con cuerpo de latón, disipador de calor de aluminio, LED COB integrado y varias aperturas ópticas. Disponible en tres longitudes y varios acabados. Stick puede instalarse sobre una serie de florones a techo, que se piden por separado, o, con un accesorio especial, sobre railes electrificados.

Direktstrahlende Pendelleuchte mit Messingkörper, Aluminiumkühlkörper, integrierter COB-LED und verschiedenen Lichtaustrittsöffnungen. Erhältlich in drei Längen und verschiedenen Ausführungen. Stick kann auf einer Reihe von Rosetten installiert werden, die separat zu bestellen sind, oder, mit einem speziellen Zubehör, auf elektrifizierten Schienen.

Stick System

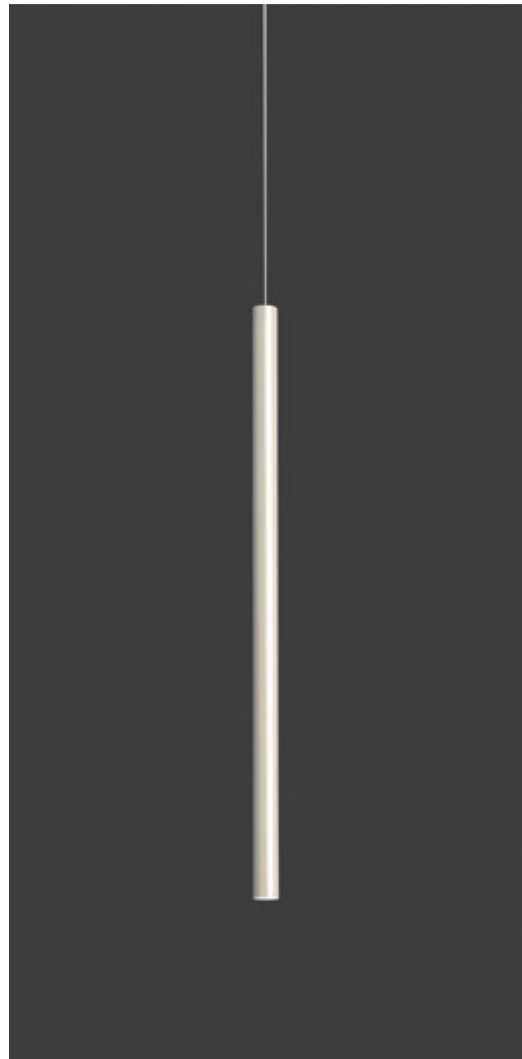

1580 Stick System

- .01** Bianco - *White*
- .02** Nero - *Black*
- .21** Dorato lucido - *Shiny gold*
- .25** Dorato satinato - *Satin gold*

Color temperature	Optics	LED light sources	lm source
/W 4000K	/48	5,9W 17V 350mA	885lm
/W 4000K	/ST Satinato - <i>Satin</i>	5,9W 17V 350mA	885lm
/WW 3000K	/48	5,9W 17V 350mA	836lm
/WW 3000K	/ST Satinato - <i>Satin</i>	5,9W 17V 350mA	836lm
/XW 2700K	/48	5,9W 17V 350mA	800lm
/XW 2700K	/ST Satinato - <i>Satin</i>	5,9W 17V 350mA	800lm



0,90 Kg

2 elementi per decentramento inclusi
2 displacement component included

1581 Stick system

- .01** Bianco - *White*
- .02** Nero - *Black*
- .21** Dorato lucido - *Shiny gold*
- .25** Dorato satinato - *Satin gold*

Color temperature	Optics	LED light sources	lm source
/W 4000K	/48	5,9W 17V 350mA	885lm
/W 4000K	/ST Satinato - <i>Satin</i>	5,9W 17V 350mA	885lm
/WW 3000K	/48	5,9W 17V 350mA	836lm
/WW 3000K	/ST Satinato - <i>Satin</i>	5,9W 17V 350mA	836lm
/XW 2700K	/48	5,9W 17V 350mA	800lm
/XW 2700K	/ST Satinato - <i>Satin</i>	5,9W 17V 350mA	800lm



1,00 Kg

2 elementi per decentramento inclusi
2 displacement component included

1582 Stick system

- .01** Bianco - *White*
- .02** Nero - *Black*
- .21** Dorato lucido - *Shiny gold*
- .25** Dorato satinato - *Satin gold*

Color temperature	Optics	LED light sources	lm source
/W 4000K	/48	5,9W 17V 350mA	885lm
/W 4000K	/ST Satinato - <i>Satin</i>	5,9W 17V 350mA	885lm
/WW 3000K	/48	5,9W 17V 350mA	836lm
/WW 3000K	/ST Satinato - <i>Satin</i>	5,9W 17V 350mA	836lm
/XW 2700K	/48	5,9W 17V 350mA	800lm
/XW 2700K	/ST Satinato - <i>Satin</i>	5,9W 17V 350mA	800lm



1,10 Kg

2 elementi per decentramento inclusi
2 displacement component included

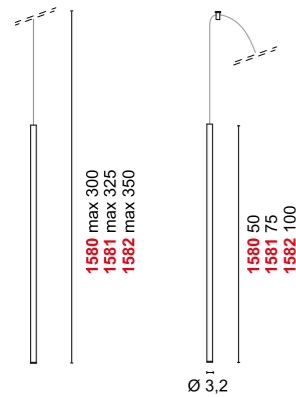

Codici finiture - *Finishes codes*

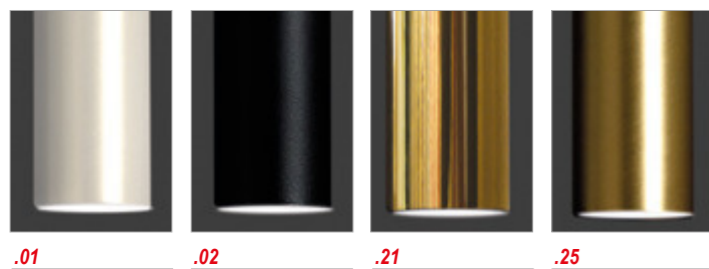

Esempio d'installazione con 9 Stick System con rosone speciale
Example of installation with 9 Stick System with special ceiling rose



4 Stick System + 0979/4.01

Accessori - *Accessories*

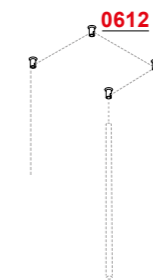
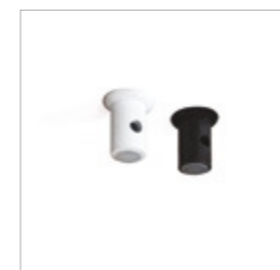

0612

Ø 1,4 cm
H 2,2 cm

1 Deviatore e decentratore
1 Displacement element

- .01** Bianco - *White*
- .02** Nero - *Black*

Rosoni - Ceiling rose

0535



IN: 50/60Hz 220-240V OUT: 350mA DC



ROSONE COMPLETO DI DRIVER - 1 LAMPADA
CEILING ROSE WITH DRIVER - 1 LAMP

Code Codici finiture - Finishes codes

0535 .01 Bianco - White
0535 .02 Nero - Black
0535 .05 Rosso - Red



IN: 50/60Hz 220-240V OUT: 350mA DC

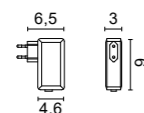
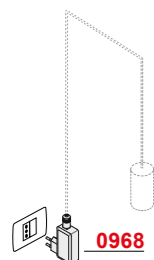

SPINA A PARETE CON DRIVER INTEGRATO + JACK - 1 LAMPADA
PLUG IN DRIVER + JACK - 1 LAMP

Code Codici finiture - Finishes codes

0968 .02 Nero - Black



0967



IN: 50/60Hz 220-240V OUT: 350mA DC

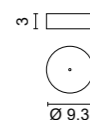

ROSONE COMPLETO DI DRIVER - 1 LAMPADA
CEILING ROSE WITH DRIVER - 1 LAMP

Code Codici finiture - Finishes codes

0967 .01 Bianco - White
0967 .02 Nero - Black



IN: 50/60Hz 220-240V OUT: 350mA DC

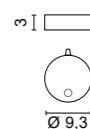
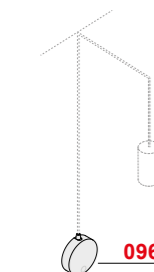

ROSONE COMPLETO DI DRIVER - 1 LAMPADA
CEILING ROSE WITH DRIVER - 1 LAMP

Code Codici finiture - Finishes codes

0969 .01 Bianco - White
0969 .02 Nero - Black



IN: 50/60Hz 220-240V OUT: 350mA DC

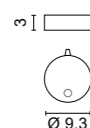
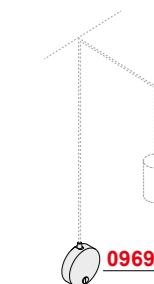

ROSONE CON INTERRUTTORE COMPLETO DI DRIVER - 1 LAMPADA
CEILING ROSE WITH SWITCH AND DRIVER - 1 LAMP

Code Codici finiture - Finishes codes

0969/S .01 Bianco - White
0969/S .02 Nero - Black



Adattatore /sospensione per binari - Track adapter/suspension

0987

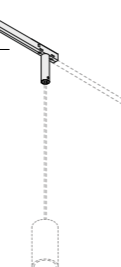

IN: 48V OUT: 350mA DC

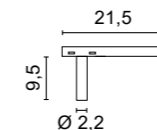

ADATTATORE PER BINARIO 48V - 1 LAMPADA
ADAPTER FOR 48V TRACK - 1 LAMP

Code Codici finiture - Finishes codes

0987 .01 Bianco - White
0987 .02 Nero - Black



0988

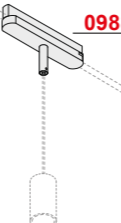

IN: 50/60Hz 220-240V OUT: 350mA DC

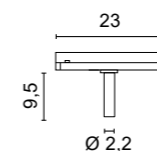

ADATTATORE PER BINARIO 220-240V - 1 LAMPADA
ADAPTER FOR 220-240V TRACK - 1 LAMP

Code Codici finiture - Finishes codes

0988 .01 Bianco - White
0988 .02 Nero - Black



Rosoni per incassi - Recessed ceiling rose

0970



IN: 50/60Hz 220-240V OUT: 350mA DC

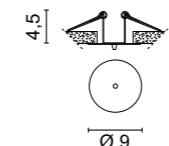

PIASTRA PER CARTONGESSO CON DRIVER 1 LAMPADA
PLASTERBOARD CEILING ROSE WITH DRIVER 1 LAMP

Code Codici finiture - Finishes codes

0970 .01 Bianco - White
0970 .02 Nero - Black



7,5 cm

0,20 Kg

Il driver fornito passa dal foro incasso della piastra per cartongesso art. 0954
The supplied driver passes through the recessed hole of the Plasterboard ceiling rose art. 0954

DIMMERAZIONE
DIMMING

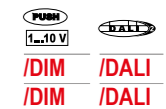

E1001



ROSONE A SCOMPRESA EUREKA SENZA DRIVER PER CARTONGESSO
EUREKA CEILING ROSE WITHOUT DRIVER FOR PLASTERBOARD

Code Codici finiture - Finishes codes

E1001 .01 Bianco - White
E1001 .02 Nero - Black



4,1 cm

Accessori - Accessories



0612

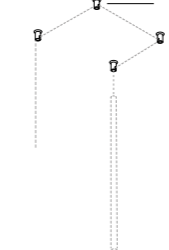

0612

Ø 1,4 cm
H 2,2 cm

1 Deviatore e decentratore
1 Displacement element

.01 Bianco - White
.02 Nero - Black

Rosoni - Ceiling rose

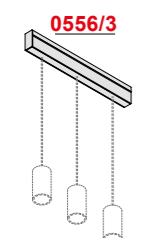
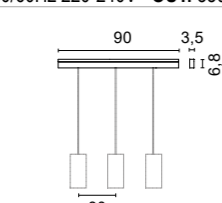
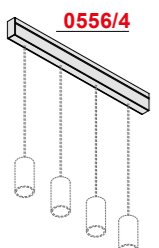
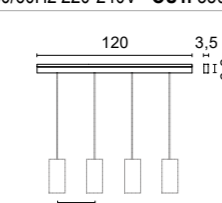
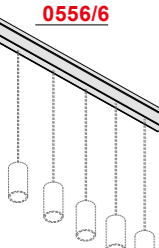
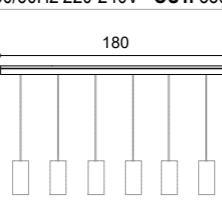
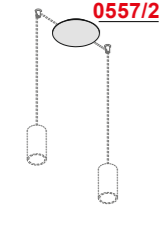
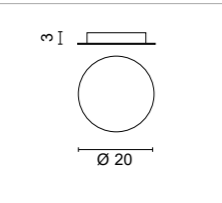
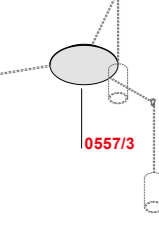
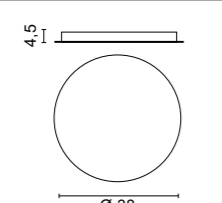
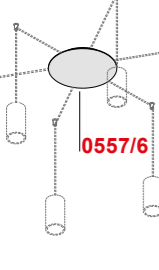
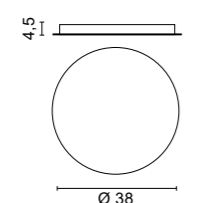
	<p>IN: 50/60Hz 220-240V OUT: 350mA DC</p> 	<p>ROSONE COMPLETO DI DRIVER - 3 LAMPADE CEILING ROSE WITH DRIVER - 3 LAMPS</p> <p>Code Codici finiture - Finishes codes</p> <p>0556/3 .01 Bianco - White</p> <p>0556/3 .02 Nero - Black</p> <p>0556/3 .05 Rosso - Red</p> <p>PUSH HALI</p> <p>/DIM /DALI</p> <p>/DIM /DALI</p> <p>/DIM /DALI</p> <p>F RECYCLE</p> <p>1,20 Kg</p>
	<p>IN: 50/60Hz 220-240V OUT: 350mA DC</p> 	<p>ROSONE COMPLETO DI DRIVER - 4 LAMPADE CEILING ROSE WITH DRIVER - 4 LAMPS</p> <p>Code Codici finiture - Finishes codes</p> <p>0556/4 .01 Bianco - White</p> <p>0556/4 .02 Nero - Black</p> <p>0556/4 .05 Rosso - Red</p> <p>PUSH HALI</p> <p>/DIM /DALI</p> <p>/DIM /DALI</p> <p>/DIM /DALI</p> <p>F RECYCLE</p> <p>1,40 Kg</p>
	<p>IN: 50/60Hz 220-240V OUT: 350mA DC</p> 	<p>ROSONE COMPLETO DI DRIVER - 6 LAMPADE CEILING ROSE WITH DRIVER - 6 LAMPS</p> <p>Code Codici finiture - Finishes codes</p> <p>0556/6 .01 Bianco - White</p> <p>0556/6 .02 Nero - Black</p> <p>0556/6 .05 Rosso - Red</p> <p>PUSH HALI</p> <p>/DIM /DALI</p> <p>/DIM /DALI</p> <p>/DIM /DALI</p> <p>F RECYCLE</p> <p>1,60 Kg</p>
	<p>IN: 50/60Hz 220-240V OUT: 350mA DC</p> 	<p>ROSONE COMPLETO DI DRIVER - 2 LAMPADE CEILING ROSE WITH DRIVER - 2 LAMPS</p> <p>Code Codici finiture - Finishes codes</p> <p>0557/2 .01 Bianco - White</p> <p>0557/2 .02 Nero - Black</p> <p>PUSH HALI</p> <p>/DIM /DALI</p> <p>/DIM /DALI</p> <p>F RECYCLE</p> <p>0,50 Kg</p>
	<p>IN: 50/60Hz 220-240V OUT: 350mA DC</p> 	<p>ROSONE COMPLETO DI DRIVER - 3 LAMPADE CEILING ROSE WITH DRIVER - 3 LAMPS</p> <p>Code Codici finiture - Finishes codes</p> <p>0557/3 .01 Bianco - White</p> <p>0557/3 .02 Nero - Black</p> <p>PUSH HALI</p> <p>/DIM /DALI</p> <p>/DIM /DALI</p> <p>F RECYCLE</p> <p>1,70 Kg</p>
	<p>IN: 50/60Hz 220-240V OUT: 350mA DC</p> 	<p>ROSONE COMPLETO DI DRIVER - 4-6 LAMPADE CEILING ROSE WITH DRIVER - 4-6 LAMPS</p> <p>Code Codici finiture - Finishes codes</p> <p>0557/6 .01 Bianco - White</p> <p>0557/6 .02 Nero - Black</p> <p>PUSH HALI</p> <p>/DIM /DALI</p> <p>/DIM /DALI</p> <p>F RECYCLE</p> <p>1,70 Kg</p>

Rosoni - Ceiling rose

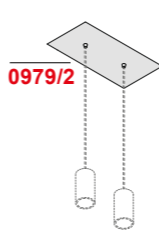
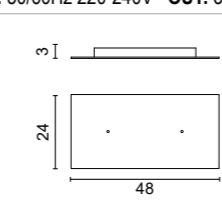
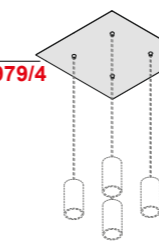
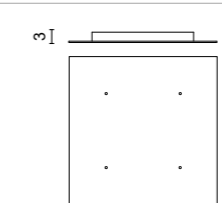
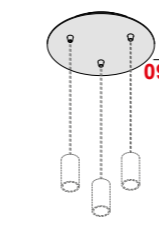
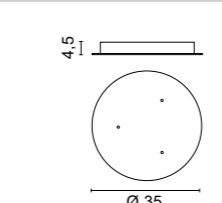
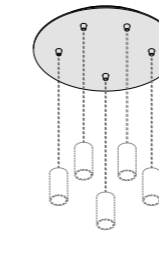
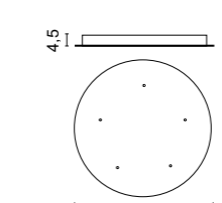
	<p>IN: 50/60Hz 220-240V OUT: 350mA DC</p> 	<p>ROSONE COMPLETO DI DRIVER - 2 LAMPADE CEILING ROSE WITH DRIVER - 2 LAMPS</p> <p>Code Codici finiture - Finishes codes</p> <p>0979/2 .01 Bianco - White</p> <p>0979/2 .02 Nero - Black</p> <p>PUSH HALI</p> <p>/DIM /DALI</p> <p>/DIM /DALI</p> <p>F</p> <p>2,00 Kg</p>
	<p>IN: 50/60Hz 220-240V OUT: 350mA DC</p> 	<p>ROSONE COMPLETO DI DRIVER - 4 LAMPADE CEILING ROSE WITH DRIVER - 4 LAMPS</p> <p>Code Codici finiture - Finishes codes</p> <p>0979/4 .01 Bianco - White</p> <p>0979/4 .02 Nero - Black</p> <p>PUSH HALI</p> <p>/DIM /DALI</p> <p>/DIM /DALI</p> <p>F</p> <p>3,80 Kg</p>
	<p>IN: 50/60Hz 220-240V OUT: 350mA DC</p> 	<p>ROSONE COMPLETO DI DRIVER - 3 LAMPADE CEILING ROSE WITH DRIVER - 3 LAMPS</p> <p>Code Codici finiture - Finishes codes</p> <p>0980/3 .01 Bianco - White</p> <p>0980/3 .02 Nero - Black</p> <p>PUSH HALI</p> <p>/DIM /DALI</p> <p>/DIM /DALI</p> <p>F</p> <p>1,20 Kg</p>
	<p>IN: 50/60Hz 220-240V OUT: 350mA DC</p> 	<p>ROSONE COMPLETO DI DRIVER - 5 LAMPADE CEILING ROSE WITH DRIVER - 5 LAMPS</p> <p>Code Codici finiture - Finishes codes</p> <p>0980/5 .01 Bianco - White</p> <p>0980/5 .02 Nero - Black</p> <p>PUSH HALI</p> <p>/DIM /DALI</p> <p>/DIM /DALI</p> <p>F</p>



design **ABS Studio**
2011

400

Lampada a sospensione a luce diretta con corpo in metallo, terminale in alluminio, lente interna in metacrilato con apertura ottica di 40°, cavo di alimentazione trasparente di 200 cm, rosone conico in ABS con alimentatore integrato e un elemento per decentramento incluso.

Direct-light suspension lamp with metal body, aluminium finial, methacrylate inner lens with 40° optical beam, 200 cm transparent power cable, conical ABS ceiling rose with integrated driver and an element for decentralisation included.

Lampe suspendue à éclairage direct avec corps en métal, embout en aluminium, lentille intérieure en méthacrylate avec ouverture optique de 40°, câble d'alimentation transparent de 200 cm, rosace de plafond conique en ABS avec driver intégré et élément de décentralisation inclus.

Lámpara colgante de luz directa con cuerpo metálico, terminal de aluminio, lente interior de metacrilato con apertura óptica de 40°, cable de alimentación transparente de 200 cm, florón a techo cónico de ABS con driver integrado y un elemento para la descentralización incluido.

Pendelleuchte mit direktem Licht, Metallgehäuse, Aluminiumabschluss, innere Linse aus Methacrylat mit optischer Öffnung von 40°, transparentes Stromkabel von 200 cm Länge, konischer Rosette aus ABS mit integriertem Driver und einem Element für die Dezentralisierung im Lieferumfang.

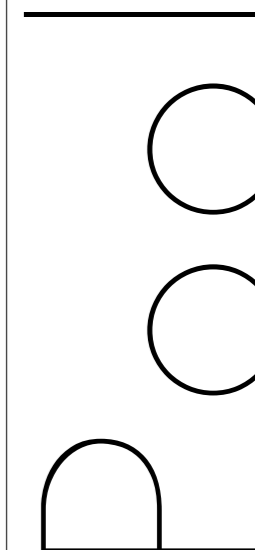



1504 Pool

- .01** Bianco - White
- .02** Nero - Black
- .31** Cromato - Chromed
- .38** Rame - Copper

Color temperature	LED Light source	lm source
WW 3000K	1,5W	162lm



0,90 Kg

1 elemento per decentramento incluso
1 displacement component included

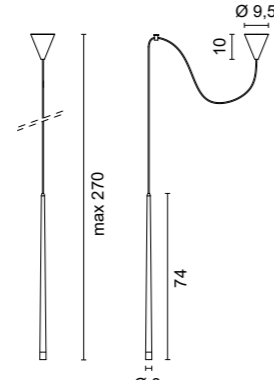

Codici finiture - Finishes codes

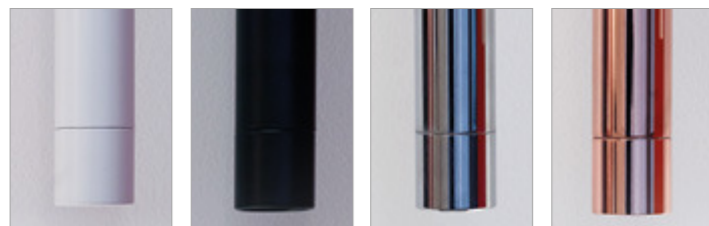

.01 **.02** **.31** **.38**





design **ABS Studio**
2012

00

Lampada o sistema di illuminazione a sospensione componibile a luce diretta con struttura in alluminio verniciato bianco opaco, schermo in metacrilato e cavi di alimentazione trasparenti. I sistemi sono componibili in configurazioni lineari o chiuse e gli accessori sono da ordinare separatamente.

Modular suspension lamp or lighting system providing direct light with a matt white painted aluminium frame, methacrylate screen and transparent power cables. The systems are modular in linear or closed configurations and accessories must be ordered separately.

Suspension modulaire ou système d'éclairage fournissant une lumière directe avec un cadre en aluminium peint en blanc mat, un écran en méthacrylate et des câbles d'alimentation transparents. Les systèmes sont modulaires en configuration linéaire ou fermée et les accessoires doivent être commandés séparément.

Lámpara de suspensión modular o sistema de iluminación que proporciona luz directa con marco de aluminio pintado en blanco mate, pantalla de metacrilato y cables de alimentación transparentes. Los sistemas son modulares en configuraciones lineales o cerradas y los accesorios deben pedirse por separado.

Modulares Hängeleuchten- oder Beleuchtungssystem für direktes Licht mit einem mattweiß lackierten Aluminiumrahmen, Methacrylatschirm und transparenten Stromkabeln. Die Systeme sind modular in linearer oder geschlossener Bauweise aufgebaut und das Zubehör muss separat bestellt werden.

MORIK



1507 Mork
.01 Bianco - White

Color temperature	LED Light source	lm source
WW 3000K	3,4W	350lm

F 250 CM 0,70 Kg

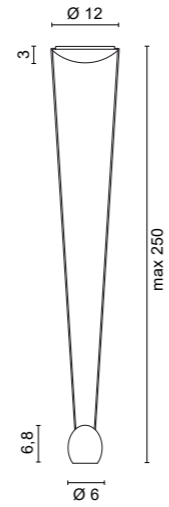

Codici finiture - Finishes codes



.01



1506 Mork System
 .01 Bianco - White

Color temperature LED Light source lm source
 /WW 3000K 1050mA 3,4W 350lm

0,45 Kg

Solo collegamento in serie - Only serial connection

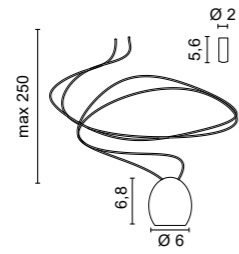

0506
 .01 Bianco - White

IN: 50/60Hz 220-240V
 Rosone completo di alimentatore - max 6 Mork
 Ceiling rose with converter - max 6 Mork

0,70 Kg

Dimmerabile su richiesta
 Dimmable on request

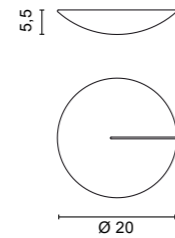

5 art. 1506.01WW + 1 art. 0506.01

Installazioni geometriche - Geometric installations

LEGENDA



Esempi di installazione geometriche - Examples of geometric configuration

3 MORK

3 art. 1506
 Mork (connector included)
 +
 1 art. 0506
 Rosone - Ceiling rose

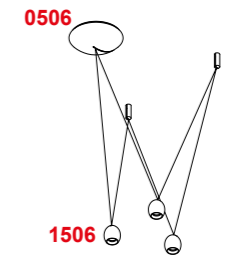
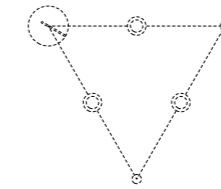

4 MORK

4 art. 1506
 Mork (connector included)
 +
 1 art. 0506
 Rosone - Ceiling rose

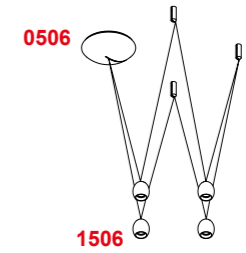
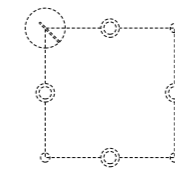

5 MORK

5 art. 1506
 Mork (connector included)
 +
 1 art. 0506
 Rosone - Ceiling rose

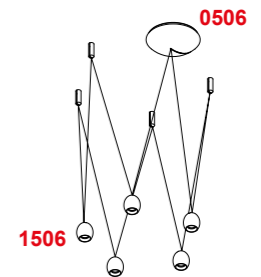
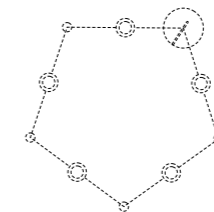

6 MORK

6 art. 1506
 Mork (connector included)
 +
 1 art. 0506
 Rosone - Ceiling rose

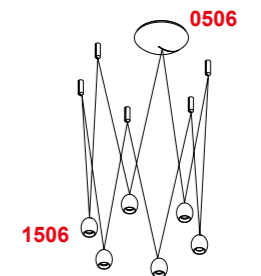
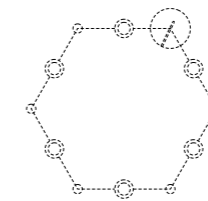

1506 Mork System
.01 Bianco - White

Color temperature **LED Light source** *lm source*
WW 3000K 1050mA 3,4W 350lm

0,45 Kg

Solo collegamento in serie - Only serial connection

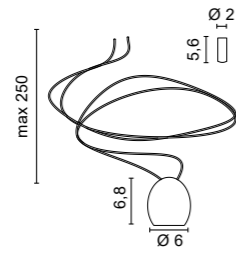

0506
.01 Bianco - White

IN: 50/60Hz 220-240V
 Rosone completo di alimentatore - max 6 Mork
 Ceiling rose with converter - max 6 Mork

0,70 Kg

Dimmerabile su richiesta
 Dimmable upon request

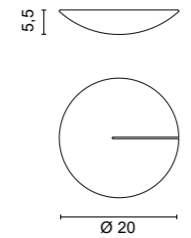

0507
.01 Bianco - White

Collegamento per configurazioni lineari
 da 2, 4, 6 Mork
 Optional for linear configurations
 2, 4 or 6 Mork

0,20 Kg

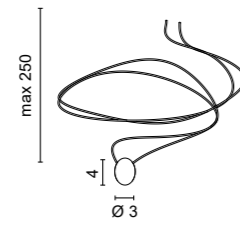

3 art. 1506.01WW + 1 art. 0506.01

Esempi di installazione in linea - Examples for linear configuration

2 MORK

2 art. 1506
 Mork (connector included)
 +
 1 art. 0506
 Rosone - Ceiling rose
 +
 1 art. 0507
 Collegamento per configurazioni
 lineari da 2,4,6 Mork
 Accessory for linear configuration
 2, 4 or 6 Mork

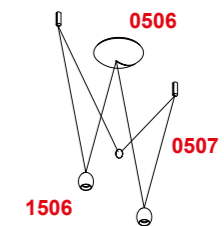
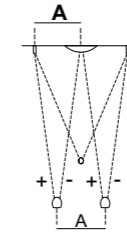

3 MORK

3 art. 1506
 Mork (connector included)
 +
 1 art. 0506
 Rosone - Ceiling rose

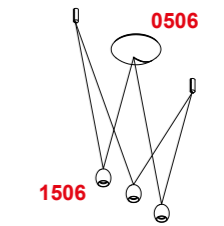
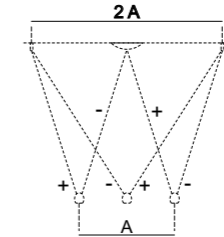

4 MORK

4 art. 1506
 Mork (connector included)
 +
 1 art. 0506
 Rosone - Ceiling rose
 +
 1 art. 0507
 Collegamento per configurazioni
 lineari da 2,4,6 Mork
 Accessory for linear configuration
 2, 4 or 6 Mork

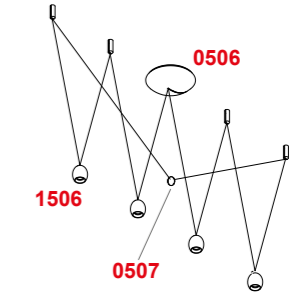
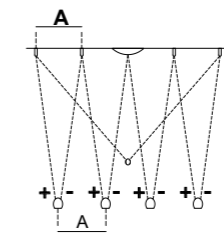

5 MORK

5 art. 1506
 Mork (connector included)
 +
 1 art. 0506
 Rosone - Ceiling rose

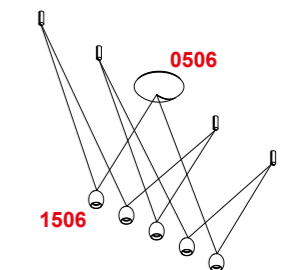
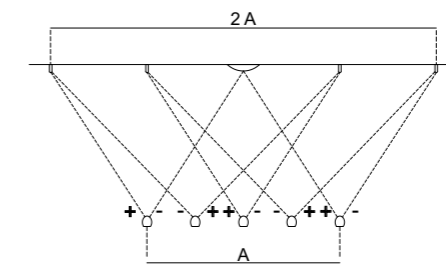

6 MORK

6 art. 1506
 Mork (connector included)
 +
 1 art. 0506
 Rosone - Ceiling rose
 +
 1 art. 0507
 Collegamento per configurazioni
 lineari da 2,4,6 Mork
 Accessory for linear configuration
 2, 4 or 6 Mork

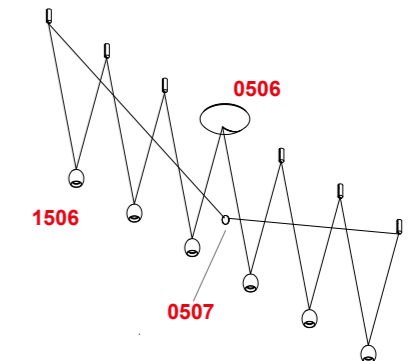
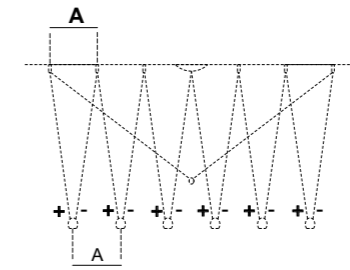



design **Studio Microsolco**
2013

412 414 416 416

Collezione di lampade a luce diffusa realizzate in filo di metacrilato, intrecciato e sovrapposto, e con portalampada con attacco E27 o G9. La particolarità della lavorazione e della qualità del metacrilato rendono ogni Matassa unica ed estremamente luminosa creando una suggestiva illuminazione d'effetto.

Collection of lamps with diffused light made of methacrylate wire, woven and overlapping, and with lampholders with E27 or G9 socket. The special workmanship and quality of the methacrylate make each Matassa unique and extremely bright, creating a striking lighting effect.

Collection de lampes à lumière diffuse en fil de méthacrylate, tressé et superposé, avec douilles E27 ou G9. Le travail particulier et la qualité du méthacrylate font de chaque Matassa une pièce unique et extrêmement lumineuse, créant un effet d'éclairage saisissant.

Colección de lámparas de luz difusa fabricadas con alambre de metacrilato, entretrejido y superpuesto, y con portalámparas con casquillo E27 o G9. La especial elaboración y la calidad del metacrilato hacen que cada Matassa sea única y extremadamente luminosa, creando un llamativo efecto de iluminación.

Kollektion von Lampen mit diffussem Licht aus Methacrylat-Draht, geflochten und überlappend, und mit Fassungen mit E27- oder G9-Fassung. Die besondere Verarbeitung und die Qualität des Methacrylats machen jede Matassa einzigartig und extrem hell, wodurch ein auffälliger Lichteffekt entsteht.

Matassa



1517 Matassa
.00 Trasparente - Transparent

Light source not included
 G9 LED
 3,5W (art. 0092/...)

  2,20 Kg

1518 Matassa
.00 Trasparente - Transparent

Light source not included
 E27 LED
 11W 1521lm (art. 0109/11/...)

  4,30 Kg

1519 Matassa
.00 Trasparente - Transparent

Light source not included
 E27 LED
 11W 1521lm (art. 0109/11/...)

  7,70 Kg

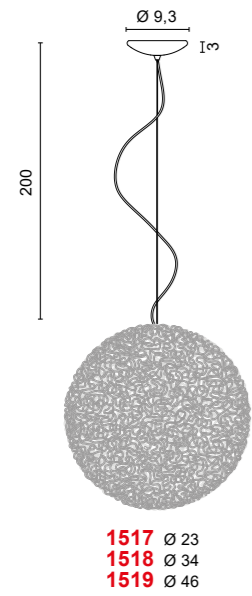

Codici finiture - Finishes codes



.00

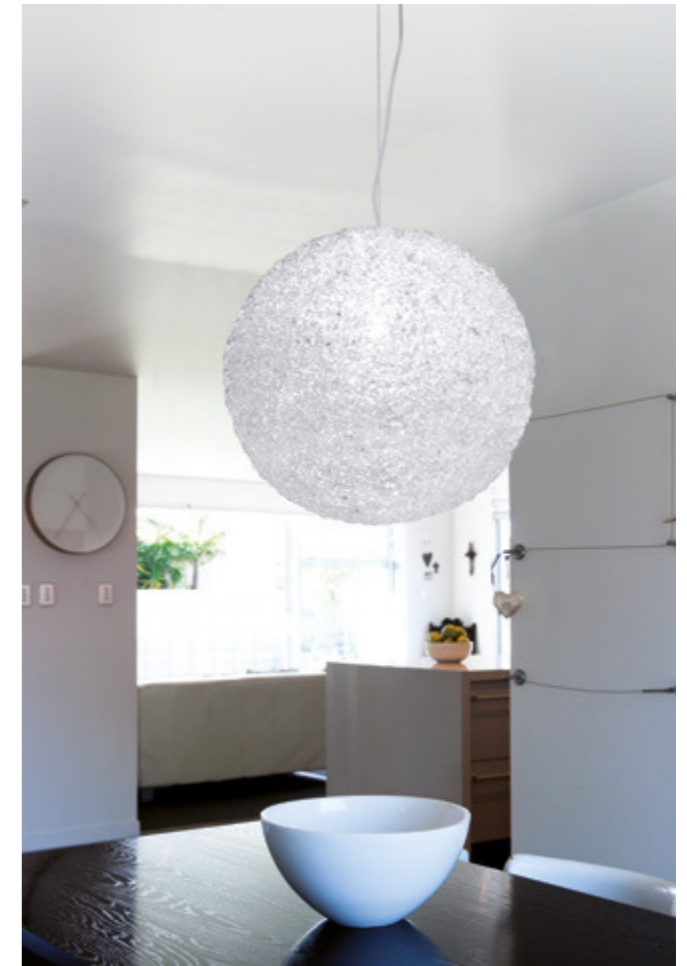

Accessori - Accessories



0532

$\varnothing 1$ cm
 H 3,5 cm

Elemento per decentramento
 Displacement component

.31 Cromato lucido - Chromed

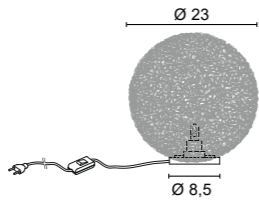
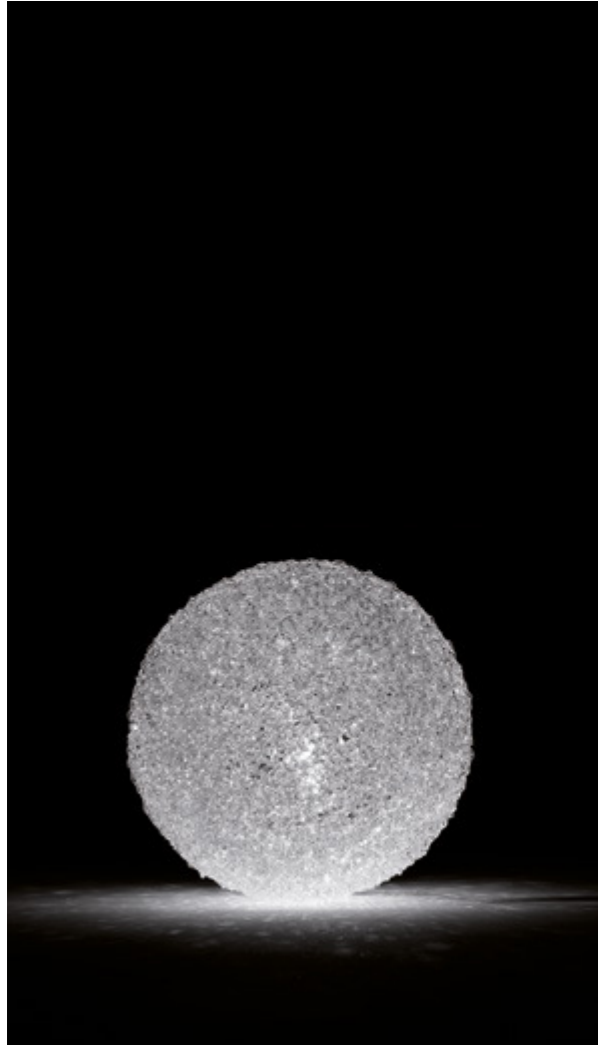

2127 Matassa
.00 Trasparente - Transparent

Light source not included
 G9 LED
 3,5W (art. 0092/...)

2,40 Kg

Accensione ON-OFF
 ON-OFF switch

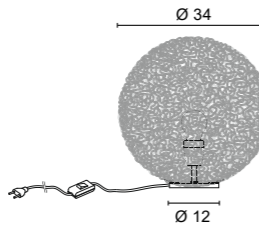

2128 Matassa
.00 Trasparente - Transparent

Light source not included
 E27 LED
 11W 1521lm (art. 0109/11/...)

5,20 Kg

Accensione ON-OFF
 ON-OFF switch

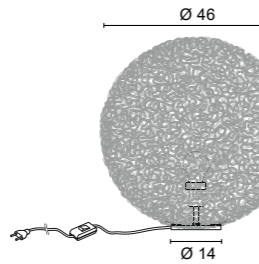

2129 Matassa
.00 Trasparente - Transparent

Light source not included
 E27 LED
 11W 1521lm (art. 0109/11/...)

9,70 Kg

Accensione ON-OFF
 ON-OFF switch



Codici finiture - Finishes codes



.00

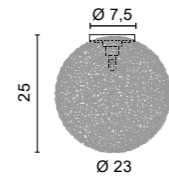
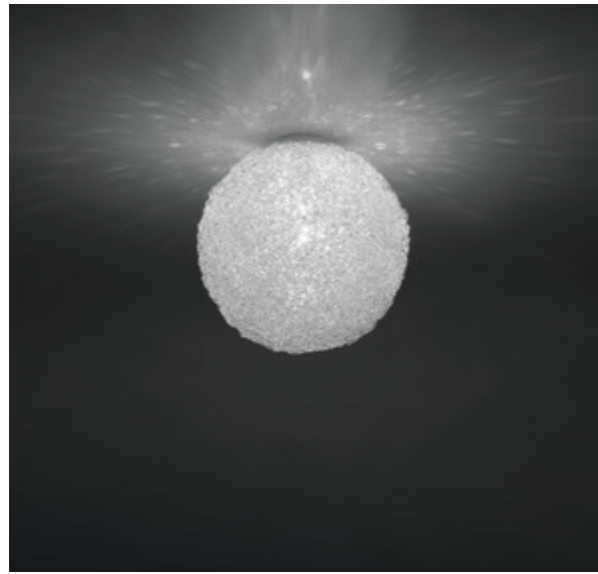

5229 Matassa
.00 Trasparente - Transparent

Light source not included
 G9 LED
 3,5W (art. 0092/...)



2,00 Kg

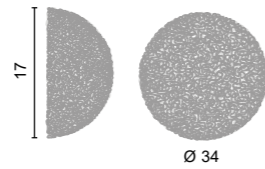
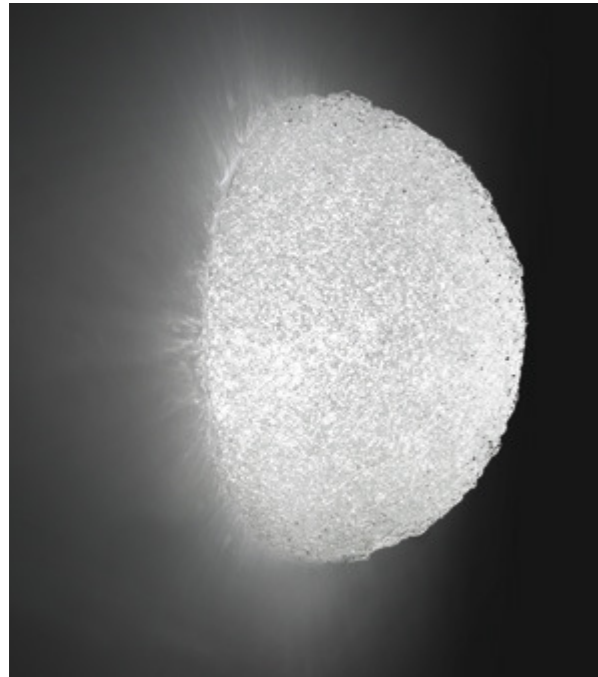

4533 Matassa
.00 Trasparente - Transparent

Light source not included
 E27 LED
 11W 1521lm (art. 0109/11/...)



2,40 Kg

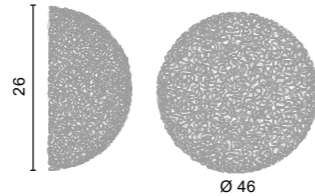

4534 Matassa
.00 Trasparente - Transparent

Light source not included
 E27 LED
 11W 1521lm (art. 0109/11/...)



4,80 Kg

Codici finiture - Finishes codes



.00





design **ABS Studio**
2011



420 420 422

Famiglia di lampade a luce diffusa con struttura in metallo e portalampada con attacco E27. Il paralume in tessuto tecnico ignifugo di colore bianco è da ordinare separatamente. Una versione a parete è disponibile anche con luce di lettura orientabile.

Family of diffused light lamps with metal frame and lamp holder with E27 socket. The lampshade in flame-retardant white technical fabric must be ordered separately. A wall version is also available with reading light.

Famille de lampes à lumière diffuse avec cadre métallique et douille avec prise E27. L'abat-jour en tissu technique blanc ignifugé est à commander séparément. Une version murale est également disponible avec une liseuse pivotante.

Familia de lámparas de luz difusa con estructura metálica y portalámparas con casquillo E27. La pantalla de tejido técnico ignifugo blanco debe pedirse por separado. También está disponible una versión de pared con luz de lectura orientable.

Familie von Streulichtlampen mit Metallrahmen und Lampenfassung mit E27-Fassung. Der Lampenschirm aus weißem, schwer entflammbarem technischem Gewebe ist separat zu bestellen. Eine wandmontierte Version ist auch mit einem schwenkbaren Leselicht erhältlich.

A | b | o



Alba 2117.01 + 8020.01

2117 Alba

.01 Bianco (senza paralume)
White (without shade)

Light source not included

E27 LED

11W 1521lm (art. 0109/11/...)



1.60 Kg

Accensione ON-OFF
ON-OFF switch

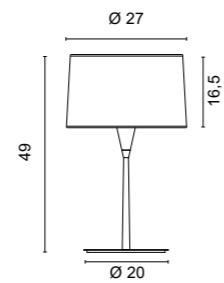
**8020.01**

Paralume in tessuto tecnico bianco ignifugo
Fireproof shade in white technical fabric



Alba 3098.01 + 8021.01

3098 Alba

.01 Bianco (senza paralume)
White (without shade)

Light source not included

E27 LED

11W 1521lm (art. 0109/11/...)



5.80 Kg

Accensione ON-OFF
ON-OFF switch

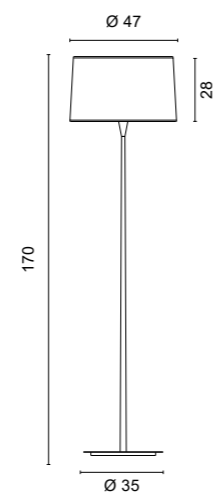
**8021.01**

Paralume in tessuto tecnico bianco ignifugo
Fireproof shade in white technical fabric



Codici finiture - Finishes codes



.01

**4392** Alba

.01 Bianco (senza paralume)
White (without shade)

Light source not included

E27 LED

11W 152lm (art. 0109/11/...)

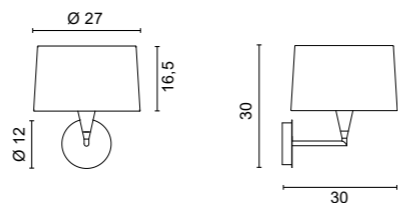

0,70 Kg

**8020.01**

Paralume in tessuto tecnico bianco ignifugo
Fireproof shade in white technical fabric

4393 Alba

.01 Bianco (senza paralume)
White (without shade)

E27 bulb not included

+ LED 350mA (1W Dimmerabile - Dimmable)

E27 LED

11W 152lm (art. 0109/11/...)

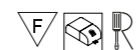

1,00 Kg

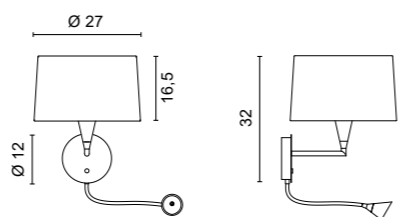
**8020.01**

Paralume in tessuto tecnico bianco ignifugo
Fireproof shade in white technical fabric

Codici finiture - Finishes codes



.01





design **Mati**
2020

Lampada a parete con telaio in acciaio armonico con portalam-pada con attacco GX53 e paralume direzionabile in PVC opacento, per un gradevole effetto updown, o in PVC bianco satinato per una luce diffusa.

Wall lamp with harmonic steel frame with lamp holder with GX53 socket and directional lampshade in opaque PVC, for a pleasant updown effect, or in white satin PVC for diffuse light.

Applique avec structure harmonieuse en acier avec douille GX53 et abat-jour directionnel en PVC opaque, pour un effet de descente agréable, ou en PVC blanc satiné pour une lumière diffuse.

Lámpara de pared con armadura de acero armónico con portalamparas con casquillo GX53 y pantalla direccional de PVC opaco, para un agradable efecto updown, o de PVC blanco satinado para una luz difusa.

Wandleuchte mit harmonischem Stahlrahmen mit Lampenfassung mit GX53-Fassung und richtungsweisendem Lampenschirm aus opakem PVC für einen angenehmen Aufwind-Effekt oder aus weißem satiniertem PVC für diffuses Licht.

Demi



4594 Demi
.01 Bianco - White
.02.21 Nero, interno oro - Black, gold inside

Light source not included
GX53 LED
8W 4000K 700lm (art. 0103/W) Dim
8W 3000K 680lm (art. 0103/WW) Dim
8W 2700K 650lm (art. 0103/XW) Dim

0,20 Kg

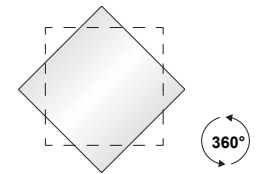
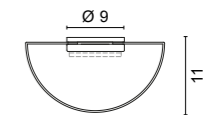
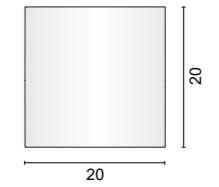

Codici finiture - Finishes codes

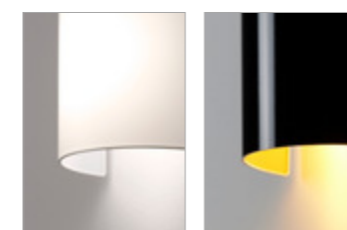

.01

.02.21



design **ABS Studio**
2009

428 429 430

Collezione di lampade orientabili a luce diretta con struttura in alluminio e driver integrato ideali per soluzioni da lettura. Disponibile in diverse tipologie di installazione con o senza interruttore. Disponibile completamente bianca, o con diffusore colorato, oppure totalmente nera.

Collection of direct-light adjustable lamps with aluminium frame and integrated driver ideal for reading solutions. Available in different installation types with or without switch. Available completely white, or with coloured diffuser, or completely black.

Collection de lampes orientables à lumière directe avec cadre en aluminium et driver intégré, idéales pour les solutions de lecture. Disponible dans différents types d'installation avec ou sans interrupteur. Disponible en blanc, ou avec un diffuseur coloré, ou en noir.

Colección de lámparas orientables de luz directa con marco de aluminio y driver integrado ideales para soluciones de lectura. Disponible en diferentes tipos de instalación con o sin interruptor. Disponible completamente blanca, o con difusor de color, o completamente negra.

Kollektion von verstellbaren Direktlichtlampen mit Aluminiumrahmen und integriertem Treiber, ideal für Leselösungen. Erhältlich in verschiedenen Installationsarten mit oder ohne Schalter. Erhältlich komplett weiß, mit farbigem Diffusor oder komplett schwarz.



Kalido

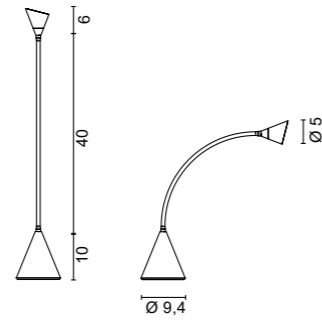

2502 Kalla

.01	Bianco - White
.02	Nero - Black
.06	Verde - Green
.09	Arancione - Orange
.10	Azzurro - Light blue
.11	Rosa - Pink

Color temperature	LED Light source	lm source
MW 3000K	1W	146lm

0,90 Kg

Accensione ON-OFF
ON-OFF switch

2700K - 4000K su richiesta
2700K - 4000K on request

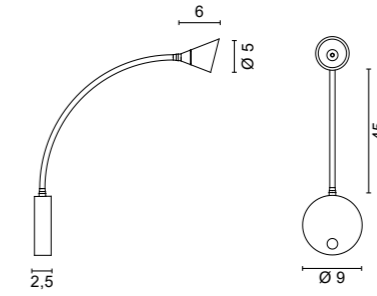

4501 Kalla

.01	Bianco - White
.02	Nero - Black
.06	Verde - Green
.09	Arancione - Orange
.10	Azzurro - Light blue
.11	Rosa - Pink

Color temperature	LED Light source	lm source
MW 3000K	1W	146lm

0,30 Kg

Accensione ON-OFF
ON-OFF switch

2700K - 4000K su richiesta
2700K - 4000K on request



Kalla 4501 da parete con interruttore
Kalla 4501 wall-mounted with switch

Codici finiture - Finishes codes



Codici finiture - Finishes codes



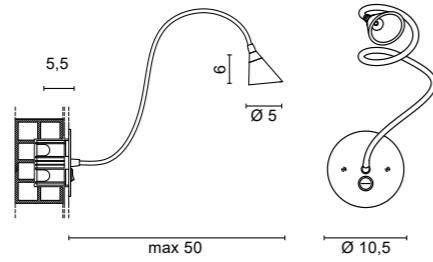

4541 Kalla Due

- .01** Bianco - White
- .02** Nero - Black
- .06** Verde - Green
- .09** Arancione - Orange
- .10** Azzurro - Light blue
- .11** Rosa - Pink

Color temperature	LED Light source	lm source
WW 3000K	1W	146lm



Accensione ON-OFF
ON-OFF switch

2700K - 4000K su richiesta
2700K - 4000K on request

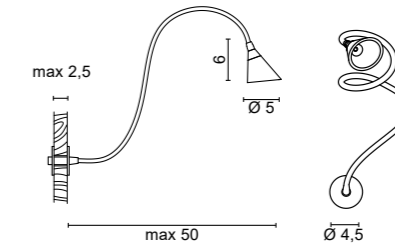

4540 Kalla Due

- .01** Bianco - White
- .02** Nero - Black
- .06** Verde - Green
- .09** Arancione - Orange
- .10** Azzurro - Light blue
- .11** Rosa - Pink

Color temperature	LED Light source	lm source
WW 3000K	1W	146lm



2700K - 4000K su richiesta
2700K - 4000K on request



Kalla Due 4541 con interruttore per incasso su parete
Kalla Due 4541 with switch for wall mounting



SomVita Suites
Ph. Hannes Niederkofler

Kalla Due 4540 per montaggio su pannello
Kalla Due 4540 for panel mounting

Codici finiture - Finishes codes



Codici finiture - Finishes codes





design **Mati**
2024

434 436

Lampade orientabili da parete a luce diretta con struttura in alluminio e alimentatore integrato ideali per soluzioni da lettura. Disponibili in varie finiture comprese quelle galvaniche.

Direct-light wall-mounted adjustable lamps with aluminium frame and integrated driver ideal for reading solutions. Available in various finishes including galvanic finishes.

Appliques réglables à lumière directe avec cadre en aluminium et driver intégré, idéales pour les solutions de lecture. Disponibles en différentes finitions, y compris des finitions galvaniques.

Apliques orientables de luz directa con marco de aluminio y driver integrado ideales para soluciones de lectura. Disponibles en varios acabados, incluidos acabados galvanicos.

Verstellbare Wandleuchten mit direktem Licht, Aluminiumrahmen und integriertem Driver, ideal für Leselösungen. Erhältlich in verschiedenen Ausführungen, einschließlich galvanischer Oberflächen.

B a m b o o

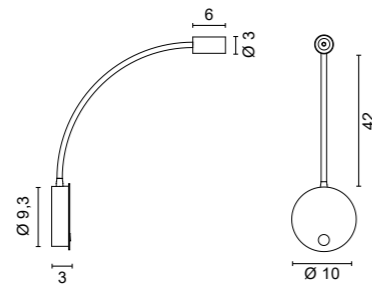

4622 Bamboo

- .01** Bianco - White
- .02** Nero - Black
- .25** Diffusore dorato satinato, struttura nera
Satin gold diffuser, black frame

Color temperature LED Light source lm source
WW 3000K 1W 146lm



0.40 Kg

Accensione ON-OFF
 ON-OFF switch

2700K - 4000K su richiesta
 2700K - 4000K on request



Codici finiture - Finishes codes

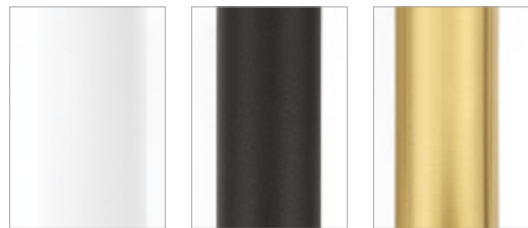

.01

.02

.25



Bamboo 4622 da parete con interruttore
 Bamboo 4622 wall-mounted with switch



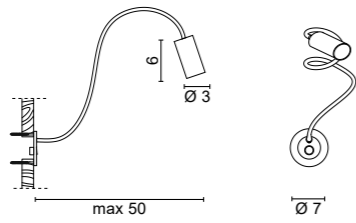
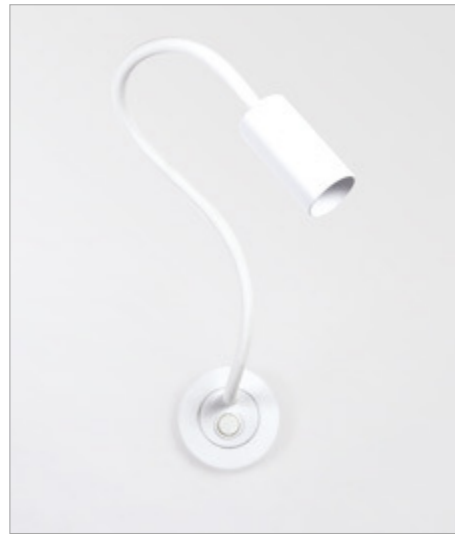

4621 Bamboo

- .01** Bianco - *White*
- .02** Nero - *Black*
- .25** Diffusore dorato satinato, struttura nera
Satin gold diffuser, black frame

Color temperature	LED Light source	lm source
WW 3000K	1W	146lm



0,30 Kg

Accensione ON-OFF
ON-OFF switch

2700K - 4000K su richiesta
2700K - 4000K on request



Codici finiture - *Finishes codes*

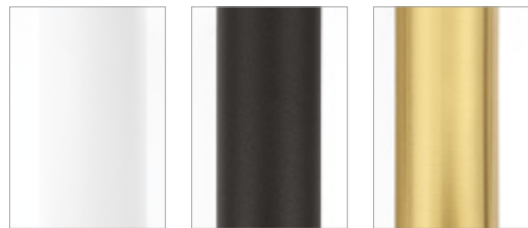

.01

.02

.25



Bamboo 4621 per montaggio su pannello
Bamboo 4621 for panel mounting



design **Mati**
2021

440

Lampada da tavolo orientabile e dimmerabile a luce diffusa con struttura in alluminio, diffusore in policarbonato opalino, completa di alimentatore a spina e dimmer push su cavo.

Adjustable and dimmable table lamp providing diffused light with aluminium frame, opal polycarbonate diffuser, complete with plug-in driver and push-on cable dimmer.

Lampe de table à lumière diffuse, réglable et dimmable, avec structure en aluminium, diffuseur en polycarbonate opale, complète avec driver enchufable et dimmateur à câble à poussoir.

Lámpara de sobremesa de luz difusa, orientable y regulable, con estructura de aluminio, difusor de policarbonato opalino, driver enchufable y regulador de intensidad por cable.

Verstellbare und dimmbare Tischleuchte für diffuses Licht mit Aluminiumrahmen und opalem Polycarbonatdiffusor, komplett mit steckerfertigem Driver und Kabelaufsteckdimmer.

Zetod

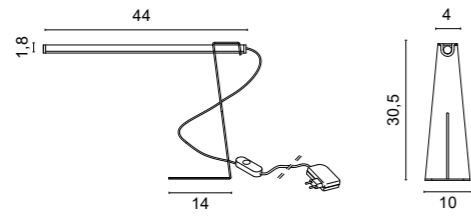

2522 Zeta

- .01** Bianco - White
- .02** Nero - Black

Color temperature	LED Light source	lm source
/W 4000K	6W	736lm
/WW 3000K	6W	660lm
/XW 2700K	6W	624lm

F Dim CRI 90 1,30 Kg

Completa di DIMMER su cavo nero
With DIMMER on black cable

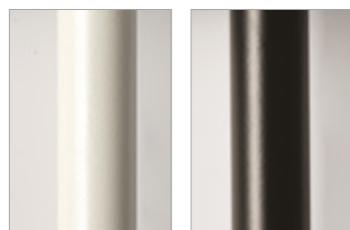

.01

.02



design **S. Cornelissen**
2015

444

Lampade da parete a luce indiretta con struttura in metallo e alimentatore integrato. Disponibile in due dimensioni e in diverse finiture. La lampada è predisposta per un cablaggio passante che permette di accostare più apparecchi tra di loro partendo da un solo punto di collegamento elettrico.

Indirect light wall lamps with metal frame and integrated driver. Available in two sizes and different finishes. The lamp is prepared for a feed-through wiring that allows several luminaires to be connected together from a single electrical connection point.

Appliques à lumière indirecte avec cadre métallique et driver intégré. Disponible en deux tailles et différentes finitions. La lampe est préparée pour un câblage traversant qui permet de connecter plusieurs luminaires à partir d'un seul point de connexion électrique.

Apliques de luz indirecta con estructura metálica y driver integrado. Disponibles en dos tamaños y diferentes acabados. La lámpara está preparada para un cableado pasante que permite conectar varias luminarias entre sí desde un único punto de conexión eléctrica.

Indirekt strahlende Wandleuchten mit Metallrahmen und integriertem Driver. Erhältlich in zwei Größen und verschiedenen Ausführungen. Die Leuchte ist für eine Durchgangsverdrahtung vorbereitet, die es ermöglicht, mehrere Leuchten über einen einzigen elektrischen Anschlusspunkt miteinander zu verbinden.

M o t s

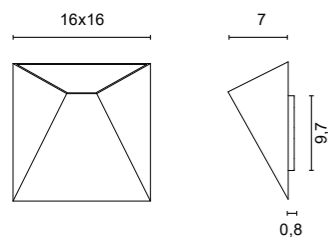

4564 Mats

- .01** Bianco - *White*
- .02** Nero - *Black*
- .35** Verniciato sabbia - *Painted sand finishing*
- .85** Verniciato argento - *Painted silver finishing*
- .86** Verniciato oro - *Painted gold finishing*
- .87** Verniciato rame - *Painted copper finishing*
- .88** Verniciato bronzo - *Painted bronze finishing*

Color temperature	LED Light source	lm source
/W 4000K	6W	966lm
/WW 3000K	6W	910lm
/XW 2700K	6W	873lm



0,60 Kg

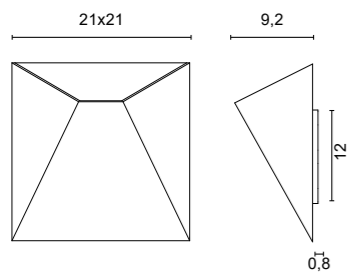

4565 Mats

- .01** Bianco - *White*
- .02** Nero - *Black*
- .35** Verniciato sabbia - *Painted sand finishing*
- .85** Verniciato argento - *Painted silver finishing*
- .86** Verniciato oro - *Painted gold finishing*
- .87** Verniciato rame - *Painted copper finishing*
- .88** Verniciato bronzo - *Painted bronze finishing*

Color temperature	LED Light source	lm source
/W 4000K	9W	1302lm
/WW 3000K	9W	1227lm
/XW 2700K	9W	1178lm



1,00 Kg

Dimmerabile TRIAC su richiesta
TRIAC dimmable on request

Codici finiture - *Finishes codes*

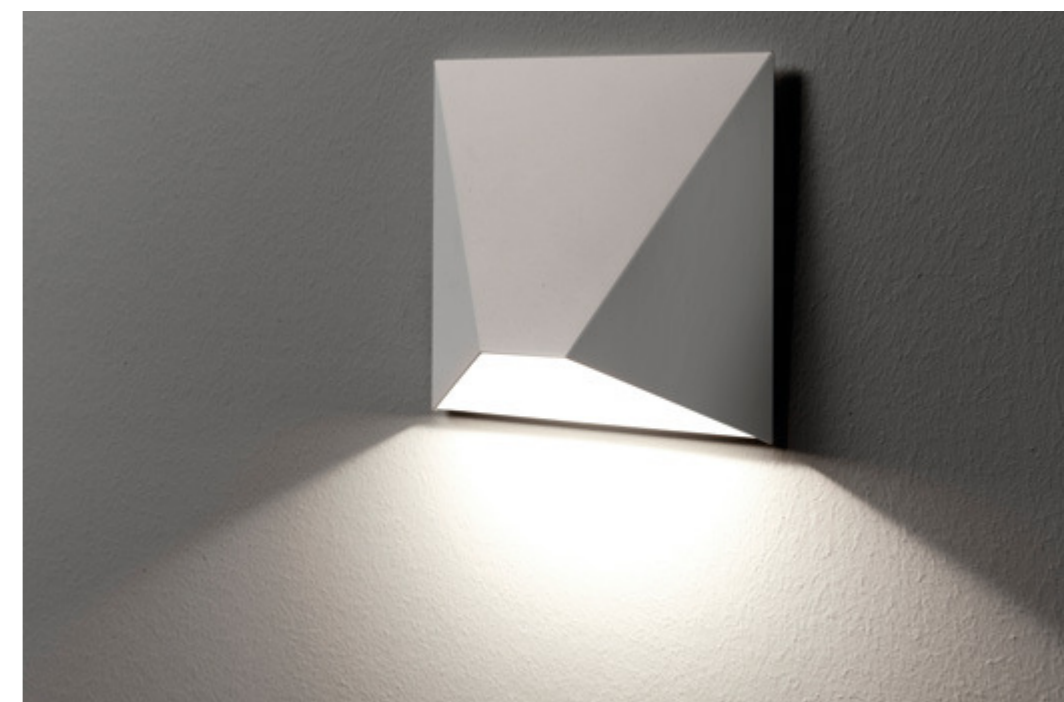
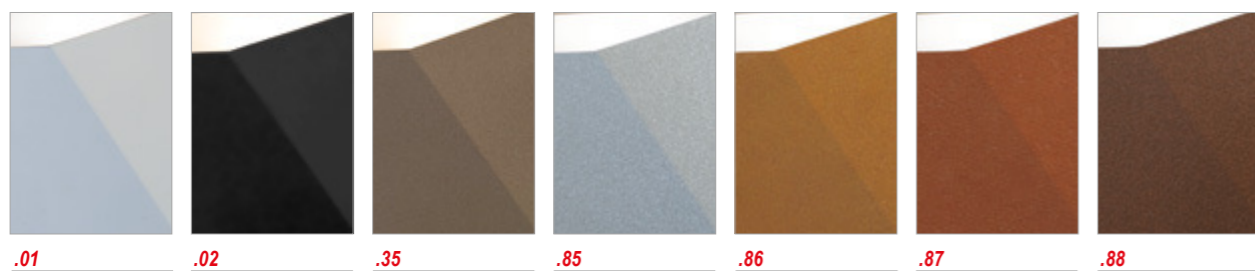



design **S. Cornelissen**
2016

448

Lampade da parete a luce radente a doppia emissione con struttura in metallo, maschera frontale in alluminio, diffusori in metacrilato e alimentatore integrato. Il posizionamento dei circuiti LED nella totale lunghezza dell'apparecchio rendono Ci una lampada estremamente performante. Dimmerabile su richiesta.

Dual-emission grazing light wall lamps with metal frame, aluminium front mask, methacrylate diffusers and integrated driver. The positioning of the LED circuits along the full length of the luminaire makes Ci an extremely high-performance lamp. Dimmable on request.

Appliques à lumière rasante à double émission avec cadre métallique, masque frontal en aluminium, diffuseurs en méthacrylate et driver intégré. Le positionnement des circuits LED sur toute la longueur du luminaire fait de Ci une lampe extrêmement performante. Dimmable sur demande.

Apliques de luz rasante de doble emisión con marco metálico, máscara frontal de aluminio, difusores de metacrilato y driver integrado. El posicionamiento de los circuitos LED a lo largo de toda la luminaria convierte a Ci en una lámpara de muy alto rendimiento. Regulable bajo pedido.

Zweistrahliges Streiflicht-Wandleuchten mit Metallrahmen, Aluminium-Frontscheibe, Methacrylat-Diffusoren und integriertem Driver. Die Positionierung der LED-Schaltkreise über die gesamte Länge der Leuchte macht Ci zu einer äußerst leistungsstarken Leuchte. Dimmbar auf Anfrage.

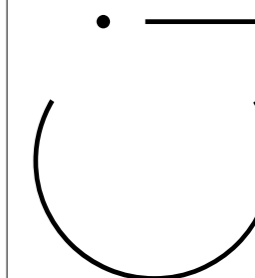

**4574** Ci

- .01** Bianco - *White*
- .02** Nero - *Black*
- .23** Alluminio satinato - *Satin aluminium*

Color temperature	LED Light source	lm source
/W 4000K	12,5W	1930lm
/WW 3000K	12,5W	1830lm



1,70 Kg

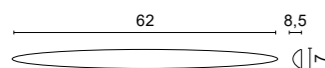

Dimmerabile PUSH - DALI su richiesta
Dimmable PUSH - DALI on request

4575 Ci

- .01** Bianco - *White*
- .02** Nero - *Black*
- .23** Alluminio satinato - *Satin aluminium*

Color temperature	LED Light source	lm source
/W 4000K	25W	3860lm
/WW 3000K	25W	3680lm



2,00 Kg

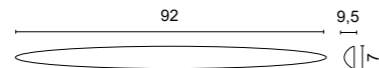

Dimmerabile PUSH - DALI su richiesta
Dimmable PUSH - DALI on request

4576 Ci

- .01** Bianco - *White*
- .02** Nero - *Black*
- .23** Alluminio satinato - *Satin aluminium*

Color temperature	LED Light source	lm source
/W 4000K	37,5W	5790lm
/WW 3000K	37,5W	5520lm

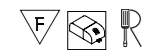

3,00 Kg

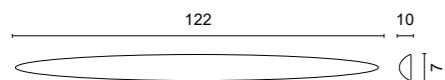

Dimmerabile PUSH - 1...10V - DALI su richiesta
Dimmable PUSH - 1...10V - DALI on request

4577 Ci

- .01** Bianco - *White*
- .02** Nero - *Black*
- .23** Alluminio satinato - *Satin aluminium*

Color temperature	LED Light source	lm source
/W 4000K	50W	7720lm
/WW 3000K	50W	7360lm



3,90 Kg

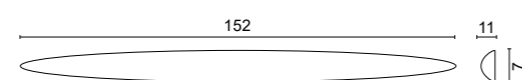

Dimmerabile PUSH - 1...10V - DALI su richiesta
Dimmable PUSH - 1...10V - DALI on request

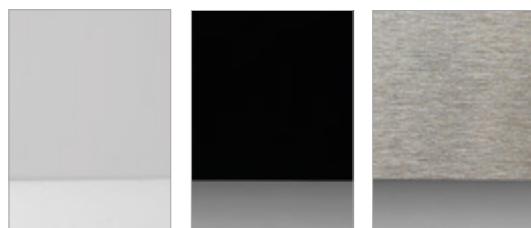
Codici finiture - *Finishes codes***.01****.02****.23**



design **ABS Studio**
2006-2015



Collezione di lampade dal caratteristico design cubiforme con struttura in alluminio o in vetro extra chiaro verniciato in bianco. Disponibile in versione con sorgente COB LED ed alimentatore integrato o con portalampada con attacco per lampadine G9 o GU10.

A collection of lamps with a characteristic cubiform design with an aluminium or extra-clear glass structure painted white. Available in versions with COB LED source and integrated driver or with lamp holder for G9 or GU10 bulbs.

Une collection de lampes au design cubique caractéristique, avec une structure en aluminium ou en verre laqué blanc extra-clair. Disponible dans les versions avec source LED COB et driver intégré ou avec douille pour ampoules G9 ou GU10.

Colección de lámparas de característico diseño cubiforme con estructura de aluminio o cristal pintado blanco extraclearo. Disponible en versiones con fuente LED COB y driver integrado o con portalámparas para bombillas G9 o GU10.

Eine Lampenkollektion mit charakteristischem würfelförmigem Design und einer Struktur aus Aluminium oder extraklarem weiß lackiertem Glas. Erhältlich in Versionen mit COB-LED-Quelle und integriertem Driver oder mit Lampenfassung mit G9- oder GU10-Glühbirnenfassung.

A | E | O

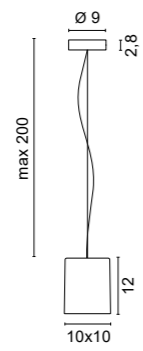

1147 Alea
.57 Vetro bianco - White glass
 Light source not included
 G9 LED
 3,5W (art. 0092/...)
 F 1,10 Kg

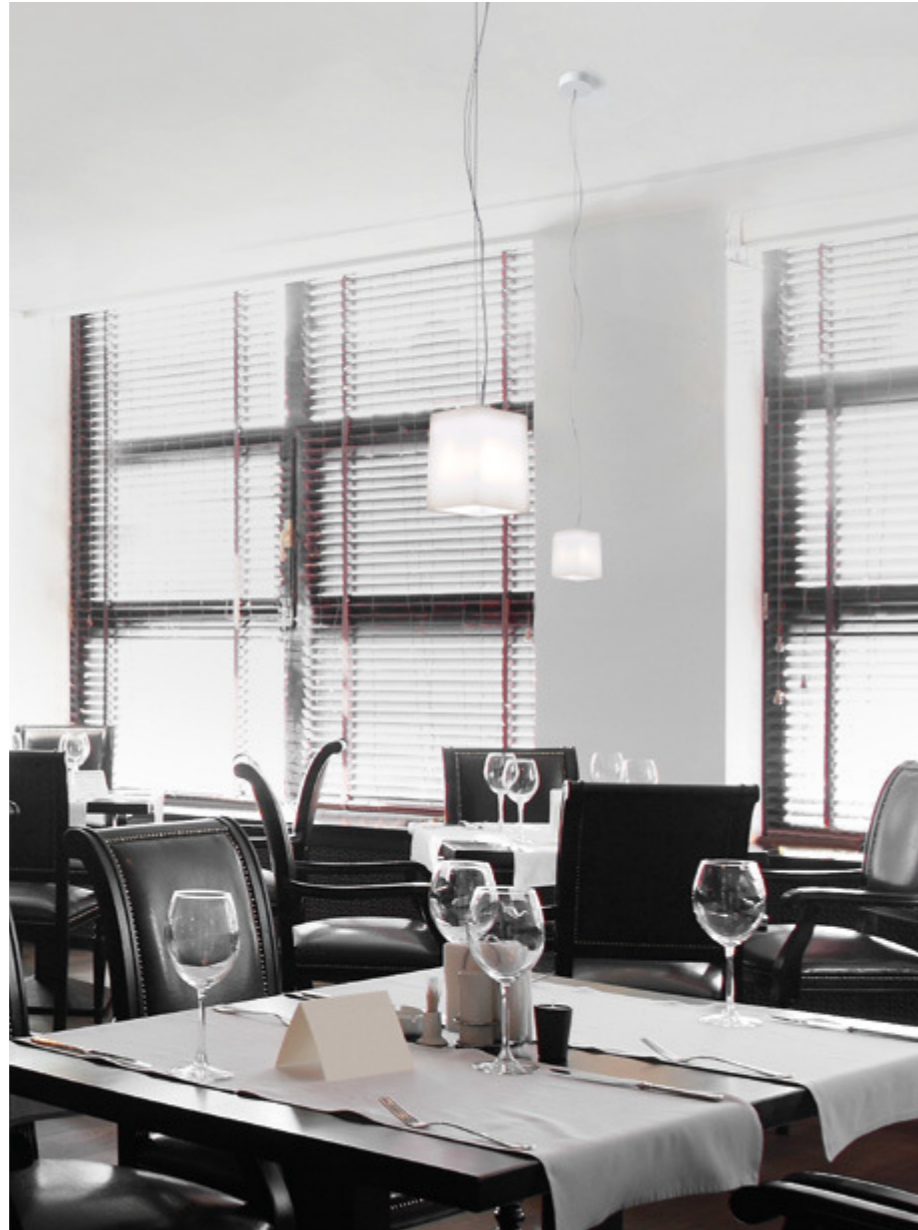

Codici finiture - Finishes codes

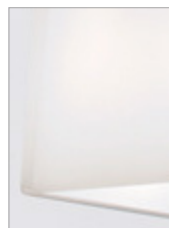

.57

Accessori - Accessories

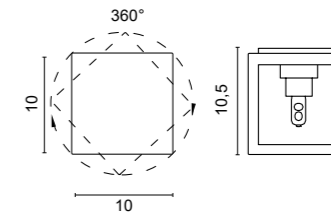
**0532**Ø 1 cm
H 3,5 cmElemento per decentramento
Displacement component**.31** Cromato lucido - Chromed

4282 Alea
.57 Vetro bianco - White glass
 Light source not included
 G9 LED
 3,5W (art. 0092/...)
 F 0,60 Kg

Codici finiture - Finishes codes



.57

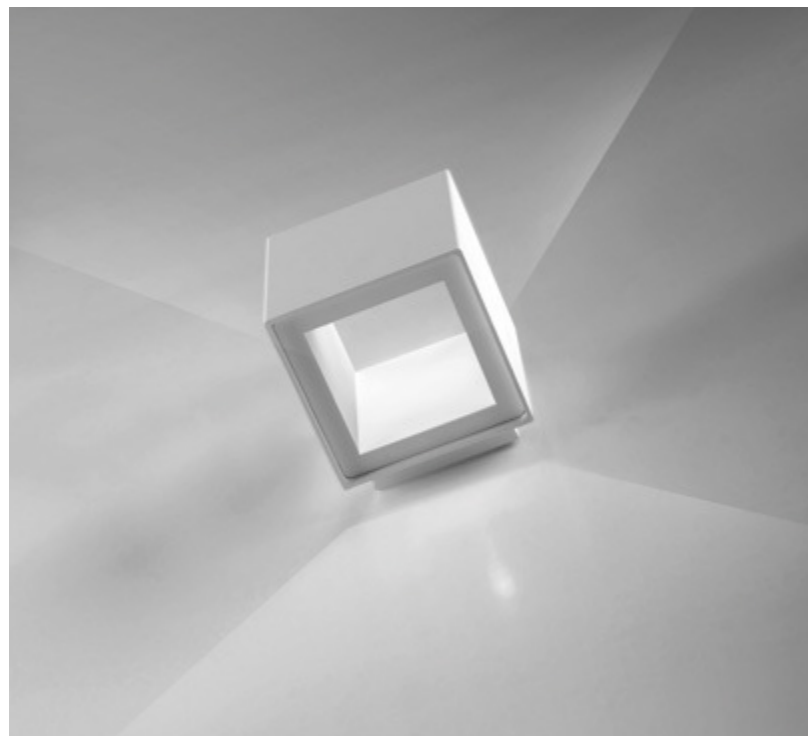

- 4561** Alea LED
- .01** Bianco - White
 - .01.11** Bianco, interno rosa - White, pink inside
 - .01.30** Bianco, interno foglia argento - White, silver leaf inside
 - .02.01** Nero, interno bianco - Black, white inside
 - .02.29** Nero, interno foglia oro - Black, gold leaf inside
 - .25.01** Dorato satinato, interno bianco - Gold satin, white inside
 - .31.01** Cromato lucido, interno bianco - Chromed, white inside
 - .35** Verniciato sabbia - Painted sand finishing

Color temperature	LED Light source	lm source
/W 4000K	6W	966lm
/WW 3000K	6W	910lm
/XW 2700K	6W	873lm

0,70 Kg

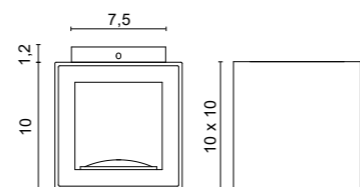

Codici finiture - Finishes codes



Accessori - Accessories

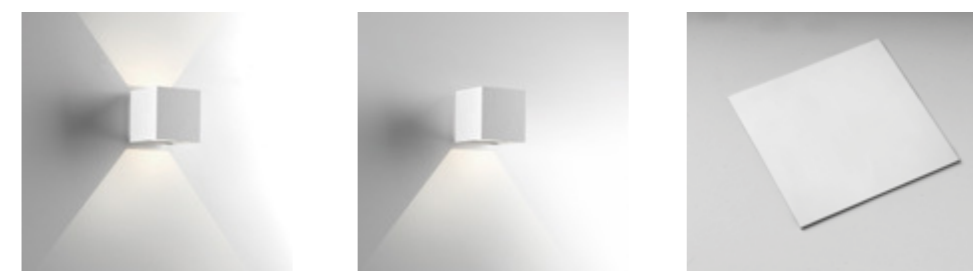

0182
 1 schermo per luce monodirezionale
 1 screen for single side light

- .01** Bianco - White
- .02** Nero - Black
- .35** Verniciato sabbia
Painted sand finishing



5561 Alea LED
 .01 Bianco - White
 .02 Nero - Black

Color temperature	LED Light source	lm source
/W 4000K	6W	966lm
/WW 3000K	6W	910lm
/XW 2700K	6W	873lm



0,70 Kg

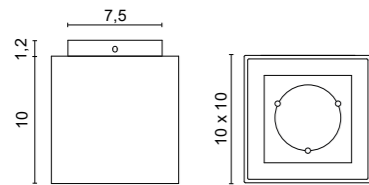

Codici finiture - Finishes codes



.01

.02



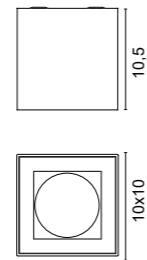

5176 Alea
 .01 Bianco - White
 .02 Nero - Black
 .35 Verniciato sabbia - Painted sand finishing

Light source
 GU10 LED
 7W 4000K 630lm (art. 0094/W)
 7W 3000K 600lm (art. 0094/WW)
 7W 2700K 580lm (art. 0094/XW)

7W 4000K 550lm (art. 0104/W) 
 7W 3000K 530lm (art. 0104/WW) 
 7W 2700K 510lm (art. 0104/XW) 

 0,50 Kg

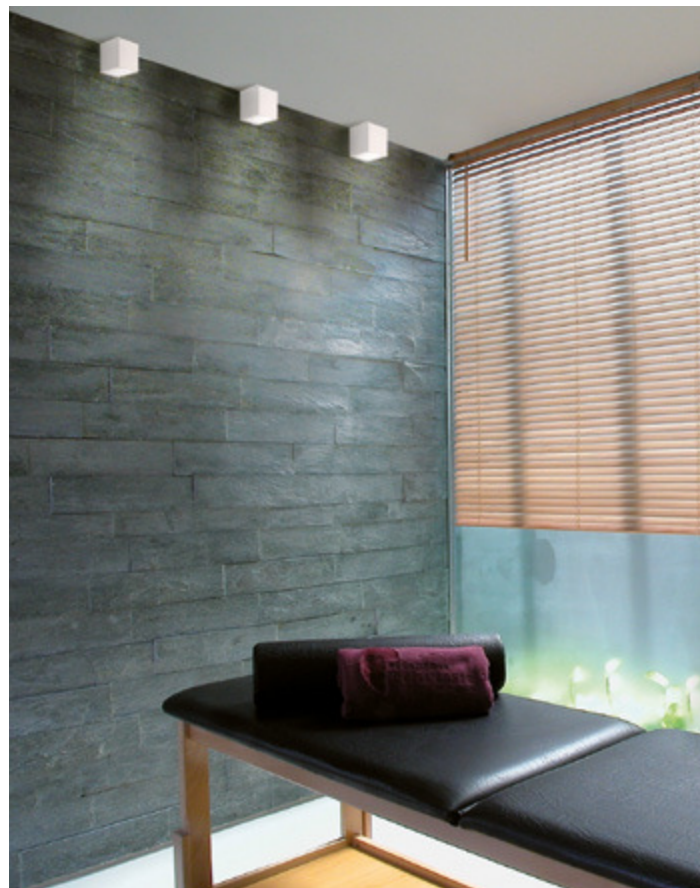

Accessori - Accessories



0205
 Cornice in acciaio con vetro Pyrex sabbato IP40
 Lampadina H max 5,5 cm
 IP40 steel frame with Pyrex glass
 Lamp H max 5,5 cm

.01 Bianco - White
 .02 Nero - Black
 .35 Verniciato sabbia - Painted sand finishing

Codici finiture - Finishes codes

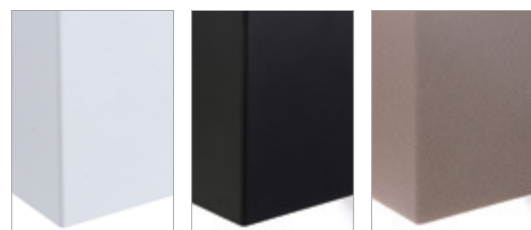

.01 .02 .35

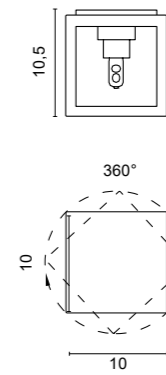

4281 Alea
 .01 Bianco - White
 .02 Nero - Black
 .35 Verniciato sabbia - Painted sand finishing

Light source
 G9 LED
 3,5W (art. 0092/...)

 0,50 Kg

Accessori - Accessories

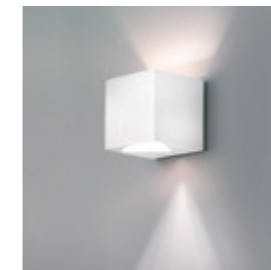

0187
 Cornice in acciaio con apertura triangolare
 Steel plate with triangular opening

.01 Bianco - White
 .02 Nero - Black
 .35 Verniciato sabbia - Painted sand finishing

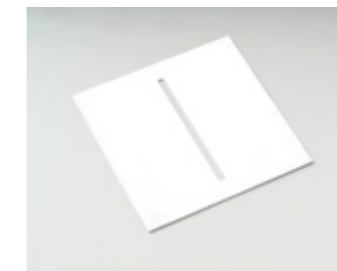
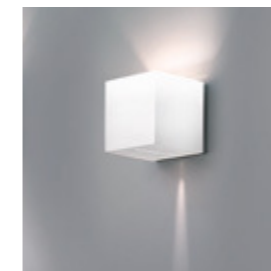

0189
 Cornice in acciaio con fuga di luce centrale
 Steel plate with central slot

.01 Bianco - White
 .02 Nero - Black
 .35 Verniciato sabbia - Painted sand finishing



0205
 Cornice in acciaio vetro Pyrex sabbato
 Steel frame with Pyrex glass

.01 Bianco - White
 .02 Nero - Black
 .35 Verniciato sabbia - Painted sand finishing

Codici finiture - Finishes codes



.01 .02 .35



design **ABS Studio**
2004

462 462

Lampada da parete o da plafone a luce diffusa con struttura in alluminio e diffusore in metacrilato satinato. Disponibile in due misure, diverse finiture, in versione con sorgente COB LED, con alimentatore integrato e con la possibilità di dimmerazione, oppure con portalampada con attacco GX53.

Wall or ceiling lamp providing diffused light with aluminium structure and satin methacrylate diffuser. Available in two sizes, different finishes, in versions with COB LED source, with integrated driver and possibility of dimming, or with lamp holder with GX53 socket.

Applique ou plafonnier à lumière diffuse avec structure en aluminium et diffuseur en méthacrylate satiné. Disponible en deux tailles, dans différentes finitions, dans les versions avec source LED COB, avec driver intégré ou gradable, ou avec douille GX53.

Aplique o plafón de luz difusa con estructura de aluminio y difusor de metacrilato satinado. Disponible en dos tamaños, diferentes acabados, en versiones con fuente LED COB, con driver integrado o regulable, o con portalámparas con casquillo GX53.

Wand- oder Deckenleuchte für diffuses Licht mit Aluminiumstruktur und satiniertem Methacrylatdiffusor. Erhältlich in zwei Größen, verschiedenen Ausführungen, in Versionen mit COB-LED-Quelle, mit integriertem Driver oder dimmbar, oder mit Lampenfassung mit GX53-Fassung.

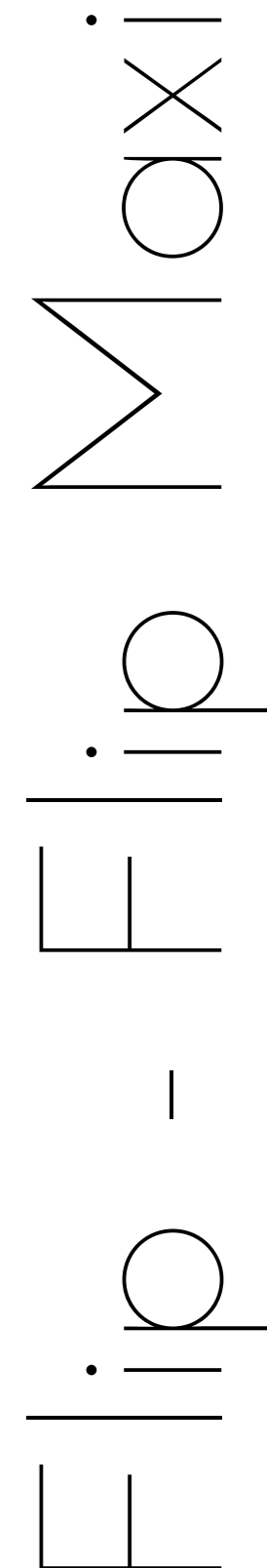

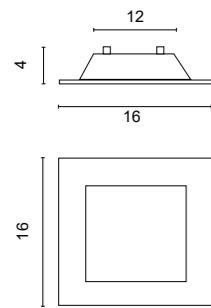

5529 Flip

- .01** Bianco - *White*
- .02** Nero - *Black*
- .31** Cromato lucido - *Shiny chromed*
- .32** Nickel satinato - *Nickel mat*
- .35** Verniciato sabbia - *Painted sand finishing*

Light source not included

GX53 LED

8W 4000K 700lm (art. 0103/W)



8W 3000K 680lm (art. 0103/WW)



8W 2700K 650lm (art. 0103/XW)



0,60 Kg

Codici finiture - *Finishes codes*



.01

.02

.31

.32

.35



5159 Flip Maxi

- .01** Bianco - *White*
- .02** Nero - *Black*
- .35** Verniciato sabbia - *Painted sand finishing*

Color temperature	LED Light source	lm source
/W 4000K	17,3W	2330lm
/WW 3000K	17,3W	2200lm



2,30 Kg

5161 Flip Maxi DIM

- .01** Bianco - *White*
- .02** Nero - *Black*
- .35** Verniciato sabbia - *Painted sand finishing*

Dimmerabile 1...10V - 1...10V dimming

Color temperature	LED Light source	lm source
/W/DIM 4000K	17,3W	2330lm
/WW/DIM 3000K	17,3W	2200lm



2,30 Kg

5161 Flip Maxi DALI

- .01** Bianco - *White*
- .02** Nero - *Black*
- .35** Verniciato sabbia - *Painted sand finishing*

Dimmerabile DALI - DALI dimming

Color temperature	LED Light source	lm source
/W/DALI 4000K	17,3W	2330lm
/WW/DALI 3000K	17,3W	2200lm



2,30 Kg

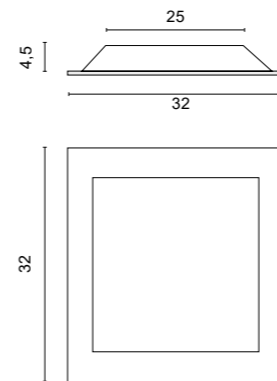

Nuova versione altezza 4,5 cm
New version height 4,5 cm

Codici finiture - *Finishes codes*



.01

.02

.35

design **ABS Studio**
1998

Lampada da parete a luce diffusa
in vetro soffiato satinato bianco
con particolari cromati e porta-
lampada con attacco E27.

Wall lamp providing diffused light
in white satin-finish blown glass
with chrome-plated details and
lamp holder with E27 socket.

Applique à lumière diffuse en
verre soufflé blanc satiné avec
détails chromés et douille avec
prise E27.

Aplique de luz difusa de cristal
soplado blanco satinado con de-
talles cromados y portalámparas
con casquillo E27.

Wandleuchte mit diffusem Licht
aus mundgeblasenem, satinier-
tem, weißem Glas mit verchrom-
ten Details und Lampenfassung
mit E27-Fassung.

F u s ò



4021 Fusò
.57 Vetro bianco - White glass
Light source not included
E27 LED
8W 1055lm (art. 0109/8/...)
11W 1521lm (art. 0109/11/...)

4023 Fusò
.57 Vetro bianco - White glass
Light source not included
E27 LED
8W 1055lm (art. 0109/8/...)
11W 1521lm (art. 0109/11/...)

 0,90 Kg

 1,50 Kg

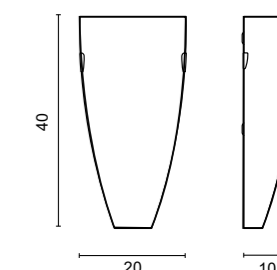
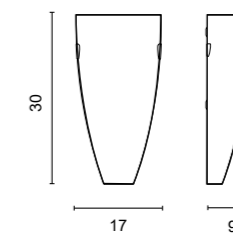

Accessori - Accessories



0009/P
Griglia di protezione per Fusò 4021
Protection net for Fusò 4021



0009/G
Griglia di protezione per Fusò 4023
Protection net for Fusò 4023

Codici finiture - Finishes codes



.57





design **ABS Studio**
2002

468 469

Collezione di lampade da tavolo e da terra a luce diffusa con struttura in nickel satinato, vetro soffiato bianco e con portalam-pada con attacco E27. La linea classica e le differenti dimensioni rendono Dama una lampada estremamente funzionale.

A collection of table and floor lamps providing diffused light with a satin nickel frame, white blown glass and E27 lamp holder. The classic line and different sizes make Dama an extremely functional lamp.

Une collection de lampes de table et de lampadaires à lumière diffuse avec une structure en nickel satiné, du verre soufflé blanc et une douille avec une prise E27. La ligne classique et les différentes tailles font de Dama une lampe extrêmement fonctionnelle.

Colección de lámparas de sobremesa y de pie de luz difusa con estructura de níquel satinado, cristal soplado blanco y portalámparas con casquillo E27. La línea clásica y los diferentes tamaños hacen de Dama una lámpara extremadamente funcional.

Eine Kollektion von Tisch- und Stehleuchten mit satiniertem Nickelrahmen, weißem mundeblasenem Glas und einer Lampenfassung mit E27-Fassung, die diffuses Licht spendet. Die klassische Linie und die verschiedenen Größen machen Dama zu einer äußerst funktionalen Leuchte.

Dama



2110 Dama
.57 Vetro bianco - White glass
 Light source not included
 E14 LED
 4,5W 470lm (art. 0109/MINI...)
 F R 1,30 Kg

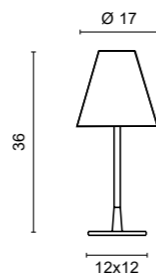

Accensione ON-OFF
 ON-OFF switch

2111 Dama
.57 Vetro bianco - White glass
 Light source not included
 E27 LED
 8W 1055lm (art. 0109/8/...)
 11W 1521lm (art. 0109/11/...)
 F R 2,90 Kg

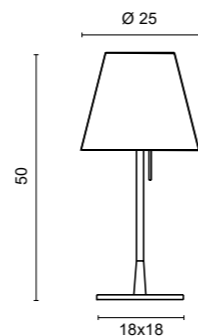

Accensione ON-OFF
 ON-OFF switch

Codici finiture - Finishes codes

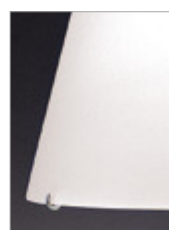

.57



3091 Dama
.57 Vetro bianco - White glass
 Light source not included
 E27 LED
 11W 1521lm (art. 0109/11/...)
 F R 7,3 Kg
 Accensione ON-OFF
 ON-OFF switch

3092 Dama
.57 Vetro bianco - White glass
 Light source not included
 E27 LED

Up light:
 11W 1521lm (art. 0109/11/...)

Down light:
 2x11W 1521lm (art. 0109/11/...)

11,70 Kg

Doppia accensione ON-OFF
 ON-OFF double switch



Codici finiture - Finishes codes



.57

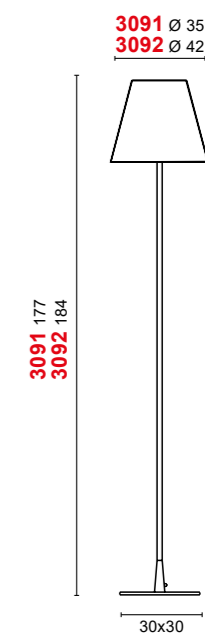



design **ABS Studio**
1995

472 473

Collezione di lampade a sospensione e da parete a luce diffusa in vetro soffiato bianco e con portalamпада con attacco E27. Il design classico e le differenti dimensioni del vetro rendono Liolà una lampada estremamente idonea a varie ambientazioni.

Collection of suspension and wall lamps with diffused light in white blown glass and with E27 lamp holder. The classic design and the different sizes of the glass make Liolà an extremely suitable lamp for various settings.

Collection de suspensions et d'appliques à lumière diffuse en verre soufflé blanc avec douille E27. Le design classique et les différentes tailles de verre font de Liolà une lampe qui s'adapte parfaitement à différents environnements.

Colección de lámparas colgantes y apliques de luz difusa en vidrio soplado blanco y con portalámparas E27. El diseño clásico y los diferentes tamaños del cristal hacen de Liolà una lámpara muy adecuada para diversos ambientes.

Kollektion von Hänge- und Wandleuchten mit diffusem Licht aus weißem geblasenem Glas und mit E27-Fassung. Das klassische Design und die verschiedenen Größen des Glases machen Liolà zu einer äußerst geeigneten Lampe für verschiedene Umgebungen.

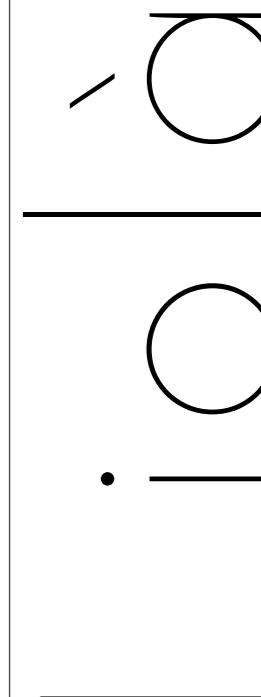

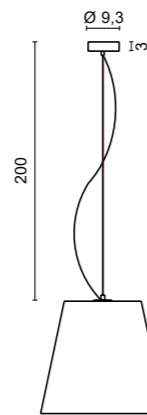

1104 Ø 17
1106 Ø 35
1107 Ø 25
1108 Ø 42

1104 15,5
1106 28
1107 20
1108 38

1104 Liola
.57 Vetro bianco - White glass
Light source not included
G9 LED
3,5W (art. 0092/...)
F R 0,70 Kg

1106 Liola
.57 Vetro bianco - White glass
Light source not included
E27 LED
11W 1521lm (art. 0109/11/...)
F R 2,50 Kg

1107 Liola
.57 Vetro bianco - White glass
Light source
E27 LED
11W 1521lm (art. 0109/11/...)
F R 1,20 Kg

1108 Liola
.57 Vetro bianco - White glass
Light source
E27 LED
11W 1521lm (art. 0109/11/...)
F R 4,20 Kg

Codici finiture - Finishes codes



.57

Accessori - Accessories



0532
Ø 1 cm
H 3,5 cm
Elemento per decentramento
Displacement component
.31 Cromato lucido - Chromed

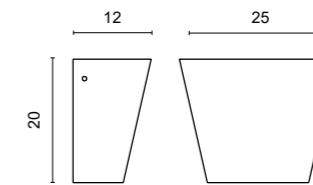

4209 Liola
.57 Vetro bianco - White glass
Light source not included
E27 LED
8W 1055lm (art. 0109/8/...)
11W 1521lm (art. 0109/11/...)
F R 0,80 Kg

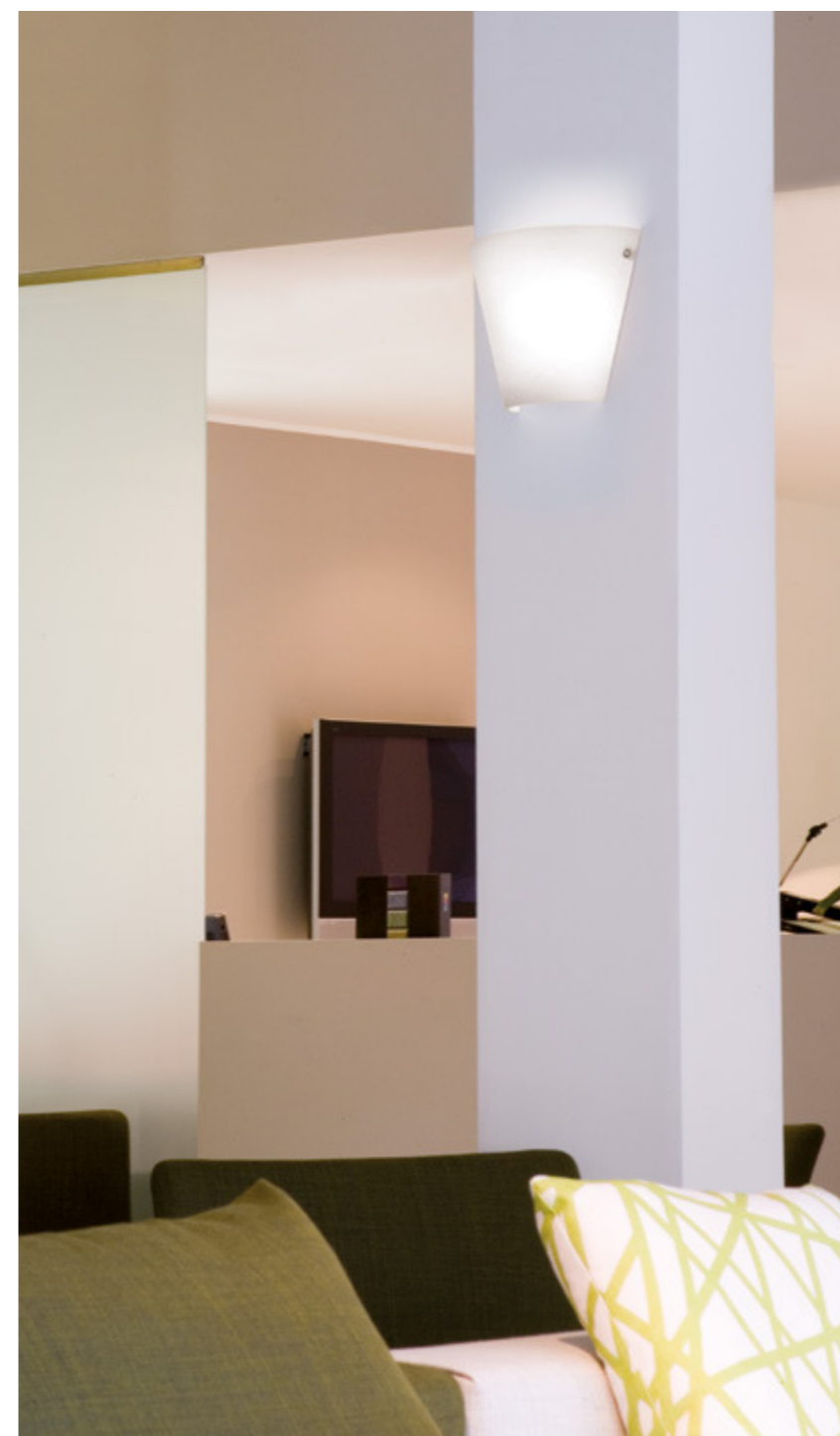

Codici finiture - Finishes codes



.57



design **ABS Studio**
2013

Lampada da parete/plafone IP40 a luce diffusa con diffusore in vetro soffiato satinato bianco e struttura in metallo verniciato bianco. Disponibile nella versione con sorgente COB LED, con alimentatore integrato e con la possibilità di dimmerazione, oppure con portalamada E27.

IP40 wall/ceiling lamp providing diffused light with white satin-finish blown glass diffuser and white painted metal structure. Available with COB LED source, with integrated driver and the possibility of dimming, or with E27 lamp holder.

Applique/plafonnier IP40 à lumière diffuse avec diffuseur en verre soufflé blanc satiné et structure métallique peinte en blanc. Disponible avec source LED COB, avec driver intégré ou gradable, ou avec douille E27.

Applique/plafón IP40 de luz difusa con difusor de cristal soplado blanco satinado y estructura metálica pintada en blanco. Disponible con fuente LED COB, con driver integrado y regulable, o con portalámparas E27.

Wand-/Deckenleuchte IP40 für diffuses Licht mit Diffusor aus geblasenem, satiniertem Glas und weiß lackierter Metallstruktur. Erhältlich mit COB LED Quelle, mit integriertem Driver und dimmbar, oder mit E27 Lampenfassung.

Musa



5234 Musa
.57 Vetro bianco - White glass

Light source not included
E27 LED

2x11W 1521lm (art. 0109/11/...)

IP40 2,80 Kg

5235 Musa
.57 Vetro bianco - White glass

Color temperature	LED Light source	lm source
/W 4000K	17,2W	2617lm
/WW 3000K	17,2W	2452lm

IP40 2,80 Kg

5241 Musa DIM
.57 Vetro bianco - White glass

Dimmerabile 1...10V - 1...10V dimming

Color temperature	LED Light source	lm source
/W/DIM 4000K	17,2W	2617lm
/WW/DIM 3000K	17,2W	2452lm

IP40 **1...10 V** 2,80 Kg

5241 Musa DIM DALI
.57 Vetro bianco - White glass

Dimmerabile DALI - DALI dimming

Color temperature	LED Light source	lm source
/W/DALI 4000K	17,2W	2617lm
/WW/DALI 3000K	17,2W	2452lm

IP40 2,80 Kg

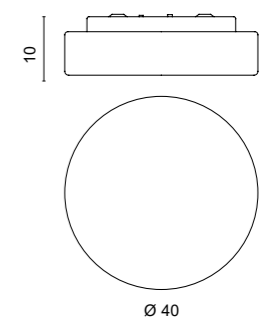

Codici finiture - Finishes codes



.57

design **ABS Studio**
2003

Lampada da parete/plafone a luce diffusa con struttura in metallo, doppio diffusore esterno in vetro Pyrex trasparente e interno satinato. Il design classico ed elegante rende Maya una lampada estremamente idonea a vari contesti.

Wall/ceiling lamp providing diffused light with metal structure, double outer diffuser in transparent Pyrex glass and satin-finished interior. The classic and elegant design makes Maya a lamp extremely suitable for various contexts.

Applique/plafonnier à lumière diffuse avec structure métallique, double diffuseur extérieur en verre pyrex transparent et intérieur satiné. Le design classique et élégant fait de Maya une lampe particulièrement adaptée à différents contextes.

Applique/plafón de luz difusa con estructura metálica, doble difusor exterior de cristal Pyrex transparente e interior satinado. El diseño clásico y elegante hace de Maya una lámpara muy adecuada para diversos contextos.

Wand-/Deckenleuchte für diffuses Licht mit Metallstruktur, doppeltem Außendiffusor aus transparentem Pyrexglas und satiniertem Innenraum. Das klassische und elegante Design macht Maya zu einer Leuchte, die sich hervorragend für verschiedene Kontexte eignet.

Maya



4552 Maya
.50 Cristallo - Crystal

Color temperature	LED Light source	lm source
3000K	8,4W	1340lm

2,90 Kg

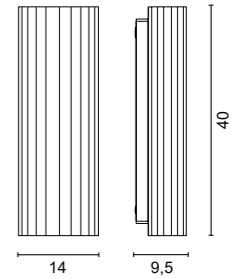

Codici finiture - Finishes codes



.50

design **ABS Studio**
1979

Storiche lampade da parete/plafone di EgoLucce con struttura in alluminio tornito e con portalam-pada con attacco E27. L'utilizzo di lampadine E27 la rende una semplice soluzione di facile installazione per risolvere velocemente e in maniera economica l'illuminazione di ambienti.

Historical wall/ceiling lamps by EgoLucce with a turned aluminium frame and E27 lamp holder. The use of E27 bulbs makes it an easy-to-install solution for quick and economical room lighting.

Appliques/plafonniers historiques EgoLucce avec un cadre en aluminium tourné et une douille E27. L'utilisation d'ampoules E27 en fait une solution facile à installer pour un éclairage rapide et économique de la pièce.

Appliques/plafones históricos de EgoLucce con marco de aluminio torneado y portálamparas E27. El uso de bombillas E27 la convierte en una solución fácil de instalar para iluminar habitaciones de forma rápida y económica.

Historische Wand-/Deckenleuchten von EgoLucce mit gedrehtem Aluminiumrahmen und E27-Lampenfassung. Die Verwendung von E27-Leuchtmitteln macht sie zu einer einfach zu installierenden Lösung für eine schnelle und wirtschaftliche Raumbeleuchtung.

Luna

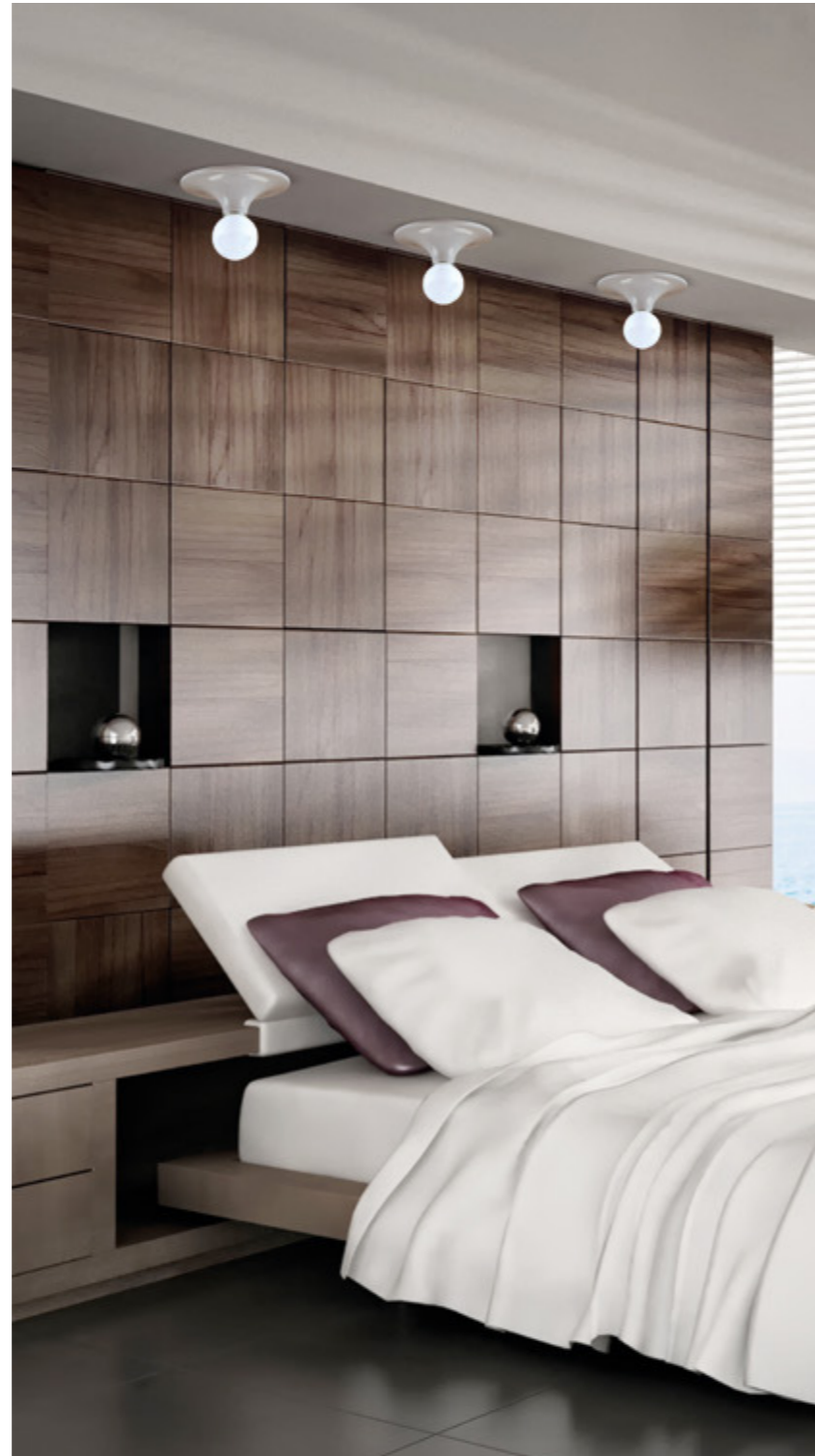

Luna

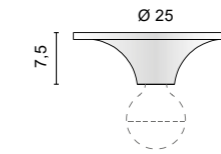

5038 Luna
.01 Bianco - White
.02 Nero - Black
.35 Verniciato sabbia - Painted sand finishing

Light source not included

E27 LED

11W 1521lm (art. 0106/ML...)



0,30 Kg

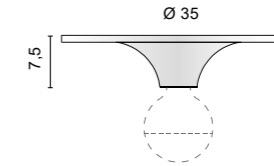

5039 Luna
.01 Bianco - White
.02 Nero - Black
.35 Verniciato sabbia - Painted sand finishing

Light source not included

E27 LED

11W 1521lm (art. 0106/ML...)



0,40 Kg

Codici finiture - Finishes codes

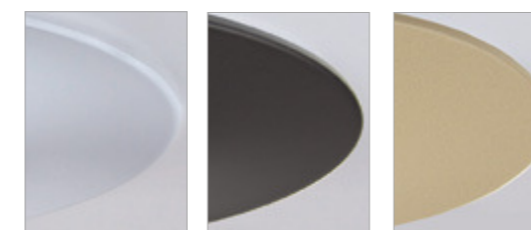

.01

.02

.35



design **ABS Studio**
1993

Lampade da parete orientabili con struttura in alluminio e ottone, alimentatore integrato e con finiture galvaniche. Ikon è stata ideata prevalentemente per l'installazione su specchi o su quadri.

Adjustable wall lights with an aluminium and brass frame, integrated driver and galvanic finish. Ikon is designed primarily for installation on mirrors or pictures.

Appliques réglables avec un cadre en aluminium et en laiton, driver intégré et une finition galvanique. Ikon est conçue principalement pour être installée sur des miroirs ou des tableaux.

Appliques orientables con marco de aluminio y latón, driver integrado y acabado galvanizado. Ikon está diseñado principalmente para su instalación sobre espejos o cuadros.

Verstellbare Wandleuchten mit einem Rahmen aus Aluminium und Messing, integriertem Driver und galvanischer Oberflächenbehandlung. Ikon ist vor allem für die Montage an Spiegeln oder Bildern gedacht.

Ikon Ikon Maxi

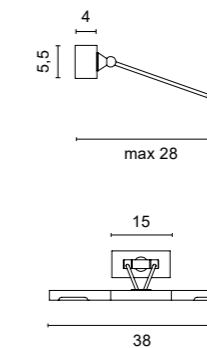

4504 Ikon
.21 Dorato lucido - *Shiny gold*
.31 Cromato lucido - *Shiny Chromed*
.32 Nickel satinato - *Nickel mat*

Color temperature	LED Light source	lm source
/WW 3000K	5W	910lm
/XW 2700K	5W	850lm

0,70 Kg

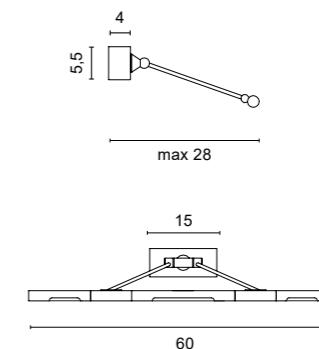

4595 Ikon Maxi
.21 Dorato lucido - *Shiny gold*
.31 Cromato lucido - *Shiny Chromed*
.32 Nickel satinato - *Nickel mat*

Color temperature	LED Light source	lm source
/WW 3000K	7,5W	1320lm
/XW 2700K	7,5W	1250lm

1,10 Kg

Codici finiture - *Finishes codes*

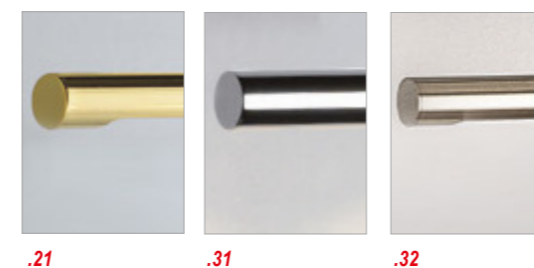



design P. Peperè
2003

Lampada IP44 da parete o plafone con struttura in alluminio, diffusore in policarbonato, terminali cromati e alimentatore integrato. Siba è stata ideata prevalentemente per l'installazione su specchi e, visto il grado di protezione, nei bagni.

IP44 wall or ceiling light with aluminium structure, polycarbonate diffuser, chrome-plated terminals and integrated driver. Siba is designed primarily for installation on mirrors and, given its degree of protection, in bathrooms.

Applique ou plafonnier IP44 avec cadre en aluminium, diffuseur en polycarbonate, embouts chromés et driver intégrée. Siba est conçu principalement pour être installé sur les miroirs et, compte tenu de son degré de protection, dans les salles de bains.

Applique o plafón IP44 con marco de aluminio, difusor de policarbonato, terminales cromados y driver integrado. Siba está diseñada principalmente para su instalación en espejos y, dado su grado de protección, en cuartos de baño.

IP44 Wand- oder Deckenleuchte mit Aluminiumrahmen, Polycarbonatdiffusor, verchromten Endkappen und integriertem Driver. Siba ist in erster Linie für die Installation auf Spiegeln und, aufgrund ihrer Schutzart, in Badezimmern vorgesehen.

Siba



4331 Siba
.31 Cromato lucido - Shiny chromed

Color temperature	LED Light source	lm source
/W 4000K	6,25W	980lm
/WW 3000K	6,25W	930lm

IP44    0,70 Kg

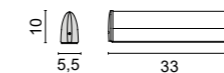

4333 Siba
.31 Cromato lucido - Shiny chromed

Color temperature	LED Light source	lm source
/W 4000K	12,5W	1930lm
/WW 3000K	12,5W	1840lm

IP44    1,10 Kg

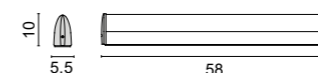

Codici finiture - Finishes codes



.31



design
officinadiarchitettura&design
2023



Famiglia di lampade da esterno IP67, orientabili, con struttura in acciaio INOX AISI 316L e diffusore in metacrilato trasparente anti UV. Gli accessori, e l'alimentatore da posizionare in remoto, sono da ordinare separatamente.

Family of IP67 adjustable outdoor lamps with AISI 316L stainless steel structure and transparent UV-resistant methacrylate diffuser. Accessories, and the driver to be remotely positioned, are to be ordered separately.

Famille de lampes d'extérieur orientables IP67 avec structure en acier inoxydable AISI 316L et diffuseur transparent en méthacrylate résistant aux UV. Les accessoires et le driver à positionner à distance doivent être commandés séparément.

Familia de lámparas de exterior regulables IP67 con estructura de acero inoxidable AISI 316L y difusor de metacrilato transparente resistente a los rayos UV. Los accesorios, así como el driver a colocar a distancia, deben pedirse por separado.

Familie von IP67 verstellbaren Außenleuchten mit Struktur aus rostfreiem Stahl AISI 316L und transparentem, UV-beständigem Methacrylat-Diffusor. Das Zubehör und das Driver für die Fernpositionierung sind separat zu bestellen.

AggOS

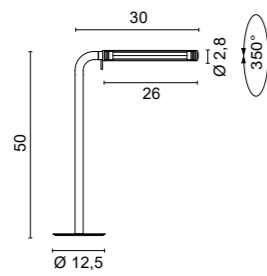

3540 Agos

.33 Acciaio satinato - *Matt steel*
Inox AISI 316L

Color temperature	LED Light source	lm source
/W 4000K	24V 3W	368lm
/WW 3000K	24V 3W	330lm
/XW 2700K	24V 3W	312lm

F III IP67 60 CM CRI >90 R 0,75 Kg

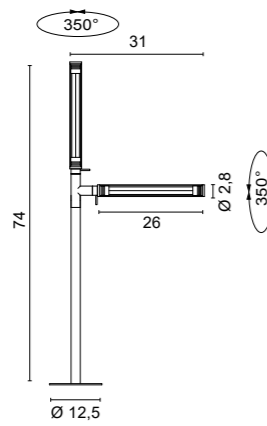

3541 Agos

.33 Acciaio satinato - *Matt steel*
Inox AISI 316L

Color temperature	LED Light source	lm source
/W 4000K	24V 6W	736lm
/WW 3000K	24V 6W	660lm
/XW 2700K	24V 6W	624lm

F III IP67 60 CM CRI >90 R 1,00 Kg

Il diffusore può ruotare di 350°
The diffuser can rotate by 350°

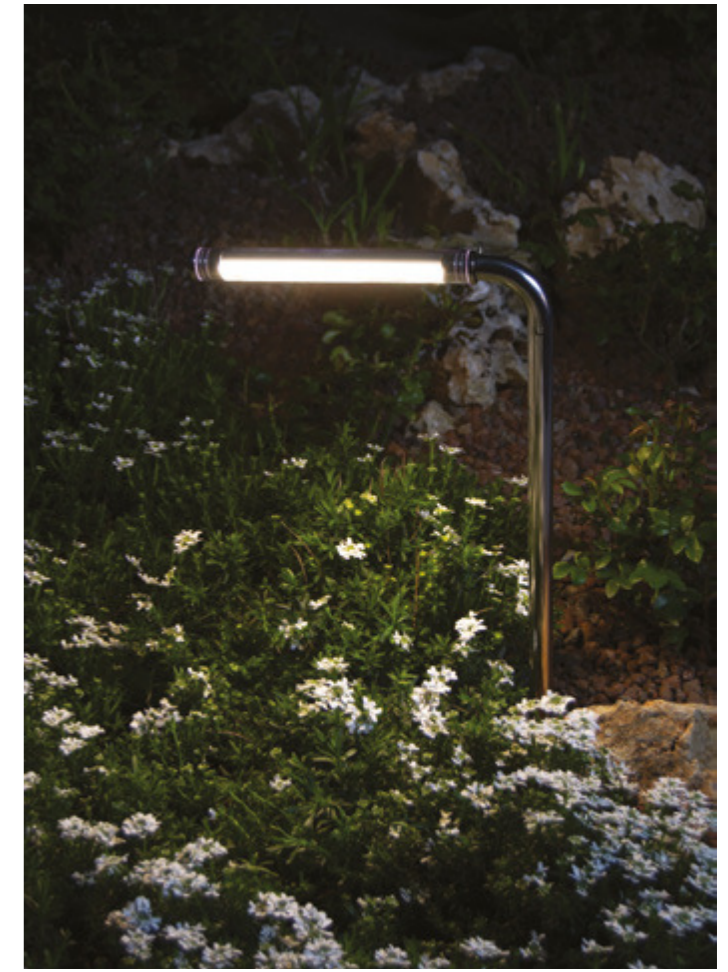

Accessori - *Accessories*



0246/R

Cassaforma drenante con piastra
Draining formwork with plate



0243

Connettore IP su cavo
IP connector on cable



0245

Picchetto per installazione temporanea a terreno
Stake for temporary installation on field

Codici finiture - *Finishes codes*



.33

Drivers

Drivers **ON/OFF**

Cod.	0155	0156	0160	0157
	24V-13W	24V-25W	24V-60W	24V-75W

IP67 drivers

Cod.	0033/IP	0034/IP
	24V-14,4W	24V-70W

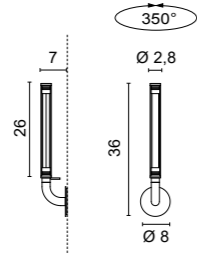

4680 Agos
.33 Acciaio satinato - *Matt steel*
Inox AISI 316L

Color temperature	LED Light source	lm source
/W 4000K	24V 3W	368lm
/WW 3000K	24V 3W	330lm
/XW 2700K	24V 3W	312lm

IP67
0,40 Kg

Il diffusore può ruotare di 350°
 The diffuser can rotate by 350°



Codici finiture - *Finishes codes*

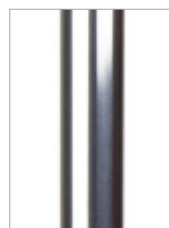

.33

Drivers

Drivers ON/OFF				
Cod.	0155	0156	0160	0157
	24V-13W	24V-25W	24V-60W	24V-75W
IP67 drivers				
Cod.	0033/IP	0034/IP		
	24V-14,4W	24V-70W		

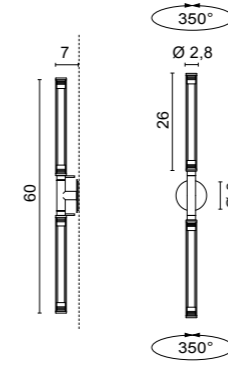

4681 Agos
.33 Acciaio satinato - *Matt steel*
Inox AISI 316L

Color temperature	LED Light source	lm source
/W 4000K	24V 6W	736lm
/WW 3000K	24V 6W	660lm
/XW 2700K	24V 6W	624lm

IP67
0,75 Kg

I due diffusori possono ruotare indipendentemente di 350°
 The two diffusers can rotate independently by 350°

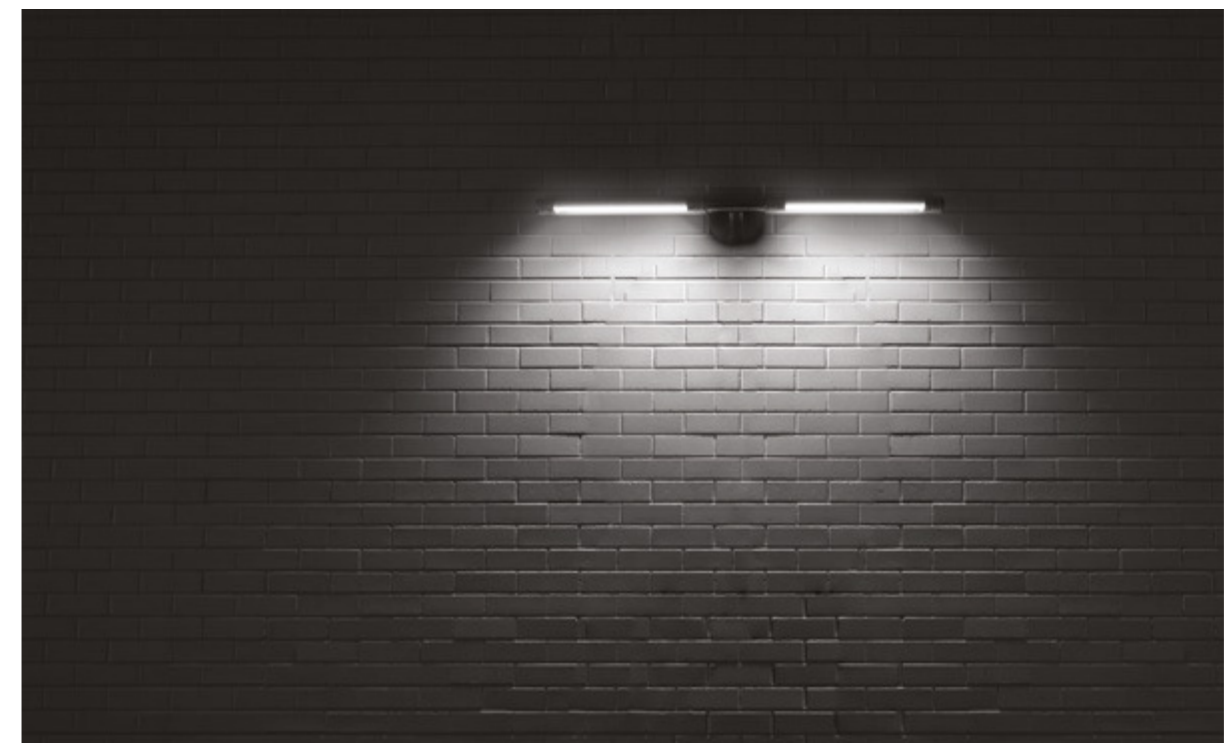
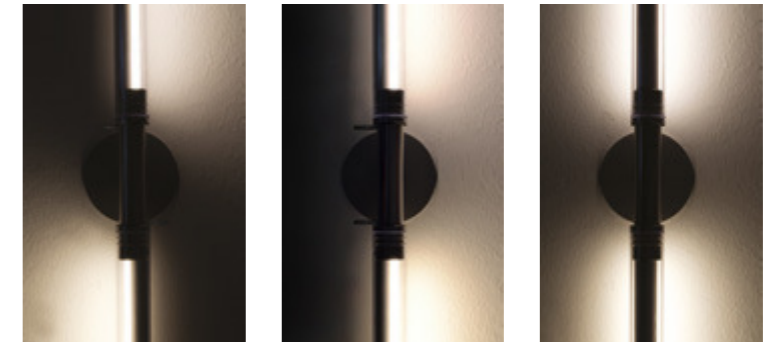

Codici finiture - *Finishes codes*



.33

Drivers

Drivers ON/OFF				
Cod.	0155	0156	0160	0157
	24V-13W	24V-25W	24V-60W	24V-75W
IP67 drivers				
Cod.	0033/IP	0034/IP		
	24V-14,4W	24V-70W		



Lampade da terra IP67 a luce diffusa, caratterizzate da un'emissione luminosa a 360 gradi, con struttura in acciaio INOX AISI 316L e diffusore in metacrilato trasparente anti UV. Gli accessori, e l'alimentatore da posizionare in remoto, sono da ordinare separatamente.

IP67 floor lamps providing diffused light, characterised by a 360° light emission, with AISI 316L stainless steel structure and transparent UV-resistant methacrylate diffuser. Accessories, and the driver to be remotely positioned, are to be ordered separately.

Lampadaires IP67 à lumière diffuse, caractérisés par une émission lumineuse de 360°, avec structure en acier inoxydable AISI 316L et diffuseur en méthacrylate transparent résistant aux UV. Les accessoires et le driver à positionner à distance sont à commander séparément.

Lámparas de pie IP67 de luz difusa, caracterizadas por una emisión luminosa de 360°, con estructura de acero inoxidable AISI 316L y difusor de metacrilato transparente resistente a los rayos UV. Los accesorios, así como el driver que se coloca a distancia, deben pedirse por separado.

Stehleuchten IP67 mit diffusen Licht, das sich durch einen Lichtaustritt von 360° auszeichnet, mit Struktur aus Edelstahl AISI 316L und transparentem, UV-beständigem Methacrylat-Diffusor. Das Zubehör und das Driver für die Fernpositionierung sind separat zu bestellen.

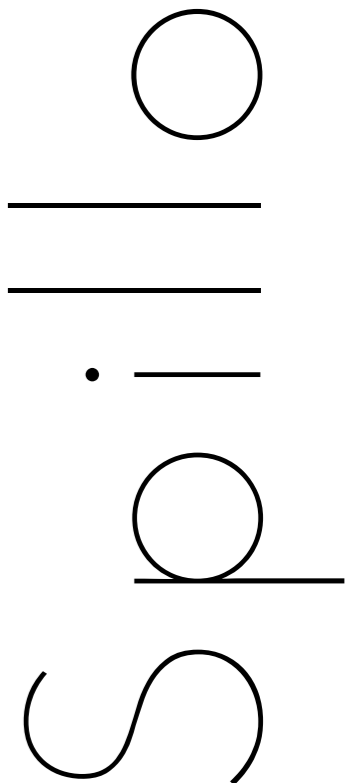

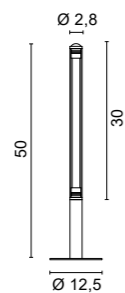

3542 Spillo

.33	Acciaio satinato - <i>Matt steel</i>
	Inox AISI 316L
.34	Verniciato corten - <i>Painted corten finishing</i>

Color temperature	LED Light source	lm source
/W 4000K	24V 6W	650lm
/WW 3000K	24V 6W	576lm
/XW 2700K	24V 6W	520lm

IP67
0,60 Kg

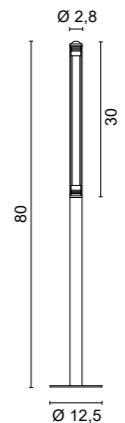

3543 Spillo

.33	Acciaio satinato - <i>Matt steel</i>
	Inox AISI 316L
.34	Verniciato corten - <i>Painted corten finishing</i>

Color temperature	LED Light source	lm source
/W 4000K	24V 6W	650lm
/WW 3000K	24V 6W	576lm
/XW 2700K	24V 6W	520lm

IP67
0,90 Kg

La luce è emessa a 360° per tutta la lunghezza del diffusore.
 The light is emitted at 360° along the entire length of the diffuser.

Codici finiture - *Finishes codes*

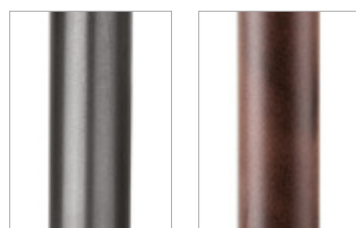

.33

.34

Drivers

Drivers ON/OFF			
Cod.	0155	0156	0160
	24V-13W	24V-25W	24V-60W
	0157		
	24V-75W		

IP67 drivers	
Cod.	0033/IP
	24V-14,4W
	0034/IP
	24V-70W



Accessori - *Accessories*



0246/R
 Cassaforma drenante con piastra
Draining formwork with plate



0243
 Connettore IP su cavo
IP connector on cable



0245
 Picchetto per installazione temporanea a terreno
Stake for temporary installation on field



0252/S.33
 Copribase
Basecover





design **Serge Cornelissen**
2022

496

Lampada da tavolo IP65 ricaricabile e dimmerabile a luce diffusa con struttura in metallo, diffusore in PVC e cavo USB-C per la ricarica incluso.

La durata della batteria è di 8 ore al 100% di luminosità e dimmerazione continua ed il tempo di ricarica è di 7 ore.

IP65 rechargeable and dimmable table lamp with metal frame, PVC diffuser and USB-C cable for charging included.

The battery life is 8 hours at 100% brightness and continuous dimming and the recharge time is 7 hours.

Lampe de table IP65 rechargeable et dimmable avec cadre en métal, diffuseur en PVC et câble USB-C pour la recharge inclus.

L'autonomie de la batterie est de 8 heures à 100 % de luminosité et à gradation continue et le temps de recharge est de 7 heures.

Lámpara de mesa IP65 recargable y regulable con estructura metálica, difusor de PVC y cable USB-C para carga incluidos.

La duración de la batería es de 8 horas al 100% de brillo y regulación continua y el tiempo de recarga es de 7 horas.

Wiederaufladbare und dimmbare IP65-Tischleuchte mit Metallrahmen, PVC-Diffusor und USB-C-Kabel zum Aufladen im Lieferumfang enthalten.

Die Akkulaufzeit beträgt 8 Stunden bei 100 % Helligkeit und stufenlosem Dimmen, die Aufladezeit 7 Stunden.

Larod

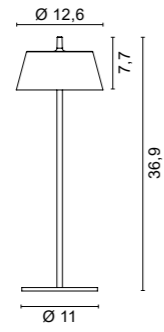

2550 Lara

- .02** Nero - Black
- .06** Verde - Green
- .34** Corten - Rust Brown
- .39** Antracite - Anthracite

Color temperature	LED Light source	lm source
2700K - 3000K	2,2W	117lm

0,65 Kg

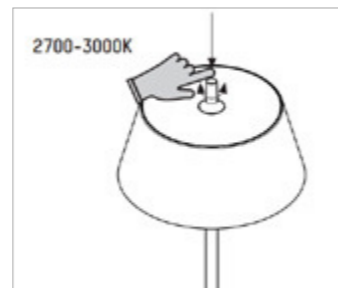

Codici finiture - Finishes codes

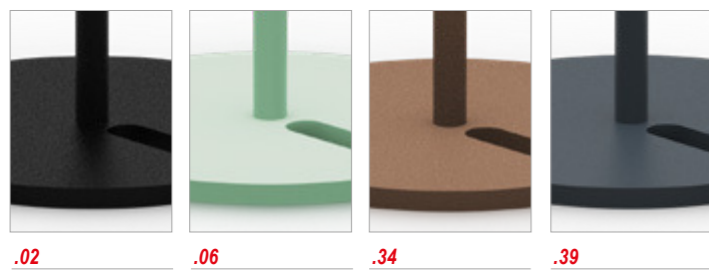

design **U.T. EgoLuce**
2014

Lampada da parete o plafone IP65 con struttura in alluminio con trattamento di anodizzazione rinforzata per esterno, diffusore in metacrilato, modulo LED da 10W e alimentatore integrato.

IP65 wall or ceiling light with aluminium frame with reinforced anodising treatment for outdoor use, methacrylate diffuser, 10W LED module and integrated driver.

Applique ou plafonnier IP65 avec cadre en aluminium à anodisation renforcée pour usage extérieur, diffuseur en méthacrylate, module LED 10W et driver intégré.

Aplique o plafón IP65 con marco de aluminio con tratamiento de anodizado reforzado para exteriores, difusor de metacrilato, módulo LED de 10W y driver integrado.

IP65 Wand- oder Deckenleuchte mit Aluminiumrahmen mit verstärkter Eloxalbehandlung für den Außeneinsatz, Diffusor aus Methacrylat, LED-Modul 10 W und integriertem Netzteil.

Drum



Drum

5520 Drum		
.01	Bianco - White	
.45	Alluminio anodizzato - Anodized aluminium	
Color temperature	LED Light source	lm source
/WW 3000K	10W	850lm
F IP65		1,30 Kg



Codici finiture - Finishes codes

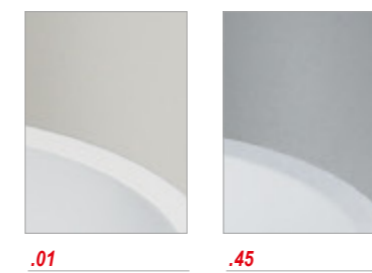

design **Feb. Rienzi**
2015

Lampada da parete o plafone IP65 con struttura in alluminio con trattamento di anodizzazione rinforzata per esterno, diffusore in vetro pressato extra chiaro, schermo in metacrilato satinato, viti in acciaio INOX, modulo LED di ultima generazione e alimentatore integrato.

IP65 wall or ceiling light with aluminium frame with reinforced anodising treatment for outdoor use, extra-clear pressed glass diffuser, satin methacrylate screen, stainless steel screws, latest generation LED module and integrated driver.

Applique ou plafonnier IP65 avec cadre en aluminium à anodisation renforcée pour usage extérieur, diffuseur en verre pressé extra-clair, écran en méthacrylate satiné, visserie en acier inoxydable, module LED de dernière génération et driver intégré.

Aplique o plafón IP65 con marco de aluminio con tratamiento de anodizado reforzado para exteriores, difusor de cristal prensado extraclaro, pantalla de metacrilato satinado, tornillería de acero inoxidable, módulo LED de última generación y driver integrado.

IP65 Wand- oder Deckenleuchte mit Aluminiumrahmen mit verstärkter Eloxalbehandlung für den Außeneinsatz, extra klarem Pressglasdiffusor, satiniertem Methacrylatschirm, Schrauben aus rostfreiem Stahl, LED-Modul der neuesten Generation und integriertem Netzteil.

Roc

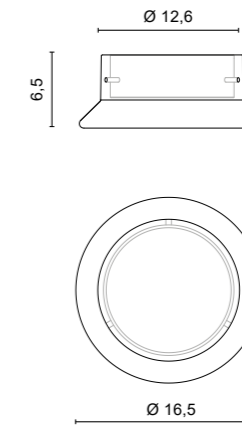

5539 Roc		
.01 Bianco - White		
Color temperature	LED Light source	lm source
3000K	8,7W	670lm
IP65		
		1,50 Kg



Codici finiture - Finishes codes



.01

design **Feb. Rienzi**
2016

Lampada da plafone IP65 con struttura e riflettore in alluminio con trattamento di anodizzazione rinforzata per esterno, diffusore in metacrilato satinato, modulo LED di ultima generazione e alimentatore integrato.

IP65 ceiling light with aluminium frame and reflector with reinforced anodising treatment for outdoor use, satin methacrylate diffuser, latest generation LED module and integrated driver.

Lampe en saillie IP65 avec cadre et réflecteur en aluminium avec traitement d'anodisation renforcé pour usage extérieur, diffuseur en méthacrylate satiné, module LED de dernière génération et driver intégré.

Plafón IP65 con marco y reflector de aluminio con tratamiento de anodizado reforzado para exteriores, difusor de metacrilato satinado, módulo LED de última generación y driver integrado.

IP65-Deckenleuchte mit Aluminiumrahmen und -reflektor mit verstärkter Eloxalbehandlung für den Außeneinsatz, Diffusor aus satiniertem Methacrylat, LED-Modul der neuesten Generation und integriertem Driver.

Jazz

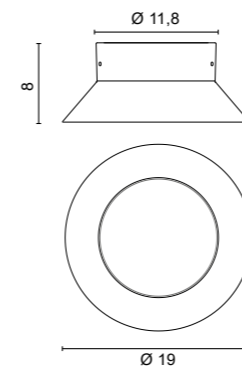

5538 Jazz

- .01** Bianco - White
- .02** Nero - Black
- .38** Ramato lucido - Shiny copper

Color temperature	LED Light source	lm source
WW 3000K	8,7W	670lm

F IP65    0,60 Kg

Codici finiture - Finishes codes





50/60Hz 220-240V

Code	Color temperature	LED Light source
0092	/WW 3000K	3,2W G9 COB 380lm
0092	/XW 2700K	3,2W G9 COB 380lm

Dimmerabile - Dimmable



50/60Hz 220-240V

Code	Color temperature	LED Light source
0093	/WW 3000K	3W GU10 200lm



50/60Hz 220-240V

Code	Color temperature	LED Light source
0094	/W 4000K	7W GU10 630lm
0094	/WW 3000K	7W GU10 600lm
0094	/XW 2700K	7W GU10 580lm



50/60Hz 220-240V

Code	Color temperature	LED Light source
0103	/W 4000K	8W GX53 700lm
0103	/WW 3000K	8W GX53 680lm
0103	/XW 2700K	8W GX53 650lm

Dimmerabile - Dimmable



50/60Hz 220-240V

Code	Color temperature	LED Light source
0104	/W 4000K	7W GU10 550lm
0104	/WW 3000K	7W GU10 530lm
0104	/XW 2700K	7W GU10 510lm

Dimmerabile - Dimmable



50/60Hz 220-240V

Code	Color temperature	LED Light source	
0106/ML	/W 4000K	11W E27 1521lm	**
0106/ML	/WW 3000K	11W E27 1521lm	*
0106/ML	/XW 2700K	11W E27 1521lm	**

* Dimmerabile - Dimmable
** Non dimmerabile - Not dimmable



50/60Hz 220-240V

Code	Color temperature	LED Light source
0109/8	/W 4000K	8W E27 1055lm
0109/8	/WW 3000K	8W E27 1055lm
0109/8	/XW 2700K	8W E27 1055lm

Dimmerabile - Dimmable



50/60Hz 220-240V

Code	Color temperature	LED Light source	
0109/11	/W 4000K	11W E27 1521lm	**
0109/11	/WW 3000K	11W E27 1521lm	*
0109/11	/XW 2700K	11W E27 1521lm	**

* Dimmerabile - Dimmable
** Non dimmerabile - Not dimmable



50/60Hz 220-240V

Code	Color temperature	LED Light source	
0109/MINI	/W 4000K	4,5W E14 470lm	**
0109/MINI	/WW 3000K	4,5W E14 470lm	*
0109/MINI	/XW 2700K	4,5W E14 470lm	**

* Dimmerabile - Dimmable
** Non dimmerabile - Not dimmable

PORCELLANA

Lampadine LED con un particolare effetto simil porcellana realizzato con una speciale satinatura del vetro sia interna che esterna
LED bulbs with a particular porcelain effect made with a special satin finish on the glass both inside and outside



50/60Hz 220-240V

Porcellana- Porcelain

Code	Color temperature	LED Light source
01LP1	2700K	6W E27 560lm

Dimmerabile - Dimmable



50/60Hz 220-240V

Porcellana- Porcelain

Code	Color temperature	LED Light source
01LP4	2700K	6W E27 580lm

Dimmerabile - Dimmable



50/60Hz 220-240V

Porcellana- Porcelain

Code	Color temperature	LED Light source
01LP6	2700K	6W E27 580lm

Dimmerabile - Dimmable



50/60Hz 220-240V

Porcellana- Porcelain

Code	Color temperature	LED Light source
01LP8	2700K	6W E27 600lm

Dimmerabile - Dimmable



50/60Hz 220-240V

Porcellana- Porcelain

Code	Color temperature	LED Light source
01LP2	2700K	6W E27 600lm

Dimmerabile - Dimmable



50/60Hz 220-240V

Porcellana- Porcelain

Code	Color temperature	LED Light source
01LP5	2700K	6W E27 520lm

Dimmerabile - Dimmable



50/60Hz 220-240V

Porcellana- Porcelain

Code	Color temperature	LED Light source
01LP7	2700K	6W E27 560lm

Dimmerabile - Dimmable

CRISTALLO

Lampadina LED di grande effetto visivo
LED bulbs with great visual effect



50/60Hz 220-240V

Porcellana- Porcelain

Code	Color temperature	LED Light source
01LCR1	2700K	6W E27 600lm

Dimmerabile - Dimmable



50/60Hz 220-240V

Porcellana- Porcelain

Code	Color temperature	LED Light source
01LCR2	2700K	6W E27 600lm

Dimmerabile - Dimmable



50/60Hz 220-240V

Porcellana- Porcelain

Code	Color temperature	LED Light source
01LCR3	2700K	6W E27 600lm

Dimmerabile - Dimmable



50/60Hz 220-240V

Porcellana- Porcelain

Code	Color temperature	LED Light source
01LCR4	2700K	6W E27 600lm

Dimmerabile - Dimmable

CUPOLA

Lampade LED con innovativi COB a spirale
LED lamps with innovative spiral COB



50/60Hz 220-240V

Argento- Silver

Code	Color temperature	LED Light source
01LC1	2700K	7W E27 806lm

Dimmerabile - Dimmable

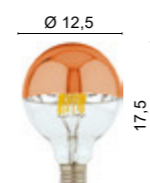

50/60Hz 220-240V

Rame- Copper

Code	Color temperature	LED Light source
01LC2	2700K	7W E27 806lm

Dimmerabile - Dimmable

CODICE	PRODOTTO	Pag
1104	Liola	472
1106	Liola	472
1107	Liola	472
1108	Liola	472
1147	Alea	452
1171	Lancia Tonda Cavo Ø 35 cm	244
1172	Lancia Tonda Cavo Ø 50 cm	244
1173	Lancia Tonda Cavo Ø 70 cm	244
1504	Pool	400
1507	Mork	404
1516	Prêt-à-Porter	338
1517	Matassa	412
1518	Matassa	412
1519	Matassa	412
1535	Spirits	142
1539	Lancia System	198
1541	Rail	346
1542	Rail	346
1545	Rail Biemission	348
1546	Rail Biemission UGR	351
1547	Rail UGR	350
1549	Baloon	302
1554	Bureau	170
1558	Pavillon	185
1559	Extra System	102
1561	Rail Quadra	358
1562	Lancia Tonda	236
1563	Lancia Tonda	238
1564	Lancia Tonda	238
1566	Lancia Tonda	236
1567	Lancia di Achille	233
1568	Pevera System	386
1569	Pevera System	386
1570	Radar	266
1571	Radar	266
1572	Radar	266
1575	Lancia Tonda XL	243
1576	Lancia Tonda XXL	243
1577	Lancia	218
1580	Stick System	392
1581	Stick System	392
1582	Stick System	392
1584	Virgola	68
1585	Virgola	68
1586	Selene	44
1587	Selene	44
1591	Newton System	368
1592	Newton System	368
1598	Edison System	310
1599	Giove	178
1600	Unidea	316
1601	Unidea	316
1602	Unidea	316
1603	Unidea	317
1604	Unidea	317
1608	Frame	64
1609	Frame	64
1660	Egotube System	328
1661	Egotube System	328
1662	Tre&Sessanta	50
1663	Tre&Sessanta	50
1665	Wanda System	74
1666	Tre&Sessanta	52
1667	Tre&Sessanta	52
1668	Bagliori	272
1669	Bagliori	272
1670	Multi Lancia System	202
1671	Multi Lancia System	202
1672	Lancia no Limits Cavo	212
1673	Lancia no limits	208
1674	Matita	80
1675	Matita	80

CODICE	PRODOTTO	Pag
1678	Iris	120
1679	Iris	121
1680	Tulipano	188
1681	Tulipano	188
1682	Tulipano	188
1683	Tulipano	188
1684	Riga	96
2110	Dama	468
2111	Dama	468
2117	Alba	420
2127	Matassa	414
2128	Matassa	414
2129	Matassa	414
2502	Kalla	428
2506	Lancia	223
2512	Unidea	320
2513	Lancia Tonda	252
2514	Lancia Tonda	252
2515	Olim	324
2520	Matita	82
2522	Zeta	440
2525	Faro	114
2539	Leggo	132
2550	Lara	496
3091	Dama	469
3092	Dama	469
3098	Alba	420
3508	Bureau	172
3509	Bureau DIM	172
3510	Newton	374
3511	Unidea	321
3512	Unidea	321
3513	Lancia Tonda	254
3514	Lancia Tonda	254
3515	Lancia Tonda	254
3517	Baloon	304
3520	Silhouette	166
3521	Silhouette DIM	166
3522	Lancia	220
3523	Lancia	220
3524	Bi Lancia	222
3525	Bi Lancia	222
3530	Matita	84
3531	Matita	84
3532	Matita	84
3533	Iris	122
3535	Virgola	70
3536	Faro	116
3540	Agos	486
3541	Agos	486
3542	Spillo	492
3543	Spillo	492
3546	Tre&Sessanta	54
3547	Trilli	20
3548	Trilli	20
3549	Trilli	20
3555	Raccordi di luce - Joy	286
3556	Raccordi di luce - Joy	288
3557	Raccordi di luce - Joy	288
4021	Fusò	465
4023	Fusò	465
4209	Liola	473
4281	Alea	459
4282	Alea	453
4331	Siba	483
4333	Siba	483
4340	Fusion	30
4392	Alba	422
4393	Alba	422
4501	Kalla	429
4504	Ikon	481
4521	Extra	106

CODICE	PRODOTTO	Pag
4524	Baloon	306
4533	Matassa	416
4534	Matassa	416
4536	Wanda	76
4537	Wanda	76
4538	Wanda RGB	76
4539	Wanda RGB	76
4540	Kalla Due	431
4541	Kalla Due	430
4552	Maya	477
4561	Alea LED	454
4562	Newton	376
4564	Mats	444
4565	Mats	444
4566	Lancia Mini	228
4567	Lancia	224
4568	Lancia	224
4569	Lancia	226
4570	Lancia	230
4574	Ci	448
4575	Ci	448
4576	Ci	448
4577	Ci	448
4578	Rail	352
4579	Rail	352
4582	Moonlight	152
4583	Moonlight	152
4584	Flower	148
4585	Flower	148
4587	Bureau	174
4588	Bureau DIM 1...10V	174
4588	Bureau DIM DALI	174
4589	Vela	364
4590	Q-Light	160
4591	Q-Light	160
4592	Eclipse Tonda	292
4593	Eclipse Quadra	295
4594	Demi	425
4595	Ikon Maxi	481
4596	Ellein	297
4599	Elleout	299
4601	Extra	104
4602	Extra	104
4603	Extra	104
4604	Extra	104
4605	Lancia Tonda	256
4606	Lancia Tonda	256
4607	Lancia Tonda	256
4608	Olim	325
4609	Olim	325
4610	Newton Slim	380
4611	Newton Flat	378
4612	Newton	376
4613	Newton Slim	380
4614	Newton Flat	378
4618	Newton Easy	382
4619	Newton Easy	382
4620	Moonlight	153
4621	Bamboo	436
4622	Bamboo	434
4625	Eclipse IP	294
4627	Aurora	136
4628	Aurora	136
4629	Aurora	136
4631	Matita	89
4632	Matita	89
4633	Matita	86
4634	Matita	88
4636	Diesis	34
4644	Bagliori	278
4645	Bagliori	276
4646	Bagliori	278

CODICE	PRODOTTO	Pag
4647	Bagliori	276
4648	Bagliori	274
4650	Iris	124
4651	Iris	124
4652	Iris	124
4670	Leggo	130
4672	Raccordi di luce - Joy	282
4673	Raccordi di luce - Joy	282
4680	Agos	488
4681	Agos	489
5038	Luna	479
5039	Luna	479
5159	Flip Maxi	463
5161	Flip Maxi DIM	463
5161	Flip Maxi DALI	463
5176	Alea	458
5229	Matassa	416
5233	Prêt-à-Porter	339
5234	Musa	475
5235	Musa	475
5241	Musa DIM	475
5241	Musa DIM DALI	475
5520	Drum	499
5529	Flip	462
5538	Jazz	503
5539	Roc	501
5540	Rail	354
5541	Rail	354
5544	Selene	46
5545	Selene	46
5546	Selene	46
5561	Alea LED	456
5562	Rail Quadra	360
5565	Anaconda	58
5567	Lancia	231
5568	Lancia	231
5590	Fusion	28
5602	Lancia Tonda	260
5603	Lancia Tonda	260
5604	Lancia Tonda	260
5605	Lancia Tonda	262
5607	Radar	268
5608	Radar	268
5612	Edison System	310
5613	Riga	98
5650	Giove	180
5651	Marte	183
5652	Marte	183
5660	Egotube	330
5661	Egotube	330
5662	Cut	335
5664	Egokube	333
5665	Egokube	333
5671	Matita	90
5672	Matita	90
5675	Aurora	138
5676	Aurora	138
5677	Aurora	138
5680	Iris	126
5681	Iris	126
5690	Racordi di luce - Joy	282
5691	Diesis	36
5694	Retta	40
5695	Retta	40
5696	Retta	40
6701	Matita	92
6702	Matita	92
6703	Matita	92
A1171	Lancia Tonda Cavo System	244
A1172	Lancia Tonda Cavo System	244
A1173	Lancia Tonda Cavo System	244
A1565	Lancia Cavo System	210

FAMIGLIA	Pag
AGOS	485
ALBA	419
ALEA	451
ANACONDA	57
AURORA	135
BAGLIORI	271
BALLOON	301
BAMBOO	433
BUREAU	169
CI	447
CUT	334
DAMA	467
DEMI	424
DIESIS	33
DRUM	498
ECLIPSE	291
EDISON SYSTEM	309
EGOKUBE	332
EGOTUBE	327

FAMIGLIA	Pag
ELLEIN	296
ELLEOUT	298
EXTRA	101
FARO	113
FLIP - FLIP MAXI	461
FLOWER	147
FRAME	63
FUSION	27
FUSO	464
GIOVE	177
IKON - IKON MAXI	480
IRIS	119
JAZZ	502
KALLA	427
LANCIA	197
LANCIA DI ACHILLE	232
LANCIA TONDA	235
LARA	495
LEGGO	129

FAMIGLIA	Pag
LIOLA'	471
LUNA	478
MARTE	182
MATASSA	411
MATTITA	79
MATS	443
MAYA	476
MOONLIGHT	151
MORK	403
MUSA	474
NEWTON	367
OLIM	323
PAVILLON	184
PEVERA SYSTEM	385
POOL	399
PRÊT-À-PORTER	337
Q-LIGHT	159
RACCORDI DI LUCE - JOY	281
RADAR	265

FAMIGLIA	Pag
RAIL	345
RAIL QUADRA	357
RETTA	39
RIGA	95
ROC	500
SELENE	43
SIBA	482
SILHOUETTE	165
SPILLO	491
SPIRITS	141
STICK SYSTEM	391
TRE&SESSANTA	49
TRILLI	19
TULIPANO	187
UNIDEA	315
VELA	363
VIRGOLA	67
WANDA	73
ZETA	439



I nostri prodotti sono costruiti in conformità alle norme europee CEI-EN 60598 e, come tali, recano la marcatura CE.

Our fittings are manufactured in conformity with the european standard CEI-EN 60598 and, consequently, get the mark CE.

Nos appareils sont fabriqués en conformité aux règles européennes CEI-EN 60598 et, par conséquence, fournis avec marque CE.

Unsere Produkte werden gemäss europäischer Norm CEI-EN 60598 hergestellt und sind als solche mit dem CE-Zeichen gekennzeichnet.

Nuestros productos son fabricados de conformidad con las normas europeas UNE EN 60598 y, como tal, lleva la marca CE.

Наши изделия изготовлены в соответствии с европейскими нормами CEI-EN 60598 и поэтому отмечены знаком CE.

Egoluce s.r.l. si riserva la facoltà di modificare, in qualsiasi momento e senza preavviso, le caratteristiche tecniche dei modelli illustrati nel presente catalogo.
I colori si intendono indicativi.

Egoluce s.r.l. reserves the right to change, at any time and without prior warning, the technical specification of any product illustrated in this catalogue.
Colours are simply indicative of the real nuance.

Egoluce s.r.l. se réserve le droit de modifier, à n'importe quel moment et sans préavis, les caractéristiques techniques des éléments illustrés dans ce catalogue.
Les couleurs sont simplement a titre indicatif.

Egoluce s.r.l. behält sich vor, jederzeit und fristlos die in beiliegendem Katalog erläuterten technischen Daten zu ändern.
Die Farben sind nicht genau wirklichkeitsgetreu.

Egoluce s.r.l. Nos reservamos el derecho de cambiar, en cualquier momento y sin previo aviso de las especificaciones de los productos mostrados en este catálogo.
Los colores son aproximados.

Фабрика Egoluce s.r.l. сохраняет за собой право в любое время и без предварительного уведомления менять технические спецификации любого изделия в этом каталоге.



Egoluce s.r.l. si riserva la facoltà di modificare, in qualsiasi momento e senza preavviso, le caratteristiche tecniche dei modelli illustrati nel presente catalogo.
I colori si intendono indicativi.

Egoluce s.r.l. reserves the right to change, at any time and without prior warning, the technical specification of any product illustrated in this catalogue.
Colours are simply indicative of the real nuance.

Codici finiture - Finishes codes

-  **00**
Trasparente
Clear
Transparent
Klar
Transparente
-  **01**
Bianco
White
Blanc
Weiss
Blanco
-  **02**
Nero
Black
Noir
Schwarz
Negro
-  **05**
Rosso
Red
Rouge
Rot
Rojo
-  **06**
Verde
Green
Vert
Grün
Verde
-  **08**
Giallo
Yellow
Jaune
Gelb
Amarillo
-  **09**
Arancione
Orange
Orange
Orange
Naranja
-  **10**
Azzurro
Light blue
Bleu ciel
Hellblau
Azul claro
-  **11**
Rosa
Pink
Rose
Rose
Rosa
-  **14**
Lavagna
Blackboard
Tableau noir
Tafel
Pizarra
-  **23**
Alluminio satinato
Satin aluminum
Aluminium satiné
Aluminium matt
Aluminio satinado
-  **24**
Cromo nero
Black chrome
Chrome noir
Schwarzchrom
Cromo negro
-  **25**
Dorato satinato
Satin gold
Doré satiné
Vergoldet matt
Dourado sate
-  **28**
Foglia rame
Copper leaf
Feuille d'or
Blatt Kupfer
Hoja de cobre
-  **29**
Foglia oro
Gold leaf
Feuille d'or
Blatt Gold
Hoja de oro
-  **30**
Foglia argento
Silver leaf
Feuille d'argent
Blatt Silber
Hoja de plata

-  **31**
Cromato
Chromed
Chromé
Verchromt
Cromado
-  **32**
Nickel satinato
Nickel mat
Nickel satiné
Nickelmatt
Niquel mate
-  **33**
Acciaio satinato
Matt-steel
Acier satiné
Edelstahl matt
Acero mate
-  **34**
Verniciato corten
Painted corten finishing
Finition corten
Corten lackiert
Barnizado acabado corten
-  **35**
Verniciato sabbia
Painted sand finishing
Finition sable
Sand lackiert
Barnizado arena
-  **21**
Dorato lucido
Shiny gold
Doré brillant
Glänzendes Gold
Daurado brillante
-  **38**
Ramato lucido
Shiny copper
Cuivre brillant
Glänzendes Kupfer
Cobre brillante
-  **39**
Verniciato antracite
Painted anthracite finishing
Finition anthracite
Anthrazit lackiert
Barnizado acabado antracita
-  **45**
Alluminio anodizzato
Anodized aluminum
Aluminium anodisé
Aluminium eloxiert
Aluminio anodizado
-  **50**
Cristallo
Crystal
Cristal
Kristall
Cristal
-  **56**
Specchio
Mirror
Miroir
Spiegel
Espejo
-  **57**
Vetro bianco
White glass
Verre blanc
Weisses Glas
Vidrio blanco
-  **85**
Verniciato argento
Painted silver finishing
Finition d'argent
Silber lackiert
Barnizado plateada
-  **86**
Verniciato oro
Painted gold finishing
Finition d'or
Gold lackiert
Barnizado dorada
-  **87**
Verniciato rame
Painted copper finishing
Finition en cuivre
Kupfer lackiert
Barnizado de cobre
-  **88**
Verniciato bronzo
Painted bronze finishing
Finition en bronze
Bronze lackiert
Barnizado de bronce



Finiture disponibili
Available finishes

Gradi di protezione - IP

1a cifra protezione alla penetrazione di corpi solidi

1st digit: protection against penetration by solid bodies

0
Non protetto
No protection

1
Protetto da corpi solidi superiori a 50mm
Protected against solid matters (over 50mm)

2
Protetto da corpi solidi superiori a 12mm
Protected against solid matters (over 12mm)

3
Protetto da corpi solidi superiori a 2,5mm
Protected against solid matters (over 2,5mm)

4
Protetto da corpi solidi superiori a 1mm
Protected against solid matters (over 1mm)

5  **Protetto contro la polvere**
Dust proof

6  **Totamente protetto contro la polvere**
Fully dust proof

2a cifra protezione contro la penetrazione d'acqua

2nd digit: protection against penetration by water

0
Non protetto
No protection

1  **Protetto contro la caduta verticale di gocce d'acqua**
Protected against drops of water falling vertically

3  **Protetto contro la pioggia**
Rain proof fixture

4  **Protetto contro gli spruzzi**
Splash proof fixture

5  **Protetto contro getti d'acqua**
Water jet proof

6  **Protetto contro le ondate**
Wave proof

7  **Protetto contro immersione**
Watertight immersion fixture



Foro incasso
Cut out

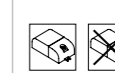

Alimentatore incluso – Alimentatore non incluso
Converter included – Converter not included



Lunghezza cavo
Cable length



Dimmer incluso
Dimmer included



CRI > 90 Indice di resa cromatica
CRI > 90 Color rendering index



Apparecchio riparabile
Fixture repairable



Fascio di apertura
Beam angles



Batteria ricaricabile
Rechargeable battery



Tunable white

Dimmerazioni - Dimming



TRIAC

Codici colore luce - Light color codes







- /XW** Extra White LED 2700K
- /WW** Warm White LED 3000K
- /W** Natural White LED 4000K
- /CW** Cold White LED 5000K
- /RGB** RGB LED 

I valori di lumen (lm) riportati nel catalogo si riferiscono al flusso luminoso nominale della sorgente LED (lm source), e al flusso della lampada (lm output).
The lumen (lm) values shown in the catalog refer to the flux luminous flux of the LED source (lm source), and the lamp flux (lm output).



Codici versioni - Option codes

- /ST** Con diffusore satinato
Satin diffuser
- /TR** Con diffusore trasparente
Transparent diffuser

Tipologie - Typology

-  Sospensioni - Suspension
-  Plafone - Ceiling
-  Terra - Floor
-  Incasso - Recessed
-  Tavolo - Table
-  Illuminazione su cavo - Cable lighting
-  Parete - Wall

Marchi - Mark

-  Apparecchio in Classe II, munito di isolamento doppio o rinforzato
Fixture on Class II, with double or reinforced insulation
-  Apparecchio a bassissima tensione con trasformatore remoto
SELV fixture with remote transformer
-  Apparecchio adatto ad essere installato su superfici normalmente infiammabili
Fixture ready for installation on normally inflammable surfaces
- IK10**
Resistenza all'urto di 20 joule o alla caduta di un elemento impattante di 5.0 kg da un'altezza di 0,4 m.
Impact resistance of 20 joules or the fall of a 5.0 kg impact element from a height of 0.4 m.

EDITION

July 2024 © All rights reserved

ART DIRECTION, LAYOUT, GRAPHICS

U.T. EgoLuce

PHOTOS

Bordegoni s.r.l.

PRINTING

Rotolito - Italy

WWW.EGOLUCE.COM

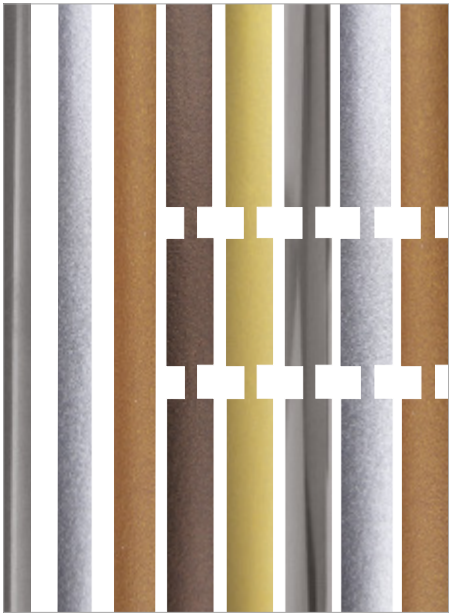

MADE IN ITALY