

NIGHT

OLIVIERI

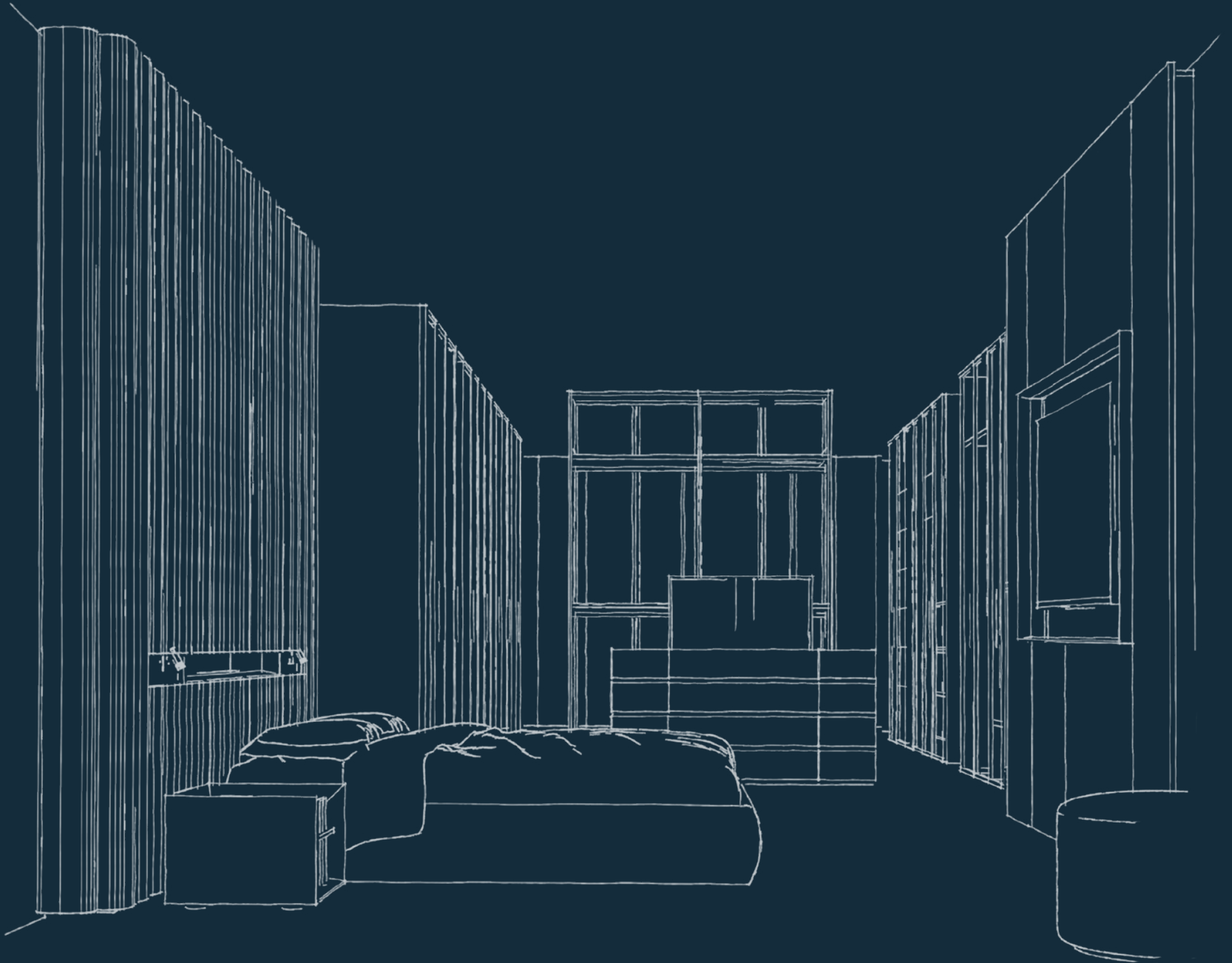

STORIE AZIENDALI

COMPANY STORY / HISTOIRE DE L'ENTREPRISE / HISTORIA DE LA EMPRESA

IT — Grazie alla collezione Dress Code, nell'ultimo triennio Olivieri ha compiuto un importante passo in avanti a livello aziendale e di riconoscibilità nel mercato, ritagliandosi uno spazio ben definito anche al di fuori della zona notte e scostandosi dai principi che l'hanno sempre definita come una bellissima azienda di camere da letto. Principi che però hanno fatto la storia di Olivieri, una storia lunga 90 anni che questo catalogo vuole richiamare. Come azienda, l'obiettivo è quello di rinnovarci, allineando la nostra proposta per la zona notte ai concetti espressi nel nostro percorso più recente, mantenendo la qualità e l'affidabilità che contraddistinguono da sempre i nostri prodotti. In modo naturale, Dress Code entra nella zona notte, portando la sua elevata capacità di progettazione e di su misura a integrazione della concretezza e della semplicità dei nostri gruppi letto e armadi. Il risultato è un prodotto generoso e pratico, estetico e funzionale: un prodotto vestito sull'esigenza del cliente.

Daniele Olivieri

EN — Thanks to the Dress Code collection, in the last three years Olivieri has taken an important step forward in terms of company and market recognition, carving out a well-defined space even outside the sleeping area and moving away from the principles that have always defined it as a beautiful bedroom company. Principles that however have made the history of Olivieri, a 90-year history that this catalog wants to recall. As a company, the goal is to renew ourselves, aligning our proposal for the sleeping area with the concepts expressed in our most recent path, maintaining the quality and reliability that have always distinguished our products. In a natural way, Dress Code enters the night area, bringing its high capacity for design and made-to-measure to complement the concreteness and simplicity of our bed sets and wardrobes. The result is a generous and practical, aesthetic and functional product: a product tailored to the customer's needs.

Daniele Olivieri

FR — Grâce à la collection Dress Code, au cours des trois dernières années, Olivieri a franchi une étape importante en termes de reconnaissance de l'entreprise et du marché, en se taillant un espace bien défini même en dehors de la zone chambres à coucher et en s'éloignant des principes qui l'ont toujours définie, comme une entreprise qui produit des compléments nuit. Des principes qui ont pourtant fait l'histoire d'Olivieri, une histoire de 90 ans que ce catalogue veut rappeler. En tant qu'entreprise, l'objectif est de nous renouveler, en alignant notre proposition pour la zone nuit avec les concepts exprimés dans notre parcours le plus récent, en maintenant la qualité et la fiabilité qui ont toujours distingué nos produits. De manière naturelle, Dress Code entre dans l'espace nuit, apportant sa grande capacité de design et de sur-mesure pour compléter le concret et la simplicité de nos parures de lit et de nos armoires. Le résultat est un produit généreux et pratique, esthétique et fonctionnel : un produit adapté aux besoins du client.

Daniele Olivieri

ES — Gracias a la colección Dress Code, en los últimos tres años Olivieri ha dado un importante paso adelante en términos de reconocimiento de la empresa y del mercado, estableciendo un espacio bien definido incluso fuera de la zona de noche y alejándose de los principios que siempre la han definido; como una hermosa compañía de dormitorio. Principios que sin embargo han hecho la historia de Olivieri, una historia de 90 años que este catálogo quiere recordar. Como empresa, el objetivo es renovarnos, alineando nuestra propuesta para el área de descanso con los conceptos expresados en nuestra trayectoria más reciente, manteniendo la calidad y confiabilidad que siempre han distinguido a nuestros productos. De forma natural, Dress Code entra en la zona de noche, aportando su alta capacidad de diseño y hecho a medida para complementar la concreción y sencillez de nuestros juegos de cama y armarios. El resultado es un producto generoso y práctico, estético y funcional: un producto a la medida de las necesidades del cliente.

Daniele Olivieri

1929-2023: 94 ANNI DI STORIA

1929-2023: 94 YEARS OF OLIVIERI HISTORY / 1929-2023: 94 ANS D'HISTOIRE OLIVIERI / 1929-2023: 94 AÑOS DE HISTORIA DE OLIVIERI

IT — 94 anni di viaggio insieme, fatti di storie di realtà quotidiana – tra le linee di produzione della fabbrica, o tra gli uffici, in tante città dello stivale o nelle principali metropoli mondiali – grazie a coloro che hanno creduto in noi fino ad oggi possiamo definirci con orgoglio un "pezzo di storia d'Italia", sapendo di essere entrati a far parte della vita di molte famiglie, spesso in maniera discreta, ma sempre con l'obiettivo che la nostra passione ed impegno quotidiano rimangano apprezzati e riconosciuti come in questi nostri primi 94 anni.

EN — 94 years of journey together, made by real daily stories – from the ones among the production lines of the factory or the offices to the multiple cities of the Italian "boot" or the world's main cities – thanks to all the people who have always

believed in us until now we can proudly say that we are a "piece of Italian history". We are sure we have become a part of many Italian families, often in a discrete way, but always with the single aim that our passion and daily dedication are appreciated and recognised as they have been in these 94 years.

FR — 94 ans de voyage ensemble, réalisés à partir de vrais récits quotidiens – depuis les chaînes de production de l'usine ou des bureaux jusqu'aux multiples villes de la "botte" italienne ou des grandes villes du monde – grâce à tous ceux qui ont toujours cru en nous, jusqu'à présent, nous pouvons dire avec fierté que nous sommes un «morceau de l'histoire italienne». Nous sommes certains de faire partie de nombreuses familles italiennes, souvent de manière

discrète, mais toujours dans le seul but de faire en sorte que notre passion et notre dévouement quotidien soient appréciés et reconnus comme ils l'ont été au cours de ces 94 années.

ES — 94 años de viajes juntos, hechos de historias de realidad cotidiana – entre las líneas de producción de la fábrica o entre las oficinas, en muchas ciudades de la "bota" italiana o en las principales metrópolis del mundo – gracias a quienes han creído en nosotros hasta ahora podemos definirnos con orgullo una "pieza de la historia italiana". Esto, sabiendo de formar parte de la vida de muchas familias, a menudo de manera discreta, pero siempre con el objetivo de que nuestra pasión y nuestro trabajo sean siempre apreciados y reconocidos como en estos primeros 94 años.

STILE SARTORIALE

TAILOR-MADE STYLE / STYLE PERSONNALISER / ESTILO SARTORIAL

IT — La filosofia Olivieri ha da sempre privilegiato la scelta accurata dei materiali e l'innovazione tecnologica, facendo così coesistere i valori artigianali appartenenti alla più autentica tradizione del mobile, con le esigenze attuali di produzione. Le nostre collezioni sono da sempre caratterizzate da una forte componente: la sartorialità. La possibilità di personalizzare le nostre collezioni con finiture e personalizzazioni tipiche delle falegnamerie, rendendo ogni progetto unico e di altissimo livello.

EN — Olivieri's philosophy has always favoured the careful choice of materials and technological innovation, therefore making the artisan values belonging to the most authentic furniture tradition coexist with current production needs. Our collections have always been characterised by a strong component: tailoring. The possibility to customise our collections with finishes and customisations typical of carpentry, making each project unique and of the highest level.

FR — La philosophie d'Olivieri a toujours privilégié le choix judicieux des matériaux et l'innovation technologique, faisant ainsi coexister les valeurs artisanales appartenant à la tradition du meuble la plus authentique avec les besoins de production actuels. Nos collections ont toujours été caractérisées par une composante forte : le tailoring. La possibilité de personnaliser nos collections avec des finitions et des personnalisations typiques de la menuiserie, rendant chaque projet unique et du plus haut niveau.

ES — La filosofía de Olivieri siempre ha privilegiado la cuidadosa elección de los materiales y la innovación tecnológica, haciendo convivir así los valores artesanales propios de la más auténtica tradición mueblería con las necesidades productivas actuales. Nuestras colecciones siempre se han caracterizado por un fuerte componente: la sastrería. La posibilidad de personalizar nuestras colecciones con acabados y personalizaciones propias de la carpintería, haciendo que cada proyecto sea único y del más alto nivel.



ARMADI

WARDROBE



GLASS

ARMADI

GLASS — WARDROBE





IT - Armadio battente GLASS TEKA con telaio brown e vetri trasparente naturale. Sullo sfondo composizione Dress Code in Quarzo 10:10 con passaggio porta soffietto.

EN - GLASS TEKA swing glass door wardrobe with brown frame and natural transparent glass. On the background, a Dress Code composition in Quarzo finish with 10:10 engravings, with folding passage door.

FR - Armoire battant GLASS TEKA avec cadre brown et verres transparents naturels. Sur fond composition Dress Code en Quarzo 10:10 avec porte de passage pliante.

ES - Armario abatible GLASS TEKA con estructura marrón y cristal natural transparente. Al fondo composición Dress Code en Cuarzo 10:10 con paso de puerta de fuele.







IT - Armadio GLASS con struttura impiallacciata rovere Light e ante in vetro Structure Bronzo con telaio laccato Champagne. Sulla destra cabina KAB con schienali in tessuto Canvas Luna, accessori in rovere Light ed elementi metallici laccati champagne. Al centro isola ICON in rovere Light.

EN - GLASS wardrobe with Light oak structure and Structure Bronze glass doors with metallic lacquered Champagne frame. On the right hand side, Kab walk-in closet with back panels upholstered with Canvas Luna fabric, internal accessories in Light oak and metallic items in Champagne. Centrally, ICON Island in Light oak.

FR - Armoire GLASS avec structure plaquée en chene Light et portes en verre Structure Bronzo avec cadre laqué Champagne. Sur la droite dressing KAB avec fonds en tissu Canvas Luna, accessoires en chene Light et éléments métalliques laqués champagne. Au centre îlot ICON en chene Light.

ES - Armario en GLASS con estructura chapada en Roble Claro y puertas de cristal Structure Bronce con marco lacado Champagne. A la derecha, vestidor KAB con respaldos en tejido Canvas Luna. Accesorios en roble Light y elementos metálicos lacados champagne. En el centro isla ICON en roble Light.





IT - Dettagli del puff estraibile dell'isola ICON con seduta in tessuto Canvas Luna.

EN - Details of the pull-out seat of the ICON Island upholstered with Canvas Luna fabric.

FR - Détails de l'ottoman amovible de l'ilot ICON avec siège en tissu Canvas Luna.

ES - Detalle del asiento extraíble de la isla ICON con asiento en tejido Canvas Luna.





IT - Armadio con ante centrali GLASS in vetro Stop-Sol e ante laterali laccate Fango Opaco con maniglia Glass. Nel dettaglio a destra cassetiera interna in Royal con griglia laccato Fango opaco. A sinistra dettaglio del soprizzo in laccato con apertura push.

EN - Wardrobe with central Stop-Sol bronze glass doors and lateral doors lacquered in Fango matt with Glass handle. In the detail on the right-hand side, the internal chest of drawers in Royal finish with accessory grid in Fango matt lacquering. On the left hand side, detail of the upper wardrobe in lacquered finishing and push-pull opening.

FR - Armoire avec portes centrales GLASS en verre Stop-Sol et portes laterales laquées Fango Opaco avec poignée Glass. Dans le détails à droite, bloc tiroirs interne en Royal avec grille laquée Fango opaco. A gauche détail de la partie haute en laqué avec ouverture push-lâche.

ES - Armario con puertas centrales GLASS en cristal Stop-Sol y puertas laterales lacadas mate Fango con tirador Glass. En detalle en la cómoda interior derecha en Royal con rejilla lacada Fango mate. A la izquierda, detalle del mueble alto lacado con apertura push.

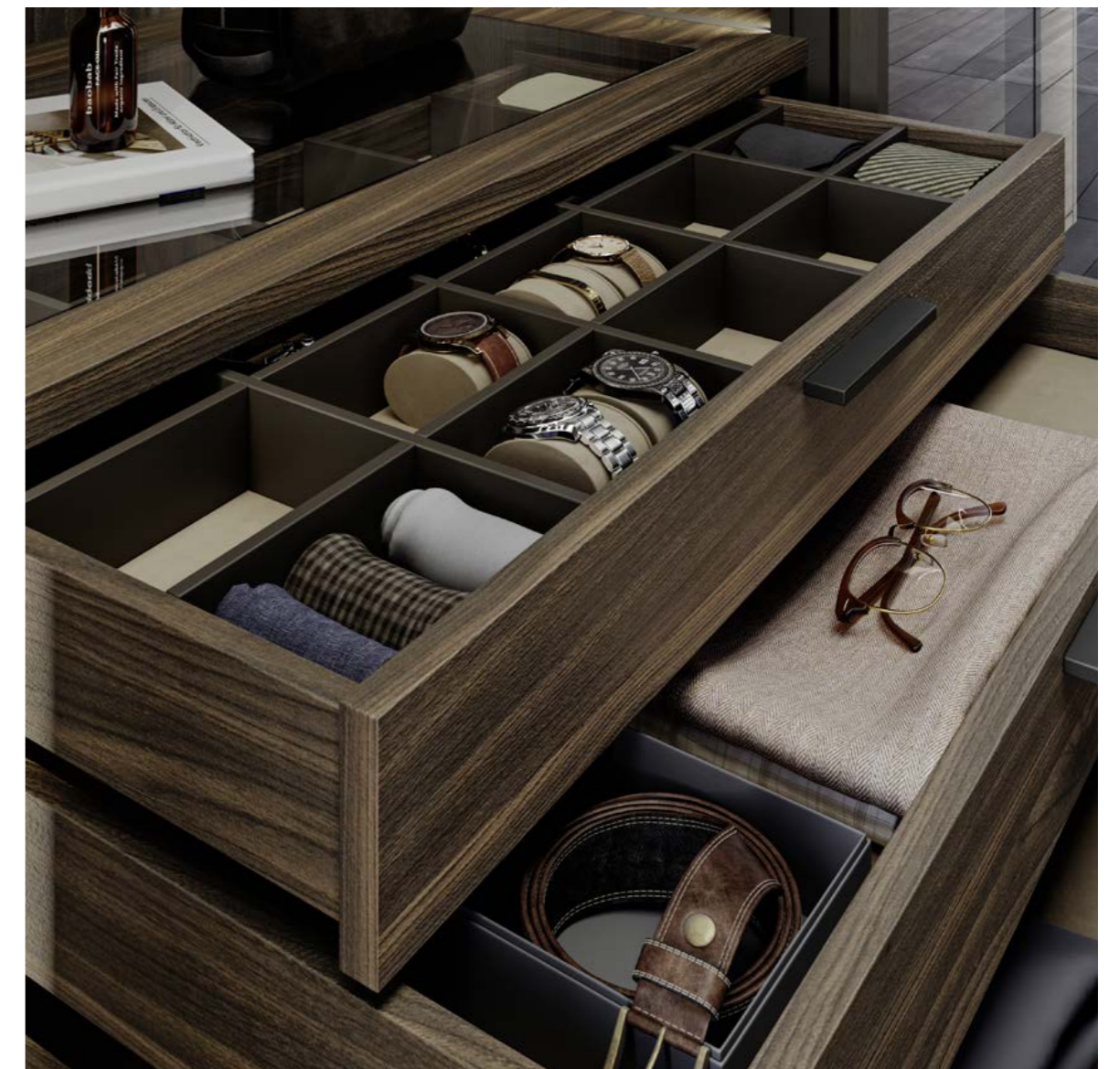





IT - Composizione Dress Code ad angolo con armadio scorrevole GLASS TEKA in vetro trasparente fumè e telaio Brown. Sullo sfondo armadio con ante in rovere Fumo 10:2 e mensolone CUBE 6 in rovere Fumo.

EN - GLASS TEKA Dress Code composition with corner module and sliding doors in Fumè transparent glass and Brown frame. In the background, the wardrobe has Fumo oak doors with 10:2 engravings and Cube 6 big shelf in Fumo oak.

FR - Composition Dress Code en version coin avec armoire coulissant GLASS TEKA en verre transparent fumè et cadre Brown. Au fond armoire avec portes en chêne Fumo 10:2 et tablette fort épaisseur CUBE 6 en chêne Fumo.

ES - Composición Dress Code con armario angular corredero GLASS TEKA en cristal transparente fumé y marco Brown. Al fondo armario con puertas en roble Fumo 10:2 y repisa grande CUBE 6 en roble Fumo.







IT - Armadio scorrevole GLASS con vetro stop-sol Bronzo e montanti metallici Brown. Nel dettaglio a destra il complemento VANITY.

EN - GLASS sliding wardrobe with Stop-sol bronze glass and Brown metallic sides. In detail, on the right hand side, the VANITY.

FR - Armoire coulissante GLASS avec verre stop-sol Bronzo et cadre métallique Brown. Dans le détail à droite le complément VANITY.

ES - Armario corredero GLASS con cristal stop-sol Bronce y bastidores metálicos Marrón. En detalle a la derecha el complemento VANITY.



GAP

ARMADI

GAP — WARDROBE





IT - Armadio battente GAP B5 con gola verticale a tutta altezza in laccato lino opaco e 10:10 e nicchie laterali in rovere Light. Cuscino nella finitura tessuto Canvas Luna.

EN - Swing wardrobe with GAP B5 built-in handle through all door's height in lino matt lacquering and with 10:10 engravings, lateral niches in Light oak. Cushion upholstered with Canvas Luna fabric.

FR - Armoire battant GAP B5 avec gorge verticale à toute hauteur en laqué lino opaco et 10:10 et niches laterales en chêne Light. Coussin dans la finition du tissu Canvas Luna.

ES - Armario con puerta abatible en lino mate lacado 10:10 y huecos laterales en Roble Claro. Tirador GAP B5 con canal vertical a toda altura Cojín en acabado tejido Canvas Luna.





IT - Armadio battente GAP B5 in laccato Grafite opaco. Vani a giorno e porta d'arredo in rovere Wengè.

EN - GAP B5 swing wardrobe lacquered in Grafite mat. Open units and internal door in Wengè oak.

FR - Armoire battant GAP B5 en laqué Grafite opaco. Modules ouverts et porte de passage en chene Wengè.

ES - Armario con puerta abatible GAP B5 en lacado mate Grafite. Compartimentos abiertos y puerta decorativa en roble Wengè.





IT - Armadio battente GAP B1 in laccato Canapa opaco. Nel dettaglio il laterale a giorno e la maniglia gola B1.

EN - Wardrobe in matt Canapa lacquer with GAP B1 handle. In detail, the open side panel and the B1 groove handle.

FR - Armoire battant GAP B1 en laqué Canapa opaco. Dans le détail le module teral ouvert et la poignée gorge B1.

ES - Armario con puerta abatible in lacado mate Canapa. Tiradores GAP B1, en detalle, el lado abierto y el tirador con ranura B1.







IT - Armadio battente GAP B1 in laccato Vischio 10:10 e due ante GLASS in vetro trasparente fumè con telaio Bronzo. Sulla destra dettaglio della maniglia gola B1.

EN - Wardrobe with swing door, handle GAP B1 and finishing Vischio lacquer with 10:10 and two GLASS doors in Fume' transparent glass with Bronzo frame. On the right, detail of the B1 groove handle.

FR - Armoire battant GAP B1 en laqué Vischio 10:10 et deux portes GLASS en verre transparent fumè avec cadre Bronzo. Sur la droite détail de la poignée gorge B1.

ES - Armario con puerta abatible GAP B1 lacado Canapa 10:10 y dos puertas GLASS en vidrio transparente fumè y bastidor Bronzo. En detalle, el tirador con gola B1.

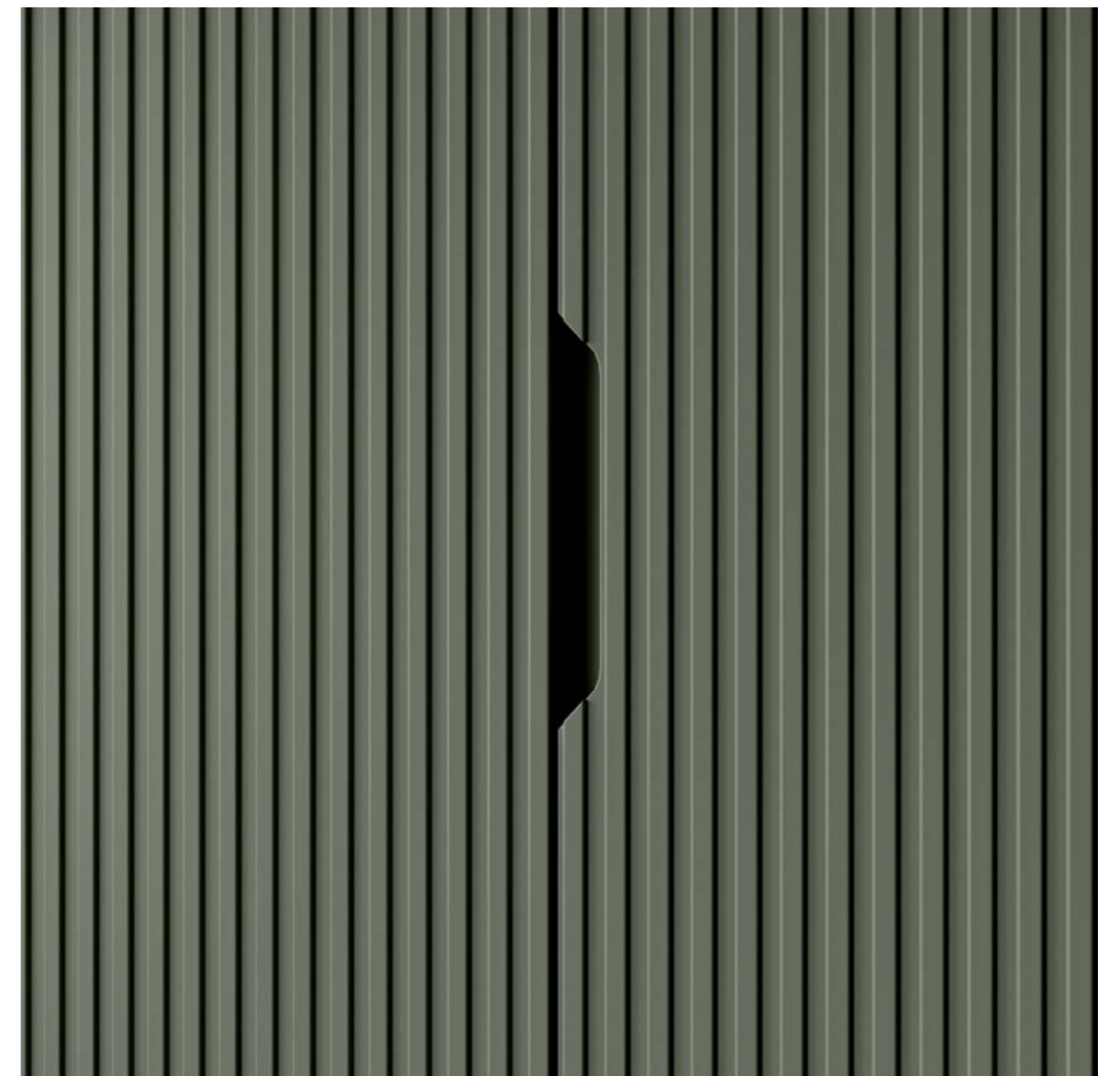





IT - Armadio battente GAP B6 in laccato Quarzo opaco e maniglia B6 in laccato Bronzo. Nel dettaglio a sinistra l'integrazione della collezione GLASS con ante e fianco laterale in vetro trasparente naturale.

EN - Wardrobe with swing door, handle GAP B6 in matt Quazar lacquer and B6 handle in Bronzo lacquer. In detail on the left, the integration of the GLASS collection with doors and side panels in natural transparent glass.

FR - Armoire battant GAP B6 en laqué Quarzo opaco et poignée B6 en laqué Bronzo. Dans le détail à gauche l'intégration de la collection GLASS avec portes et chant lateral en verre transparent naturel.

ES - Armario con puerta abatible GAP B6 lacado mate Quazar y tirador B6 lacado Bronzo. En detalle a la izquierda, la integración de la colección GLASS con puertas y costados en vidrio natural transparente.





IT - Armadio battente GAP B6 con doppia maniglia gola B6 e modulo a giorno in laccato Bronzo.

EN - Wardrobe with swing door, with GAP B6 with double B6 groove handle and Bronzo lacquered open module.

FR - Armoire battant GAP B6 avec double poignée gorge B6 et module ouvert en laqué Bronzo.

ES - Armario con puerta abatible GAP B6 con doble tirador B6 y módulo abierto lacado Bronzo.





IT - Armadio battente GAP B3-B4 in Lino opaco con maniglia in rovere Tabacco. Nel dettaglio a destra il gruppo letto LEONARDO.

EN - Wardrobe with swing door in matt Lino with Tabacco oak, handle GAP B3-B4. In detail on the right, the LEONARDO bed group.

FR - Armoire battant GAP B3-B4 en Lino opaco avec poignée en chêne Tabacco. Dans le détail à droite le lit et table de nuit LEONARDO.

ES - Armario con puerta abatible GAP B3-B4 en Lino mate con tirador Roble Tabacco. En detalle a la derecha, el grupo de cama LEONARDO.





IT - Armadio soffietto GAP B2 in Fango opaco e struttura interna in Royal.

EN - Folding wardrobe in matt Fango with handle GAP B2 and internal structure in Royal.

FR - Armoire pliant GAP B2 en Fango opaco et structure interne en Royal.

ES - Armario puerta abatible con tirador GAP B2 en Fango mate y estructura interior en Royal.







IT - Armadio scorrevole GAP S2 in Canapa opaco. Nell'immagine generale le porte d'arredo scorrevoli in Canapa LINE e maniglia S1 con all'interno la cabina armadio LOFT con montanti Champagne e accessori in Royal.

FR - Armoire coulissante GAP S2 en Canapa opaco. Dans l'image générale les portes de passage coulissantes en Canapa LINE et poignée S1, à l'intérieur le dressing LOFT avec montants Champagne et accessoires en Royal.

EN - Wardrobe with Sliding door in matt Canapa, handle GAP S2. In the principal image, the LINE internal sliding doors in Canapa and S1 handle with the LOFT walk-in closet inside posts in finishing Champagne and Royal accessories.

ES - Armario corredero GAP S2 en Canapa mate. En la imagen general, las puertas corredizas decoración LINE en Canapa mate y tirador S1 con en el interior vestidor LOFT con montantes Champagne y accesorios Royal.

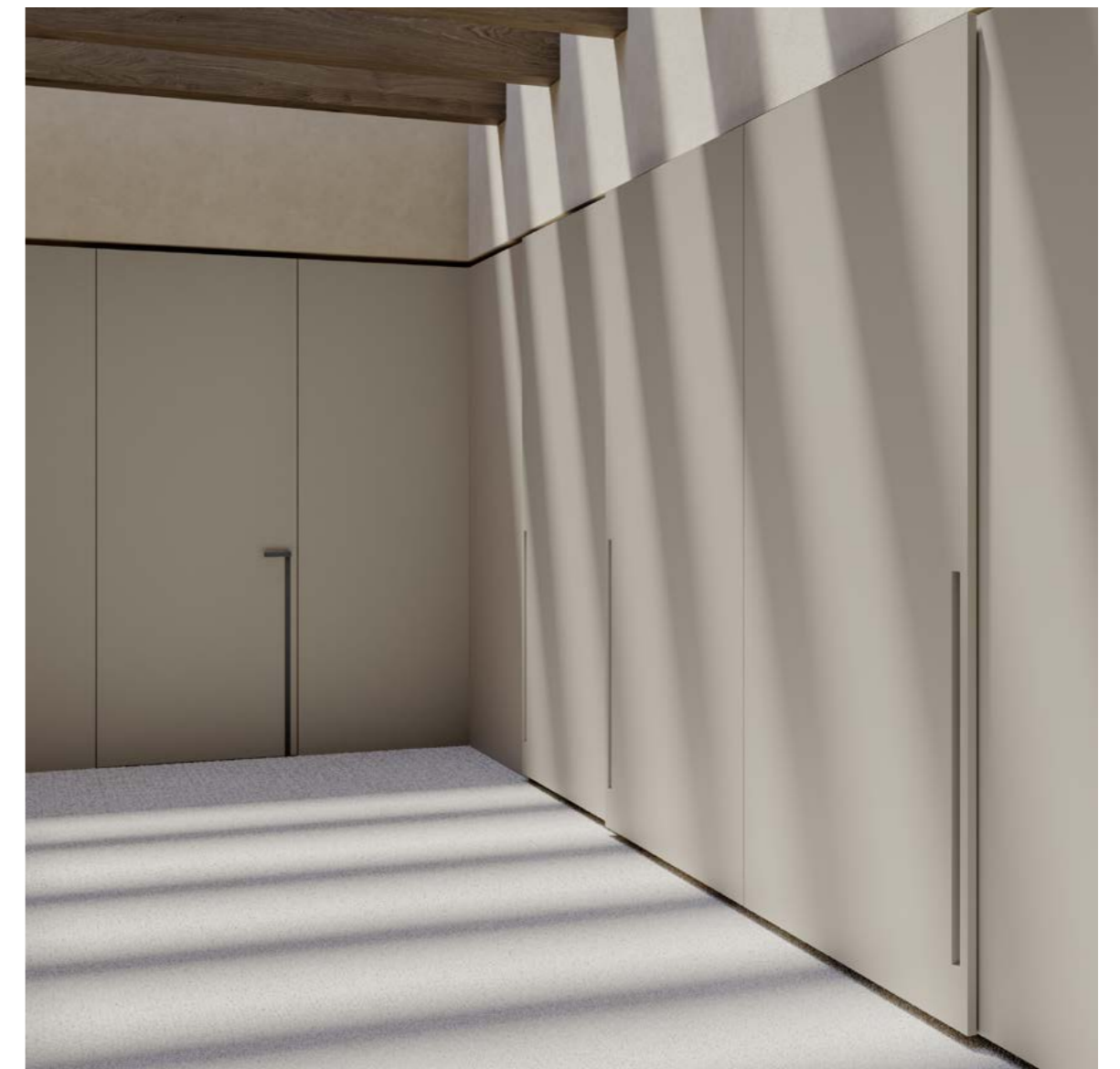



IT - Armadio antone scorrevole GAP A1 in Lino opaco. Nei dettagli l'interno con il fianco prestige retroilluminato in laccato Champagne e struttura in Royal.

EN - Sliding big door wardrobe in matt linen with GAP A1 handle. In detail, the interior with the backlit prestige side in Champagne lacquer and structure in Royal.

FR - Armoire grande porte coulissant GAP A1 en Lino opaco. Dans les détails, l'intérieur avec le chant prestige rétro-éclairé en laqué Champagne et structure en Royal.

ES - Armario de puertas correderas en lino mate con tirador GAP A1. En detalle, el interior con el lateral Prestige retroiluminado en lacado Champagne y estructura en Royal.







IT - Armadio complanare
GAP C2 in Fango opaco e
struttura interna in Royal.

EN - Wardrobe, GAP C2
handle, with coplanar door
in matt Fango and internal
structure in Royal.

FR - Armoire coplainare
GAP C2 en Fango opaco et
structure interne en Royal.

ES - Armario puerta
complanare en Fango mate
con tirador GAP C2. Estructura
interior en Royal.

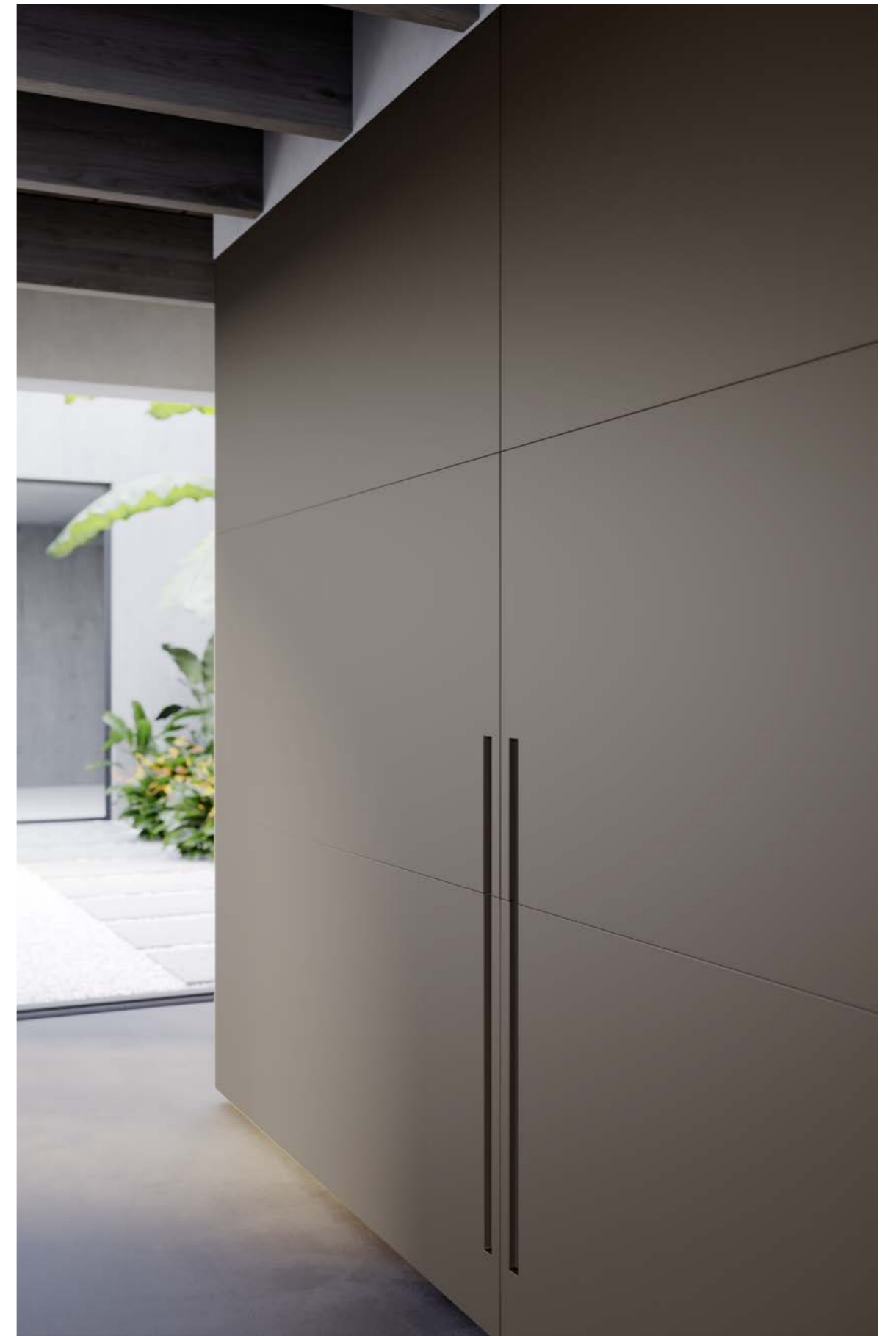



STYLE

ARMADI

STYLE — WARDROBE



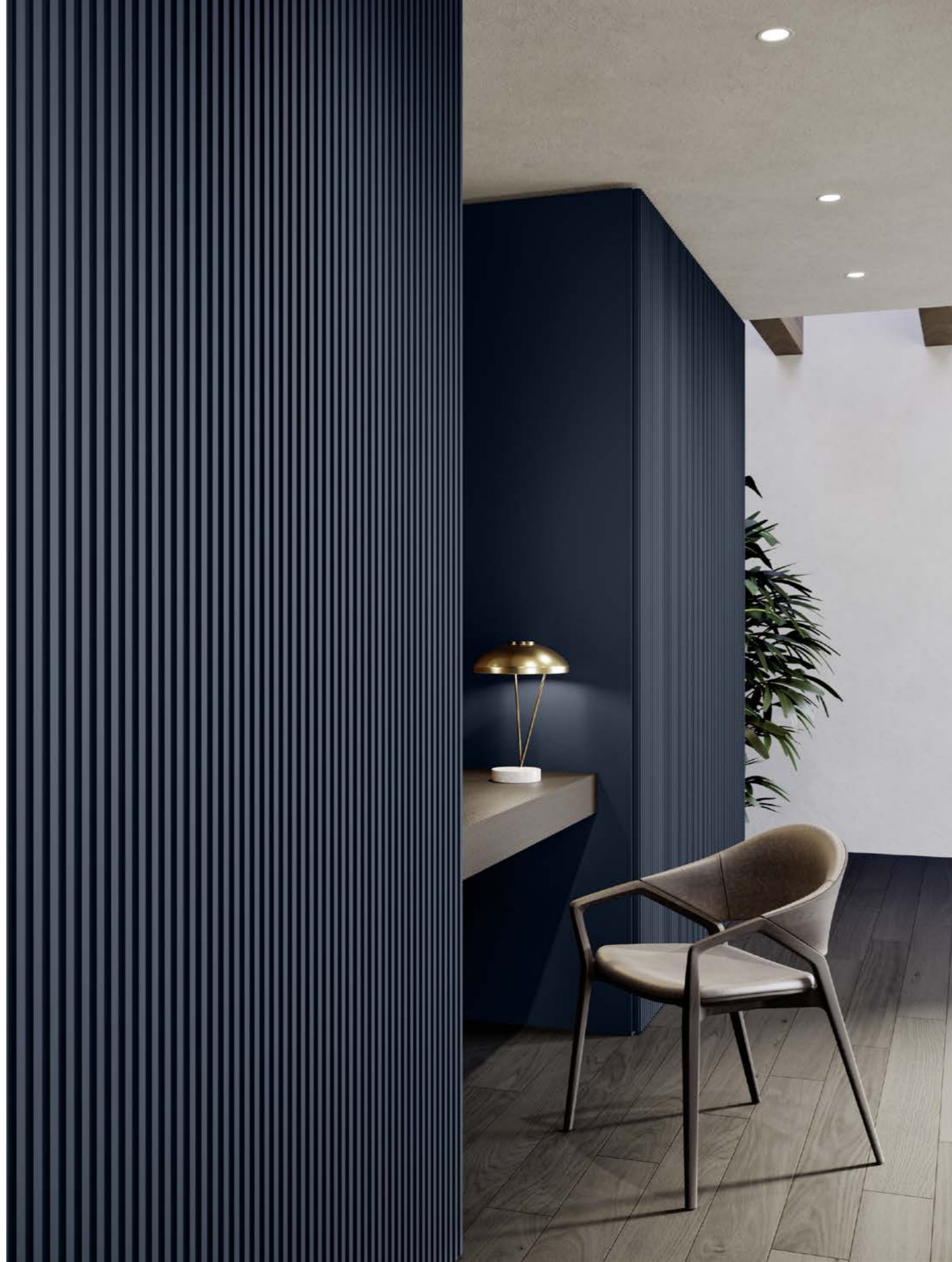

IT - Armadio battente STYLE in laccato Oceano 10:10 con mensolone in rovere Moka.

EN - Wardrobe STYLE with swing door in Oceano 10:10 lacquer finish, shelves in Moka oak.

FR - Armoire battant STYLE en laqué Oceano 10:10 avec tablette de fort épaisseur en chêne Moka.

ES - Armario con puerta abatible STYLE en acabado lacado Oceano 10:10 con repisas en roble Moka.





IT - Armadio battente STYLE in laccato Canapa 80:40 con porta d'arredo integrata con maniglia Infinity Long. Nel dettaglio a destra i ripiani porta scarpe inclinati.

EN - Wardrobe with STYLE swing door in Canapa 80:40 lacquer finish with integrated internal door with Infinity Long handle. In detail on the right, the inclined shoe shelves.

FR - Armoire battant STYLE en laqué Canapa 80:40 et porte de passage intégrée avec poignée Infinity Long. Dans le détail à droite, tablettes portchaussures inclinées.

ES - Armario con puerta abatible STYLE en acabado lacado Canapa 80:40 con puerta de intercomunicación integrada con tirador Infinity Long. En detalle a la derecha, los estantes para zapatos inclinados.





IT - Armadio battente STYLE in laccato Grafite opaco con porta d'arredo integrata con maniglia Infinity Short e modulo TV in rovere Carbon. Nel dettaglio a sinistra il pannello porta TV rotabile con ripiani nascosti.

EN - Wardrobe with swing door STYLE in matt Grafite lacquer with integrated interior door with Infinity Short handle and TV module in Carbon oak. In detail on the left, the rotating TV panel with hidden shelves.

FR - Armoire battant STYLE en laqué Grafite opaco et porte de passage intégrée avec poignée Infinity Short et module TV en chêne Carbon. Dans le détail à gauche le panneau porte TV ouvrable avec des étagères cachées.

ES - Armario con puertas abatibles STYLE lacado mate Grafite. Puerta de intercomunicación integrada con tirador Infinity Short y módulo TV en roble Carbón. En detalle a la izquierda, el panel de TV giratorio con repisas ocultas.







IT - Armadio battente STYLE in laccato Quarzo 10:10 con passaggio porta soffietto e box a giorno in rovere Grigio con camino a vapore integrato.

EN - Wardrobe with STYLE swing door in Quarzo 10:10 lacquer finish with folding door passage and Gray oak open box with integrated steam fireplace.

FR - Armoire battant STYLE en laqué Quarzo 10:10 avec porte pliante de passage et box ouvert en chêne Grigio avec cheminée à vapeur intégré.

ES - Armario con puerta abatible STYLE acabado lacado Quarzo 10:10. Puerta plegable abatible y modulo abierto de Roble Gris con chimenea de vapor integrada.







IT - Armadio soffietto STYLE in laccato Canapa opaco con maniglia wood in rovere Moka. Nel dettaglio a destra la speciale apertura soffietto con i fianchi Prestige retroilluminati.

EN - Wardrobe with STYLE folding door in matt Canapa lacquer finish with wood handle in Moka oak. In detail on the right, the special folding opening with backlit Prestige sides.

FR - Armoire pliant STYLE en laqué Canapa opaco avec poignée wood en chene Moka. Dans le détail à droite l'ouverture spéciale pliante avec chants Prestige rétro-éclairés.

ES - Armario con puerta abatible STYLE lacado mate Canapa con tirador wood en roble Moka. En detalle a la derecha, la especial apertura plegable abatible con costados Prestige retroiluminados.





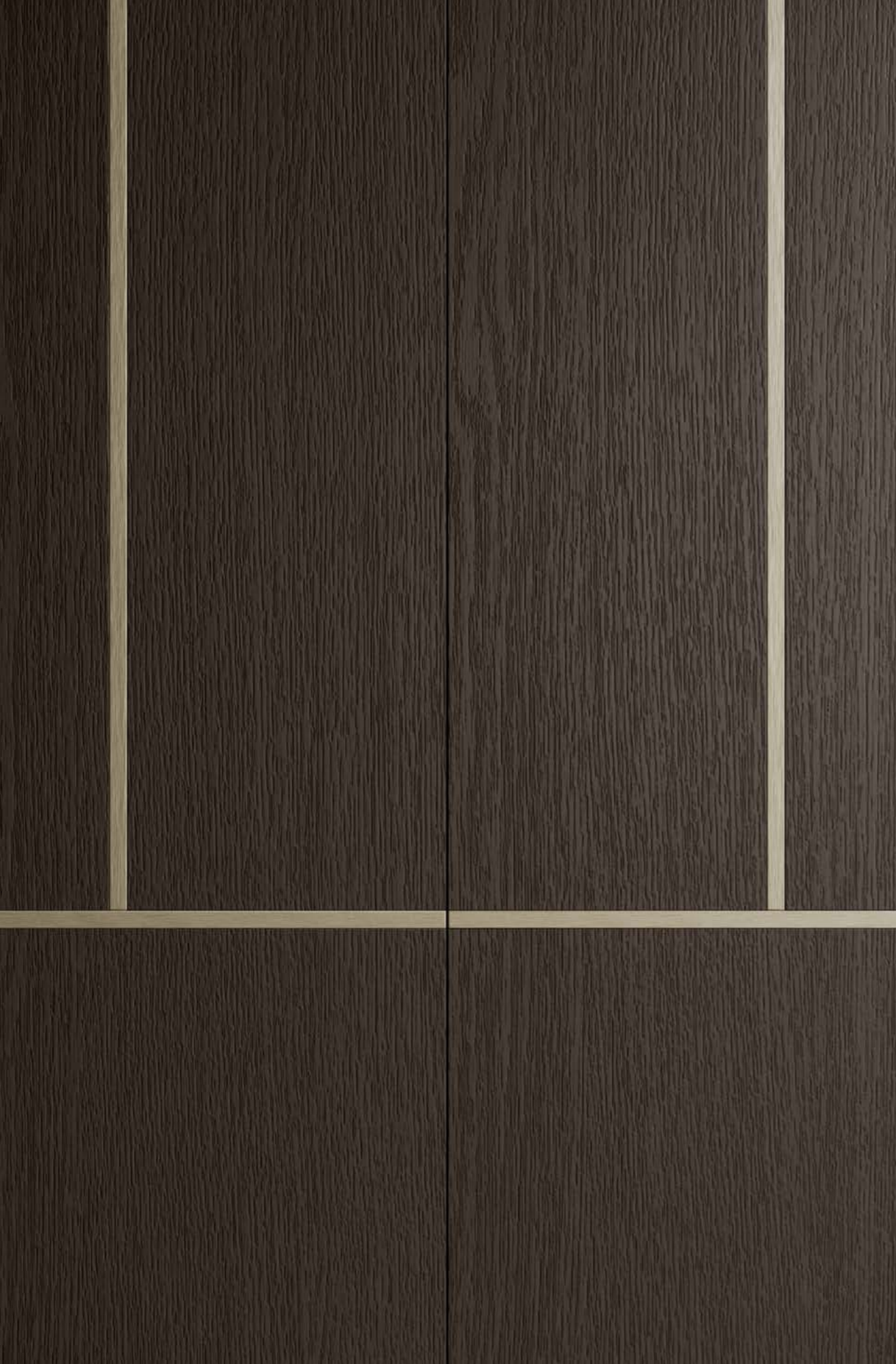

IT - Armadio battente STYLE
in rovere Fumo con inserto
metallico ottone e porte
d'arredo integrate.

EN - Wardrobe with STYLE
swing door in Fumo oak with
inserto metallic Ottone and
integrated internal door.

FR - Armoire battant STYLE
en chene Fumo avec insert
métallique laiton plus portes de
passage intégrées.

ES - Armario con puerta
abatible STYLE roble Fumo
con inserto metálico Ottone y
puerta de intercomunicación
integrada.

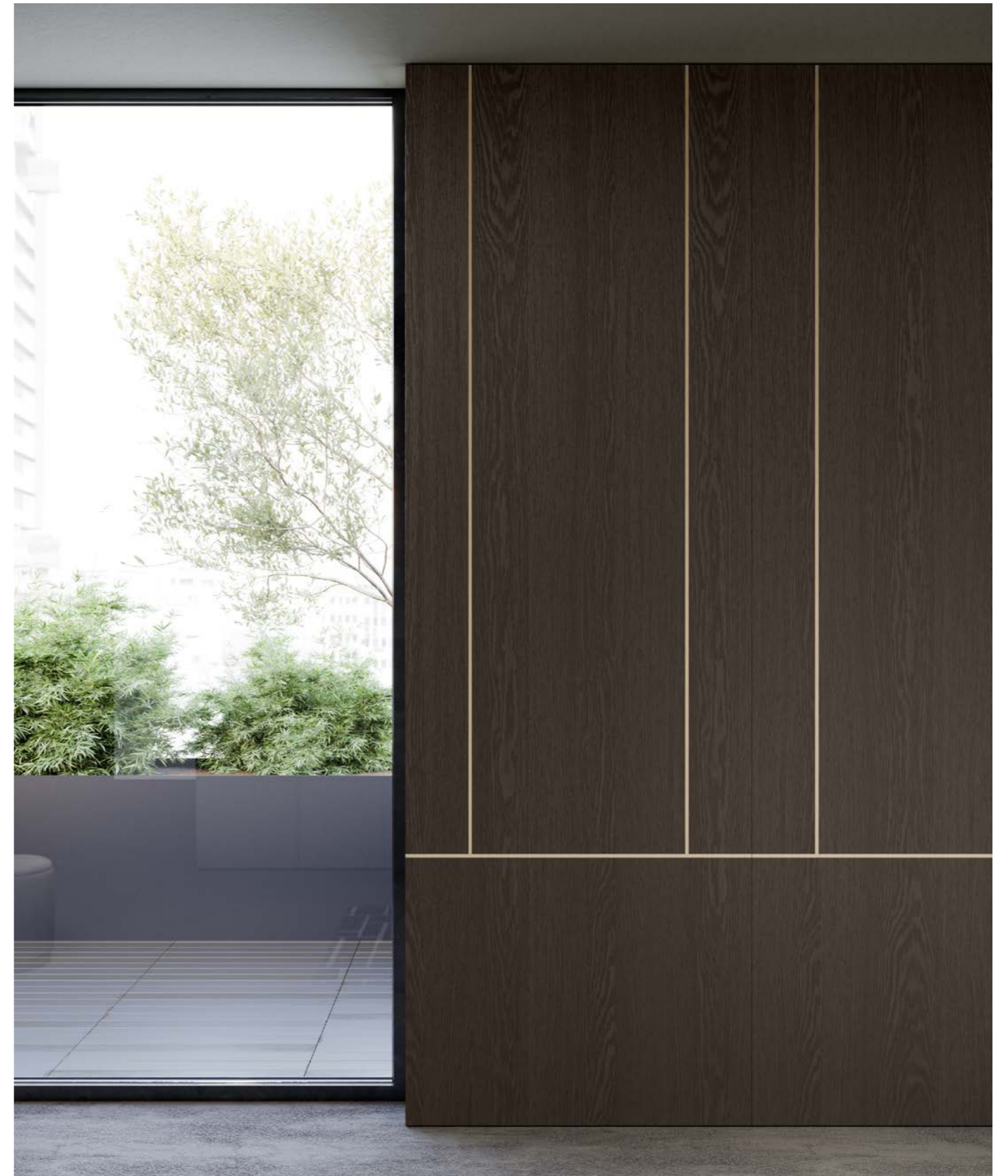





IT - Armadio scorrevole STYLE con tre ante laccate Grafite opaco e un'anta in rovere Carbon 10:2. Letto LEONARDO e VANITY in rovere Carbon.

EN - Wardrobe with three STYLE sliding doors in Grafite matt lacquer finish and one door in Carbon 10:2 oak. LEONARDO bed and VANITY in Carbon oak.

FR - Armoire coulissant STYLE avec trois portes laqué Grafite opaco et une porte chene Carbon 10:2. Lit LEONARDO et VANITY en chene Carbon.

ES - Armario con 3 puertas correderizas STYLE en acabado lacado mate Grafite y una puerta en roble Carbón 10:2. Cama LEONARDO y VANITY en roble Carbon.





DECOR

ARMADI

DECOR — WARDROBE





IT - Armadio battente DECOR in laccato Canapa LINE e moduli a giorno in Royal. Nel dettaglio a sinistra l'illuminazione verticale.

EN - Wardrobe with DECOR swing door in Canapa LINE lacquer finish and Royal open units. In detail on the left, vertical lighting.

FR - Armoire battant DECOR en laqué Canapa LINE et modules ouverts en Royal. Dans le détails à gauche l'éclairage verticale.

ES - Armario con puertas abatibles DECOR en acabado lacado Canapa LINE y módulos abiertos Royal. En detalle a la izquierda, iluminación vertical.





IT - Armadio battente DECOR in laccato Nociola SHANGHAI. Nei dettagli la nicchia a giorno in Royal con faretto led.

EN - Wardrobe with DECOR SHANGHAI swing door in Nociola lacquer finishing. In detail, the open niche in Royal with LED spotlight.

FR - Armoire battant DECOR en laqué Nociola SHANGHAI. Dans les détails la niche à jour en Royal avec spot led.

ES - Armario DECOR SHANGHAI con puerta abatible en acabado lacado Nociola. En detalle, el módulo abierto en Royal con foco LED.

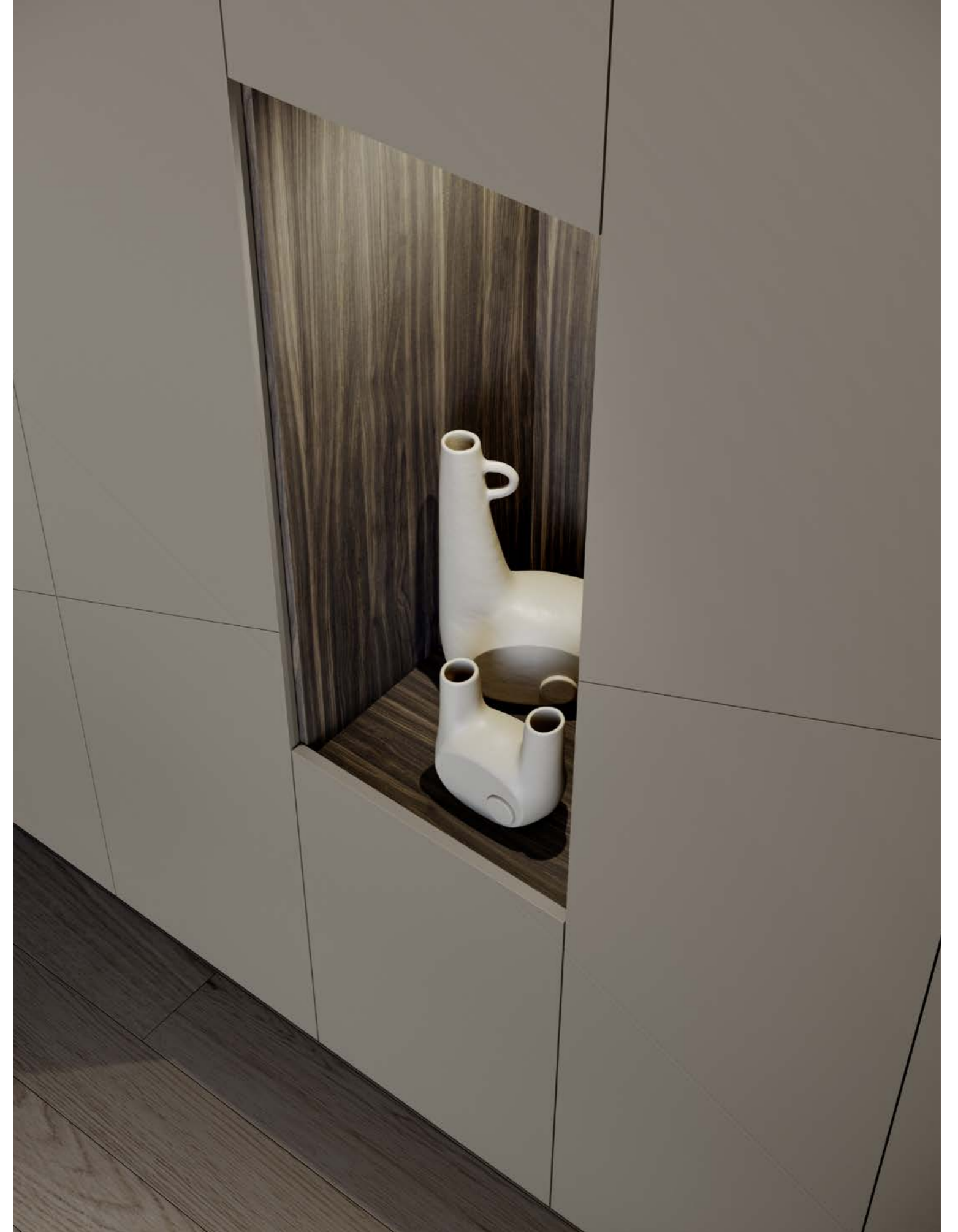



FAB

ARMADI

FAB — WARDROBE





IT - Armadio battente FAB in tessuto Canvas Luna e telaio Champagne. Ante GLASS integrate in vetro trasparente e telaio Champagne con struttura interna in rovere Light.

EN - Wardrobe with swing doors FAB in Canvas Luna fabric and Champagne frame. Integrated GLASS transparent glass and Champagne frame with internal structure in Light oak.

FR - Armoire battant FAB en tissu Canvas Luna et cadre Champagne. Portes GLASS intégrées en verre transparent et cadre Champagne avec structure interne en chêne Light.

ES - Armario con puertas abatibles FAB en tejido Canvas Luna y bastidor Champagne. Puertas GLASS integradas en cristal transparente y marco Champagne con estructura interior en Roble Light.



IT - Armadio battente FAB in tessuto Canvas Denim e telaio Bronzo. Nel dettaglio l'isola ICON rovere Moka.

EN - Wardrobe with swing door FAB in Canvas Denim texture and Bronze frame. In detail, the ICON island in Moka oak.

FR - Armoire battant FAB en tissu Canvas Denim et cadre Bronze. Dans le détail l'ilot ICON chene Moka.

ES - Armario con puerta abatible FAB en tejido Canvas Denim y bastidor Bronce. En detalle, la isla ICON en roble Moka.







IT - Armadio scorrevole FAB in ecopelle Tortora e telaio Bronzo. Sullo sfondo cabina armadio KAB in Royal.

EN - Wardrobe with FAB sliding door in Tortora eco-leather and Bronze frame. In the background KAB walk-in closet in Royal.

FR - Armoire coulissant FAB en ecocuir Tortora et cadre Bronzo. Sur le fond, dressing KAB en Royal.

ES - Armario con puerta corrediza FAB en ecopiel Tortora y bastidor Bronce. Al fondo, vestidor KAB en Royal.



DIAMANTE

ARMADI

DIAMANTE — WARDROBE



IT - Armadio battente DIAMANTE con anta in laccato Cappuccino opaco e rovere Fumo Diamante. Letto KALÈ con gruppo GINEVRA in rovere Fumo.

EN - Wardrobe with DIAMANTE swing door, in matt Cappuccino lacquer and Fumo Diamante oak. KALÈ bed with GINEVRA group in Fumo oak.

FR - Armoire battant DIAMANTE avec porte en in laqué Cappuccino opaco et chene Fumo Diamante. Lit KALÈ avec collection GINEVRA en chene Fumo.

ES - Armario con puerta abatible DIAMANTE, en lacado mate Cappuccino y roble Fumo Diamante. Cama KALÈ con grupo GINEVRA en roble Fumo.

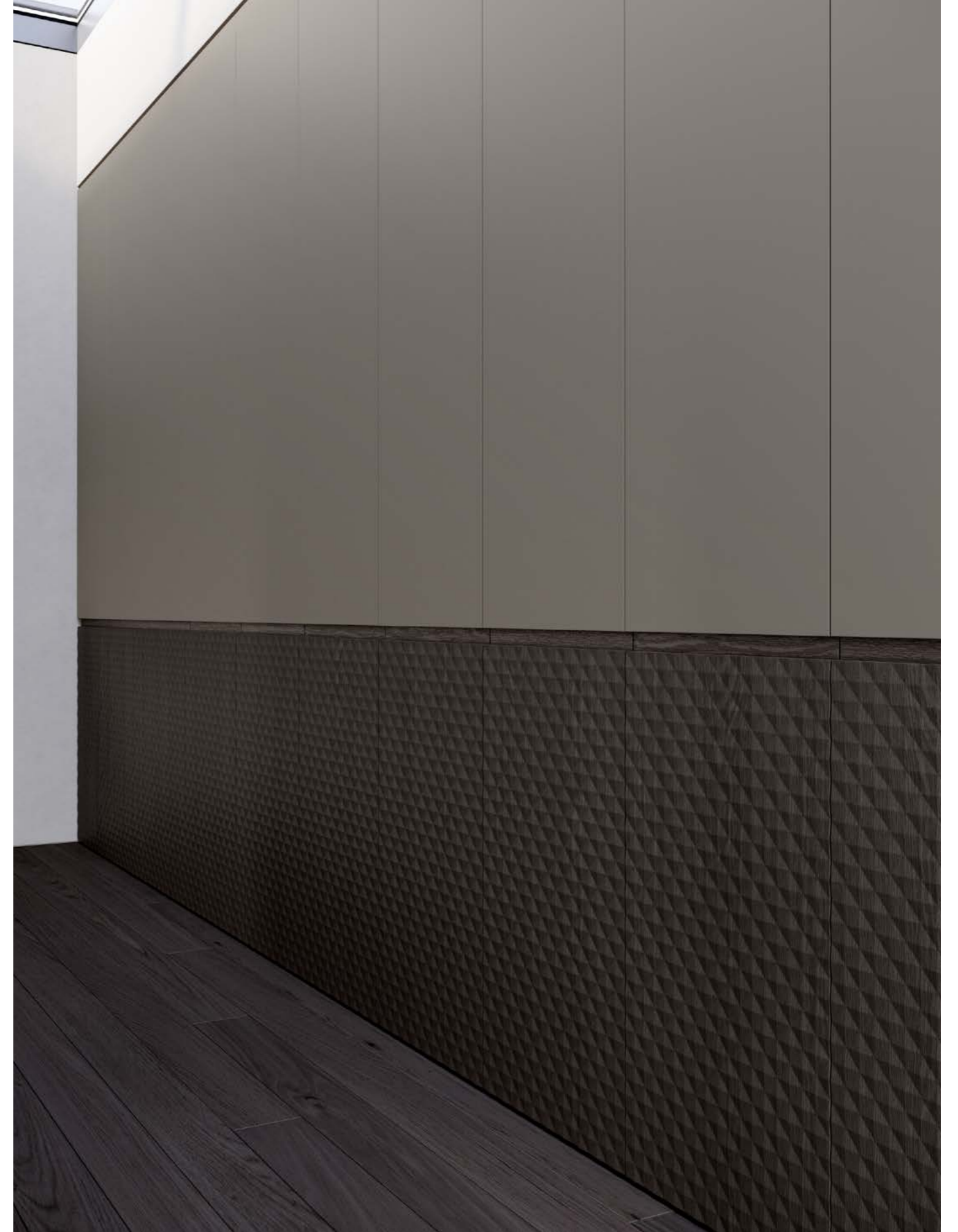



IT - Armadio battente DIAMANTE in laccato lino Diamante e maniglia in rovere Moka.

EN - Wardrobe with DIAMANTE swing door, in Lino Diamante lacquered finish and Moka oak handle.

FR - Armoire battant DIAMANTE en laqué lino Diamante et poignée en chene Moka.

ES - Armario con puertas abatibles DIAMANTE, en acabado lacado lino Diamante y tirador de roble Moka.

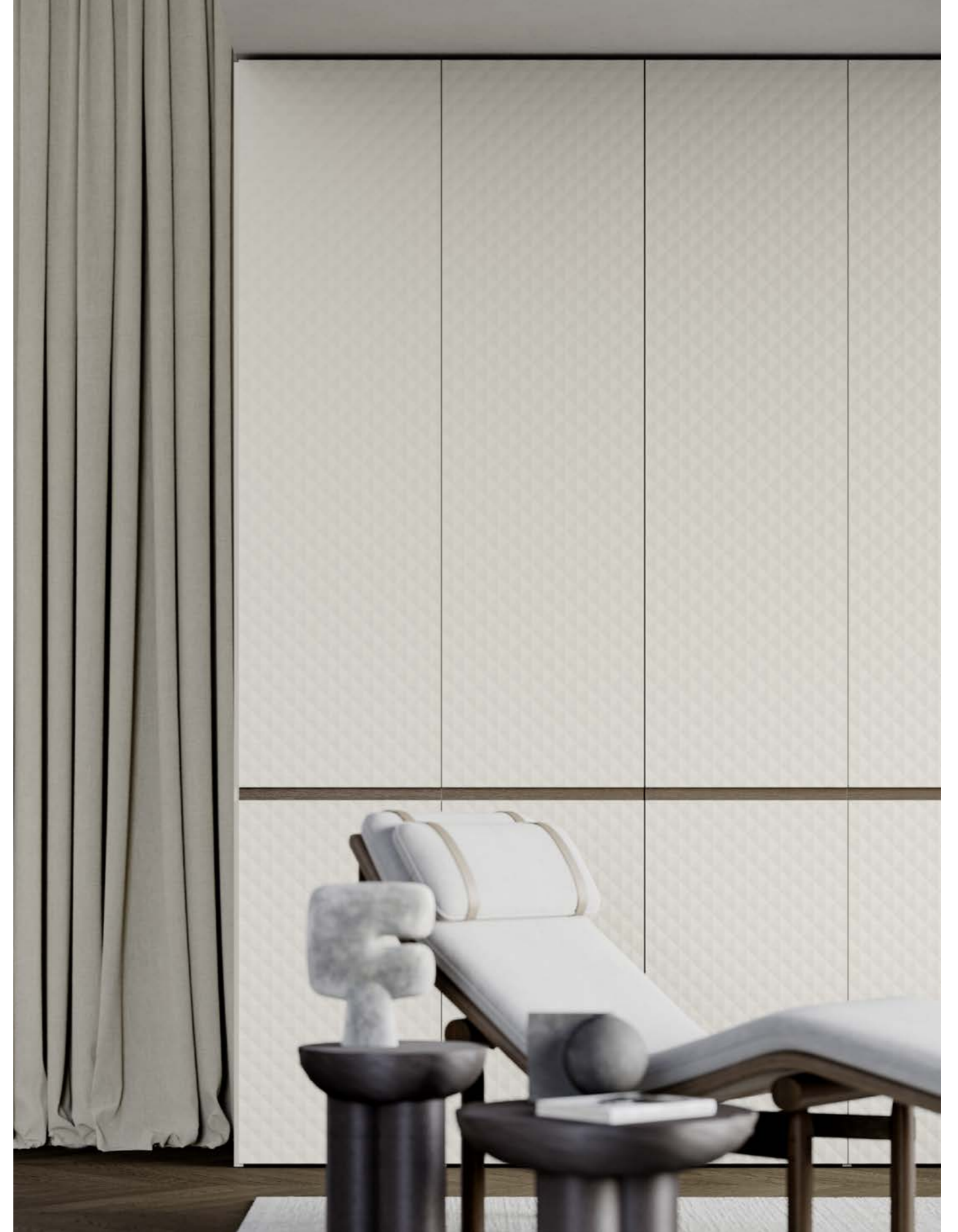

CABINE

WALK-IN CLOSET



PRESTIGE

CABINE

PRESTIGE — WALK-IN CLOSET



IT - Cabina armadio con strutture interne in Royal e fianco Prestige in Brown. Nel dettaglio a sinistra la retroilluminazione led integrata al fianco Prestige.

EN - Walk-in closet with internal structures in Royal and Prestige side in Brown. In detail on the left, the integrated LED backlighting on the Prestige side.

FR - Dressing avec structures internes en Royal et chant Prestige en Brown. Dans le détail à gauche le rétroéclairage led intégré au chant Prestige.

ES - Walk-in closet con estructuras internas en Royal y lateral Prestige en Brown. En detalle a la izquierda, la retroiluminación LED integrada en el costado Prestige.







IT - Cabina armadio con strutture interne in Royal e fianco Prestige in Champagne. Al centro l'isola LOFT in Royal.

EN - Walk-in closet with internal structures in Royal and Prestige side in Champagne. In the center the island LOFT in Royal.

FR - Dressing avec structure interne en Royal et chant Prestige in Champagne. Au centre l'ilot LOFT en Royal.

ES - Walk-in closet con estructuras internas en Royal y costado Prestige en Champagne. En el centro la isla LOFT en Royal.





IT - Cabina armadio con strutture interne in rovere Light e fianco Prestige in Champagne. Nel dettaglio a sinistra le ante GLASS in vetro trasparente naturale con telaio Champagne.

EN - Walk-in closet with internal structures in Light oak and Prestige side in Champagne. In detail on the left the GLASS doors in natural transparent glass with Champagne frame.

FR - Dressing avec structures internes en chêne Light et chant Prestige en Champagne. Dans le détail à gauche les portes GLASS en verre transparent naturel avec cadre Champagne.

ES - Walk-in closet con estructuras internas en Roble Light y costados Prestige en Champagne. En detalle a la izquierda las puertas GLASS en cristal transparente natural con marco Champagne.





KAB

CABINE

KAB — WALK-IN CLOSET



IT - Cabina armadio KAB con schienali in Canvas Luna ed accessori interni in rovere Tabacco. Al centro l'isola ICON in rovere Tabacco.

EN - KAB walk-in closet with back panels in Canvas Luna and internal accessories in Tobacco oak. In the centre, the ICON island in Tobacco oak.

FR - Dressing KAB avec fonds en Canvas Luna et accessoires internes en chêne Tabacco. Au centre l'îlot ICON en chêne Tabacco.

ES - Vestidor KAB con traseras en Canvas Luna y accesorios internos en Roble Tabacco. En el centro, la isla ICON en roble Tabacco.





ITALO CALVINO
LIVING IN STYLE
PARIS



IT - Cabina armadio KAB con schienali in materico pietra Grigio ed accessori interni in laccato Grafite.

EN - KAB walk-in closet with pietra Grigio textured back panels and Grafite lacquered internal accessories.

FR - Dressing KAB avec fonds en materique pierre Grigio et accessoires internes en laqué Grafite.

ES - Vestidor KAB con traseras textura Pietra Grigio y accesorios internos lacados Grafite.





IT - Cabina armadio KAB in Royal.
Nel dettaglio a sinistra l'accessorio
porta pantaloni estraibile in Brown.

EN - KAB walk-in closet in Royal. In
detail on the left, the pull-out trouser
holder accessory in Brown.

FR - Dressing KAB en Royal. Dans le
détail à gauche l'accessoire porte-
pantalons amovible en Brown.

ES - Vestidor KAB en Royal. En detalle
a la izquierda, el accesorio pantalón
extraíble en Brown.







IT - Cabina armadio KAB con schienali in carta da parati ed accessori in rovere Wengè. A centro l'isola LOFT in rovere Wengè e seduta in Canvas Topo.

EN - KAB walk-in closet with wallpaper back panels and Wengè oak accessories. In the center, the LOFT island in Wengè oak and seat in Canvas Topo.

FR - Dressing KAB avec fonds en papier peinte et accessoires en chene Wengè. Au centre l'ilot LOFT en chene Wengè et siège en Canvas Topo.

ES - Vestidor KAB con traseras papel tapis y accesorios en roble Wengè. En el centro, la isla LOFT en roble Wengè y asiento en Canvas Topo.





LOFT

CABINE

LOFT — WALK-IN CLOSET



IT - Cabina armadio LOFT in Royal con montanti Brown.

EN - LOFT walk-in closet in Royal with Brown posts.

FR - Dressing LOFT en Royal avec montants Brown.

ES - Vestidor LOFT en color Royal con montantes Brown.





IT - Cabina armadio LOFT in Royal con montanti Champagne. Al centro isola LOFT in Royal.

EN - LOFT walk-in closet in Royal with Champagne posts. Center Island LOFT in Royal.

FR - Dressing LOFT en Royal avec montants Champagne. Au centre îlot LOFT en Royal.

ES - Vestidor LOFT en Royal con montantes Champagne. Centro Island LOFT en Royal.

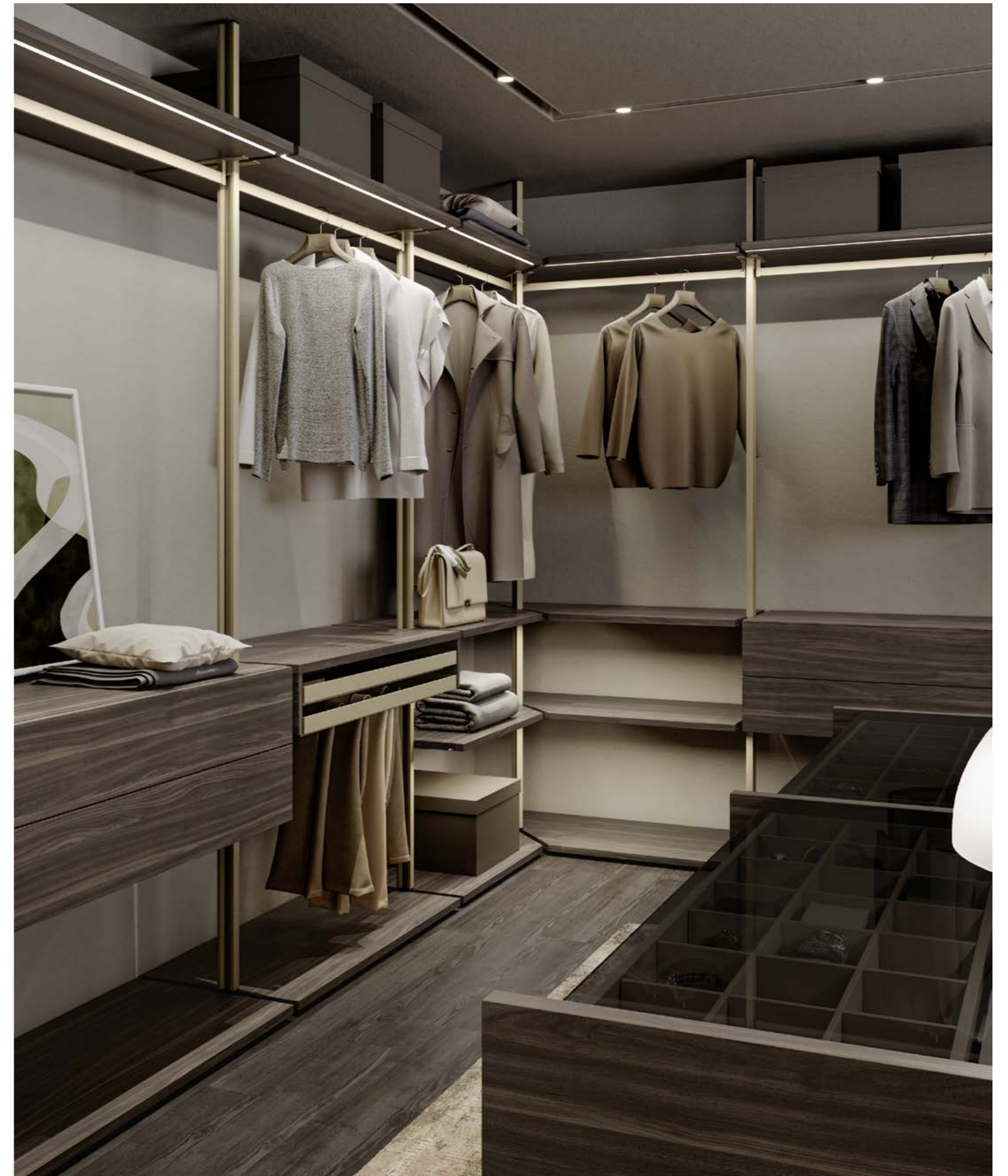





IT - Cabina armadio LOFT in laccato Fango opaco con montanti in Brown.

EN - LOFT walk-in closet in matt Mud lacquer with Brown posts.

FR - Dressing LOFT en laqué Fango opaco avec montants en Brown.

ES - Vestidor LOFT en lacado mate Mud con montantes Brown.



LETTI E GRUPPI

BED COLLECTIONS



DRESS CODE

LETTI E GRUPPI

DRESS CODE — BED COLLECTIONS





IT - Letto DRESS CODE con testata imbottita in Canvas Luna e nicchia orizzontale laccata Champagne. Gruppo letto AQUA in laccato Lino 10:10 con basamento Champagne. Nel dettaglio a destra la vaschetta Champagne retroilluminata.

FR - Lit DRESS CODE avec tête de lit rembourrée en Canvas Luna et niche horizontale laquée Champagne. Compléments AQUA en laqué Lino 10:10 avec socle Champagne. Dans le détail à droite le tiroir suspendu Champagne rétroéclairé.

EN - DRESS CODE bed with upholstered headboard in Canvas Luna and horizontal Champagne lacquered niche. AQUA bed group in Lino 10:10 lacquer with Champagne base. In detail on the right, the backlit Champagne tray.

ES - Cama DRESS CODE con cabecera tapizada en Canvas Luna y nicho horizontal lacado Champagne. Grupo de cama AQUA lacado Lino 10:10 con base Champagne. En detalle a la derecha, la bandeja en Champagne retroiluminada.

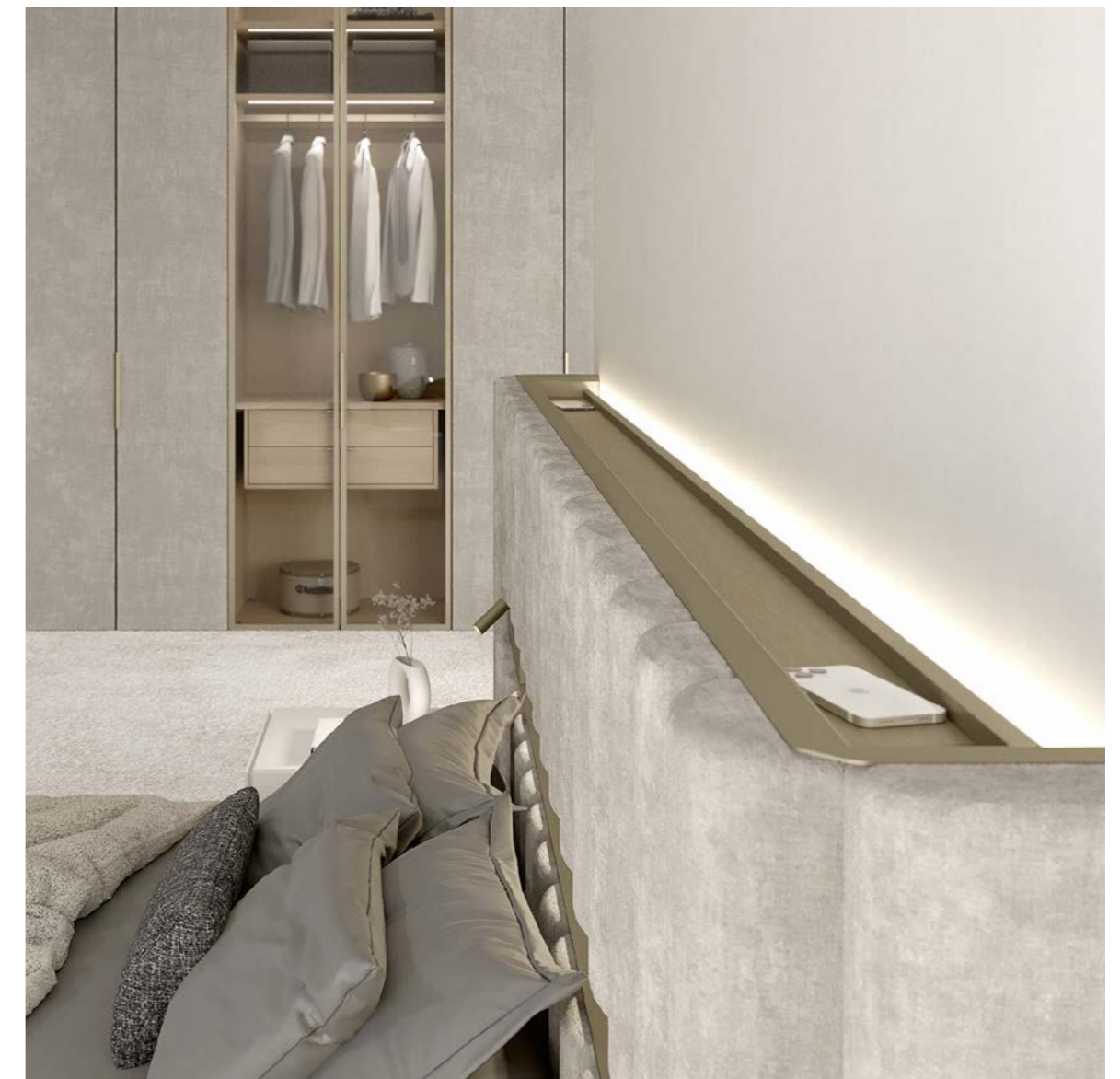





IT - Letto DRESS CODE con testata imbottita in Canvas Topo e boiserie superiore in rovere Grigio 10:2.

EN - DRESS CODE bed with upholstered headboard in Canvas Topo and upper boiserie in Gray oak 10:2.

FR - Lit DRESS CODE avec tête de lit rembourrée en Canvas Topo et boiserie supérieure en chêne Grigio 10:2.

ES - Cama DRESS CODE con cabecera tapizada en Canvas Topo y boiserie superior en Roble Grigio 10:2.





IT - Dettaglio del gruppo letto DRESS CODE in rovere Grigio con struttura Champagne.

EN - Detail of the DRESS CODE bed group in Gray oak with Champagne structure.

FR - Détail des compléments DRESS CODE en chêne Grigio avec structure Champagne.

ES - Detalle del grupo cama DRESS CODE en roble Gris con estructura Champagne.

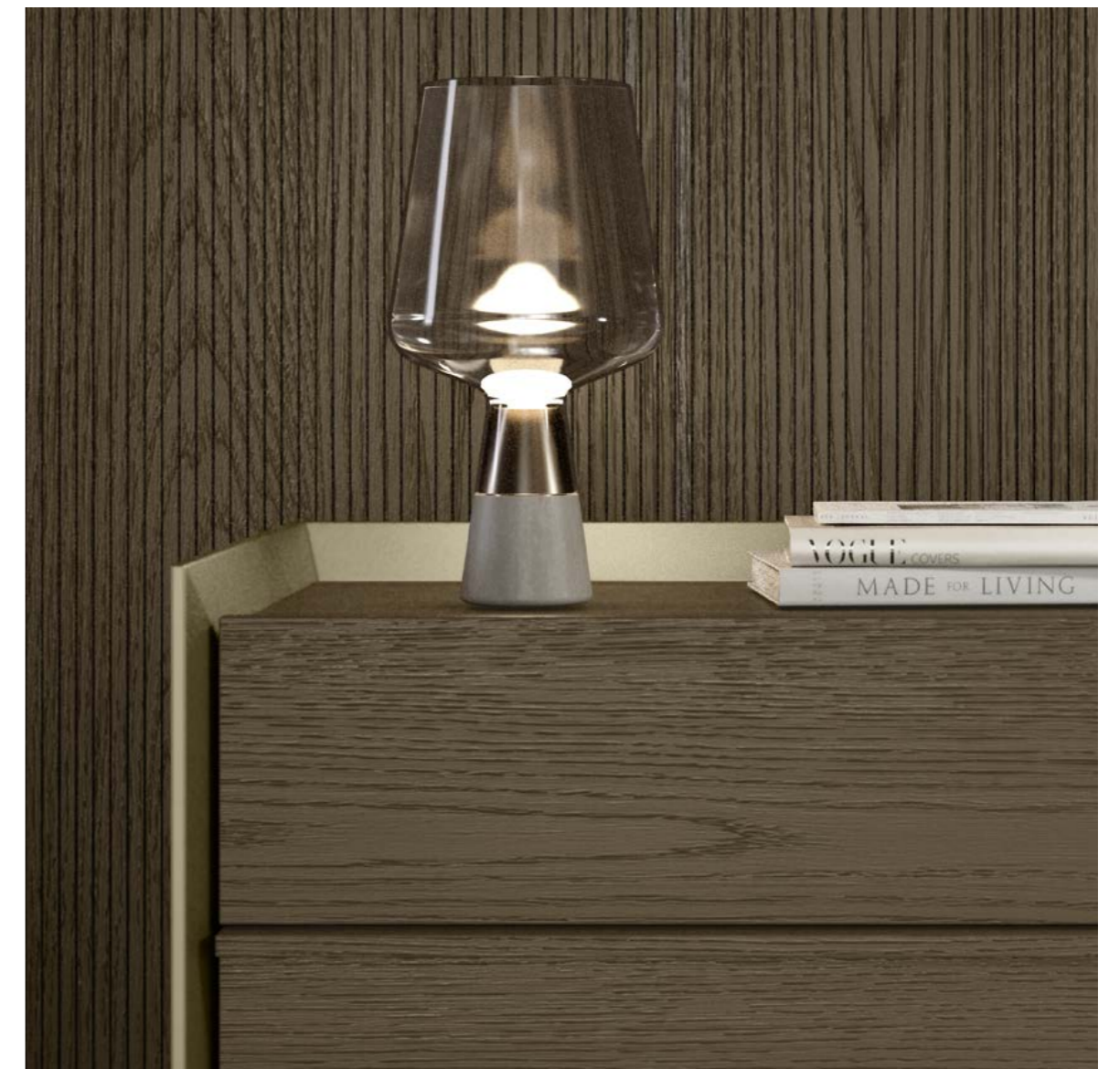





IT - Letto DRESS CODE con testata imbottita in Canvas Titano e nicchia orizzontale laccata Bronzo. Gruppo letto AQUA in laccato Quarzo 10:10 con basamento Bronzo. Nel dettaglio a destra il faretto orientabile.

EN - DRESS CODE bed with upholstered headboard in Canvas Titano and horizontal lacquered Bronzo niche. AQUA bed group in Quarzo 10:10 lacquer finish with Bronzo basement. In detail on the right, the adjustable spotlight.

FR - Lit DRESS CODE avec tête de lit rembourrée en Canvas Titano et niche horizontale laquée Bronzo. Compléments AQUA en laqué Quarzo 10:10 avec piedment Bronzo. Dans le détail à droite le spot led orientable.

ES - Cama DRESS CODE con cabecero tapizado en Canvas Titano y nicho horizontal lacado Bronzo. Grupo de cama AQUA en acabado lacado Quarzo 10:10 con basamento Bronzo. En detalle a la derecha, el foco orientable.





IT - Letto DRESS CODE con testata imbottita in Wool Moro e inserti verticali laccati Bronzo. Gruppo letto DRESS CODE in rovere Moka 10:2 con struttura Bronzo.

EN - DRESS CODE bed with upholstered headboard in Wool Moro and Bronzo lacquered vertical fix panels. DRESS CODE bed group in Moka 10:2 oak with Bronzo structure.

FR - Lit DRESS CODE avec tête de lit rembourrée en Wool Moro et inserts verticaux laqués Bronzo. Compléments DRESS CODE en chêne Moka 10:2 avec structure Bronzo.

ES - Cama DRESS CODE con cabecera tapizada con fijos verticales lacados Wool Moro y Bronzo. Grupo de camas DRESS CODE en roble Moka 10:2 con estructura Bronzo.



Letto Dress Code

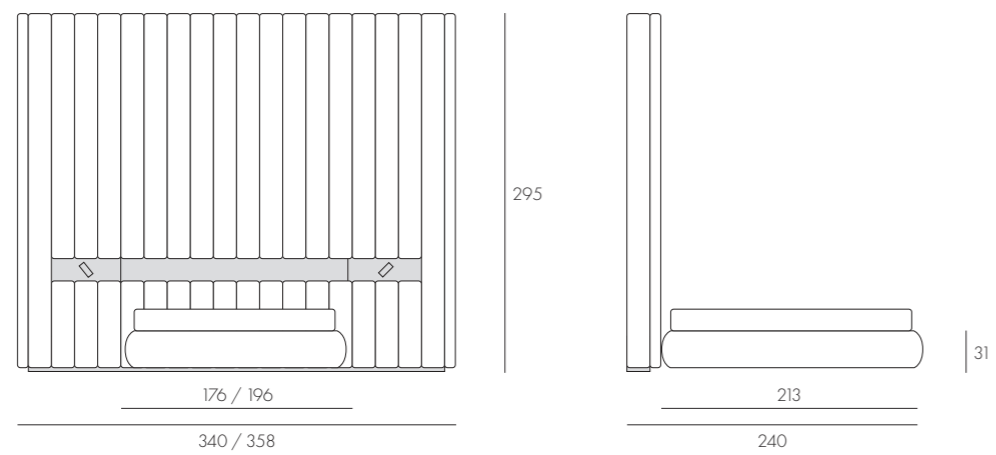
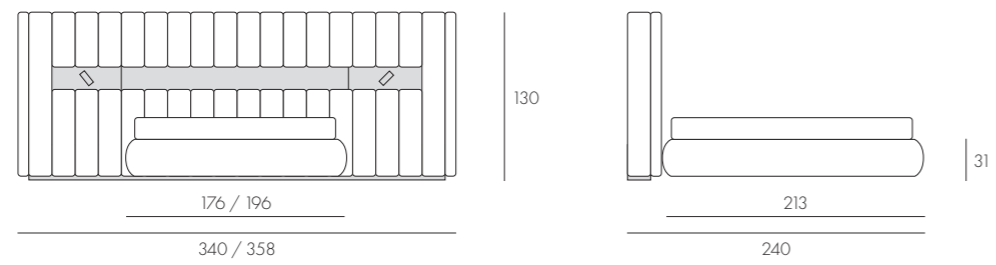
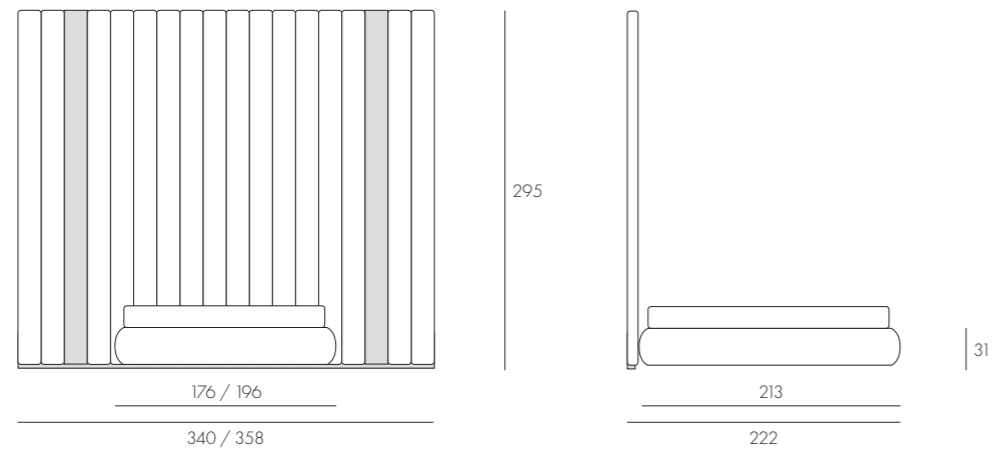
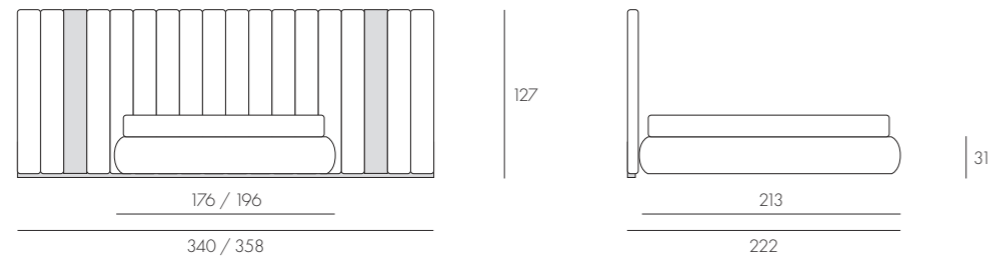

Gruppo Dress Code

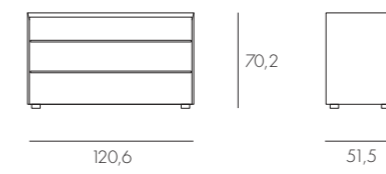



KALÈ

LETTI E GRUPPI

KALÈ — BED COLLECTIONS





IT - Letto KALÈ in rovere Moka con cuscini in tessuto Canvas Luna. Gruppo letto KALÈ in rovere Moka con top in cuoio Moro. A sinistra il dettaglio del retro del letto.

EN - KALÈ bed in Moka oak with pillows in Canvas Luna fabric. KALÈ bed group in Moka oak with cuoio Moro top. On the left, the detail of the bed back.

FR - Lit KALÈ en chêne Moka avec coussins tissu Canvas Luna. Compléments lit KALÈ en chêne Moka avec top en cuoio Moro. A gauche le détail de la partie derrière du lit.

ES - Cama KALÈ en roble Moka con cojines en tejido Canvas Luna. Grupo cama KALÈ en roble Moka con encimera en cuoio Moro. A la izquierda, el detalle del respaldo de la cama.





IT - Gruppo letto KALÈ in rovere Moka con top in cuoio Moro.

EN - KALÈ bed group in Moka oak with cuoio Moro top.

FR - Compléments KALÈ en chêne Moka avec top en cuir Moro.

ES - Grupo cama KALÈ en roble Moka con encimera en cuoio Moro.



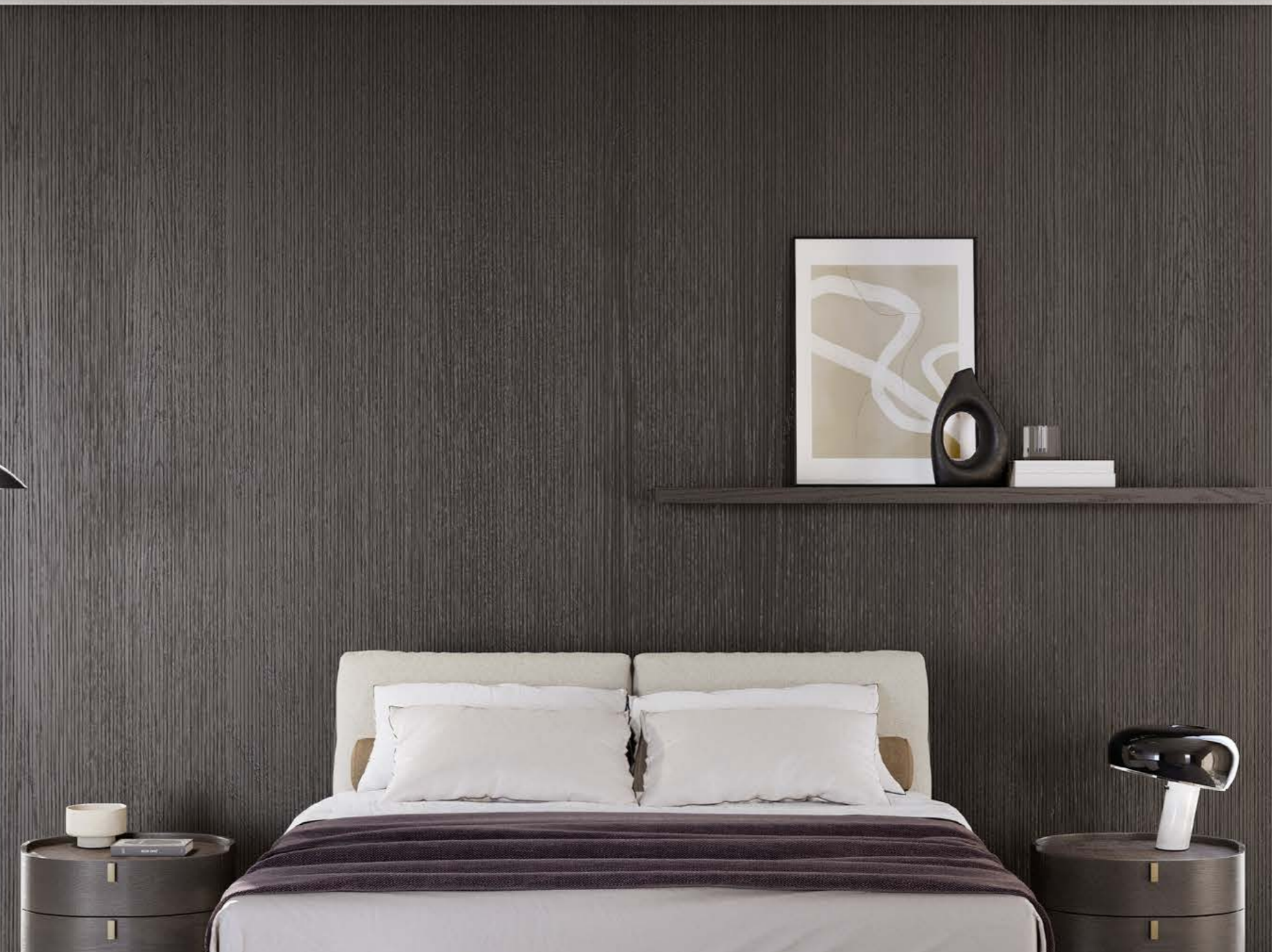

IT - Letto KALÈ in rovere Carbon con cuscini in tessuto Wool Bianco. Gruppo letto KALÈ in rovere Carbon con top in cuoio Moro.

EN - KALÈ bed group in oak Carbon with pillows fabric Wool Bianco. KALE bed group in oak Carbon with cuoio Moro top.

FR - Lit KALÈ en chene Carbon avec coussins en tissu Wool Bianco. Compléments KALÈ en chene Carbon avec top en cuoio Moro.

ES - Cama KALÈ en roble Carbón con cojines en tejido Wool Bianco. Grupo cama KALÈ en roble Carbón con encimera en cuoio Moro.







IT - Gruppo letto KALÈ in rovere Carbon con top in rovere.
A sinistra il dettaglio dello scrittoio con cassetto apribile.

EN - KALÈ bed group in Carbon oak with oak top. On the left, the detail of the writing desk with an opening drawer.

FR - Compléments KALÈ en chêne Carbon avec top en chêne. A gauche le détail du bureau avec tiroir ouvrant.

ES - Grupo cama KALÈ en roble Carbon con encimera de roble. A la izquierda, el detalle del escritorio con cajón apribile.







Letto Kalè

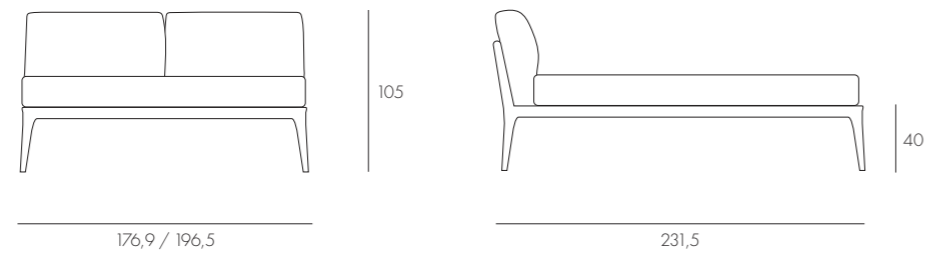

Gruppo Kalè

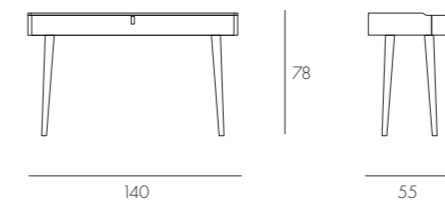
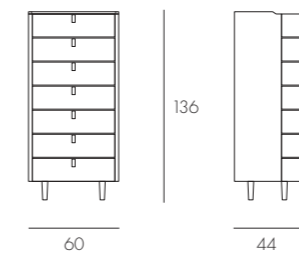
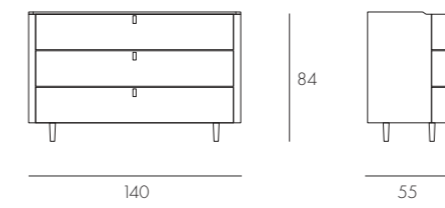
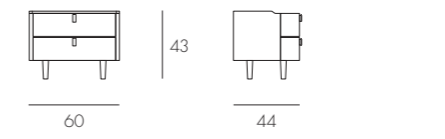



ANDREA

LETTI E GRUPPI

ANDREA — BED COLLECTIONS



A bed with a dark, textured headboard, a red blanket, and white pillows. The bed is positioned against a wall with a vertical ribbed texture.

A floor lamp with a square, light-colored shade, positioned near the bed.

A bedside table lamp with a square, light-colored shade, positioned on a dark bedside table.

A dark, modern bedside table with a light-colored drawer, positioned next to the bed.

A dark, low-profile table with decorative objects, including a vase and a book, positioned near the large window.

A large, dark, textured rug covering the floor in the foreground.



IT - Letto ANDREA in rovere Carbon con cuscini in Canvas Caffè. A sinistra dettaglio del comodino con struttura in rovere Carbon e cassetti in laccato fango opaco.

EN - ANDREA bed in Carbon oak with pillows in Canvas Caffè. On the left, detail of the bedside table with structure in Carbon oak and matt Fango lacquered drawers.

FR - Lit ANDREA en chêne Carbon avec coussins en Canvas Caffè. A gauche détail de la table de nuit avec structure en chêne Carbon et tiroirs en laqué Fango opaco.

ES - Cama ANDREA en roble Carbón con cojines en Canvas Caffè. A la izquierda, detalle de la mesita de noche con estructura en Roble Carbón y cajones lacados mate Fango.



IT - Comò ANDREA in rovere Carbon e cassetti in laccato Fango opaco.

EN - ANDREA chest of drawers in Carbon oak and matt Fango lacquered drawers.

FR - Commode ANDREA en chene Carbon et tiroir en laqué Fango opaco.

ES - Cajonera ANDREA en roble Carbón y cajones lacados mate Fango.







IT - Letto ANDREA in rovere Visone con cuscini in Mumble Sabbia. A sinistra dettaglio del comodino con struttura in rovere Visone e cassetti in laccato lino opaco.

EN - ANDREA bed in Visone oak with pillows in Mumble Sabbia. On the left, detail of the bedside table with structure in Visone oak and matt Lino lacquered drawers.

FR - Lit ANDREA en chêne Visone avec coussins en Mumble Sabbia. A gauche détail de la table de nuit avec structure en chêne Visone et tiroirs en laqué lino opaco.

ES - Cama ANDREA en roble Visone con cojines en Mumble Sabbia. A la izquierda, detalle de la mesita de noche con estructura en roble Visone y cajones lacados lino mate.

IT - Settimanale ANDREA con struttura in rovere Visone e cassetti in laccato lino opaco.

EN - ANDREA tall chest of drawers with structure in Visone oak and matt lino lacquered drawers.

FR - Semainier ANDREA avec structure en chêne Visone et tiroirs en laqué lino opaco.

ES - ANDREA cajonera alta con estructura en roble Visone y cajones lacados lino mate.



Letto Andrea

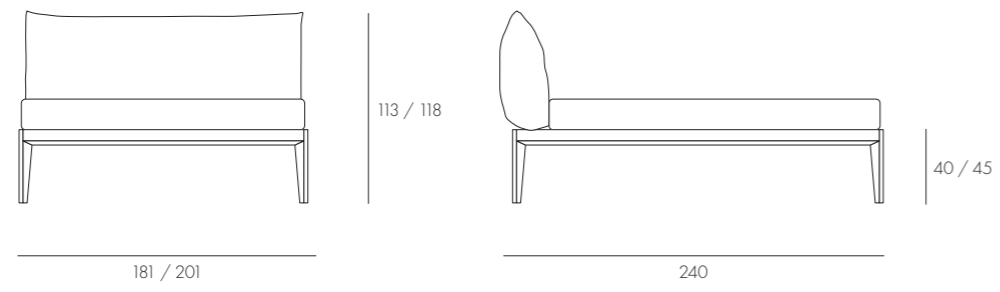

Gruppo Andrea

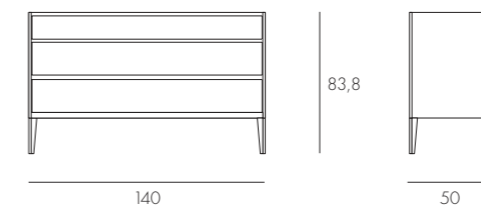
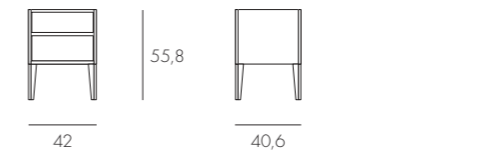



MARTIN

LETTI E GRUPPI

MARTIN — BED COLLECTIONS





IT - Letto MARTIN Soft in Grafite opaco con cuscini Canvas Topo. Gruppo letto Aqua in Grafite opaco.

EN - MARTIN Soft bed in matt Grafite with Canvas Topo pillows. Aqua bed group in matt Grafite.

FR - Lit MARTIN Soft en Grafite opaco avec coussins Canvas Topo. Compléments Aqua en Grafite opaco.

ES - MARTIN Cama Soft en Grafite mate con cojines Canvas Topo. Grupo de cama Aqua en Grafite mate.





IT - Dettaglio del settimanale
AQUA in Grafite opaco.

EN - Detail of the tall chest of
drawer AQUA in matt graphite.

FR - Détail du meuble haut
AQUA en Grafite opaco.

ES - Detalle de la cajonera
alta AQUA en Grafite mate.





IT - Letto MARTIN Canapa opaco. Gruppo letto con struttura e maniglia Canapa opaco e cassetti lino opaco.

EN - MARTIN bed Canapa matt. Bed group structure and handle with matt Canapa and matt lino drawers.

FR - Lit MARTIN Canapa opaco. Compléments lit avec structure et poignée Canapa opaco et tiroirs lino opaco.

ES - Cama MARTIN Canapa mate. Grupo cama con estructura y tirador Canapa mate y cajones lino mate.



IT - Dettaglio del comò MARTIN con struttura e maniglia Canapa opaco e cassetti Lino opaco.

EN - Detail of the MARTIN chest of drawers with structure and handle matt Canapa and matt Lino drawers.

FR - Détail du commode MARTIN avec structure et poignée Canapa opaco et tiroirs Lino opaco.

ES - Detalle de la cajonera MARTIN con estructura y tirador Canapa mate y cajones Lino mate.



Letto Martin

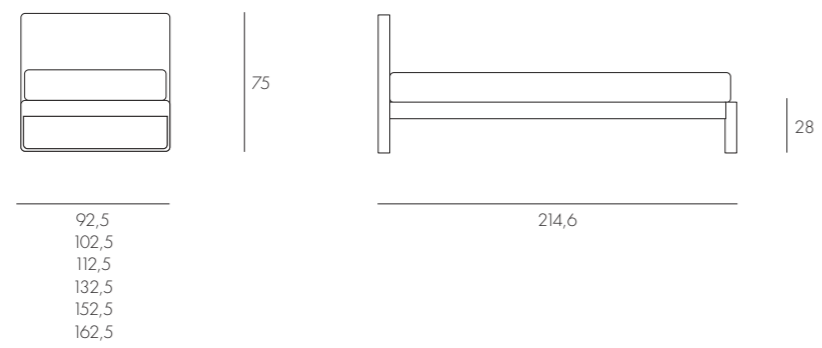
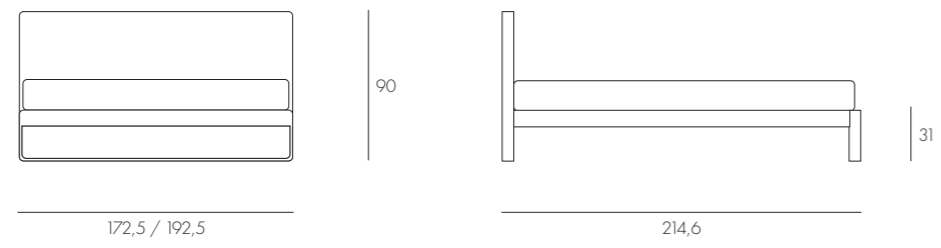
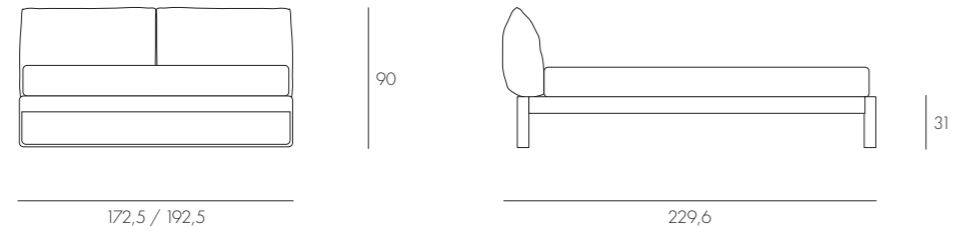

Gruppo Martin

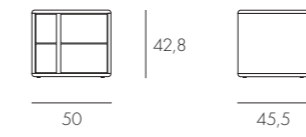



LEONARDO

LETTI E GRUPPI

LEONARDO — BED COLLECTIONS





IT - Letto e gruppo letto
LEONARDO in rovere Carbon.

EN - LEONARDO bed and
bed group in Carbon oak.

FR - Lit et collection
LEONARDO en chêne
Carbon.

ES - Cama LEONARDO y
grupo cama en roble Carbon.





IT - letto e gruppo letto
LEONARDO in rovere Grigio.

EN - LEONARDO bed and
bed group in Grigio oak.

FR - Lit et groupe LEONARDO
en chene Grigio.

ES - Cama LEONARDO y
grupo cama en roble Grigio.



IT - Dettaglio del comodino
LEONARDO in rovere Grigio.

EN - Detail of LEONARDO bedside
table in Grigio oak.

FR - Détail de la table de nuit
LEONARDO en chene Grigio.

ES - Detalle de la mesita de noche
LEONARDO en roble Grigio.



IT - Dettaglio del comò LEONARDO
in rovere Grigio.

EN - Detail of the LEONARDO chest
of drawers in Grigio oak.

FR - Détail du commode LEONARDO
en chene Grigio.

ES - Detalle de la cajonera
LEONARDO en roble Grigio.



Letto Leonardo

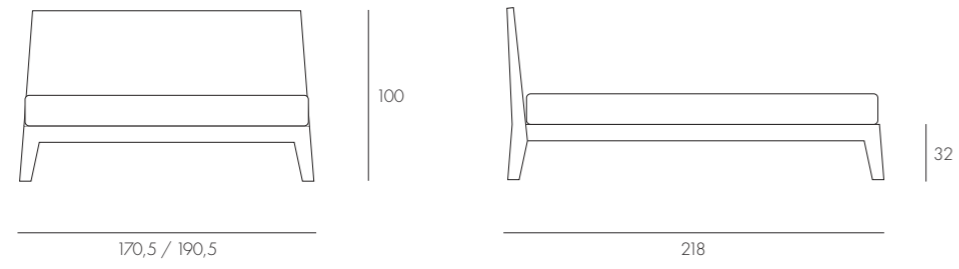

Gruppo Leonardo





AQUA NIGHT

LETTI E GRUPPI

AQUA NIGHT — BED COLLECTIONS



IT - Gruppo letto AQUA in lino 10:10 con base Champagne.

EN - Bed group AQUA in lino 10:10 with Champagne basement.

FR - Collection AQUA en lino 10:10 avec piedment Champagne.

ES - Grupo de cama AQUA en lino 10:10 con base Champagne.





IT - Dettaglio del settimanale e del comodino AQUA in laccato opaco.

EN - Detail of the high unit and night stand AQUA in matt lacquered.

FR - Détail du meuble haut et table de nuit AQUA en laqué mat.

ES - Detalle de la cajonera alta y de la mesilla de noche AQUA en laca mate.





Gruppo Aqua Night

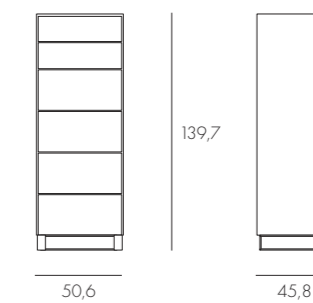
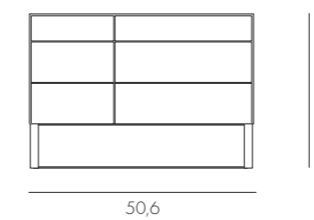
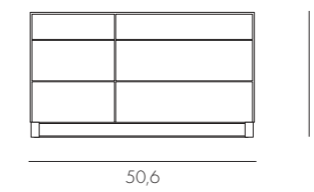
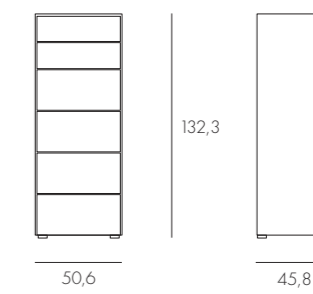
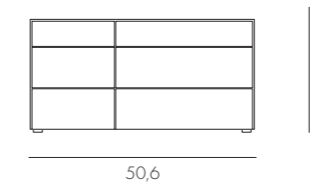
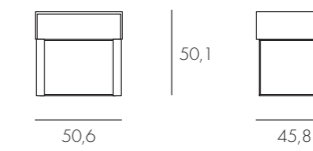
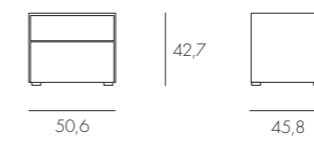
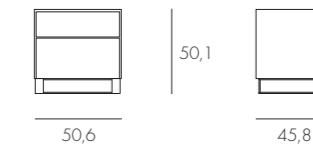
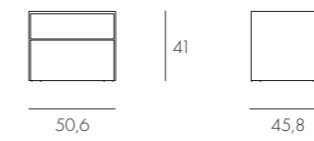



GINEVRA

LETTI E GRUPPI

GINEVRA — BED COLLECTIONS



IT - Gruppo letto GINEVRA in rovere Grigio.
EN - GINEVRA bed group in Grigio oak.
FR - Collection GINEVRA en chene Grigio.
ES - Grupo de cama GINEVRA en roble Grigio.





Gruppo Ginevra

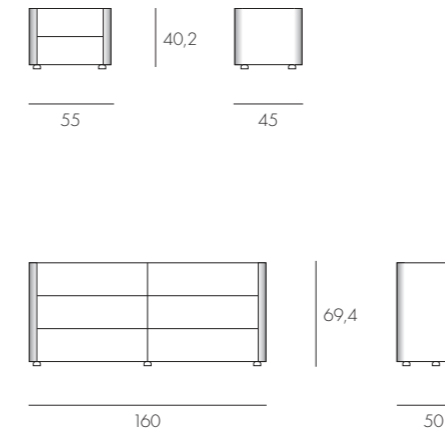

COMPLEMENTI NOTTE

NIGHT COMPLEMENTS



ISOLA ICON

COMPLEMENTI NOTTE

ICON ISLAND — NIGHT COMPLEMENTS





IT - Isola ICON centro stanza in rovere Light con seduta estraibile in Canvas Luna.

EN - ICON freestanding island in Light oak with pull-out seat in Canvas Luna.

FR - Îlot ICON double-face en chêne Light avec assise amovible en Canvas Luna.

ES - Isla independiente ICON en roble Claro con asiento extraíble en Canvas Luna.





IT - Isola ICON in rovere
Moka con accessorio porta
gioielli elettronico in velluto.

EN - ICON island in Moka
oak with electronic jewelry
holder accessory in velvet.

FR - Îlot ICON en chêne Moka
avec accessoire porte-bijoux
électronique en velour.

ES - Isla ICON en roble
Moka con accesorio joyero
electrónico en terciopelo.



Isola Icon

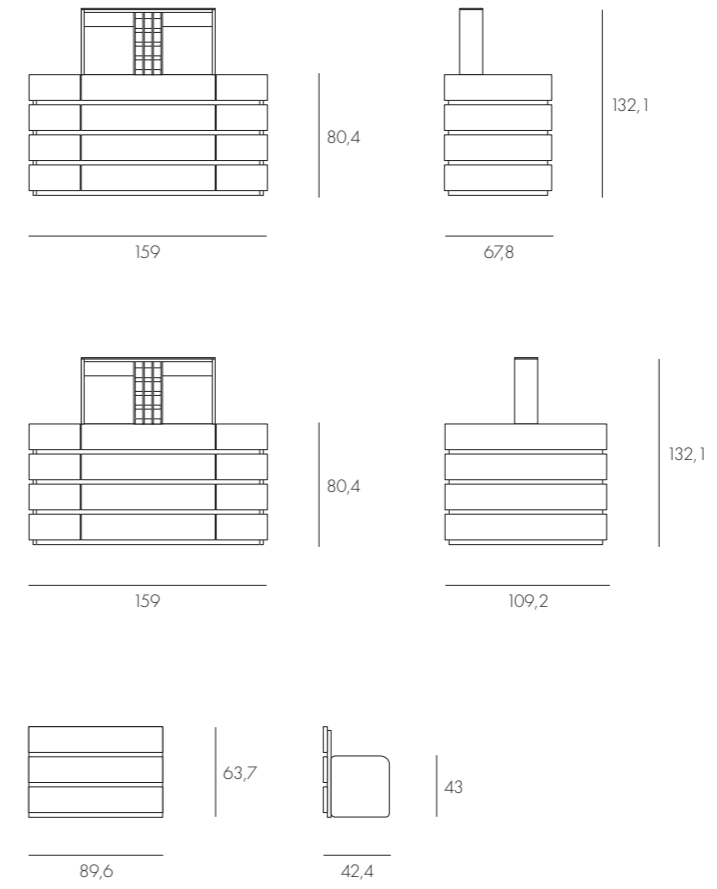



ISOLA LOFT

COMPLEMENTI NOTTE

LOFT ISLAND — NIGHT COMPLEMENTS



IT - Isola LOFT centro stanza
in Royal con maniglia cuoio
Moro e cassetto superiore con
griglia in Canapa opaco.

EN - LOFT freestanding island
in Royal with cuoio Moro
handle and upper drawer with
matt Canapa grid tray.

FR - Ilot LOFT double-face en
Royal avec poignée cuoio
Moro et tiroir supérieur avec
grille en Canapa opaco.

ES - Isla independiente LOFT
en Royal con tirador en cuoio
Moro y cajón superior con
parrilla Canapa mate.



IT - Dettaglio della griglia in laccato Canapa con fondo in cuoio Corda.

EN - Detail of the grid in Canapa lacquer with bottom in cuoio Corda.

FR - Détail de la grille en laqué Canapa avec fond en cuoio Corda.

ES - Detalle de la parrilla en laca Canapa con fondo en cuoio Corda.





IT - Isola LOFT in rovere
Wengè con seduta in
Canvas Topo.

EN - LOFT island in Wengé
oak with seat in Canvas
Topo.

FR - Îlot LOFT en chêne
Wengé avec siège en
Canvas Topo.

ES - Isla LOFT en roble
Wengé con asiento en
Canvas Topo.



Isola Loft

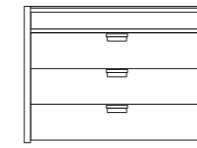

47 / 67 / 87 / 107

78,5
98,5



53,6 / 100

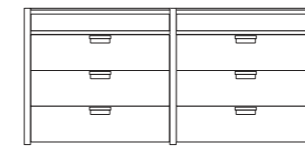

90,5 / 130,5 / 170,5 / 210,5

78,5
98,5



53,6 / 100

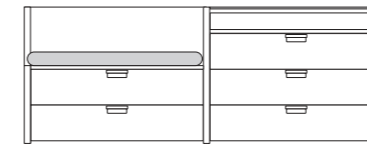

130,5

78,5
98,5

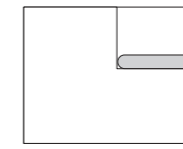

100

43,5

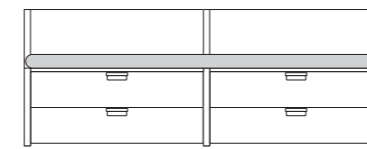

130,5

78,5
98,5

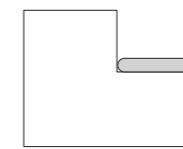

100

43,5



VANITY

COMPLEMENTI NOTTE

VANITY — NIGHT COMPLEMENTS





IT - Scrivania "Make up" VANITY in laccato Nocciola opaco con cornice in rovere Moka.

EN - "Make up" desk VANITY in lacquered Nocciola matt with Moka oak frame.

FR - Meuble "Maquillage" VANITY en laque mate Nocciola avec sous-top en chêne Moka.

ES - Escritorio "Make-up" VANITY lacado Nocciola mate con marco en roble Moka.





IT - VANITY sospeso
in rovere Grigio.

EN - Wall-hung VANITY
in Grigio oak.

FR - VANITY suspendu
en Grigio.

ES - MUEBLE suspendido
en roble Grigio.



Vanity

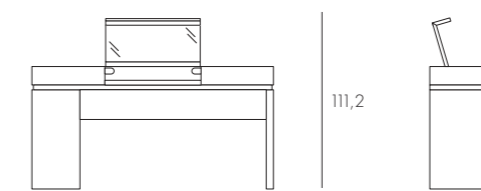
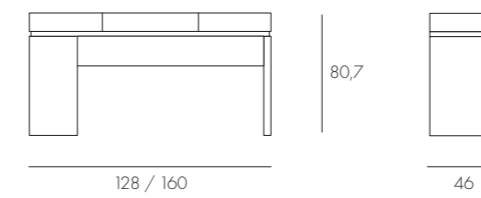

Vanity sospeso

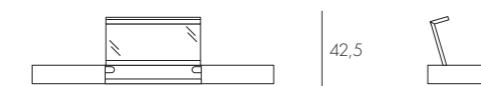
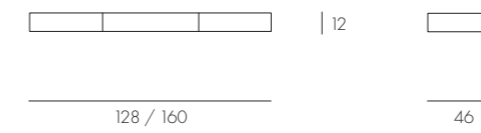



DESK

COMPLEMENTI NOTTE

DESK — NIGHT COMPLEMENTS



IT - Scrivania DESK in laccato Fango opaco con cornice in rovere Carbon.

EN - DESK in matt Fango lacquer with Carbon oak frame.

FR - Bureau DESK en laqué Fango opaco avec corniche en chêne Carbon.

ES - Escritorio DESK en lacado Fango mate con estructura en roble Carbon.





IT - DESK sospeso
in rovere Fumo.

EN - Floating DESK
in Fumo oak.

FR - Bureau DESK
suspendu
en chene Fumo.

ES - Escritorio DESK
suspendido
en roble Fumo.



Desk

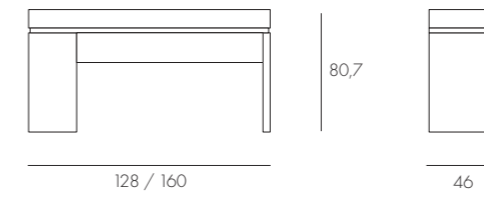

Desk sospeso



Project

MICHELE SARTINI

Project Assistant

ALESSIA TACCONI

Art Direction

LUALDI MERALDI STUDIO

Graphic Design

OFFICINE BONFIGLIOLI

Produzione 3D Rendering

TRUETOPIA
OFFICINE BONFIGLIOLI

Fotolito

LIFEINPIXEL

Stampa

PAZZINI STAMPATORE EDITORE

