

# New products 2025



OPINION CIATTI®  
FIRENZE

# Novità / News 2025

## prodotti / products



**Axis system**  
pag. 2



**Axis table**  
pag. 12



**Nigelle**  
pag. 16

## aggiornamenti / updates



**ILletto outdoor**  
pag. 20



**Con.tradition**  
pag. 22



**La Cima**  
pag. 23

## Axis

Original design by Bruno Pozzi and Marco Duina, 1985. Updated by Lapo Ciatti, 2025.



IT Cucina disaggregata con struttura in acciaio inox, ideale per uso indoor/outdoor. Disponibile in tre misure, con varie possibilità di composizioni.

Piedini regolabili.

Finiture struttura e accessori in acciaio inox: acciaio inox satinato, beige, nero; malta ecologica (Corkcrete) beige.

Finiture piani: materiale ecologico bianco o nero, malta ecologica (Corkcrete) beige. Opzione sovratap in acciaio inox satinato.

Accessori:

- Gamba in acciaio inox per sostenere top con sbalzo superiore a 50 cm.
- Alzatine con o senza griglia in acciaio inox.
- Mensola in acciaio inox.
- Ripiano sospeso.
- Carter sifone e isola copri tubi in acciaio inox.
- Selezione di elettrodomestici, vasche e rubinetti per uso outdoor.

EN Modular Kitchen with stainless steel structure, for indoor/outdoor use.

Available in three sizes with various composition possibilities. Adjustable feet.

Structure and stainless steel accessory finishes: satin stainless steel, beige, black; eco-friendly mortar (Corkcrete) in beige.

Top finishes: eco-friendly white or black material, eco-friendly mortar (Corkcrete) in beige. Top overlay in satin stainless steel.

Accessories:

- Stainless steel leg to support overhanging tops over 50 cm.
- Backsplashes with or without hanging grid in steel.
- Stainless steel shelf.
- Suspended shelf.
- Siphon cover and pipe cover island in stainless steel.
- Selection of appliances, sinks and faucets for outdoor use.

FR Cuisine modulaire avec structure en acier inoxydable idéale pour une utilisation intérieure/extérieure. Disponible en trois tailles avec diverses possibilités de composition. Pieds réglables.

Finitions de la structure et des accessoires en métal : acier inox satiné, beige, noir; mortier écologique (Corkcrete) beige.

Finitions des plateaux : matériau écologique blanc ou noir, mortier écologique (Corkcrete) beige. Option surplan en acier inox satiné.

Accessoires :

- Pied en acier inoxydable pour soutenir les plateaux en porte-à-faux de plus de 50 cm.
- Dosserets avec ou sans grille suspendue en acier.
- Étagère en acier inoxydable.
- Étagère suspendue.
- Cache-siphon et île couvre-tuyaux en acier inoxydable.
- Sélection d'électroménagers, éviers et robinets pour usage extérieur.

DE Modulare Küche mit Edelstahlstruktur, für Innen- und Außenbereich. Erhältlich in drei Größen mit verschiedenen Gestaltungsmöglichkeiten. Verstellbare Füßen.

Ausführungen der Struktur und Metallzubehör: satiniertes Edelstahl, Beige, Schwarz; ökologischer Mörtel (Corkcrete) in Beige.

Ausführungen für Arbeitsplatten: umweltfreundliches Material in Weiß oder Schwarz, ökologischer Mörtel (Corkcrete) in Beige.

Zusätzliche Option: Arbeitsplatte aus satiniertem Edelstahl.

Zubehör:

- Edelstahlbein zur Unterstützung von überhängenden Arbeitsplatten über 50 cm.
- Wandabschlussprofil mit oder ohne Aufhängegitter aus Stahl.
- Edelstahlregal.
- Hängendes Regal.
- Siphonabdeckung und Rohrverkleidungsinsel aus Edelstahl.
- Auswahl an Haushaltsgeräten, Spülen und Wasserhähne für den Außenbereich.

## STRUTTURE / STRUCTURES

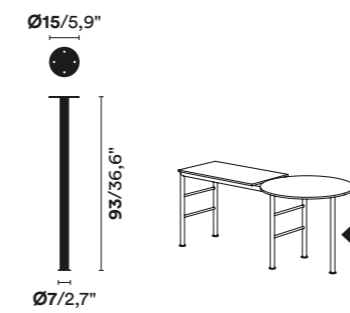
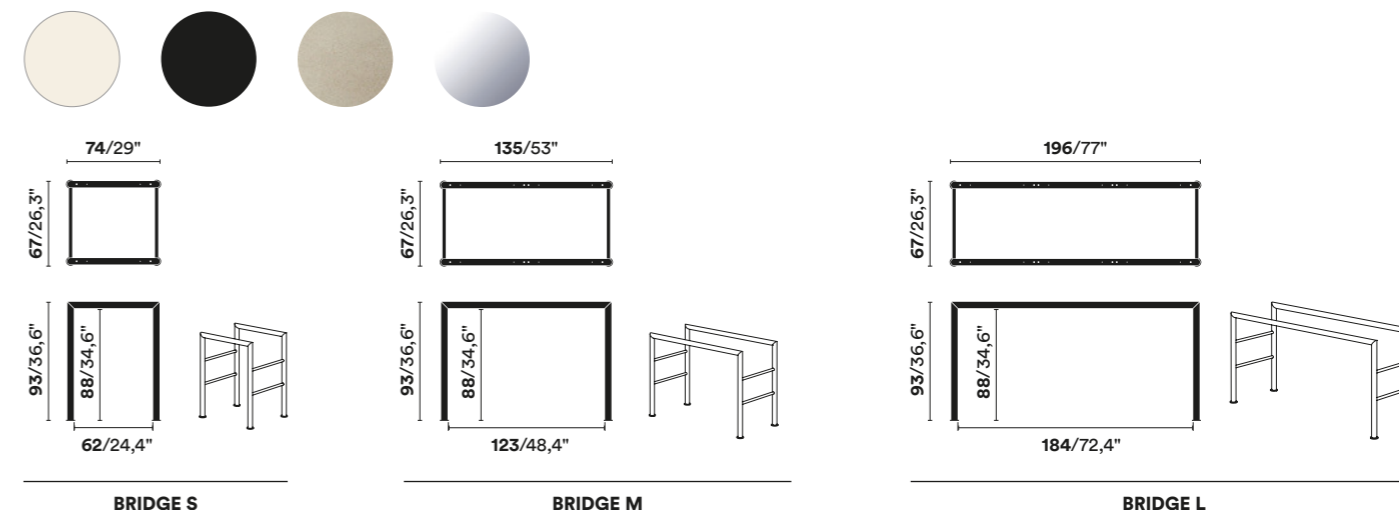

**LEG**  
solo per top con sbalzo > 50 cm  
only for tops with an overhang > 50 cm

## PIANI CUCINA / WORKTOPS

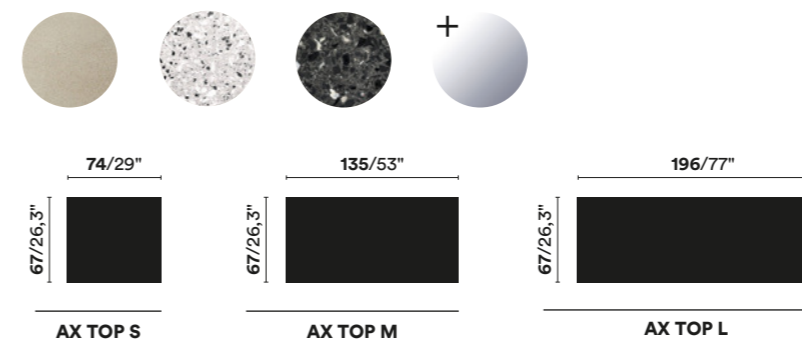

## PIANI CUCINA PER COMPOSIZIONI A ISOLA / WORKTOPS FOR ISLAND CONFIGURATIONS

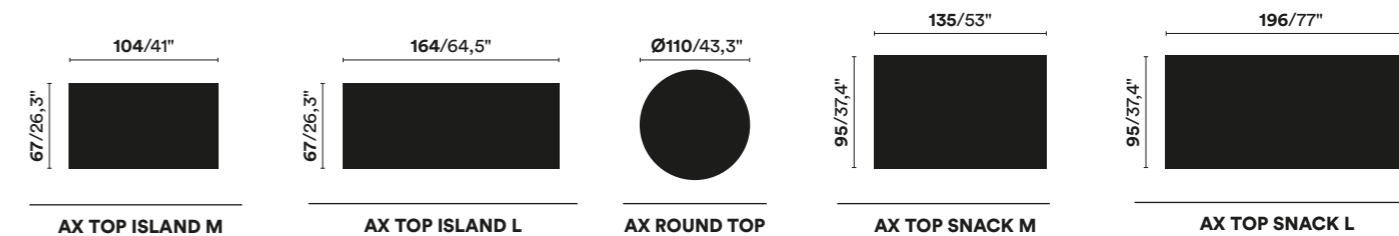

Tutti i piani hanno uno spessore di 2 cm.  
All the tops are 2 cm (8,7") thick.  
Tous les plateaux ont une épaisseur de 2 cm.  
Alle Platten sind 2 cm dick.

Il sovratap in acciaio inox ha uno spessore di 1,5 mm (si sovrappone al top di 2 cm).  
The top overlay in stainless steel has a thickness of 1,5 mm (it overlaps the 2 cm top).  
Le surplan en acier inoxydable a une épaisseur de 1,5 mm (il se superpose au top de 2 cm).  
Die Arbeitsplattenaufgabe aus Edelstahl hat eine Dicke von 1,5 mm" (es überlappt die 2 cm Platte).

## Note

L'altezza del ponte permette l'inserimento di elettrodomestici freestanding.

The height of the bridge allows the installation of freestanding appliances.

La hauteur de la structure permet l'installation des appareils électroménagers autonomes.

Die Höhe der Struktur ermöglicht das Einsetzen von freistehenden Geräten.

La finitura Corkcrete è una speciale malta ecologica risultante da una combinazione di sughero e resine naturali a base d'acqua.

Corkcrete is a special ecological mortar resulting from a combination of cork and water-based natural resins.

Corkcrete est un mortier écologique spécial résultant de la combinaison de liège et de résines naturelles à base d'eau.

Corkcrete ist ein Ökologischer Spezialmörtel aus einer Kombination von Kork und Naturharzen auf Wasserbasis.

Il materiale ecocompatibile del piano proviene dal riciclo della vetroresina e dei suoi componenti. Si tratta quindi di un pannello double-green perché riciclato al 100% e riciclabile a fine vita.

The eco-friendly material of the table top is made from recycled fiberglass and its components. It is therefore a totally green panel because it is 100% recycled, as well as recyclable at the end of its life.

Le matériau écologique utilisé pour le plateau est obtenu du recyclage de la fibre de verre et de ses composants. Il s'agit donc d'un plateau double-green 100% recyclé et recyclable en fin de cycle de vie.

Das umweltfreundliche Material der Tischplatte stammt aus dem Recycling von GFK-Kunststoff und dessen Bestandteilen. Es handelt sich daher um eine double-green Tischplatte, da sie zu 100% aus recyceltem Material besteht und am Ende der Lebenszeit erneut recycelt werden kann.

**ACCESSORI / ACCESSORIES**

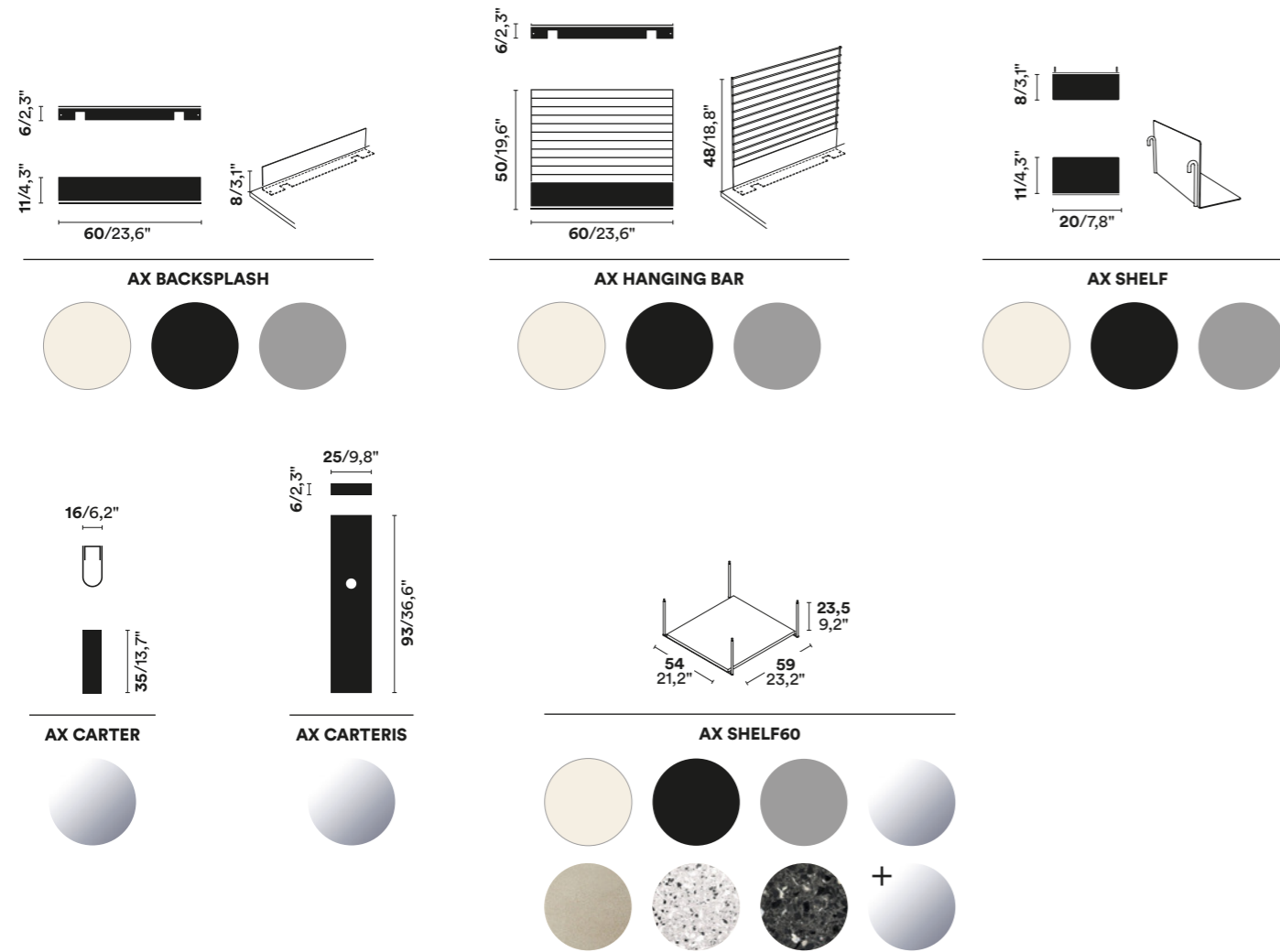

**COMPOSIZIONI / CONFIGURATIONS**

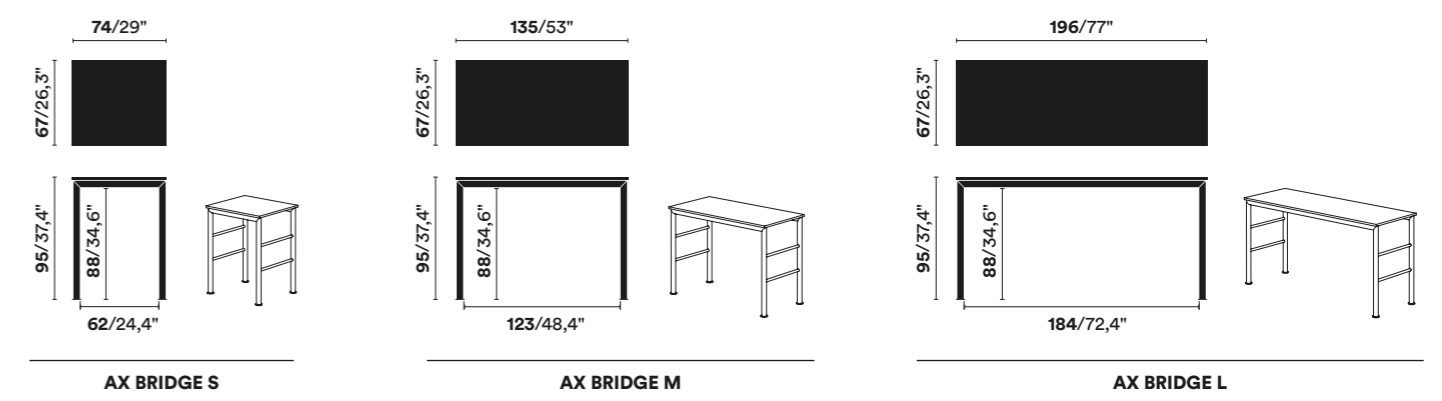

**COMPOSIZIONI: AXIS SNACK / CONFIGURATIONS: AXIS SNACK**

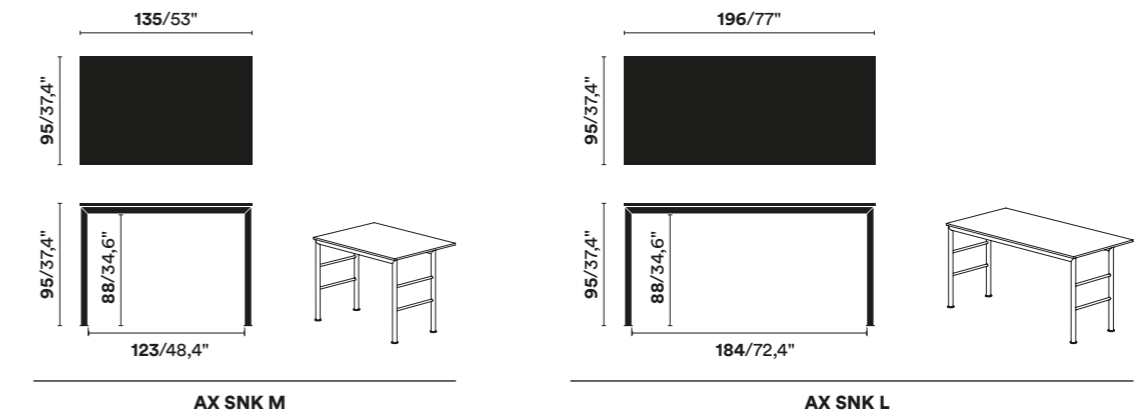

**COMPOSIZIONI: ISOLE CON TOP TONDO / CONFIGURATIONS: ISLANDS WITH ROUND TOP**

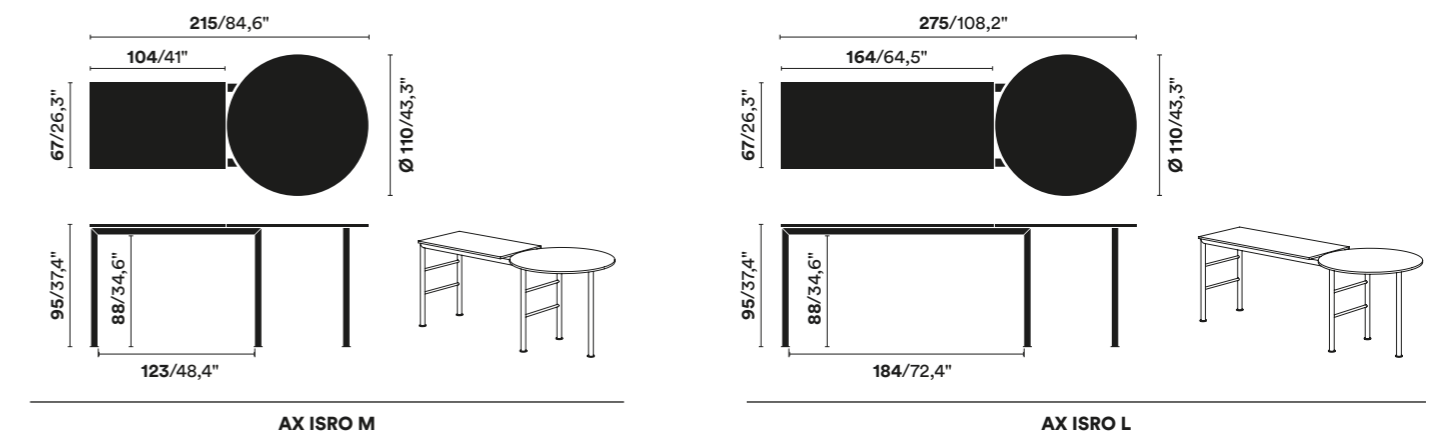

**COMPOSIZIONI: ISOLE CON TOP RETTANGOLARE / CONFIGURATIONS: ISLANDS WITH RECTANGULAR TOP**

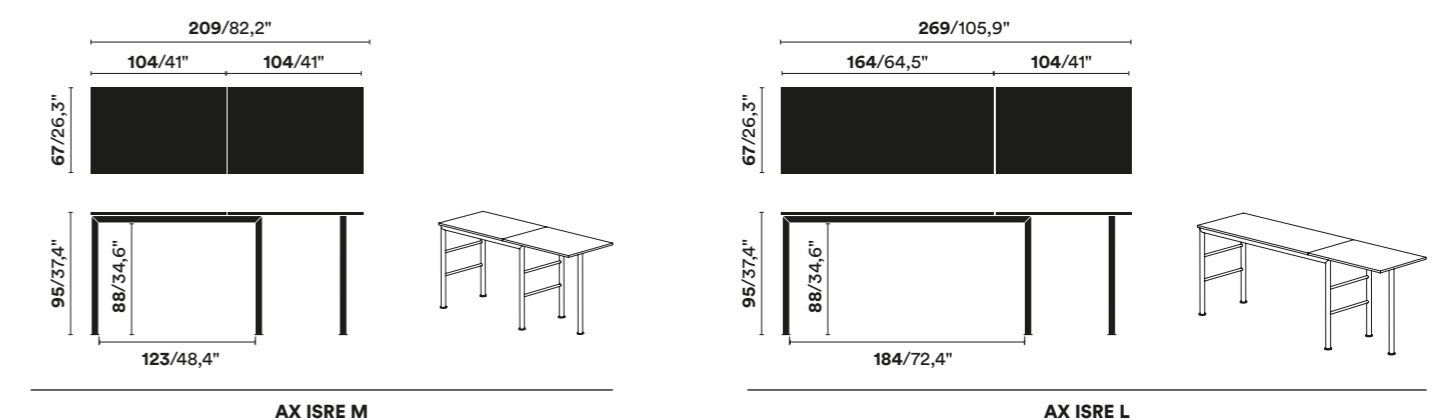



COMPOSITION 1  
Ingombro totale: Larghezza 135 cm, profondità 67 cm.  
Overall dimensions: Width 135 cm, depth 67 cm.



COMPOSITION 2  
Ingombro totale: Larghezza 196 cm, profondità 67 cm.  
Overall dimensions: Width 196 cm, depth 67 cm.



COMPOSITION 7  
Ingombro totale: Larghezza 209 cm, profondità 67 cm.  
Overall dimensions: Width 209 cm, depth 67 cm.



COMPOSITION 8  
Ingombro totale: Larghezza 269 cm, profondità 67 cm.  
Overall dimensions: Width 269 cm, depth 67 cm.



COMPOSITION 3  
Ingombro totale: Larghezza ~160 cm, profondità 67 cm.  
Overall dimensions: Width ~160 cm, depth 67 cm.



COMPOSITION 4  
Ingombro totale: Larghezza ~275 cm, profondità 67 cm.  
Overall dimensions: Width ~275 cm, depth 67 cm.



COMPOSITION 9  
Ingombro totale: Larghezza 135 cm, profondità 95 cm.  
Overall dimensions: Width 135 cm, depth 95 cm.



COMPOSITION 10  
Ingombro totale: Larghezza 196 cm, profondità 95 cm.  
Overall dimensions: Width 196 cm, depth 95 cm.



COMPOSITION 5  
Ingombro totale: Larghezza 215 cm, profondità 110 cm.  
Overall dimensions: Width 215 cm, depth 110 cm.



COMPOSITION 6  
Ingombro totale: Larghezza 275 cm, profondità 110 cm.  
Overall dimensions: Width 275 cm, depth 110 cm.



COMPOSITION 11  
Ingombro totale: Larghezza ~400 cm, profondità 67 cm.  
Overall dimensions: Width ~400 cm, depth 67 cm.





**Axis table** Original design by Bruno Pozzi and Marco Duina, 1985. Updated by Lapo Ciatti, 2025.



**IT** Tavolo con struttura a ponte in acciaio inox, disponibile in due dimensioni. Ideale per uso indoor/outdoor con piedini regolabili.  
**Finiture struttura:** acciaio inox satinato, beige, nero, malta ecologica (Corkcrete) beige.  
**Finiture top:** materiale ecologico bianco o nero, malta ecologica (Corkcrete) beige, vetro temperato chiaro o fumè.

**EN** Table with bridge structure in stainless steel, available in two sizes. Ideal for indoor/outdoor use with adjustable feet.  
**Structure finishes:** satin stainless steel, beige, black, ecological mortar (Corkcrete) beige.  
**Top finishes:** eco-friendly material in white or black, ecological mortar (Corkcrete) beige, clear or smoked tempered glass.



**Finiture struttura / Structure finishes**



**Finiture piani / Top finishes**

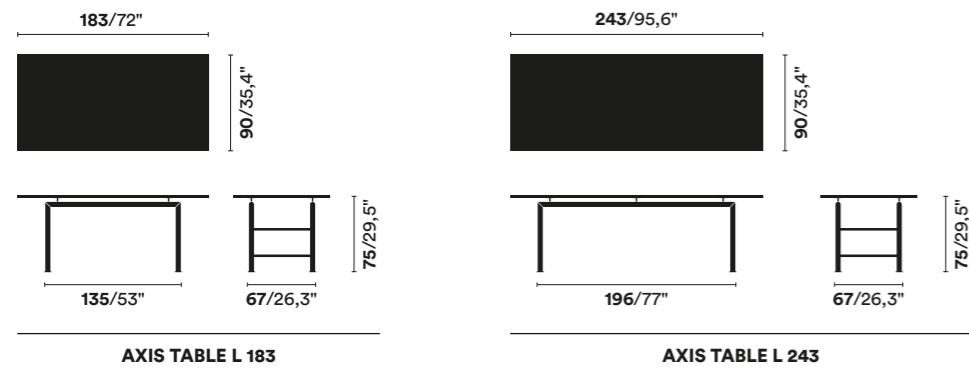

**Note**

La finitura Corkcrete è una speciale malta ecologica risultante da una combinazione di sughero e resine naturali a base d'acqua.  
 Corkcrete is a special ecological mortar resulting from a combination of cork and water-based natural resins.  
 Corkcrete est un mortier écologique spécial résultant de la combinaison de liège et de résines naturelles à base d'eau.  
 Corkcrete ist ein Ökologischer Spezialmörtel aus einer Kombination von Kork und Naturharzen auf Wasserbasis.

Il materiale ecologico del piano proviene dal riciclo della vetroresina e dei suoi componenti. Si tratta quindi di un pannello *double-green* perché riciclato al 100% e riciclabile a fine vita.  
 The eco-friendly material of the table top is made from recycled fiberglass and its components. It is therefore a totally green panel because it is 100% recycled, as well as recyclable at the end of its life.  
 Le matériau écologique utilisé pour le plateau est obtenu du recyclage de la fibre de verre et de ses composants. Il s'agit donc d'un plateau *double-green* 100% recyclé et recyclable en fin de cycle de vie.  
 Das umweltfreundliche Material der Tischplatte stammt aus dem Recycling von GFK-Kunststoff und dessen Bestandteilen. Es handelt sich daher um eine *double-green* Tischplatte, da sie zu 100% aus recyceltem Material besteht und am Ende der Lebenszeit erneut recycelt werden kann.



Struttura in acciaio verniciato beige, top in Corkcrete beige.  
 Beige painted stainless steel structure, top in beige Corkcrete.



Struttura in acciaio inox satinato, top in materiale ecologico bianco.  
 Structure in satin stainless steel, top in white eco-friendly material.



Struttura in acciaio verniciato nero, top in vetro temperato fumè.  
 Black painted stainless steel structure, top in smoked tempered glass.



## Nigelle Maurizio Galante + Tal Lancman, 2025



**IT** Sedia e sgabello in acciaio con struttura a slitta verniciata a polveri, impilabile. Il decoro sulla seduta è ispirato al pizzo toscano e consente il deflusso dell'acqua. Per uso indoor/outdoor. Sedie in confezione da quattro pezzi, sgabelli in confezione da due pezzi.

**Finiture:** verniciatura con protettivo EcoShield\* nei colori beige, grigio chiaro, terracotta, nero.

**Accessori:** Rivestimento di seduta e schienale in tessuto spalmato trapuntato nei colori beige, grigio chiaro, terracotta, nero.

**Cuscino/pad decorato in materiale plastico riciclato, nei colori beige, grigio chiaro, terracotta.**

**EN** Chair and stool in powder-coated sled frame steel, stackable. The seat decoration is inspired by Tuscan lace and allows water drainage. Suitable for indoor/outdoor use. Chairs in a pack of four pieces, stools in a pack of two pieces. **Finishes:** painting with EcoShield\* protective coating in beige, light grey, terracotta, black.

**Accessories:** Upholstered seat and backrest in quilted coated fabric available in beige, light gray, terracotta, black. Cushion/pad in recycled plastic material with decorations. **Finishes:** beige, light gray, terracotta.

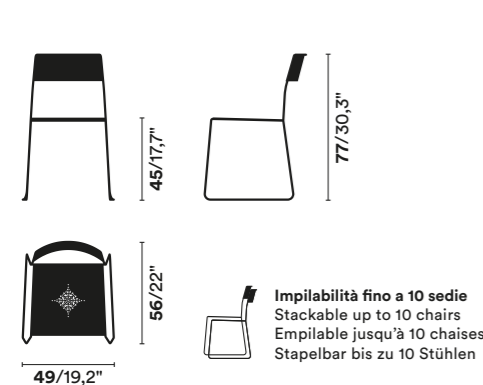

**NIGELLE**

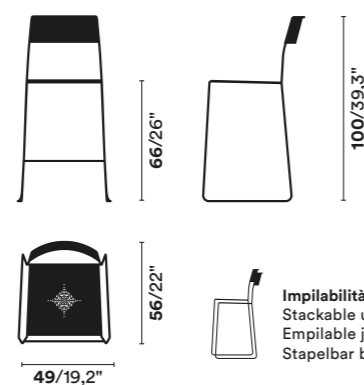

**NIGELLE STOOL**



**NIGELLE DRESS**

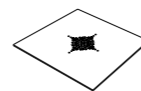

**NIGELLE PAD**

### Note

\*EcoShield: trattamento che garantisce un'eccezionale protezione dalla corrosione dovuta agli agenti atmosferici con vernici all'acqua, riducendo l'impatto ambientale. Il rivestimento ottenuto è duraturo nel tempo, resistendo efficacemente all'usura e al deterioramento.

\*EcoShield: Treatment ensuring exceptional protection against corrosion caused by atmospheric agents, using water-based paints to reduce environmental impact. The resulting coating is durable over time and effectively resists wear and deterioration.

**FR** Chaise et tabouret en acier avec structure traîneau peint par poudrage, empilable. Le décor sur l'assise est inspiré de la dentelle toscane et permet l'écoulement de l'eau. Pour usage intérieur/extérieur. Chaises en lot de quatre pièces, tabourets en lot de deux pièces.

**Finitions :** peinture avec protection EcoShield\* en beige, gris clair, terracotta, noir.

**Accessoires :** Revêtement d'assise et de dossier en tissu enduit et matelassé, disponible en beige, gris clair, terre cuite, noir. Coussin/pad décoré en matériau plastique recyclé, disponible en beige, gris clair, terre cuite.

**DE** Stuhl und Hocker aus Stahl mit pulverbeschichteter Schlittenstruktur, stapelbar. Das Dekor auf der Sitzfläche ist von toskanischer Spitze inspiriert und ermöglicht den Wasserablauf. Für Innen- und Außenbereich geeignet. Stühle im Viererpack, Hocker im Zweierpack.

**Ausführungen:** Lackierung mit EcoShield\*-Schutz in Beige, Hellgrau, Terrakotta, Schwarz.

**Zubehör:** Bezug für Sitzfläche und Rückenlehne aus beschichtetem, dekoriertem und gepolstertem Stoff erhältlich in Beige, Hellgrau, Terrakotta und Schwarz.

**Kissen/Pad aus recyceltem Kunststoffmaterial mit Dekor erhältlich in Beige, Hellgrau und Terrakotta.**







## ILletto outdoor Lapo Ciatti, 2025

**IT** Letto a baldacchino con struttura portante in acciaio completo di materasso realizzato in spugna nautica e schienali reclinabili in cinque posizioni.

Rete in pannello ecologico.

**Finiture struttura:** 213 colori RAL Classic opachi; malta ecologica (Corkcrete) beige. Protettivo EcoShield\*.

**Finiture materasso:** colori bianco o beige.

**Accessori:** tende e tettuccio in tessuto velato per uso indoor/outdoor, colori bianco o beige.

**EN** Canopy bed with a steel supporting frame, complete with a mattress made of marine-grade foam and backrests adjustable to five positions.

Eco-friendly panel bed base.

**Structure finishes:** 213 matte RAL Classic colors; eco-friendly beige mortar (Corkcrete). EcoShield\* protective coating.

**Mattress finishes:** White or beige colors.

**Accessories:** Sheer fabric curtains and canopy for indoor/outdoor use, available in white or beige.

**FR** Lit à baldachin avec structure portante en acier, complet avec matelas en mousse nautique et dossiers inclinables en cinq positions.

Sommier en panneau écologique.

**Finitions de la structure :** 213 couleurs RAL Classic opaques ; mortier écologique beige (Corkcrete). Protection EcoShield\*.

**Finitions du matelas :** Couleurs blanc ou beige.

**Accessoires :** Rideaux et baldachin en tissu vaporeux pour usage intérieur/ extérieur, disponibles en blanc ou beige.

**DE** Himmelbett mit mit Gestell aus Stahl, komplett mit einer Matratze aus nautischem Schaumstoff und Rückenlehnen, die in fünf Positionen verstellbar sind. Lattenrost aus umweltfreundlicher Platte.

**Ausführungen der Struktur:** 213 matte RAL Classic Farben; umweltfreundlicher beige Mörtel (Corkcrete). EcoShield\*-Schutz.

**Ausführungen der Matratze:** Farben Weiß oder Beige.

**Zubehör:** Transparente Stoffvorhänge und Baldachin für den Innen- und Außenbereich, in Weiß oder Beige erhältlich.



**Finiture struttura / Structure finishes**



**Tessuti materasso / mattress fabrics**

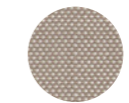

**Tessuti tende e tettuccio / curtains and roof fabrics**

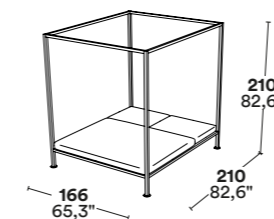

ILL OUT 160

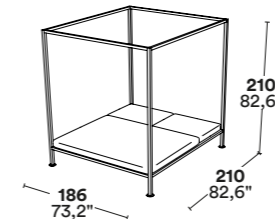

ILL OUT 180

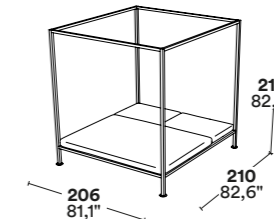

ILL OUT 200

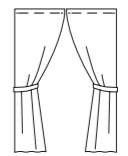

ILL CURTAINS

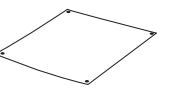

ILL ROOF

### Note

La finitura Corkcrete è una speciale malta ecologica risultante da una combinazione di sughero e resine naturali a base d'acqua. Corkcrete is a special ecological mortar resulting from a combination of cork and water-based natural resins. Corkcrete est un mortier écologique spécial résultant de la combinaison de liège et de résines naturelles à base d'eau. Corkcrete ist ein Ökologischer Spezialmörtel aus einer Kombination von Kork und Naturharzen auf Wasserbasis.

Il materiale ecocompatibile della rete outdoor proviene dal riciclo della vetroresina e dei suoi componenti. Si tratta quindi di un pannello double-green perché riciclato al 100% e riciclabile a fine vita. The eco-friendly material of the outdoor base is made from recycled fiberglass and its components. It is therefore a totally green panel because it is 100% recycled, as well as recyclable at the end of its life. Le matériau écologique utilisé pour le sommier outdoor est obtenu du recyclage de la fibre de verre et de ses composants. Il s'agit donc d'un plateau double-green 100% recyclé et recyclable en fin de cycle de vie. Das umweltfreundliche Material der Outdoor-Bettplatte stammt aus dem Recycling von GFK-Kunststoff und dessen Bestandteilen. Es handelt sich daher um eine double-green Tischplatte, da sie zu 100% aus recyceltem Material besteht und am Ende der Lebenszeit erneut recycelt werden kann.

\*EcoShield: trattamento che garantisce un'eccezionale protezione dalla corrosione dovuta agli agenti atmosferici con vernici all'acqua, riducendo l'impatto ambientale. Il rivestimento ottenuto è duraturo nel tempo, resistendo efficacemente all'usura e al deterioramento. \*EcoShield: Treatment ensuring exceptional protection against corrosion caused by atmospheric agents, using water-based paints to reduce environmental impact. The resulting coating is durable over time and effectively resists wear and deterioration. \*EcoShield: traitement garantissant une protection exceptionnelle contre la corrosion due aux agents atmosphériques, avec des peintures à base d'eau réduisant l'impact environnemental. Le revêtement obtenu est durable dans le temps et résiste efficacement à l'usure et à la détérioration. \*EcoShield: eine Behandlung, die einen außergewöhnlichen Schutz vor Korrosion durch atmosphärische Einflüsse bietet und wasserbasierte Farben verwendet, um die Umweltbelastung zu reduzieren. Die resultierende Beschichtung ist langlebig und widerstandsfähig gegen Abnutzung und Verschleiß.

## Con.tradition Sara Bernardi, 2013-2025



**IT** Lanterne luminose per uso outdoor coperto con struttura in acciaio lavorato. Rosone in finitura colore nero. Cablaggio EU, 2 mt di cavo d'acciaio con cavo elettrico nero. Certificato outdoor IP41.  
**Finiture:** nero RAL 9005.

**EN** Luminous lanterns with worked steel structure for covered outdoor use. Ceiling rose in black finish. EU wiring, 2 meters / 78,8" steel cable with black electrical cable. Certified for outdoor use IP41.  
**Finishes:** Black RAL 9005.



**FR** Lanternes pour une utilisation en extérieur couvert avec structure en acier travaillé. Rosace en finition noire. Câblage UE, 2 mètres / 78,8" de câble en acier avec câble électrique noir. Certifié pour l'extérieur IP41.  
**Finitions :** noir RAL 9005.

**DE** Lanterne für den überdachten Außenbereich mit einer Struktur aus bearbeitetem Stahl. Deckenrose in RAL 9005 schwarzer Farbe. EU-Kabel, 2 Meter / 78,8" Stahlkabel mit schwarzem Stromkabel. Zertifiziert für den Außenbereich IP41.  
**Ausführungen:** Schwarz RAL 9005.

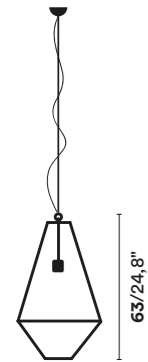

CON.TRADITION S

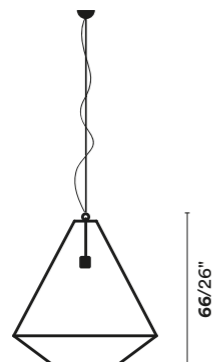

CON.TRADITION M

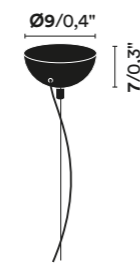

ceiling rose

### Note



220V  
HALOGEN / LED  
MAX 1x60W E27  
**Lampadina non inclusa.**  
Light bulb not included.  
Ampoule non incluse.  
Leuchtmittel nicht inbegriffen.

## La Cima Lapo Ciatti, 2014-2025



**IT** Appendiabiti in corda nautica intrecciata, montabile a parete o soffitto, con dettagli in metallo. Ogni corda è dotata di tre anelli, ciascuno con due appendiabiti.  
**Finiture corda:** nera o color beige naturale.  
**Finiture parti metalliche:** nero lucido, beige lucido, galvanica oro 24 K, cromo.

**EN** Wall or ceiling-mounted coat rack in plaited nautical rope with metal hardware. Each rope features three rings, equipped with two coat hooks each.  
**Rope finishes:** black or natural beige.  
**Metal hardware finishes:** glossy black, glossy beige, 24K gold plating, chrome.



**Finiture corda / Rope finishes**

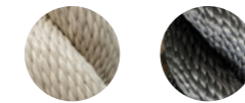

**Finiture parti metalliche / Metal hardware finishes**

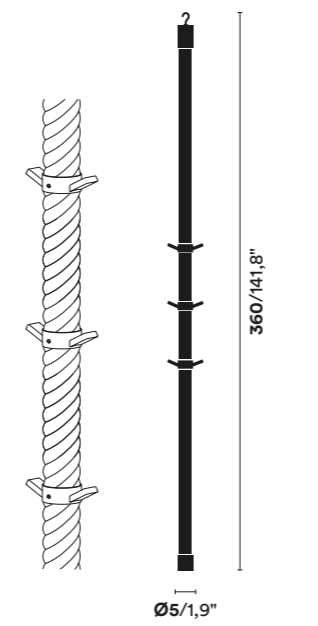

LACIMA

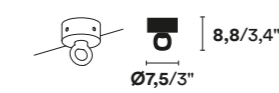

LACIMA CEILING

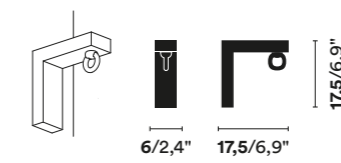

LACIMA WALL

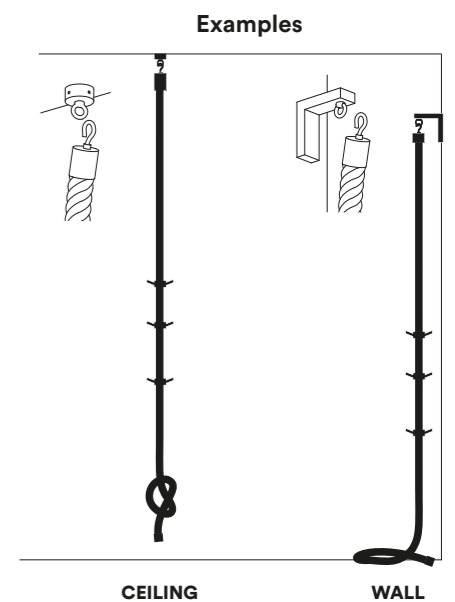

CEILING

WALL

**FR** Portemanteau à accrocher au mur ou au plafond en corde marine croisée avec détails en métal. Chaque corde est équipée avec trois anneaux contenant chacun deux crochets porte-manteaux.  
**Finitions corde :** noir ou beige naturel.  
**Finitions accessoires en métal :** noir brillant, beige brillant, plaqué or 24 cts, chromé.

**DE** Garderobe aus geflochtenem Schiffseil, zur Wand- oder Deckenbefestigung, mit Zubehör aus Metall. Jedes Seil ist mit drei Ringen ausgestattet, die jeweils zwei Kleiderhaken enthalten.  
**Ausführungen Seil:** Schwarz oder Naturbeige.  
**Ausführungen Zubehör:** glänzendes Schwarz, glänzendes Beige, 24K Goldbeschichtung, Chrom.

## **Opinion Ciatti Srl**

via di Prato, 80  
50041 Calenzano, Firenze - Italia  
T.: + 39 055 88 70 91  
F.: + 39 055 88 70 92 37  
info@opinionciatti.com

[www.opinionciatti.com](http://www.opinionciatti.com)

