

astro

2025

LIGHTING
CATALOGUE

Our Heritage

Since 1997, founders John Fearon and James Bassant have shared a passion for British lighting design and a vision to create products with distinctive quality.

The insight gained over this time influences our comprehensive range of lighting for hospitality, residential, senior living, and commercial applications.

Underpinned by a meticulous attention to detail, each design balances high performance with our commitment to sustainable, timeless design.



Creating a Sustainable Future

Responsible design is about being mindful of the whole lifecycle of our products. From the initial concept through to the end of a luminaire's life. Our three prioritised commitments guide each decision we make and are linked to the UN Global Goals for Sustainable Development.

Net Zero

Committed to going further than carbon neutrality, we are actively reducing emissions across our entire value chain with the aim of becoming a net zero contributor.

Astro Circular

Transforming our approach to design and engineering, we are minimising our impact on the planet. By adopting circular loops we can reduce, reuse, repair and recycle, extending the lifespan of our products.

Light For All

Nearly 600 million people across sub-Saharan Africa lack access to light but this can change instantly with a simple solar light. Our partnership with global charity SolarAid, aims to spread awareness of this global energy crisis and support the most remote communities in Malawi and Zambia with clean, safe, solar power.



Find out more



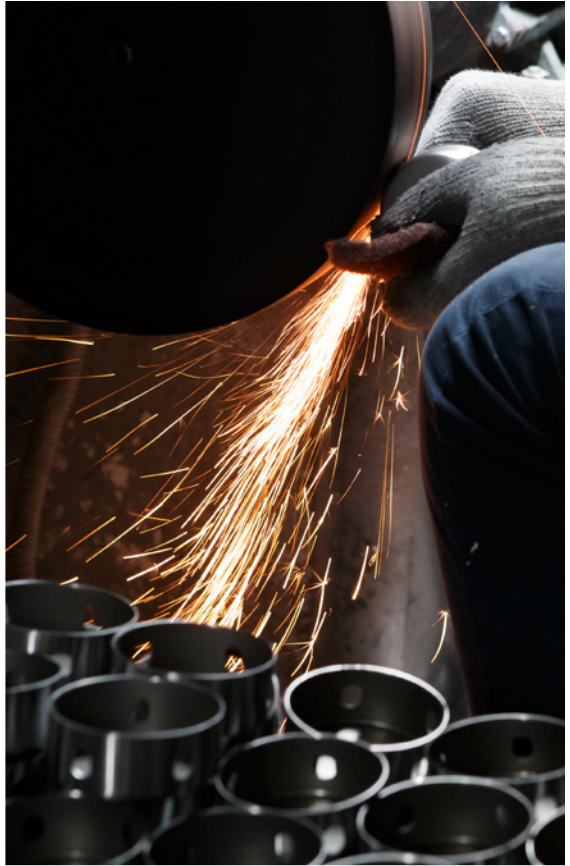
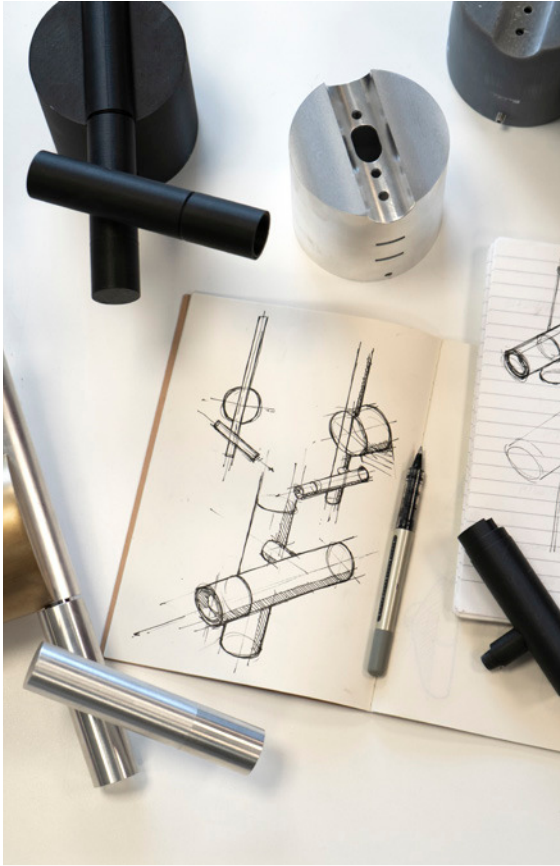

New Products

Modern innovation blends with timeless elegance in our latest collection of contemporary lighting concepts. Featuring complete guest room families and the introduction of PVD Brass and Pressed Ceramic to our coastal products, this collection offers flexible, architecturally inspired luminaires in our distinctive, refined aesthetic.



Tacoma Pendant P. 80



Tacoma Surface P. 82



Liberty P. 40



Burlington P. 34

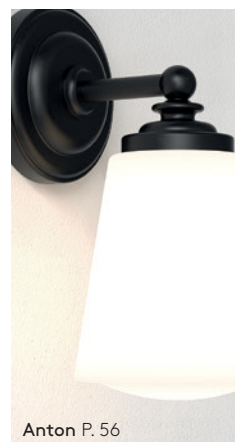

Anton P. 56



Luna P. 142



Club Table P. 254

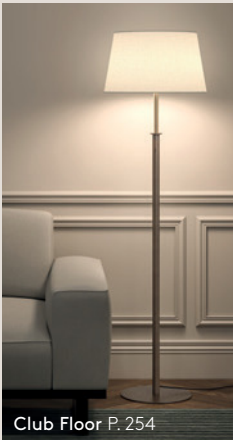

Club Floor P. 254



Club Reader P. 176

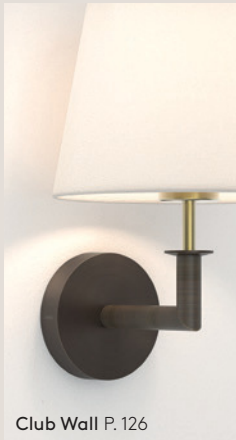

Club Wall P. 126



Veo Pendant P. 282



Taiko Pendant P. 284



Gio P. 184



Comino P. 204



Beaumont Floor P. 252



Beaumont Reader P. 174

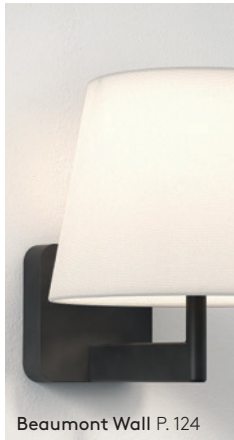

Beaumont Wall P. 124



Beaumont Table P. 252



Juno Spotlights P. 310



Kos Recessed P. 380



Dartmouth Spike P. 364



Edward Floor P. 241



Dartmouth Spot Single + Twin P. 350



Newlyn Twin P. 386



Newlyn Single P. 386



Newlyn Surface P. 398



Mast Light Coastal P. 394



Ava Coastal P. 390



Montreal Coastal P. 388



Montreal Coastal P. 388

Available Spring 2025



Contents

Bathroom

| | |
|----------------------|-----|
| Lighting Regulations | 22 |
| Wall | 26 |
| Mirror Mounting Kit | 68 |
| Marker | 70 |
| Illuminated Mirror | 72 |
| Pendant | 78 |
| Ceiling | 82 |
| Downlight | 94 |
| Spotlight | 101 |

Interior

| | |
|-------------------|-----|
| Collections | 102 |
| Wall | 124 |
| Reading | 174 |
| Plaster + Ceramic | 204 |
| Glass | 223 |
| Picture | 226 |
| Marker | 230 |
| Portable | 234 |
| Table & Floor | 236 |
| Ceiling | 266 |
| Pendant | 280 |
| Downlight | 298 |
| Spotlight | 312 |
| Track | 318 |

Exterior

| | |
|---------------|-----|
| Wall | 324 |
| Wall + Ground | 359 |
| Portable | 370 |
| Pendant | 372 |
| Ceiling | 376 |
| Downlight | 378 |

Coastal

| | |
|-----------|-----|
| Wall | 386 |
| Downlight | 397 |
| Ground | 400 |

Information

| | |
|---------------------|-----|
| Accessories | 402 |
| Shade Information | 402 |
| Finishes | 403 |
| Symbols | 403 |
| Numerical Index | 404 |
| Alphabetical Index | 407 |
| Global Distributors | 410 |
| Design Rights | 411 |

Bathroom Lighting



Atticus
P. 26



Artemis
P. 27



Palermo
P. 28



Cabaret
P. 29



Boston
P. 30



Harvard Wall
P. 31



Mashiko
P. 32



Salerno
P. 33



NEW
Burlington
P. 34



Versailles
P. 36



Monza Classic 250
P. 38



io Wall
P. 39



NEW
Liberty Wall
P. 40



Ottavino Wall
P. 42



Millie
P. 43



Thurso Oval
P. 44



Cabin Wall
P. 45



Sagara
P. 46



Lyra Wall
P. 47



Tacoma Single
P. 48



Tacoma Twin
P. 48



Tacoma Single
Grande
P. 48



Aquina Wall
P. 50



Conic
P. 51



Elena
P. 52



Riva 350
P. 53



Lago 280
P. 54



Beauville
P. 55



Anton
P. 56



Roma
P. 58



Arezzo Wall
P. 59



Kyoto
P. 60



Ortona Single
P. 61



Ortona Twin
P. 61



Padova
P. 62



Dio
P. 63



Tube
P. 64



Bari
P. 64



Verona
P. 65



Nena
P. 65



Cube
P. 66



Zeppo Wall
P. 67



Dayton
P. 69



Kashima
P. 69



Borgo 54
P. 70



Terra 28
P. 71



Terra 42
P. 71



Tango
P. 71



Ascot
P. 72



Orb
P. 74



Orb Single
P. 74



Niimi
P. 75



Catena
P. 75



Nagoya
P. 76



Mascali
P. 77



Ottavino Pendant
P. 78



Nara
P. 79



NEW
Tacoma Pendant
P. 80



NEW
Tacoma Surface
P. 82



Mashiko Square
P. 84



Mashiko Round
P. 84



Lyra Ceiling
P. 86



Arezzo Ceiling
P. 87



Zeppo Ceiling
P. 88



Denver
P. 89



Aquina Ceiling 240
P. 90



Aquina Ceiling 360
P. 90



Sabina 170
P. 91



Sabina 280
P. 91



Denia
P. 91



Dakota
P. 92



Altea
P. 92



Syros
P. 93



Mallon LED
P. 93



Ottawa
P. 94



Kos Round
P. 95



Kos Square
P. 95



Void
P. 96



Trimless Round
P. 97



Trimless Square
P. 97



Pinhole
P. 98



Minima Round
P. 99



Minima Square
P. 99



Vancouver
P. 100



Terra 28 Round
P. 100



Aqua Single
P. 101



Aqua Recessed
P. 101



Aqua Triple Round
P. 101

Interior Lighting



NEW
Beaumont Wall
P. 124



NEW
Club Wall
P. 126



Venn Wall
P. 128



Lima
P. 129



Caserta
P. 130



Tate
P. 131



Arbor
P. 132



Riva 350
P. 133



Napoli
P. 134



Ravello Wall
P. 135



Park Lane
P. 136



Park Lane Grande
P. 137



Cambria 180
P. 138



Ashino
P. 139



ios 250 Shade
P. 139



Beauville
P. 140



Lago 280
P. 141



NEW
Luna
P. 142



Toro
P. 144



Ottavino Wall
P. 145



Veio
P. 146



Ella Wall
P. 147



Tacoma Single
P. 148



Tacoma Twin
P. 148



Tacoma Single Grande
P. 148



Ako
P. 150



Elba Wall
P. 151



Hashira 300
P. 152



Yuma
P. 153



Avignon
P. 154



io Wall
P. 155



Harvard Wall
P. 156



Boston
P. 157



Versailles
P. 158



Montreal
P. 160



Jura
P. 161



Ito
P. 162



Carlton Wall
P. 163



Serge
P. 164



Imari Wall Fixed
P. 165



Imari Wall Adjustable
P. 165



Edward Wall
P. 166



Edward Twin
P. 167



Miura Wall
P. 168



Miura Swing Arm
P. 169



Mitsu wall
P. 170

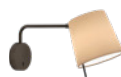

Mitsu Swing Arm
P. 171



Atelier Wall
P. 172



Atelier Grande Wall
P. 173



NEW
Beaumont Reader
P. 174



NEW
Club Reader
P. 176



Side by Side
P. 178



Side by Side Grande USB
P. 179



Venn Reader/Twin
P. 180



Napoli Reader
P. 181



Park Lane Reader
P. 182



Ravello Reader
P. 183



NEW
Gio
P. 184



Ascoli Swing
P. 186



Leda Single
P. 187



Leda Swing Arm
P. 187



Enna Swing
P. 188



Enna Surface USB
P. 189



Enna Square
Switched
P. 190



Enna Surface
P. 191



Enna Recess
Switched
P. 192



Enna Twin
P. 193



Micro Recess
P. 194



Keta
P. 195



Fuse 3
P. 196



Digit
P. 197



Tosca
P. 198



Baton
P. 199



Zeppo Reader
P. 200



Edge Reader Mini
P. 201



Lucca
P. 202



Fosso
P. 203



Leo
P. 203



NEW
Comino
P. 204



Velo
P. 206



Aria 300
P. 207



Parma
P. 208



Parma
P. 209



Shadow 300
P. 210



Pella
P. 211



Pienza
P. 211



Koza
P. 212



Kymi
P. 213



Pero
P. 214



Mosto
P. 215



Serifos
P. 216



Bologna 240
P. 217



Eclipse Round
P. 218



Blend
P. 219



Amas + Amat
P. 220



Amalfi
P. 221



Kyo
P. 221



Milo
P. 222



Parallel
P. 222



Tokyo
P. 223



Zeppo Wall
P. 224



Cyl
P. 225



Luga
P. 225



Goya
P. 226



Renoir
P. 227



Mondrian
P. 228



Mondrian Frame
P. 228



Leros Trimless
P. 230



Tango
P. 231



Borgo Trimless
P. 232



Borgo
P. 233



Halo Portable
P. 234



Zeppo Portable
P. 235



Ella Table
P. 236



Carlton Desk
P. 237



Imari Desk
P. 238



Gerrit
P. 239



Edward Desk
P. 240



NEW
Edward Floor
P. 241



Atelier Desk
P. 242



Miura Desk USB
P. 243



Joel Table
P. 244



Joel Floor
P. 245



Leda Desk
P. 246



Leda Floor
P. 247



Ascoli Desk
P. 248



Ascoli Floor
P. 249



Enna Desk
P. 250



Enna Floor
P. 251



NEW
Beaumont Table
P. 252



NEW
Beaumont Floor
P. 252



NEW
Club Table
P. 254



NEW
Club Floor
P. 254



Mitsu Table
P. 256



Mitsu Floor
P. 257



Venn Table
P. 258



Venn Floor
P. 259



Ravello Table
P. 260



Ravello Floor
P. 261



Park Lane Table
P. 262



Park Lane Floor
P. 265



Cut
P. 264



Marasino
P. 265



Limina
P. 265



Elba Ceiling Square
P. 266



Elba Ceiling Round
P. 266



Cambria
P. 268



Fife
P. 269

Salina
P. 270

Bevel Round
P. 271

Mashiko
P. 272

Taiko
P. 274

Mallon LED
P. 275

Aquila Ceiling
P. 276



Zeppo Ceiling
P. 277

NEW
Tacoma Surface
P. 278

NEW
Tacoma Pendant
P. 280

NEW
Veo Pendant
P. 282

NEW
Taiko Pendant
P. 284

Pendant
Suspension Kit 3
P. 286

Pendant
Suspension Kit 4
P. 288



Cambria Pendant
P. 289

io Pendant
P. 290

Zeppo Pendant
P. 291

Hashira Pendant
P. 292

Osca Pendant 400
P. 293

Ginestra
P. 294

Homefield
Pendant
P. 295



Pinhole
P. 298

Void
P. 299

Trimless Round
P. 300

Trimless Square
P. 301

Blanco
P. 302

Taro
P. 303

Minima Round
P. 304



Minima Square
P. 305

Ottawa
P. 306

Kos
P. 307

Shadow Surface
P. 308

Osca
P. 309

NEW
Juno Recessed
P. 310

NEW
Juno Single
P. 310



NEW
Juno Triple Bar
P. 310

NEW
Juno Four Bar
P. 310

Lynx
P. 312

Can
P. 313

Apollo single
P. 314

Apollo 100
Recessed
P. 314

Koto Single
P. 315



Koto Single Switched
P. 315



Koto Recessed
P.315



Koto Triple Round
P. 315



Koto 3/4/5 Bar
P. 315



Ascoli Single
P. 316



Ascoli Single Recessed
P. 316



Ascoli Single Switched
P. 316



Ascoli Flush
P. 316



Ascoli Twin
P. 316



Ascoli Twin Recessed
P. 316



Ascoli Triple Round
P. 317



Ascoli 3/4/5 Bar
P. 317



Apollo 100 Track
P. 318



Ascoli Track Spot
P. 318



Koto Track Spot
P. 318



Can Track Spot
P. 318



Track Pendant
P. 318

Exterior Lighting



Homefield Wall
P. 324



Messina
P. 325



Salerno
P. 326



Harvard Wall
P. 327



Box Lantern
P. 328



Coach
P. 329



Farringdon
P. 330



Calvi Wall
P. 331



Richmond Lantern
P. 332



Richmond Wall
P. 333



Harvard Lantern
P. 334



Pimlico
P. 335



Montparnasse Wall
P. 336



Cabin Wall
P. 337



Portree Wall
P. 338



Tressino
P. 339



Thurso Round
P. 340



Thurso Oval
P. 340



Kea Round
P. 341



Ava
P. 342



Montreal Oval
P. 343



Montreal Round
P. 343



Chios
P. 344



Oslo
P. 345



Dunbar
P. 346



Elis
P. 347



Mast Light
P. 348



Mast Light Twin
P. 348



Dartmouth
P. 349



NEW
Dartmouth Spot
Single
P. 350



NEW
Dartmouth Spot
Twin
P. 350



Bayville Spot Single
P. 352



Bayville Spot Twin
P. 352



Jura Single Spot
P. 353



Jura
P. 354



Mori
P. 355



Incline
P. 356



Tango
P. 357



Tivola
P. 358



Beam
P. 359



Gramos Round
P. 360



Gramos Square
P.360



Terra
P. 361



Bayville Spike Spot
P. 362



Myos
P. 363



NEW
Dartmouth Spike
Spot
P. 364



Jura Spike Spot
P. 366



Soprano Wall
P. 367



Soprano Bollard
P. 368



Homefield
Pedestal
P. 369



Kuro
P. 370



Nomad
P. 371



Harvard Pendant
P. 372



Montparnasse
Pendant
P. 373



Calvi Pendant
P. 374



Homefield Pendant
P. 375



Homefield Ceiling
P. 376



Bronte
P. 377



Jura Surface
P. 378



Kos Round
P. 379



Kos Square
P. 379



NEW
Kos Recessed
P. 380

Coastal Lighting



NEW
Newlyn Single
P. 386



NEW
Newlyn Twin
P. 386



NEW
Montreal Coastal
Round
P. 388



NEW
Montreal Coastal
Oval
P. 388



Ava Coastal
P. 390



Dunbar Coastal
P. 392



Eclipse Coastal
P. 393



Mast Light
Coastal Single
P. 394



Mast Light
Coastal Twin
P. 394



Oslo Coastal
P. 396



Kos Coastal
P. 397



NEW
Newlyn Surface
P. 398



Cromarty
P. 400



Skye Spike Spot
P. 401

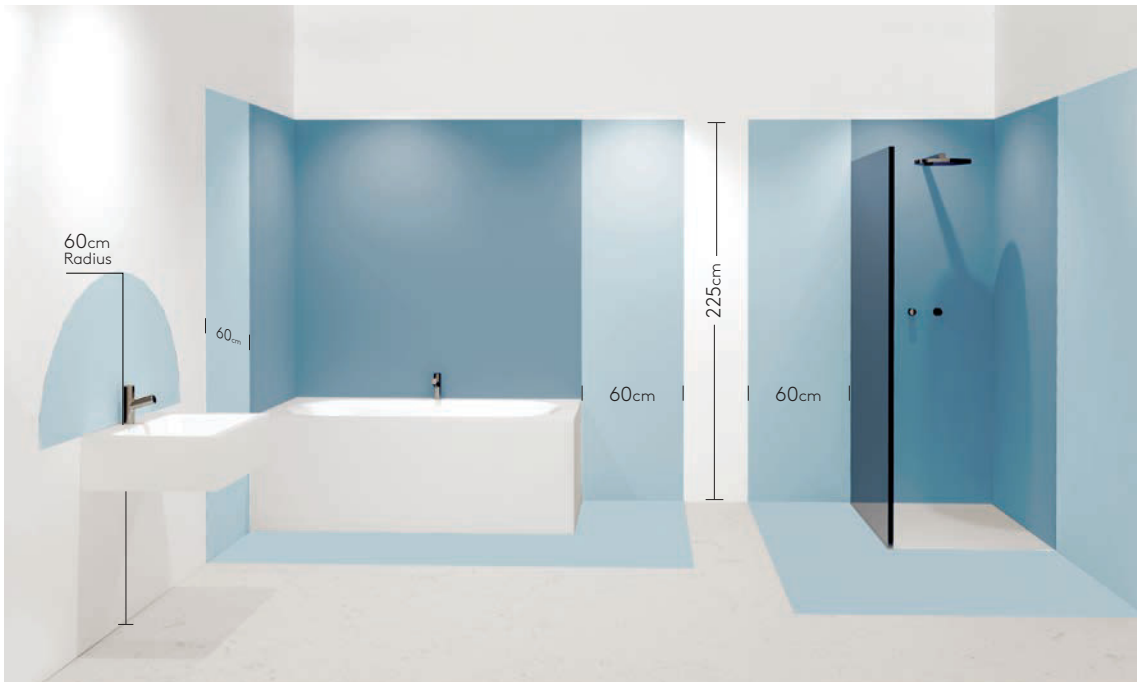

● ZONE 1 IP65 (or IPX5) ● ZONE 2 IP44 (or IPX4) ○ ZONE 3 IP20

Bathroom Lighting Regulations

Zone 1 Light fittings in this zone must be a minimum rating of IP44 (or IPX4) spray proof, however Astro Lighting recommends a higher rating of IP65 (or IPX5).

Zone 2 Light fittings in Zone 2 must be splash-proof. Look for an IP number of IP44 (or IPX4) or higher.

Zone 3 There are no special requirements in this zone in the United Kingdom. In Ireland, Zone 3 requires IP rated products.

All Zones Any electrical circuits in the bathroom must be protected by a 30mA Residual Current Device (RCD). Electrical equipment exposed to water-jets, e.g. for cleaning purposes, must be at least IP65 (IPX5).

N.B. These regulations apply to domestic applications only, according to IEE Wiring Regulations (17th Edition), BS 7671: 2008. For non-domestic applications, please refer to your electrician.

FR Zone 1 Les luminaires doivent être protégés contre les projections d'eau: symboles IP45, IP55, IP65. En France, tous les produits utilisés en zone 1 doivent être Très Basse Tension de Sécurité. **Zone 2** Les armatures doivent, dans cette zone, être protégées contre les projections d'eau: symbole IP44 ou supérieur. **Zone 3** Aucune exigence particulière n'est requise dans cette zone. NB: Ce résumé est seulement d'application pour un usage domestique. Pour tout autre usage ou, en cas de doute quant au type de luminaire à utiliser, demandez conseil à un électricien qualifié.

DE Zone 1 Beleuchtungskörper in dieser Zone müssen strahlwassergeschützt sein. Achten Sie auf folgende Zeichen: IP45, IP55 oder IP65. **Zone 2** Beleuchtungskörper in allen Zonen 2 müssen spritzwassergeschützt sein. Achten Sie auf folgende Zeichen: IP44 oder besser. **Zone 3** Für diese Zone gelten keine spezifischen Anforderungen für Beleuchtungskörper. Hinweis: Diese Zusammenfassung ist nur für den Hausgebrauch bestimmt. Für öffentliche Situationen oder in Zweifelsfällen beim Anbringen eines Beleuchtungskörpers wenden Sie sich bitte an einen ausgebildeten Elektriker.

IT Zone 1 Le installazioni per illuminazione in questo tipo di ambiente devono essere anti-nebulizzazione. è richiesto un grado di protezione IP45 (IPX5) o superiore. **Zone 2** Le installazioni per illuminazione in zone di tipo 2 devono essere anti-spruzzo. è richiesto un grado di protezione IP44 (IPX4) o superiore. **Zone 3** Non sono previsti particolari requisiti IP per questo tipo di ambiente. NB: Tali normative s'intendono applicabili esclusivamente per usi domestici, secondo la normativa britannica IEE Wiring Regulations (17a edizione) BS 7671 2008, in materia di impianti elettrici. Per applicazioni extra domestiche, rivolgersi a un elettricista.

Onerous Environments For more information on the use of our fittings in onerous environments, please get in touch via our website.



FR Environnements particuliers Pour obtenir de plus amples informations quant à l'utilisation de nos luminaires en environnements contraignants, veuillez prendre contact avec nous via notre site web.

DE Extremen Orten Für weitere Informationen über die Verwendung unserer Fassungen in rauen Umgebungen, kontaktieren Sie uns bitte über unsere Website.

IT Ambienti particolari Per maggiori informazioni sull'utilizzo dei nostri apparecchi in ambienti con condizioni particolarmente rigide, non esitate a contattarci tramite il nostro sito web.

Bathroom Lighting



Atticus
P. 26



Artemis
P. 27



Palermo
P. 28



Cabaret
P. 29



Boston
P. 30



Harvard Wall
P. 31



Mashiko
P. 32



Salerno
P. 33



NEW
Burlington
P. 34



Versailles
P. 36



Monza Classic 250
P. 38



io Wall
P. 39



NEW
Liberty Wall
P. 40



Ottavino Wall
P. 42



Millie
P. 43



Thurso Oval
P. 44



Cabin Wall
P. 45



Sagara
P. 46



Lyra Wall
P. 47



Tacoma Single
P. 48



Tacoma Twin
P. 48



Tacoma Single Grande
P. 48



Aquina Wall
P. 50



Conic
P. 51



Elena
P. 52



Riva 350
P. 53



Lago 280
P. 54



Beauville
P. 55



Anton
P. 56



Roma
P. 58



Arezzo Wall
P. 59



Kyoto
P. 60



Ortona Single
P. 61



Ortona Twin
P. 61



Padova
P. 62



Dio
P. 63



Tube
P. 64



Bari
P. 64



Verona
P. 65



Nena
P. 65



Cube
P. 66



Zeppo Wall
P. 67



Dayton
P. 69



Kashima
P. 69



Borgo 54
P. 70



Terra 28
P. 71



Terra 42
P. 71



Tango
P. 71



Ascot
P. 72



Orb
P. 74



Orb Single
P. 74



Niimi
P. 75



Catena
P. 75



Nagoya
P. 76



Mascali
P. 77



Ottavino Pendant
P. 78



Nara
P. 79



NEW
Tacoma Pendant
P. 80



NEW
Tacoma Surface
P. 82



Mashiko Square
P. 84



Mashiko Round
P. 84



Lyra Ceiling
P. 86



Arezzo Ceiling
P. 87



Zeppo Ceiling
P. 88



Denver
P. 89



Aquina Ceiling 240
P. 90



Aquina Ceiling 360
P. 90



Sabina 170
P. 91



Sabina 280
P. 91



Denia
P. 91



Dakota
P. 92



Altea
P. 92



Syros
P. 93



Mallon LED
P. 93



Ottawa
P. 94



Kos Round
P. 95



Kos Square
P. 95



Void
P. 96



Trimless Round
P. 97



Trimless Square
P. 97



Pinhole
P. 98



Minima Round
P. 99



Minima Square
P. 99



Vancouver
P. 100



Terra 28 Round
P. 100



Aqua Single
P. 101



Aqua Recessed
P. 101



Aqua Triple Round
P. 101



Atticus

ZONES 2 3

| | | | | LAMP | WATT | INPUT | K | CRI | Lm | IP | CLASS | | |
|-----|---------|---------|--|--------------|-------|----------|------|-----|-----|----|-------|-------|---|
| 600 | 1440001 | 1440005 | | Integral LED | 13.4W | 200-240V | 3000 | 90 | 606 | 44 | | Phase | ✓ |
| 900 | 1440002 | 1440006 | | Integral LED | 16.8W | 200-240V | 3000 | 90 | 976 | 44 | | Phase | ✓ |

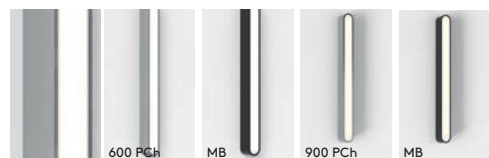
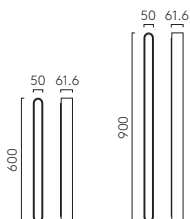



Artemis

ZONES  

| | LAMP | WATT | INPUT | K | CRI | Lm | IP | CLASS |  |
|---|--------------|-------|------------|------|-----|-----|----|---|---|
|  1308006 | Integral LED | 12.6W | Mains 230V | 3000 | 80 | 604 | 44 |  |  |

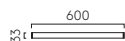

All products on this page can be mirror-mounted / Tous les produits sur cette page peuvent être montés sur miroir / Diese Produkte sind zur Montage am Spiegel geeignet / Tutti i prodotti di questa pagina possono essere fissati ad uno specchio. See p.68
Made to Order Larger size option is available as Made to Order for this product subject to minimum order quantities and extended lead times. / D'autres options de taille plus importante sur commande sont disponibles pour ce produit, sous condition d'un volume de commande minimum et de délais de livraison prolongés. / Größere Größen sind für dieses Produkt als Sonderanfertigung erhältlich und unterliegen einer Mindestbestellmenge und längeren Lieferzeiten. Bitte besuchen Sie unsere Website für weitere Informationen. / Un formato maggiore è disponibile su misura per questo prodotto con quantitativi minimi e tempi di consegna allungati. See Website.



Palermo

ZONES 2 3

| | | | LAMP | WATT | INPUT | K | CRI | Lm | IP | CLASS | |
|-----|--------------------------------------|-------------------------------------|--------------|-------|----------|------|-----|-----|----|--------------------------|---|
| 600 | <input type="checkbox"/> PCh 1084033 | <input type="checkbox"/> MB 1084038 | Integral LED | 6.8W | 220-240V | 3000 | 90 | 346 | 44 | <input type="checkbox"/> | ✓ |
| 900 | <input type="checkbox"/> PCh 1084034 | <input type="checkbox"/> MB 1084037 | Integral LED | 11.7W | 220-240V | 3000 | 90 | 629 | 44 | <input type="checkbox"/> | ✓ |



All products on this page can be mirror-mounted / Tous les produits sur cette page peuvent être montés sur miroir / Diese Produkte sind zur Montage am Spiegel geeignet / Tutti i prodotti di questa pagina possono essere fissati ad uno specchio. See p.68



Cabaret

ZONES 2 3

| | | | | LAMP | WATT | IP | CLASS | | |
|------|---------|---------|--|------|--------------|----|-------|---|---|
| Four | 1087009 | 1087007 | | G9* | 4 x 3.5W max | 44 | | ✓ | ✓ |
| Five | 1087010 | 1087008 | | G9* | 5 x 3.5W max | 44 | | ✓ | ✓ |

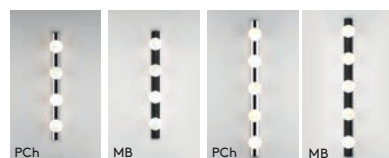

* Lamp excluded/La lampe exclu/Das Leuchtmittel ist ausgeschlossen/La lampadina esclusi.



Boston

ZONES 2 3

| | | | LAMP | WATT | INPUT | K | CRI | Lm | IP | CLASS | ☑ | ☑ | |
|-----|----|---------|------|---------|--------------|-------|------------|------|----|-------|----|---|---|
| 370 | Br | 1370004 | PCh | 1370002 | Integral LED | 14W | Mains 230V | 3000 | 80 | 465 | 44 | ☑ | ☑ |
| 600 | Br | 1370012 | | | Integral LED | 18.5W | Mains 230V | 3000 | 90 | 780 | 44 | ☑ | ☑ |

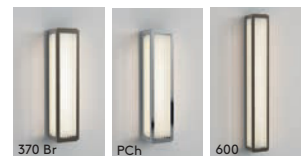
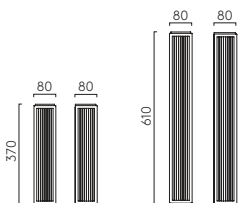

All products on this page can be mirror-mounted / Tous les produits sur cette page peuvent être montés sur miroir / Diese Produkte sind zur Montage am Spiegel geeignet / Tutti i prodotti di questa pagina possono essere fissati ad uno specchio. See p.68
Made to Order Alternative finish and dimming options are available as Made to Order for this product subject to minimum order quantities and extended lead times. / D'autres options de finition et de gradation sur commande sont disponibles pour ce produit, sous condition d'un volume de commande minimum et de délais de livraison prolongés. / Alternative Ausführungen und Dimmoptionen sind für dieses Produkt als Sonderanfertigung erhältlich und unterliegen einer Mindestbestellmenge und längeren Lieferzeiten. / Finiture alternative e diverse opzioni di regolazione sono disponibili su misura per questo prodotto con quantitativi minimi e tempi di consegna allungati. See website.

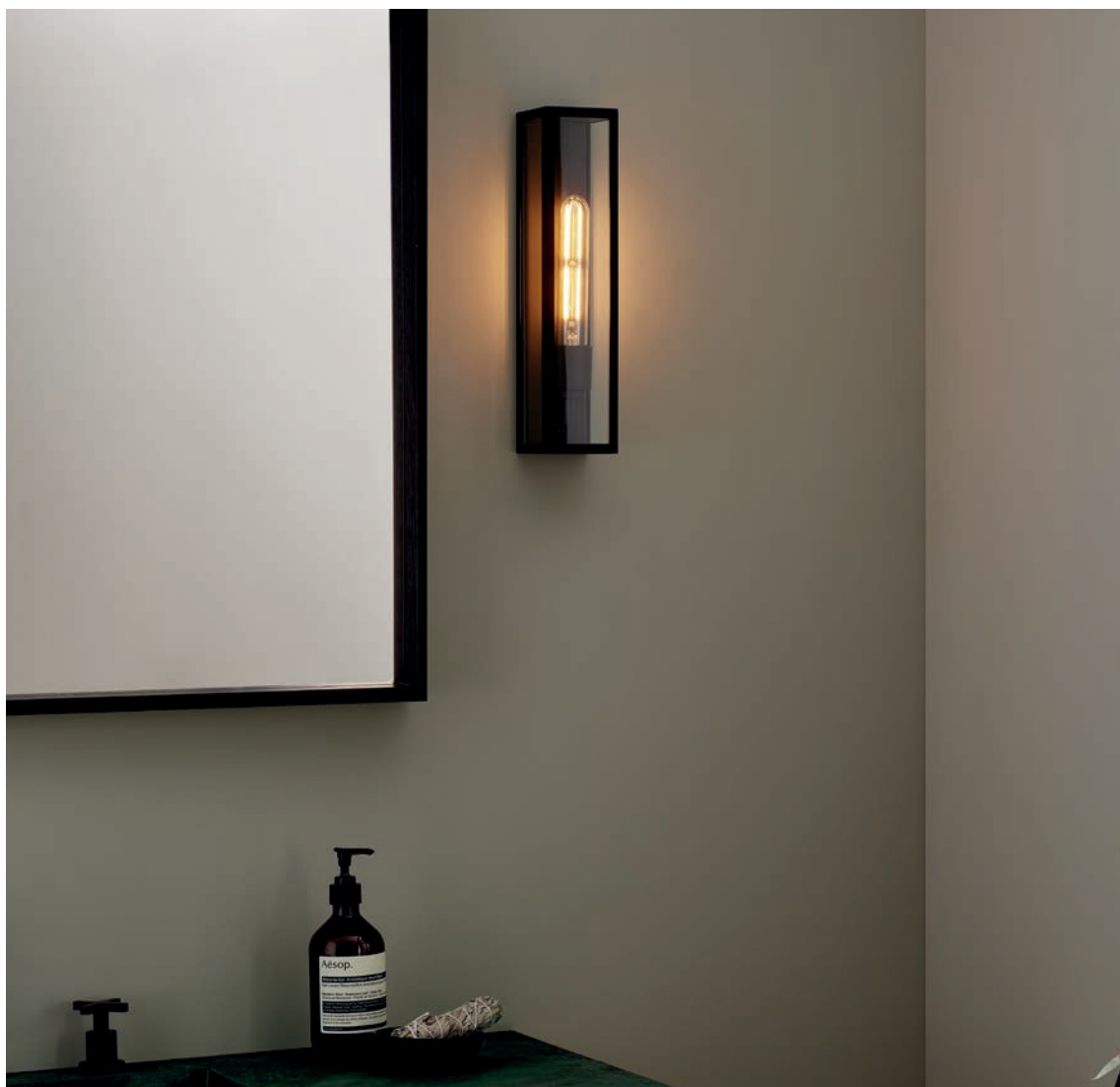

Harvard Wall

ZONES 2 3

| | LAMP | WATT | CLASS | IP | | |
|---|--------------|--------|-------|----|---|---|
| Br 1402009 TB 1402017 NB 1402007 | E27 Tubular▼ | 4W max | | 44 | ✓ | ✓ |

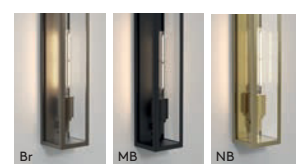
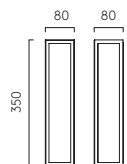

▼ Lamp excluded/La lampe exclu/Das Leuchtmittel ist ausgeschlossen/La lampadina esclusi.



360 LED Matt Nickel

Mashiko

ZONES 2 3

| | | | | LAMP | WATT | INPUT | K | CRI | Lm | IP | CLASS | | | | | |
|--------------------|----|---------|-----|---------|--------------|---------|----------|-------------|----|-----|-------|----|---|---|---|---|
| Classic 360 | Br | 1121055 | PCh | 1121006 | MG | 1121037 | E14* | 2 x 40W max | - | - | - | 44 | | ✓ | ✓ | - |
| 600 LED | Br | 1121102 | | | Integral LED | 10.6W | 220-240V | 3000 | 80 | 899 | 44 | | - | - | ✓ | |

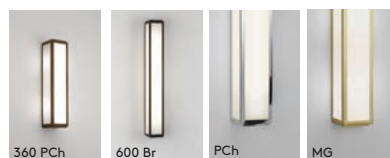
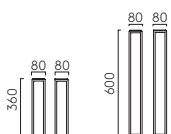

* Lamp excluded / La lampe exclu / Das Leuchtmittel ist ausgeschlossen / La lampadina esclusi.

All products on this page can be mirror-mounted / Tous les produits sur cette page peuvent être montés sur miroir / Diese Produkte sind zur Montage am Spiegel geeignet / Tutti i prodotti di questa pagina possono essere fissati ad uno specchio. See p.68

Made to Order Alternative finish and dimming options are available as Made to Order for this product subject to minimum order quantities and extended lead times. / D'autres options de finition et de gradation sur commande sont disponibles pour ce produit, sous condition d'un volume de commande minimum et de délais de livraison prolongés. / Alternative Ausführungen und Dimmoptionen sind für dieses Produkt als Sonderanfertigung erhältlich und unterliegen einer Mindestbestellmenge und längeren Lieferzeiten. / Finiture alternative e diverse opzioni di regolazione sono disponibili su misura per questo prodotto con quantitativi minimi e tempi di consegna allungati. See website.



350 Natural Brass

Salerno

ZONES

| | | | | LAMP | WATT | INPUT | K | CRI | Lm | IP | CLASS | | | | |
|---------|-----------------------------|---------|-----------------------------|---------|------------------|------------|------------|------|----|-----|-------|---|-------|---|---|
| 350 | <input type="checkbox"/> TB | 1178009 | <input type="checkbox"/> NB | 1178006 | E14 [▼] | 40W max | - | - | - | 44 | | ✓ | ✓ | - | |
| 350 LED | <input type="checkbox"/> TB | 1178012 | | | Integral LED | 8.2W | Mains 230V | 3000 | 80 | 367 | 44 | | - | ✓ | ✓ |
| 520 | <input type="checkbox"/> TB | 1178010 | | | E14 [▼] | 3 x 5W max | - | - | - | 44 | | ✓ | ✓ | - | |
| 520 LED | <input type="checkbox"/> TB | 1178011 | | | Integral LED | 15.4W | Mains 230V | 3000 | 80 | 916 | 44 | | Phase | ✓ | ✓ |

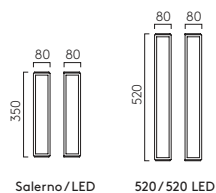

▼ Lamp excluded / La lampe exclu / Das Leuchtmittel ist ausgeschlossen / La lampadina esclusi.





Burlington

ZONES 2 3

| | | | LAMP | WATT | INPUT | K | CRI | Lm | IP | CLASS | | | | | |
|-----|----|---------|------|---------|--------------|-------|------------|------|----|-------|----|--|-------|---|---|
| 400 | Br | 1477001 | MG | 1477003 | Integral LED | 5.9W | Mains 230V | 2700 | 90 | 418 | 44 | | Phase | ✓ | ✓ |
| 600 | Br | 1477005 | MG | 1477007 | Integral LED | 9.87W | Mains 230V | 2700 | 90 | 791 | 44 | | Phase | ✓ | ✓ |

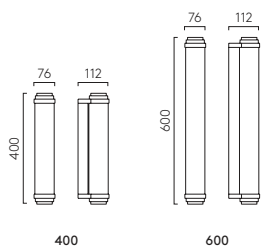

▼ Lamp excluded/La lampe exclu/Das Leuchtmittel ist ausgeschlossen/La lampadina esclusi.

All products on this page can be mirror-mounted/Tous les produits sur cette page peuvent être montés sur miroir/Diese Produkte sind zur Montage am Spiegel geeignet/Tutti i prodotti di questa pagina possono essere fissati ad uno specchio. See p.68

Made to Order Alternative finish and dimming options are available as Made to Order for this product subject to minimum order quantities and extended lead times./D'autres options de finition et de gradation sur commande sont disponibles pour ce produit, sous condition d'un volume de commande minimum et de délais de livraison prolongés./Alternative Ausführungen und Dimmoptionen sind für dieses Produkt als Sonderanfertigung erhältlich und unterliegen einer Mindestbestellmenge und längeren Lieferzeiten./Finiture alternative e diverse opzioni di regolazione sono disponibili su misura per questo prodotto con quantitativi minimi e tempi di consegna allungati. See website.



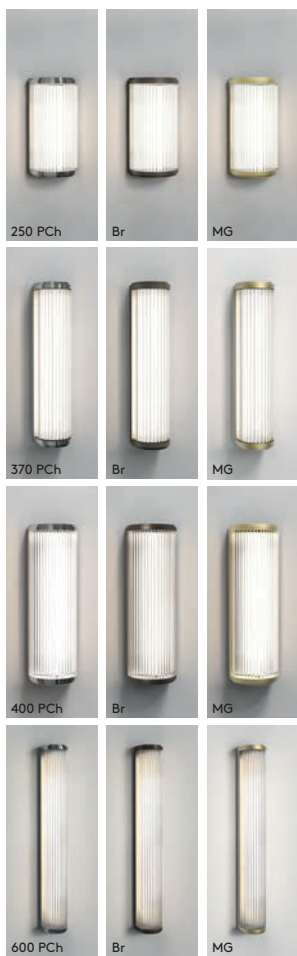

Versailles

ZONES 2 3

| | LAMP | WATT | INPUT | K | CRI | Lm | IP | CLASS | ☾ | 🌐 | 🌍 | |
|-----|--|--------------|-------|----------|------|----|-----|-------|--------------------------|-------|---|---|
| 250 | <input type="checkbox"/> PCh 1380024 <input type="checkbox"/> Br 1380025 <input type="checkbox"/> MG 1380026 | Integral LED | 4.5W | 220-240V | 3000 | 80 | 320 | 44 | <input type="checkbox"/> | Phase | ✓ | ✓ |
| 370 | <input type="checkbox"/> PCh 1380013 <input type="checkbox"/> Br 1380014 <input type="checkbox"/> MG 1380040 | Integral LED | 12W | 100-240V | 3000 | 80 | 661 | 44 | <input type="checkbox"/> | - | ✓ | ✓ |
| 400 | <input type="checkbox"/> PCh 1380029 <input type="checkbox"/> Br 1380030 <input type="checkbox"/> MG 1380031 | Integral LED | 7.1W | 100-240V | 3000 | 80 | 658 | 44 | <input type="checkbox"/> | Phase | ✓ | ✓ |
| 600 | <input type="checkbox"/> PCh 1380084 <input type="checkbox"/> Br 1380082 <input type="checkbox"/> MG 1380083 | Integral LED | 18.4W | 220-240V | 3000 | 90 | 945 | 44 | <input type="checkbox"/> | - | ✓ | ✓ |

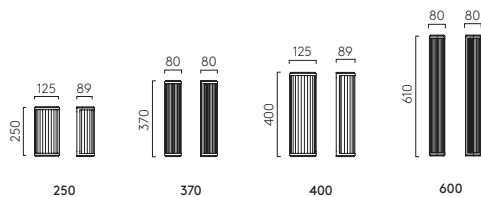

All products on this page can be mirror-mounted / Tous les produits sur cette page peuvent être montés sur miroir / Diese Produkte sind zur Montage am Spiegel geeignet / Tutti i prodotti di questa pagina possono essere fissati ad uno specchio. See p.68



Monza Classic 250

ZONES 2 3

PCh 1194003

| LAMP | WATT | IP | CLASS | | |
|------|---------|----|-------|---|---|
| E27▼ | 12W max | 44 | | ✓ | ✓ |

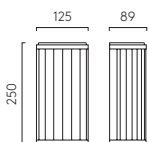

▼ Lamp excluded / La lampe exclu / Das Leuchtmittel ist ausgeschlossen / La lampadina esclusi.
 All products on this page can be mirror-mounted / Tous les produits sur cette page peuvent être montés sur miroir / Diese Produkte sind zur Montage am Spiegel geeignet / Tutti i prodotti di questa pagina possono essere fissati ad uno specchio. See p.68



io Wall

ZONES 2 3

| | | | | LAMP | WATT | INPUT | K | CRI | Lm | IP | CLASS | | | | | | |
|-----|-----|---------|----|--------------|------|----------|--------------|------|----------|------|-------|-------|----|---|-------|---|---|
| 265 | PCh | 1409003 | | Integral LED | 4.9W | 220-240V | 3000 | 80 | 403 | 44 | | Phase | ✓ | ✓ | | | |
| 420 | PCh | 1409055 | MB | 1409056 | MG | 1409057 | Integral LED | 6.5W | 220-240V | 3000 | 90 | 469 | 44 | | Phase | ✓ | ✓ |
| 665 | PCh | 1409058 | MB | 1409059 | MG | 1409060 | Integral LED | 8.3W | 220-240V | 3000 | 90 | 725 | 44 | | Phase | ✓ | ✓ |

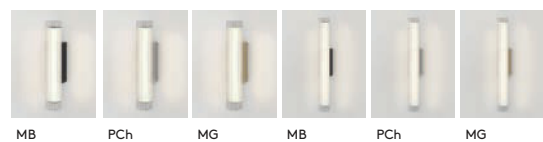
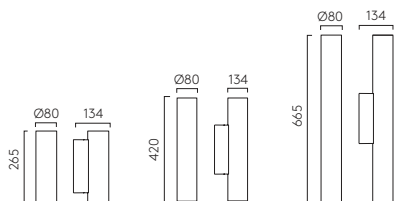





MB



PB



PCh



Liberty Wall

ZONES 2 3

| | LAMP | WATT | IP | CLASS | | |
|-----------------------------------|------|---------|----|-------|---|---|
| MB 1485001 PB 1485002 PCh 1485003 | E14 | 40W max | 44 | | ✓ | ✓ |

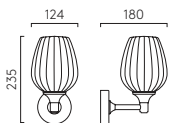

▼ Lamp excluded / La lampe exclu / Das Leuchtmittel ist ausgeschlossen / La lampadina esclusi.



Ottavino Wall

ZONES 2 3

| | | LAMP | WATT | IP | CLASS | | |
|--------------------|-------------------|------|--------|----|-------|---|---|
| PCh 1411001 | MB 1411006 | E14▼ | 5W max | 44 | | ✓ | ✓ |

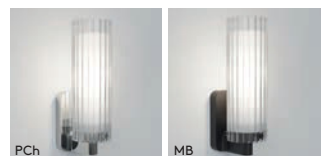
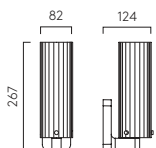

▼ Lamp excluded / La lampe exclu / Das Leuchtmittel ist ausgeschlossen / La lampadina esclusi.



Millie

ZONES **2** **3**

| | LAMP | WATT | IP | CLASS | | |
|--------------------------------------|------|----------|----|-------|---|---|
| PCh 1454001 MB 1454003 | G9* | 3.5W max | 44 | | ✓ | ✓ |

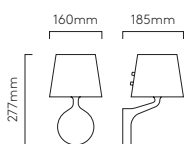

* Lamp excluded / La lampe exclu / Das Leuchtmittel ist ausgeschlossen / La lampadina esclusi.



Thurso Oval

ZONES 2 3

CB 1376006

| LAMP | WATT | IP | CLASS | | |
|------|---------|----|-------|---|---|
| E27* | 42W max | 44 | | ✓ | ✓ |

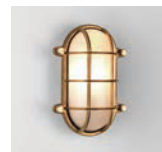
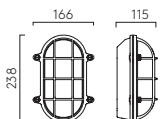

▼ Lamp excluded / La lampe exclu / Das Leuchtmittel ist ausgeschlossen / La lampadina esclusi.



Frosted Antique Brass

Cabin Wall

ZONES **2** **3**

| | LAMP | WATT | IP | CLASS | | |
|--|------|---------|----|-------|---|---|
| Br 1368025 AB 1368003 | E27* | 60W max | 44 | | ✓ | ✓ |
| Frosted Br 1368026 AB 1368008 | E27* | 60W max | 44 | | ✓ | ✓ |

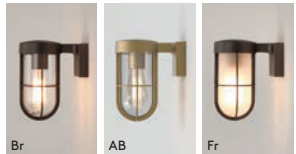
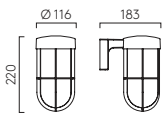

* Lamp excluded / La lampe exclu / Das Leuchtmittel ist ausgeschlossen / La lampadina esclusi.



Sagara

ZONES 2 3

| | LAMP | WATT | IP | CLASS | | |
|-------------|------|---------|----|-------|---|---|
| PCh 1168001 | G9▼ | 40W max | 44 | | ✓ | ✓ |
| MB 1168003 | | | | | | |

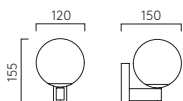

▼ Lamp excluded / La lampe exclu / Das Leuchtmittel ist ausgeschlossen / La lampadina esclusi.



Lyra

ZONES **2 3**

GW 1472001

| LAMP | WATT | IP | CLASS | | |
|-----------------|--------|----|-------|---|---|
| G9 [▼] | 5W max | 44 | | ✓ | ✓ |

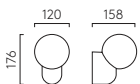

▼ Lamp excluded/La lampe exclu/Das Leuchtmittel ist ausgeschlossen/La lampadina esclusi.





Tacoma

SHADE EXCLUDED ZONES

| | | | | | LAMP | WATT | IP | CLASS | |
|---------------|---------|---------|---------|--|------|--------------|----|-------|---|
| Single | 1429001 | 1429004 | 1429007 | | G9* | 3.5W max | 44 | | ✓ |
| Twin | 1429002 | 1429005 | 1429008 | | G9* | 2 x 3.5W max | 44 | | ✓ |
| Single Grande | 1429003 | 1429006 | 1429009 | | G9* | 3.5W max | 44 | | ✓ |

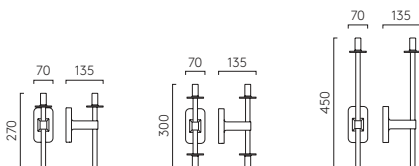

Shade Options

| Shade Type | Color/Finish | Code |
|--------------------|--------------|---------|
| Round Shade (Ø135) | WG | 5036001 |
| | WR | 5036003 |
| | CR | 5036004 |
| | SR | 5036005 |
| | SR | 5036005 |
| Reed Shade (Ø95) | WG | 5036009 |
| | SR | 5036010 |
| | SR | 5036010 |
| Tulip shade (Ø124) | WG | 5036007 |
| | SR | 5036008 |

▼ Lamp excluded/La lampe exclu/Das Leuchtmittel ist ausgeschlossen/La lampadina esclusi.



Aquina Wall

ZONES **2** **3**

| | LAMP | WATT | IP | CLASS | | |
|--------------------------------------|------|----------|----|-------|---|---|
| PCh 1450001 MB 1450002 | G9* | 3.5W max | 44 | | ✓ | ✓ |

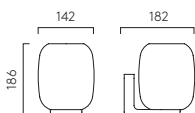

▼ Lamp excluded / La lampe exclu / Das Leuchtmittel ist ausgeschlossen / La lampadina esclusi.



Conic

ZONES **2** **3**

| | LAMP | WATT | IP | CLASS | | |
|--------------------------------------|------|----------|----|-------|---|---|
| PCh 1451001 MB 1451002 | G9* | 3.5W max | 44 | | ✓ | ✓ |

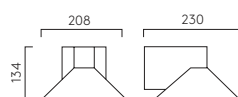

▼ Lamp excluded/La lampe exclu/Das Leuchtmittel ist ausgeschlossen/La lampadina esclusi.



Elena

ZONES 2 3

| | LAMP | WATT | IP | CLASS | | |
|--|------|----------|----|--------------------------|-------------------------------------|-------------------------------------|
| <input type="checkbox"/> PCh 1453001 <input type="checkbox"/> MB 1453003 | G9* | 3.5W max | 44 | <input type="checkbox"/> | <input checked="" type="checkbox"/> | <input checked="" type="checkbox"/> |

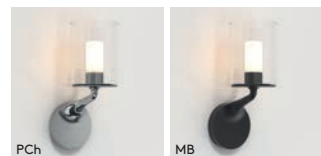
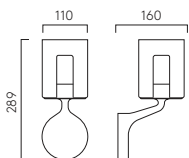

▼ Lamp excluded / La lampe exclu / Das Leuchtmittel ist ausgeschlossen / La lampadina esclusi.



Matt Black + White Fabric Shade

Riva 350

SHADE EXCLUDED ZONES 2 3

| | LAMP | WATT | IP | CLASS | |
|--|------------------|---------|----|--------------------------|-------------------------------------|
| <input type="checkbox"/> PCh 1214001 <input type="checkbox"/> MN 1214004 <input type="checkbox"/> Br 1214010 <input type="checkbox"/> MB 1214015 | E27 [▼] | 60W max | 44 | <input type="checkbox"/> | <input checked="" type="checkbox"/> |

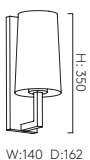

CONE 240
Shade options
 WG 5018007
 WF 5018004
 PF 5018014

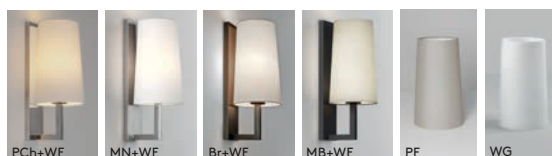

• Special Shade Colours / Couleurs spéciales / Sonderfarben / Colori speciali - See p.404
 ▼ Lamp excluded / La lampe exclu / Das Leuchtmittel ist ausgeschlossen / La lampadina esclusi.



Bronze + Natural Brass Shade

Lago 280

SHADE EXCLUDED ZONES 2 3

| | | | | LAMP | WATT | IP | CLASS | | | | | |
|-----|---------|----|---------|------|---------|----|---------|------|---------|----|--|---|
| PCh | 1297001 | MN | 1297002 | Br | 1297007 | MB | 1297009 | E27* | 60W max | 44 | | ✓ |

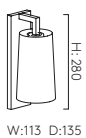

CONE 195
Shade options

| | |
|----|---------|
| WG | 5019001 |
| WF | 5018001 |
| NB | 5018046 |



• Special Shade Colours/Couleurs spéciales/Sonderfarben/Colori speciali - See p.404
 ▼ Lamp excluded/La lampe exclu./Das Leuchtmittel ist ausgeschlossen/La lampadina esclusi.



Beauville

SHADE EXCLUDED ZONES 2 3

| | LAMP | WATT | IP | CLASS | |
|-------------|------|---------|----|-------|--|
| PCh 1388001 | E27* | 40W max | 44 | | |
| Br 1388003 | | | | | |

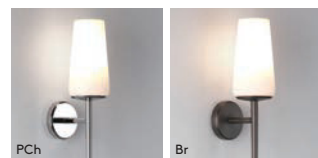
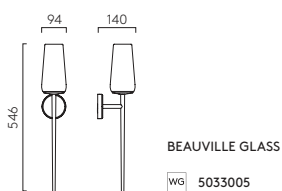

* Lamp excluded / La lampe exclu / Das Leuchtmittel ist ausgeschlossen / La lampadina esclusi





MB



PB



PCh



Anton

ZONES **2 3**

| | LAMP | WATT | IP | CLASS | | |
|--|------------------|---------|----|-------|-------------------------------------|-------------------------------------|
| <input type="checkbox"/> PCh 1106001 <input type="checkbox"/> MB 1106006 <input type="checkbox"/> PB 1106007 | E14 [▼] | 40W max | 44 | | <input checked="" type="checkbox"/> | <input checked="" type="checkbox"/> |

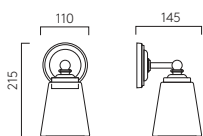

[▼] Lamp excluded/La lampe exclu/Das Leuchtmittel ist ausgeschlossen/La lampadina esclusi.



Roma

ZONES 2 3

| | LAMP | WATT | IP | CLASS | | |
|-------------|------|---------|----|-------|---|---|
| PCh 1050001 | G9▼ | 40W max | 44 | | ✓ | ✓ |
| MB 1050007 | | | | | | |
| MG 1050009 | | | | | | |

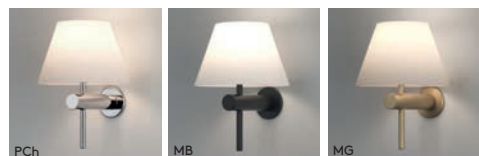
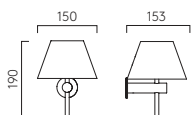

▼ Lamp excluded/La lampe exclu/Das Leuchtmittel ist ausgeschlossen/La lampadina esclusi.
 All products on this page can be mirror-mounted/Tous les produits sur cette page peuvent être montés sur miroir/Diese Produkte sind zur Montage am Spiegel geeignet/Tutti i prodotti di questa pagina possono essere fissati ad uno specchio. See p.68



Arezzo Wall

ZONES  

| | LAMP | WATT | IP | CLASS |  |  |
|---|------|---------|----|---|---|---|
|  1049001 | G9* | 40W max | 44 |  | ✓ | ✓ |

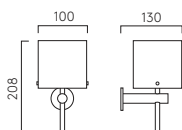

▼ Lamp excluded/La lampe exclu/Das Leuchtmittel ist ausgeschlossen/La lampadina esclusi.
 All products on this page can be mirror-mounted/Tous les produits sur cette page peuvent être montés sur miroir/Diese Produkte sind zur Montage am Spiegel geeignet/Tutti i prodotti di questa pagina possono essere fissati ad uno specchio. See p.68



Kyoto

ZONES 2 3

| | | LAMP | WATT | INPUT | K | CRI | Lm | IP | CLASS | |
|-----|---------|--------------|------|------------|------|-----|-----|----|-------|-------------------------------------|
| PCh | 1060018 | Integral LED | 8.7W | Mains 230V | 2700 | 90 | 291 | 44 | | <input checked="" type="checkbox"/> |
| MB | 1060017 | | | | | | | | | |

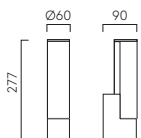



Ortona

ZONES 2 3

| | LAMP | WATT | IP | CLASS | | |
|---------------|------------------------|------|-------------|-------|--|-----|
| Single | PCh 1459001 MB 1459005 | G9* | 25W max | 44 | | ✓ ✓ |
| Twin | PCh 1459002 MB 1459006 | G9* | 2 x 25W max | 44 | | ✓ ✓ |

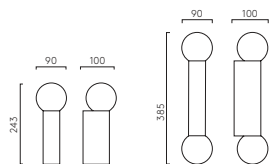

* Lamp excluded / La lampe exclu / Das Leuchtmittel ist ausgeschlossen / La lampadina esclusi.



Padova

ZONES 2 3

| | LAMP | WATT | IP | CLASS | | |
|--|------|-------------|----|--------------------------|-------------------------------------|-------------------------------------|
| <input type="checkbox"/> PCh 1143001 <input type="checkbox"/> MB 1143008 | G9▼ | 2 x 28W max | 44 | <input type="checkbox"/> | <input checked="" type="checkbox"/> | <input checked="" type="checkbox"/> |

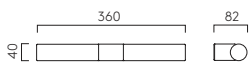

▼ Lamp excluded / La lampe exclu / Das Leuchtmittel ist ausgeschlossen / La lampadina esclusi.



Dio

ZONES **2** **3**

| | LAMP | WATT | INPUT | K | CRI | Lm | IP | CLASS | |
|--------------------|--------------|------|----------|------|-----|-----|----|-------|-------------------------------------|
| Pch 1305006 | Integral LED | 6.4W | 100-240V | 3000 | 80 | 320 | 44 | | <input checked="" type="checkbox"/> |

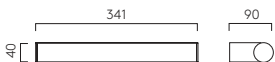

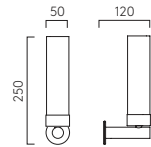
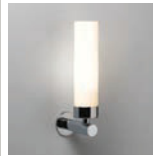

ZONES 2 3

Tube

| | LAMP | WATT | IP | CLASS | | |
|-------------|------------------|---------|----|-------|---|---|
| PCh 1021001 | E14 [▼] | 40W max | 44 | | ✓ | ✓ |

▼ Lamp excluded / La lampe exclu / Das Leuchtmittel ist ausgeschlossen / La lampadina esclusi.
 Can be mirror-mounted / Peut être monté sur miroir / Kann am Spiegel montiert werden / Può essere montato a specchio. See p.68

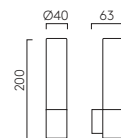

ZONES 2 3

Bari

| | LAMP | WATT | IP | CLASS | | |
|---|-----------------|---------|----|-------|---|---|
| PCh 1047001 MN 1047004 MG 1047008 MB 1047006 | G9 [▼] | 40W max | 44 | | ✓ | ✓ |

▼ Lamp excluded / La lampe exclu / Das Leuchtmittel ist ausgeschlossen / La lampadina esclusi.

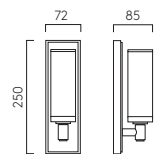
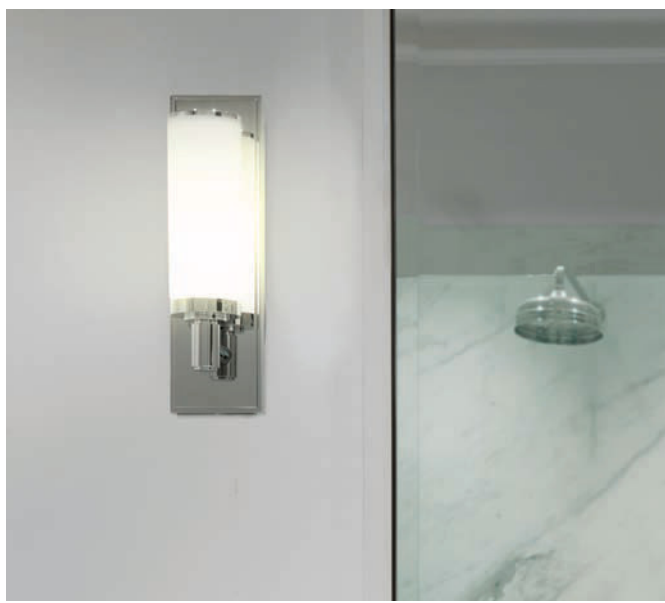

Verona

ZONES 2 3

| | LAMP | WATT | IP | CLASS | | |
|-------------|------|---------|----|-------|---|---|
| PCh 1147001 | E14* | 40W max | 44 | | ✓ | ✓ |

* Lamp excluded / La lampe exclu / Das Leuchtmittel ist ausgeschlossen / La lampadina esclusi.

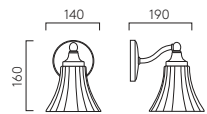

Nena

ZONES 2 3

| | LAMP | WATT | IP | CLASS | | |
|-------------|------|---------|----|-------|---|---|
| PCh 1105001 | G9* | 40W max | 44 | | ✓ | ✓ |

* Lamp excluded / La lampe exclu / Das Leuchtmittel ist ausgeschlossen / La lampadina esclusi.



Cube

ZONES 2 3

| | LAMP | WATT | IP | CLASS | | |
|-------------|------|---------|----|-------|---|---|
| PCh 1140001 | G9* | 40W max | 44 | | ✓ | ✓ |

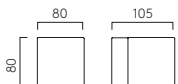

▼ Lamp excluded / La lampe exclu / Das Leuchtmittel ist ausgeschlossen / La lampadina esclusi.



Zeppo Wall

ZONES **2 3**

| | LAMP | WATT | IP | CLASS | | |
|--------------------|-------------------|------|---------|-------|--|---|
| PCh 1176004 | MB 1176047 | G9* | 33W max | 44 | | <input checked="" type="checkbox"/> <input checked="" type="checkbox"/> |

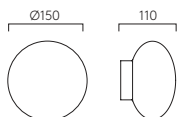

* Lamp excluded / La lampe exclu / Das Leuchtmittel ist ausgeschlossen / La lampadina esclusi.



Palermo 600 + Mirror Mounting Kit 2

Mirror Mounting Kits

DIMENSIONS

Kit 1 PCh Br MN MW MB 6001003

Ø80mm D:12mm

Kit 2 PCh 6001002

Ø25mm D:21mm

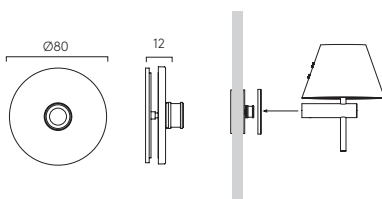

Kit 1

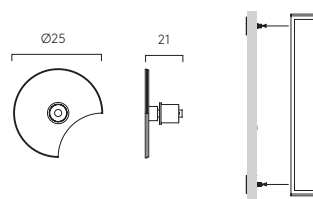

Kit 2

Please refer to our website for compatible products / Veuillez consulter notre site Web pour les produits compatibles / Kompatible Produkte finden Sie auf unserer Website / Si prega di fare riferimento al nostro sito Web per i prodotti compatibili.

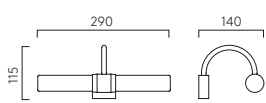

Dayton

ZONES 2 3

| | LAMP | WATT | IP | CLASS | | |
|-------------|------|-------------|----|-------|---|---|
| PCh 1044001 | G9* | 2 x 25W max | 44 | | ✓ | ✓ |

* Lamp excluded/La lampe exclu/Das Leuchtmittel ist ausgeschlossen/La lampadina esclusi.

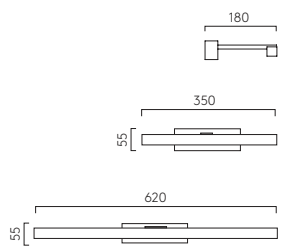

Kashima

ZONES 2 3

| | LAMP | WATT | INPUT | K | CRI | Lm | IP | CLASS |
|-----------------|--------------|------|----------|------|-----|-----|----|-------|
| 350 PCh 1174003 | Integral LED | 4.5W | 100-240V | 3000 | 80 | 165 | 44 | |
| 620 PCh 1174004 | Integral LED | 8.2W | 220-240V | 3000 | 80 | 387 | 44 | |



Borgo

ZONES 1 2 3

| | | LAMP | WATT | INPUT | K | CRI | Lm | IP | CLASS | | |
|--------|---------|--------------|------|--------------------|------|-----|----|----|-------|---|---|
| 54 LED | 1212019 | Integral LED | 2.6W | 350mA [▼] | 3000 | 90 | 30 | 65 | | ✓ | ✓ |
| 54 LED | 1212033 | Integral LED | 2.6W | 350mA [▼] | 2700 | 90 | 30 | 65 | | ✓ | ✓ |

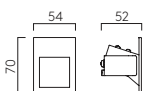

[▼] Driver excluded/Driver d'entrée exclu/Driver esclusi/Das treiber ist ausgeschlossen.

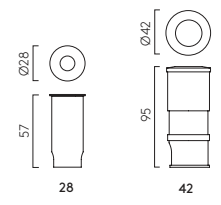
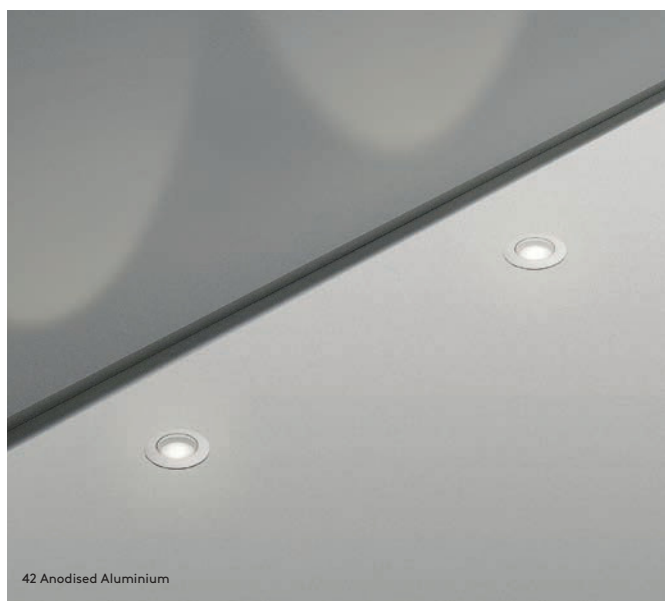

Terra

ZONES 1 2 3

| | LAMP | WATT | INPUT | K | CRI | Lm | IP | CLASS | | |
|----|--------------------------------------|--------------|-------|--------|------|----|-----|-------|--|-------------------------------------|
| 28 | <input type="checkbox"/> BSS 1201005 | Integral LED | 1.8W | 350mA* | 3000 | 80 | 53 | 65 | | <input checked="" type="checkbox"/> |
| 42 | <input type="checkbox"/> AA 1201007 | Integral LED | 3.2W | 700mA* | 3000 | 80 | 169 | 67 | | <input checked="" type="checkbox"/> |

* Driver excluded / Driver d'entrée exclu / Driver esclusi / Das treiber ist ausgeschlossen.

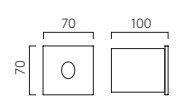

Tango

ZONES 1 2 3

| | LAMP | WATT | INPUT | K | CRI | Lm | IP | CLASS | | |
|-------------------------------------|--------------------------------------|-------------------------------------|--------------|------|--------|------|----|-------|----|-------------------------------------|
| <input type="checkbox"/> TB 1175004 | <input type="checkbox"/> BSS 1175002 | <input type="checkbox"/> MW 1175001 | Integral LED | 2.2W | 350mA* | 3000 | 90 | 23 | 65 | <input checked="" type="checkbox"/> |

* Driver excluded / Driver d'entrée exclu / Driver esclusi / Das treiber ist ausgeschlossen.

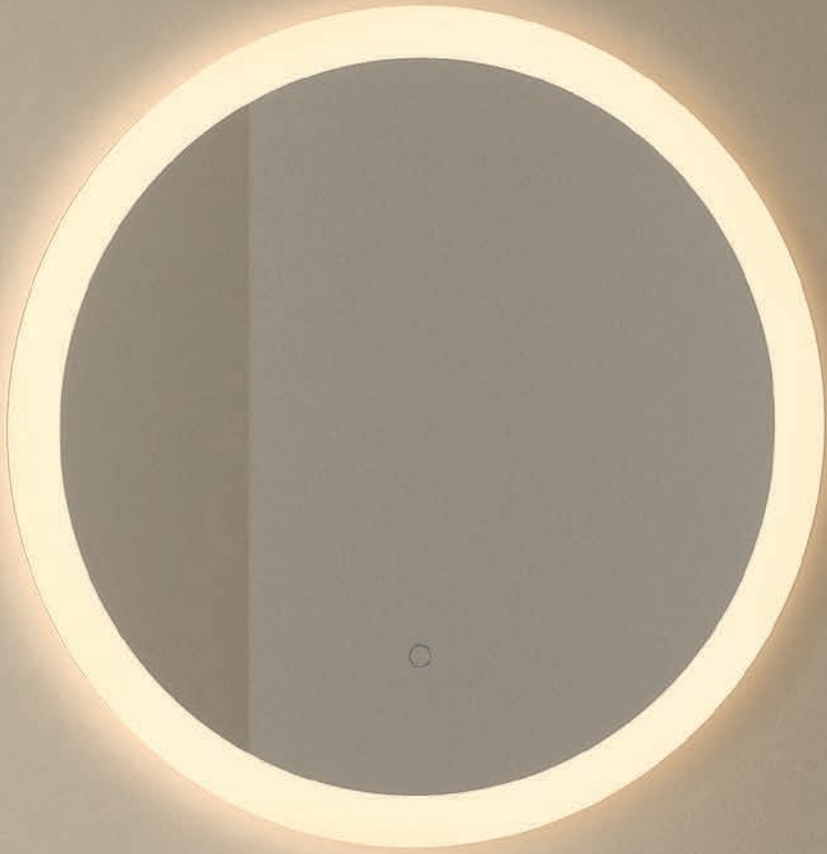



Ascot

ZONES 1 2 3

| | | | LAMP | WATT | INPUT | K | CRI | Lm | IP | CLASS | 🔌 | 🌞 |
|-----------|-----------------------------|---------|--------------|-------|----------|-------------|-----|-----------|----|--------------------------|---|---|
| 650 Round | <input type="checkbox"/> Mi | 1486001 | Integral LED | 27W | 200-240V | 2700 - 6000 | 90 | 620 - 670 | 44 | <input type="checkbox"/> | ✓ | ✓ |
| 700 | <input type="checkbox"/> Mi | 1486002 | Integral LED | 28.9W | 200-240V | 2700 - 6000 | 90 | 703 - 762 | 44 | <input type="checkbox"/> | ✓ | ✓ |
| 800 | <input type="checkbox"/> Mi | 1486003 | Integral LED | 50W | 200-240V | 2700 - 6000 | 90 | 940-1020 | 44 | <input type="checkbox"/> | ✓ | ✓ |

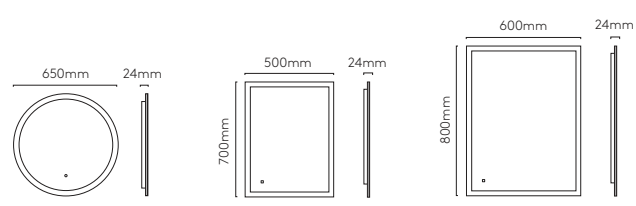



Orb

ZONES 2 3

| | | | | LAMP | WATT | IP | CLASS | | | |
|-------------------|---------|---------|--|------|----------|----|-------|---|---|---|
| Orb | 1424001 | 1424003 | | G9* | 3.5W max | 44 | | ✓ | ✓ | ✓ |
| Orb Single | 1424002 | 1424004 | | G9* | 3.5W max | 44 | | ✓ | ✓ | ✓ |

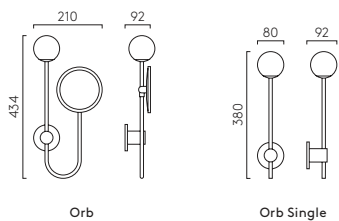

* Lamp excluded / La lampe exclu / Das Leuchtmittel ist ausgeschlossen / La lampadina esclusi.

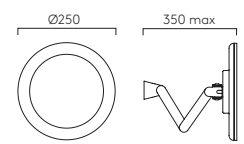

Niimi

ZONES 2 3

| | LAMP | WATT | INPUT | K | CRI | Lm | IP | CLASS | | | | |
|-------------|--------------|------|----------|------|-----|-----|----|-------|---|---|---|---|
| PCh 1163008 | Integral LED | 6W | 100-240V | 3000 | 80 | 146 | 44 | | ✓ | ✓ | ✓ | ✓ |

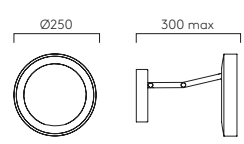

Catena

ZONES 2 3

| | LAMP | WATT | INPUT | K | CRI | Lm | IP | CLASS | | | | |
|-------------|--------------|-------|------------|------|-----|-----|----|-------|---|---|---|---|
| PCh 1137003 | Integral LED | 12.4W | Mains 230V | 3000 | 80 | 216 | 44 | | ✓ | ✓ | ✓ | ✓ |



Nagoya

ZONES 2 3

| | LAMP | WATT | IP | CLASS | | | |
|-------------|------|-------------|----|-------|---|---|---|
| PCh 1447002 | G9* | 2 x 20W max | 44 | | ✓ | ✓ | ✓ |
| MB 1447001 | | | | | | | |

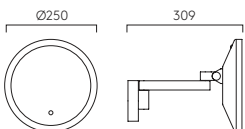

▼ Lamp excluded / La lampe exclu / Das Leuchtmittel ist ausgeschlossen / La lampadina esclusi.



Mascali

ZONES 2 3

| | LAMP | WATT | INPUT | K | CRI | Lm | IP | CLASS | | | | |
|-------------|--------------|------|----------|------|-----|-----|----|-------|---|---|---|---|
| PCh 1373020 | Integral LED | 7.4W | 100-240V | 3000 | 90 | 110 | 44 | □ | ✓ | ✓ | ✓ | ✓ |
| MB 1373022 | | | | | | | | | | | | |

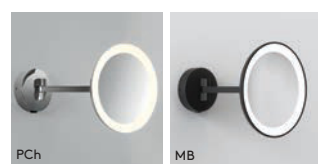
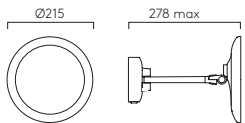



Ottavino Pendant

ZONES 2 3

| | LAMP | WATT | IP | CLASS | | |
|-------------|------|--------|----|-------|---|---|
| PCh 1411002 | E14▼ | 5W max | 44 | | ✓ | ✓ |

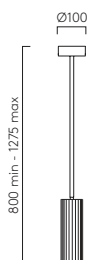

▼ Lamp excluded / La lampe exclu / Das Leuchtmittel ist ausgeschlossen / La lampadina esclusi.



Nara

SHADE EXCLUDED ZONES 1 2 3

| | LAMP | WATT | INPUT | K | CRI | Lm | IP | CLASS | |
|-------------|--------------|------|------------|------|-----|-----|----|-------|---|
| PCh 1464001 | Integral LED | 7.6W | Mains 230V | 3000 | 90 | 324 | 44 | □ | ✓ |
| MB 1464003 | | | | | | | | | |

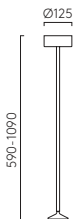

Shade Options



Nara Globe Glass
 [wg] 5039001
 [SR] 5039002



Nara Tapered Glass
 [wg] 5039003
 [SR] 5039004



Nara Cone Glass
 [wg] 5039005







Tacoma Pendant

SHADE EXCLUDED ZONES 2 3

| | LAMP | WATT | IP | CLASS | | |
|-----------------------------------|------|---------|----|-------|---|---|
| AB 1429024 MB 1429025 PCh 1429026 | G9* | 25W max | 44 | | ✓ | ✓ |

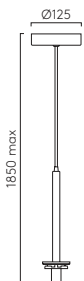

Shade Options

- Round Shade**
 5036001
 5036003
 5036004
 5036005

- Reed Shade**
 5036009
 5036010

- Tulip shade**
 5036007
 5036008

* Lamp excluded/La lampe exclu/Das Leuchtmittel ist ausgeschlossen/La lampadina esclusi.





PCh



MB

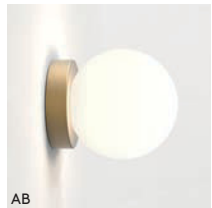

AB

Can be wall or ceiling mounted



AB + Round Shade CR



MB + Tulip Shade SR



MB + Round Shade SR



PCh + Reed Shade WG



Tacoma Surface

SHADE EXCLUDED

ZONES **2 3**

| | LAMP | WATT | IP | CLASS | | |
|--|------|---------|----|-------|---|---|
| MB 1429027 AB 1429028 PCh 1429029 | G9* | 25W max | 44 | | ✓ | ✓ |

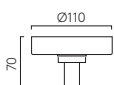

Shade Options

Round Shade (Ø135)

- 5036001
- 5036003
- 5036004
- 5036005

Reed Shade (Ø95)

- 5036009
- 5036010

Tulip shade (Ø124)

- 5036007
- 5036008

* Lamp excluded/La lampe exclu/Das Leuchtmittel ist ausgeschlossen/La lampadina esclusi.
 Can be wall or ceiling mounted/Peut être monté au mur ou au plafond/Kann an der Wand oder Decke montiert werden/ Può essere montato a parete o a soffitto





400 Bronze

Mashiko Ceiling

ZONES 2 3

| | LAMP | WATT | IP | CLASS | 🔄 | 🔍 |
|--|------|-------------|----|--------------------------|---|---|
| Square 200 <input type="checkbox"/> PCh 1121009 <input type="checkbox"/> Br 1121056 | E27* | 60W max | 44 | <input type="checkbox"/> | ✓ | ✓ |
| Square 300 <input type="checkbox"/> PCh 1121005 <input type="checkbox"/> Br 1121079 | E27* | 2 x 60W max | 44 | <input type="checkbox"/> | ✓ | ✓ |
| Square 400 <input type="checkbox"/> PCh 1121010 <input type="checkbox"/> Br 1121013 | E27* | 4 x 40W max | 44 | <input type="checkbox"/> | ✓ | ✓ |
| Round 230 <input type="checkbox"/> PCh 1121021 <input type="checkbox"/> Br 1121097 | E27* | 60W max | 44 | <input type="checkbox"/> | ✓ | ✓ |
| Round 300 <input type="checkbox"/> PCh 1121017 <input type="checkbox"/> Br 1121043 | E27* | 60W max | 44 | <input type="checkbox"/> | ✓ | ✓ |
| Round 400 <input type="checkbox"/> PCh 1121026 <input type="checkbox"/> Br 1121085 | E27* | 3 x 42W max | 44 | <input type="checkbox"/> | ✓ | ✓ |

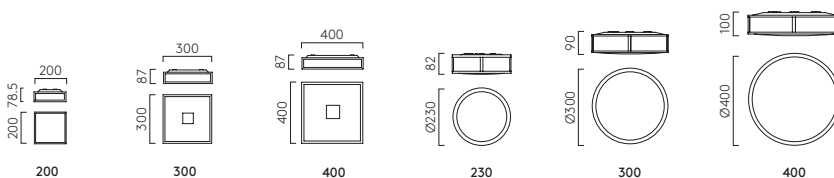

* Lamp excluded / La lampe exclu / Das Leuchtmittel ist ausgeschlossen / La lampadina esclusi.



Lyra Ceiling

ZONES 2 3

| | | LAMP | WATT | IP | CLASS | | |
|-----|---------|------|---------|----|-------|---|---|
| 140 | 1472003 | G9▼ | 10W max | 44 | | ✓ | ✓ |
| 180 | 1472004 | E27▼ | 20W max | 44 | | ✓ | ✓ |

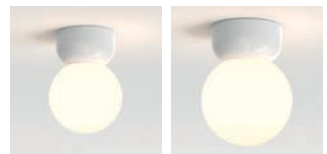
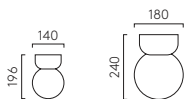

▼ Lamp excluded / La lampe exclu / Das Leuchtmittel ist ausgeschlossen / La lampadina esclusi.



Arezzo Ceiling

ZONES **2** **3**

| | LAMP | WATT | IP | CLASS |  |  |
|-------------|------|---------|----|---|---|---|
| PCh 1049003 | E27* | 12W max | 44 |  | <input checked="" type="checkbox"/> | <input checked="" type="checkbox"/> |

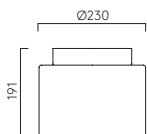

* Lamp excluded / La lampe exclu / Das Leuchtmittel ist ausgeschlossen / La lampadina esclusi.



Zeppo Ceiling

ZONES 2 3

| | LAMP | WATT | IP | CLASS | | |
|---------------------------|------|---------|----|-------|---|---|
| PCh 1176001 MB 1176017 | E27* | 60W max | 44 | | ✓ | ✓ |

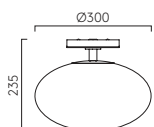

* Lamp excluded / La lampe exclu / Das Leuchtmittel ist ausgeschlossen / La lampadina esclusi.



Denver

ZONES 2 3

| | LAMP | WATT | IP | CLASS | | |
|---------------------------|------|---------|----|-------|---|---|
| PCh 1038001 MB 1038005 | G9* | 40W max | 44 | | ✓ | ✓ |

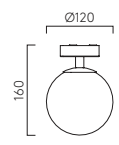

* Lamp excluded / La lampe exclu / Das Leuchtmittel ist ausgeschlossen / La lampadina esclusi.



Aquina Ceiling

ZONES 2 3

| | | | | LAMP | WATT | IP | CLASS | | |
|-----|---------|---------|--|------|-------------|----|-------|---|---|
| 240 | 1450003 | 1450009 | | E27▼ | 12W max | 44 | | ✓ | ✓ |
| 360 | 1450004 | 1450011 | | E27▼ | 2 X 12W max | 44 | | ✓ | ✓ |

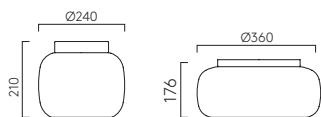

▼ Lamp excluded / La lampe exclu / Das Leuchtmittel ist ausgeschlossen / La lampadina esclusi.

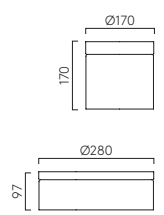
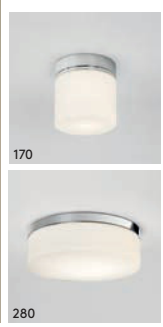

Sabina

ZONES 2 3

| | | LAMP | WATT | IP | CLASS | | |
|-----|---------|------|---------|----|-------|---|---|
| 170 | 1292001 | E27* | 12W max | 44 | | ✓ | ✓ |
| 280 | 1292003 | E27* | 12W max | 44 | | ✓ | ✓ |

* Lamp excluded / Das Leuchtmittel ist ausgeschlossen / La lampadina esclusi

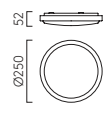

Denia

ZONES 2 3

| | | LAMP | WATT | IP | CLASS | | |
|--|---------|------|-------------|----|-------|---|---|
| | 1134001 | E14* | 2 x 40W LED | 44 | | ✓ | ✓ |

* Lamp excluded / La lampe exclu / Das Leuchtmittel ist ausgeschlossen / La lampadina esclusi.

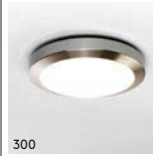

300

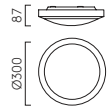

Dakota

ZONES 2 3

| | | LAMP | WATT | IP | CLASS | | |
|-----|---------|------|---------|----|-------|-------------------------------------|-------------------------------------|
| 300 | 1129001 | E27* | 60W max | 44 | | <input checked="" type="checkbox"/> | <input checked="" type="checkbox"/> |

▼ Lamp excluded / Das Leuchtmittel ist ausgeschlossen / La lampadina esclusi

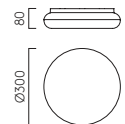

Altea

ZONES 2 3

| | | LAMP | WATT | IP | CLASS | | |
|-----|---------|------|---------|----|-------|-------------------------------------|-------------------------------------|
| 300 | 1133002 | E27* | 60W max | 44 | | <input checked="" type="checkbox"/> | <input checked="" type="checkbox"/> |

▼ Lamp excluded / La lampe exclu / Das Leuchtmittel ist ausgeschlossen / La lampadina esclusi.

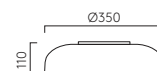
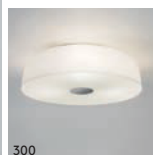

Syros

ZONES 2 3

| | LAMP | WATT | IP | CLASS | | |
|------------|------|-------------|----|-------|---|---|
| WG 1328001 | E27* | 3 x 40W max | 44 | | ✓ | ✓ |

* Lamp excluded / La lampe exclu / Das Leuchtmittel ist ausgeschlossen / La lampadina esclusi.

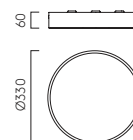

Mallon LED

ZONES 2 3

| | LAMP | WATT | INPUT | K | CRI | Lm | IP | CLASS | | | |
|-----------------------------------|--------------|-------|------------|-----------------|-----|---------|----|-------|---|---|---|
| PCh 1125014 MN 1125015 Br 1125016 | Integral LED | 15.3W | Mains 230V | 2700/3000/4000* | 90 | 670-733 | 44 | | ✓ | ✓ | ✓ |

* Colour temperature can be adjusted between stated values via onboard switch / La température de couleur peut être ajustée entre les valeurs indiquées via un interrupteur intégré. / Die Farbtemperatur kann mit dem eingebauten Schalter zwischen den angegebenen Werten eingestellt werden. / Die Farbtemperatur kann mit dem eingebauten Schalter zwischen den angegebenen Werten eingestellt werden. / La temperatura di colore può essere impostata tra valori indicati tramite interruttore a bordo.



Ottawa

ZONES 2 3

| | LAMP | WATT | IP | CLASS | |
|---|-------|--------|----|-------|----------|
| MB 1474001 MW 1474002 | GU10* | 6W max | 65 | | |



▼ Lamp excluded / La lampe exclu / Das Leuchtmittel ist ausgeschlossen / La lampadina esclusi.



Kos

ZONES 1 2 3

| | | | | LAMP | WATT | INPUT | K | CRI | Lm | IP | CLASS | | |
|---------------|---------|---------|--|--------------|---------|----------|------|-----|-----|----|-------|-------|---|
| Round 85 | 1326039 | 1326040 | | GU10▼ | 6W max | - | - | - | - | 65 | | ✓ | - |
| | 1326041 | 1326042 | | GU10▼ | 6W max | - | - | - | - | 65 | | ✓ | - |
| Round 100 LED | 1326061 | 1326062 | | Integral LED | 210-250 | 210-250V | 3000 | 80 | 316 | 65 | | Phase | ✓ |
| Round 140 LED | 1326067 | 1326068 | | Integral LED | 12.8W | 220-240V | 3000 | 80 | 761 | 65 | | Phase | ✓ |
| Square 85 | 1326043 | 1326044 | | GU10▼ | 6W max | - | - | - | - | 65 | | ✓ | - |

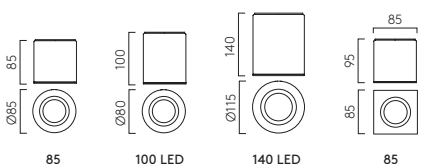

▼ Lamp excluded / La lampe exclu / Das Leuchtmittel ist ausgeschlossen / La lampadina esclusi.













The Void range must be installed before plastering
 / La gamme Void doit être impérativement installée
 avant plafonnage. / Die Void Produktreihe muss
 vor dem Verputzen eingebaut werden. / La linea
 Void deve essere installata prima della posa del
 controsoffitto.

Void 80

Void

ZONES 1 2 3

| | | | LAMP | WATT | IP | CLASS |  | Recess depth |  |  |  | |
|----|---|--|-------|--------|----|---|---|--------------|---|---|---|---|
| 55 |  1392017 | | GU10* | 6W max | 65 |  |  | Ø70 | 163 | ✓ | ✓ | - |
| 80 |  1392019 | | GU10* | 6W max | 65 |  |  | Ø98 | 163 | ✓ | ✓ | - |

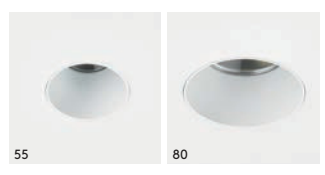
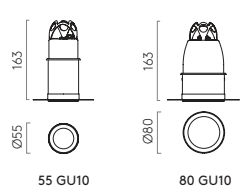

* Lamp excluded / La lampe exclu / Das Leuchtmittel ist ausgeschlossen / La lampadina esclusi.
 ♦ Please see our website for more information about our fire rated products.



The Trimless range must be installed before plastering
 / La gamme Trimless doit être impérativement
 installée avant plâtrage. / Die Trimless
 Produktreihe muss vor dem Verputzen eingebaut
 werden. / La linea Trimless deve essere installata
 prima della posa del controsoffitto.

Trimless

ZONES 1 2 3

| | | LAMP | WATT | IP | CLASS | | Recess depth | | |
|---|----------|-------|--------|----|-------|----------------|--------------|---|---|
| Round Slimline Fixed Fire-rated IP65 | 1248017* | GU10* | 6W max | 65 | | Ø79 | 150 | ✓ | ✓ |
| Square Fixed Fire-rated IP65 | 1248005* | GU10* | 6W max | 65 | | H: 95 W: 95 | 182 | ✓ | ✓ |



▼ Lamp excluded / La lampe exclu / Das Leuchtmittel ist ausgeschlossen / La lampadina esclusi.

▲ Please see our website for more information about our fire rated products.

* Slimline downlights are compatible with our range of LED Modules which allow higher output and more specification options than GU10 lamps. / Les downlights Slimline sont compatibles avec notre gamme de modules LED ce qui offre un rendement supérieur et beaucoup plus d'options que les ampoules GU10. / Slimline-Downlights sind mit unserem Angebot an LED-Modulen kompatibel, die eine höhere Leistung und mehr Spezifikationsmöglichkeiten als GU10-Lampen bieten. / I faretti Slimline sono compatibili con la nostra gamma di Moduli LED che permettono una maggiore luminosità e più specifiche di progetto rispetto alle lampade GU10. See p.404



Pinhole

ZONES 1 2 3

| | | LAMP | WATT | IP | CLASS | Recess depth | | | |
|---|----------|-------|--------|----|-------|--------------|---|---|---|
| Round Slimline Fixed Fire-rated IP65 | 1434001* | GU10* | 6W max | 65 | | Ø70 150 | ✓ | ✓ | ✓ |
| Round Slimline Flush Fixed Fire-rated IP65 | 1434007* | GU10* | 6W max | 65 | | Ø62 150 | ✓ | ✓ | ✓ |
| Square Slimline Square Fixed Fire-rated IP65 | 1434002* | GU10* | 6W max | 65 | | Ø70 150 | ✓ | ✓ | ✓ |

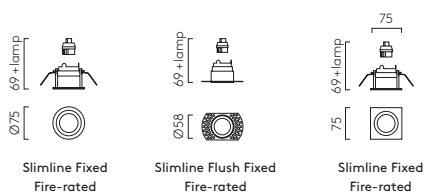

▼ Lamp excluded / La lampe exclu / Das Leuchtmittel ist ausgeschlossen / La lampadina esclusi.

♦ Please see our website for more information about our fire rated products.

* Slimline downlights are compatible with our range of LED Modules which allow higher output and more specification options than GU10 lamps. / Les downlights Slimline sont compatibles avec notre gamme de modules LED, ce qui offre un rendement supérieur et beaucoup plus d'options que les ampoules GU10. / Slimline-Downlights sind mit unserem Angebot an LED-Modulen kompatibel, die eine höhere Leistung und mehr Spezifikationsmöglichkeiten als GU10-Lampen bieten. / I faretti Slimline sono compatibili con la nostra gamma di Moduli LED che permettono una maggiore luminosità e più specifiche di progetto rispetto alle lampade GU10. See p.404

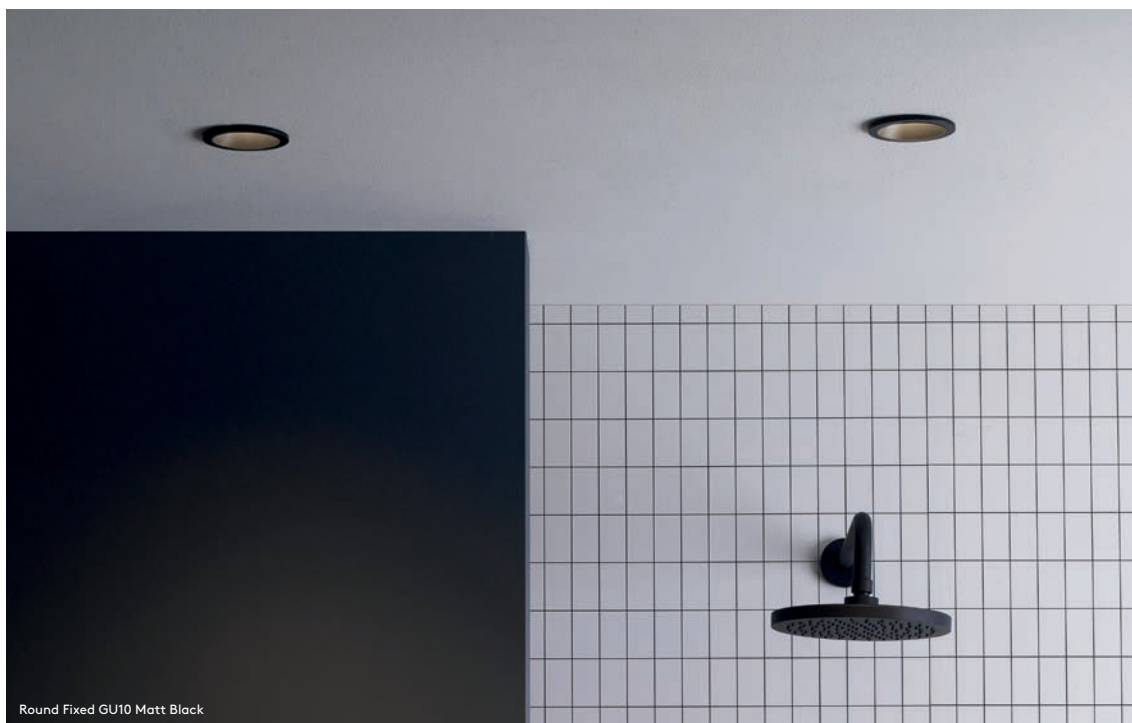

Round Fixed GU10 Matt Black



1249023

1249012

1249017

1249034

1249035

1249036

1249037

1249018

1249038

1249039

Minima

ZONES 1 2 3

| | | | LAMP | WATT | INPUT | K | CRI | Lm | IP | CLASS | | Recess depth | | | |
|---------------------------------------|--------------------------------------|--------------------------------------|-------------------|---------|------------|------|-----|-----|----|-------|----------------|--------------|--------------|---|---|
| Round Fixed IP65 | <input type="checkbox"/> MW 1249012 | <input type="checkbox"/> MB 1249017 | GU10 [▼] | 50W max | - | - | - | - | 65 | □ | Ø76 | 150 | ✓ | - | - |
| Round Fixed LED Fire-rated IP65 | <input type="checkbox"/> MW 1249023 | | Integral LED | 8W | Mains 230V | 2700 | 90 | 665 | 65 | ◇ | Ø86 | 150 | Phase +1-10V | ✓ | ✓ |
| Round Slimline Fixed Fire-rated IP65 | <input type="checkbox"/> MW 1249034* | <input type="checkbox"/> MB 1249035* | GU10 [▼] | 6W max | - | - | - | - | 65 | □ | Ø86 | 150 | ✓ | ✓ | - |
| Round Slimline 25 Fire-rated IP65 | <input type="checkbox"/> MW 1249036* | <input type="checkbox"/> MB 1249037* | GU10 [▼] | 6W max | - | - | - | - | 65 | □ | Ø86 | 150 | ✓ | ✓ | - |
| Square Fixed IP65 | <input type="checkbox"/> MW 1249018 | | GU10 [▼] | 50W max | - | - | - | - | 65 | □ | Ø76 | 150 | - | - | - |
| Square Slimline Fixed Fire-rated IP65 | <input type="checkbox"/> MW 1249038* | <input type="checkbox"/> MB 1249039* | GU10 [▼] | 6W max | - | - | - | - | 65 | □ | W: 86 H: 86 | 150 | ✓ | ✓ | - |

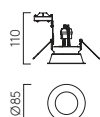

Fixed

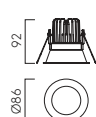

Fixed LED Fire-rated

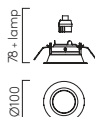

Slimline Fixed Fire-rated

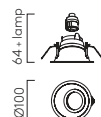

Slimline 25 Fire-rated IP65

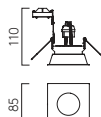

Fixed

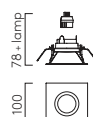

Slimline Fixed Fire-rated

▼ Lamp excluded / La lampe exclu / Das Leuchtmittel ist ausgeschlossen / La lampadina esclusi.

◆ Please see our website for more information about our fire rated products.

* Slimline downlights are compatible with our range of LED Modules which allow higher output and more specification options than GU10 lamps. / Les downlights Slimline sont compatibles avec notre gamme de modules LED ce qui offre un rendement supérieur et beaucoup plus d'options que les ampoules GU10. / Slimline-Downlights sind mit unserem Angebot an LED-Modulen kompatibel, die eine höhere Leistung und mehr Spezifikationsmöglichkeiten als GU10-Lampen bieten. / I faretti Slimline sono compatibili con la nostra gamma di Moduli LED che permettono una maggiore luminosità e più specifiche di progetto rispetto alle lampade GU10. See p.404

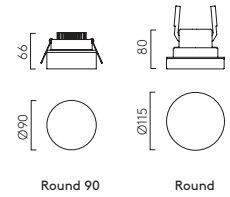
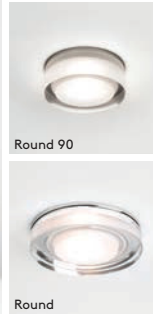

Vancouver

ZONES 1 2 3

| | CA | PCh | 1229012 | LAMP | WATT | INPUT | K | CRI | Lm | IP | CLASS | ☎ | 🔌 | 🌀 | 🌍 |
|----------|----|-----|---------|--------------|--------|--------|------|-----|-----|----|-------|-----|---|---|---|
| Round 90 | CA | PCh | 1229012 | Integral LED | 6.1W | 350mA* | 3000 | 80 | 681 | 44 | ◆ | Ø79 | ✓ | - | ✓ |
| Round | CA | PCh | 1229003 | GU10* | 6W max | - | - | - | - | 65 | □ | Ø89 | ✓ | ✓ | - |

* Lamp + driver excluded / La lampe driver d'entrée exclu / La lampadina + driver esclusi / Das Leuchtmittel + das treiber ist ausgeschlossen

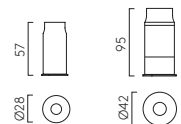
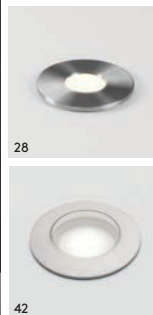

Terra

ZONES 1 2 3

| | BSS | 1201005 | LAMP | WATT | INPUT | K | CRI | Lm | IP | CLASS | ☎ | 🔌 | 🌀 | 🌍 |
|----|-----|---------|--------------|------|--------|------|-----|-----|----|-------|-----|---|---|---|
| 28 | BSS | 1201005 | Integral LED | 1.8W | 350mA* | 3000 | 80 | 53 | 65 | ◆ | Ø25 | ✓ | ✓ | |
| 42 | BSS | 1201007 | Integral LED | 3.2W | 700mA* | 3000 | 80 | 169 | 67 | ◆ | Ø40 | ✓ | ✓ | |

* Driver excluded / Driver d'entrée exclu / Das treiber ist ausgeschlossen / Driver esclusi.



Aqua Single

Aqua

ZONES 2 3

| | | LAMP | WATT | IP | CLASS | | |
|---------------------|---------|-------------------|------------|----|-------|---|---|
| Single | 1393001 | GU10 [▼] | 6W max | 44 | | ✓ | ✓ |
| Recessed | 1393007 | GU10 [▼] | 6W max | 44 | | ✓ | ✓ |
| Triple Round | 1393002 | GU10 [▼] | 3 x 6W max | 44 | | ✓ | ✓ |

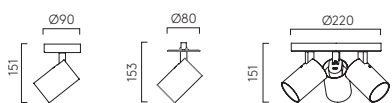

▼ Lamp excluded/La lampe exclu/Das Leuchtmittel ist ausgeschlossen/La lampadina esclusi.

Interior Lighting



Tacoma Collection

| | |
|---------|--------|
| Wall | P. 148 |
| Surface | P. 278 |
| Pendant | P. 280 |



Club Collection

| | |
|--------|--------|
| Wall | P. 126 |
| Reader | P. 176 |
| Table | P. 254 |
| Floor | P. 254 |



Beaumont Collection

| | |
|--------|--------|
| Wall | P. 124 |
| Reader | P. 174 |
| Table | P. 252 |
| Floor | P. 252 |



Atelier Collection

| | |
|-------------|--------|
| Wall | P. 172 |
| Grande Wall | P. 173 |
| Desk | P. 242 |



Imari Collection

Fixed Wall P. 165
Adjustable Wall P. 165
Desk P. 238



Edward Collection

| | |
|-------|--------|
| Wall | P. 166 |
| Twin | P. 167 |
| Desk | P. 240 |
| Floor | P. 241 |



Miura Collection

Wall P. 168
Swing Arm P. 169
Desk P. 243



Mitsu Collection

| | |
|-----------|--------|
| Wall | P. 170 |
| Swing Arm | P. 171 |
| Table | P. 256 |
| Floor | P. 257 |



Zeppo Collection

| | |
|----------|--------|
| Wall | P. 224 |
| Reader | P. 200 |
| Portable | P. 235 |
| Ceiling | P. 277 |
| Pendant | P. 291 |



Leda Collection

| | |
|-------|--------|
| Wall | P. 187 |
| Swing | P. 187 |
| Desk | P. 246 |
| Floor | P. 247 |



Venn Collection

| | |
|-------------|--------|
| Wall | P. 128 |
| Reader | P. 180 |
| Reader Twin | P. 180 |
| Table | P. 258 |
| Floor | P. 259 |



Ascoli Collection

| | | | |
|-----------------|--------|---------------|--------|
| Single | P. 316 | Twin | P. 316 |
| Single Switched | P. 316 | Twin Recessed | P. 316 |
| Single Recessed | P. 316 | Triple Round | P. 317 |
| Swing Arm | P. 186 | 3/4/5 Bar | P. 317 |
| Desk | P. 248 | Track | P. 318 |
| Floor | P. 249 | | |



Enna Collection

| | | | |
|-------------|--------|--------|--------|
| Swing | P. 188 | Recess | P. 192 |
| Surface USB | P. 189 | Twin | P. 193 |
| Square | P. 190 | Desk | P. 250 |
| Surface | P. 191 | Floor | P. 251 |



Park Lane Collection

| | |
|-----------|--------|
| Park Lane | P. 136 |
| Grande | P. 137 |
| Reader | P. 182 |
| Table | P. 262 |
| Floor | P. 263 |



Ravello Collection

| | |
|--------|--------|
| Wall | P. 135 |
| Reader | P. 183 |
| Table | P. 260 |
| Floor | P. 261 |



Cambria Collection

Cambria 180 P. 138
Cambria Ceiling P. 268
Cambria Pendant P. 289



Elba Collection

| | |
|----------------|--------|
| Wall | P. 151 |
| Ceiling Round | P. 266 |
| Ceiling Square | P. 266 |

Interior Lighting



NEW
Beaumont Wall
P. 124



NEW
Club Wall
P. 126



Venn Wall
P. 128



Lima
P. 129



Caserta
P. 130



Tate
P. 131



Arbor
P. 132



Riva 350
P. 133



Napoli
P. 134



Ravello Wall
P. 135



Park Lane
P. 136



Park Lane Grande
P. 137



Cambria 180
P. 138



Ashino
P. 139



ios 250 Shade
P. 139



Beauville
P. 140



Lago 280
P. 141



NEW
Luna
P. 142



Toro
P. 144



Ottavino Wall
P. 145



Veo
P. 146



Ella Wall
P. 147



Tacoma
P. 148



Ako
P. 150



Elba Wall
P. 151



Hashira 300
P. 152



Yuma
P. 153



Avignon
P. 154



io Wall
P. 155



Harvard Wall
P. 156



Boston
P. 157



Versailles
P. 158



Montreal
P. 160



Jura
P. 161



Ito
P. 162



Carlton Wall
P. 163



Serge
P. 164



Imari Wall
P. 165



Edward Wall
P. 166



Edward Twin
P. 167



Miura Wall
P. 168



Miura Swing Arm
P. 169



Mitsu wall
P. 170

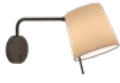

Mitsu Swing Arm
P. 171



Atelier Wall
P. 172



Atelier Grande Wall
P. 173



NEW
Beaumont Reader
P. 174



NEW
Club Reader
P. 176



Side by Side
P. 178



Side by Side Grande USB
P. 179



Venn Reader/Twin
P. 180



Napoli Reader
P. 181



Park Lane Reader
P. 182



Ravello Reader
P. 183



NEW
Gio
P. 184



Ascoli Swing
P. 186



Leda Single
P. 187



Leda Swing Arm
P. 187



Enna Swing
P. 188



Enna Surface USB
P. 189



Enna Square Switched
P. 190



Enna Surface
P. 191



Enna Recess Switched
P. 192



Enna Twin
P. 193



Micro Recess
P. 194



Keta
P. 195



Fuse 3
P. 196



Digit
P. 197



Tosca
P. 198



Baton
P. 199



Zeppo Reader
P. 200



Edge Reader Mini
P. 201



Lucca
P. 202



Fosso
P. 203



Leo
P. 203



NEW
Comino
P. 204



Velo
P. 206



Aria 300
P. 207



Parma
P. 208



Parma
P. 209



Shadow 300
P. 210



Pella + Pienza
P. 211



Koza
P. 212



Kymi
P. 213



Pero
P. 214



Mosto
P. 215



Serifos
P. 216



Bologna 240
P. 217



Eclipse Round
P. 218



Blend
P. 219



Amas + Amat
P. 220



Amalfi
P. 221



Kyo
P. 221



Milo
P. 222



Parallel
P. 222



Tokyo
P. 223



Zeppo Wall
P. 224



Cyl
P. 225



Luga
P. 225



Goya
P. 226



Renoir
P. 227



Mondrian
P. 228



Leros Trimless
P. 230



Tango
P. 231



Borgo Trimless
P. 232



Borgo
P. 233



Halo Portable
P. 234



Zeppo Portable
P. 235



Ella Table
P. 236



Carlton Desk
P. 237



Imari Desk
P. 238



Gerrit
P. 239



Edward Desk
P. 240



NEW
Edward Floor
P. 241



Atelier Desk
P. 242



Miura Desk USB
P. 243



Joel Table
P. 244



Joel Floor
P. 245



Leda Desk
P. 246



Leda Floor
P. 247



Ascoli Desk
P. 248



Ascoli Floor
P. 249



Enna Desk
P. 250



Enna Floor
P. 251



NEW
Beaumont Table
P. 252



NEW
Beaumont Floor
P. 252



NEW
Club Table
P. 254



NEW
Club Floor
P. 254



Mitsu Table
P. 256



Mitsu Floor
P. 257



Venn Table
P. 258



Venn Floor
P. 259



Ravello Table
P. 260



Ravello Floor
P. 261



Park Lane Table
P. 262



Park Lane Floor
P. 263



Cut
P. 264



Marasino
P. 265



Limina
P. 265



Elba Ceiling Square
P. 266



Cambria
P. 268



Fife
P. 269



Salina
P. 270



Bevel Round
P. 271



Mashiko
P. 272



Taiko
P. 274



Mallon LED
P. 275



Aquila Ceiling
P. 276



Zeppo Ceiling
P. 277



NEW
Tacoma Surface
P. 278



NEW
Tacoma Pendant
P. 280



NEW
Vevo Pendant
P. 282



NEW
Taiko Pendant
P. 284



Pendant
Suspension Kit 3
P. 286



Pendant
Suspension Kit 4
P. 288



Cambria Pendant
P. 289



io Pendant
P. 290



Zeppo Pendant
P. 291



Hashira Pendant
P. 292



Osca Pendant 400
P. 293



Ginestra
P. 294



Homefield
Pendant
P. 295



Pinhole
P. 298



Void
P. 299



Trimless
P. 300 - 301



Blanco
P. 302



Taro
P. 303



Minima
P. 304 - 305



Ottawa
P. 306



Kos
P. 307



Shadow Surface
P. 308



Osca
P. 309



NEW
Juno Recessed
P. 310



NEW
Juno Single
P. 310



NEW
Juno Triple/
Four Bar
P. 310



Lynx
P. 312



Can
P. 313



Apollo single/
100 Recessed
P. 314



Koto Single/
Switched/Recessed
P. 315



Koto Triple Round
P. 315



Koto 3/4/5 Bar
P. 315



Ascoli Single/
Recessed/
Switched/Flush
P. 316



Ascoli Twin/
Twin Recessed
P. 316



Ascoli Triple Round
/3/4/5 Bar
P. 317



Apollo 100 Track
P. 318



Ascoli Track Spot
P. 318



Koto Track Spot
P. 318



Can Track Spot
P. 318



Track Pendant
P. 318





Beaumont Wall

SHADE EXCLUDED

| | LAMP | WATT | CLASS | |
|------------|------|---------|-------|---|
| MB 1480013 | E27* | 60W max | ⊕ | ✓ |

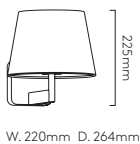

French Drum 220

PF 5047001

WF 5047002



* Lamp excluded/La lampe exclu/Das Leuchtmittel ist ausgeschlossen/La lampadina esclusi.

Made to Order Alternative finish options are available as Made to Order for this product subject to minimum order quantities and extended lead times. / D'autres options de finition sur commande sont disponibles pour ce produit, sous condition d'un volume de commande minimum et de délais de livraison prolongés. / Alternative Ausführungen sind für dieses Produkt als Sonderanfertigung erhältlich und unterliegen einer Mindestbestellmenge und längeren Lieferzeiten. / Diverse finiture alternative sono disponibili su misura per questo prodotto con quantitativi minimi e tempi di consegna allungati. See website.





Wall MB



WALL

NEW

Club Wall

SHADE EXCLUDED

| | LAMP | WATT | CLASS | |
|------------|------|---------|-------|---|
| Br 1483010 | E27* | 12W max | | ✓ |



French Drum 220

- 5047001
- 5047002



* Lamp excluded/La lampe exclu/Das Leuchtmittel ist ausgeschlossen/La lampadina esclusi.



Venn Wall

SHADE EXCLUDED

| MN | Br | LAMP | WATT | CLASS | | |
|---------|---------|------------------|---------|-------|-------------------------------------|--------------------------|
| 1433007 | 1433003 | E27 [▼] | 12W max | | <input checked="" type="checkbox"/> | <input type="checkbox"/> |



W. 315 D.135

Stadium 160
shade options

- WF 5043002
- PF 5043001



• Special Shade Colours / Couleurs spéciales / Sonderfarben / Colori speciali. See p.404

▼ Lamp excluded / La lampe exclu / Das Leuchtmittel ist ausgeschlossen / La lampadina esclusi.

Made to Order Alternative finish options are available as Made to Order for this product subject to minimum order quantities and extended lead times. / D'autres options de finition sur commande sont disponibles pour ce produit, sous condition d'un volume de commande minimum et de délais de livraison prolongés / Alternative Ausführungen sind für dieses Produkt als Sonderanfertigung erhältlich und unterliegen einer Mindestbestellmenge und längeren Lieferzeiten / Diverse finiture alternative sono disponibili su misura per questo prodotto con quantitativi minimi e tempi di consegna allungati. See website.



Lima

SHADE EXCLUDED

Br 1318009

| LAMP | WATT | CLASS | |
|------|---------|-------|---|
| E27* | 60W max | | ✓ |

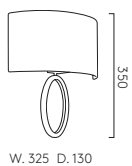

Semi Drum 320
Shade options

- 5026001
- 5026002
- 5026005





• Special Shade Colours / Couleurs spéciales / Sonderfarben / Colori speciali. See p.404
 * Lamp excluded / La lampe exclu / Das Leuchtmittel ist ausgeschlossen / La lampadina esclusi.



Caserta

SHADE EXCLUDED

Br 1349010

| LAMP | WATT | CLASS |  |
|------|---------|---|---|
| E27* | 60W max |  | ✓ |

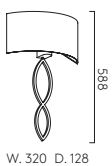

Semi Drum 320
Shade options

| | |
|----|---------|
| WF | 5026001 |
| BF | 5026002 |
| PF | 5026005 |

W. 320 D. 128

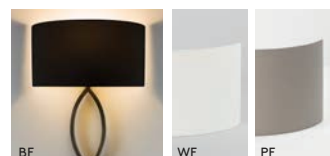

- Special Shade Colours / Couleurs spéciales / Sonderfarben / Colori speciali. See p.404
- ▼ Lamp excluded / La lampe exclu / Das Leuchtmittel ist ausgeschlossen / La lampadina esclusi.



Black Fabric Shade

Tate

SHADE EXCLUDED

| | LAMP | WATT | CLASS | |
|------------|------|---------|-------|---|
| Br 1334007 | E27* | 60W max | | ✓ |

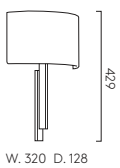

Semi Drum 320
Shade options

- 5026001
- 5026002
- 5026005

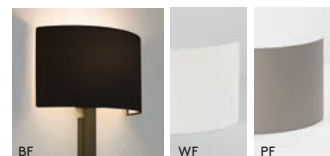

• Special Shade Colours / Couleurs spéciales / Sonderfarben / Colori speciali. See p.404
 * Lamp excluded / La lampe exclu / Das Leuchtmittel ist ausgeschlossen / La lampadina esclusi



Arbor

| Plug-in | MB 1479001 | MW 1479002 | LAMP | WATT | CLASS | <input type="checkbox"/> |
|---------|------------|------------|-------|--------|--------------------------|--------------------------|
| | | | E14 ▼ | 7W max | <input type="checkbox"/> | ✓ |

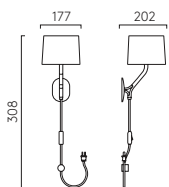

▼ Lamp excluded/La lampe exclu/Das Leuchtmittel ist ausgeschlossen/La lampadina esclusi.
 * One cable guide included. Additional quantities are available to purchase separately./Un guide câble fourni. Des quantités supplémentaires sont disponibles à l'achat séparément./Eine Kabelführung enthalten. Zusätzliche Mengen sind separat zu erwerben./È incluso un guida cavi. Quantità aggiuntive possono essere acquistate separatamente. See P. xxxxy./Un guide câble fourni. Des quantités supplémentaires sont disponibles à l'achat séparément./Eine Kabelführung enthalten. Zusätzliche Mengen sind separat zu erwerben./È incluso un guida cavi. Quantità aggiuntive possono essere acquistate separatamente. See p.404



Bronze + Putty Fabric shade

Riva 350

SHADE EXCLUDED

| | | | | LAMP | WATT | CLASS | |
|----|---------|-----|---------|------|---------|-------|---|
| MN | 1214004 | Br | 1214010 | E27* | 60W max | | ✓ |
| MB | 1214015 | PCh | 1214001 | | | | |

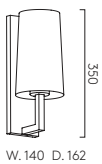

Cone 240
Shade options

| | |
|----|---------|
| WG | 5018007 |
| WF | 5018004 |
| PF | 5018014 |



- Special Shade Colours / Couleurs spéciales / Sonderfarben / Colori speciali. See p.404
- Lamp excluded / La lampe exclu / Das Leuchtmittel ist ausgeschlossen / La lampadina esclusi.



Napoli

SHADE EXCLUDED

| | LAMP | WATT | CLASS | |
|-------------------|-------------|----------------|-------|-------------------------------------|
| MN 1185001 | E27* | 60W max | | <input checked="" type="checkbox"/> |

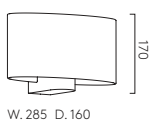

Oval 285
shade options

| | |
|----|---------|
| WF | 5014001 |
| OF | 5014003 |
| PF | 5014004 |



* Special Shade Colours/Couleurs spéciales/Sonderfarben/Colori speciali. See p.404
 ▼ Lamp excluded/La lampe exclu/Das Leuchtmittel ist ausgeschlossen/La lampadina esclusi.



Bronze + White Fabric Drum 250 Shade

Ravello Wall

SHADE EXCLUDED

| | LAMP | WATT | CLASS | |
|--|------|---------|--------------------------|-------------------------------------|
| <input type="checkbox"/> PCh 1222012 <input type="checkbox"/> MN 1222013 <input type="checkbox"/> Br 1222040 | E27* | 60W max | <input type="checkbox"/> | <input checked="" type="checkbox"/> |

Shade Options

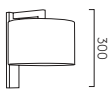

W. 250 D. 282

Drum 250

- WF 5016007
- OF 5016009
- PF 5016019



W. 135 D. 225

Tube 135

- WF 5015004
- OF 5015006
- PF 5015007



* Special Shade Colours / Couleurs spéciales / Sonderfarben / Colori speciali. See p.404
 * Lamp excluded / La lampe exclu / Das Leuchtmittel ist ausgeschlossen / La lampadina esclusi.



Park Lane

| | LAMP | WATT | CLASS |  |
|---|----------------|---------|---|---|
| White Shade Incl.* Br 1080044 | E14 Golf Ball▼ | 60W max |  | ✓ |

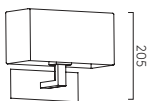

W. 250 D. 141



▼ Lamp excluded / La lampe exclu / Das Leuchtmittel ist ausgeschlossen / La lampadina esclusi.

* Oyster coloured shades (ref: 5001013) available to order separately. / Les abat-jours couleur coquille d'huître (ref: 5001013) peuvent être commandés séparément. / Schirme in der Farbe Oyster (Art. Nr.: 5001013) können separat bestellt werden. / Sono disponibili paralumi di colore 'oyster' (ref: 5001013), da ordinare separatamente.



Oyster Shade

Park Lane Grande

SHADE EXCLUDED

| | LAMP | WATT | CLASS | |
|------------|------|---------|-------|---|
| Br 1080045 | E27* | 60W max | ⊕ | ✓ |

Shade Options

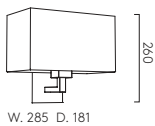

Rectangle 285

| | | | |
|----|---------|----|---------|
| WF | 5001001 | PF | 5001017 |
| BF | 5001003 | MF | 5011009 |
| OF | 5001007 | | |

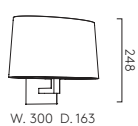

Tapered Oval*

| | |
|----|---------|
| WF | 5034001 |
| OF | 5034003 |
| PF | 5034004 |



* Special Shade Colours / Couleurs spéciales / Sonderfarben / Colori speciali. See p.404

▼ Lamp excluded / La lampe exclu / Das Leuchtmittel ist ausgeschlossen / La lampadina esclusi.

* To be used with LED lamp only / Pour utilisation avec lampe LED seulement / nur mit Kompaktleuchtstofflampe / LED verwenden / Solo per l'uso con lampade a LED.



Cambria 180 Shade

| | WF | OF | PF | BACKPLATE EXCL. | LAMP | WATT | CLASS | |
|--|---------|---------|---------|-----------------------|------|---------|-------|---|
| | 5038007 | 5038008 | 5038009 | Backplate 3 - 1367003 | E27* | 60W max | | ☑ |



W. 315 D. 120

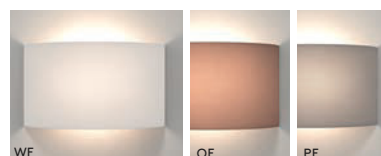

• Special Shade Colours/Couleurs spéciales/Sonderfarben/Colori speciali. See p.404
 ▼ Lamp excluded/La lampe exclu/Das Leuchtmittel ist ausgeschlossen/La lampadina esclusi

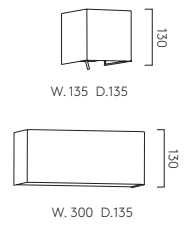
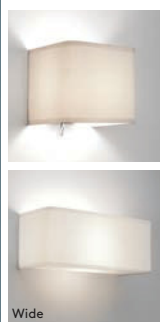

Ashino

| | | LAMP | WATT | CLASS | | |
|-------------|---------|----------------|---------|-------|---|---|
| Ashino | 1166001 | E14 Golf Ball* | 60W max | | ✓ | ✓ |
| Ashino Wide | 1166002 | E27* | 60W max | | ✓ | - |

* Lamp excluded / La lampe exclu/ Das Leuchtmittel ist ausgeschlossen/ La lampadina esclusi

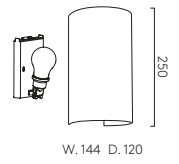
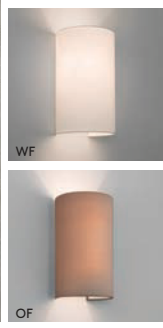

ios 250 Shade

| | | BACKPLATE EXCL. | LAMP | WATT | CLASS | |
|---------|---------|-----------------------|------|---------|-------|---|
| 5028001 | 5028003 | Backplate 3 - 1367003 | E27* | 60W max | | ✓ |

* Lamp excluded/ La lampe exclu/ Das Leuchtmittel ist ausgeschlossen/ La lampadina esclusi



Beauville

SHADE EXCLUDED

| | | LAMP | WATT | CLASS | |
|------------------------------|---------|------|---------|--------------------------|-------------------------------------|
| <input type="checkbox"/> PCh | 1388001 | E27* | 40W max | <input type="checkbox"/> | <input checked="" type="checkbox"/> |
| <input type="checkbox"/> Br | 1388003 | | | | |

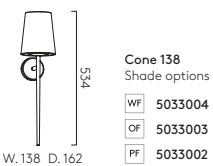

Cone 138
Shade options

- WF 5033004
- OF 5033003
- PF 5033002



• Special Shade Colours / Couleurs spéciales / Sonderfarben / Colori speciali. See p.404
 ▼ Lamp excluded / La lampe exclu / Das Leuchtmittel ist ausgeschlossen / La lampadina esclusi.



Bronze + White Glass shade

Lago 280

SHADE EXCLUDED

| | | | | LAMP | WATT | CLASS | | | | | |
|------------------------------|---------|-----------------------------|---------|-----------------------------|---------|-----------------------------|---------|------|---------|--------------------------|---|
| <input type="checkbox"/> PCh | 1297001 | <input type="checkbox"/> MN | 1297002 | <input type="checkbox"/> Br | 1297007 | <input type="checkbox"/> MB | 1297009 | E27▼ | 60W max | <input type="checkbox"/> | ✓ |

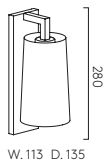

Cone 195
Shade options
 WG 5019001
 WF 5018001
 NB 5018046



• Special Shade Colours / Couleurs spéciales / Sonderfarben / Colori speciali. See p.404
 ▼ Lamp excluded / La lampe exclu / Das Leuchtmittel ist ausgeschlossen / La lampadina esclusi.

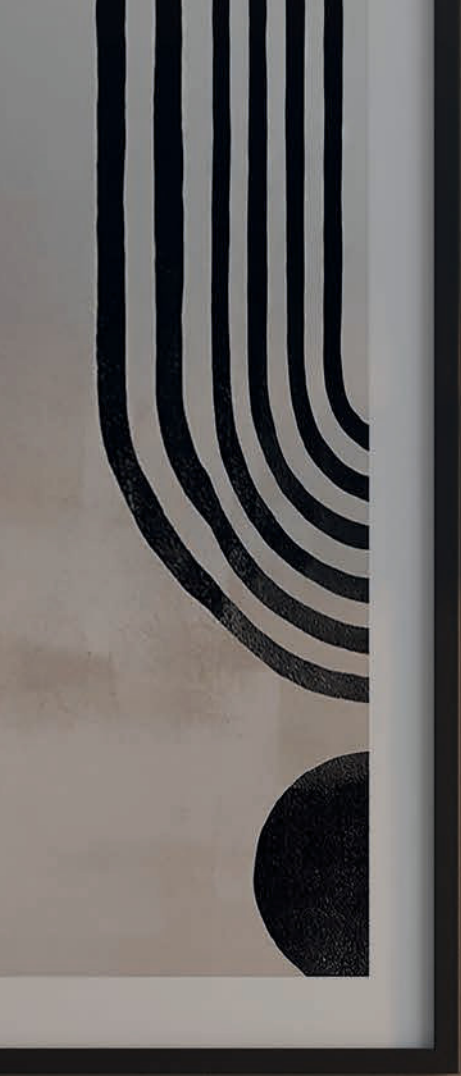

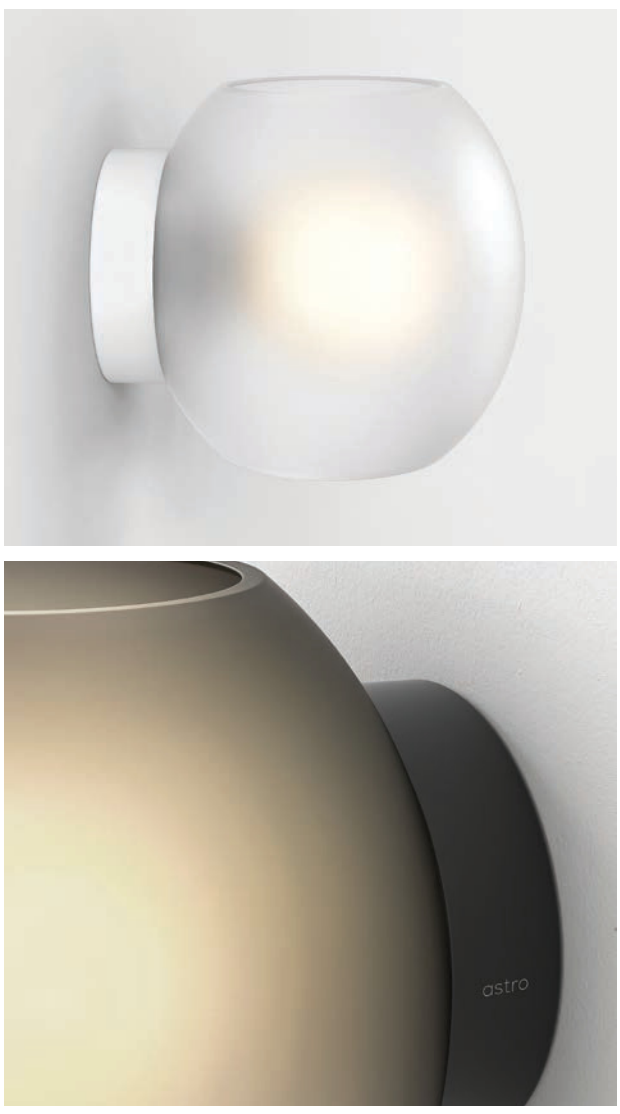

Luna

| | LAMP | WATT | CLASS | | |
|---|------|---------|-------|---|---|
| WFr 1489001 SFr 1489002 DSG 1489005 | E27* | 12W max | | ✓ | ✓ |

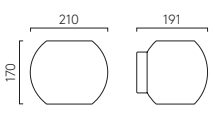

* Lamp excluded/La lampe exclu/Das Leuchtmittel ist ausgeschlossen/La lampadina esclusi.



Toro

CG 1461001

| LAMP | WATT | CLASS | | |
|------|---------|-------|---|---|
| E27* | 12W max | | ✓ | ✓ |

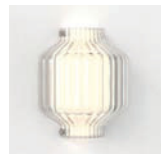
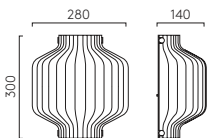

* Lamp excluded / La lampe exclu / Das Leuchtmittel ist ausgeschlossen / La lampadina esclusi.



Ottavino Wall

| | LAMP | WATT | CLASS | | |
|--------------------------------------|-------------|---------------|-------|-------------------------------------|-------------------------------------|
| PCh 1411001 MB 1411006 | E14* | 5W max | | <input checked="" type="checkbox"/> | <input checked="" type="checkbox"/> |

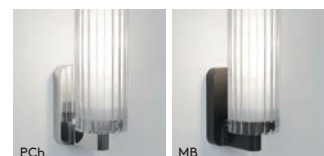
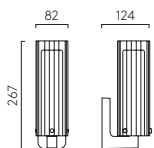

▼ Lamp excluded/La lampe exclu/Das Leuchtmittel ist ausgeschlossen/La lampadina esclusi.



Veo

| | | LAMP | WATT | CLASS | | |
|-------------------|-------------------|------|---------|-------|---|---|
| MN 1455001 | Br 1455002 | E27* | 12W max | | ✓ | ✓ |

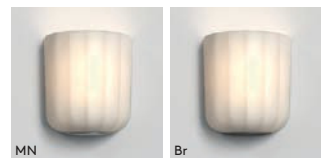
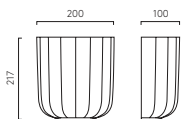

▼ Lamp excluded / La lampe exclu / Das Leuchtmittel ist ausgeschlossen / La lampadina esclusi.



Ella Wall

| MB Po 1470003 | | LBr Po 1470004 | | LAMP | WATT | CLASS |
|---------------|--|----------------|--|------|--------------|-------|
| | | | | G9* | 2 x 3.5W max | ⊥ |



W.160 D.214

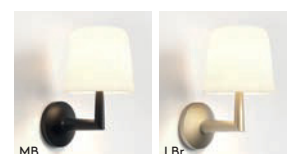

* Lamp excluded / La lampe exclu / Das Leuchtmittel ist ausgeschlossen / La lampadina esclusi.





Tacoma

SHADE EXCLUDED

| | | | | LAMP | WATT | CLASS | |
|---------------|---------|---------|---------|-----------------|--------------|-------|---|
| Single | 1429001 | 1429004 | 1429007 | G9 [▼] | 3.5W max | | ✓ |
| Twin | 1429002 | 1429005 | 1429008 | G9 [▼] | 2 x 3.5W max | | ✓ |
| Single Grande | 1429003 | 1429006 | 1429009 | G9 [▼] | 3.5W max | | ✓ |

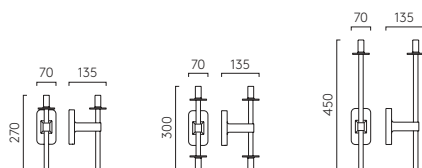

Glass Shade Options

- Round Shade**
- 5036001
- 5036003
- 5036004
- 5036005

- Reed Shade**
- 5036009
- 5036010

- Tulip shade**
- 5036007
- 5036008

▼ Lamp excluded/La lampe exclu/Das Leuchtmittel ist ausgeschlossen/La lampadina esclusi.



600 Matt Black/Matt Gold

Ako

| | | | | LAMP | WATT | INPUT | K | CRI | Lm | CLASS | | |
|-----|---|---------|---|---------|--------------|-------|----------|------|----|-------|--|---------|
| 420 | <input type="checkbox"/> MB <input type="checkbox"/> MG | 1481014 | <input type="checkbox"/> MW <input type="checkbox"/> MG | 1481015 | Integral LED | 15.9W | 220-240V | 2700 | 90 | 522 | | phase ✓ |
| 600 | <input type="checkbox"/> MB <input type="checkbox"/> MG | 1481017 | <input type="checkbox"/> MW <input type="checkbox"/> MG | 1481018 | Integral LED | 15.9W | 220-240V | 2700 | 90 | 478 | | phase ✓ |

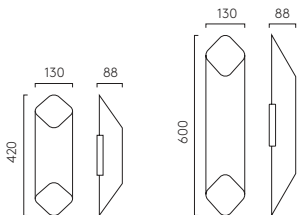

Made to Order Alternative finish and dimming options are available as Made to Order for this product subject to minimum order quantities and extended lead times. / D'autres options de finition et de gradation sur commande sont disponibles pour ce produit, sous condition d'un volume de commande minimum et de délais de livraison prolongés / Alternative Ausführungen und Dimmoptionen sind für dieses Produkt als Sonderanfertigung erhältlich und unterliegen einer Mindestbestellmenge und längeren Lieferzeiten / Finiture alternative e diverse opzioni di regolazione sono disponibili su misura per questo prodotto con quantitativi minimi e tempi di consegna allungati. See Website.



400 Wall White Fabric

Elba Wall

| | WF | PF | LAMP | WATT | CLASS | |
|-----|---------|---------|------|-------------|-------|---|
| 400 | 1469001 | 1469002 | E27▼ | 2 x 12W max | | ✓ |
| 600 | 1469003 | 1469004 | E27▼ | 2 x 12W max | | ✓ |

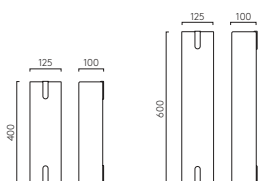

▼ Lamp excluded/La lampe exclu/Das Leuchtmittel ist ausgeschlossen/La lampadina esclusi



Hashira 300

| | LAMP | WATT | CLASS | |
|---|-------|------------|-------|---|
| MB 1442001 MN 1442005 MG 1442006 | GU10* | 2 x 6W max | | ✓ |

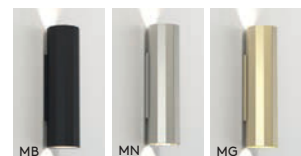
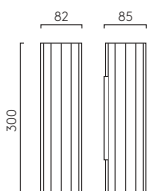

▼ Lamp excluded / La lampe exclu / Das Leuchtmittel ist ausgeschlossen / La lampadina esclusi.

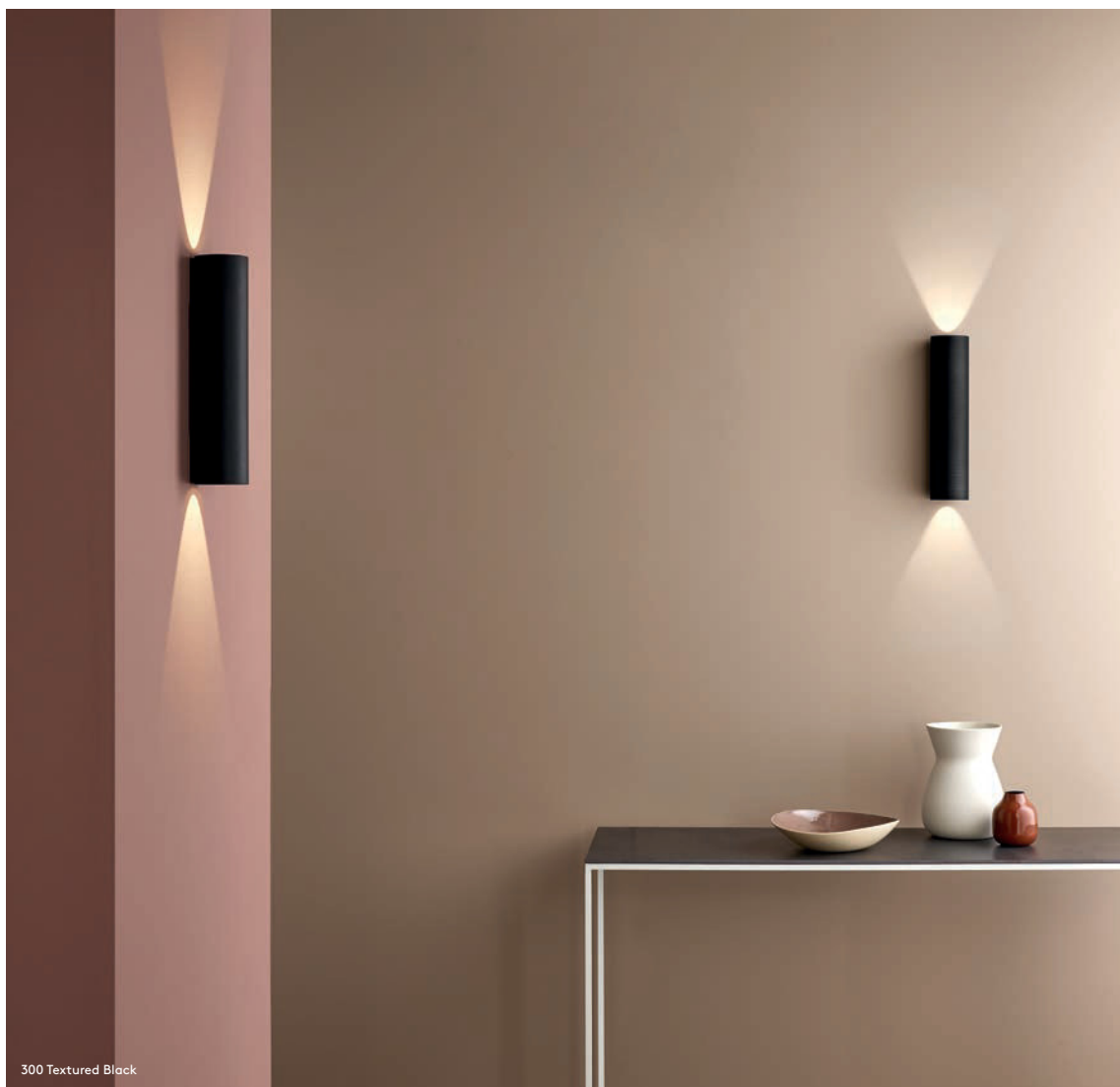

300 Textured Black

Yuma

| | | | | LAMP | WATT | INPUT | K | CRI | Lm | CLASS | | |
|-----|------------|------------|--|--------------|-------|----------|------|-----|-----|-------|-------|---|
| 240 | TB 1399023 | Br 1399025 | | Integral LED | 15.9W | 210-250V | 2700 | 80 | 451 | | Phase | ✓ |
| 300 | TB 1399027 | Br 1399029 | | Integral LED | 12W | 210-250V | 2700 | 80 | 173 | | Phase | ✓ |

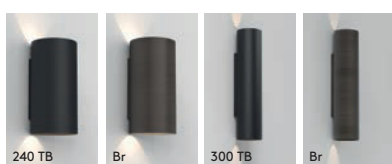
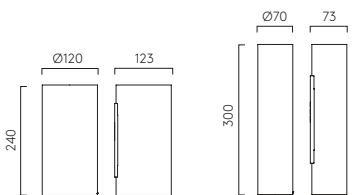



Square 500 Anique Brass

Avignon

| | | | LAMP | WATT | CLASS | | |
|------------|------------|------------|-------|-------------|-------|---|---|
| Round 375 | Br 1427001 | AB 1427002 | E27 ▼ | 12W max | | ✓ | ✓ |
| Round 525 | Br 1427003 | AB 1427004 | E27 ▼ | 2 x 12W max | | ✓ | ✓ |
| Square 300 | Br 1427009 | AB 1427010 | E27 ▼ | 12W max | | ✓ | ✓ |
| Square 500 | Br 1427011 | AB 1427012 | E27 ▼ | 2 x 12W max | | ✓ | ✓ |

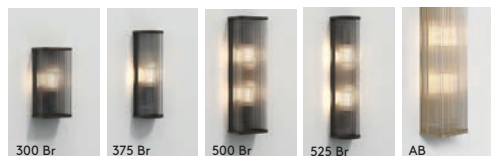
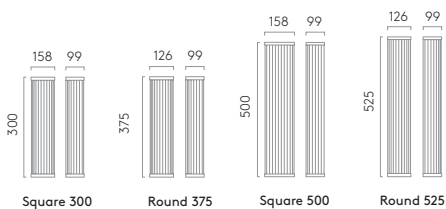

▼ Lamp excluded / La lampe exclu / Das Leuchtmittel ist ausgeschlossen / La lampadina esclusi.

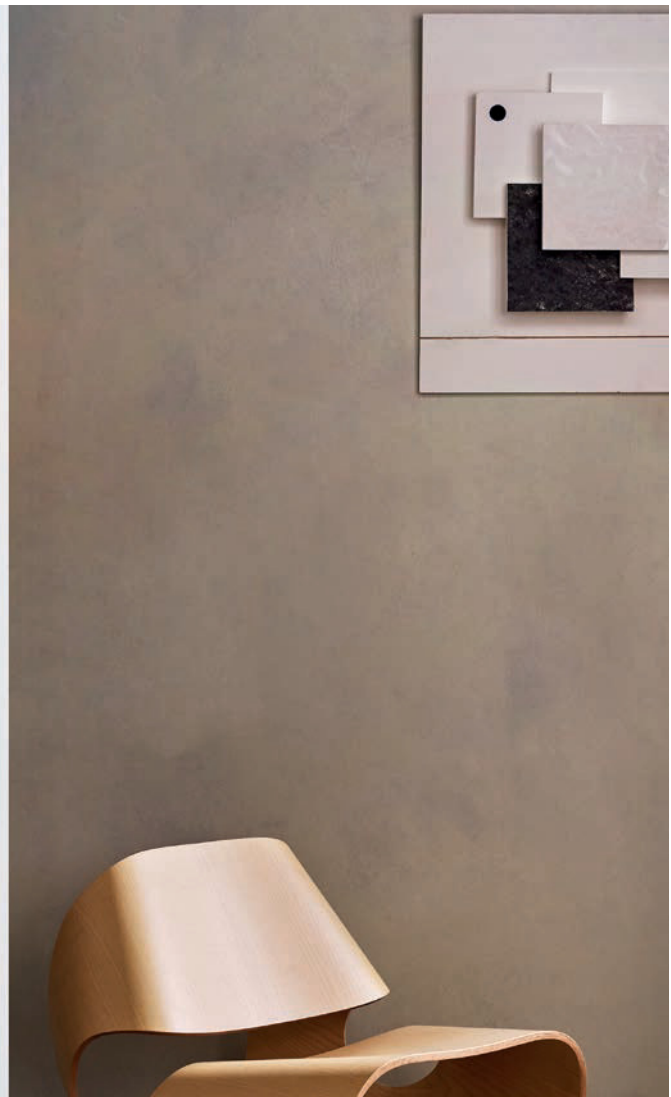
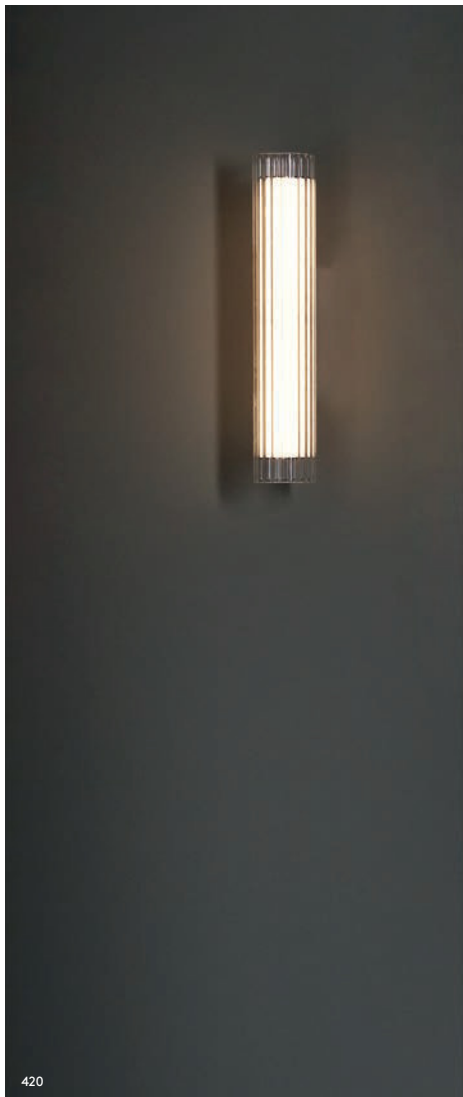

io Wall

| | LAMP | WATT | INPUT | K | CRI | Lm | CLASS | | | |
|-----|---|--------------|-------|----------|------|----|-------|--|-------|-----|
| 265 | PCh 1409003 | Integral LED | 4.9W | 220-240V | 3000 | 80 | 403 | | Phase | ✓ ✓ |
| 420 | PCh 1409055 MB 1409056 MG 1409057 | Integral LED | 6.5W | 220-240V | 3000 | 80 | 469 | | Phase | ✓ ✓ |
| 665 | PCh 1409058 MB 1409059 MG 1409060 | Integral LED | 8.3W | 220-240V | 3000 | 80 | 725 | | Phase | ✓ ✓ |

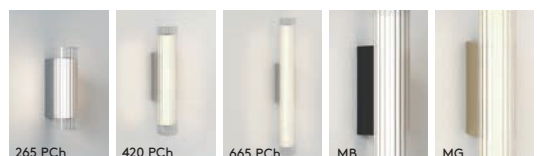
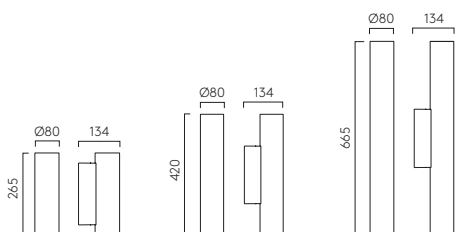



Harvard Wall

| | | | LAMP | WATT | CLASS | | |
|----|---------|----|--------------------------|--------|-------|---|---|
| Br | 1402009 | MB | E27 Tubular [▼] | 4W max | | ✓ | ✓ |

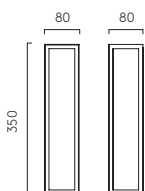

▼ Lamp excluded / La lampe exclu / Das Leuchtmittel ist ausgeschlossen / La lampadina esclusi.



Boston

| | | | | LAMP | WATT | INPUT | K | CRI | Lm | CLASS | ⊗ | ⊙ |
|-----|-----------------------------|---------|------------------------------|---------|--------------|-------|----------|------|----|-------|--------------------------|-----|
| 370 | <input type="checkbox"/> Br | 1370004 | <input type="checkbox"/> PCh | 1370002 | Integral LED | 14W | 100-240V | 3000 | 80 | 465 | <input type="checkbox"/> | ✓ ✓ |
| 600 | <input type="checkbox"/> Br | 1370012 | | | Integral LED | 18.5W | 220-240V | 3000 | 90 | 780 | <input type="checkbox"/> | ✓ ✓ |

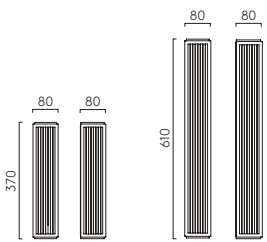

Made to Order Alternative finish options are available as Made to Order for this product subject to minimum order quantities and extended lead times. / D'autres options de finition sur commande sont disponibles pour ce produit, sous condition d'un volume de commande minimum et de délais de livraison prolongés. / Alternative Ausführungen sind für dieses Produkt als Sonderanfertigung erhältlich und unterliegen einer Mindestbestellmenge und längeren Lieferzeiten. / Diverse finiture alternative sono disponibili su misura per questo prodotto con quantitativi minimi e tempi di consegna allungati. See website.



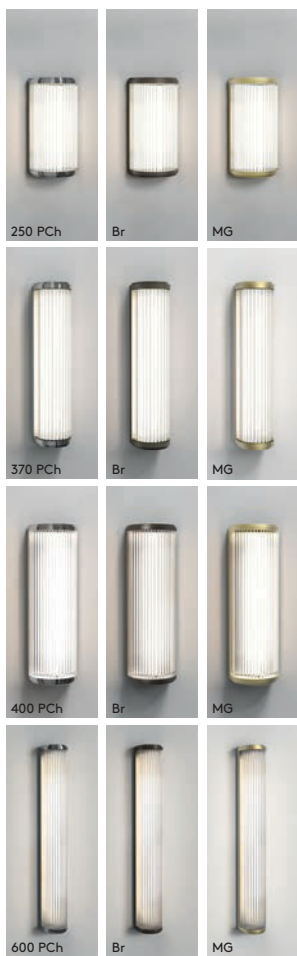

Versailles

| | LAMP | WATT | INPUT | K | CRI | Lm | CLASS | | | |
|-----|--|--------------|-------|----------|------|----|-------|--------------------------|-------|-----|
| 250 | <input type="checkbox"/> PCh 1380024 <input type="checkbox"/> Br 1380025 <input type="checkbox"/> MG 1380026 | Integral LED | 4.5W | 220-240V | 3000 | 80 | 320 | <input type="checkbox"/> | Phase | ✓ ✓ |
| 370 | <input type="checkbox"/> PCh 1380013 <input type="checkbox"/> Br 1380014 <input type="checkbox"/> MG 1380040 | Integral LED | 12W | 100-240V | 3000 | 80 | 661 | <input type="checkbox"/> | - | ✓ ✓ |
| 400 | <input type="checkbox"/> PCh 1380029 <input type="checkbox"/> Br 1380030 <input type="checkbox"/> MG 1380031 | Integral LED | 7.1W | 220-240V | 3000 | 80 | 658 | <input type="checkbox"/> | Phase | ✓ ✓ |
| 600 | <input type="checkbox"/> PCh 1380084 <input type="checkbox"/> Br 1380082 <input type="checkbox"/> MG 1380083 | Integral LED | 18.4W | 220-240V | 3000 | 90 | 945 | <input type="checkbox"/> | - | ✓ ✓ |

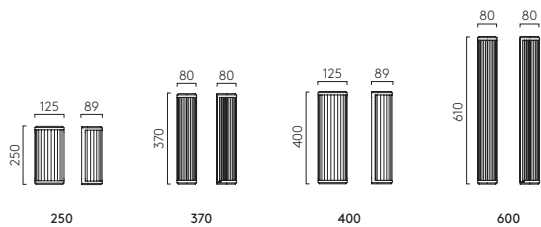



Montreal

| | TB | BSS | LAMP | WATT | IP | CLASS | | |
|------------------|------------|-------------|------|---------|----|-------|---|---|
| Oval | TB 1032007 | BSS 1032013 | E27* | 12W max | 44 | | ✓ | ✓ |
| Round 220 | TB 1032005 | BSS 1032011 | E14* | 7W max | 44 | | ✓ | ✓ |
| Round 300 | TB 1032006 | BSS 1032012 | E27* | 12W max | 44 | | ✓ | ✓ |

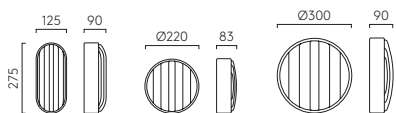

▼ Lamp excluded / La lampe exclu / Das Leuchtmittel ist ausgeschlossen / La lampadina esclusi.



Jura

| | | LAMP | WATT | CLASS | | |
|--------|------------|-------|-------------|-------|---|---|
| Single | SB 1375009 | GU10▼ | 35W max | | ✓ | ✓ |
| Twin | SB 1375010 | GU10▼ | 2 x 35W max | | ✓ | ✓ |

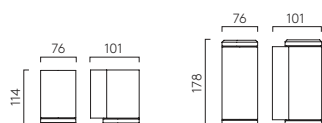

▼ Lamp excluded/La lampe exclu/Das Leuchtmittel ist ausgeschlossen/La lampadina esclusi.



Ito

| | LAMP | WATT | CLASS | |
|------------|------|--------|-------|---|
| MW 1446001 | | | | |
| MB 1446002 | G9* | 5W max | ⊕ | ✓ |

Device Charging Wireless + USB-A

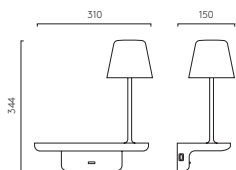

▼ Lamp excluded / La lampe exclu / Das Leuchtmittel ist ausgeschlossen / La lampadina esclusi.



Carlton Wall

| | LAMP | WATT | CLASS | I |
|---|------|--------|---|---|
|  1467004 | G9* | 5W max |  | ✓ |
| Plug-in  1467007* | G9* | 5W max |  | ✓ |



W.110 D.118



* Lamp excluded/La lampe exclu/Das Leuchtmittel ist ausgeschlossen/La lampadina esclusi.

* One cable guide included. Additional quantities are available to purchase separately./Un guide câble fourni. Des quantités supplémentaires sont disponibles à l'achat séparément / Eine Kabelführung enthalten. Zusätzliche Mengen sind separat zu erwerben./È incluso un guida cavi. Quantità aggiuntive possono essere acquistate separatamente. See p.404



Serge

| | LAMP | WATT | CLASS | |
|---|------|---------|--------------------------|-------------------------------------|
| MB 1476003 MW 1476002 | G9* | 20W max | <input type="checkbox"/> | <input checked="" type="checkbox"/> |

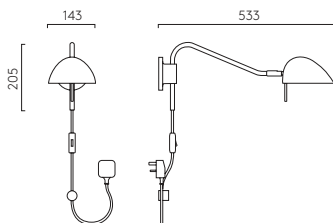

▼ Lamp excluded / La lampe exclu / Das Leuchtmittel ist ausgeschlossen / La lampadina esclusi.

* One cable guide included. Additional quantities are available to purchase separately. / Un guide câble fourni. Des quantités supplémentaires sont disponibles à l'achat séparément / Eine Kabelführung enthalten. Zusätzliche Mengen sind separat zu erwerben. / È incluso un guida cavi. Quantità aggiuntive possono essere acquistate separatamente. See p.404

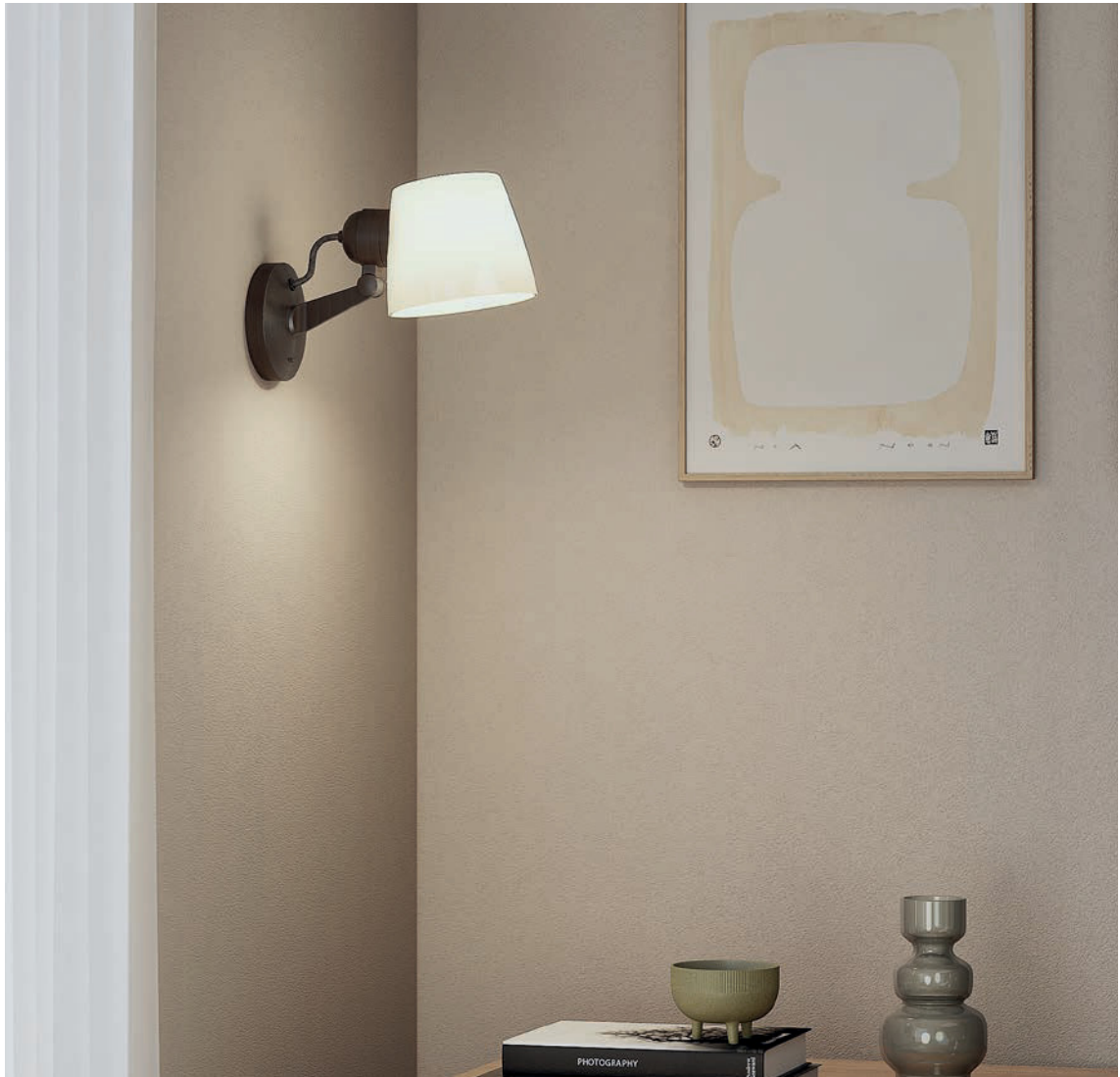

Imari

| | Br | Po | MN | Po | LAMP | WATT | CLASS | I |
|-------------------|----|----|----|----|------|---------|-------|---|
| Fixed | Br | Po | MN | Po | E27* | 12W max | ⊕ | ✓ |
| Adjustable | Br | Po | MN | Po | E27* | 12W max | ⊕ | ✓ |



W.140 D.166



W.140 D.262



Fixed Br



Adjustable Br



MN

* Lamp excluded / La lampe exclu / Das Leuchtmittel ist ausgeschlossen / La lampadina esclusi.



Edward Wall

SHADE EXCLUDED

| | | LAMP | WATT | CLASS | | |
|----------|-------------------|------|---------|-------|---|---|
| Wall | MB 1441001 | E27* | 12W max | | ✓ | - |
| Switched | MB 1441013 | E27* | 12W max | | - | ✓ |

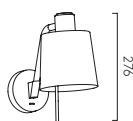

W. 110 D. 390

Tapered Drum 155
Fabric Shade options

- WF** 5013027
- BF** 5013028
- PF** 5013029

Tapered Drum 155
Metal Shade options

- MB** 5013024
- MG** 5013026

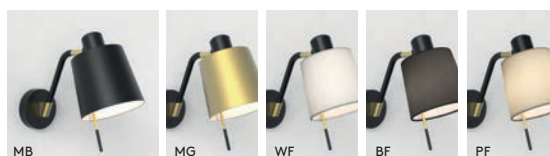

• Special Shade Colours/Couleurs spéciales/Sonderfarben/Colori speciali. See p.404
 ▼ Lamp excluded/La lampe exclu/Das Leuchtmittel ist ausgeschlossen/La lampadina esclusi.



Edward Twin

SHADE EXCLUDED

| | LAMP | WATT | CLASS | |
|-------------------|------------------|-------------|-------|-------------------------------------|
| MB 1441002 | E27 [▼] | 2 x 12W max | | <input checked="" type="checkbox"/> |

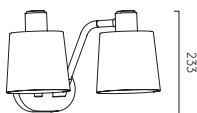

W. 407 D. 281

Tapered Drum 155
Fabric Shade options

| | |
|-----------|---------|
| WF | 5013027 |
| BF | 5013028 |
| PF | 5013029 |

Tapered Drum 155
Metal Shade options

| | |
|-----------|---------|
| MB | 5013024 |
| MG | 5013026 |



- Special Shade Colours / Couleurs spéciales / Sonderfarben / Colori speciali. See p.404
- ▼ Lamp excluded / La lampe exclu / Das Leuchtmittel ist ausgeschlossen / La lampadina esclusi.



Matt Gold + Matt Gold Shade

Miura Wall

SHADE EXCLUDED

| | | | LAMP | WATT | INPUT | K | CRI | Lm | CLASS | I | ⊕ |
|-------------------|-------------------|-------------------|--------------|------|----------|------|-----|-----|-------|---|---|
| MB 1444001 | MN 1444002 | MG 1444003 | Integral LED | 7.5W | 220-240V | 2700 | 80 | 367 | ⊕ | ✓ | ✓ |

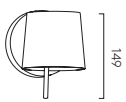

W.110 D.157

Cone 105
Shade options

- MB** 5018052
- MN** 5018053
- MG** 5018054



• Special Shade Colours / Couleurs spéciales / Sonderfarben / Colori speciali. See p.404



Matt Nickel + Matt Black Shade

Miura Swing Arm

SHADE EXCLUDED

| | | | LAMP | WATT | INPUT | K | CRI | Lm | CLASS | | | | | |
|-----------|---------|-----------|---------|-----------|---------|--------------|------|----------|-------|----|-----|---|---|---|
| MB | 1444004 | MN | 1444005 | MG | 1444006 | Integral LED | 7.5W | 220-240V | 2700 | 80 | 367 | ⊕ | ✓ | ✓ |

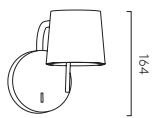

W. 110 D.290

Cone 105
Shade options

- MB** 5018052
- MN** 5018053
- MG** 5018054



• Special Shade Colours / Couleurs spéciales / Sonderfarben / Colori speciali. See p.404



Matt Nickel + White Fabric Shade

Mitsu Wall

SHADE EXCLUDED

| | | LAMP | WATT | CLASS | |
|------------|------------|------|---------|-------|---|
| MN 1394003 | Br 1394004 | E27* | 12W max | ⊕ | ✓ |

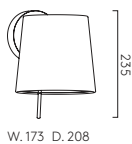

- Cone 173
Shade options
- WF 5018031
 - OF 5018033
 - PF 5018034



* Special Shade Colours / Couleurs spéciales / Sonderfarben / Colori speciali. See p.404

▼ Lamp excluded / La lampe exclu / Das Leuchtmittel ist ausgeschlossen / La lampadina esclusi.

Made to Order Alternative finish options are available as Made to Order for this product subject to minimum order quantities and extended lead times. / D'autres options de finition sur commande sont disponibles pour ce produit, sous condition d'un volume de commande minimum et de délais de livraison prolongés. / Alternative Ausführungen sind für dieses Produkt als Sonderanfertigung erhältlich und unterliegen einer Mindestbestellmenge und längeren Lieferzeiten. / Diverse finiture alternative sono disponibili su misura per questo prodotto con quantitativi minimi e tempi di consegna allungati. See website.



Matt Nickel + White Fabric Shade

Mitsu Swing Arm

SHADE EXCLUDED

| MN | Br | LAMP | WATT | CLASS | |
|---------|---------|------|---------|-------|---|
| 1394001 | 1394002 | E27* | 12W max | ⊕ | ✓ |

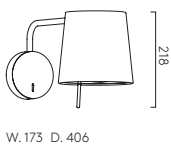

- Cone 173**
Shade options
- WF 5018031
 - OF 5018033
 - PF 5018034



• Special Shade Colours / Couleurs spéciales / Sonderfarben / Colori speciali. See p.404

† Lamp excluded / La lampe exclu / Das Leuchtmittel ist ausgeschlossen / La lampadina esclusi.

Made to Order Alternative finish options are available as Made to Order for this product subject to minimum order quantities and extended lead times. / D'autres options de finition sur commande sont disponibles pour ce produit, sous condition d'un volume de commande minimum et de délais de livraison prolongés. / Alternative Ausführungen sind für dieses Produkt als Sonderanfertigung erhältlich und unterliegen einer Mindestbestellmenge und längeren Lieferzeiten. / Diverse finiture alternative sono disponibili su misura per questo prodotto con quantitativi minimi e tempi di consegna allungati. See website.



Atelier Wall

| | LAMP | WATT | CLASS | |
|------------|------|---------|-------|---|
| MB 1224013 | E27▼ | 12W max | □ | ✓ |

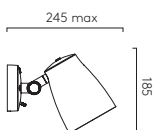

▼ Lamp excluded / La lampe exclu / Das Leuchtmittel ist ausgeschlossen / La lampadina esclus.



Atelier Grande Wall

| | LAMP | WATT | CLASS | |
|-------------|------|---------|-------|--|
| MB 1224016* | E27* | 12W max | | |

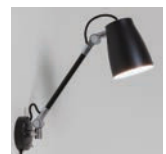
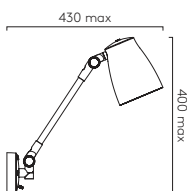

* Supplied with removable plug and lead set / Fourni avec prise et cordon amovibles / Inklusive abnehmbarem Stecker und Kabel / Fornito con cavo e spina rimovibile
 ▼ Lamp excluded / La lampe exclu / Das Leuchtmittel ist ausgeschlossen / La lampadina esclus.





Reader MB



Beaumont Reader

SHADE EXCLUDED

| | LAMP | WATT | CLASS |
|------------|------|---------|-------|
| MB 1480018 | E27* | 60W max | ⚡ |

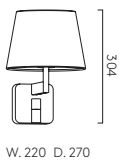

French Drum 220

- PF 5047001
- WF 5047002



* Lamp excluded/La lampe exclu/Das Leuchtmittel ist ausgeschlossen/La lampadina esclusi.





Reader MB

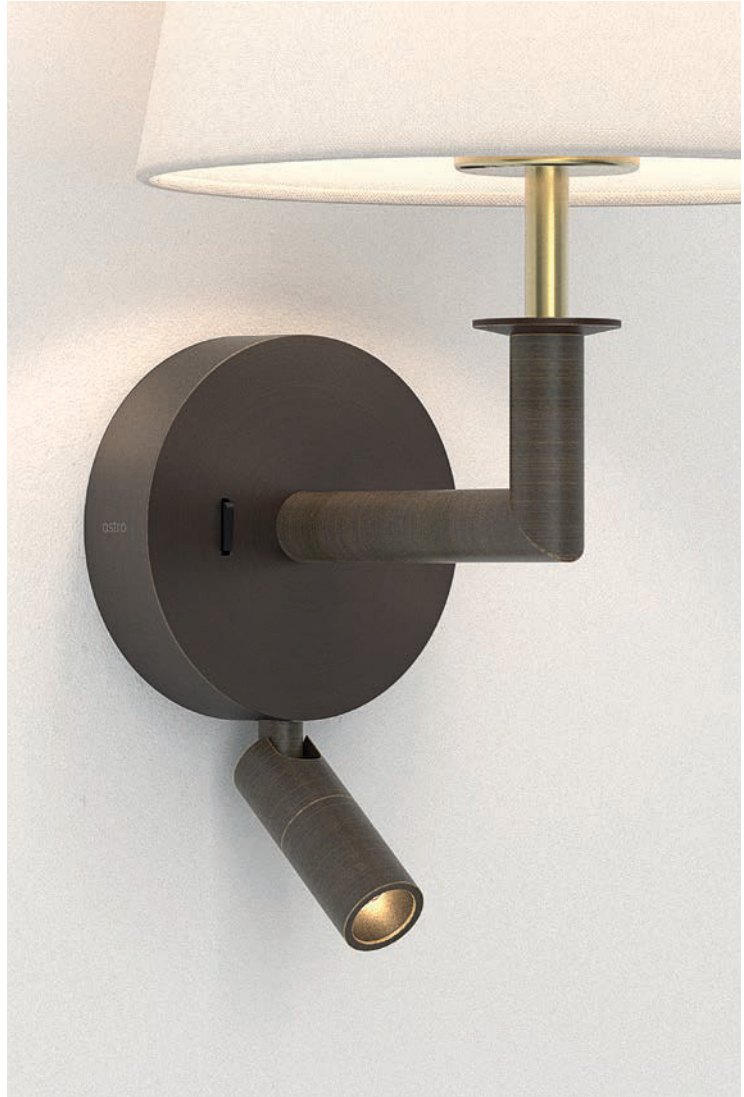

WALL · REVADING
NEW

Club Reader

SHADE EXCLUDED

Br 1483011

| LAMP | WATT | CLASS |
|------|---------|-------|
| E27* | 12W max | ⚡ |



French Drum 220

- PF 5047001
- WF 5047002



* Lamp excluded/La lampe exclu/Das Leuchtmittel ist ausgeschlossen/La lampadina esclusi.



Matt Nickel - White Fabric Tapered Round 250 Shade

Side by Side

SHADE EXCLUDED

| | | | LAMP | WATT | INPUT | K | CRI | Lm | CLASS | <input type="checkbox"/> | | | |
|-----------------------------|---------|-----------------------------|---------|-----------------------------|---------|-----------------------------|--------|----------|-------|--------------------------|-----|--|-------------------------------------|
| <input type="checkbox"/> MB | 1406002 | <input type="checkbox"/> MN | 1406003 | <input type="checkbox"/> Br | 1406004 | E27* 12W max + Integral LED | 2W max | 100-240V | 2700 | 90 | 211 | | <input checked="" type="checkbox"/> |

Shade Options

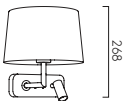

W. 275 D. 261

Tapered Round 250

| | |
|-----------------------------|---------|
| <input type="checkbox"/> WF | 5035003 |
| <input type="checkbox"/> BF | 5035004 |
| <input type="checkbox"/> PF | 5035005 |

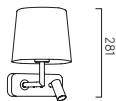

W. 240 D. 226

Cone 180

| | |
|-----------------------------|---------|
| <input type="checkbox"/> WF | 5018035 |
| <input type="checkbox"/> PF | 5018037 |



Shown with Cone 180, see Side by Side Grande USB for Tapered Round 250

Can be Mounted in 3 Orientations / Montage reversible (gauche / droite) / Kann beidseitig montiert werden / Può essere montato anche rivolto verso l'alto.

* Lamp excluded / La lampe exclu / Das Leuchtmittel ist ausgeschlossen / La lampadina esclus.



Matt Nickel + White Fabric Tapered Round 250 Shade

Side by Side Grande USB

SHADE EXCLUDED

| | | | LAMP | WATT | INPUT | K | CRI | Lm | CLASS | | |
|-------------------|-------------------|-------------------|-----------------------------|--------|----------|------|-----|-----|-------|-------------------------------------|-------------------------------------|
| MB 1406013 | MN 1406014 | Br 1406012 | E27* 12W max + Integral LED | 2W max | 100-240V | 2700 | 90 | 211 | | <input checked="" type="checkbox"/> | <input checked="" type="checkbox"/> |

Device Charging USB-A

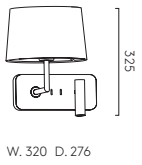

- Tapered Round 250
Shade options
- WF** 5035003
 - BF** 5035004
 - PF** 5035005

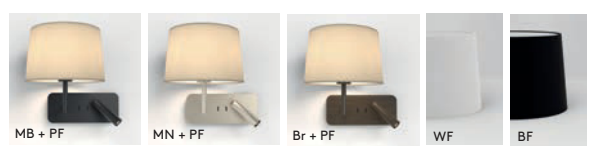

Can be Mounted in 3 Orientations / Montage reversible (gauche/droite) / Kann beidseitig montiert werden / Può essere montato anche rivolto verso l'alto.
 * Lamp excluded / La lampe exclu / Das Leuchtmittel ist ausgeschlossen / La lampadina esclus.



Venn Reader

SHADE EXCLUDED

| | | | | LAMP | WATT | INPUT | K | CRI | Lm | CLASS | | |
|--------|------------|------------|--|-----------------------------|------|----------|------|-----|-----|-------|---|---|
| Single | MN 1433009 | Br 1433005 | | E27* 12W max + Integral LED | 2W | 100-240V | 2700 | 90 | 211 | | ✓ | ✓ |
| Twin | MN 1433010 | Br 1433006 | | E27* 12W max + Integral LED | 2W | 100-240V | 2700 | 90 | 211 | | ✓ | ✓ |

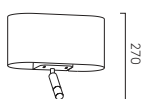

W. 315 D.135

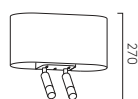

W. 315 D.135

Stadium 160
Shade options
 WF 5043002
 PF 5043001

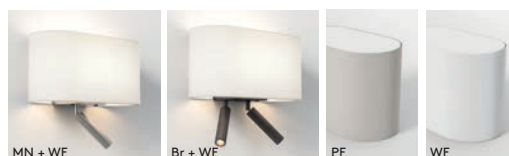

- Special Shade Colours / Couleurs spéciales / Sonderfarben / Colori speciali. See p.404
- Lamp excluded / La lampe exclu / Das Leuchtmittel ist ausgeschlossen / La lampadina esclus



Napoli Reader

SHADE EXCLUDED

| | LAMP | WATT | INPUT | K | CRI | Lm | CLASS | |
|------------|-----------------------------|------|----------|------|-----|-----|-------|---|
| MN 1185003 | E27* 60W max + Integral LED | 2W | 100-240V | 2700 | 90 | 211 | ⊕ | ✓ |

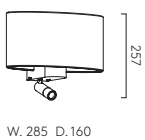

- Oval 285
Shade options
- WF 5014001
 - OF 5014003
 - PF 5014004

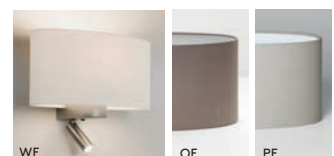

- Special Shade Colours / Couleurs spéciales / Sonderfarben / Colori speciali. See p.404
- Lamp excluded / La lampe exclu / Das Leuchtmittel ist ausgeschlossen / La lampadina esclus.





Park Lane Reader

SHADE EXCLUDED

| Br | 1080051 | LAMP | WATT | INPUT | K | CRI | Lm | CLASS | |
|----|---------|-----------------------------|------|----------|------|-----|-----|-------|---|
| | | E27* 60W max + Integral LED | 1W | 100-240V | 2700 | 90 | 115 | | ✓ |

Shade Options

| | | | | | | | | | | | | | | | | | | | |
|--|--|----|---------|----|---------|----|---------|----|---------|----|---------|--|--|----|---------|----|---------|----|---------|
|  <p>W. 285 D. 187</p> | <p>Rectangle 285</p> <table border="0"> <tr><td>WF</td><td>5001001</td></tr> <tr><td>BF</td><td>5001003</td></tr> <tr><td>OF</td><td>5001007</td></tr> <tr><td>PF</td><td>5001017</td></tr> <tr><td>MF</td><td>5011009</td></tr> </table> | WF | 5001001 | BF | 5001003 | OF | 5001007 | PF | 5001017 | MF | 5011009 |  <p>W. 300 D. 185</p> | <p>Tapered Oval*</p> <table border="0"> <tr><td>WF</td><td>5034001</td></tr> <tr><td>OF</td><td>5034003</td></tr> <tr><td>PF</td><td>5034004</td></tr> </table> | WF | 5034001 | OF | 5034003 | PF | 5034004 |
| WF | 5001001 | | | | | | | | | | | | | | | | | | |
| BF | 5001003 | | | | | | | | | | | | | | | | | | |
| OF | 5001007 | | | | | | | | | | | | | | | | | | |
| PF | 5001017 | | | | | | | | | | | | | | | | | | |
| MF | 5011009 | | | | | | | | | | | | | | | | | | |
| WF | 5034001 | | | | | | | | | | | | | | | | | | |
| OF | 5034003 | | | | | | | | | | | | | | | | | | |
| PF | 5034004 | | | | | | | | | | | | | | | | | | |



• Special Shade Colours / Couleurs spéciales / Sonderfarben / Colori speciali. See p.404

▼ Lamp excluded / La lampe exclu / Das Leuchtmittel ist ausgeschlossen / La lampadina esclus.

* To be used with LED lamp only / Pour utilisation avec lampe LED seulement / nur mit Kompaktleuchtstofflampe LED verwenden / Solo per l'uso con lampade a LED.



Matt Nickel + White Fabric Shade

Ravello LED Reader

SHADE EXCLUDED

| | | | | LAMP | WATT | INPUT | K | CRI | Lm | CLASS | | | |
|-----|---------|----|---------|------|---------|-----------------------------|----|----------|------|-------|-----|---|---|
| PCh | 1222018 | MN | 1222019 | Br | 1222020 | E27* 40W max + Integral LED | 2W | 100-240V | 2700 | 90 | 211 | ⊕ | ✓ |

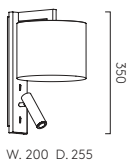

- Drum 200
Shade options
- WF 5016020
 - OF 5016022
 - PF 5016029

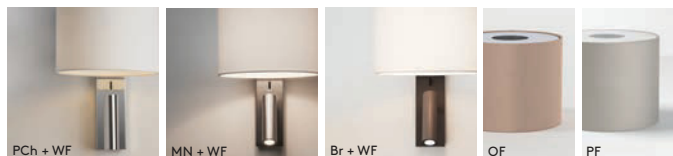

• Special Shade Colours / Couleurs spéciales / Sonderfarben / Colori speciali. See p.404
 ▼ Lamp excluded / La lampe exclu / Das Leuchtmittel ist ausgeschlossen / La lampadina esclus.





Gio

| | LAMP | WATT | CLASS | | |
|-------------------------------------|------------|--------|-------|---|---|
| MB 1473007 MW 1473008 | 35mm GU10* | 4W max | | ✓ | ✓ |

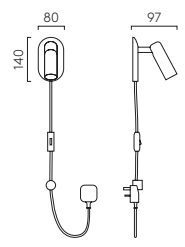

* Lamp excluded/La lampe exclu/Das Leuchtmittel ist ausgeschlossen/La lampadina esclusi.



Ascoli Swing

| | LAMP | WATT | CLASS | |
|---|-------|--------|--------------------------|---|
| MB 1286088 TW 1286065 MN 1286066 Br 1286067 | GU10* | 6W max | <input type="checkbox"/> | ✓ |
| Plug-in* TW 1286137 MB 1286138 | GU10* | 6W max | <input type="checkbox"/> | ✓ |

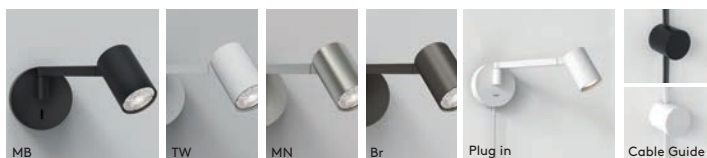

▼ Lamp excluded / La lampe exclu / Das Leuchtmittel ist ausgeschlossen / La lampadina esclus.

* One cable guide included. Additional quantities are available to purchase separately. / Un guide câble fourni. Des quantités supplémentaires sont disponibles à l'achat séparément / Eine Kabelführung enthalten. Zusätzliche Mengen sind separat zu erwerben. / È incluso un guida cavi. Quantità aggiuntive possono essere acquistate separatamente. See p.404



Leda

SHADE EXCLUDED

| | | LAMP | WATT | CLASS | I |
|-----------|---------|------------|--------|-------|---|
| Single | 1457003 | 35mm GU10▼ | 4W max | | ✓ |
| Swing Arm | 1457004 | 35mm GU10▼ | 4W max | | ✓ |



- Leda Shade Options
- 5040001
 - 5040004
 - 5040005

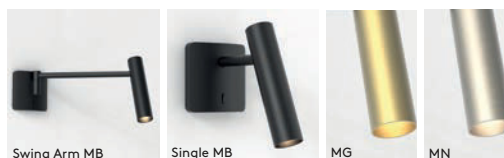

▼ Lamp excluded/La lampe exclu/Das Leuchtmittel ist ausgeschlossen/La lampadina esclus.



Enna Swing

| | | | | LAMP | WATT | INPUT | K | CRI | Lm | CLASS | | | | | | |
|-----------|---------|-----------|---------|-----------|---------|-----------|---------|--------------|------|----------|------|----|-----|--|---|---|
| MB | 1058033 | MW | 1058032 | MN | 1058056 | MG | 1058105 | Integral LED | 4.7W | 100-240V | 2700 | 90 | 105 | | ✓ | ✓ |

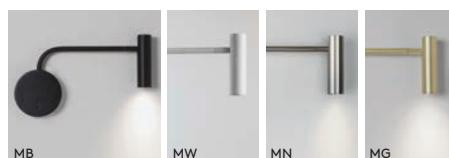
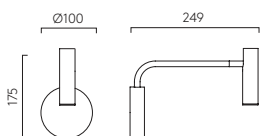



Enna Surface USB

| | LAMP | WATT | INPUT | K | CRI | Lm | CLASS | | |
|---|--------------|------|----------|------|-----|-----|-------|--|--|
| MB 1058246 MW 1058249 MG 1058247 | Integral LED | 3.6W | 100-240V | 2700 | 90 | 134 | | | |

Device charging USB-A + USB-C

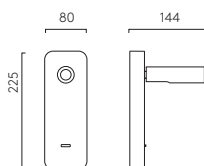

Can be Mounted in 3 Orientations / Montage reversible (gauche/droite) / Kann beidseitig montiert werden / Può essere montato anche rivolto verso l'alto.
Made to Order Alternative finish options are available as Made to Order for this product subject to minimum order quantities and extended lead times. / D'autres options de finition sur commande sont disponibles pour ce produit, sous condition d'un volume de commande minimum et de délais de livraison prolongés. / Alternative Ausführungen sind für dieses Produkt als Sonderanfertigung erhältlich und unterliegen einer Mindestbestellmenge und längeren Lieferzeiten. / Diverse finiture alternative sono disponibili su misura per questo prodotto con quantitativi minimi e tempi di consegna allungati. See website.



Enna Square Switched

| | LAMP | WATT | INPUT | K | CRI | Lm | CLASS | | |
|--|--------------|------|----------|------|-----|-----|-------|--|--|
| MW 1058226 MB 1058024 MN 1058018 Br 1058085 MG 1058030 | Integral LED | 4.5W | 100-240V | 2700 | 90 | 111 | | | |

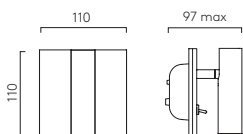

Made to Order Alternative finish and switching options are available as Made to Order for this product subject to minimum order quantities and extended lead times. / D'autres options de finition et de commutation sur commande sont disponibles pour ce produit, sous condition d'un volume de commande minimum et de délais de livraison prolongés. / Alternative Ausführungen und Schalteroptionen sind für dieses Produkt als Sonderanfertigung erhältlich und unterliegen einer Mindestbestellmenge und längeren Lieferzeiten. / Finiture alternative e diverse opzioni di commutazione sono disponibili su misura per questo prodotto con quantitativi minimi e tempi di consegna allungati. See website.



Enna Surface

| | LAMP | WATT | INPUT | K | CRI | Lm | CLASS | | |
|---|--------------|------|----------|------|-----|-----|-------|--|--|
| MW 1058225 MB 1058027 MN 1058013 Br 1058084 MG 1058108 | Integral LED | 4.5W | 100-240V | 2700 | 90 | 111 | | | |

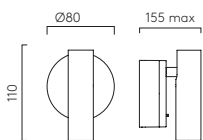



Enna Recess Switched

| | LAMP | WATT | INPUT | K | CRI | Lm | CLASS | | |
|--|--------------|------|----------|------|-----|-----|-------|-------------------------------------|-------------------------------------|
| <input type="checkbox"/> MB 1058067 <input type="checkbox"/> MW 1058062 <input type="checkbox"/> MN 1058065 <input checked="" type="checkbox"/> Br 1058088 | Integral LED | 3.9W | 100-240V | 2700 | 90 | 151 | | <input checked="" type="checkbox"/> | <input checked="" type="checkbox"/> |

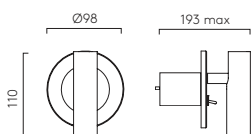

Made to Order Alternative finish options are available as Made to Order for this product subject to minimum order quantities and extended lead times. / D'autres options de finition sur commande sont disponibles pour ce produit, sous condition d'un volume de commande minimum et de délais de livraison prolongés. / Alternative Ausführungen sind für dieses Produkt als Sonderanfertigung erhältlich und unterliegen einer Mindestbestellmenge und längeren Lieferzeiten. / Diverse finiture alternative sono disponibili su misura per questo prodotto con quantitativi minimi e tempi di consegna allungati. See website



Enna Twin

| | LAMP | WATT | INPUT | K | CRI | Lm | CLASS | | |
|---|--------------|------|----------|------|-----|-----|--------------------------|--------------------------|-------------------------------------|
| <input type="checkbox"/> MB 1058192 <input type="checkbox"/> MW 1058194 <input type="checkbox"/> MN 1058195 <input type="checkbox"/> Br 1058197 <input type="checkbox"/> MG 1058196 | Integral LED | 6.6W | 100-240V | 2700 | 90 | 340 | <input type="checkbox"/> | <input type="checkbox"/> | <input checked="" type="checkbox"/> |

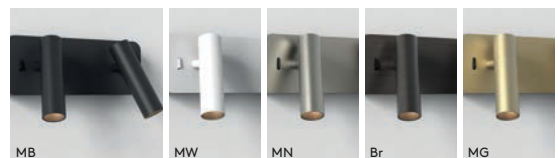
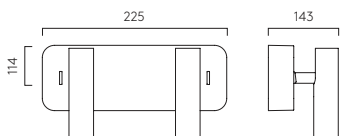



Micro Recess

| | LAMP | WATT | INPUT | K | CRI | Lm | CLASS | | | | |
|-------------------|----------------------------------|--------------|-------|----------|------|----|-------|--|---|---|---|
| Switched | MW 1407006 MB 1407007 MN 1407008 | Integral LED | 3.4W | 100-240V | 2700 | 90 | 166 | | - | ✓ | ✓ |
| | Br 1407009 MG 1407010 | | | | | | | | | | |
| Unswitched | MW 1407001 MB 1407002 MN 1407003 | Integral LED | 3.2W | 700mA* | 2700 | 90 | 164 | | ✓ | - | ✓ |
| | Br 1407004 MG 1407005 | | | | | | | | | | |

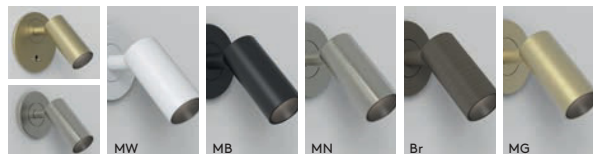
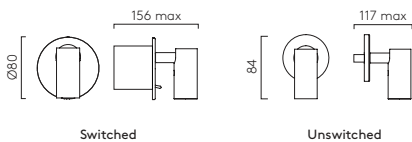

* Driver excluded/Driver d'entrée exclu/Das treiber ist ausgeschlossen/Driver esclusi



Keta

| | | | | LAMP | WATT | INPUT | K | CRI | Lm | CLASS | | |
|-------|------------|------------|-------------|--------------|------|----------|------|-----|-----|-------|---|---|
| USB-A | MB 1437004 | MW 1437005 | MN 1437001 | Integral LED | 3.2W | 100-240V | 2700 | 90 | 155 | ⊕ | ✓ | ✓ |
| | MG 1437007 | Br 1437008 | | | | | | | | | | |
| USB-C | MB 1437038 | MW 1437041 | MN 1437040 | Integral LED | 3.2W | 100-240V | 2700 | 90 | 155 | ⊕ | ✓ | ✓ |
| | MG 1437039 | Br 1437037 | PCh 1437042 | | | | | | | | | |
| | Non-USB | MB 1437020 | MG 1437021 | | | | | | | | | |

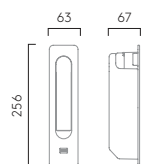



Fuse 3

| | LAMP | WATT | INPUT | K | CRI | Lm | CLASS | | |
|----------------|---|--------------|-------|------------|------|----|-------|---|-----|
| 3 USB-A | <input type="checkbox"/> MB 1215082 <input type="checkbox"/> Br 1215085 <input type="checkbox"/> MN 1215084 <input type="checkbox"/> MG 1215103 | Integral LED | 3.5W | Mains 230V | 2700 | 90 | 185 | ⊕ | ✓ ✓ |
| 3 USB-C | <input type="checkbox"/> MW 1215147 <input type="checkbox"/> MB 1215044 <input type="checkbox"/> Br 1215043 <input type="checkbox"/> MN 1215046 <input type="checkbox"/> MG 1215145 | Integral LED | 3.5W | Mains 230V | 2700 | 90 | 185 | ⊕ | ✓ ✓ |
| 3 | <input type="checkbox"/> MW 1215122 <input type="checkbox"/> MB 1215123 <input type="checkbox"/> Br 1215126 <input type="checkbox"/> MN 1215125 <input type="checkbox"/> MG 1215127 | Integral LED | 3.6W | Mains 230V | 2700 | 90 | 151 | ⊕ | ✓ ✓ |
| TOGGLE | <input type="checkbox"/> MB 1215149 <input type="checkbox"/> Br 1215148 <input type="checkbox"/> MN 1215151 | Integral LED | 3.5W | Mains 230V | 2700 | 90 | 185 | ⊕ | ✓ ✓ |

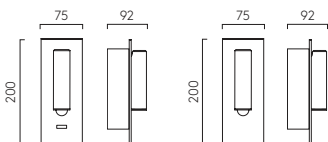

Made to Order Alternative finish options are available as Made to Order for this product subject to minimum order quantities and extended lead times. / D'autres options de finition sur commande sont disponibles pour ce produit, sous condition d'un volume de commande minimum et de délais de livraison prolongés. / Alternative Ausführungen sind für dieses Produkt als Sonderanfertigung erhältlich und unterliegen einer Mindestbestellmenge und längeren Lieferzeiten. / Diverse finiture alternative sono disponibili su misura per questo prodotto con quantitativi minimi e tempi di consegna allungati. See website.



Digit

| | LAMP | WATT | INPUT | K | CRI | Lm | CLASS | | | | | | |
|-------------------------------------|-------------------------------------|-------------------------------------|--------------------------------------|-------------------------------------|--------------|------|----------|------|----|-----|--------------------------|-------------------------------------|-------------------------------------|
| <input type="checkbox"/> MB 1323043 | <input type="checkbox"/> MN 1323045 | <input type="checkbox"/> Br 1323042 | <input type="checkbox"/> PCh 1323046 | <input type="checkbox"/> MG 1323044 | Integral LED | 4.8W | 100-240V | 2700 | 90 | 131 | <input type="checkbox"/> | <input checked="" type="checkbox"/> | <input checked="" type="checkbox"/> |

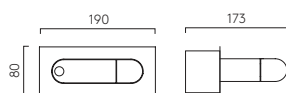

Can be Mounted in 3 Orientations / Montage reversible (gauche/droite) / Kann beidseitig montiert werden / Può essere montato anche rivolto verso l'alto.
Made to Order Alternative finish options are available as Made to Order for this product subject to minimum order quantities and extended lead times. / D'autres options de finition sur commande sont disponibles pour ce produit, sous condition d'un volume de commande minimum et de délais de livraison prolongés. / Alternative Ausführungen sind für dieses Produkt als Sonderanfertigung erhältlich und unterliegen einer Mindestbestellmenge und längeren Lieferzeiten. / Diverse finiture alternative sono disponibili su misura per questo prodotto con quantitativi minimi e tempi di consegna allungati. See website.



Tosca

| | LAMP | WATT | INPUT | K | CRI | Lm | CLASS | | |
|--|--------------|------|----------|------|-----|----|-------|-------------------------------------|-------------------------------------|
| <input type="checkbox"/> MN 1157001 <input type="checkbox"/> Br 1157012 <input type="checkbox"/> PCh 1157003 <input type="checkbox"/> MG 1157007 | Integral LED | 2.7W | 100-240V | 2700 | 90 | 75 | | <input checked="" type="checkbox"/> | <input checked="" type="checkbox"/> |

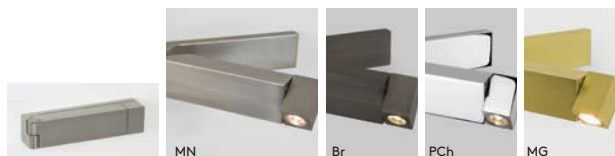
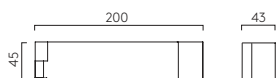

Can be Mounted in 3 Orientations / Montage reversible (gauche/droite) / Kann beidseitig montiert werden / Può essere montato anche rivolto verso l'alto.
Made to Order Alternative finish options are available as Made to Order for this product subject to minimum order quantities and extended lead times. / D'autres options de finition sur commande sont disponibles pour ce produit, sous condition d'un volume de commande minimum et de délais de livraison prolongés. / Alternative Ausführungen sind für dieses Produkt als Sonderanfertigung erhältlich und unterliegen einer Mindestbestellmenge und längeren Lieferzeiten. / Diverse finiture alternative sono disponibili su misura per questo prodotto con quantitativi minimi e tempi di consegna allungati. See website.



Baton

| | LAMP | WATT | INPUT | K | CRI | Lm | CLASS | | |
|-------------------------------------|------------|--------------|-------|----------|------|----|-------|--|-------------------------------------|
| MB 1475012 MN 1475013 | Reader: | Integral LED | 5.1W | 100-240V | 2700 | 90 | 191 | | <input checked="" type="checkbox"/> |
| | Backlight: | Integral LED | 2W | 100-240V | 2700 | 90 | 211 | | <input checked="" type="checkbox"/> |

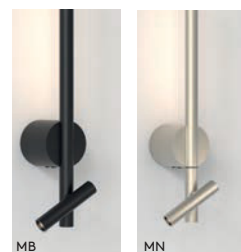
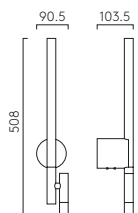

Can be Mounted in 3 Orientations / Montage reversible (gauche/droite) / Kann beidseitig montiert werden / Può essere montato anche rivolto verso l'alto.



Zeppo Reader

| | LAMP | WATT | INPUT | K | CRI | Lm | CLASS | ⏏ | Ⓜ |
|----------------------------------|--|------|----------|------|-----|-----|-------|---|---|
| MW 1176008 MB 1176009 Br 1176010 | G9 ⁺ 3.5W max + Integral LED 2W | | 100-240V | 2700 | 90 | 211 | ⏏ | ✓ | ✓ |

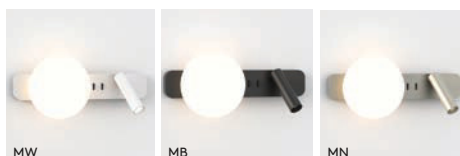
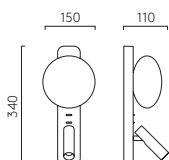

▼ Lamp excluded / La lampe exclu / Das Leuchtmittel ist ausgeschlossen / La lampadina esclus.

Can be Mounted in 3 Orientations / Montage reversible (gauche/droite) / Kann beidseitig montiert werden / Può essere montato anche rivolto verso l'alto.

Made to Order Alternative finish options are available as Made to Order for this product subject to minimum order quantities and extended lead times. / D'autres options de finition sur commande sont disponibles pour ce produit, sous condition d'un volume de commande minimum et de délais de livraison prolongés. / Alternative Ausführungen sind für dieses Produkt als Sonderanfertigung erhältlich und unterliegen einer Mindestbestellmenge und längeren Lieferzeiten. / Diverse finiture alternative sono disponibili su misura per questo prodotto con quantitativi minimi e tempi di consegna allungati. See website.



Edge Reader Mini

| | | | | LAMP | WATT | INPUT | K | CRI | Lm | CLASS | | | | | | | |
|----|---------|----|---------|------|---------|-------|---------|------------|--------------|----------|----------|------|----|---------|--|---|---|
| MW | 1352018 | MB | 1352041 | Br | 1352040 | MN | 1352042 | Reader: | Integral LED | 8.7-9.3W | 100-240V | 2700 | 80 | 78-153 | | ✓ | ✓ |
| | | | | | | | | Backlight: | Integral LED | 3.3W | 100-240V | 2700 | 90 | 130-211 | | ✓ | ✓ |

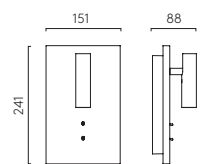

Can be Mounted in 3 Orientations / Montage reversible (gauche/droite) / Kann beidseitig montiert werden / Può essere montato anche rivolto verso l'alto.



Lucca

| | | | | | LAMP | WATT | INPUT | K | CRI | Lm | CLASS | | |
|-----------------|-------------------|-------------------|-------------------|-------------------|--------------|------|----------|------|-----|-----|-------|---|---|
| Recessed | MB 1435009 | MN 1435010 | MG 1435011 | Br 1435012 | Integral LED | 3.6W | 100-240V | 2700 | 90 | 124 | ⊕ | ✓ | ✓ |
| Surface | MB 1435001 | MN 1435002 | MG 1435003 | Br 1435004 | Integral LED | 3.6W | 100-240V | 2700 | 90 | 124 | ⊕ | ✓ | ✓ |

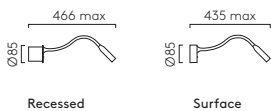

Recessed

Surface



MB

MN

MG

Br

Made to Order Alternative switching options are available as Made to Order for this product subject to minimum order quantities and extended lead times. / D'autres options de commutation sur commande sont disponibles pour ce produit, sous condition d'un volume de commande minimum et de délais de livraison prolongés. / Alternative Schaltoptionen sind für dieses Produkt als Sonderanfertigung erhältlich und unterliegen einer Mindestbestellmenge und längeren Lieferzeiten. / Opzioni di commutazione alternative sono disponibili su misura per questo prodotto con quantitativi minimi e tempi di consegna allungati. See website.

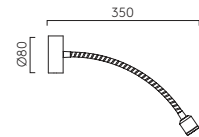

Fosso

MN 1138008 Br 1138011

| LAMP | WATT | INPUT | K | CRI | Lm | CLASS | ⏻ | 🌐 |
|--------------|------|----------|------|-----|----|-------|---|---|
| Integral LED | 1.7W | 100-240V | 3000 | 90 | 83 | ⊕ | ✓ | ✓ |

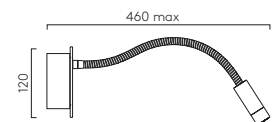

Leo

MN 1295002 Br 1295003

| LAMP | WATT | INPUT | K | CRI | Lm | CLASS | ⏻ | 🌐 |
|--------------|------|------------|------|-----|-----|-------|---|---|
| Integral LED | 4W | Mains 230V | 3000 | 90 | 193 | ⊕ | ✓ | ✓ |





155



320



Comino

| | | LAMP | WATT | CLASS | |
|-----|-----------|------------------|---------|-------|---|
| 155 | P 1490001 | E27 [▼] | 12W max | | ✓ |
| 320 | P 1490002 | E27 [▼] | 12W max | | ✓ |

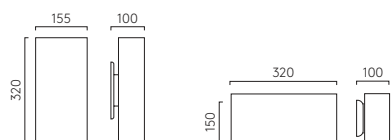

▼ Lamp excluded/La lampe exclu/Das Leuchtmittel ist ausgeschlossen/La lampadina esclusi.
Can be painted/Peut être peint/kann lackiert werden/Può essere verniciato.



Velo

| | | LAMP | WATT | CLASS | |
|-----|-----------|------------------|-------------|-------|---|
| 280 | P 1417001 | E27 [▼] | 12W max | | ✓ |
| 390 | P 1417002 | E27 [▼] | 2 x 12W max | | ✓ |

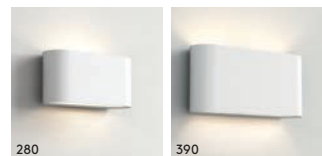
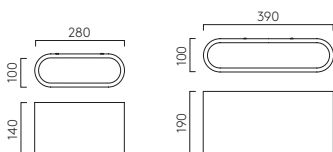

▼ Lamp excluded / La lampe exclu / Das Leuchtmittel ist ausgeschlossen / La lampadina esclusi.
Can be painted / Peut être peint / kann lackiert werden / Può essere verniciato.



Aria 300

| | LAMP | WATT | CLASS |  |
|------------------|------|---------|---|---|
| P 1300001 | E27* | 12W max |  | ✓ |

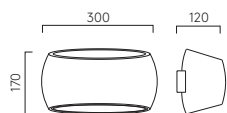

▼ Lamp excluded/La lampe exclu/Das Leuchtmittel ist ausgeschlossen/La lampadina esclusi.
Can be painted/Peut être peint/kann lackiert werden/Può essere verniciato.



210

Parma

| | | LAMP | WATT | CLASS | |
|-----|---------|-------|------------|-------|---|
| 110 | 1187009 | GU10* | 6W max | | ✓ |
| 210 | 1187003 | GU10* | 2 x 6W max | | ✓ |

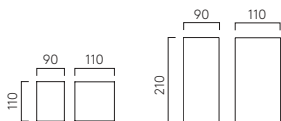

▼ Lamp excluded / La lampe exclu / Das Leuchtmittel ist ausgeschlossen / La lampadina esclusi.
 Can be painted / Peut être peint / kann lackiert werden / Può essere verniciato.



Parma

| | | LAMP | WATT | INPUT | K | CRI | Lm | CLASS | | |
|---------|------------------------------------|--------------|---------|----------|------|-----|------|-------|-------|---|
| 200 | <input type="checkbox"/> P 1187005 | E14* | 60W max | - | - | - | - | | ✓ | - |
| 625 LED | <input type="checkbox"/> P 1187027 | Integral LED | 15.9W | 220-240V | 2700 | 80 | 1497 | | Phase | ✓ |

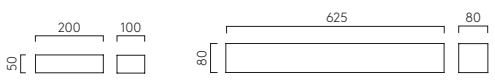

* Lamp excluded/La lampe exclu/Das Leuchtmittel ist ausgeschlossen/La lampadina esclusi.
Can be painted/Peut être peint/kann lackiert werden/Può essere verniciato.



Shadow 300

| | LAMP | WATT | CLASS | |
|-----------|-------|------------|-------|---|
| P 1414002 | GU10* | 2 x 6W max | ⊕ | ✓ |

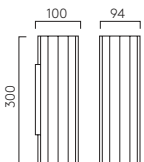

▼ Lamp excluded / La lampe exclu / Das Leuchtmittel ist ausgeschlossen / La lampadina esclusi.
Can be painted / Peut être peint / kann lackiert werden / Può essere verniciato.

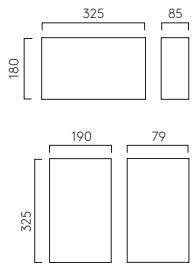
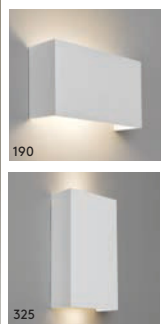

Pella

| | LAMP | WATT | CLASS | |
|--|-------|------------|-------|---|
| 190 <input type="checkbox"/> P 1315002 | GU10* | 2 x 6W max | | ✓ |
| 325 <input type="checkbox"/> P 1315001 | E27* | 12W max | | ✓ |

* Lamp excluded / La lampe exclu / Das Leuchtmittel ist ausgeschlossen / La lampadina esclusi.
Can be painted / Peut être peint / kann lackiert werden / Può essere verniciato.

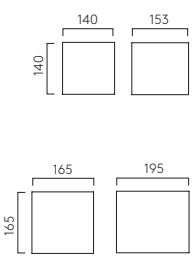
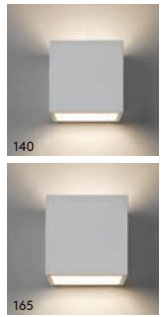

Pienza

| | LAMP | WATT | CLASS | |
|--|------|---------|-------|---|
| 140 <input type="checkbox"/> P 1196001 | E14* | 60W max | | ✓ |
| 165 <input type="checkbox"/> P 1196003 | E27* | 12W max | | ✓ |

* Lamp excluded / La lampe exclu / Das Leuchtmittel ist ausgeschlossen / La lampadina esclusi.
Can be painted / Peut être peint / kann lackiert werden / Può essere verniciato.



Koza

| | LAMP | WATT | CLASS | |
|-----------|------|---------|-------|---|
| P 1155001 | E14* | 60W max | ⊕ | ✓ |

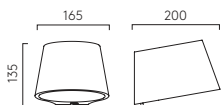

▼ Lamp excluded / La lampe exclu / Das Leuchtmittel ist ausgeschlossen / La lampadina esclusi.
 Can be painted / Peut être peint / kann lackiert werden / Può essere verniciato.



300

Kymi

| | LAMP | WATT | CLASS | |
|--|-------|------------|-------|---|
| 220 <input type="checkbox"/> P 1335001 | GU10* | 2 x 6W max | | ✓ |
| 300 <input type="checkbox"/> P 1335003 | GU10* | 2 x 6W max | | ✓ |

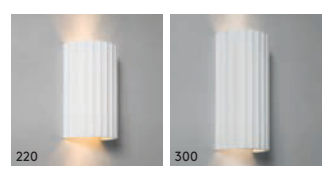
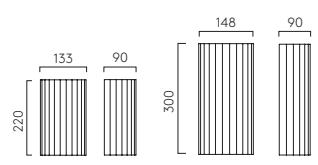

* Lamp excluded / La lampe exclu / Das Leuchtmittel ist ausgeschlossen / La lampadina esclusi.
 Can be painted / Peut être peint / kann lackiert werden / Può essere verniciato.



Pero

| | LAMP | WATT | CLASS |  |
|-----------|------|---------|---|---|
| P 1172001 | G9* | 28W max |  | ✓ |

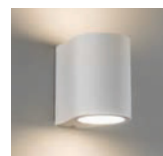
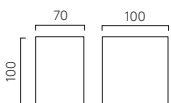



▼ Lamp excluded/La lampe exclu/Das Leuchtmittel ist ausgeschlossen/La lampadina esclusi.
 Can be painted/Peut être peint/kann lackiert werden/Può essere verniciato.



Mosto

P 1173001

| LAMP | WATT | CLASS |  |
|-----------------|---------|---|---|
| G9 [▼] | 28W max |  | ✓ |

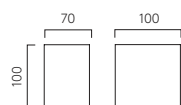

▼ Lamp excluded/La lampe exclu/Das Leuchtmittel ist ausgeschlossen/La lampadina esclusi.
Can be painted/Peut être peint/kann lackiert werden/Può essere verniciato.



Serifos

| | LAMP | WATT | INPUT | K | CRI | Lm | CLASS | | |
|--|--------------|------------|----------|------|-----|-----|-------|---|---|
| 170 LED <input type="checkbox"/> P 1350002 | Integral LED | 7.1W | 100-240V | 2700 | 90 | 164 | | - | ✓ |
| 170 LED <input type="checkbox"/> P 1350001 | Integral LED | 7.1W | 100-240V | 3000 | 90 | 208 | | - | ✓ |
| 220 <input type="checkbox"/> P 1350003 | GU10* | 2 x 6W max | - | - | - | - | | ✓ | - |

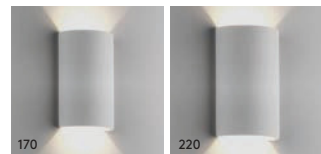
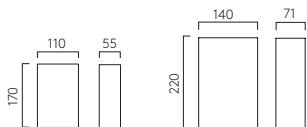

* Lamp excluded / La lampe exclu / Das Leuchtmittel ist ausgeschlossen / La lampadina esclusi.
Can be painted / Peut être peint / kann lackiert werden / Può essere verniciato.

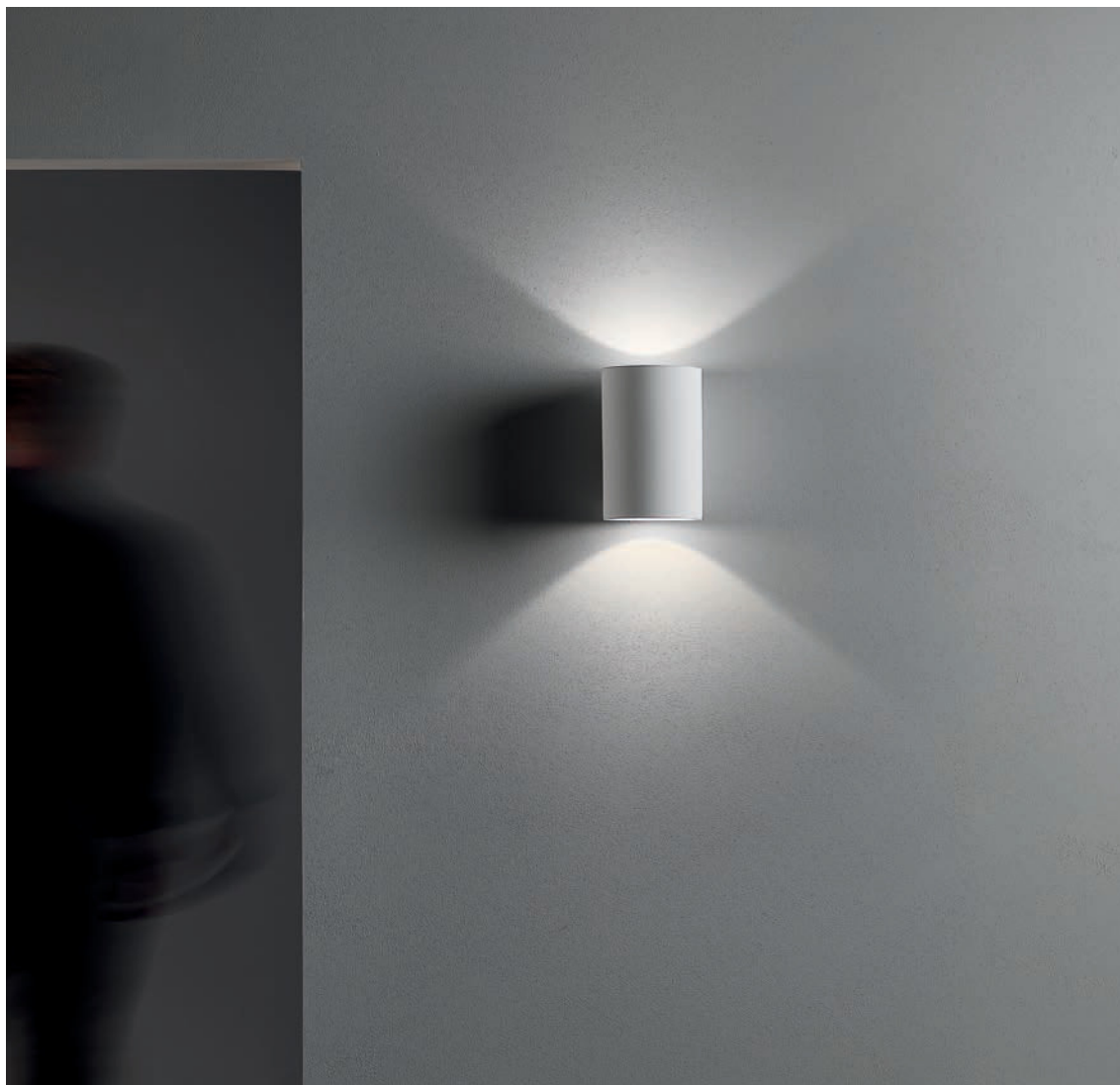

Bologna 240

| | LAMP | WATT | CLASS | |
|-----------|-------------------|------------|-------|---|
| P 1287002 | GU10 [▼] | 2 x 6W max | ⊕ | ✓ |

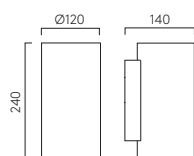

▼ Lamp excluded/La lampe exclu/Das Leuchtmittel ist ausgeschlossen/La lampadina esclusi.
Can be painted/Peut être peint/kann lackiert werden/Può essere verniciato.



250

Eclipse Round

| | | LAMP | WATT | INPUT | K | CRI | Lm | CLASS | |
|-----|------------------------------------|--------------|-------|----------|------|-----|-----|-------|---|
| 250 | <input type="checkbox"/> P 1333020 | Integral LED | 9.5W | 100-240V | 3000 | 80 | 446 | ⊕ | ✓ |
| 250 | <input type="checkbox"/> P 1333019 | Integral LED | 9.4W | 100-240V | 2700 | 80 | 386 | ⊕ | ✓ |
| 350 | <input type="checkbox"/> P 1333026 | Integral LED | 16.5W | 220-240V | 3000 | 80 | 685 | ⊕ | ✓ |
| 350 | <input type="checkbox"/> P 1333025 | Integral LED | 16.4W | 220-240V | 2700 | 80 | 674 | ⊕ | ✓ |

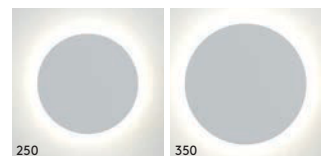
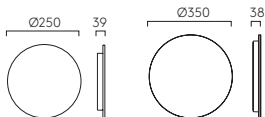

Can be painted/Peut être peint/kann lackiert werden/Può essere verniciato.



Blend

P 1439001

| LAMP | WATT | CLASS | |
|------|---------|-------|---|
| E27* | 12W max | | ✓ |

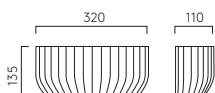

* Lamp excluded/La lampe exclu/Das Leuchtmittel ist ausgeschlossen/La lampadina esclusi.
Can be painted/Peut être peint/kann lackiert werden/Può essere verniciato.



Amas 320

Amas 320 + Amat 320

| | | LAMP | WATT | CLASS | |
|-----------------|---------|------------------|---------|-------|---|
| Amas 320 | 1431001 | E27 [▼] | 12W max | | ✓ |
| Amat 320 | 1432001 | E27 [▼] | 12W max | | ✓ |

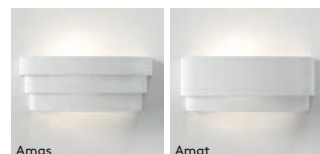
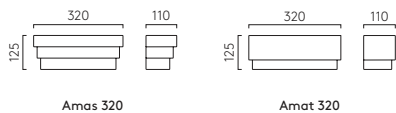

▼ Lamp excluded / La lampe exclu / Das Leuchtmittel ist ausgeschlossen / La lampadina esclusi.
Can be painted / Peut être peint / kann lackiert werden / Può essere verniciato.

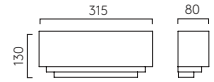

Amalfi

C 1079001

| LAMP | WATT | CLASS | |
|------|---------|-------|---|
| E27* | 60W max | | ✓ |

* Lamp excluded / La lampe exclu / Das Leuchtmittel ist ausgeschlossen / La lampadina esclusi.
Can be painted / Peut être peint / kann lackiert werden / Può essere verniciato

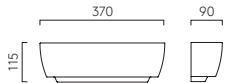

Kyo

C 1301001*

| LAMP | WATT | CLASS | |
|------|---------|-------|---|
| E27* | 60W max | | ✓ |

* Lamp excluded / La lampe exclu / Das Leuchtmittel ist ausgeschlossen / La lampadina esclusi.
Can be painted / Peut être peint / kann lackiert werden / Può essere verniciato.

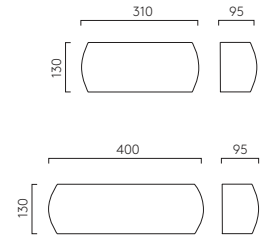
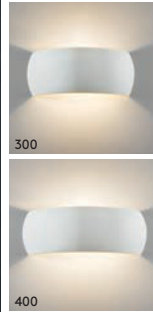

Milo

| | | LAMP | WATT | CLASS | |
|-----|------------------------------------|------|---------|--------------------------|---|
| 300 | <input type="checkbox"/> C 1299001 | E27* | 60W max | <input type="checkbox"/> | ✓ |
| 400 | <input type="checkbox"/> C 1299002 | E27* | 60W max | <input type="checkbox"/> | ✓ |

▼ Lamp excluded/La lampe exclu/Das Leuchtmittel ist ausgeschlossen/La lampadina esclusi.
Can be painted/Peut être peint/kann lackiert werden/Può essere verniciato

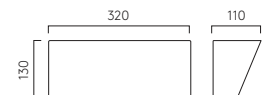

Parallel

| | | LAMP | WATT | CLASS | |
|--|------------------------------------|------|---------|--------------------------|---|
| | <input type="checkbox"/> C 1438001 | E27* | 12W max | <input type="checkbox"/> | ✓ |

▼ Lamp excluded/La lampe exclu/Das Leuchtmittel ist ausgeschlossen/La lampadina esclusi.
Can be painted/Peut être peint/kann lackiert werden/Può essere verniciato.



Tokyo

| | LAMP | WATT | CLASS | | | |
|-----------------|------------|----------------|---------|--|---|---|
| | WG 1089001 | E14 Golf Ball▼ | 60W max | | ✓ | - |
| Switched | WG 1089002 | E14 Golf Ball▼ | 60W max | | - | ✓ |

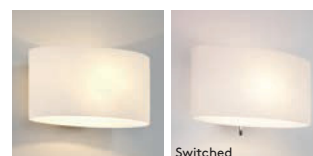
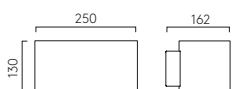

▼ Lamp excluded/La lampe exclu/Das Leuchtmittel ist ausgeschlossen/La lampadina esclusi.



Zeppo Wall

| | | LAMP | WATT | CLASS | | |
|--------------------|-------------------|------|---------|-------|---|---|
| PCh 1176004 | MB 1176047 | G9▼ | 33W max | | ✓ | ✓ |

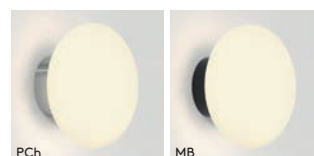
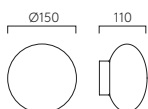

▼ Lamp excluded / La lampe exclu / Das Leuchtmittel ist ausgeschlossen / La lampadina esclusi.

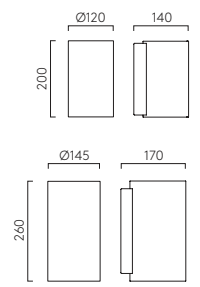

Cyl

| | |
|-----|------------|
| 200 | WG 1186001 |
| 260 | WG 1186002 |

| LAMP | WATT | CLASS | | |
|----------------|-------------|-------|---|---|
| E14 Golf Ball* | 2 x 40W max | | ✓ | ✓ |
| E27* | 2 x 60W max | | ✓ | ✓ |

▼ Lamp excluded / La lampe exclu / Das Leuchtmittel ist ausgeschlossen / La lampadina esclusi.

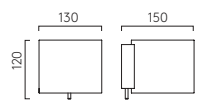
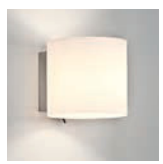

Luga

| |
|------------|
| WG 1074001 |
|------------|

| LAMP | WATT | CLASS | | |
|--------------------|---------|-------|---|---|
| E14 Golf Ball LED* | 60W max | | ✓ | ✓ |

▼ Lamp excluded / La lampe exclu / Das Leuchtmittel ist ausgeschlossen / La lampadina esclusi.



460 Brushed Antique Brass

Goya

| | | | | | | LAMP | WATT | INPUT | K | CRI | Lm | CLASS | | |
|---------|-----------------------------|---------|------------------------------|---------|------------------------------|---------|--------------|-------|----------|------|----|-------|--|---|
| 460 LED | <input type="checkbox"/> BN | 1115007 | <input type="checkbox"/> BAB | 1115012 | <input type="checkbox"/> PCh | 1115008 | Integral LED | 7.5W | 220-240V | 2700 | 80 | 821 | | ✓ |
| 760 LED | <input type="checkbox"/> BN | 1115009 | <input type="checkbox"/> BAB | 1115013 | <input type="checkbox"/> PCh | 1115010 | Integral LED | 9.6W | 220-240V | 2700 | 80 | 1109 | | ✓ |





350 Matt Nickel

Renoir

| | | | | LAMP | WATT | INPUT | K | CRI | Lm | CLASS | | |
|-----|----|---------|-----|---------|--------------|-------|----------|------|----|-------|--|-------|
| 350 | Br | 1371025 | MBB | 1371030 | Integral LED | 3.8W | 220-240V | 2700 | 90 | 190 | | Phase |
| 520 | Br | 1371027 | MBB | 1371031 | Integral LED | 4.8W | 220-240V | 2700 | 90 | 261 | | Phase |
| 680 | Br | 1371029 | MBB | 1371032 | Integral LED | 6.3W | 220-240V | 2700 | 90 | 367 | | Phase |







600 Bronze

Mondrian

| | | | | LAMP | WATT | INPUT | K | CRI | Lm | CLASS | |
|----------------------|------------|------------|--|--------------|-------|----------|------|-----|---------|-------|---|
| 400 | Br 1374036 | MB 1374041 | | Integral LED | 6.9W | 220-240V | 2700 | 90 | 127-161 | ⊕ | - |
| 600 | Br 1374038 | MB 1374042 | | Integral LED | 10.8W | 220-240V | 2700 | 90 | 214-219 | ⊕ | - |
| Frame Mounted | | | | | | | | | | | |
| 400* | Br 1374032 | MB 1374039 | | Integral LED | 6.9W | 12V CV* | 2700 | 90 | 127-161 | ⊖ | ✓ |
| 600* | Br 1374034 | MB 1374040 | | Integral LED | 10.8W | 12V CV* | 2700 | 90 | 214-219 | ⊖ | ✓ |

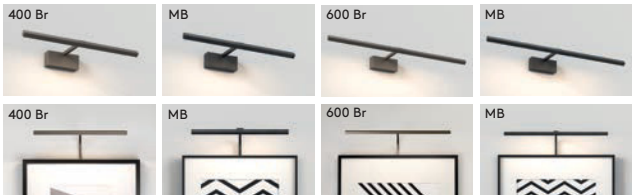
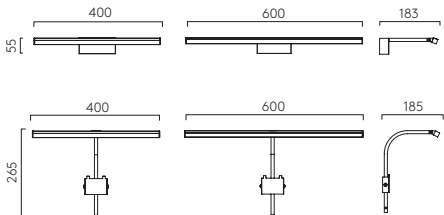

* Can be frame-mounted or wall mounted/Peut être monté sur le cadre ou le mur/Kann auf dem Rahmen oder an der Wand montiert werden/Può essere montato a un quadro o a una parete.
 • Driver excluded/Driver d'entrée exclu/Das treiber ist ausgeschlossen/Driver esclusi.



Leros Trimless

| | LAMP | WATT | INPUT | K | CRI | Lm | CLASS | | |
|------------|--------------|------|--------|------|-----|----|-------|---|---|
| MW 1342002 | Integral LED | 1.1W | 350mA▼ | 2700 | 80 | 36 | | ✓ | ✓ |

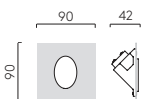

▼ Driver excluded/Driver d'entrée exclu/Das treiber ist ausgeschlossen/Driver esclusi.
 Driver must be installed remotely in a serviceable location./Le driver doit être installé à distance dans un endroit accessible/Treiber muss remote in einem zu wart Speicherort installiert./Driver deve essere installato a distanza in un luogo accessibile.



Tango

| | LAMP | WATT | INPUT | K | CRI | Lm | CLASS | | |
|---------------------------------------|--------------|------|--------|------|-----|----|-------|---|---|
| BSS 1175002 MW 1175001 TB 1175004 | Integral LED | 2.2W | 350mA* | 3000 | 90 | 23 | | ✓ | ✓ |

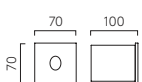

*Driver excluded/Driver d'entrée exclu/Das treiber ist ausgeschlossen/Driver esclusi.

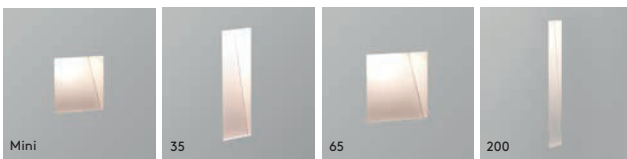

Borgo Trimless

| | | | LAMP | WATT | INPUT | K | CRI | Lm | CLASS | 🔌 |
|-------|----|---------|--------------|------|--------------------|------|-----|----|-------|---|
| Mini* | MW | 1212039 | Integral LED | 2.6W | 350mA [▼] | 3000 | 90 | 22 | | ✓ |
| | MW | 1212037 | Integral LED | 2.6W | 350mA [▼] | 2700 | 90 | 29 | | ✓ |
| 35 | MW | 1212007 | Integral LED | 3.5W | 700mA [▼] | 3000 | 90 | 70 | | ✓ |
| | MW | 1212027 | Integral LED | 4.1W | 700mA [▼] | 2700 | 90 | 76 | | ✓ |
| 65 | MW | 1212008 | Integral LED | 3.8W | 700mA [▼] | 3000 | 90 | 80 | | ✓ |
| | MW | 1212028 | Integral LED | 4.1W | 700mA [▼] | 2700 | 90 | 70 | | ✓ |
| 200 | MW | 1212038 | Integral LED | 3.8W | 700mA [▼] | 3000 | 90 | 56 | | ✓ |
| | MW | 1212040 | Integral LED | 4.1W | 700mA [▼] | 2700 | 90 | 46 | | ✓ |

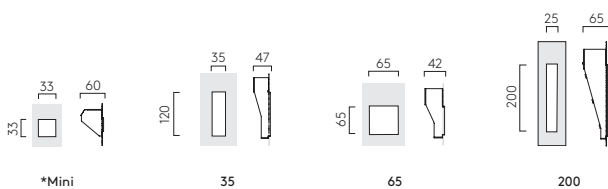

▼ Driver excluded/Driver d'entrée exclu/Das treiber ist ausgeschlossen/Driver esclusi.

* Borgo Mini Driver must be installed remotely in a serviceable location./ Le driver doit être installé à distance dans un endroit accessible/Treiber muss remote in einem zu wart Speicherort installiert/Driver deve essere installato a distanza in un luogo accessibile.

35, 65 + 200 LED Driver accessible after installation/Driver LED accessibles après installation/LED-Treiber ist nach der Installation zugänglich/Accesso al driver anche dopo l'installazione

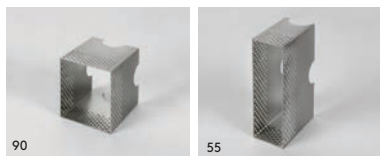

A wall box accessory is available for installation of the BORG 55 and 90 into brick walls / Accessoire mural disponible pour l'installation de la gamme BORG dans des murs en brique / Als Zubehör sind Wandkästen erhältlich, die eine Installation der BORG Serie in Ziegelwänden ermöglichen. / Un accessorio per le pareti è disponibile per l'installazione del BORG in muri di mattoni.

90 Wall Box 6013002 H.108mm W.87mm D.100mm
 55 Wall Box 6013001 H.165mm W.51mm D.100mm

Borgo

| | | LAMP | WATT | INPUT | K | CRI | Lm | CLASS | | |
|----|---------|--------------|------|--------------------|------|-----|----|-------|---|---|
| 54 | 1212019 | Integral LED | 2.6W | 350mA [▼] | 3000 | 90 | 30 | | ✓ | ✓ |
| | 1212033 | Integral LED | 2.6W | 350mA [▼] | 2700 | 90 | 30 | | ✓ | ✓ |
| 55 | 1212001 | Integral LED | 3.9W | 700mA [▼] | 3000 | 90 | 39 | | ✓ | ✓ |
| | 1212021 | Integral LED | 4.1W | 700mA [▼] | 2700 | 90 | 40 | | ✓ | ✓ |
| 90 | 1212004 | Integral LED | 4.2W | 700mA [▼] | 3000 | 90 | 72 | | ✓ | ✓ |
| | 1212024 | Integral LED | 4.1W | 700mA [▼] | 2700 | 90 | 68 | | ✓ | ✓ |

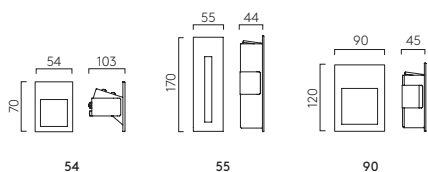

[▼] Driver excluded / Driver d'entrée exclu / Das treiber ist ausgeschlossen / Driver esclusi.
 Driver accessible after installation / Driver LED accessibles après installation / LED-Treiber ist nach der Installation zugänglich / Accesso al driver anche dopo l'installazione



Halo Portable

| | LAMP | WATT | INPUT | K | CRI | Lm | CLASS | | | |
|-------------|--------------|------|-------------|------|-----|-----|-------|--------|-------------------------------------|-------------------------------------|
| MW 1468002 | Integral LED | 2.6W | 5V DC USB-C | 2700 | 90 | 214 | | 4 step | <input checked="" type="checkbox"/> | <input checked="" type="checkbox"/> |
| MB 1468001 | | | | | | | | | | |
| LBr 1468003 | | | | | | | | | | |

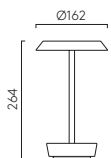

Charged via USB-C to USB-A charging cable (included)
5V USB charger available separately, reference 6032001



Zeppo Portable

| | LAMP | WATT | INPUT | K | CRI | Lm | CLASS | | | | | | |
|------------|-------------|-------------|--------------|------|------|------|-------|-----|--|--------|---|---|---|
| MB 1176019 | PGr 1176026 | LBr 1176022 | Integral LED | 2.6W | USB* | 2700 | 80 | 287 | | 4 step | ✓ | ✓ | ✓ |

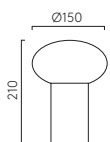

* Charged via USB-C to USB-A charging cable (included), 5V USB charger available separately, reference 6032001



Ella Table

| MB Po | | LBr Po | | LAMP | WATT | CLASS | |
|---------|--|----------|--|------|---------|--------------------------|---|
| 1470001 | | 1470002 | | G9▼ | 10W max | <input type="checkbox"/> | ✓ |

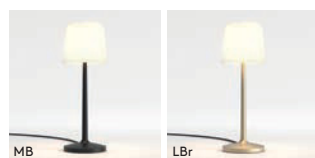
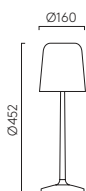

▼ Lamp excluded / La lampe exclu / Das Leuchtmittel ist ausgeschlossen / La lampadina esclusi.



Carlton Desk

| | LAMP | WATT | CLASS | <input type="checkbox"/> |
|------------|------|--------|--------------------------|-------------------------------------|
| Pb 1467003 | G9* | 5W max | <input type="checkbox"/> | <input checked="" type="checkbox"/> |

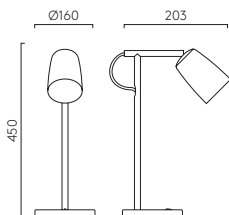

* Lamp excluded/La lampe exclu/Das Leuchtmittel ist ausgeschlossen/La lampadina esclusi.



Porcelain Shade

Imari Desk

Br Po 1460001 MN Po 1460004

LAMP WATT CLASS

E27* 12W max ✓

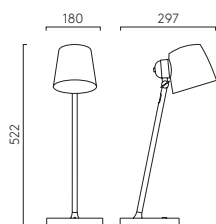

▼ Lamp excluded / La lampe exclu / Das Leuchtmittel ist ausgeschlossen / La lampadina esclusi.



Gerrit

| | LAMP | WATT | INPUT | K | CRI | Lm | CLASS | | |
|------------|--------------|-------|----------|------|-----|-----|-------|---|---|
| AG 1465001 | Integral LED | 10.5W | 100-240V | 2700 | 90 | 393 | | ✓ | ✓ |

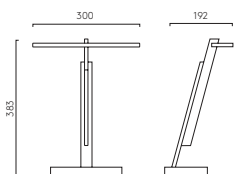



Black Fabric Shade

Edward Desk

SHADE EXCLUDED

| | LAMP | WATT | CLASS | |
|------------|------|---------|--------------------------|-------------------------------------|
| MB 1441003 | E27* | 12W max | <input type="checkbox"/> | <input checked="" type="checkbox"/> |

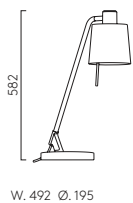

Tapered Drum 155
Fabric shade options

- WF 5013027
- BF 5013028
- PF 5013029

Tapered Drum 155
Metal shade options

- MB 5013024
- MG 5013026

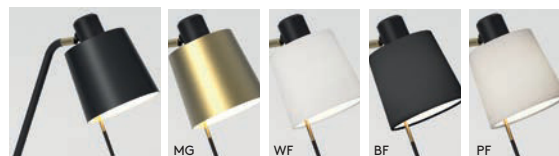

• Special Shade Colours/Couleurs spéciales/Sonderfarben/Colori speciali. See p.404
 ▼ Lamp excluded/La lampe exclu/Das Leuchtmittel ist ausgeschlossen/La lampadina esclusi.



Edward Floor

SHADE EXCLUDED

MB 1441017

| LAMP | WATT | CLASS | |
|------|---------|-------|-------------------------------------|
| E27* | 12W max | | <input checked="" type="checkbox"/> |

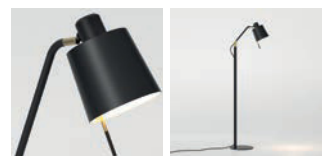
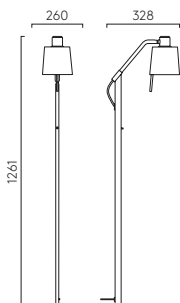

▼ Lamp excluded/La lampe exclu/Das Leuchtmittel ist ausgeschlossen/La lampadina esclusi.



Atelier Desk

| | LAMP | WATT | CLASS |
|------------|------|---------|-------------------------------------|
| MB 1224061 | E27* | 12W max | <input checked="" type="checkbox"/> |

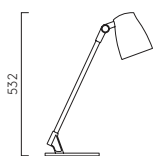

W. 122 max Ø.200



▼ Lamp excluded / La lampe exclu / Das Leuchtmittel ist ausgeschlossen / La lampadina esclusi.



Matt Black Shade

Miura Desk USB

SHADE EXCLUDED

| | LAMP | WATT | INPUT | K | CRI | Lm | CLASS | | |
|--------------------------|--------------|------|----------|------|-----|-----|-------|---|---|
| MN 1444007 MG 1444008 | Integral LED | 7.5W | 220-240V | 2700 | 80 | 367 | | ✓ | ✓ |

Device charging - USB-A

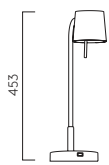

W. 325 Ø.150



• Special Shade Colours / Couleurs spéciales / Sonderfarben / Colori speciali - P. 404



Joel Table

| | LAMP | WATT | CLASS | |
|------------|------|---------|---|---|
| MB 1223002 | E27* | 42W max |  |  |



W. 470 max Ø.180



▼ Lamp excluded / La lampe exclu / Das Leuchtmittel ist ausgeschlossen / La lampadina esclusi.



Joel Floor

| | LAMP | WATT | CLASS | |
|------------|------|---------|--------------------------|-------------------------------------|
| MB 1223005 | E27* | 42W max | <input type="checkbox"/> | <input checked="" type="checkbox"/> |



W. 660 Ø.220



* Lamp excluded / La lampe exclu / Das Leuchtmittel ist ausgeschlossen / La lampadina esclusi.



Leda Desk

SHADE EXCLUDED

Quickbase™

MB 1457002

LAMP

WATT

CLASS



35mm GU10*

4W max

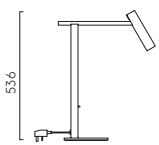

Leda Shade options

- MN 5040001
- MB 5040004
- MG 5040005

W.150 D.300

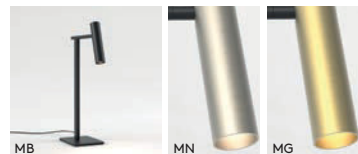

▼ Lamp excluded/La lampe exclu/Das Leuchtmittel ist ausgeschlossen/La lampadina esclusi.



Leda Floor

SHADE EXCLUDED

Quickbase™

 MB 1457001

LAMP

WATT

CLASS



35mm GU10*

4W max

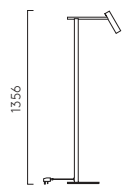

W. 355 D.200

Leda Shade
options
 MN 5040001

 MB 5040004

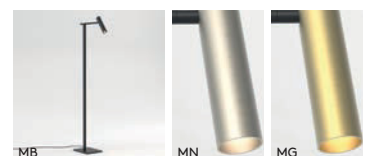
 MG 5040005

▼ Lamp excluded/La lampe exclu/Das Leuchtmittel ist ausgeschlossen/La lampadina esclusi.
Quickbase™



Ascoli Desk

| | | | | LAMP | WATT | CLASS | | | | | |
|----|---------|----|---------|------|---------|-------|---------|-------|--------|--|--|
| MW | 1286016 | MN | 1286017 | Br | 1286024 | MB | 1286086 | GU10* | 6W max | | |

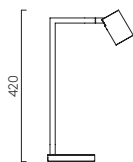

W. 210 Ø.135



▼ Lamp excluded / La lampe exclu / Das Leuchtmittel ist ausgeschlossen / La lampadina esclusi.



Ascoli Floor

| | LAMP | WATT | CLASS | |
|------------|-------|--------|--------------------------|-------------------------------------|
| MW 1286157 | GU10* | 6W max | <input type="checkbox"/> | <input checked="" type="checkbox"/> |
| Br 1286155 | | | | |
| MB 1286156 | | | | |

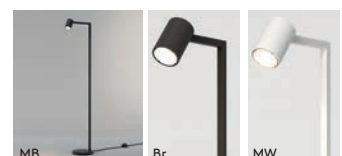
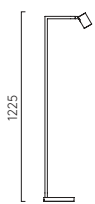

▼ Lamp excluded/La lampe exclu/Das Leuchtmittel ist ausgeschlossen/La lampadina esclusi.



Enna Desk

| | LAMP | WATT | INPUT | K | CRI | Lm | CLASS | | |
|------|---|--------------|-------|----------|------|----|-------|--------------------------|-------------------------------------|
| | <input type="checkbox"/> MW 1058005 <input type="checkbox"/> MB 1058006 <input type="checkbox"/> MN 1058057 <input type="checkbox"/> MG 1058106 | Integral LED | 4.5W | 100-240V | 2700 | 90 | 124 | <input type="checkbox"/> | <input checked="" type="checkbox"/> |
| USB* | <input type="checkbox"/> MW 1058212 <input type="checkbox"/> MB 1058210 <input type="checkbox"/> MN 1058213 <input type="checkbox"/> MG 1058214 | Integral LED | 3.3W | 100-240V | 2700 | 90 | 170 | <input type="checkbox"/> | <input checked="" type="checkbox"/> |

* Device charging USB-C

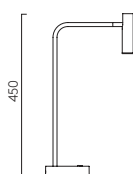

W. 241 Ø.120

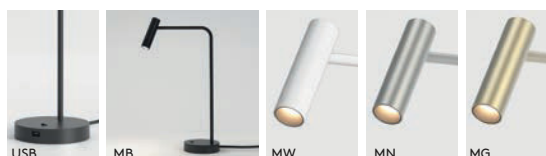

Made to Order Alternative finish options are available as Made to Order for this product subject to minimum order quantities and extended lead times. / D'autres options de finition sur commande sont disponibles pour ce produit, sous condition d'un volume de commande minimum et de délais de livraison prolongés. / Alternative Ausführungen sind für dieses Produkt als Sonderanfertigung erhältlich und unterliegen einer Mindestbestellmenge und längeren Lieferzeiten. / Diverse finiture alternative sono disponibili su misura per questo prodotto con quantitativi minimi e tempi di consegna allungati. See website.



Enna Floor

| | LAMP | WATT | INPUT | K | CRI | Lm | CLASS | | |
|-------------------|-------------------|-------------------|-------------------|--------------|------|----------|-------------|--------------------------|-------------------------------------|
| MW 1058002 | MB 1058003 | MN 1058058 | MG 1058107 | Integral LED | 4.5W | 100-240V | 2700 90 124 | <input type="checkbox"/> | <input checked="" type="checkbox"/> |



W. 241 Ø.200



Made to Order Alternative finish options are available as Made to Order for this product subject to minimum order quantities and extended lead times. / D'autres options de finition sur commande sont disponibles pour ce produit, sous condition d'un volume de commande minimum et de délais de livraison prolongés. / Alternative Ausführungen sind für dieses Produkt als Sonderanfertigung erhältlich und unterliegen einer Mindestbestellmenge und längeren Lieferzeiten. / Diverse finiture alternative sono disponibili su misura per questo prodotto con quantitativi minimi e tempi di consegna allungati. See website.



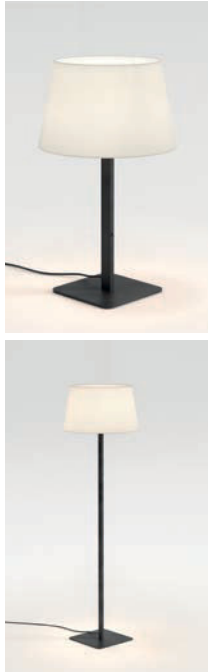
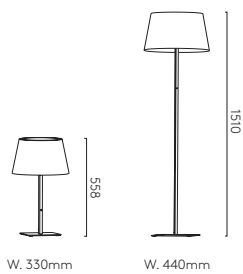

TABLE + FLOOR
NEW QUICKBASE™

Beaumont Table + Floor

SHADE EXCLUDED

| Quickbase™ | LAMP | WATT | INPUT | K | CRI | Lm | CLASS | |
|---|------|---------|-------|---|-----|----|-------|---|
| Table MB 1480003 | E27* | 60W max | - | - | - | - | | ✓ |
| Floor MB 1480008 | E27* | 60W max | - | - | - | - | | ✓ |



- | | |
|--|--|
| French Drum 330 | French Drum 440 |
| PF 5047003 | PF 5047005 |
| WF 5047004 | WF 5047006 |

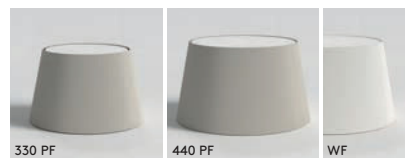

* Lamp excluded/La lampe exclu/Das Leuchtmittel ist ausgeschlossen/La lampadina esclusi.



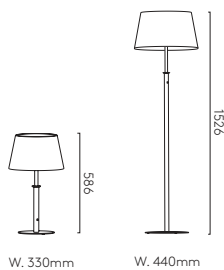

TABLE + FLOOR
NEW QUICKBASE™

Club Table + Floor

SHADE EXCLUDED

| Quickbase™ | LAMP | WATT | INPUT | K | CRI | Lm | CLASS | |
|--------------------------------------|------|---------|-------|---|-----|----|-------|---|
| Table Br 1483001 | E27* | 60W max | - | - | - | - | ⊕ | ✓ |
| Floor Br 1483002 | E27* | 60W max | - | - | - | - | ⊕ | ✓ |



- | | | | |
|-------------------------|-------------------------|-------------------------|-------------------------|
| French Drum 330 | | French Drum 440 | |
| PF 5047003 | PF 5047005 | PF 5047005 | PF 5047006 |
| WF 5047004 | WF 5047006 | | |



▼ Lamp excluded/La lampe exclu/Das Leuchtmittel ist ausgeschlossen/La lampadina esclusi.



Bronze + White Fabric Shade

Mitsu Table

SHADE EXCLUDED

| | LAMP | WATT | CLASS | |
|------------|------|---------|--------------------------|-------------------------------------|
| MN 1394009 | E27* | 12W max | <input type="checkbox"/> | <input checked="" type="checkbox"/> |

Br 1394010

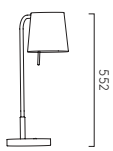

W. 351 D.185

Cone 173 shade options

- WF 5018031
- OF 5018033
- PF 5018034



* Special Shade Colours / Couleurs spéciales / Sonderfarben / Colori speciali. See p.404

▼ Lamp excluded/La lampe exclu/Das Leuchtmittel ist ausgeschlossen/La lampadina esclusi.

Made to Order Alternative finish options are available as Made to Order for this product subject to minimum order quantities and extended lead times. / D'autres options de finition sur commande sont disponibles pour ce produit, sous condition d'un volume de commande minimum et de délais de livraison prolongés. / Alternative Ausführungen sind für dieses Produkt als Sonderanfertigung erhältlich und unterliegen einer Mindestbestellmenge und längeren Lieferzeiten. / Diverse finiture alternative sono disponibili su misura per questo prodotto con quantitativi minimi e tempi di consegna allungati. See website.



Bronze + White Fabric Shade

Mitsu Floor

SHADE EXCLUDED

| | | | LAMP | WATT | CLASS | | | | |
|----|---------|----|---------|------|---------|------|---------|--------------------------|---|
| Br | 1394058 | MB | 1394059 | MN | 1394060 | E27* | 12W max | <input type="checkbox"/> | ✓ |

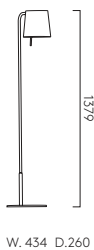

- Cone 173 shade options
- WF 5018031
 - OF 5018033
 - PF 5018034



• Special Shade Colours / Couleurs spéciales / Sonderfarben / Colori speciali. See p.404

* Lamp excluded / La lampe exclu / Das Leuchtmittel ist ausgeschlossen / La lampadina esclusi.

Made to Order Alternative finish options are available as Made to Order for this product subject to minimum order quantities and extended lead times. / D'autres options de finition sur commande sont disponibles pour ce produit, sous condition d'un volume de commande minimum et de délais de livraison prolongés. / Alternative Ausführungen sind für dieses Produkt als Sonderanfertigung erhältlich und unterliegen einer Mindestbestellmenge und längeren Lieferzeiten. / Diverse finiture alternative sono disponibili su misura per questo prodotto con quantitativi minimi e tempi di consegna allungati. See website.



Bronze + Putty Fabric Shade

Venn Table

SHADE EXCLUDED

| | | | | LAMP | WATT | INPUT | K | CRI | Lm | CLASS | <input type="checkbox"/> | |
|-------------------------------|-----------------------------|---------|-----------------------------|---------|----------------------------|---------|----------|------|----|-------|--------------------------|---|
| Quickbase™ (not table reader) | | | | | | | | | | | | |
| Table | <input type="checkbox"/> MN | 1433036 | <input type="checkbox"/> Br | 1433035 | E27* | 12W max | - | - | - | - | <input type="checkbox"/> | ✓ |
| Table Reader | <input type="checkbox"/> MN | 1433038 | <input type="checkbox"/> Br | 1433037 | E27* 12W max+ Integral LED | 2W max | 100-240V | 2700 | 90 | 211 | <input type="checkbox"/> | ✓ |

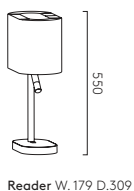
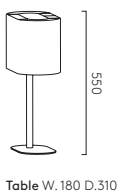

Stadium 220
Shade options
 WF 5043004
 PF 5043003

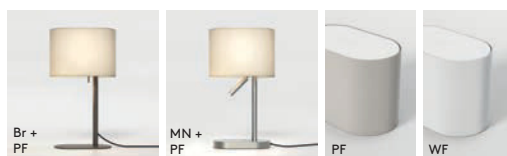

* Special Shade Colours / Couleurs spéciales / Sonderfarben / Colori speciali. See p.404

▼ Lamp excluded / La lampe exclu / Das Leuchtmittel ist ausgeschlossen / La lampadina esclusi.

Made to Order Alternative finish options are available as Made to Order for this product subject to minimum order quantities and extended lead times. / D'autres options de finition sur commande sont disponibles pour ce produit, sous condition d'un volume de commande minimum et de délais de livraison prolongés. / Alternative Ausführungen sind für dieses Produkt als Sonderanfertigung erhältlich und unterliegen einer Mindestbestellmenge und längeren Lieferzeiten. / Diverse finiture alternative sono disponibili su misura per questo prodotto con quantitativi minimi e tempi di consegna allungati. See website.



Matt Nickel + Putty Fabric Shade

Venn Floor

SHADE EXCLUDED

Quickbase™

LAMP

WATT

CLASS



MN 1433026 Br 1433025

E27*

12W max

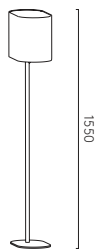

Floor W. 234 D. 424

Stadium 300

Shade options

WF 5043006

PF 5043005

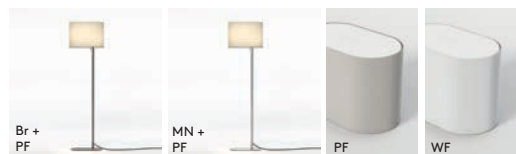

* Special Shade Colours / Couleurs spéciales / Sonderfarben / Colori speciali. See p.404

† Lamp excluded / La lampe exclu / Das Leuchtmittel ist ausgeschlossen / La lampadina esclusi.

Made to Order Alternative finish options are available as Made to Order for this product subject to minimum order quantities and extended lead times. / D'autres options de finition sur commande sont disponibles pour ce produit, sous condition d'un volume de commande minimum et de délais de livraison prolongés. / Alternative Ausführungen sind für dieses Produkt als Sonderanfertigung erhältlich und unterliegen einer Mindestbestellmenge und längeren Lieferzeiten. / Diverse finiture alternative sono disponibili su misura per questo prodotto con quantitativi minimi e tempi di consegna allungati. See website.



Bronze + Putty Fabric Shade

Ravello Table

SHADE EXCLUDED

| | | | LAMP | WATT | CLASS | <input type="checkbox"/> | | | |
|------------------------------|---------|-----------------------------|---------|-----------------------------|---------|--------------------------|---------|--------------------------|-------------------------------------|
| <input type="checkbox"/> PCh | 1222007 | <input type="checkbox"/> MN | 1222008 | <input type="checkbox"/> Br | 1222009 | E27▼ | 60W max | <input type="checkbox"/> | <input checked="" type="checkbox"/> |

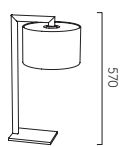

Drum 250
shade options
 WF 5016007
 PF 5016019

W. 250 D. 305



- Special Shade Colours / Couleurs spéciales / Sonderfarben / Colori speciali. See p.404
- ▼ Lamp excluded / La lampe exclu / Das Leuchtmittel ist ausgeschlossen / La lampadina esclusi.



Matt Nickel + White Fabric Shade

Ravello Floor

SHADE EXCLUDED

| | | | LAMP | WATT | CLASS | | | | |
|----|---------|----|---------|------|---------|------|---------|--------------------------|-------------------------------------|
| Br | 1222091 | MN | 1222092 | PCh | 1222093 | E27* | 60W max | <input type="checkbox"/> | <input checked="" type="checkbox"/> |

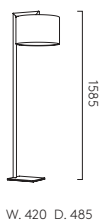

Drum 420
shade options
WF 5016004
PF 5016028



• Special Shade Colours / Couleurs spéciales / Sonderfarben / Colori speciali. See p.404

▼ Lamp excluded / La lampe exclu / Das Leuchtmittel ist ausgeschlossen / La lampadina esclusi.

Made to Order Alternative finish options are available as Made to Order for this product subject to minimum order quantities and extended lead times. / D'autres options de finition sur commande sont disponibles pour ce produit, sous condition d'un volume de commande minimum et de délais de livraison prolongés. / Alternative Ausführungen sind für dieses Produkt als Sonderanfertigung erhältlich und unterliegen einer Mindestbestellmenge und längeren Lieferzeiten. / Diverse finiture alternative sono disponibili su misura per questo prodotto con quantitativi minimi e tempi di consegna allungati. See website.



Bronze + Rectangle 285 White Fabric Shade

Park Lane Table

SHADE EXCLUDED

| | LAMP | WATT | CLASS | |
|------------|------|---------|--------------------------|-------------------------------------|
| Br 1080046 | E27▼ | 60W max | <input type="checkbox"/> | <input checked="" type="checkbox"/> |

Shade Options

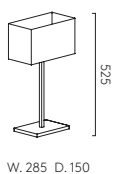

Rectangle 285
 WF 5001001
 PF 5001017

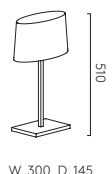

Tapered Oval*
 WF 5034001
 PF 5034004



• Special Shade Colours/ Couleurs spéciales/ Sonderfarben/ Colori speciali - P. 404

▼ Lamp excluded/ La lampe exclu/ Das Leuchtmittel ist ausgeschlossen/ La lampadina esclusi.

* To be used with LED lamp only/ Pour utilisation avec lampe LED seulement/ nur mit Kompaktleuchtstofflampe/ LED verwenden/ Solo per l'uso con lampade a LED



Park Lane Floor

SHADE EXCLUDED

Br 1080047

| LAMP | WATT | CLASS | <input type="checkbox"/> |
|------|---------|--------------------------|-------------------------------------|
| E27* | 60W max | <input type="checkbox"/> | <input checked="" type="checkbox"/> |

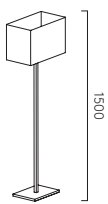

W. 400 D. 225

Rectangle 400
shade options

WF 5001002

PF 5001030

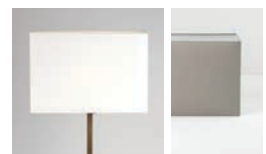

- Special Shade Colours / Couleurs spéciales / Sonderfarben / Colori speciali - P. 404
- ▼ Lamp excluded / La lampe exclu / Das Leuchtmittel ist ausgeschlossen / La lampadina esclusi.



Cut

| MW | Br | LAMP | WATT | CLASS | |
|---------|---------|-------|--------|--------------------------|-------------------------------------|
| 1412001 | 1412003 | GU10▼ | 6W max | <input type="checkbox"/> | <input checked="" type="checkbox"/> |

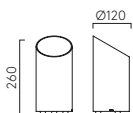

▼ Lamp excluded / La lampe exclu / Das Leuchtmittel ist ausgeschlossen / La lampadina esclusi.

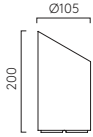

Marasino

P 1218001

| LAMP | WATT | CLASS | |
|-------|--------|-------|--|
| GU10* | 6W max | | |

* Lamp excluded/La lampe exclu/Das Leuchtmittel ist ausgeschlossen/La lampadina esclusi.
Can be painted/Peut être peint/kann lackiert werden/Può essere verniciato.

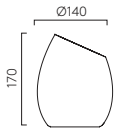

Limina

P 1221001

| LAMP | WATT | CLASS | |
|-------|--------|-------|--|
| GU10* | 6W max | | |

* Lamp excluded/La lampe exclu/Das Leuchtmittel ist ausgeschlossen/La lampadina esclusi.
Can be painted/Peut être peint/kann lackiert werden/Può essere verniciato.



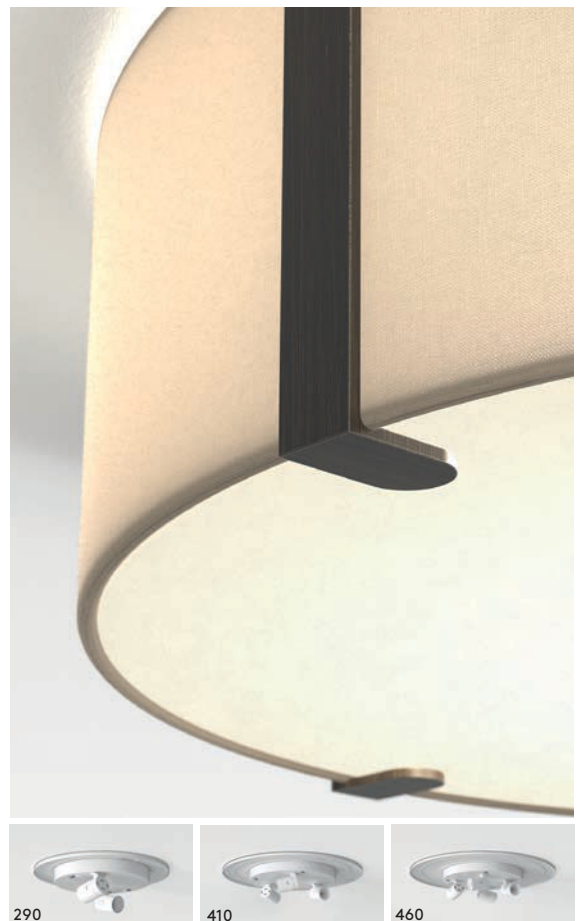

Ceiling Bases

Elba Ceiling

SHADE EXCLUDED

| Base | Compatible Shades Sold Separately | LAMP | WATT | CLASS | |
|-------------|-----------------------------------|------|-------------|-------|---|
| 290 1462001 | Square 350 | E27* | 2 x 12W max | | ✓ |
| 410 1462002 | Round 450 | E27* | 3 x 12W max | | ✓ |
| 460 1462003 | Round 600 + Square 500 | E27* | 4 x 12W max | | ✓ |

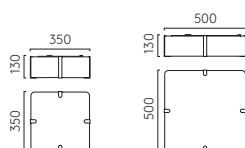

Elba Square
Shade options

| | | |
|-----|----|---------|
| 350 | WF | 5043007 |
| 350 | PF | 5043008 |
| 500 | WF | 5042009 |
| 500 | PF | 5042010 |

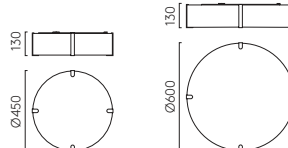

Elba Round
Shade options

| | | |
|-----|----|---------|
| 450 | WF | 5042001 |
| 450 | PF | 5042002 |
| 600 | WF | 5042003 |
| 600 | PF | 5042004 |

* Lamp excluded / La lampe exclu / Das Leuchtmittel ist ausgeschlossen / La lampadina esclusi.

Made to Order Larger size option is available as Made to Order for this product subject to minimum order quantities and extended lead times. / D'autres options de taille plus importante sur commande sont disponibles pour ce produit, sous condition d'un volume de commande minimum et de délais de livraison prolongés. Größere Größen sind für dieses Produkt als Sonderanfertigung erhältlich und unterliegen einer Mindestbestellmenge und längeren Lieferzeiten. / Un formato maggiore è disponibile su misura per questo prodotto con quantitativi minimi e tempi di consegna allungati. See website.



480 Putty Fabric

Cambria

| | | | | LAMP | WATT | CLASS | |
|-----|-------------------------------------|-------------------------------------|--|------------------|---------|-------|---|
| 380 | <input type="checkbox"/> WF 1421001 | <input type="checkbox"/> PF 1421002 | | E27 [▼] | 2 x 12W | | ✓ |
| 480 | <input type="checkbox"/> WF 1421004 | <input type="checkbox"/> PF 1421005 | | E27 [▼] | 3 x 12W | | ✓ |
| 580 | <input type="checkbox"/> WF 1421007 | <input type="checkbox"/> PF 1421008 | | E27 [▼] | 3 x 12W | | ✓ |

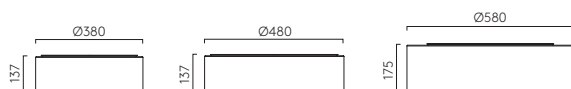

• Special Shade Colours/Couleurs spéciales/Sonderfarben/Colori speciali. See p.404
 ▼ Lamp excluded/La lampe exclu/Das Leuchtmittel ist ausgeschlossen/La lampadina esclusi.



Fife

| | | | LAMP | WATT | CLASS | |
|-----|---------|---------|------|-------------|-------|---|
| 330 | 1471005 | 1471006 | E27* | 12W max | | ✓ |
| 430 | 1471003 | 1471004 | E27* | 2 x 12W max | | ✓ |
| 530 | 1471001 | 1471002 | E27* | 3 x 12W max | | ✓ |

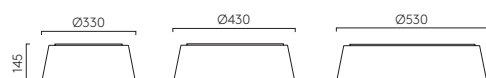

* Lamp excluded / La lampe exclu / Das Leuchtmittel ist ausgeschlossen / La lampadina esclusi.



480 Putty Fabric

Salina

| | WF | PF | LAMP | WATT | CLASS | |
|-----|---------|---------|------|---------|-------|---|
| 400 | 1463001 | 1463003 | E27* | 2 x 12W | | ✓ |
| 550 | 1463002 | 1463004 | E27* | 3 x 12W | | ✓ |

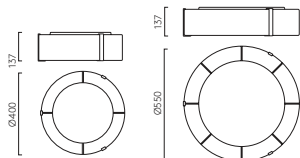

• Special Shade Colours/Couleurs spéciales/Sonderfarben/Colori speciali. See p.404
 ▼ Lamp excluded/La lampe exclu/Das Leuchtmittel ist ausgeschlossen/La lampadina esclusi.



600

Bevel Round

| | | | CEILING PLATE EXCL. | LAMP | WATT | CLASS | |
|-----|-------------------------------------|-------------------------------------|----------------------|------|-------------|-------|---|
| 450 | <input type="checkbox"/> WF 5021003 | <input type="checkbox"/> OF 5021011 | 3-way plate: 1296001 | E27* | 3 x 60W max | | ✓ |
| 600 | <input type="checkbox"/> WF 5021001 | <input type="checkbox"/> OF 5021009 | 4-way plate: 1296002 | E27* | 4 x 60W max | | ✓ |

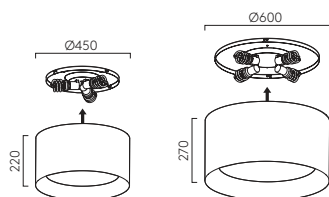

* Lamp excluded/La lampe exclu/Das Leuchtmittel ist ausgeschlossen/La lampadina esclusi.



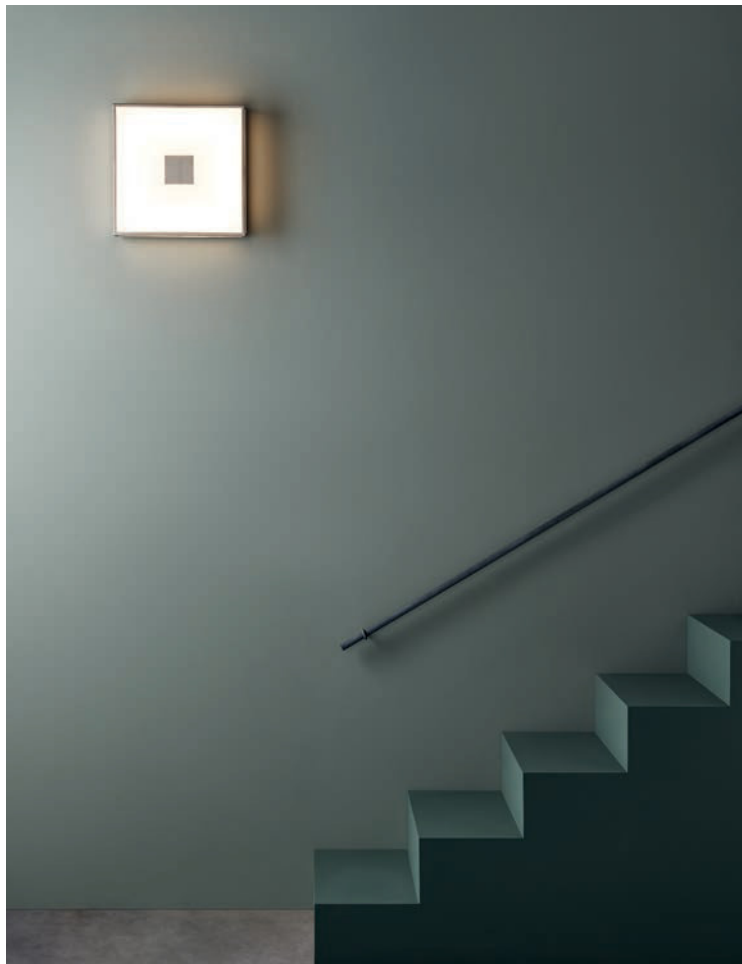

Mashiko

| | | | | LAMP | WATT | CLASS | | |
|-------------------|---------|---------|--|------------------|-------------|-------|---|---|
| Square 200 | 1121009 | 1121056 | | E27 [▼] | 60W max | | ✓ | ✓ |
| Square 300 | 1121005 | 1121079 | | E27 [▼] | 2 x 60W max | | ✓ | ✓ |
| Square 400 | 1121010 | 1121013 | | E27 [▼] | 4 x 40W max | | ✓ | ✓ |
| Round 230 | 1121021 | 1121097 | | E27 [▼] | 60W max | | ✓ | ✓ |
| Round 300 | 1121017 | 1121043 | | E27 [▼] | 60W max | | ✓ | ✓ |
| Round 400 | 1121026 | 1121085 | | E27 [▼] | 3 x 42W max | | ✓ | ✓ |

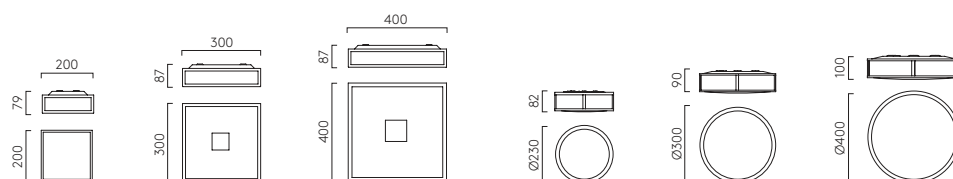

▼ Lamp excluded/La lampe exclu/Das Leuchtmittel ist ausgeschlossen/La lampadina esclusi.



300

Taiko

| | | | LAMP | WATT | CLASS | |
|-----|-------------------------------------|-------------------------------------|------|-------------|-------|---|
| 300 | <input type="checkbox"/> MB 1456001 | <input type="checkbox"/> MW 1456005 | E27* | 2 x 12W max | ⊕ | ✓ |
| 400 | <input type="checkbox"/> MB 1456002 | <input type="checkbox"/> MW 1456006 | E27* | 3 x 12W max | ⊕ | ✓ |



* Lamp excluded / La lampe exclu / Das Leuchtmittel ist ausgeschlossen / La lampadina esclusi.



Mallon LED

| | LAMP | WATT | INPUT | K | CRI | Lm | CLASS | | | | | | | | |
|------------------------------|---------|-----------------------------|---------|-----------------------------|---------|--------------|-------|------------|-----------------|----|-------------|--------------------------|-------|---|---|
| <input type="checkbox"/> PCh | 1125014 | <input type="checkbox"/> MN | 1125015 | <input type="checkbox"/> Br | 1125016 | Integral LED | 15.3W | Mains 230V | 2700/3000/4000* | 90 | 670-730-733 | <input type="checkbox"/> | Phase | ✓ | ✓ |

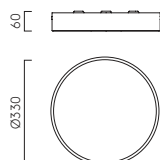

Colour temperature can be adjusted between stated values via onboard switch / La température de couleur peut être ajustée entre les valeurs indiquées via un interrupteur intégré / Die Farbtemperatur kann mit dem eingebauten Schalter zwischen den angegebenen Werten eingestellt werden. / La temperatura di colore può essere impostata tra valori indicati tramite interruttore a bordo



Aquina Ceiling

| | LAMP | WATT | CLASS | | |
|-----|---------------------|------|-------------|--|--------|
| 240 | 1450003 1450009 | E27* | 12W max | | ✓ ✓ |
| 360 | 1450004 1450011 | E27* | 2 x 12W max | | ✓ ✓ |

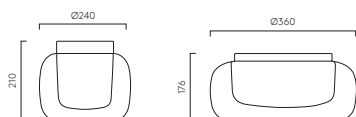

▼ Lamp excluded / La lampe exclu / Das Leuchtmittel ist ausgeschlossen / La lampadina esclusi.



Zeppo Ceiling

| | LAMP | WATT | CLASS | | |
|---------------------------|------|---------|-------|---|---|
| PCh 1176001 MB 1176017 | E27* | 60W max | | ✓ | ✓ |

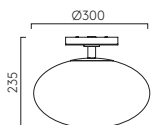

▼ Lamp excluded/La lampe exclu/Das Leuchtmittel ist ausgeschlossen/La lampadina esclusi.





PCh



MB

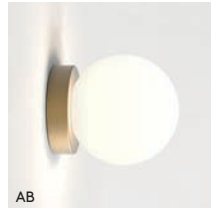

AB

Can be wall or ceiling mounted



AB + Round Shade CR



MB + Tulip Shade SR



MB + Round Shade SR



PCh + Reed Shade WG



Tacoma Surface

SHADE EXCLUDED

| | LAMP | WATT | IP | CLASS | | |
|--|------|---------|----|--------------------------|-------------------------------------|-------------------------------------|
| <input type="checkbox"/> MB 1429027 <input type="checkbox"/> AB 1429028 <input type="checkbox"/> PCh 1429029 | G9* | 25W max | 44 | <input type="checkbox"/> | <input checked="" type="checkbox"/> | <input checked="" type="checkbox"/> |

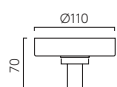

Shade Options

Ø135 Round Shade
 WG 5036001
 WR 5036003
 CR 5036004
 SR 5036005

Ø95 Reed Shade
 WG 5036009
 SR 5036010

Ø124 Tulip shade
 WG 5036007
 SR 5036008

* Lamp excluded/La lampe exclu/Das Leuchtmittel ist ausgeschlossen/La lampadina esclusi.
 Can be wall or ceiling mounted/Peut être monté sur un mur ou un plafond/Kann an einer Wand oder Decke montiert werden/Puo' essere montato su muro o soffitto





Tacoma Pendant

SHADE EXCLUDED

| | LAMP | WATT | IP | CLASS | | |
|--|------|---------|----|--------------------------|---|---|
| <input type="checkbox"/> AB 1429024 <input type="checkbox"/> MB 1429025 <input type="checkbox"/> PCh 1429026 | G9* | 25W max | 44 | <input type="checkbox"/> | ✓ | ✓ |

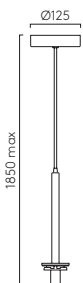

Shade Options

| | | |
|---|---|---|
| <p>Ø135</p> <p>Round Shade</p> <ul style="list-style-type: none"> <input type="checkbox"/> WG 5036001 <input type="checkbox"/> WR 5036003 <input type="checkbox"/> CR 5036004 <input type="checkbox"/> SR 5036005 | <p>Ø95</p> <p>Reed Shade</p> <ul style="list-style-type: none"> <input type="checkbox"/> WG 5036009 <input type="checkbox"/> SR 5036010 | <p>Ø124</p> <p>Tulip shade</p> <ul style="list-style-type: none"> <input type="checkbox"/> WG 5036007 <input type="checkbox"/> SR 5036008 |
|---|---|---|

* Lamp excluded/La lampe exclu/Das Leuchtmittel ist ausgeschlossen/La lampadina esclusi.





180



230

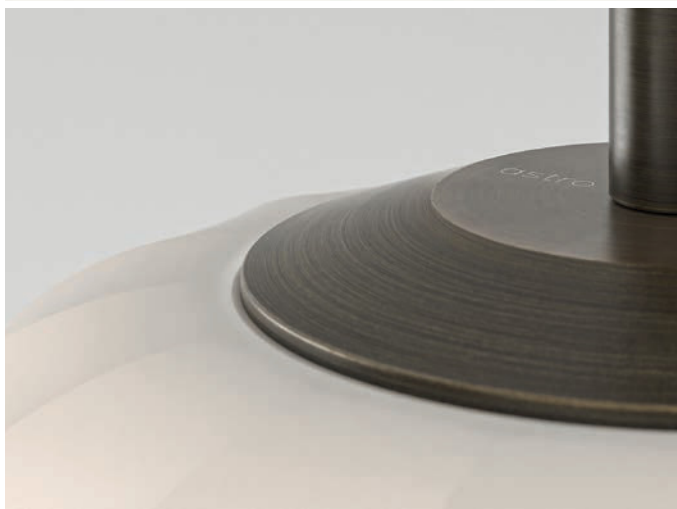
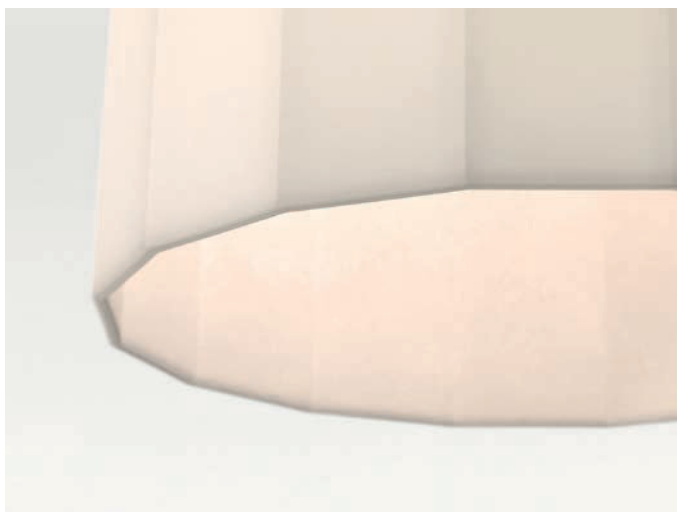

Veo Pendant

| | | LAMP | WATT | CLASS | | |
|-----|------------|------|---------|-------|---|---|
| 180 | Br 1455005 | E27* | 60W max | | ✓ | ✓ |
| 230 | Br 1455006 | E27* | 60W max | | ✓ | ✓ |

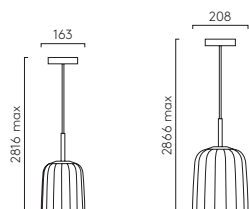

▼ Lamp excluded/La lampe exclu/Das Leuchtmittel ist ausgeschlossen/La lampadina esclusi.





PENDANT
NEW

Taiko Pendant

| | LAMP | WATT | CLASS | |
|-------------------------------------|------|---------|-------|--|
| MB 1456009 MW 1456010 | E27* | 60W max | | |

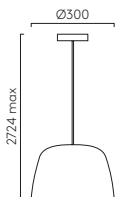

▼ Lamp excluded/La lampe exclu/Das Leuchtmittel ist ausgeschlossen/La lampadina esclusi.





Pendant Suspension Kit 3

SHADE EXCLUDED

| | MB | Br | MN | LAMP | WATT | CLASS | ☾ |
|----------------|---------|---------|----|------|---------|-------|---|
| Kit 3 | 1184009 | 1184011 | | E27* | 60W max | ⊕ | ✓ |
| Knurled | 1184010 | | | E27* | 60W max | ⊕ | ✓ |

Shade Options

Tapered 320 Pendant

WF 5013020
PF 5013022

Curve Glass 220

DS 5041001
CG 5041003

Curve Glass 285

DS 5041002
CG 5041004

* Lamp excluded / La lampe exclu / Das Leuchtmittel ist ausgeschlossen / La lampadina esclusi.



Pendant Suspension Kit 4

SHADE EXCLUDED

| | | | LAMP | WATT | CLASS | |
|----------------|-------------------------------------|-------------------------------------|------|---------|-------|---|
| Kit 4 | <input type="checkbox"/> MB 1184020 | <input type="checkbox"/> Br 1184021 | E27* | 60W max | | ✓ |
| Knurled | <input type="checkbox"/> MN 1184022 | | E27* | 60W max | | ✓ |

Shade Options

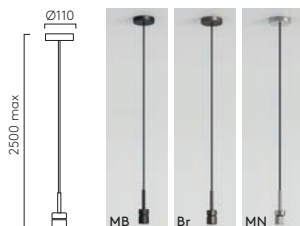
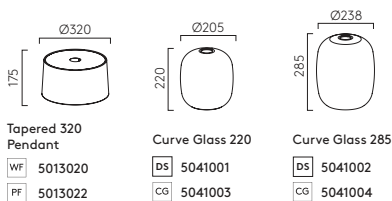

* Lamp excluded / La lampe exclu / Das Leuchtmittel ist ausgeschlossen / La lampadina esclusi.



Cambria Pendant

SHADE EXCLUDED

| | LAMP | WATT | CLASS |
|--------------------------|------|-------------|-------|
| MW 1421012 MN 1421013 | E27* | 3 x 12W max | |

Shade Options

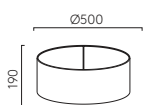

- Cambria 500**
- WF 5038001
 - PF 5038004

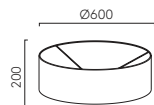

- Cambria 600**
- WF 5038002
 - PF 5038006

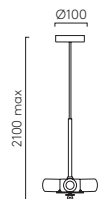

* Lamp excluded / La lampe exclu / Das Leuchtmittel ist ausgeschlossen / La lampadina esclusi.



io Pendant

| | LAMP | WATT | INPUT | K | CRI | Lm | CLASS | | | |
|------------------------|--------------|------------|----------|------|-------|-----------|-------|-------|---|---|
| PCh 1409004 MB 1409062 | Integral LED | 20.2-21.1W | 220-240V | 3000 | 80/90 | 1966-2328 | | Phase | ✓ | ✓ |

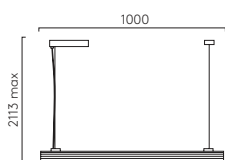



Zeppo Pendant

400 MW 1176003

| LAMP | WATT | CLASS | | |
|------|----------|-------|---|---|
| E27* | 100W max | | ✓ | ✓ |

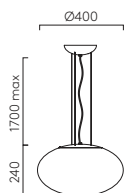

* Lamp excluded/La lampe exclu/Das Leuchtmittel ist ausgeschlossen/La lampadina esclusi.



Hashira Pendant

| | LAMP | WATT | CLASS |  |
|---|-------|--------|---|---|
| MB 1442004 MN 1442011 MG 1442012 | GU10* | 6W max |  | <input checked="" type="checkbox"/> |

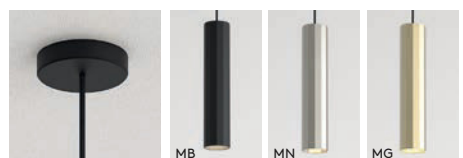

* Lamp excluded / La lampe exclu / Das Leuchtmittel ist ausgeschlossen / La lampadina esclusi.



Osca Pendant 400

| | LAMP | WATT | CLASS | |
|-----------|-------|--------|-------|--|
| P 1252014 | GU10* | 6W max | | |

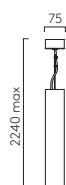

▼ Lamp excluded/La lampe exclu/Das Leuchtmittel ist ausgeschlossen/La lampadina esclusi.



Ginestra

| | | | LAMP | WATT | CLASS | |
|-----|------------|------------|------------------|---------|-------|---|
| 300 | MB 1361001 | MW 1361011 | E27 [▼] | 42W max | | ✓ |
| 400 | MB 1361002 | MW 1361012 | E27 [▼] | 72W max | | ✓ |

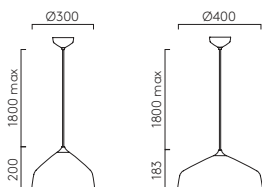

▼ Lamp excluded/La lampe exclu/Das Leuchtmittel ist ausgeschlossen/La lampadina esclusi.



Homefield Pendant

| | | | | LAMP | WATT | CLASS | | |
|-----|-------------------------------------|-------------------------------------|--|------------------|---------|--------------------------|---|---|
| 240 | <input type="checkbox"/> TB 1095010 | <input type="checkbox"/> NB 1095035 | | E27 [▼] | 12W max | <input type="checkbox"/> | ✓ | ✓ |
| 360 | <input type="checkbox"/> TB 1095015 | | | E27 [▼] | 60W max | <input type="checkbox"/> | ✓ | ✓ |
| 450 | <input type="checkbox"/> TB 1095033 | | | E27 [▼] | 12W max | <input type="checkbox"/> | ✓ | ✓ |

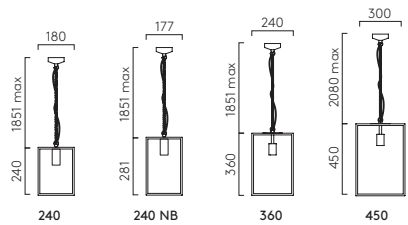

▼ Lamp excluded/La lampe exclu/Das Leuchtmittel ist ausgeschlossen/La lampadina esclusi.

Downlights

The Astro collection of fixed and adjustable downlights are available in multiple shapes, sizes, and finishes with options for use with GU10 lamps, integrated LED or LED modules and suited to a variety of interior and exterior applications, including the bathroom.

Our Downlight Selector tool is designed to streamline your decision making process and deftly reveal your perfect product.

FR La collection Astro de downlights, fixes et réglables, est disponible dans diverses formes, dimensions et finitions avec des options pour une utilisation avec des ampoules GU10, des LED intégrées ou modules LED. Elle est adaptée à de multiples applications intérieures et extérieures et notamment, dans la salle d'eau. Notre outil Sélecteur de downlight est pensé pour rationaliser votre processus de prise de décision et déterminer votre produit idéal avec dextérité.

DE Die Astro-Kollektion fester und verstellbarer Deckenstrahler ist in verschiedenen Formen, Größen und Ausführungen erhältlich. Sie können mit GU10-Lampen, integrierten LEDs oder LED-Modulen bestückt werden und eignen sich für eine Vielzahl von Anwendungen im Innen- und Außenbereich, einschließlich Badezimmer. Unser Deckenstrahler-Auswahltool wurde entwickelt, um Ihnen den Entscheidungsprozess zu vereinfachen und Ihr perfektes Produkt zu finden.

IT La collezione di faretti fissi e regolabili Astro è disponibile in diverse forme, dimensioni e finiture, con la possibilità di utilizzare lampadine GU10, LED integrati o moduli LED: essa è indicata per numerose applicazioni sia all'interno che all'esterno, compreso l'ambiente bagno. Il nostro strumento Selettore faretti nasce per snellire il processo decisionale e per indicarvi il prodotto perfetto per te.

View our Downlight Selector



Track Lighting

Track lighting is an ideal solution for illuminating commercial and residential schemes in a contemporary, flexible and efficient way.

Our online Track Configurator simplifies component selection allowing you to effortlessly create and order your desired track lighting system in just a few simple steps.

FR L'éclairage sur rail est une solution idéale pour illuminer les espaces commerciaux et résidentiels dans un esprit contemporain, souple et efficace. Notre Configurateur de rail en ligne simplifie la sélection des éléments : vous créez et commandez ainsi facilement le système d'éclairage sur rail de votre choix en seulement quelques étapes simples.

DE Extremen Orten Lichtschienensysteme sind eine gute Wahl für eine moderne, flexible und effiziente Beleuchtung von Geschäfts- und Wohnräumen. Unser Online-Lichtschienenkongfigurator vereinfacht die Auswahl der Komponenten und ermöglicht es Ihnen, Ihr gewünschtes Lichtschienensystem in wenigen einfachen Schritten zu erstellen und zu bestellen.

IT L'illuminazione a binario è una soluzione ideale per illuminare ambienti commerciali e residenziali in modo moderno, versatile ed efficiente. Il nostro Configuratore per sistema a binario online semplifica la scelta dei componenti, permettendoti così di creare e ordinare senza fatica il sistema a binario che preferisci con pochi e semplici passi.

Launch Track Configurator Tool





Round Slimline Adjustable Fire-Rated



Pinhole

| | | LAMP | WATT | CLASS | Recess depth | | | |
|--|----------|-------|------------|---------|--------------|---|---|---|
| Round Slimline Fixed Fire-rated IP65 | 1434001* | GU10* | 6W max | Ø70 | 150 | ✓ | ✓ | ✓ |
| Round Slimline Adjustable Fire-rated | 1434003* | GU10* | 6W max | Ø83 | 150 | ✓ | ✓ | ✓ |
| Round Slimline Flush Fixed Fire-rated IP65 | 1434007* | GU10* | 6W max | Ø62 | 150 | ✓ | ✓ | ✓ |
| Round Slimline Flush Adjustable Fire-rated | 1434008* | GU10* | 6W max | Ø79 | 150 | ✓ | ✓ | ✓ |
| Square Slimline Square Fixed Fire-rated IP65 | 1434002* | GU10* | 6W max | Ø70 | 150 | ✓ | ✓ | ✓ |
| Square Slimline Square Adjustable Fire-rated | 1434004* | GU10* | 6W max | Ø83 | 150 | ✓ | ✓ | ✓ |
| Square Square Twin Adjustable | 1434005 | GU10* | 2 x 6W max | 2 x Ø83 | 150 | ✓ | - | ✓ |

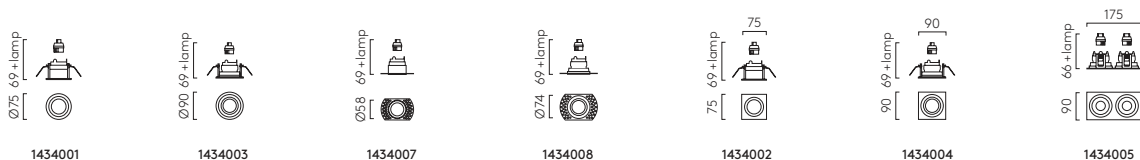

♠ Please see our website for more information about our fire rated products.

▼ Lamp excluded/La lampe exclu/Das Leuchtmittel ist ausgeschlossen/La lampadina esclusi.



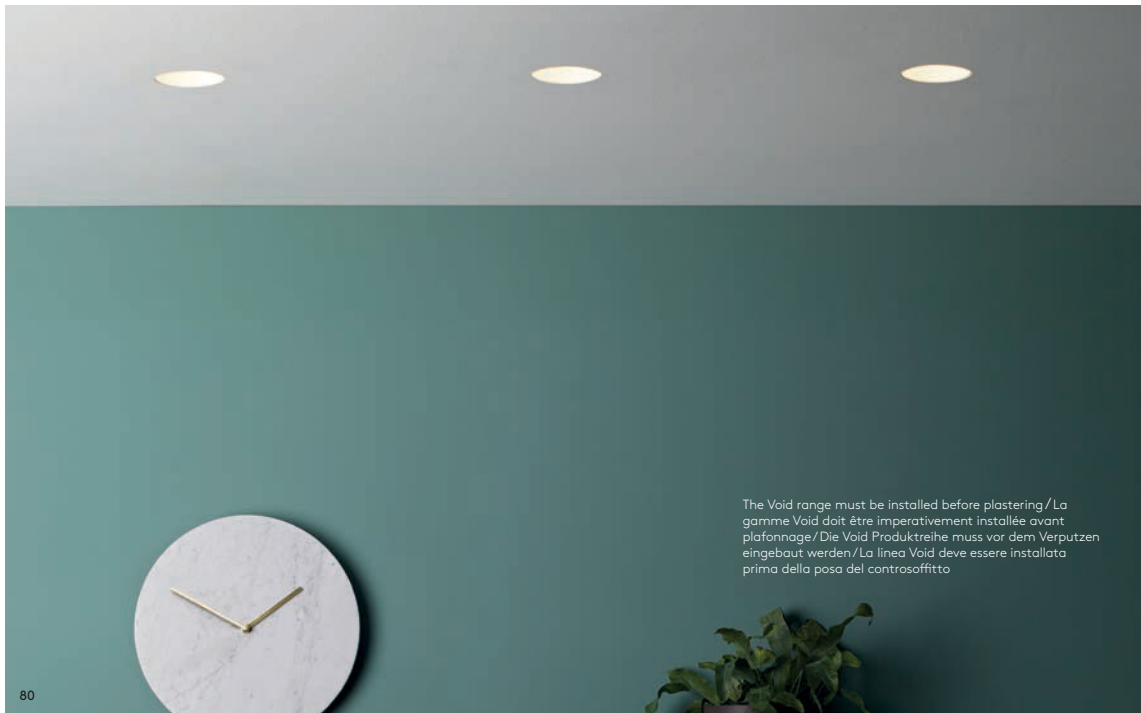

* Slimline downlights are compatible with our range of LED Modules which allow higher output and more specification options than GU10 lamps./Les downlights Slimline sont compatibles avec notre gamme de modules LED, ce qui offre un rendement supérieur et beaucoup plus d'options que les ampoules GU10./Slimline-Downlights sind mit unserem Angebot an LED-Modulen kompatibel, die eine höhere Leistung und mehr Spezifikationsmöglichkeiten als GU10-Lampen bieten./I faretti Slimline sono compatibili con la nostra gamma di Moduli LED che permettono una maggiore luminosità e più specifiche di progetto rispetto alle lampade GU10. See p.404

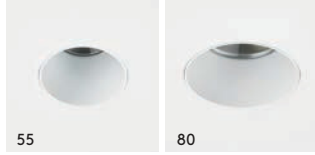

The Void range must be installed before plastering / La gamme Void doit être impérativement installée avant plafonnage / Die Void Produktreihe muss vor dem Verputzen eingebaut werden / La linea Void deve essere installata prima della posa del controsoffitto



Void

| | | LAMP | WATT | CLASS |  Recess depth |  |  |
|----|---|-------|--------|---|--|---|---|
| 55 |  1392017 | GU10▼ | 6W max |  | Ø70 163 | ✓ | ✓ |
| 80 |  1392019 | GU10▼ | 6W max |  | Ø98 163 | ✓ | ✓ |

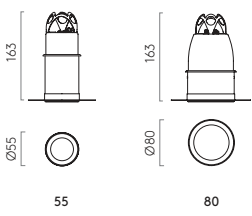

⚡ Please see our website for more information about our fire rated products.
 ▼ Lamp excluded / La lampe exclu / Das Leuchtmittel ist ausgeschlossen / La lampadina esclusi.

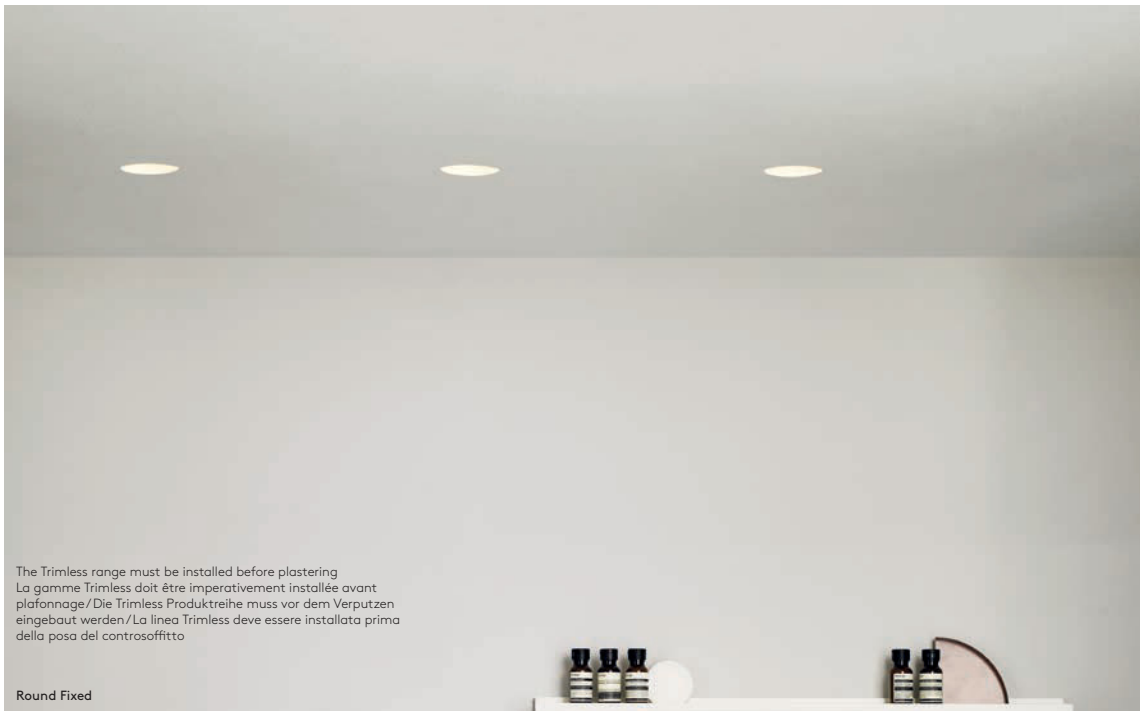

The Trimless range must be installed before plastering
 La gamme Trimless doit être impérativement installée avant
 plafonnage/Die Trimless Produktreihe muss vor dem Verputzen
 eingebaut werden/La linea Trimless deve essere installata prima
 della posa del controsoffitto

Round Fixed



Trimless Round

| | Lamp | Watt | Input | K | CRI | Lm | IP | Class | Recess depth | Fire rated | adj. | | | |
|---------------------|----------|--------------|------------|------------|------|----|-----|-------|--------------|------------|------|---|---|---|
| Adjustable | 1248024 | GU10 ▼ | 6W max | Mains 230V | - | - | 20 | | Ø79 | 150 | ✓ | - | ✓ | |
| Fixed | 1248023 | GU10 ▼ | 6W max | Mains 230V | - | - | 20 | | Ø79 | 150 | ✓ | - | - | |
| Adjustable LED | 1248010 | Integral LED | 10.2W | CC 700mA ▼ | 2700 | 80 | 528 | 20 | | Ø79 | 150 | ✓ | - | ✓ |
| Twin Adjustable | 1248021 | GU10 ▼ | 2 x 6W max | Mains 230V | - | - | 20 | | Ø79 | 150 | ✓ | - | ✓ | |
| Slimline Adjustable | 1248019* | GU10 ▼ | 6W max | Mains 230V | - | - | 20 | | Ø79 | 150 | ✓ | ✓ | ✓ | |
| Slimline Fixed | 1248017* | GU10 ▼ | 6W max | Mains 230V | - | - | 65 | | Ø79 | 150 | ✓ | ✓ | - | |
| Mini | 1248025 | GU10 ▼ | 4W max | Mains 230V | - | - | 65 | | Ø54 | 114 | ✓ | - | - | |

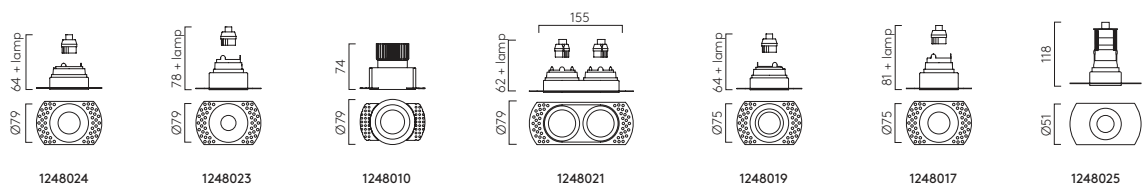

♦ Please see our website for more information about our fire rated products.

▼ Lamp or driver excluded/Lampe ou pilote exclus/Lampe oder Treiber ausgeschlossen/Lampada o driver esclusi.

* Slimline downlights are compatible with our range of LED Modules which allow higher output and more specification options than GU10 lamps./Les downlights Slimline sont compatibles avec notre gamme de modules LED, ce qui offre un rendement supérieur et beaucoup plus d'options que les ampoules GU10./Slimline-Downlights sind mit unserem Angebot an LED-Modulen kompatibel, die eine höhere Leistung und mehr Spezifikationsmöglichkeiten als GU10-Lampen bieten./I faretti Slimline sono compatibili con la nostra gamma di Moduli LED che permettono una maggiore luminosità e più specifiche di progetto rispetto alle lampade GU10. See p.404

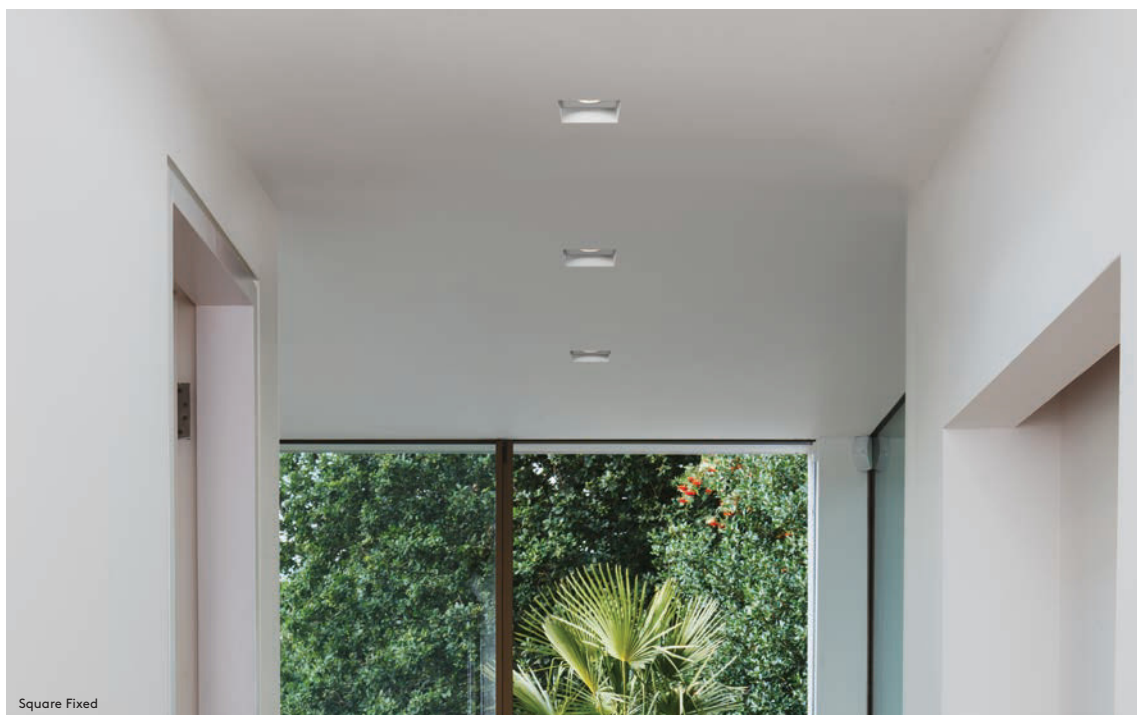

Square Fixed



Trimless Square

| | | Lamp | Watt | IP | Class | | Recess depth | | adj ¹ |
|------------------|---------|--------|------------|----|-------|--------|--------------|---|------------------|
| Adjustable | 1248020 | GU10 ▼ | 6W max | 20 | | 79x79 | 150 | ✓ | ✓ |
| Fixed | 1248018 | GU10 ▼ | 6W max | 20 | | 79x79 | 150 | ✓ | - |
| Twin Adjustable | 1248022 | GU10 ▼ | 2 x 6W max | 20 | | 162x79 | 150 | ✓ | ✓ |
| Fixed Fire-rated | 1248005 | GU10 ▼ | 6W max | 65 | | 95x95 | 150 | ✓ | - |

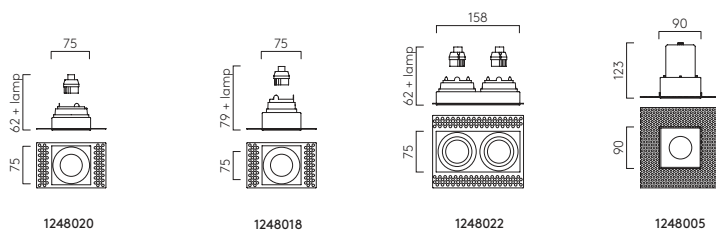

◆ Please see our website for more information about our fire rated products.
 ▼ Lamp excluded/La lampe exclu/Das Leuchtmittel ist ausgeschlossen/La lampadina esclusi.



Blanco

| | | | LAMP | WATT | CLASS | | Recess depth | |
|-------------------|----------------------------|---------|-------|------------|-------|---------|--------------|---|
| Round Fixed | <input type="checkbox"/> P | 1253004 | GU10* | 6W max | | Ø133 | 150 | ✓ |
| Square Fixed | <input type="checkbox"/> P | 1253002 | GU10* | 6W max | | 120x120 | 150 | ✓ |
| Round Adjustable | <input type="checkbox"/> P | 1253005 | GU10* | 6W max | | Ø152 | 150 | ✓ |
| Square Adjustable | <input type="checkbox"/> P | 1253007 | GU10* | 6W max | | 150x150 | 150 | ✓ |
| Twin Adjustable | <input type="checkbox"/> P | 1253006 | GU10* | 2 x 6W max | | 230x150 | 150 | ✓ |

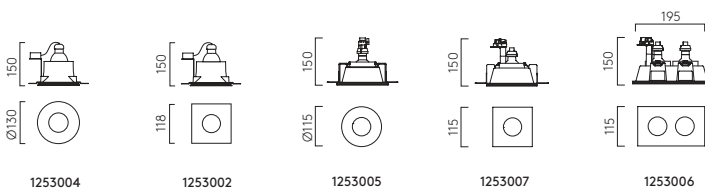

The Blanco range is ideally installed after plastering, requiring only minimal filling after installation. La gamme Blanco est idéalement installée après le plafonnage et requiert un minimum de finition. / Die Blanco Produktpalette sollte idealerweise nach dem Verputzen eingebaut werden, da sie nach der Installation nur eine minimale Auffüllung erfordern. / La linea Blanco può essere installata dopo la posa del controsoffitto, richiede solo una stuccatura finale.

* Lamp excluded / La lampe exclu / Das Leuchtmittel ist ausgeschlossen / La lampadina esclusi.



Taro

| | | LAMP | WATT | CLASS | | Recess depth | |
|------------------------|---------|-------|-------------|-------|--------|--------------|---|
| Round Fixed | 1240024 | GU10▼ | 50W max | | Ø86 | 172 | ✓ |
| Round Adjustable | 1240028 | GU10▼ | 50W max | | Ø86 | 167 | ✓ |
| Square Fixed | 1240026 | GU10▼ | 50W max | | Ø86 | 172 | ✓ |
| Square Adjustable | 1240030 | GU10▼ | 50W max | | Ø86 | 167 | ✓ |
| Square Twin Adjustable | 1240032 | GU10▼ | 2 x 50W max | | 184x89 | 146 | ✓ |

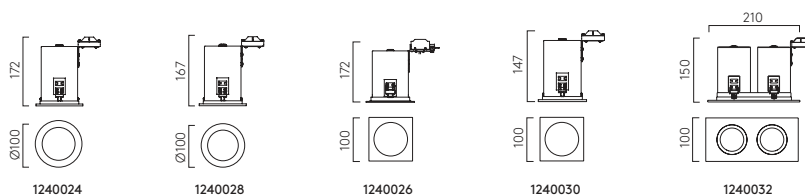

⚡ Please see our website for more information about our fire rated products.
 ▼ Lamp excluded/La lampe exclu/Das Leuchtmittel ist ausgeschlossen/La lampadina esclusi.

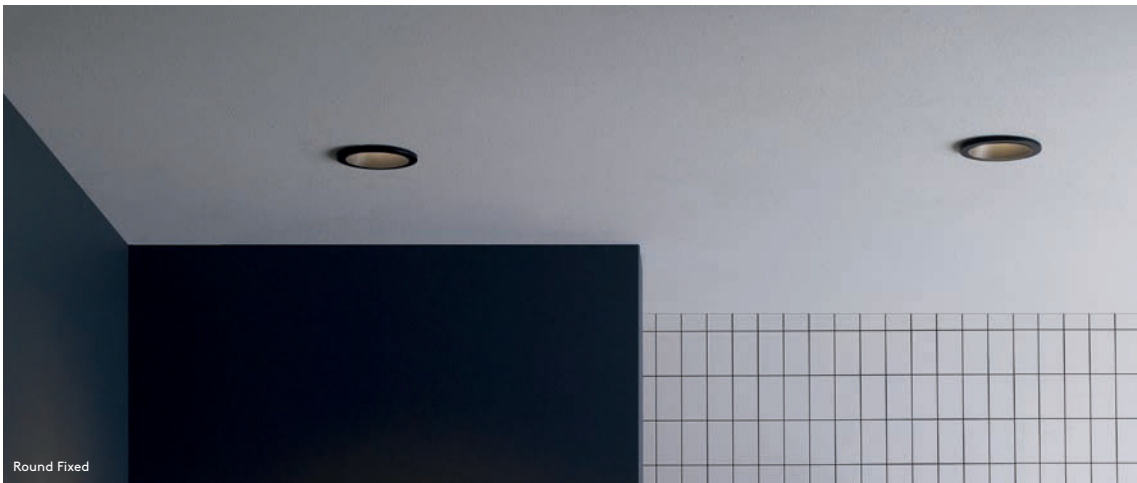

Minima Round

| | | | LAMP | WATT | INPUT | K | CRI | Lm | CLASS | | Recess depth | | | |
|--------------------------------|--|----------|--------------|----------|-----------------------------|------------|-----|-----|-------|-----|--------------|---------|---|---|
| Fixed LED | | 1249005 | Integral LED | 10.7W | 700mA [▼] | 2700 | 80 | 434 | | Ø76 | 150 | ✓ | - | ✓ |
| Fixed Fire-rated IP65 LED | | 1249023 | Integral LED | 8W max | 220-240V | 2700 | 90 | 665 | | Ø86 | 150 | Phase + | - | ✓ |
| Fixed | | 1249002 | | 1249015 | GU10 [▼] | 50W max | - | - | - | | Ø76 | 150 | ✓ | - |
| Fixed IP65 | | 1249012 | | 1249017 | GU10 [▼] | 50W max | - | - | - | | Ø76 | 150 | ✓ | - |
| Slimline Fixed Fire-rated IP65 | | 1249034* | | 1249035* | GU10 [▼] | 6W max | - | - | - | | Ø86 | 150 | ✓ | ✓ |
| Adjustable | | 1249003 | | 1249016 | GU10 [▼] | 50W max | - | - | - | | Ø76 | 150 | ✓ | - |
| Slimline Adjustable Fire-rated | | 1249040* | | 1249041* | GU10 [▼] | 6W max | - | - | - | | Ø86 | 150 | ✓ | ✓ |
| Slimline 25° Fire-rated IP65 | | 1249036* | | 1249037* | GU10 [▼] | 4W max | - | - | - | | Ø86 | 150 | ✓ | ✓ |
| Mini | | 1249052 | | 1249054 | 35mm MR11 GU10 [▼] | 4W max | - | - | - | | Ø62 | 117 | ✓ | - |
| Twin Adjustable | | 1249028 | | 1249029 | GU10 [▼] | 2 x 6W max | - | - | - | | 92x95 | 150 | ✓ | - |

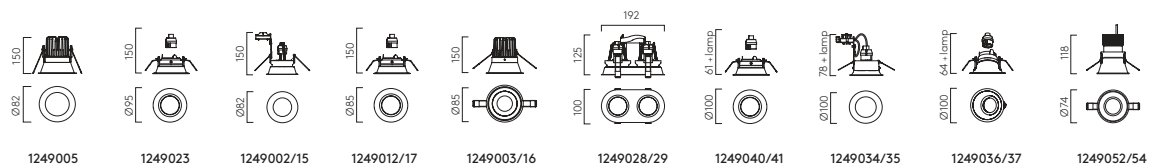

♣ Please see our website for more information about our fire rated products.

▼ Lamp or driver excluded/Lampe ou pilote exclus/Lampe oder Treiber ausgeschlossen/Lampada o driver esclusi.

* Slimline downlights are compatible with our range of LED Modules which allow higher output and more specification options than GU10 lamps./ Les downlights Slimline sont compatibles avec notre gamme de modules LED, ce qui offre un rendement supérieur et beaucoup plus d'options que les ampoules GU10./ Slimline-Downlights sind mit unserem Angebot an LED-Modulen kompatibel, die eine höhere Leistung und mehr Spezifikationsmöglichkeiten als GU10-Lampen bieten./ I faretti Slimline sono compatibili con la nostra gamma di Moduli LED che permettono una maggiore luminosità e più specifiche di progetto rispetto alle lampade GU10. See p.404

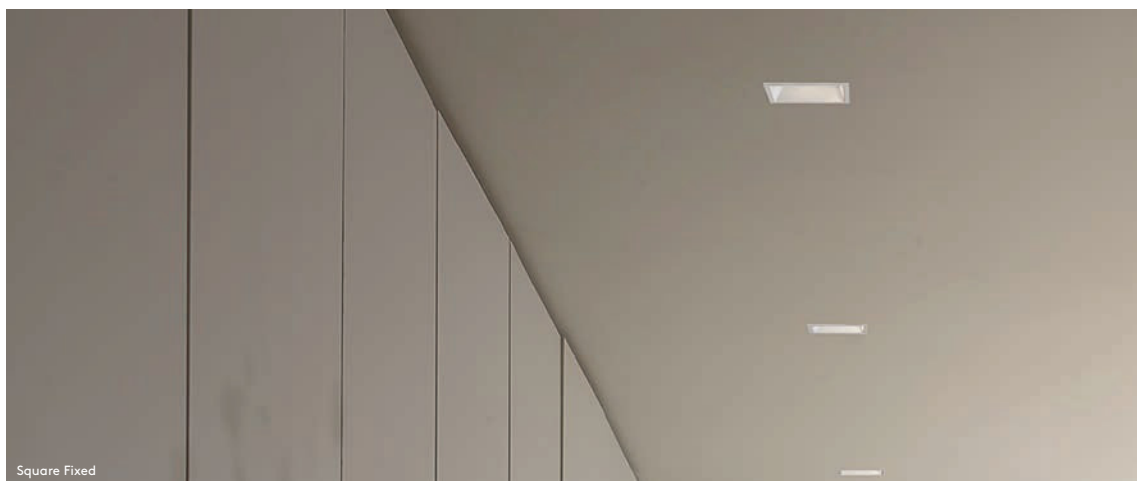

Square Fixed



Minima Square

| | | | | LAMP | WATT | CLASS | | Recess depth | | | |
|---------------------------------------|--|----------|--|-------------------|-------------------|--------|--|--------------|-----|---|---|
| Fixed IP65 | | 1249018 | | GU10 [▼] | 50W max | | | Ø76 | 150 | ✓ | - |
| Slimline Fixed Fire-rated IP65 | | 1249038* | | 1249039* | GU10 [▼] | 6W max | | 86x86 | 150 | ✓ | ✓ |
| Slimline Adjustable Fire-rated | | 1249042* | | 1249043* | GU10 [▼] | 6W max | | 86x86 | 150 | ✓ | ✓ |

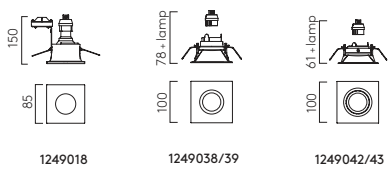

◆ Please see our website for more information about our fire rated products.
 ▼ Lamp excluded/La lampe exclu/Das Leuchtmittel ist ausgeschlossen/La lampadina esclusi.
 * Slimline downlights are compatible with our range of LED Modules which allow higher output and more specification options than GU10 lamps./Les downlights Slimline sont compatibles avec notre gamme de modules LED, ce qui offre un rendement supérieur et beaucoup plus d'options que les ampoules GU10./Slimline-Downlights sind mit unserem Angebot an LED-Modulen kompatibel, die eine höhere Leistung und mehr Spezifikationsmöglichkeiten als GU10-Lampen bieten./I faretto Slimline sono compatibili con la nostra gamma di Moduli LED che permettono una maggiore luminosità e più specifiche di progetto rispetto alle lampade GU10. See p.404



Ottawa

| | LAMP | WATT | CLASS | |
|------------|-------|--------|-------|---|
| MW 1474002 | GU10▼ | 6W max | ⊕ | ✓ |
| MB 1474001 | | | | |



▼ Lamp excluded / La lampe exclu / Das Leuchtmittel ist ausgeschlossen / La lampadina esclusi.



Round 85 Matt White



Kos

| | | | | LAMP | WATT | INPUT | K | CRI | Lm | CLASS | | |
|----------------------|----|---------|-----|--------------|--------|----------|------|-----|-----|-------|-------|---|
| Round 85 | MW | 1326039 | TB | GU10▼ | 6W max | - | - | - | - | | ✓ | - |
| | TG | 1326041 | PCh | | | | | | | | | |
| Round 100 LED | TW | 1326061 | TB | Integral LED | 6.2W | 210-250V | 3000 | 80 | 316 | | Phase | ✓ |
| Round 140 LED | TW | 1326067 | TB | Integral LED | 12.8W | 220-240V | 3000 | 80 | 761 | | Phase | ✓ |
| Square 85 | MW | 1326043 | TB | GU10▼ | 6W max | - | - | - | - | | ✓ | - |

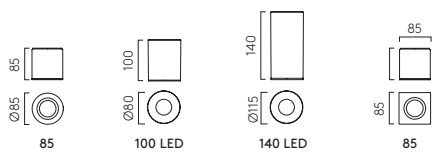

▼ Lamp excluded / La lampe exclu / Das Leuchtmittel ist ausgeschlossen / La lampadina esclusi.



Shadow Surface

| | LAMP | WATT | CLASS | |
|-----|-----------|-------|--------|-----|
| 150 | P 1414003 | GU10▼ | 6W max | ⊕ ✓ |

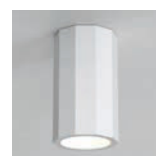

▼ Lamp excluded / La lampe exclu / Das Leuchtmittel ist ausgeschlossen / La lampadina esclusi.



Osca

| | | LAMP | WATT | CLASS | |
|----------------|------------------------------------|-------|---------|-------|---|
| 140 Fixed | <input type="checkbox"/> P 1252003 | GU10▼ | 6W max | | ✓ |
| 140 Adjustable | <input type="checkbox"/> P 1252006 | GU10▼ | 6W max | | ✓ |
| 200 Fixed | <input type="checkbox"/> P 1252011 | E27▼ | 12W max | | ✓ |

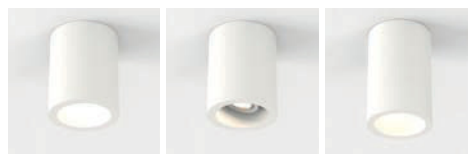
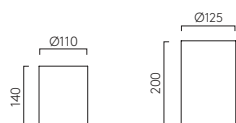

▼ Lamp excluded/La lampe exclu/Das Leuchtmittel ist ausgeschlossen/La lampadina esclusi.



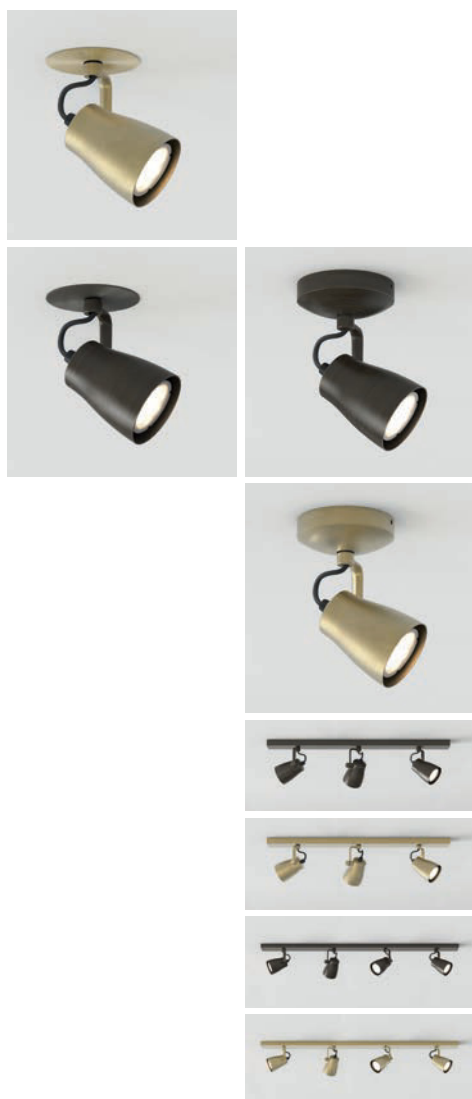

Juno

| | Br | MBB | LAMP | WATT | CLASS | | |
|-------------------|---------|---------|--------|-------------|-------|---|---|
| Recessed | 1487001 | 1487005 | | | | | |
| Single | 1487002 | 1487006 | GU10 ▼ | 35W max | | ✓ | ✓ |
| Triple Bar | 1487003 | 1487007 | GU10 ▼ | 3 x 35W max | | ✓ | ✓ |
| Four Bar | 1487004 | 1487008 | GU10 ▼ | 4 x 35W max | | ✓ | ✓ |

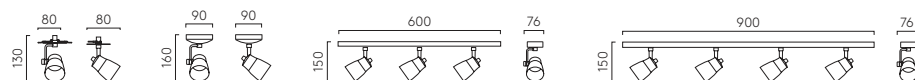

▼ Lamp excluded/La lampe exclu/Das Leuchtmittel ist ausgeschlossen/La lampadina esclusi.



Lynx

Includes removable glare guard

| | LAMP | WATT | INPUT | K | CRI | Lm | CLASS | | |
|---------------|-----------------------|--------------|-------|------------|------|----|-----------|--|---|
| Recess | MW 1403007 MB 1403006 | Integral LED | 12.1W | Mains 230V | 3000 | 80 | 741 - 810 | | ✓ |
| Recess | MW 1403009 | Integral LED | 12.1W | Mains 230V | 3000 | 80 | 741 - 810 | | ✓ |

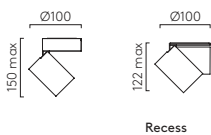



50 Recessed Matt Black

Can

Includes removable glare guard

| | | | LAMP | WATT | INPUT | K | CRI | Lm | CLASS | | |
|--------------------|---------|---------|--------------|------|----------|------|-----|---------|-------|-------|---|
| 50 Single | 1396024 | 1396025 | Integral LED | 8.2W | 220-240V | 3000 | 90 | 509-544 | | Phase | ✓ |
| 50 Recessed | 1396028 | 1396029 | Integral LED | 8.2W | 220-240V | 3000 | 90 | 509-544 | | Phase | ✓ |

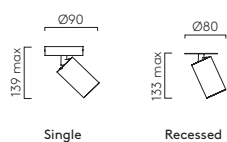

Can 50 Bezel
6020008



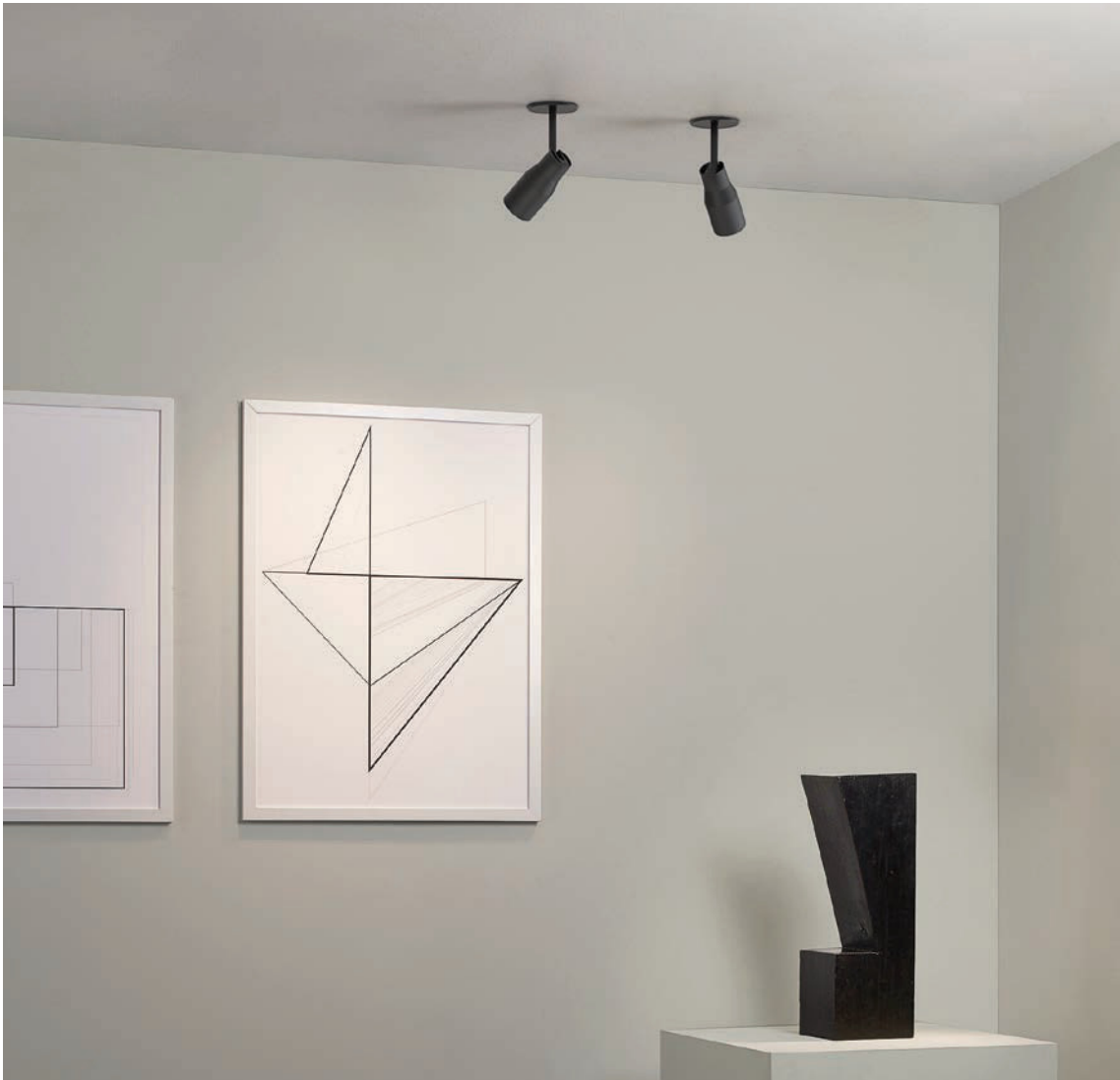

Apollo

| | | | Lamp | Watt | Class | | |
|--------------|---------|---------|------------|--------|-------|---|---|
| Single | 1422001 | 1422002 | LED GU10 ▼ | 6W max | | ✓ | ✓ |
| 100 Recessed | 1422016 | 1422017 | LED GU10 ▼ | 6W max | | ✓ | ✓ |

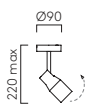

Single

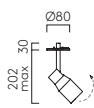

100 Recessed



▼ Lamp excluded / La lampe exclu / Das Leuchtmittel ist ausgeschlossen / La lampadina esclusi.



Koto

| | | | | Lamp | Watt | Class | | | (adj)* |
|-----------------|-------------------------------------|-------------------------------------|--|--------|------------|-------|---|---|--------|
| Single | <input type="checkbox"/> MW 1478009 | <input type="checkbox"/> MB 1478001 | | GU10 ▼ | 6W max | | ✓ | - | ✓ |
| Single Switched | <input type="checkbox"/> MW 1478010 | <input type="checkbox"/> MB 1478002 | | GU10 ▼ | 6W max | | - | ✓ | ✓ |
| Recessed | <input type="checkbox"/> MW 1478011 | <input type="checkbox"/> MB 1478003 | | GU10 ▼ | 6W max | | ✓ | - | ✓ |
| Triple Round | <input type="checkbox"/> MW 1478013 | <input type="checkbox"/> MB 1478005 | | GU10 ▼ | 3 x 6W max | | ✓ | - | ✓ |
| Triple Bar | <input type="checkbox"/> MW 1478014 | <input type="checkbox"/> MB 1478006 | | GU10 ▼ | 3 x 6W max | | ✓ | - | ✓ |
| Four Bar | <input type="checkbox"/> MW 1478015 | <input type="checkbox"/> MB 1478007 | | GU10 ▼ | 4 x 6W max | | ✓ | - | ✓ |
| Five Bar | <input type="checkbox"/> MW 1478016 | <input type="checkbox"/> MB 1478008 | | GU10 ▼ | 5 x 6W max | | ✓ | - | ✓ |

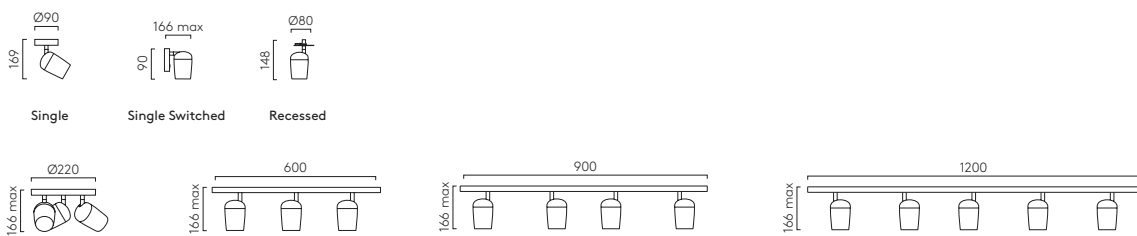

▼ Lamp excluded/La lampe exclu/Das Leuchtmittel ist ausgeschlossen/La lampadina esclusi.



Single Switched



Single

Single Switched

Recessed

Flush

Twin

Twin recessed

Ascoli

| | | | | | LAMP | WATT | CLASS | | | |
|------------------|---------|---------|---------|---------|-------------------|-------------|-------|-------------------------------------|-------------------------------------|-------------------------------------|
| Single | 1286001 | 1286004 | 1286015 | 1286078 | GU10 [†] | 50W max | | - | <input checked="" type="checkbox"/> | - |
| Single Switched | 1286010 | 1286009 | 1286011 | 1286079 | GU10 [†] | 6W max | | - | - | <input checked="" type="checkbox"/> |
| Recessed | 1286021 | 1286022 | 1286023 | 1286080 | GU10 [†] | 50W max | | - | <input checked="" type="checkbox"/> | - |
| Flush Fire-rated | 1286095 | 1286096 | | | GU10 [†] | 6W max | | <input checked="" type="checkbox"/> | <input checked="" type="checkbox"/> | - |
| Twin | 1286123 | 1286126 | 1286125 | 1286124 | GU10 [†] | 2 x 50W max | | - | <input checked="" type="checkbox"/> | - |
| Twin Recessed | 1286097 | 1286098 | 1286099 | 1286100 | GU10 [†] | 2 x 50W max | | - | <input checked="" type="checkbox"/> | - |



Single



Single Switched



Recessed



Flush Fire-rated

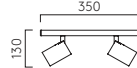

Twin

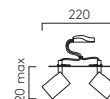

Twin Recessed

[†] Please see our website for more information about our fire rated products.
[‡] Lamp excluded / La lampe exclu / Das Leuchtmittel ist ausgeschlossen / La lampadina esclusi.

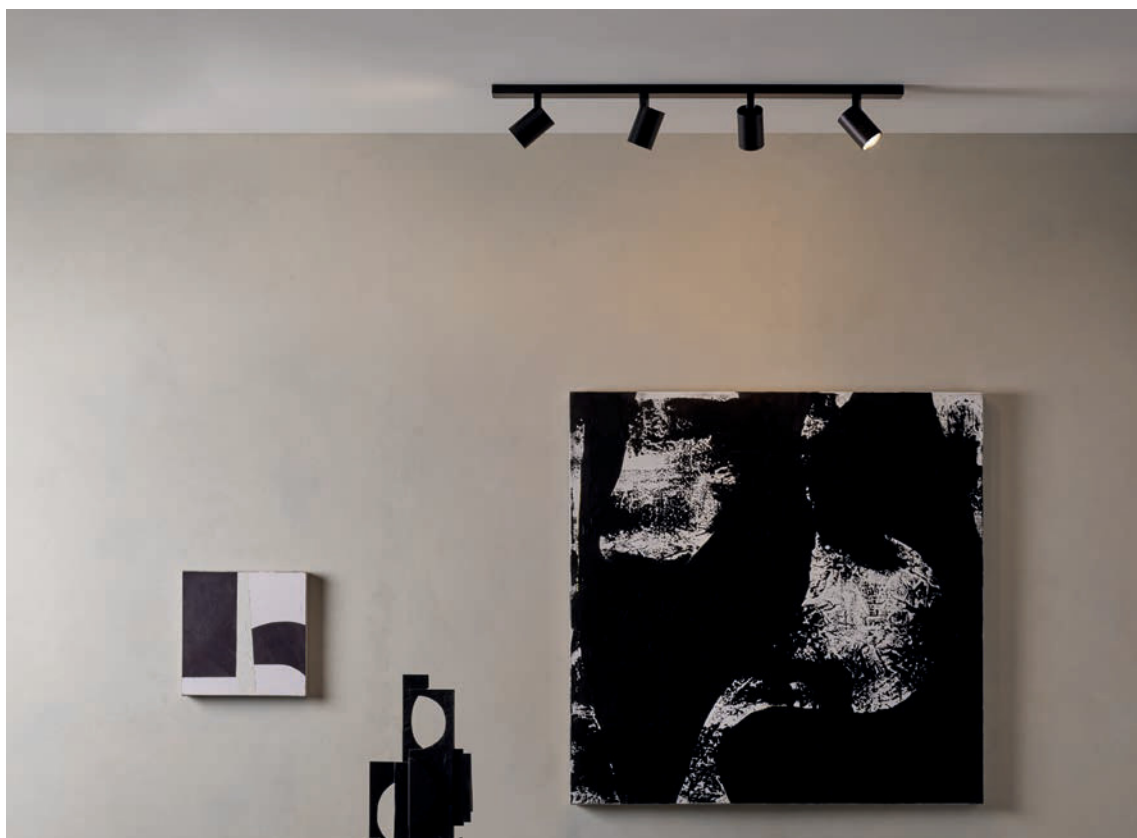

ASCOLI CONTINUED

| | | | | | | LAMP | WATT | CLASS | | | |
|--------------|---------|---------|---------|---------|--|-------|-------------|-------|---|---|---|
| Triple Round | 1286002 | 1286005 | 1286012 | 1286082 | | GU10▼ | 3 x 50W max | | - | ✓ | - |
| Triple Bar | 1286127 | 1286130 | 1286129 | 1286128 | | GU10▼ | 3 x 50W max | | - | ✓ | - |
| Four Bar | 1286131 | 1286134 | 1286133 | 1286084 | | GU10▼ | 4 x 50W max | | - | ✓ | - |
| Five Bar | 1286059 | 1286060 | 1286061 | 1286085 | | GU10▼ | 5 x 50W max | | - | ✓ | - |

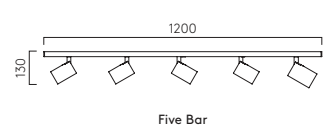
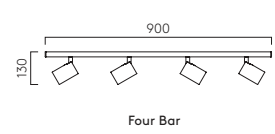
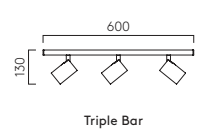
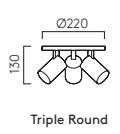

▼ Lamp excluded/La lampe exclu/Das Leuchtmittel ist ausgeschlossen/La lampadina esclusi.



Track Spotlights + Pendants

| | | | | LAMP | WATT | INPUT | K | CRI | Lm | CLASS | | |
|---------------------|---------|---------|---------|-------------------|---------|----------|------|-----|-------------|-------|-------|---|
| Apollo 100 | 1422022 | 1422023 | | GU10 [▼] | 6W max | - | - | - | - | | ✓ | - |
| Ascoli | 1286033 | 1286052 | 1286149 | GU10 [▼] | 50W max | - | - | - | - | | ✓ | - |
| Koto | 1478012 | 1478004 | | GU10 [▼] | 6W max | - | - | - | - | | ✓ | - |
| Can 50 | 1396026 | 1396027 | | Integral LED | 8.2W | 220-240V | 3000 | 90 | 509 - 544 | | Phase | ✓ |
| Can 75 | 1396030 | 1396031 | | Integral LED | 14.7W | 220-240V | 3000 | 90 | 892 - 945 | | Phase | ✓ |
| Can 100 | 1396034 | 1396035 | | Integral LED | 28.5W | 220-240V | 3000 | 90 | 2048 - 2350 | | Phase | ✓ |
| Pendant Kit* | 1184014 | 1184015 | | E27 [▼] | 12W | - | - | - | - | | ✓ | - |



Apollo 100



Ascoli



Koto



Can 50



Can 75

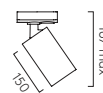

Can 100

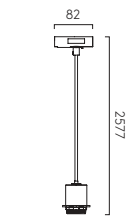

Pendant Suspension Kit

▼ Lamp excluded / La lampe exclu / Das Leuchtmittel ist ausgeschlossen / La lampadina esclusi.

* Shade excluded / Shade exclu / Lichtschirm ausgeschlossen / Paralume escluso



Ascoli Track - Matt Gold

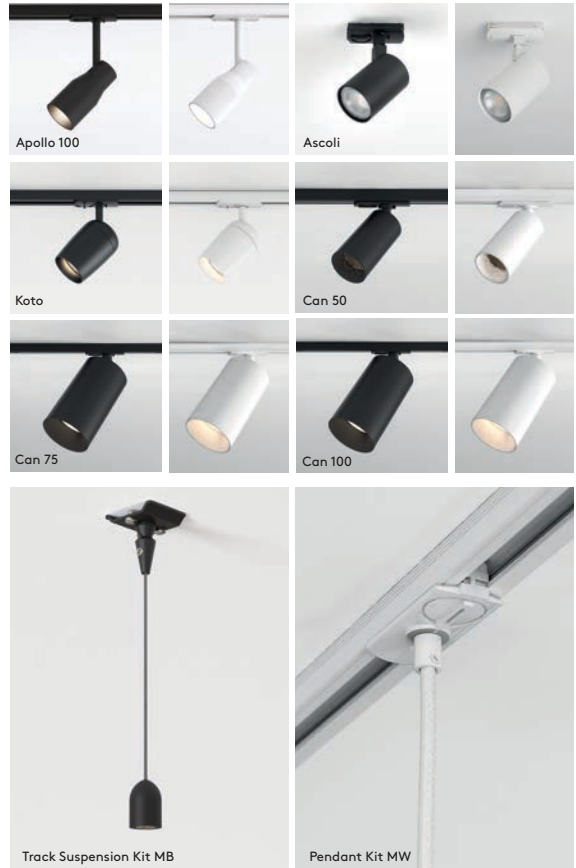

Track Accessories

| | | |
|----------------------------------|-------------------------------------|-------------------------------------|
| 1m track | <input type="checkbox"/> MW 6020001 | <input type="checkbox"/> MB 6020009 |
| 2 x 1m track | <input type="checkbox"/> MW 6020040 | <input type="checkbox"/> MB 6020041 |
| 2m track | <input type="checkbox"/> MW 6020002 | <input type="checkbox"/> MB 6020010 |
| End cap | <input type="checkbox"/> MW 6020003 | <input type="checkbox"/> MB 6020011 |
| End to End Connector | <input type="checkbox"/> MW 6020004 | <input type="checkbox"/> MB 6020012 |
| Live End | <input type="checkbox"/> MW 6020005 | <input type="checkbox"/> MB 6020013 |
| Left Corner Connector | <input type="checkbox"/> MW 6020006 | <input type="checkbox"/> MB 6020014 |
| Right Corner Connector | <input type="checkbox"/> MW 6020007 | <input type="checkbox"/> MB 6020015 |
| X Connector | <input type="checkbox"/> MW 6020019 | <input type="checkbox"/> MB 6020020 |
| Central Live Connector | <input type="checkbox"/> MW 6020017 | <input type="checkbox"/> MB 6020018 |
| T Connector Left Farside Earth | <input type="checkbox"/> MW 6020027 | <input type="checkbox"/> MB 6020028 |
| T Connector Left Nearside Earth | <input type="checkbox"/> MW 6020025 | <input type="checkbox"/> MB 6020026 |
| T Connector Right Farside Earth | <input type="checkbox"/> MW 6020023 | <input type="checkbox"/> MB 6020024 |
| T Connector Right Nearside Earth | <input type="checkbox"/> MW 6020021 | <input type="checkbox"/> MB 6020022 |

| | | |
|--------------------------------|-------------------------------------|-------------------------------------|
| Suspension Central Live Supply | <input type="checkbox"/> MW 6020030 | <input type="checkbox"/> MB 6020031 |
| Connector Live End Supply | <input type="checkbox"/> MW 6020032 | <input type="checkbox"/> MB 6020033 |
| Pendant Connector | <input type="checkbox"/> MW 6020038 | <input type="checkbox"/> MB 6020039 |
| Track Suspension Kit | <input type="checkbox"/> MW 6020042 | <input type="checkbox"/> MB 6020043 |
| Corner Support | - 6020036 | |
| Straight Support | - 6020035 | |
| T Support | - 6020037 | |
| X Support | - 6020034 | |

Bezels

for use with can track spots only



Can 50 6020008 Can 75 6020016 Can 100 6020029
Includes removable glare guard

Please visit the tools section of our website to use the track configurator / Veuillez consulter la section outils de notre site Web pour utiliser le configurateur de rail. / Visitate la sezione accessori del nostro sito per accedere al Configuratore di binary. / Bitte besuchen Sie den Tools-Bereich unserer Website, um den Track-Konfigurator zu verwenden.



Exterior Lighting

Exterior Lighting



Homefield Wall
P. 324



Messina
P. 325



Salerno
P. 326



Harvard Wall
P. 327



Box Lantern
P. 328



Coach
P. 329



Farrington
P. 330



Calvi Wall
P. 331



Richmond Lantern
P. 332



Richmond Wall
P. 333



Harvard Lantern
P. 334



Pimlico
P. 335



Montparnasse
Wall
P. 336



Cabin Wall
P. 337



Portree Wall
P. 338



Tressino
P. 339



Thurso Round
P. 340



Thurso Oval
P. 340



Kea Round
P. 341



Ava
P. 342



Montreal Oval
P. 343



Montreal Round
P. 343



Chios
P. 344



Oslo
P. 345



Dunbar
P. 346



Elis
P. 347



Mast Light
P. 348



Mast Light Twin
P. 348



Dartmouth
P. 349



NEW
Dartmouth Spot
Single
P. 350



NEW
Dartmouth Spot
Twin
P. 350



Bayville Spot Single
P. 352



Bayville Spot Twin
P. 352



Jura Single Spot
P. 353



Jura
P. 354



Mori
P. 355



Incline
P. 356



Tango
P. 357



Tivola
P. 358



Beam
P. 359



Gramos Round
P. 360



Gramos Square
P.360



Terra
P. 361



Bayville Spike Spot
P. 362



Myos
P. 363



NEW
Dartmouth Spike
Spot
P. 364



Jura Spike Spot
P. 366



Soprano Wall
P. 367



Soprano Bollard
P. 368



Homefield
Pedestal
P. 369



Kuro
P. 370



Nomad
P. 371



Harvard Pendant
P. 372



Montparnasse
Pendant
P. 373



Calvi Pendant
P. 374



Homefield Pendant
P. 375



Homefield Ceiling
P. 376



Bronte
P. 377



Jura Surface
P. 378



Kos Round
P. 379



Kos Square
P. 379



NEW
Kos Recessed
P. 380



160 Textured Black

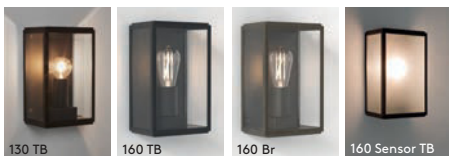

Homefield Wall

| | | | | LAMP | WATT | IP | CLASS | ☰ | Ⓜ |
|------------|----|----------|----|------|---------|----|-------|---|---|
| 130 | TB | 1095040* | | E14▼ | 60W max | 44 | ⊕ | ✓ | ✓ |
| 160 | TB | 1095041* | Br | E27▼ | 60W max | 44 | ⊕ | ✓ | ✓ |
| 160 Sensor | TB | 1095039* | | E27▼ | 60W max | 44 | ⊕ | - | ✓ |

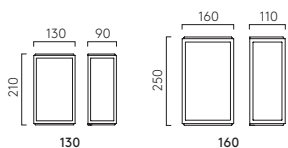

▼ Lamp excluded / La lampe exclu / Das Leuchtmittel ist ausgeschlossen / La lampadina esclusi.

* Suitable for use within five miles (eight km) of the coast or in other onerous environments. / Convient pour une utilisation à moins de huit kilomètres de la côte ou dans d'autres environnements difficiles. / Geeignet für den Einsatz innerhalb von acht Kilometern Entfernung zur Küste oder in anderen rauen Umgebungen. / Adatto per l'uso entro cinque miglia (otto km) dalla costa o in altri ambienti gravosi.



160 Textured Black



Messina

| | | | | | LAMP | WATT | IP | CLASS | 🔄 | 🔍 | | | | |
|------------|----|----------|----|---------|----------|----------|-------|---------|------|---------|----|---|---|---|
| 130 | TB | 1183029* | Br | 1183018 | E27* | 60W max | 44 | ⚡ | ✓ | ✓ | | | | |
| 160 | TB | 1183031 | Br | 1183023 | TB Fr | 1183030* | Br Fr | 1183026 | E27* | 12W max | 44 | ⚡ | ✓ | ✓ |
| 160 Sensor | TB | 1183032* | | | E27* | 60W max | 44 | ⚡ | - | ✓ | | | | |
| 200 | TB | 1183028 | | | E27* | 12W max | 44 | ⚡ | ✓ | ✓ | | | | |
| Twin | TB | 1183027 | | | 2 x E27* | 12W max | 44 | ⚡ | ✓ | ✓ | | | | |

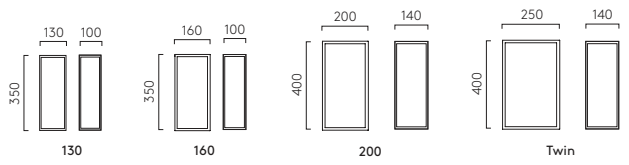

* Lamp excluded / La lampe exclu / Das Leuchtmittel ist ausgeschlossen / La lampadina esclusi.
 * Suitable for use within five miles (eight km) of the coast or in other onerous environments. / Convient pour une utilisation à moins de huit kilomètres de la côte ou dans d'autres environnements difficiles / Geeignet für den Einsatz innerhalb von acht Kilometern Entfernung zur Küste oder in anderen rauen Umgebungen. / Adatto per l'uso entro cinque miglia (otto km) dalla costa o in altri ambienti gravosi.



350 LED Textured Black

Salerno

| | | LAMP | WATT | INPUT | K | CRI | Lm | IP | CLASS | | | |
|----------------|------------------------|--------------|-------------|------------|------|-----|-----|----|-------|-------|---|---|
| 350 | TB 1178009* NB 1178006 | E14* | 2 x 40W max | - | - | - | 44 | 44 | | ✓ | ✓ | - |
| 350 LED | TB 1178012* | Integral LED | 8.2W | 100-277V | 3000 | 80 | 367 | 44 | | - | ✓ | ✓ |
| 520 | TB 1178010* | E14* | 3 x 5W | - | - | - | 44 | 44 | | ✓ | ✓ | - |
| 520 LED | TB 1178011* | Integral LED | 15.4W | Mains 230V | 3000 | 80 | 916 | 44 | | Phase | ✓ | ✓ |

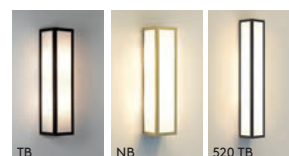
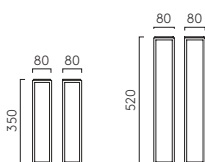

▼ Lamp excluded / La lampe exclu / Das Leuchtmittel ist ausgeschlossen / La lampadina esclusi.

* Suitable for use within five miles (eight km) of the coast or in other onerous environments. / Convient pour une utilisation à moins de huit kilomètres de la côte ou dans d'autres environnements difficiles / Geeignet für den Einsatz innerhalb von acht Kilometern Entfernung zur Küste oder in anderen rauen Umgebungen. / Adatto per l'uso entro cinque miglia (otto km) dalla costa o in altri ambienti gravosi.



350 Textured Black

Harvard Wall

| | LAMP | WATT | IP | CLASS | | |
|-----|-----------------------------------|------|--------|-------|--|---|
| 350 | TB 1402017* Br 1402009 NB 1402007 | E27* | 4W max | 44 | | ✓ |
| 500 | NB 1402006 | E27* | 4W max | 44 | | ✓ |

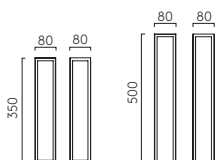

* Lamp excluded / La lampe exclu / Das Leuchtmittel ist ausgeschlossen / La lampadina esclusi.

* Suitable for use within five miles (eight km) of the coast or in other onerous environments. / Convient pour une utilisation à moins de huit kilomètres de la côte ou dans d'autres environnements difficiles. / Geeignet für den Einsatz innerhalb von acht Kilometern Entfernung zur Küste oder in anderen rauen Umgebungen. / Adatto per l'uso entro cinque miglia (otto km) dalla costa o in altri ambienti gravosi.



Box Lantern

| | | LAMP | WATT | IP | CLASS | | |
|-----|-------------|------------------|---------|----|-------|---|---|
| 270 | TB 1354003* | E27 [▼] | 60W max | 23 | | ✓ | ✓ |
| 350 | TB 1354004 | E27 [▼] | 60W max | 23 | | ✓ | ✓ |
| 450 | TB 1354007 | E27 [▼] | 60W max | 23 | | ✓ | ✓ |

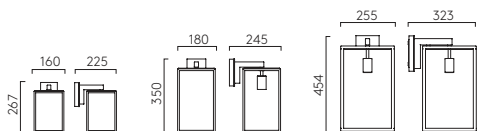

▼ Lamp excluded / La lampe exclu / Das Leuchtmittel ist ausgeschlossen / La lampadina esclusi.

* Suitable for use within five miles (eight km) of the coast or in other onerous environments. / Convient pour une utilisation à moins de huit kilomètres de la côte ou dans d'autres environnements difficiles / Geeignet für den Einsatz innerhalb von acht Kilometern Entfernung zur Küste oder in anderen rauen Umgebungen. / Adatto per l'uso entro cinque miglia (otto km) dalla costa o in altri ambienti gravosi.



Coach

| | LAMP | WATT | IP | CLASS | | |
|---------------|------|---------|----|-------|--|--|
| 130 1369006* | E27* | 60W max | 44 | | | |

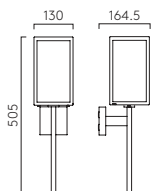

† Lamp excluded / La lampe exclu / Das Leuchtmittel ist ausgeschlossen / La lampadina esclusi.

* Suitable for use within five miles (eight km) of the coast or in other onerous environments. / Convient pour une utilisation à moins de huit kilomètres de la côte ou dans d'autres environnements difficiles. / Geeignet für den Einsatz innerhalb von acht Kilometern Entfernung zur Küste oder in anderen rauen Umgebungen. / Adatto per l'uso entro cinque miglia (otto km) dalla costa o in altri ambienti gravosi.



Farringdon

| | LAMP | WATT | IP | CLASS | | |
|-------------|------|---------|----|-------|---|---|
| TB 1366002* | E27* | 60W max | 44 | | ✓ | ✓ |

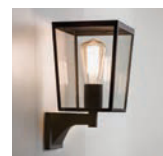
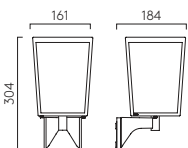

▼ Lamp excluded / La lampe exclu / Das Leuchtmittel ist ausgeschlossen / La lampadina esclusi.

* Suitable for use within five miles (eight km) of the coast or in other onerous environments. / Convient pour une utilisation à moins de huit kilomètres de la côte ou dans d'autres environnements difficiles / Geeignet für den Einsatz innerhalb von acht Kilometern Entfernung zur Küste oder in anderen rauen Umgebungen. / Adatto per l'uso entro cinque miglia (otto km) dalla costa o in altri ambienti gravosi.



305

Calvi Wall

| | LAMP | WATT | IP | CLASS | | |
|---|------|---------|----|-------|---|---|
| 215 TB 1306001 AB 1306005 | E27* | 60W max | 23 | | ✓ | ✓ |
| 305 TB 1306011 | E27* | 60W max | 23 | | ✓ | ✓ |

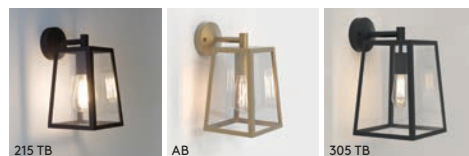
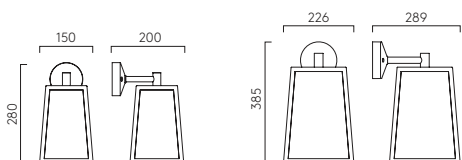

* Lamp excluded / La lampe exclu / Das Leuchtmittel ist ausgeschlossen / La lampadina esclusi.



200

Richmond Lantern

| | LAMP | WATT | IP | CLASS | | |
|--------------|------|---------|----|-------|---|---|
| 200 1340004 | E27* | 60W max | 23 | | ✓ | ✓ |
| 254 1340011 | E27* | 60W max | 23 | | ✓ | ✓ |

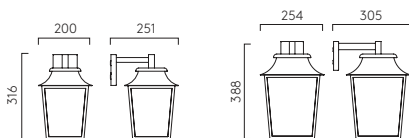

▼ Lamp excluded / La lampe exclu / Das Leuchtmittel ist ausgeschlossen / La lampadina esclusi.



Richmond Wall

| | | LAMP | WATT | IP | CLASS | ☾ | Ⓢ |
|-----|--|------|---------|----|-------|---|---|
| 235 |  1340013* | E27* | 60W max | 44 | Ⓢ | ✓ | ✓ |
| 285 |  1340014* | E27* | 60W max | 44 | Ⓢ | ✓ | ✓ |

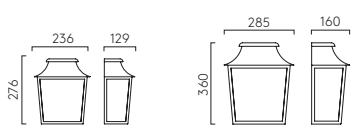

▼ Lamp excluded / La lampe exclu / Das Leuchtmittel ist ausgeschlossen / La lampadina esclusi.
 * Suitable for use within five miles (eight km) of the coast or in other onerous environments. / Convient pour une utilisation à moins de huit kilomètres de la côte ou dans d'autres environnements difficiles / Geeignet für den Einsatz innerhalb von acht Kilometern Entfernung zur Küste oder in anderen rauen Umgebungen. / Adatto per l'uso entro cinque miglia (otto km) dalla costa o in altri ambienti gravosi.



Harvard Lantern

| | LAMP | WATT | IP | CLASS | | |
|-------------|------|---------|----|-------|-------------------------------------|-------------------------------------|
| TB 1402011* | E27* | 60W max | 44 | | <input checked="" type="checkbox"/> | <input checked="" type="checkbox"/> |

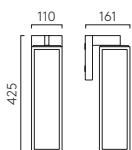

Frosted Glass
Accessory
Fr 6030003



▼ Lamp excluded / La lampe exclu / Das Leuchtmittel ist ausgeschlossen / La lampadina esclusi.

* Suitable for use within five miles (eight km) of the coast or in other onerous environments. / Convient pour une utilisation à moins de huit kilomètres de la côte ou dans d'autres environnements difficiles / Geeignet für den Einsatz innerhalb von acht Kilometern Entfernung zur Küste oder in anderen rauen Umgebungen. / Adatto per l'uso entro cinque miglia (otto km) dalla costa o in altri ambienti gravosi.



500 Antique Brass

Pimlico

| | | | | LAMP | WATT | IP | CLASS | | |
|-----|-------------|------------|------------|------------------|---------|----|-------|---|---|
| 400 | TB 1413001* | Br 1413002 | AB 1413003 | E27 [▼] | 60W max | 23 | | ✓ | ✓ |
| 500 | TB 1413004* | Br 1413005 | AB 1413006 | E27 [▼] | 60W max | 23 | | ✓ | ✓ |

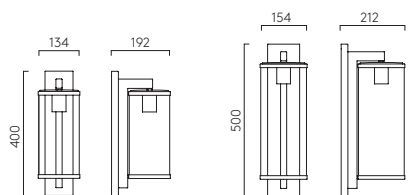

▼ Lamp excluded / La lampe exclu / Das Leuchtmittel ist ausgeschlossen / La lampadina esclusi.
 * Suitable for use within five miles (eight km) of the coast or in other onerous environments. / Convient pour une utilisation à moins de huit kilomètres de la côte ou dans d'autres environnements difficiles / Geeignet für den Einsatz innerhalb von acht Kilometern Entfernung zur Küste oder in anderen rauen Umgebungen. / Adatto per l'uso entro cinque miglia (otto km) dalla costa o in altri ambienti gravosi.



Montparnasse Wall

| PN | Br | LAMP | WATT | IP | CLASS | | |
|---------|---------|------|---------|----|-------|---|---|
| 1096001 | 1096009 | E27▼ | 60W max | 44 | | ✓ | ✓ |

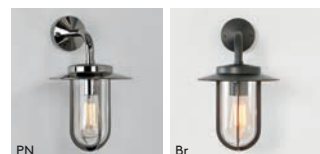
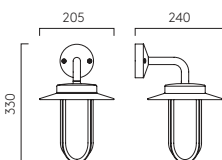

▼ Lamp excluded / La lampe EXCLU / La lampadina esclusi / Das Leuchtmittel ist ausgeschlossen



Cabin Wall

| | Br | AB | LAMP | WATT | IP | CLASS | | |
|---------|---------|---------|------|---------|----|-------|---|---|
| Clear | 1368025 | 1368003 | E27* | 60W max | 44 | | ✓ | ✓ |
| Frosted | 1368026 | 1368008 | E27* | 60W max | 44 | | ✓ | ✓ |

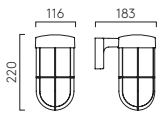

* Lamp excluded/La lampe exclu/Das Leuchtmittel ist ausgeschlossen/La lampadina esclusi.



Portree Wall

| | LAMP | WATT | IP | CLASS | | |
|------------|------|---------|----|-------|---|---|
| SB 1400003 | E27* | 12W max | 44 | | ✓ | ✓ |

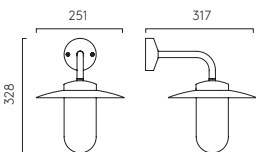

* Lamp excluded / La lampe exclu / Das Leuchtmittel ist ausgeschlossen / La lampadina esclusi.

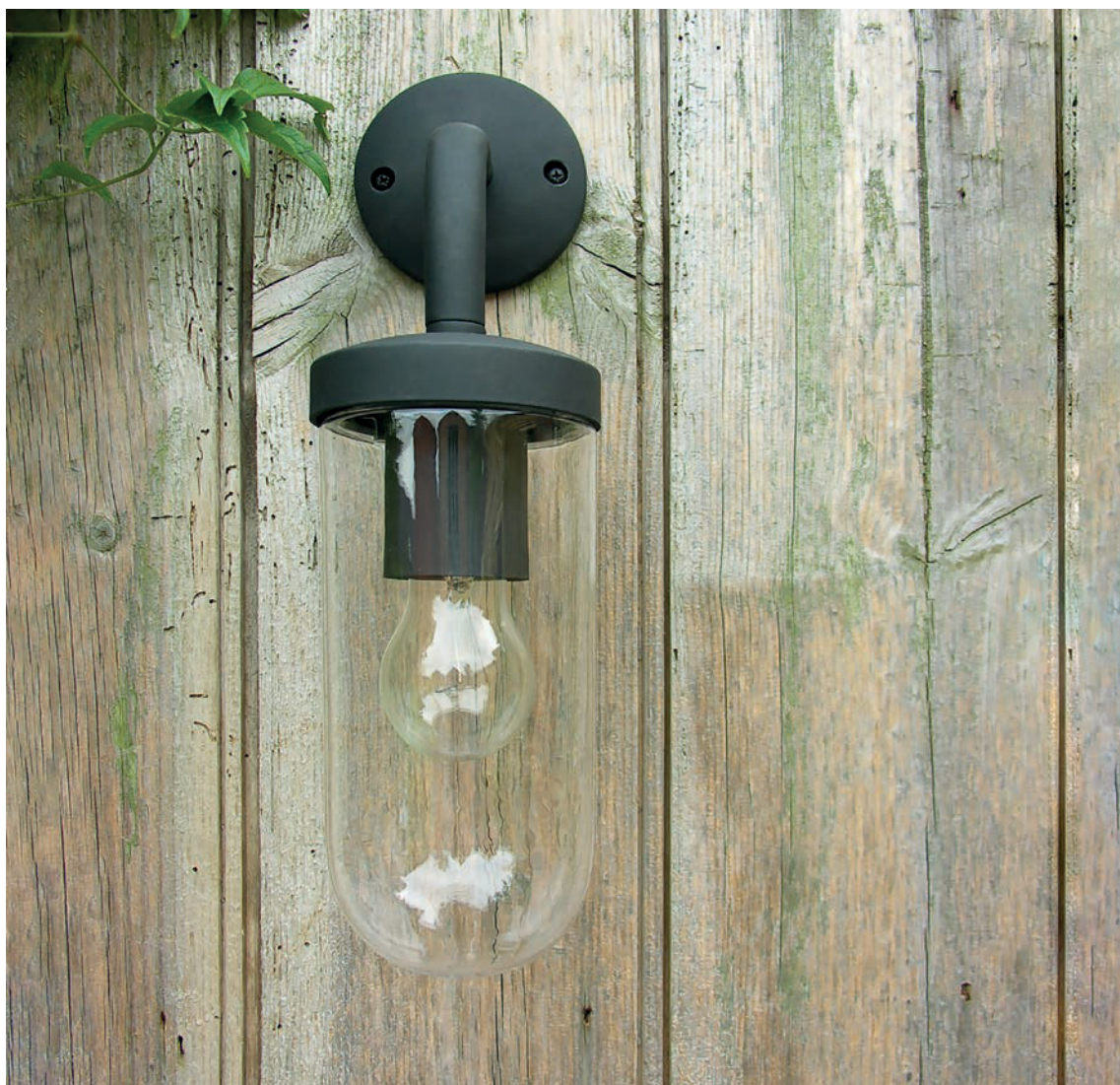

Tressino

TB 1193004

| LAMP | WATT | IP | CLASS | | |
|------|---------|----|-------|---|---|
| E27* | 60W max | 44 | | ✓ | ✓ |

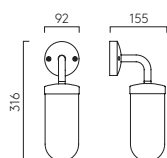

* Lamp excluded / La lampe exclu / Das Leuchtmittel ist ausgeschlossen / La lampadina esclusi.



Thurso



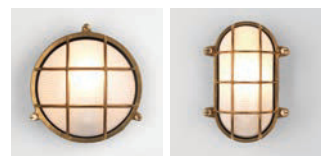
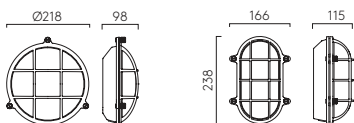



| | | LAMP | WATT | IP | CLASS | | |
|-------|------------|------|---------|----|-------|---|---|
| Round | CB 1376005 | E27* | 42W max | 44 | | ✓ | ✓ |
| Oval | CB 1376006 | E27* | 42W max | 44 | | ✓ | ✓ |



* Lamp excluded / La lampe exclu / Das Leuchtmittel ist ausgeschlossen / La lampadina esclusi.



Kea

| | | | | LAMP | WATT | INPUT | K | CRI | Lm | IP | CLASS |  |
|-----------|---|---|--|--------------|-------|------------|------|-----|------|----|---|---|
| Round 150 |  1391001 |  1391002 | | Integral LED | 8.1W | Mains 230V | 3000 | 80 | 566 | 65 |  | ✓ |
| Round 250 |  1391003 |  1391004 | | Integral LED | 12.6W | Mains 230V | 3000 | 80 | 1046 | 65 |  | ✓ |

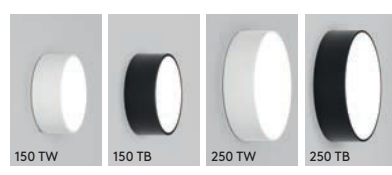
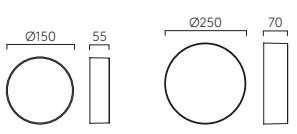

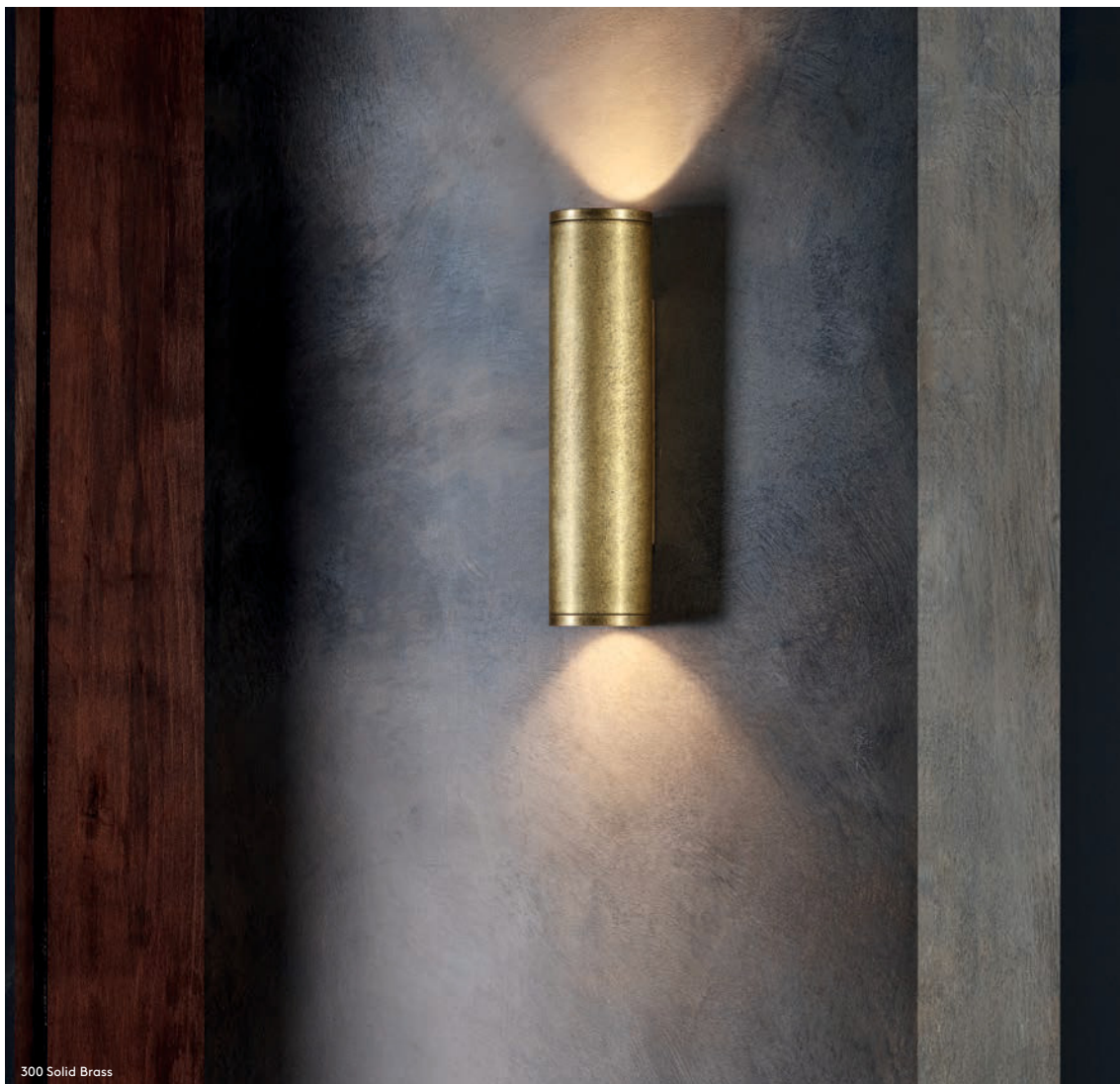

Ava

| | | LAMP | WATT | IP | CLASS | |
|-----|---|-------------------|------------|----|-------|---|
| 200 | TB 1428005 | GU10 [▼] | 6W max | 44 | | ✓ |
| 300 | TB 1428009 SB 1428017 | GU10 [▼] | 2 x 6W max | 44 | | ✓ |
| 400 | TB 1428013 | GU10 [▼] | 2 x 6W max | 44 | | ✓ |

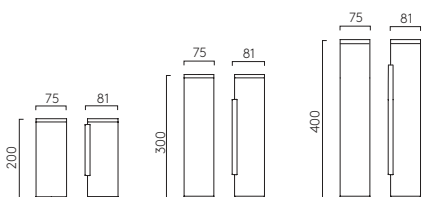

▼ Lamp excluded / La lampe exclu / Das Leuchtmittel ist ausgeschlossen / La lampadina esclusi.



Montreal

| | | | | LAMP | WATT | IP | CLASS | | | |
|------------------|---------|-----------|--|------|---------|----|-------|---|---|---|
| Oval | 1032007 | 1032013 * | | E27* | 12W max | 44 | | ✓ | ✓ | ✓ |
| Round 220 | 1032005 | 1032011 * | | E14* | 7W max | 44 | | ✓ | ✓ | ✓ |
| Round 300 | 1032006 | 1032012 * | | E27* | 12W max | 44 | | ✓ | ✓ | ✓ |

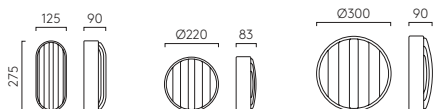

▼ Lamp excluded / La lampe exclu / Das Leuchtmittel ist ausgeschlossen / La lampadina esclusi.

* Suitable for use within five miles (eight km) of the coast or in other onerous environments. / Convient pour une utilisation à moins de huit kilomètres de la côte ou dans d'autres environnements difficiles / Geeignet für den Einsatz innerhalb von acht Kilometern Entfernung zur Küste oder in anderen rauen Umgebungen. / Adatto per l'uso entro cinque miglia (otto km) dalla costa o in altri ambienti gravosi.



Chios

| | LAMP | WATT | IP | CLASS | |
|-----|--|-------|------------|-------|---|
| 80 | TG 1310007 TB 1310002 TW 1310005 | GU10* | 6W max | 44 | ✓ |
| 150 | TG 1310008 TB 1310004 TW 1310006 | GU10* | 2 x 6W max | 44 | ✓ |



* Lamp excluded / La lampe exclu / Das Leuchtmittel ist ausgeschlossen / La lampadina esclusi.

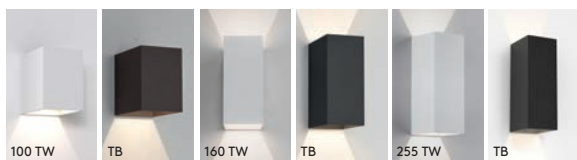

Oslo

| | | | | LAMP | WATT | INPUT | K | CRI | Lm | IP | CLASS | |
|-----|----|---------|----|---------|--------------|-------|------------|------|----|---------|-------|-----|
| 100 | TB | 1298004 | TW | 1298005 | Integral LED | 3.8W | Mains 230V | 3000 | 90 | 47 | 65 | ⊕ - |
| 160 | TB | 1298002 | TW | 1298006 | Integral LED | 5.8W | Mains 230V | 3000 | 90 | 76-146 | 65 | ⊕ ✓ |
| 255 | TB | 1298007 | TW | 1298009 | Integral LED | 7.5W | Mains 230V | 3000 | 80 | 270-365 | 65 | ⊕ ✓ |

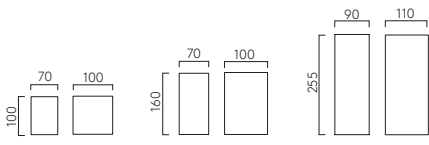



255

Dunbar

| | LAMP | WATT | INPUT | K | CRI | Lm | IP | CLASS | |
|-----|------------|--------------|-------|------------|------|--------|----|-------|---|
| 100 | TB 1384003 | Integral LED | 3.7W | Mains 230V | 3000 | 90 64 | 65 | ⊕ | ✓ |
| 160 | TB 1384004 | Integral LED | 5.8W | Mains 230V | 3000 | 90 76 | 65 | ⊕ | ✓ |
| 255 | TB 1384005 | Integral LED | 7.5W | Mains 230V | 3000 | 80 303 | 65 | ⊕ | ✓ |

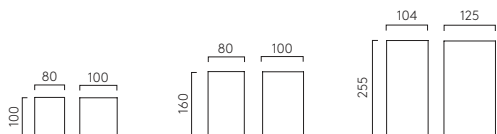



Elis

| | LAMP | WATT | INPUT | K | CRI | Lm | IP | CLASS | | |
|---------------|--------------------------|--------------|-------|------------|------|----|-----|-------|---|---|
| Single | TB 1331001 | Integral LED | 4.7W | Mains 230V | 3000 | 80 | 248 | 54 | ⊕ | ✓ |
| Twin | TB 1331002 SB 1331013 | Integral LED | 8.2W | Mains 230V | 3000 | 80 | 524 | 54 | ⊕ | ✓ |

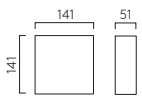

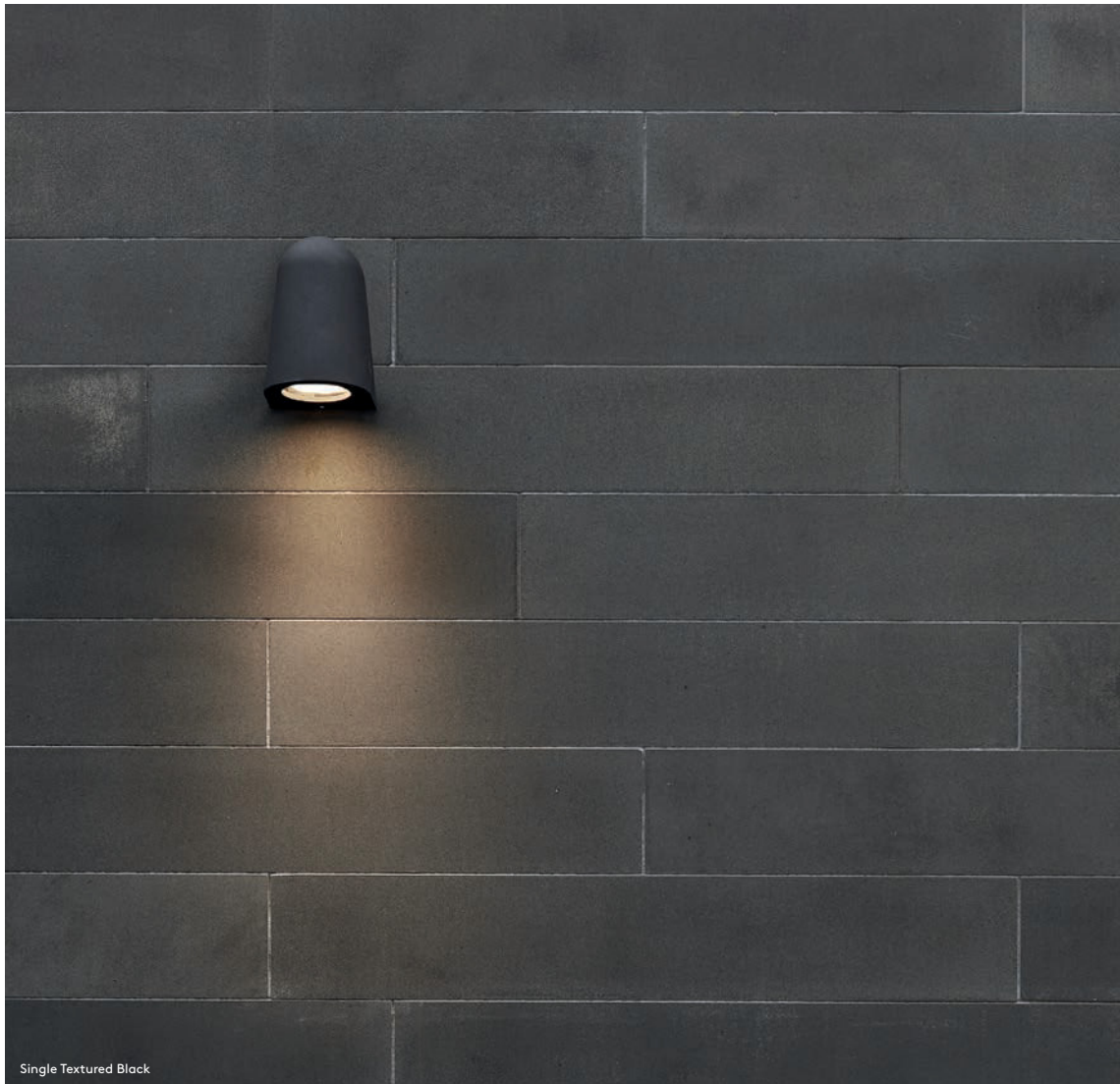

Single Textured Black

Mast Light

| | | | | | LAMP | WATT | IP | CLASS | |
|--------|-------------------|-------------------|-------------------|-------------------|-------------------|------------|----|-------|---|
| Single | TB 1317011 | TW 1317012 | TG 1317007 | AB 1317003 | GU10 [▼] | 6W max | 65 | ⊕ | ✓ |
| Twin | TB 1317018 | | | AB 1317017 | GU10 [▼] | 2 x 6W max | 44 | ⊕ | ✓ |

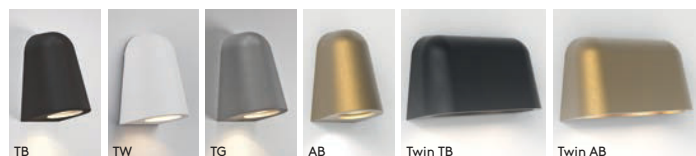
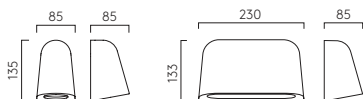

▼ Lamp excluded / La lampe exclu / Das Leuchtmittel ist ausgeschlossen / La lampadina esclusi.



Twin Textured Black

Dartmouth

| | LAMP | WATT | INPUT | K | CRI | Lm | IP | CLASS | | | |
|------------|-----------------------|--------------|------------|------------|------|----|-----|-------|---|---|---|
| Single | TB 1372011 TG 1372010 | GU10* | 6W max | - | - | - | 54 | | ✓ | - | |
| Single LED | TB 1372003 | Integral LED | 4.6W | Mains 230V | 3000 | 80 | 263 | 54 | | - | ✓ |
| Twin | TB 1372014 TG 1372013 | GU10* | 2 x 6W max | - | - | - | 54 | | ✓ | - | |
| Twin LED | TB 1372006 | Integral LED | 8.1W | Mains 230V | 3000 | 80 | 542 | 54 | | - | ✓ |



▼ Lamp excluded / La lampe EXCLU / La lampadina esclusi / Das Leuchtmittel ist ausgeschlossen





Dartmouth Spot

| | | LAMP | WATT | IP | CLASS | |
|--------|------------|-------|-------------|----|-------|---|
| Single | TB 1372015 | GU10▼ | 10W max | 44 | | ✓ |
| Twin | TB 1372016 | GU10▼ | 2 x 10W max | 44 | | ✓ |



▼ Lamp excluded / La lampe exclu / Das Leuchtmittel ist ausgeschlossen / La lampadina esclusi.



Bayville Spot



| | LAMP | WATT | INPUT | K | CRI | Lm | IP | CLASS | | |
|--------|------------|--------------|------------------|------|-----|-----|----|-------|-------|---|
| Single | TB 1401015 | Integral LED | 8.2W Mains 230V | 3000 | 80 | 467 | 65 | | Phase | ✓ |
| Twin | TB 1401018 | Integral LED | 16.4W Mains 230V | 3000 | 80 | 934 | 65 | | Phase | ✓ |





Jura Single Spot

SB 1375013

| LAMP | WATT | IP | CLASS |  |
|-------|--------|----|---|---|
| GU10* | 6W max | 65 |  | Phase |

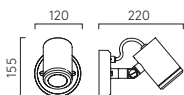

* Lamp excluded / La lampe exclu / Das Leuchtmittel ist ausgeschlossen / La lampadina esclusi.



Single

Jura

| | | LAMP | WATT | IP | CLASS | |
|--------|------------|-------|-------------|----|-------|---|
| Single | SB 1375009 | GU10* | 35W max | 44 | | ✓ |
| Twin | SB 1375010 | GU10* | 2 x 35W max | 44 | | ✓ |

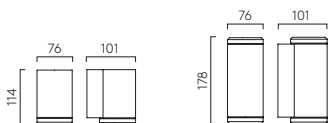

Single

Twin

* Lamp excluded / La lampe exclu / Das Leuchtmittel ist ausgeschlossen / La lampadina esclusi.



Mori

| | | LAMP | WATT | INPUT | K | CRI | Lm | IP | CLASS | |
|-----|---------|--------------|------|------------|-----------|-----|-----|----|-------|--|
| 140 | 1466001 | Integral LED | 4.1W | 220-240V | 3000/4000 | 80 | 116 | 65 | | |
| 250 | 1466002 | Integral LED | 8.1W | Mains 230V | 3000/4000 | 80 | 214 | 65 | | |





Incline

| | LAMP | WATT | INPUT | K | CRI | Lm | IP | CLASS | |
|------------|--------------|------|----------|------|-----|-----|----|-------|---|
| SB 1419005 | Integral LED | 8.2W | 220-240V | 3000 | 80 | 485 | 65 | | ✓ |

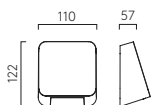



Tango

| | | | LAMP | WATT | INPUT | K | CRI | Lm | IP | CLASS | | |
|--------------------|-------------------|-------------------|--------------|------|--------|------|-----|----|----|-------|-----|---|
| BSS 1175002 | TB 1175004 | MW 1175001 | Integral LED | 2.2W | 350mA▼ | 3000 | 90 | 23 | 65 | | Ø64 | ✓ |

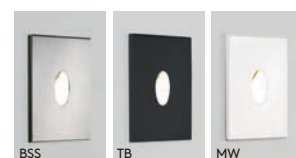
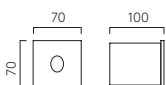

▼ Driver excluded / Driver d'entrée exclu / Driver esclusi / Das treiber ist ausgeschlossen



Tivola

| | LAMP | WATT | INPUT | K | CRI | Lm | IP | CLASS | | | | | |
|------------|------------|------------|--------------|------|--------|------|----|-------|----|---|-----|---|---|
| TG 1338009 | TB 1338001 | AB 1338003 | Integral LED | 3.8W | 700mA▼ | 3000 | 90 | 82 | 65 | ◆ | Ø62 | ✓ | ✓ |

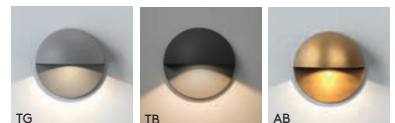
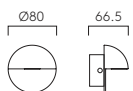

▼ Driver excluded / Driver d'entrée exclu / Driver esclusi / Das treiber ist ausgeschlossen



Beam

| | | LAMP | WATT | INPUT | K | CRI | Lm | IP | CLASS | | | |
|-----|-------------|--------------|------|--------|------|-----|----|----|-------|-----|---|---|
| One | MPS 1202004 | Integral LED | 3.2W | 700mA▼ | 3000 | 80 | 15 | 67 | ◆ | Ø40 | ✓ | ✓ |
| Two | MPS 1202005 | Integral LED | 3.2W | 700mA▼ | 3000 | 80 | 34 | 67 | ◆ | Ø40 | ✓ | ✓ |

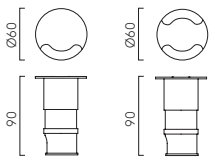

▼ Driver excluded / Driver d'entrée exclu / Driver esclusi / Das treiber ist ausgeschlossen



Gramos

| | | | | LAMP | WATT | IP CLASS | | | |
|---------------|---------|---------|--|-------|--------|----------|--|--|--|
| Round | 1312001 | 1312008 | | GU10* | 6W max | 65 | | | |
| Square | 1312003 | 1312009 | | GU10* | 6W max | 65 | | | |

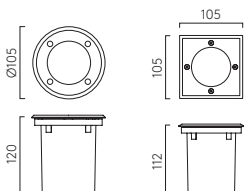

▼ Lamp excluded / La lampe EXCLU / La lampadina esclusi / Das Leuchtmittel ist ausgeschlossen



42

Terra

| | | LAMP | WATT | INPUT | K | CRI | Lm | IP | CLASS | | | |
|----|-------------|--------------|------|--------------------|------|-----|-----|----|-------|-----|---|---|
| 28 | BSS 1201005 | Integral LED | 1.8W | 350mA [▼] | 3000 | 80 | 53 | 65 | | Ø25 | ✓ | ✓ |
| 42 | AA 1201007 | Integral LED | 3.2W | 700mA [▼] | 3000 | 80 | 169 | 67 | | Ø40 | ✓ | ✓ |

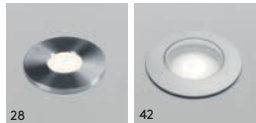
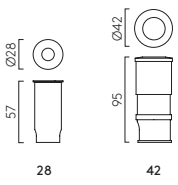

[▼] Driver excluded / Driver d'entrée exclu / Driver esclusi / Das treiber ist ausgeschlossen



Bayville Spike Spot

| | | LAMP | WATT | INPUT | K | CRI | Lm | IP | CLASS | | |
|-----------------|-------------------|--------------|-------|------------|------|-----|-----|----|-------|-------|---|
| | TB 1401021 | Integral LED | 8.2W | Mains 230V | 3000 | 80 | 467 | 65 | | Phase | ✓ |
| 12V | TB 1401009 | Integral LED | 6.4W | 12V * | 3000 | 80 | 465 | 65 | | - | ✓ |
| 900 | TB 1401023 | Integral LED | 8.2W | Mains 230V | 3000 | 80 | 467 | 66 | | Phase | ✓ |
| 900 Twin | TB 1401024 | Integral LED | 16.4W | Mains 230V | 3000 | 80 | 934 | 66 | | Phase | ✓ |

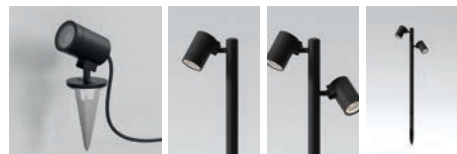
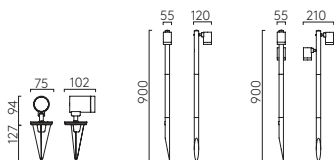

* Driver excluded / Driver d'entrée exclu / Driver esclusi / Das treiber ist ausgeschlossen



Myos

| | LAMP | WATT | INPUT | K | CRI | Lm | IP | CLASS | | |
|------------|--------------|-------|--------|------|-----|-----|----|-------|---|---|
| TB 1426002 | Integral LED | 11.4W | 700mA* | 3000 | 90 | 312 | 65 | | ✓ | ✓ |

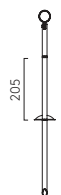
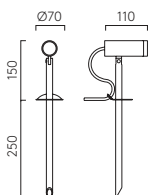

Extension Pole Accessory
6034001

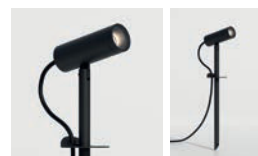

* Driver excluded / Driver d'entrée exclu / Driver esclusi / Das treiber ist ausgeschlossen





GROUND

NEW

Dartmouth Spike Spot

TB 1372017

| LAMP | WATT | IP | CLASS | |
|-------|---------|----|-------|---|
| GU10▼ | 10W max | 65 | | ✓ |

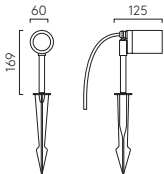

▼ Lamp excluded/La lampe exclu/Das Leuchtmittel ist ausgeschlossen/La lampadina esclusi.



Jura Spike Spot

| | LAMP | WATT | IP | CLASS |  |
|-------------------|-------|--------|----|---|---|
| SB 1375012 | GU10* | 6W max | 65 |  | <input checked="" type="checkbox"/> |

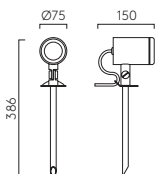

▼ Lamp excluded / La lampe exclu / Das Leuchtmittel ist ausgeschlossen / La lampadina esclusi.



Soprano Wall

TB 1131004

| LAMP | WATT | IP | CLASS | Ⓢ |
|-------|--------|----|-------|---|
| GX53* | 9W max | 44 | Ⓢ | ✓ |

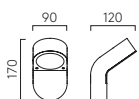

▼ Lamp excluded/La lampe exclu/Das Leuchtmittel ist ausgeschlossen/La lampadina esclusi.



Soprano Bollard

| | LAMP | WATT | IP | CLASS | |
|------------|-------|--------|----|-------|---|
| TB 1131006 | GX53▼ | 9W max | 44 | | ✓ |

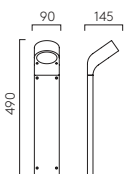

▼ Lamp excluded / La lampe exclu / Das Leuchtmittel ist ausgeschlossen / La lampadina esclusi.



Homefield Pedestal

| | LAMP | WATT | IP | CLASS | | |
|------------|------|---------|----|-------|---|---|
| TB 1095036 | E27▼ | 12W max | 44 | | ✓ | ✓ |

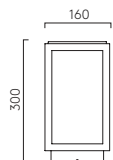

▼ Lamp excluded / La lampe exclu / Das Leuchtmittel ist ausgeschlossen / La lampadina esclusi.



Kuro

PORTABLE

| | | LAMP | WATT | INPUT | K | CRI | Lm | IP | CLASS | | |
|-----|---------|--------------|------|---------------------|------|-----|-----|----|-------|---|--------|
| 250 | 1430001 | Integral LED | 1.3W | Solar powered 5V DC | 2700 | 80 | 145 | 44 | | ✓ | 3-step |
| 450 | 1430002 | Integral LED | 1.3W | Solar powered 5V DC | 2700 | 80 | 145 | 44 | | ✓ | 3-step |

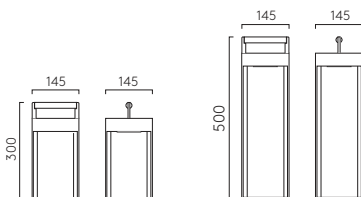

Charged via USB-C to USB-A charging cable (included) 6032001 5V USB charger available separately



Nomad

PORTABLE

| | LAMP | WATT | INPUT | K | CRI | Lm | IP | CLASS | | | |
|------------|------------|----------------|-------|---------------|------|----|-----|-------|--|---------|---|
| TB 1484001 | TW 1484002 | Integrated LED | 2W | 5V DC - USB-C | 3000 | 80 | 181 | IP65 | | ✓ Touch | ✓ |

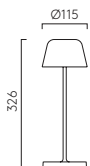

Charged via USB-C to USB-A charging cable (included) 6032001 5V USB charger available separately



Harvard Pendant

| | LAMP | WATT | IP | CLASS | | |
|-------------|------|---------|----|-------|-------------------------------------|-------------------------------------|
| TB 1402013* | E27* | 12W max | 44 | | <input checked="" type="checkbox"/> | <input checked="" type="checkbox"/> |

Frosted Glass 6030003

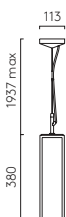

▼ Lamp excluded/La lampe exclu/Das Leuchtmittel ist ausgeschlossen/La lampadina esclusi.

* Suitable for use within five miles (eight km) of the coast or in other onerous environments./Convient pour une utilisation à moins de huit kilomètres de la côte ou dans d'autres environnements difficiles/ Geeignet für den Einsatz innerhalb von acht Kilometern Entfernung zur Küste oder in anderen rauen Umgebungen./Adatto per l'uso entro cinque miglia (otto km) dalla costa o in altri ambienti gravosi.



Montparnasse Pendant

| PN | Br | LAMP | WATT | IP | CLASS | | |
|---------|---------|------|---------|----|-------|---|---|
| 1096004 | 1096010 | E27* | 60W max | 44 | | ✓ | ✓ |

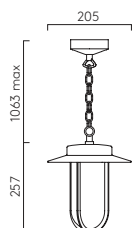

* Lamp excluded/La lampe exclu/Das Leuchtmittel ist ausgeschlossen/La lampadina esclusi.



215

Calvi Pendant

| | | LAMP | WATT | IP | CLASS | | |
|-----|------------|------------------|---------|----|-------|---|---|
| 215 | TB 1306003 | E27 [▼] | 60W max | 23 | | ✓ | ✓ |
| 305 | TB 1306013 | E27 [▼] | 60W max | 23 | | ✓ | ✓ |

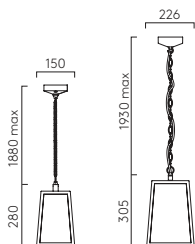

215

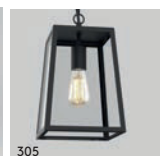

305

▼ Lamp excluded / La lampe exclu / Das Leuchtmittel ist ausgeschlossen / La lampadina esclusi.



240

Homefield Pendant

| | | LAMP | WATT | IP CLASS | | |
|-----|----------|------------------|---------|----------|---|---|
| 240 | 1095010 | E27 [▼] | 60W max | 23 | ✓ | ✓ |
| | 1095035 | E27 [▼] | 12W max | 44 | ✓ | ✓ |
| 360 | 1095015* | E27 [▼] | 60W max | 23 | ✓ | ✓ |
| 450 | 1095033 | E27 [▼] | 12W max | 23 | ✓ | ✓ |

| | | | |
|-----|----|-----|-----|
| | | | |
| 240 | NB | 360 | 450 |

| | | | |
|-----|--------|-----|-----|
| | | | |
| 240 | 240 NB | 360 | 450 |

▼ Lamp excluded / La lampe exclu / Das Leuchtmittel ist ausgeschlossen / La lampadina esclusi.

* Suitable for use within five miles (eight km) of the coast or in other onerous environments. / Convient pour une utilisation à moins de huit kilomètres de la côte ou dans d'autres environnements difficiles / Geeignet für den Einsatz innerhalb von acht Kilometern Entfernung zur Küste oder in anderen rauen Umgebungen. / Adatto per l'uso entro cinque miglia (otto km) dalla costa o in altri ambienti gravosi.



Homefield Ceiling

| | LAMP | WATT | IP | CLASS | | |
|-------------|------|---------|----|-------|---|---|
| TB 1095021* | E27* | 60W max | 23 | | ✓ | ✓ |

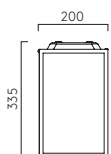

▼ Lamp excluded / La lampe exclu / La lampadina esclusi / Das Leuchtmittel ist ausgeschlossen

* Suitable for use within five miles (eight km) of the coast or in other onerous environments./Convient pour une utilisation à moins de huit kilomètres de la côte ou dans d'autres environnements difficiles / Geeignet für den Einsatz innerhalb von acht Kilometern Entfernung zur Küste oder in anderen rauen Umgebungen./Adatto per l'uso entro cinque miglia (otto km) dalla costa o in altri ambienti gravosi.



Bronte

| | LAMP | WATT | IP | CLASS | | |
|------------|------|---------|----|-------|---|---|
| TB 1353001 | E27* | 60W max | 25 | | ✓ | ✓ |

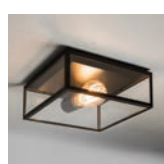
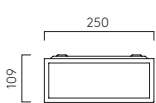

* Lamp excluded/La lampe exclu/Das Leuchtmittel ist ausgeschlossen/La lampadina esclusi.

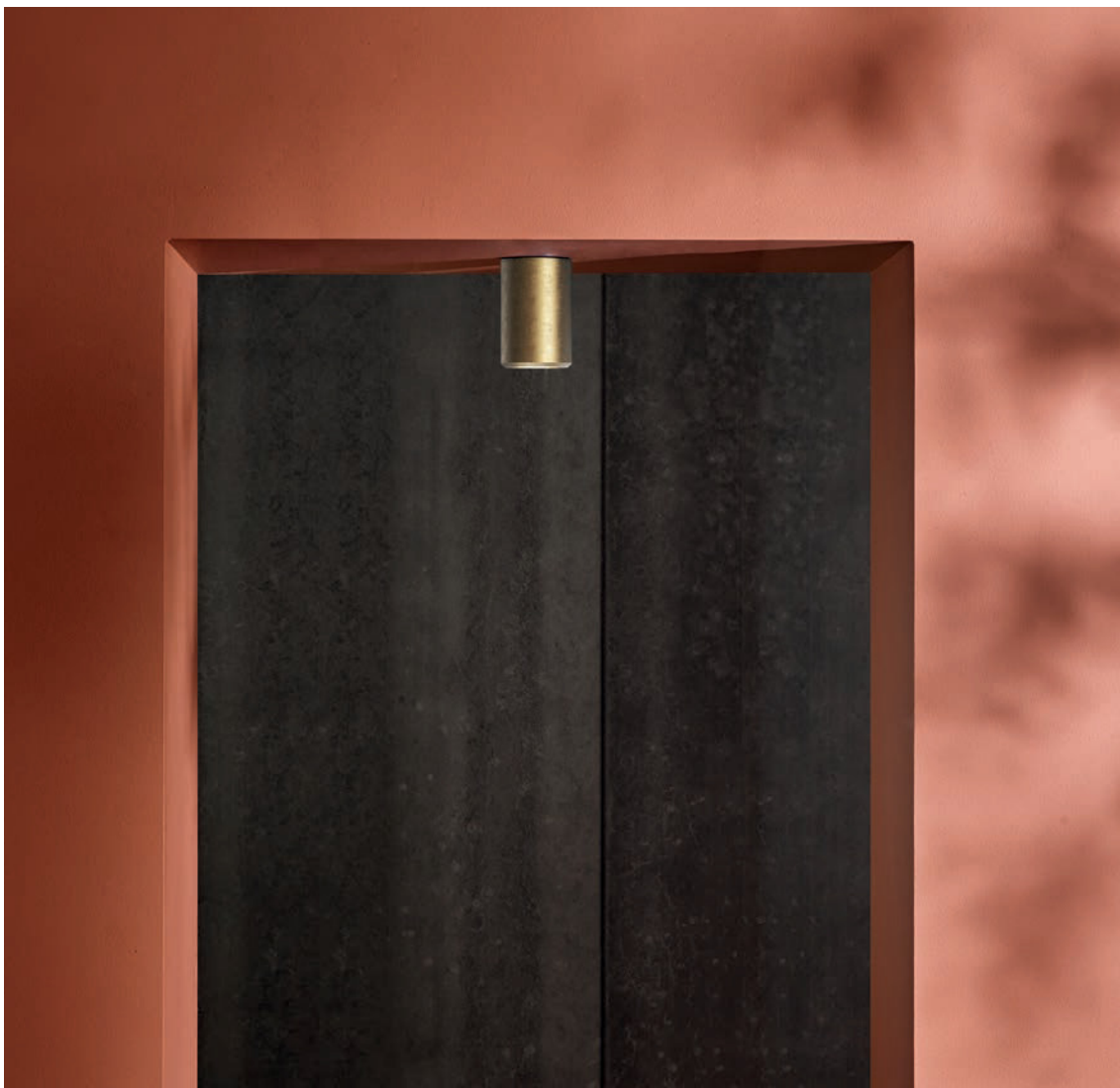

Jura Surface

| | LAMP | WATT | IP | CLASS | |
|------------|-------|---------|----|-------|---|
| SB 1375011 | GU10* | 35W max | 44 | | ✓ |

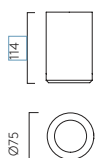

▼ Lamp excluded / La lampe exclu / La lampadina esclusi / Das Leuchtmittel ist ausgeschlossen



Kos

| | | | | LAMP | WATT | INPUT | K | CRI | Lm | IP | CLASS | | | |
|---------------|-----|---------|----|---------|--------------|--------|------------|------|----|-----|-------|--|-------|---|
| Round 85 | MW | 1326039 | TB | 1326040 | GU10* | 6W max | Mains 230V | - | - | - | 65 | | ✓ | - |
| | PCh | 1326042 | TG | 1326041 | GU10* | 6W max | Mains 230V | - | - | - | 65 | | ✓ | - |
| | SB | 1326075 | | | GU10* | 6W max | Mains 230V | - | - | - | 44 | | ✓ | - |
| Round 100 LED | TW | 1326061 | TB | 1326062 | Integral LED | 6.2W | Mains 230V | 3000 | 80 | 316 | 65 | | Phase | ✓ |
| Round 140 LED | TW | 1326067 | TB | 1326068 | Integral LED | 12.8W | Mains 230V | 3000 | 80 | 761 | 65 | | Phase | ✓ |
| Square 85 | MW | 1326043 | TB | 1326044 | GU10* | 6W max | Mains 230V | - | - | - | 65 | | ✓ | - |

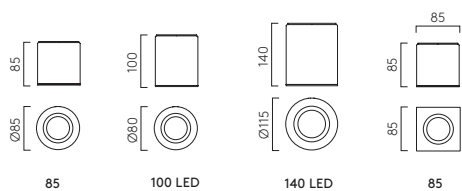

* Lamp excluded / La lampe exclu / Das Leuchtmittel ist ausgeschlossen / La lampadina esclusi.





MW



TB



Kos Recessed

| | LAMP | WATT | IP | CLASS | |
|--------------------------|-------|--------|----|-------|---|
| MW 1326080 TB 1326081 | GU10▼ | 6W max | 65 | ⊕ | ✓ |

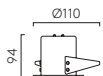

▼ Lamp excluded/La lampe exclu/Das Leuchtmittel ist ausgeschlossen/La lampadina esclusi.



Coastal Lighting



NEW
Newlyn Single
P. 386r4w2



NEW
Newlyn Twin
P. 386



NEW
Montreal Coastal
Round
P. 388



NEW
Montreal Coastal
Oval
P. 388



Ava Coastal
P. 390



Dunbar Coastal
P. 392



Eclipse Coastal
P. 393



Mast Light
Coastal Single
P. 394



Mast Light
Coastal Twin
P. 394



Oslo Coastal
P. 396



Kos Coastal
P. 397



NEW
Newlyn Surface
P. 398



Cromarty
P. 400



Skye Spike Spot
P. 401





AVAILABLE SPRING 2025

Newlyn Wall

| | | | LAMP | WATT | IP | CLASS | |
|---------------|---------|---------|-------|--------|----|-------|---|
| Single | 1488001 | 1488002 | GU10* | 6W max | 65 | | ✓ |
| Twin | 1488004 | 1488003 | GU10* | 6W max | 65 | | ✓ |

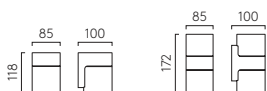

* Lamp excluded/La lampe exclu/Das Leuchtmittel ist ausgeschlossen/La lampadina esclusi.

* Ten-year warranty applies/Garantie de dix ans/La garanzia di dieci anni è applicabile/Es gilt eine zehnjährige Garantie.





AVAILABLE SPRING 2025

Montreal Coastal

| | | LAMP | WATT | IP | CLASS | | |
|-----------|--|------------------|---------|----|-------|---|---|
| Round 220 | <input type="checkbox"/> BSS 1032011* | E14 [▼] | 7W max | 44 | | ✓ | ✓ |
| Round 300 | <input type="checkbox"/> BB 1032018* <input type="checkbox"/> BSS 1032012* | E27 [▼] | 12W max | 44 | | ✓ | ✓ |
| Oval | <input type="checkbox"/> BB 1032019* <input type="checkbox"/> BSS 1032013* | E27 [▼] | 12W max | 44 | | ✓ | ✓ |

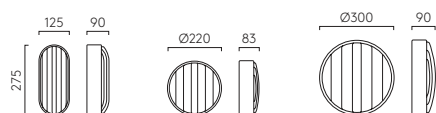

▼ Lamp excluded/La lampe exclu/Das Leuchtmittel ist ausgeschlossen/La lampadina esclusi.
* Ten-year warranty applies/Garantie de dix ans/La garanzia di dieci anni è applicabile/Es gilt eine zehnjährige Garantie.





200 BB



BSS



300 BB



BSS



200 Brushed Stainless Steel

WALL

NEW FINISH - SPRING 2025

AVAILABLE SPRING 2025

Ava Coastal

| | | | | LAMP | WATT | IP | CLASS | |
|-----|----------|----------|--|-------|------------|----|-------|---|
| 200 | 1428002* | 1428020* | | GU10* | 6W max | 44 | | ✓ |
| 300 | 1428004* | 1428021* | | GU10* | 2 x 6W max | 44 | | ✓ |

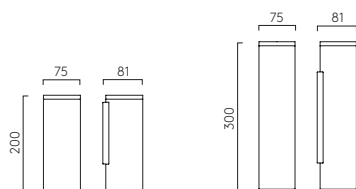

▼ Lamp excluded/La lampe exclu/Das Leuchtmittel ist ausgeschlossen/La lampadina esclusi.

* Ten-year warranty applies/Garantie de dix ans/La garanzia di dieci anni è applicabile/Es gilt eine zehnjährige Garantie.

Suitable for use within five miles (eight km) of the coast or in other onerous environments./Convient pour une utilisation à moins de huit kilomètres de la côte ou dans d'autres environnements difficiles./Geeignet für den Einsatz innerhalb von acht Kilometern Entfernung zur Küste oder in anderen rauen Umgebungen./Adatto per l'uso entro cinque miglia (otto km) dalla costa o in altri ambienti gravosi.



reddot award 2018
winner lighting design



120

Dunbar Coastal

| | LAMP | WATT | INPUT | K | CRI | Lm | IP | CLASS | |
|--------------|--------------|------|----------|------|-----|----|----|-------|---|
| 120 1384019 | Integral LED | 3.9W | 220-240V | 3000 | 90 | 60 | 65 | | ✓ |
| 160 1384020 | Integral LED | 6.3W | 100-240V | 3000 | 90 | 97 | 65 | | ✓ |

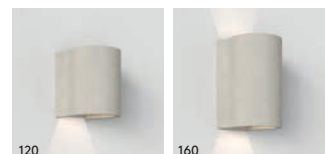
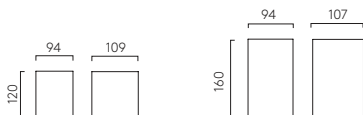

Suitable for use within five miles (eight km) of the coast or in other onerous environments. / Convient pour une utilisation à moins de huit kilomètres de la côte ou dans d'autres environnements difficiles. / Geeignet für den Einsatz innerhalb von acht Kilometern Entfernung zur Küste oder in anderen rauen Umgebungen. / Adatto per l'uso entro cinque miglia (otto km) dalla costa o in altri ambienti gravosi.



Eclipse Coastal

| | LAMP | WATT | INPUT | K | CRI | Lm | IP | CLASS | |
|------------|--------------|-------|----------|------|-----|-----|----|-------|---|
| MC 1333011 | Integral LED | 12.6W | 100-240V | 3000 | 80 | 597 | 44 | □ | ✓ |

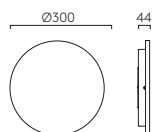

Suitable for use within five miles (eight km) of the coast or in other onerous environments./Convient pour une utilisation à moins de huit kilomètres de la côte ou dans d'autres environnements difficiles / Geeignet für den Einsatz innerhalb von acht Kilometern Entfernung zur Küste oder in anderen rauen Umgebungen./Adatto per l'uso entro cinque miglia (otto km) dalla costa o in altri ambienti gravosi.





AVAILABLE SPRING 2025

Mast Light Coastal

| | LAMP | WATT | IP | CLASS | |
|--------|--|-------|------------|-------|---|
| Single | <input type="checkbox"/> MC 1317006* <input type="checkbox"/> GGB 1317022 <input type="checkbox"/> GGW 1317021 | GU10* | 6W max | 44 | ✓ |
| Twin | <input type="checkbox"/> MC 1317013* | GU10* | 2 x 6W max | 44 | ✓ |







▼ Lamp excluded/La lampe exclu/Das Leuchtmittel ist ausgeschlossen/La lampadina esclusi.

* Ten-year warranty applies/Garantie de dix ans/La garanzia di dieci anni è applicabile/Es gilt eine zehnjährige Garantie.

Suitable for use within five miles (eight km) of the coast or in other onerous environments./Convient pour une utilisation à moins de huit kilomètres de la côte ou dans d'autres environnements difficiles / Geeignet für den Einsatz innerhalb von acht Kilometern Entfernung zur Küste oder in anderen rauen Umgebungen./Adatto per l'uso entro cinque miglia (otto km) dalla costa o in altri ambienti gravosi.



Oslo Coastal

| | | LAMP | WATT | INPUT | K | CRI | Lm | IP | CLASS | |
|-----|--|--------------|------|------------|------|-----|----|----|---|---|
| 120 |  MC 1298019 | Integral LED | 3.9W | Mains 230V | 3000 | 90 | 61 | 65 |  | ✓ |
| 160 |  MC 1298020 | Integral LED | 6.3W | Mains 230V | 3000 | 90 | 96 | 65 |  | ✓ |

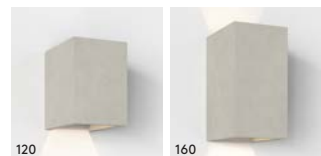
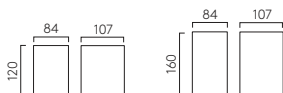

Suitable for use within five miles (eight km) of the coast or in other onerous environments./Convient pour une utilisation à moins de huit kilomètres de la côte ou dans d'autres environnements difficiles./Geeignet für den Einsatz innerhalb von acht Kilometern Entfernung zur Küste oder in anderen rauen Umgebungen./Adatto per l'uso entro cinque miglia (otto km) dalla costa o in altri ambienti gravosi.



Kos Coastal

| | LAMP | WATT | IP | CLASS | |
|-------------|-------|--------|----|-------|---|
| MC 1326014* | GU10* | 6W max | 44 | | ✓ |

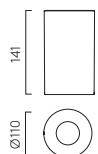

▼ Lamp excluded/La lampe exclu/Das Leuchtmittel ist ausgeschlossen/La lampadina esclusi.

* Ten-year warranty applies/Garantie de dix ans/La garanzia di dieci anni è applicabile/Es gilt eine zehnjährige Garantie.

Suitable for use within five miles (eight km) of the coast or in other onerous environments./Convient pour une utilisation à moins de huit kilomètres de la côte ou dans d'autres environnements difficiles./Geeignet für den Einsatz innerhalb von acht Kilometern Entfernung zur Küste oder in anderen rauen Umgebungen./Adatto per l'uso entro cinque miglia (otto km) dalla costa o in altri ambienti gravosi.





GGB



GGW



AVAILABLE SPRING 2025

Newlyn Surface

| | LAMP | WATT | IP | CLASS | |
|-------------|-------|--------|----|-------|---|
| GGB 1488005 | GU10* | 6W max | 44 | | ✓ |
| GGW 1488006 | | | | | |



- * Lamp excluded/La lampe exclu/Das Leuchtmittel ist ausgeschlossen/La lampadina esclusi.
- * Ten-year warranty applies/Garantie de dix ans/La garanzia di dieci anni è applicabile/Es gilt eine zehnjährige Garantie.



100

Cromarty

| | | LAMP | WATT | INPUT | K | CRI | Lm | IP | CLASS | ☎ | 🌐 |
|-----|---|--------------|-------|----------|------|-----|------|----|-------|------|---|
| 100 |  1378005 | Integral LED | 9W | 220-240V | 3000 | 90 | 510 | 67 | ⚡ | Ø98 | ✓ |
| 120 |  1378004 | Integral LED | 15.2W | 220-240V | 3000 | 90 | 1115 | 67 | ⚡ | Ø111 | ✓ |

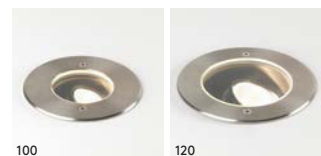
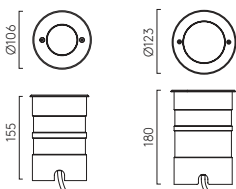



100

120

Suitable for use within five miles (eight km) of the coast or in other onerous environments./Convient pour une utilisation à moins de huit kilomètres de la côte ou dans d'autres environnements difficiles./Geeignet für den Einsatz innerhalb von acht Kilometern Entfernung zur Küste oder in anderen rauen Umgebungen./Adatto per l'uso entro cinque miglia (otto km) dalla costa o in altri ambienti gravosi.



Skye Spike Spot

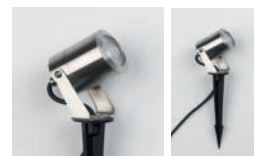
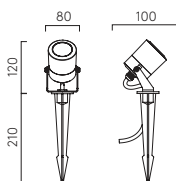

| | LAMP | WATT | INPUT | K | CRI | Lm | IP | CLASS |  |  |
|-------------|--------------|-------|--------|------|-----|-----|----|---|---|---|
| BSS 1386001 | Integral LED | 10.3W | 700mA* | 3000 | 80 | 600 | 65 |  | ✓ | ✓ |



* Driver excluded / Driver d'entrée exclu / Driver esclusi / Das treiber ist ausgeschlossen.

Suitable for use within five miles (eight km) of the coast or in other onerous environments. / Convient pour une utilisation à moins de huit kilomètres de la côte ou dans d'autres environnements difficiles. / Geeignet für den Einsatz innerhalb von acht Kilometern Entfernung zur Küste oder in anderen rauen Umgebungen. / Adatto per l'uso entro cinque miglia (otto km) dalla costa o in altri ambienti gravosi.

LED Modules

| K | CRI | Lm | IP |  |  | DIMENSIONS | CODE |
|-------|-----|------|----|---|---|-------------|---------|
| 2700K | 90 | 1000 | 20 | Yes | 24° | H:52 Ø:50mm | 6033010 |
| 3000K | 90 | 1050 | 20 | Yes | 24° | H:52 Ø:50mm | 6033011 |
| 4000K | 90 | 1100 | 20 | Yes | 24° | H:52 Ø:50mm | 6033012 |
| 4000K | 90 | 1050 | 20 | Yes | 40° | H:52 Ø:50mm | 6033009 |



Accessories

| PRODUCT | DIMENSIONS | CODE |
|---------------------------------|---------------------|---------|
| Firehood 150 | H:150 W:150 D:120mm | 6010001 |
| Firehood 280 | H:250 W:280 D:170mm | 6010005 |
| Firehood 300 | H:300 W:150 D:120mm | 6010003 |
| Firehood 410 | H:190 W:410 D:170mm | 6010004 |
| Insulation Guard Downlight | H:30 W:400 D:0.4mm | 6012002 |
| Insulation Guard Mini Downlight | H:30 W:344 D:0.4mm | 6012003 |
| IP44 Kit | H:106 Ø:70mm | 6014001 |
| LED Connector | H:15 W:10mm | 6007002 |
| Demister Pad | H:400 W:400mm | 6018002 |
| Cable Guide MW | Ø:30mm D:30mm | 6029006 |
| Cable Guide MB | Ø:30mm D:30mm | 6029007 |



FIREHOOD 150
6010001



FIREHOOD 280
6010005



FIREHOOD 300
6010003



FIREHOOD 410
6010004



DOWNLIGHT
6012002



MINI DOWNLIGHT
6012003



IP44 KIT
6014001



LED CONNECTOR
6007002



DEMISTER PAD
6018002



CABLE GUIDE
MW 6029006



CABLE GUIDE
MB 6029007

Fabric Shades

Standard Colours We supply a range of standard fabric shade options to complement our designs. You'll find full details of compatible shades on each of the product pages and on our website.

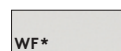

White Fabric



Black Fabric



Oyster Fabric



Putty Fabric



Mocha Fabric

Special Orders Our fabric shades are available in a variety of additional colours and can be ordered on a special basis with a minimum order quantity of 30 pieces.

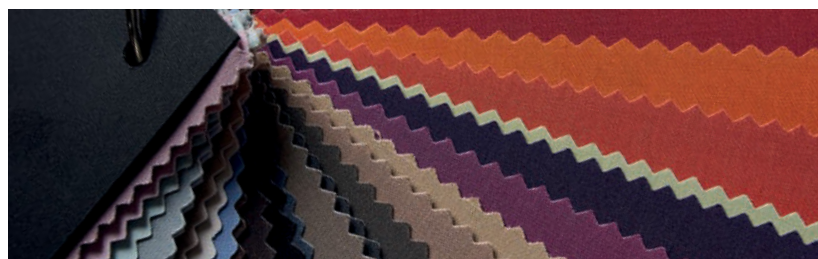

FR Finitions des abat-jours standard: Nous proposons une gamme d'abat-jours standard qui complètent nos modèles. Vous trouverez toutes les informations sur les abat-jours compatibles dans les pages consacrées à chacun de nos produits. Choix de couleurs spéciales: Tous les abat-jours Astro sont disponibles dans une variété de couleurs supplémentaires. Ils peuvent être commandés spécialement en quantité minimale de 30 unités.











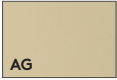
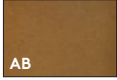
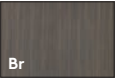



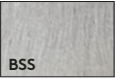







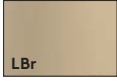

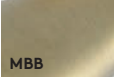
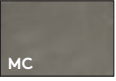

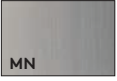
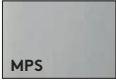

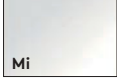
DE Standardausführungen: Wir liefern ein breites Spektrum von Standardschirmen zur Ergänzung unserer Designs. Vollständige Einzelheiten zu kompatiblen Schirmen finden sie auf den jeweiligen Produktseiten. Besondere Farboptionen: Alle Astro-Lampenschirme sind in einer Vielzahl zusätzlicher Farben erhältlich und können auf besonderer Basis mit einer Mindestabnahmemenge von 30 Stück bestellt werden.

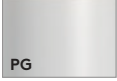
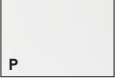
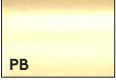
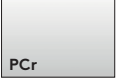
IT Finiture paralume standard: Forniamo una serie di paralumi standard adatti per tutti i progetti. Troverete dettagli sui paralumi compatibili su ognuna delle pagine prodotto. Opzioni colori speciali: Tutti i paralumi Astro sono disponibili in una serie di colori aggiuntivi e possono essere richiesti tramite ordine speciale in numero minimo di 30 pezzi.

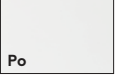
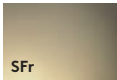



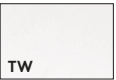







* Please note colours may vary from batch to batch / Merci de noter que les couleurs peuvent varier d'un lot à l'autre / Bitte beachten: Farben können je nach Charge variieren / I colori potrebbero essere diversi a seconda del lotto di produzione.

Finishes

REFERENCE

| | | | | | | | |
|--|---|---|---|--|---|--|--|
|  AA Anodised Aluminium |  AG Anodised Gold |  AB Antique Brass |  Br Bronze |  BAB Brushed Antique Brass |  BB Brushed Brass |  BN Brushed Nickel |  BSS Brushed Stainless Steel |
|  CB Cast Brass |  C Ceramic |  CA Clear Acrylic |  CG Clear Glass |  DS Dark Smoked |  FG Frosted Glass |  GGB Gloss Glaze Black |  GGW Gloss Glaze White |
|  LBr Light Bronze |  MB Matt Black |  MBB Matt Brushed Brass |  MC Matt Concrete |  MG Matt Gold |  MN Matt Nickel |  MPS Matt Painted Silver |  MW Matt White |
|  Mi Mirror |  NB Natural Brass |  PG Pebble Grey |  P Plaster |  PB Polished Brass |  PCr Polished Chrome |  PN Polished Nickel |  Po Porcelain |
|  SFr Dark Smoked Frosted |  SB Solid Brass |  TB Textured Black |  TG Textured Grey |  TW Textured White |  WG White Glass | | |

Symbols

| | | |
|---|---|--|
|  CLASS 1 Classe 1 / Schutzklasse 1 / Classe 1 |  GLASS COMPONENT Verre / Glas / Componente in vetro |  MAGNIFICATION Grossissement / Vergrößerung / Ingrandimento |
|  CLASS 2 Classe 2 / Schutzklasse 2 / Classe 2 |  SMART TOUCH Toucher intelligent / Intelligente Berührung / Tocco intelligente |  BEAM ANGLE Angle de faisceau / Abstrahlwinkel / Angolo del fascio luminoso |
|  CLASS 3 Classe 3 / Schutzklasse 3 / Classe 3 |  MOTION SENSOR Capteur de mouvement / Bewegungssensor / Sensore di movimento |  CUT OUT Découper / Ausgeschnitten / Ritagliare |
|  FIRE-RATED Résistant au feu / Schwer entflammbar / Ignifugo |  SWITCHED with on/off switch or pull cord / avec interrupteur / mit An- / Ausschalter oder Zugschalter / con interruttore on/off o a tirante |  PHOTOMETRIC DATA Please refer to astrolighting.com for photometric data / Veuillez consulter astrolighting.com pour les données photométriques / Bitte beziehen Sie sich für fotometrische Daten auf astrolighting.com / Fare riferimento a astrolighting.com per i dati fotometrici. |
|  DIMMABLE Dimmable / Dimmbar / Dimmerabile | | |

| | | | | | | | | | | | |
|---------|----------------------------|-----|---------|---------|---------------------------|-----|---------|---------|-------------------------|-------|--------|
| 1021001 | Tube | PCh | 64 | 1084034 | Palermo 900 | PCh | 28 | 1163008 | Niimi | Mi | 75 |
| 1032005 | Montreal Round 220 | TB | 160/343 | 1084037 | Palermo 900 | MB | 28 | 1166001 | Ashino | WF | 139 |
| 1032006 | Montreal Round 300 | TB | 160/343 | 1084038 | Palermo 600 | MB | 28 | 1166002 | Ashino Wide | WF | 139 |
| 1032007 | Montreal Oval | TB | 160/343 | 1087007 | Cabaret Four | MB | 29 | 1168001 | Sagara | PCh | 46 |
| 1032011 | Montreal Round 220 | BSS | 160/343 | 1087008 | Cabaret Five | MB | 29 | 1168003 | Sagara | MB | 46 |
| 1032012 | Montreal Round 300 | BSS | 160/343 | 1087009 | Cabaret Four | PCh | 29 | 1172001 | Pero | P | 214 |
| 1032013 | Montreal Oval | BSS | 160/343 | 1087010 | Cabaret Five | PCh | 29 | 1173001 | Mosto | P | 215 |
| 1032018 | Montreal Coastal Round 300 | BB | 389 | 1089001 | Tokyo | WG | 223 | 1174003 | Kashima 350 | PCh | 69 |
| 1032019 | Montreal Coastal Oval | BB | 389 | 1089002 | Tokyo Switched | WG | 223 | 1174004 | Kashima 620 | PCh | 69 |
| 1038001 | Denver | PCh | 89 | 1095010 | Homefield Pendant 240 | TB | 295/375 | 1175001 | Tango | MW | 71/357 |
| 1038005 | Denver | MB | 89 | 1095015 | Homefield Pendant 360 | TB | 295/375 | 1175002 | Tango | BSS | 71/357 |
| 1044001 | Dayton | PCh | 69 | 1095021 | Homefield Ceiling | TB | 376 | 1175004 | Tango | TB | 71/357 |
| 1047001 | Bari | PCh | 64 | 1095029 | Homefield Wall 160 | Br | 324 | 1176003 | Zeppo Pendant 400 | MW | 291 |
| 1047004 | Bari | MN | 64 | 1095033 | Homefield Pendant 450 | TB | 295/375 | 1176004 | Zeppo Wall | PCh | 67/224 |
| 1047006 | Bari | MB | 64 | 1095035 | Homefield Pendant 240 | NB | 295/375 | 1176008 | Zeppo Reader | MW | 200 |
| 1047008 | Bari | MG | 64 | 1095036 | Homefield Pedestal | TB | 369 | 1176009 | Zeppo Reader | MB | 200 |
| 1049001 | Arezzo Wall | PCh | 59 | 1095039 | Homefield Wall 160 Sensor | TB | 324 | 1176010 | Zeppo Reader | Br | 200 |
| 1049003 | Arezzo Ceiling | PCh | 87 | 1095040 | Homefield Wall 130 | TB | 324 | 1176011 | Zeppo Ceiling | PCh | 88/277 |
| 1050001 | Roma | PCh | 58 | 1095041 | Homefield Wall 160 | TB | 324 | 1176017 | Zeppo Ceiling | MB | 88/277 |
| 1050007 | Roma | MB | 58 | 1096001 | Montparnasse Wall | PN | 336 | 1176019 | Zeppo Portable | MB | 235 |
| 1050009 | Roma | MG | 58 | 1096004 | Montparnasse Pendant | PN | 373 | 1176022 | Zeppo Portable | LBr | 235 |
| 1058002 | Enna Floor | MW | 251 | 1096009 | Montparnasse Wall | Br | 336 | 1176026 | Zeppo Portable | PGr | 235 |
| 1058003 | Enna Floor | MB | 251 | 1096010 | Montparnasse Pendant | Br | 373 | 1176047 | Zeppo Wall | MB | 67/224 |
| 1058005 | Enna Desk | MW | 250 | 1105001 | Nena | PCh | 65 | 1178006 | Salerno 350 | NB | 33/326 |
| 1058006 | Enna Desk | MB | 250 | 1106001 | Anton | PCh | 57 | 1178009 | Salerno 350 | TB | 33/326 |
| 1058013 | Enna Surface | MN | 191 | 1106006 | Anton | MB | 57 | 1178010 | Salerno 520 | TB | 33/326 |
| 1058018 | Enna Square Switched | MN | 190 | 1106007 | Anton | PB | 57 | 1178011 | Salerno 520 LED | TB | 33/326 |
| 1058024 | Enna Square Switched | MB | 190 | 1115007 | Goya 460 LED | BN | 226 | 1178012 | Salerno 350 LED | TB | 33/326 |
| 1058027 | Enna Surface | MB | 191 | 1115008 | Goya 460 LED | PCh | 226 | 1183018 | Messina 130 | Br | 325 |
| 1058030 | Enna Square Switched | MG | 190 | 1115009 | Goya 760 LED | BN | 226 | 1183023 | Messina 160 | Br | 325 |
| 1058032 | Enna Swing | MW | 188 | 1115010 | Goya 760 LED | PCh | 226 | 1183026 | Messina 160 | Br/Fr | 325 |
| 1058033 | Enna Swing | MB | 188 | 1115012 | Goya 460 LED | BAB | 226 | 1183027 | Messina Twin | TB | 325 |
| 1058056 | Enna Swing | MN | 188 | 1115013 | Goya 760 LED | BAB | 226 | 1183028 | Messina 200 | TB | 325 |
| 1058057 | Enna Desk | MN | 250 | 1121005 | Mashiko Square 300 | PCh | 85/273 | 1183029 | Messina 130 | TB | 325 |
| 1058058 | Enna Floor | MN | 251 | 1121006 | Mashiko Classic 360 | PCh | 32 | 1183030 | Messina 160 | TB/Fr | 325 |
| 1058062 | Enna Recess Switched | MW | 192 | 1121009 | Mashiko Square 200 | PCh | 85/273 | 1183031 | Messina 160 | TB | 325 |
| 1058065 | Enna Recess Switched | MN | 192 | 1121010 | Mashiko Square 400 | PCh | 85/273 | 1183032 | Messina 160 Sensor | TB | 325 |
| 1058067 | Enna Recess Switched | MB | 192 | 1121013 | Mashiko Square 400 | Br | 85/273 | 1184009 | Pendant Kit 3 | MB | 287 |
| 1058084 | Enna Surface | Br | 191 | 1121017 | Mashiko Round 300 | PCh | 85/273 | 1184010 | Pendant Kit 3 Knurled | MN | 287 |
| 1058085 | Enna Square Switched | Br | 190 | 1121021 | Mashiko Round 230 | PCh | 85/273 | 1184011 | Pendant Kit 3 | Br | 287 |
| 1058088 | Enna Recess Switched | Br | 192 | 1121026 | Mashiko Round 400 | PCh | 85/273 | 1184014 | Track Pendant Kit | MW | 318 |
| 1058105 | Enna Swing | MG | 188 | 1121037 | Mashiko Classic 360 | MG | 32 | 1184015 | Track Pendant Kit | MB | 318 |
| 1058106 | Enna Desk | MG | 250 | 1121043 | Mashiko Round 300 | Br | 85/273 | 1184020 | Pendant Kit 4 | MB | 288 |
| 1058107 | Enna Floor | MG | 251 | 1121055 | Mashiko Classic 360 | Br | 32 | 1184021 | Pendant Kit 4 | Br | 288 |
| 1058108 | Enna Surface | MG | 191 | 1121056 | Mashiko Square 200 | Br | 85/273 | 1184022 | Pendant Kit 4 Knurled | MN | 288 |
| 1058192 | Enna Twin | MB | 193 | 1121079 | Mashiko Square 300 | Br | 85/273 | 1185001 | Napoli | MN | 134 |
| 1058194 | Enna Twin | MW | 193 | 1121085 | Mashiko Round 400 | Br | 85/273 | 1185003 | Napoli Reader | MN | 181 |
| 1058195 | Enna Twin | MN | 193 | 1121097 | Mashiko Round 230 | Br | 85/273 | 1186001 | Cyl 200 | WG | 225 |
| 1058196 | Enna Twin | MG | 193 | 1121102 | Mashiko 600 LED | Br | 32 | 1186002 | Cyl 260 | WG | 225 |
| 1058197 | Enna Twin | Br | 193 | 1125014 | Mallon LED | PCh | 93/275 | 1187003 | Parma 210 | P | 208 |
| 1058210 | Enna Desk USB | MB | 250 | 1125015 | Mallon LED | MN | 93/275 | 1187005 | Parma 200 | P | 209 |
| 1058212 | Enna Desk USB | MW | 250 | 1125016 | Mallon LED | Br | 93/275 | 1187009 | Parma 110 | P | 208 |
| 1058213 | Enna Desk USB | MN | 250 | 1129001 | Dakota 300 | PCh | 92 | 1187027 | Parma 625 LED | P | 209 |
| 1058214 | Enna Desk USB | MG | 250 | 1131004 | Soprano Wall | TB | 367 | 1193004 | Tressino | TB | 339 |
| 1058225 | Enna Surface | MW | 191 | 1131006 | Soprano Ballard | TB | 368 | 1194003 | Monza Classic 250 | PCh | 38 |
| 1058226 | Enna Square Switched | MW | 190 | 1133002 | Altea 300 | PCh | 92 | 1196001 | Pienza 140 | P | 211 |
| 1058246 | Enna Surface USB | MB | 189 | 1134001 | Denia | PCh | 91 | 1196003 | Pienza 165 | P | 211 |
| 1058247 | Enna Surface USB | MG | 189 | 1137003 | Catena | PCh | 75 | 1201005 | Terra 28 | BSS | 71/361 |
| 1058249 | Enna Surface USB | MW | 189 | 1138008 | Fosso | MN | 203 | 1201007 | Terra 42 | AA | 71/361 |
| 1060017 | Kyoto | MB | 60 | 1138011 | Fosso | Br | 203 | 1202004 | Beam One | MPS | 359 |
| 1060018 | Kyoto | PCh | 60 | 1140001 | Cube | PCh | 66 | 1202005 | Beam Two | MPS | 359 |
| 1074001 | Luga | WG | 225 | 1143001 | Padova | PCh | 62 | 1212001 | Borgo 55 2700K | MW | 233 |
| 1079001 | Amalfi | C | 221 | 1143008 | Padova | MB | 62 | 1212004 | Borgo 90 2700K | MW | 233 |
| 1080044 | Park Lane | Br | 136 | 1147001 | Verona | PCh | 65 | 1212007 | Borgo Trimless 35 3000K | MW | 232 |
| 1080045 | Park Lane Grande | Br | 137 | 1155001 | Koza | P | 212 | 1212008 | Borgo Trimless 65 3000K | MW | 232 |
| 1080046 | Park Lane Table | Br | 262 | 1157001 | Tosca | MN | 198 | 1212019 | Borgo 54 LED 3000K | MW | 70 |
| 1080047 | Park Lane Floor | Br | 263 | 1157003 | Tosca | PCh | 198 | 1212019 | Borgo 54 2700K | MW | 233 |
| 1080051 | Park Lane Reader | Br | 182 | 1157007 | Tosca | MG | 198 | 1212021 | Borgo 55 3000K | MW | 233 |
| 1084033 | Palermo 600 | PCh | 28 | 1157012 | Tosca | Br | 198 | 1212024 | Borgo 90 3000K | MW | 233 |

| | | | | | | | | | | | |
|---------|-------------------------------|--------|--------|---------|--------------------------------|----|--------|---------|---------------------------|-----|--------|
| 1212027 | Borgo Trimless 35 2700K | MW | 232 | 1249012 | Minima Round Fixed IP65 | MW | 99/304 | 1286126 | Ascoli Twin | TW | 316 |
| 1212028 | Borgo Trimless 65 2700K | MW | 232 | 1249015 | Minima Round Fixed | MB | 304 | 1286127 | Ascoli Triple Bar | TW | 317 |
| 1212033 | Borgo 54 LED 2700K | MW | 70 | 1249016 | Minima Round Adj | MB | 304 | 1286128 | Ascoli Triple Bar | MB | 317 |
| 1212033 | Borgo 54 3000K | MW | 233 | 1249017 | Minima Round Fixed IP65 | MB | 99/304 | 1286129 | Ascoli Triple Bar | MN | 317 |
| 1212037 | Borgo Trimless Mini 2700K | MW | 232 | 1249018 | Minima Square Fixed IP65 | MW | 99/305 | 1286130 | Ascoli Triple Bar | Br | 317 |
| 1212038 | Borgo Trimless 200 3000K | MW | 232 | 1249023 | Minima Round Fixed LED | MW | 99/304 | 1286131 | Ascoli Four Bar | TW | 317 |
| 1212039 | Borgo Trimless Mini 3000K | MW | 232 | 1249028 | Minima Round Twin Adj | MW | 304 | 1286133 | Ascoli Four Bar | MN | 317 |
| 1212040 | Borgo Trimless 200 2700K | MW | 232 | 1249029 | Minima Round Twin Adj | MB | 304 | 1286134 | Ascoli Four Bar | Br | 317 |
| 1214001 | Riva 350 | PCh | 53/133 | 1249034 | Minima Round Slimline Fixed | MW | 99/304 | 1286137 | Ascoli Swing Plug-in | TW | 186 |
| 1214004 | Riva 350 | MN | 53/133 | 1249035 | Minima Round Slimline Fixed | MB | 99/304 | 1286138 | Ascoli Swing Plug-in | MB | 186 |
| 1214010 | Riva 350 | Br | 53/133 | 1249036 | Minima Round Slimline 25 | MW | 99/304 | 1286149 | Ascoli Track Spot | MG | 318 |
| 1214015 | Riva 350 | MB | 53/133 | 1249037 | Minima Round Slimline 25 | MB | 99/304 | 1286155 | Ascoli Floor | Br | 249 |
| 1215082 | Fuse 3 USB-A | MB | 196 | 1249038 | Minima Square Slimline Fixed | MW | 99/305 | 1286156 | Ascoli Floor | MB | 249 |
| 1215084 | Fuse 3 USB-A | MN | 196 | 1249039 | Minima Square Slimline Fixed | MB | 99/305 | 1286157 | Ascoli Floor | MW | 249 |
| 1215085 | Fuse 3 USB-A | Br | 196 | 1249040 | Minima Slimline Adj Fire-rated | MW | 304 | 1287002 | Bologna 240 | P | 217 |
| 1215103 | Fuse 3 USB-A | MG | 196 | 1249041 | Minima Slimline Adj Fire-rated | MB | 304 | 1292001 | Sabina 170 | PCh | 91 |
| 1215122 | Fuse 3 | MW | 196 | 1249042 | Minima Slimline Adj Fire-rated | MW | 305 | 1292003 | Sabina 280 | PCh | 91 |
| 1215123 | Fuse 3 | MB | 196 | 1249043 | Minima Slimline Adj Fire-rated | MB | 305 | 1295002 | Leo | MB | 203 |
| 1215125 | Fuse 3 | MN | 196 | 1249052 | Minima Round Mini | MW | 304 | 1295003 | Leo | Br | 203 |
| 1215126 | Fuse 3 | Br | 196 | 1249054 | Minima Round Mini | MB | 304 | 1296001 | 3-Way Plate | MW | 271 |
| 1215127 | Fuse 3 | MG | 196 | 1252003 | Osca 140 Fixed | P | 309 | 1296002 | 4-Way Plate | MW | 271 |
| 1215143 | Fuse 3 USB-C | Br | 196 | 1252006 | Osca 140 Adj | P | 309 | 1297001 | Lago 280 | PCh | 54/141 |
| 1215144 | Fuse 3 USB-C | MB | 196 | 1252011 | Osca 200 Fixed | P | 309 | 1297002 | Lago 280 | MN | 54/141 |
| 1215145 | Fuse 3 USB-C | MG | 196 | 1252014 | Osca Pendant 400 | P | 293 | 1297007 | Lago 280 | Br | 54/141 |
| 1215146 | Fuse 3 USB-C | MN | 196 | 1253002 | Blanco Square Fixed | P | 302 | 1297009 | Lago 280 | MB | 54/141 |
| 1215147 | Fuse 3 USB-C | MW | 196 | 1253004 | Blanco Round Fixed | P | 302 | 1298002 | Oslo 160 | TB | 345 |
| 1215148 | Fuse 3 Toggle | Br | 196 | 1253005 | Blanco Round Adj | P | 302 | 1298004 | Oslo 100 | TB | 345 |
| 1215149 | Fuse 3 Toggle | MB | 196 | 1253006 | Blanco Twin Adj | P | 302 | 1298005 | Oslo 100 | TW | 345 |
| 1215151 | Fuse 3 Toggle | MN | 196 | 1253007 | Blanco Square Adj | P | 302 | 1298006 | Oslo 160 | TW | 345 |
| 1218001 | Marasino | P | 265 | 1286001 | Ascoli Single | TW | 316 | 1298007 | Oslo 255 | TB | 345 |
| 1221001 | Limina | P | 265 | 1286002 | Ascoli Triple Round | TW | 317 | 1298009 | Oslo 255 | TW | 345 |
| 1222007 | Ravello Table | PCh | 260 | 1286004 | Ascoli Single | Br | 316 | 1298019 | Oslo Coastal 120 | MC | 396 |
| 1222008 | Ravello Table | MN | 260 | 1286005 | Ascoli Triple Round | Br | 317 | 1298020 | Oslo Coastal 160 | MC | 396 |
| 1222009 | Ravello Table | Br | 260 | 1286009 | Ascoli Single Switched | Br | 316 | 1299001 | Milo 300 | C | 222 |
| 1222012 | Ravello Wall | PCh | 135 | 1286010 | Ascoli Single Switched | TW | 316 | 1299002 | Milo 400 | C | 222 |
| 1222013 | Ravello Wall | MN | 135 | 1286011 | Ascoli Single Switched | MN | 316 | 1300001 | Aria 300 | P | 207 |
| 1222018 | Ravello LED Reader | PCh | 183 | 1286012 | Ascoli Triple Round | MN | 317 | 1301001 | Kyo | C | 221 |
| 1222019 | Ravello LED Reader | MN | 183 | 1286015 | Ascoli Single | MN | 316 | 1305006 | Dio | PCh | 63 |
| 1222020 | Ravello LED Reader | Br | 183 | 1286016 | Ascoli Desk | MW | 248 | 1306001 | Calvi Wall 215 | TB | 331 |
| 1222040 | Ravello Wall | Br | 135 | 1286017 | Ascoli Desk | MN | 248 | 1306003 | Calvi Pendant 215 | TB | 374 |
| 1222091 | Ravello Floor | Br | 261 | 1286022 | Ascoli Recessed | TW | 316 | 1306005 | Calvi Wall 215 | AB | 331 |
| 1222092 | Ravello Floor | MN | 261 | 1286023 | Ascoli Recessed | Br | 316 | 1306011 | Calvi Wall 305 | TB | 331 |
| 1222093 | Ravello Floor | PCh | 261 | 1286024 | Ascoli Desk | Br | 248 | 1306013 | Calvi Pendant 305 | TB | 374 |
| 1223002 | Joel Table | MB | 244 | 1286033 | Ascoli Track Spot | TW | 318 | 1308006 | Artemis 600 | PCh | 27 |
| 1223005 | Joel Floor | MB | 245 | 1286052 | Ascoli Track Spot | TB | 318 | 1310002 | Chios 80 | TB | 344 |
| 1224013 | Atelier Wall | MB | 171 | 1286059 | Ascoli Five Bar | TW | 317 | 1310004 | Chios 150 | TB | 344 |
| 1224016 | Atelier Grande Wall | MB | 172 | 1286060 | Ascoli Five Bar | Br | 317 | 1310005 | Chios 80 | TW | 344 |
| 1224061 | Atelier Desk | MB | 242 | 1286061 | Ascoli Five Bar | MN | 317 | 1310006 | Chios 150 | TW | 344 |
| 1229003 | Vancouver Round | CA/PCh | 100 | 1286065 | Ascoli Swing | TW | 186 | 1310007 | Chios 80 | TG | 344 |
| 1229012 | Vancouver Round 90 | CA/PCh | 100 | 1286066 | Ascoli Swing | MN | 186 | 1310008 | Chios 150 | TG | 344 |
| 1240024 | Taro Round Fixed | MW | 303 | 1286067 | Ascoli Swing | Br | 186 | 1312001 | Gramos Round | BSS | 360 |
| 1240026 | Taro Square Fixed | MW | 303 | 1286078 | Ascoli Single | MB | 316 | 1312003 | Gramos Square | BSS | 360 |
| 1240028 | Taro Round Adj | MW | 303 | 1286079 | Ascoli Single Switched | MB | 316 | 1312008 | Gramos Round | SB | 360 |
| 1240030 | Taro Square Adj | MW | 303 | 1286080 | Ascoli Recessed | MN | 316 | 1312009 | Gramos Square | SB | 360 |
| 1240032 | Taro Square Twin Adj | MW | 303 | 1286082 | Ascoli Triple Round | MB | 317 | 1315001 | Pella 325 | P | 211 |
| 1248005 | Trimless Square Fixed | MW | 97/301 | 1286084 | Ascoli Four Bar | MB | 317 | 1315002 | Pella 190 | P | 211 |
| 1248010 | Trimless Round Adj LED | MW | 300 | 1286085 | Ascoli Five Bar | MB | 317 | 1317003 | Mast Light Single | AB | 348 |
| 1248017 | Trimless Round Slimline Fixed | MW | 97/300 | 1286086 | Ascoli Desk | MB | 248 | 1317006 | Mast Light Coastal Single | MC | 395 |
| 1248018 | Trimless Square Fixed | MW | 301 | 1286088 | Ascoli Swing | MB | 186 | 1317007 | Mast Light Single | TG | 348 |
| 1248019 | Trimless Round Slimline Adj | MW | 300 | 1286095 | Ascoli Recessed | MB | 316 | 1317011 | Mast Light Single | TB | 348 |
| 1248020 | Trimless Square Adj | MW | 301 | 1286095 | Ascoli Flush Fire-rated | TW | 316 | 1317012 | Mast Light Single | TW | 348 |
| 1248021 | Trimless Round Twin Adj | MW | 300 | 1286096 | Ascoli Flush Fire-rated | MB | 316 | 1317013 | Mast Light Coastal Twin | MC | 395 |
| 1248022 | Trimless Square Twin Adj | MW | 301 | 1286097 | Ascoli Twin Recessed | TW | 316 | 1317017 | Mast Light Twin | AB | 348 |
| 1248023 | Trimless Round Fixed | MW | 300 | 1286098 | Ascoli Twin Recessed | Br | 316 | 1317018 | Mast Light Twin | TB | 348 |
| 1248024 | Trimless Round Adj | MW | 300 | 1286099 | Ascoli Twin Recessed | MN | 316 | 1317021 | Mast Light Coastal Single | GGW | 395 |
| 1248025 | Trimless Round Mini | MW | 300 | 1286100 | Ascoli Twin Recessed | MB | 316 | 1317022 | Mast Light Coastal Single | GGB | 395 |
| 1249002 | Minima Round Fixed | MW | 304 | 1286124 | Ascoli Twin | MB | 316 | 1318009 | Lima | Br | 129 |
| 1249003 | Minima Round Adj | MW | 304 | 1286125 | Ascoli Twin | Br | 316 | 1323042 | Digit | Br | 197 |
| 1249005 | Minima Round Fixed LED | TW | 304 | 1286125 | Ascoli Twin | MN | 316 | 1323043 | Digit | MB | 197 |

| | | | | | | | | | | | |
|---------|-------------------------|-----|--------|---------|----------------------------|-----|--------|---------|------------------------------|-----|--------|
| 1323044 | Digit | MG | 197 | 1372003 | Dartmouth Single LED | TB | 349 | 1396024 | Can 50 Single | MW | 313 |
| 1323045 | Digit | MN | 197 | 1372006 | Dartmouth Twin LED | TB | 349 | 1396025 | Can 50 Single | MB | 313 |
| 1323046 | Digit | PCh | 197 | 1372010 | Dartmouth Single | TG | 349 | 1396026 | Can 50 Track Spot | MW | 318 |
| 1326014 | Kos Coastal | MC | 397 | 1372011 | Dartmouth Single | TB | 349 | 1396027 | Can 50 Track Spot | MB | 318 |
| 1326039 | Kos Round 85 | MW | 95/379 | 1372013 | Dartmouth Twin | TG | 349 | 1396028 | Can 50 Recessed | MW | 313 |
| 1326040 | Kos Round 85 | TB | 95/379 | 1372014 | Dartmouth Twin | TB | 349 | 1396029 | Can 50 Recessed | MB | 313 |
| 1326041 | Kos Round 85 | TG | 95/379 | 1372015 | Dartmouth Spot Single | TB | 351 | 1396030 | Can 75 Track Spot | MW | 318 |
| 1326042 | Kos Round 85 | PCh | 95/379 | 1372016 | Dartmouth Spot Twin | TB | 351 | 1396031 | Can 75 Track Spot | MB | 318 |
| 1326043 | Kos Square 85 | MW | 95/379 | 1372017 | Dartmouth Spike Spot | TB | 365 | 1396034 | Can 100 Track Spot | MW | 318 |
| 1326044 | Kos Square 85 | TB | 95/379 | 1373020 | Mascoli | PCh | 77 | 1396035 | Can 100 Track Spot | MB | 318 |
| 1326061 | Kos Round 100 LED | TW | 95/379 | 1373022 | Mascoli | MB | 77 | 1399023 | Yuma 240 | TB | 153 |
| 1326062 | Kos Round 100 LED | TB | 95/379 | 1374032 | Mondrian 400 Frame Mounted | Br | 229 | 1399025 | Yuma 240 | Br | 153 |
| 1326067 | Kos Round 140 LED | TW | 95/379 | 1374034 | Mondrian 600 Frame Mounted | Br | 229 | 1399027 | Yuma 300 | TB | 153 |
| 1326068 | Kos Round 140 LED | TB | 95/379 | 1374036 | Mondrian 400 | Br | 229 | 1399029 | Yuma 300 | Br | 153 |
| 1326075 | Kos Round 85 | SB | 379 | 1374038 | Mondrian 600 | Br | 229 | 1400003 | Portree Wall | SB | 338 |
| 1326080 | Kos Recessed | MW | 381 | 1374039 | Mondrian 400 Frame Mounted | MB | 229 | 1401009 | Bayville Spike Spot 12V | TB | 362 |
| 1326081 | Kos Recessed | TB | 381 | 1374040 | Mondrian 600 Frame Mounted | MB | 229 | 1401015 | Bayville Spot Single | TB | 352 |
| 1328001 | Syros | WG | 93 | 1374041 | Mondrian 400 | MB | 229 | 1401018 | Bayville Spot Twin | TB | 352 |
| 1331001 | Elis Single | TB | 347 | 1374042 | Mondrian 600 | MB | 229 | 1401021 | Bayville Spike Spot | TB | 362 |
| 1331002 | Elis Twin | TB | 347 | 1375009 | Jura Single | SB | 161 | 1401023 | Bayville Spike Spot 900 | TB | 362 |
| 1331013 | Elis Twin | SB | 347 | 1375009 | Jura Single | SB | 354 | 1401024 | Bayville Spike Spot 900 Twin | TB | 362 |
| 1333011 | Eclipse Coastal | MC | 393 | 1375010 | Jura Twin | SB | 161 | 1402006 | Harvard Wall 500 | NB | 327 |
| 1333019 | Eclipse Round 250 2700K | P | 218 | 1375010 | Jura Twin | SB | 354 | 1402007 | Harvard Wall | NB | 31/327 |
| 1333020 | Eclipse Round 250 3000K | P | 218 | 1375011 | Jura Surface | SB | 378 | 1402009 | Harvard Wall | Br | 31/327 |
| 1333025 | Eclipse Round 350 2700K | P | 218 | 1375012 | Jura Spike Spot | SB | 366 | 1402011 | Harvard Lantern | TB | 334 |
| 1333026 | Eclipse Round 350 3000K | P | 218 | 1375013 | Jura Single Spot | SB | 353 | 1402013 | Harvard Pendant | TB | 372 |
| 1334007 | Tate | Br | 131 | 1376005 | Thurso Round | CB | 340 | 1402017 | Harvard Wall | TB | 31/327 |
| 1335001 | Kymi 220 | P | 213 | 1376006 | Thurso Oval | CB | 44 | 1403006 | Lynx | MB | 312 |
| 1335003 | Kymi 300 | P | 213 | 1376006 | Thurso Oval | CB | 340 | 1403007 | Lynx | MW | 312 |
| 1338001 | Tivola | TB | 358 | 1378004 | Cromarty 120 | BSS | 400 | 1403009 | Lynx Recess | MW | 312 |
| 1338003 | Tivola | AB | 358 | 1378005 | Cromarty 100 | BSS | 400 | 1406002 | Side by Side | MB | 178 |
| 1338009 | Tivola | TG | 358 | 1380013 | Versailles 370 | PCh | 37/159 | 1406003 | Side by Side | MN | 178 |
| 1340004 | Richmond Lantern 200 | TB | 332 | 1380014 | Versailles 370 | Br | 37/159 | 1406004 | Side by Side | Br | 178 |
| 1340011 | Richmond Lantern 254 | TB | 332 | 1380024 | Versailles 250 | PCh | 37/159 | 1406012 | Side by Side Grande USB | Br | 179 |
| 1340013 | Richmond Wall 235 | TB | 333 | 1380025 | Versailles 250 | Br | 37/159 | 1406013 | Side by Side Grande USB | MB | 179 |
| 1340014 | Richmond Wall 285 | TB | 333 | 1380026 | Versailles 250 | MG | 37/159 | 1406014 | Side by Side Grande USB | MN | 179 |
| 1342002 | Leros Trimless | MW | 230 | 1380029 | Versailles 400 | PCh | 37/159 | 1407001 | Micro Recess Unswitched | MW | 194 |
| 1349010 | Caserta | Br | 130 | 1380030 | Versailles 400 | Br | 37/159 | 1407002 | Micro Recess Unswitched | MB | 194 |
| 1350001 | Serifos 170 LED 3000K | P | 216 | 1380031 | Versailles 400 | MG | 37/159 | 1407003 | Micro Recess Switched | MB | 194 |
| 1350002 | Serifos 170 LED 2700K | P | 216 | 1380040 | Versailles 370 | MG | 37/159 | 1407004 | Micro Recess Unswitched | Br | 194 |
| 1350003 | Serifos 220 | P | 216 | 1380082 | Versailles 600 | Br | 37/159 | 1407005 | Micro Recess Unswitched | MG | 194 |
| 1352018 | Edge Reader Mini | MW | 201 | 1380083 | Versailles 600 | MG | 37/159 | 1407006 | Micro Recess Switched | MW | 194 |
| 1352040 | Edge Reader Mini | Br | 201 | 1380084 | Versailles 600 | PCh | 37/159 | 1407008 | Micro Recess Switched | MN | 194 |
| 1352041 | Edge Reader Mini | MB | 201 | 1384003 | Dunbar 100 | TB | 346 | 1407009 | Micro Recess Switched | Br | 194 |
| 1352042 | Edge Reader Mini | MN | 201 | 1384004 | Dunbar 160 | TB | 346 | 1407010 | Micro Recess Switched | MG | 194 |
| 1353001 | Bronte | TB | 377 | 1384005 | Dunbar 255 | TB | 346 | 1409003 | io Wall 265 | PCh | 39/155 |
| 1354003 | Box Lantern 270 | TB | 328 | 1384019 | Dunbar Coastal 120 | MC | 392 | 1409004 | io Pendant | PCh | 290 |
| 1354004 | Box Lantern 350 | TB | 328 | 1384020 | Dunbar Coastal 160 | MC | 392 | 1409055 | io Wall 420 | PCh | 39/155 |
| 1354007 | Box Lantern 450 | TB | 328 | 1386001 | Skye Spike Spot | BSS | 401 | 1409056 | io Wall 420 | MB | 39/155 |
| 1361001 | Ginestra 300 | MB | 294 | 1388001 | Beauville | PCh | 55/140 | 1409057 | io Wall 420 | MG | 39/155 |
| 1361002 | Ginestra 400 | MB | 294 | 1388003 | Beauville | Br | 55/140 | 1409058 | io Wall 665 | PCh | 39/155 |
| 1361011 | Ginestra 300 | MW | 294 | 1391001 | Kea Round 150 | TW | 341 | 1409059 | io Wall 665 | MB | 39/155 |
| 1361012 | Ginestra 400 | MW | 294 | 1391002 | Kea Round 150 | TB | 341 | 1409060 | io Wall 665 | MG | 39/155 |
| 1366002 | Farringdon | TB | 330 | 1391003 | Kea Round 250 | TW | 341 | 1409062 | io Pendant | MB | 290 |
| 1367003 | Backplate 3 | MW | 138 | 1391004 | Kea Round 250 | TB | 341 | 1411001 | Ottavino Wall | PCh | 42/145 |
| 1368003 | Cabin Wall | AB | 45/337 | 1392017 | Void 55 | MW | 96/299 | 1411002 | Ottavino Pendant | PCh | 78 |
| 1368008 | Cabin Wall Frosted | AB | 45/337 | 1392019 | Void 80 | MW | 96/299 | 1411006 | Ottavino Wall | MB | 42/145 |
| 1368025 | Cabin Wall | Br | 45/337 | 1393001 | Aqua Single | MW | 101 | 1412001 | Cut | MW | 264 |
| 1368026 | Cabin Wall Frosted | Br | 45/337 | 1393002 | Aqua Triple Round | MW | 101 | 1412003 | Cut | Br | 264 |
| 1369006 | Coach 130 | TB | 328 | 1393007 | Aqua Recessed | MW | 101 | 1413001 | Pimlico 400 | TB | 335 |
| 1370002 | Boston 370 | PCh | 30/157 | 1394001 | Mitsu Swing Arm | MN | 171 | 1413002 | Pimlico 400 | Br | 335 |
| 1370004 | Boston 370 | Br | 30/157 | 1394002 | Mitsu Swing Arm | Br | 171 | 1413003 | Pimlico 400 | AB | 335 |
| 1370012 | Boston 600 | Br | 30/157 | 1394003 | Mitsu Wall | MN | 170 | 1413004 | Pimlico 500 | TB | 335 |
| 1371025 | Renoir 350 | Br | 227 | 1394004 | Mitsu Wall | Br | 170 | 1413005 | Pimlico 500 | Br | 335 |
| 1371027 | Renoir 520 | Br | 227 | 1394009 | Mitsu Table | MN | 256 | 1413006 | Pimlico 500 | AB | 335 |
| 1371029 | Renoir 680 | Br | 227 | 1394010 | Mitsu Table | Br | 256 | 1414002 | Shadow 300 | P | 210 |
| 1371030 | Renoir 350 | MBB | 227 | 1394058 | Mitsu Floor | Br | 257 | 1414003 | Shadow Surface 150 | P | 308 |
| 1371031 | Renoir 520 | MBB | 227 | 1394059 | Mitsu Floor | MB | 257 | 1417001 | Velo 280 | P | 206 |
| 1371032 | Renoir 680 | MBB | 227 | 1394060 | Mitsu Floor | MN | 257 | 1417002 | Velo 2390 | P | 206 |

| | | | | | | | | | | | |
|---------|-------------------------------|-----|--------|---------|----------------------------------|-----|--------|---------|----------------------|--------|--------|
| 1419005 | Incline | SB | 356 | 1434004 | Pinhole Square Slimline Sq Adj | MW | 298 | 1455002 | Veo | Br | 146 |
| 1421001 | Cambria 380 | WF | 268 | 1434005 | Pinhole Square Twin Adj | MW | 298 | 1455005 | Veo Pendant 180 | Br | 283 |
| 1421002 | Cambria 380 | PF | 268 | 1434007 | Pinhole Round Slimline Flush | MW | 98/298 | 1455006 | Veo Pendant 230 | Br | 283 |
| 1421004 | Cambria 480 | WF | 268 | 1434008 | Pinhole Round Slimline Flush Adj | MW | 298 | 1456001 | Taiko 300 | MB | 274 |
| 1421005 | Cambria 480 | PF | 268 | 1434037 | Venn Table Reader | Br | 258 | 1456002 | Taiko 400 | MB | 274 |
| 1421007 | Cambria 580 | WF | 268 | 1435001 | Lucca Surface | MB | 202 | 1456005 | Taiko 300 | MW | 274 |
| 1421008 | Cambria 580 | PF | 268 | 1435002 | Lucca Surface | MN | 202 | 1456006 | Taiko 400 | MW | 274 |
| 1421012 | Cambria Pendant | MW | 289 | 1435003 | Lucca Surface | MG | 202 | 1456009 | Taiko Pendant | MB | 285 |
| 1421013 | Cambria Pendant | MN | 289 | 1435004 | Lucca Surface | Br | 202 | 1456010 | Taiko Pendant | MW | 285 |
| 1422001 | Apollo Single | TW | 314 | 1435009 | Lucca Recessed | MB | 202 | 1457001 | Leda Floor | MB | 247 |
| 1422002 | Apollo Single | MB | 314 | 1435010 | Lucca Recessed | MN | 202 | 1457002 | Leda Desk | MB | 246 |
| 1422016 | Apollo 100 Recessed | TW | 314 | 1435011 | Lucca Recessed | MG | 202 | 1457003 | Leda Single | MB | 187 |
| 1422017 | Apollo 100 Recessed | MB | 314 | 1435012 | Lucca Recessed | Br | 202 | 1457004 | Leda Swing Arm | MB | 187 |
| 1422022 | Apollo 100 Track Spot | TW | 318 | 1437001 | Keta USB-A | MN | 195 | 1459001 | Ortona Single | PCh | 61 |
| 1422023 | Apollo 100 Track Spot | MB | 318 | 1437004 | Keta USB-A | MB | 195 | 1459002 | Ortona Twin | PCh | 61 |
| 1424001 | Orb | PCh | 74 | 1437005 | Keta USB-A | MW | 195 | 1459005 | Ortona Single | MB | 61 |
| 1424002 | Orb Single | PCh | 74 | 1437007 | Keta USB-A | MG | 195 | 1459006 | Ortona Twin | MB | 61 |
| 1424003 | Orb | MB | 74 | 1437008 | Keta USB-A | Br | 195 | 1460001 | Imari Desk | Br/Po | 238 |
| 1424004 | Orb Single | MB | 74 | 1437019 | Keta Non-USB | Br | 195 | 1460002 | Imari Fixed | Br/Po | 165 |
| 1426002 | Myos | TB | 363 | 1437020 | Keta Non-USB | MB | 195 | 1460003 | Imari Adjustable | Br/Po | 165 |
| 1427001 | Avignon Round 375 | Br | 154 | 1437021 | Keta Non-USB | MG | 195 | 1460004 | Imari Desk | MN/Po | 238 |
| 1427002 | Avignon Round 375 | AB | 154 | 1437037 | Keta USB-C | Br | 195 | 1460005 | Imari Fixed | MN/Po | 165 |
| 1427003 | Avignon Round 525 | Br | 154 | 1437038 | Keta USB-C | MB | 195 | 1460006 | Imari Adjustable | MN/Po | 165 |
| 1427004 | Avignon Round 525 | AB | 154 | 1437039 | Keta USB-C | MG | 195 | 1461001 | Toro | CG | 144 |
| 1427009 | Avignon Square 300 | Br | 154 | 1437040 | Keta USB-C | MN | 195 | 1462001 | Ceiling Base 290 | MW | 267 |
| 1427010 | Avignon Square 300 | AB | 154 | 1437041 | Keta USB-C | MW | 195 | 1462002 | Ceiling Base 410 | MW | 267 |
| 1427011 | Avignon Square 500 | Br | 154 | 1437042 | Keta USB-C | PCh | 195 | 1462003 | Ceiling Base 460 | MW | 267 |
| 1427012 | Avignon Square 500 | AB | 154 | 1438001 | Parallel | C | 222 | 1463001 | Salina 400 | WF | 270 |
| 1428002 | Ava Coastal 200 | BSS | 391 | 1439001 | Blend | P | 219 | 1463002 | Salina 550 | WF | 270 |
| 1428002 | Ava Coastal 200 | BB | 391 | 1440001 | Atticus 600 | PCh | 26 | 1463003 | Salina 400 | PF | 270 |
| 1428004 | Ava Coastal 300 | BSS | 391 | 1440002 | Atticus 900 | PCh | 26 | 1463004 | Salina 550 | PF | 270 |
| 1428005 | Ava 200 | TB | 342 | 1440005 | Atticus 600 | MB | 26 | 1464001 | Nara | PCh | 79 |
| 1428009 | Ava 300 | TB | 342 | 1440006 | Atticus 900 | MB | 26 | 1464003 | Nara | MB | 79 |
| 1428013 | Ava 400 | TB | 344 | 1441001 | Edward Wall | MB | 166 | 1465001 | Gerrit | AG | 239 |
| 1428017 | Ava 300 | SB | 342 | 1441002 | Edward Twin | MB | 167 | 1466001 | Mori 140 | TB | 355 |
| 1428021 | Ava Coastal 300 | BB | 391 | 1441003 | Edward Desk | MB | 240 | 1466002 | Mori 250 | TB | 355 |
| 1429001 | Tacoma Single | PCh | 49/149 | 1441013 | Edward Wall Switched | MB | 166 | 1467003 | Carlton Desk | Po | 237 |
| 1429002 | Tacoma Twin | PCh | 49/149 | 1441017 | Edward Floor | MB | 241 | 1467004 | Carlton Wall | Po | 163 |
| 1429003 | Tacoma Single Grande | PCh | 49/149 | 1442001 | Hashira 300 | MB | 152 | 1467007 | Carlton Wall Plug-in | Po | 163 |
| 1429004 | Tacoma Single | MB | 49/149 | 1442004 | Hashira Pendant | MB | 292 | 1468001 | Halo Portable | MB | 234 |
| 1429005 | Tacoma Twin | MB | 49/149 | 1442005 | Hashira 300 | MN | 152 | 1468002 | Halo Portable | MW | 234 |
| 1429006 | Tacoma Single Grande | MB | 49/149 | 1442006 | Hashira 300 | MG | 152 | 1468003 | Halo Portable | LBr | 234 |
| 1429007 | Tacoma Single | AB | 49/149 | 1442011 | Hashira Pendant | MN | 292 | 1469001 | Elba Wall 400 | WF | 151 |
| 1429008 | Tacoma Twin | AB | 49/149 | 1442012 | Hashira Pendant | MG | 292 | 1469002 | Elba Wall 400 | PF | 151 |
| 1429009 | Tacoma Single Grande | AB | 49/149 | 1444001 | Miura Wall | MB | 168 | 1469003 | Elba Wall 600 | WF | 151 |
| 1429024 | Tacoma Pendant | AB | 81/281 | 1444002 | Miura Wall | MN | 168 | 1469004 | Elba Wall 600 | PF | 151 |
| 1429025 | Tacoma Pendant | MB | 81/281 | 1444003 | Miura Wall | MG | 168 | 1470001 | Ella Table | MB/Po | 236 |
| 1429026 | Tacoma Pendant | PCh | 81/281 | 1444004 | Miura Swing Arm | MB | 169 | 1470002 | Ella Table | LBr/Po | 236 |
| 1429027 | Tacoma Surface | MB | 83/279 | 1444005 | Miura Swing Arm | MN | 169 | 1470003 | Ella Wall | MB/Po | 147 |
| 1429028 | Tacoma Surface | AB | 83/279 | 1444006 | Miura Swing Arm | MG | 169 | 1470004 | Ella Wall | LBr/Po | 147 |
| 1429029 | Tacoma Surface | PCh | 83/279 | 1444007 | Miura Desk USB | MN | 243 | 1471001 | Fife 530 | WF | 269 |
| 1430001 | Kuro 250 | TB | 370 | 1444008 | Miura Desk USB | MG | 243 | 1471002 | Fife 530 | PF | 269 |
| 1430002 | Kuro 450 | TB | 370 | 1446001 | Ito | MW | 162 | 1471003 | Fife 430 | WF | 269 |
| 1431001 | Amas 320 | C | 220 | 1446002 | Ito | MB | 162 | 1471004 | Fife 430 | PF | 269 |
| 1432001 | Amat 320 | C | 220 | 1447001 | Nagoya | MB | 76 | 1471005 | Fife 330 | WF | 269 |
| 1433003 | Venn Wall | Br | 128 | 1447002 | Nagoya | PCh | 76 | 1471006 | Fife 330 | PF | 269 |
| 1433005 | Venn Reader Single | Br | 180 | 1450001 | Aquina Wall | PCh | 50 | 1472001 | Lyra Single | GW | 47 |
| 1433006 | Venn Reader Twin | Br | 180 | 1450002 | Aquina Wall | MB | 50 | 1472003 | Lyra Ceiling 140 | GW | 86 |
| 1433007 | Venn Wall | MN | 128 | 1450003 | Aquina Ceiling 240 | PCh | 90/276 | 1472004 | Lyra Ceiling 180 | GW | 86 |
| 1433009 | Venn Reader Single | MN | 180 | 1450004 | Aquina Ceiling 360 | PCh | 90/276 | 1473007 | Gio | MB | 185 |
| 1433010 | Venn Reader Twin | MN | 180 | 1450009 | Aquina Ceiling 240 | MB | 90/276 | 1473008 | Gio | MW | 185 |
| 1433025 | Venn Floor | Br | 259 | 1450011 | Aquina Ceiling 360 | MB | 90/276 | 1474001 | Ottawa | MB | 94/306 |
| 1433026 | Venn Floor | MN | 259 | 1451001 | Conic | PCh | 51 | 1474002 | Ottawa | MW | 94/306 |
| 1433035 | Venn Table | Br | 258 | 1451002 | Conic | MB | 51 | 1475012 | Baton | MB | 199 |
| 1433036 | Venn Table | MN | 258 | 1453001 | Elena | PCh | 52 | 1475013 | Baton | MN | 199 |
| 1433038 | Venn Table Reader | MN | 258 | 1453003 | Elena | MB | 52 | 1476002 | Serge | MW | 164 |
| 1434001 | Pinhole Round Slimline Fixed | MW | 98/298 | 1454001 | Millie | PCh | 43 | 1476003 | Serge | MB | 164 |
| 1434002 | Pinhole Square Slimline Fixed | MW | 98/298 | 1454003 | Millie | MB | 43 | 1477001 | Burlington 400 | Br | 35 |
| 1434003 | Pinhole Round Slimline Adj | MW | 298 | 1455001 | Veo | MN | 146 | 1477003 | Burlington 400 | MG | 35 |

| | | | | | | | | | | | |
|---------|---------------------------|-------|-----|---------|-------------------------|----|--------|---------|----------------------------------|----|-----|
| 1477005 | Burlington 600 | Br | 35 | 5013026 | Tapered Drum 155 shade | MG | 166 | 5041001 | Curve Glass 220 shade | DS | 287 |
| 1477007 | Burlington 600 | MG | 35 | 5013027 | Tapered Drum 155 shade | WF | 166 | 5041002 | Curve Glass 285 shade | DS | 287 |
| 1478001 | Koto Single | MB | 315 | 5013028 | Tapered Drum 155 shade | BF | 166 | 5041003 | Curve Glass 220 shade | CG | 287 |
| 1478002 | Koto Single Switched | MB | 315 | 5013029 | Tapered Drum 155 shade | PF | 166 | 5041004 | Curve Glass 285 shade | CG | 287 |
| 1478003 | Koto Recessed | MB | 315 | 5014001 | Oval 285 shade | WF | 134 | 5042001 | Elba Round 450 | WF | 267 |
| 1478004 | Koto Track Spot | MB | 318 | 5014003 | Oval 285 shade | OF | 134 | 5042002 | Elba Round 450 | PF | 267 |
| 1478005 | Koto Triple Round | MB | 315 | 5014004 | Oval 285 shade | PF | 134 | 5042003 | Elba Round 600 | WF | 267 |
| 1478006 | Koto Triple Bar | MB | 315 | 5015004 | Tube 135 shade | WF | 135 | 5042004 | Elba Round 600 | PF | 267 |
| 1478007 | Koto Four Bar | MB | 315 | 5015006 | Tube 135 shade | OF | 135 | 5042007 | Elba Square 350 | WF | 267 |
| 1478008 | Koto Five Bar | MB | 315 | 5015007 | Tube 135 shade | PF | 135 | 5042008 | Elba Square 350 | PF | 267 |
| 1478009 | Koto Single | MW | 315 | 5016004 | Drum 200 shade | WF | 261 | 5042009 | Elba Square 500 | WF | 267 |
| 1478010 | Koto Single Switched | MW | 315 | 5016007 | Drum 250 shade | WF | 135 | 5042010 | Elba Square 500 | PF | 267 |
| 1478011 | Koto Recessed | MW | 315 | 5016009 | Drum 250 shade | OF | 135 | 5043001 | Stadium 160 shade | PF | 128 |
| 1478012 | Koto Track Spot | MW | 318 | 5016019 | Drum 250 shade | PF | 135 | 5043002 | Stadium 160 shade | WF | 128 |
| 1478013 | Koto Triple Round | MW | 315 | 5016020 | Drum 200 shade | WF | 183 | 5043003 | Stadium 220 shade | PF | 258 |
| 1478014 | Koto Triple Bar | MW | 315 | 5016022 | Drum 200 shade | OF | 183 | 5043004 | Stadium 220 shade | WF | 258 |
| 1478015 | Koto Four Bar | MW | 315 | 5016028 | Drum 420 shade | PF | 261 | 5043005 | Stadium 300 shade | PF | 259 |
| 1478016 | Koto Five Bar | MW | 315 | 5016029 | Drum 200 shade | PF | 183 | 5043006 | Stadium 300 shade | WF | 259 |
| 1479001 | Arbor | MB | 132 | 5018001 | Cone 195 shade | WF | 54/141 | 5047001 | French Drum 220 shade | PF | 125 |
| 1479002 | Arbor | MW | 132 | 5018004 | Cone 240 shade | WF | 53/133 | 5047002 | French Drum 220 shade | WF | 125 |
| 1480003 | Beaumont Table | MB | 253 | 5018007 | Cone 240 shade | WG | 53/133 | 5047003 | French Drum 330 shade | PF | 253 |
| 1480008 | Beaumont Floor | MB | 253 | 5018014 | Cone 240 shade | PF | 53/133 | 5047004 | French Drum 330 shade | WF | 253 |
| 1480013 | Beaumont Wall | MB | 125 | 5018031 | Cone 173 shade | WF | 170 | 5047005 | French Drum 440 shade | PF | 253 |
| 1480018 | Beaumont Reader | MB | 175 | 5018033 | Cone 173 shade | OF | 170 | 5047006 | French Drum 440 shade | WF | 253 |
| 1481014 | Ako 420 | MB/MG | 150 | 5018034 | Cone 173 shade | PF | 170 | 6001002 | Mirror Mounting Kit 2 | | 68 |
| 1481015 | Ako 420 | MW/MG | 150 | 5018035 | Cone 180 shade | WF | 178 | 6001003 | Mirror Mounting Kit 1 | | 68 |
| 1481017 | Ako 600 | MB/MG | 150 | 5018037 | Cone 180 shade | PF | 178 | 6013001 | Borgo 55 Wall Box | | 233 |
| 1481018 | Ako 600 | MW/MG | 150 | 5018046 | Cone 195 shade | NB | 54/141 | 6013002 | Borgo 90 Wall Box | | 233 |
| 1483001 | Club Table | Br | 255 | 5018052 | Cone 105 shade | MB | 168 | 6020001 | 1m Track | MW | 319 |
| 1483002 | Club Floor | Br | 255 | 5018053 | Cone 105 shade | MN | 168 | 6020002 | 2m Track | MW | 319 |
| 1483010 | Club Wall | Br | 127 | 5018054 | Cone 105 shade | MG | 168 | 6020003 | End Cap | MW | 319 |
| 1483011 | Club Reader | Br | 177 | 5019001 | Cone 195 shade | WG | 54/141 | 6020004 | End to End Connector | MW | 319 |
| 1484001 | Nomad | TB | 371 | 5021001 | Bevel Round 600 | WF | 271 | 6020005 | Live End | MW | 319 |
| 1484002 | Nomad | TW | 371 | 5021003 | Bevel Round 450 | WF | 271 | 6020006 | Left Corner Connector | MW | 319 |
| 1485001 | Liberty Wall | MB | 41 | 5021009 | Bevel Round 600 | PF | 271 | 6020007 | Right Corner Connector | MW | 319 |
| 1485002 | Liberty Wall | PB | 41 | 5021011 | Bevel Round 450 | PF | 271 | 6020009 | 1m Track | MB | 319 |
| 1485003 | Liberty Wall | PCh | 41 | 5026001 | Semi Drum 320 shade | WF | 129 | 6020010 | 2m Track | MB | 319 |
| 1486001 | Ascot 650 Round | Mi | 73 | 5026002 | Semi Drum 320 shade | BF | 129 | 6020011 | End Cap | MB | 319 |
| 1486002 | Ascot 700 | Mi | 73 | 5026005 | Semi Drum 320 shade | PF | 129 | 6020012 | End to End Connector | MB | 319 |
| 1486003 | Ascot 800 | Mi | 73 | 5028001 | ios 250 shade | WF | 139 | 6020013 | Live End | MB | 319 |
| 1487001 | Juno Recessed | Br | 311 | 5028003 | ios 250 shade | OF | 139 | 6020014 | Left Corner Connector | MB | 319 |
| 1487002 | Juno Single | Br | 311 | 5033002 | Cone 138 shade | PF | 140 | 6020015 | Right Corner Connector | MB | 319 |
| 1487003 | Juno Triple Bar | Br | 311 | 5033003 | Cone 138 shade | OF | 140 | 6020017 | Central Live Connector | MW | 319 |
| 1487004 | Juno Four Bar | Br | 311 | 5033004 | Cone 138 shade | WF | 140 | 6020018 | Central Live Connector | MB | 319 |
| 1487005 | Juno Recessed | MBB | 311 | 5033005 | Beauville Glass shade | WG | 55 | 6020019 | X Connector | MW | 319 |
| 1487006 | Juno Single | MBB | 311 | 5034001 | Tapered Oval shade | WF | 137 | 6020020 | X Connector | MB | 319 |
| 1487007 | Juno Triple Bar | MBB | 311 | 5034003 | Tapered Oval shade | OF | 137 | 6020021 | T Connector Right Nearside Earth | MW | 319 |
| 1487008 | Juno Four Bar | MBB | 311 | 5034004 | Tapered Oval shade | PF | 137 | 6020022 | T Connector Right Nearside Earth | MB | 319 |
| 1488001 | Newlyn Wall Single | GGB | 387 | 5035003 | Tapered Round 250 shade | WF | 178 | 6020023 | T Connector Right Farside Earth | MW | 319 |
| 1488002 | Newlyn Wall Single | GGW | 387 | 5035004 | Tapered Round 250 shade | BF | 178 | 6020024 | T Connector Right Farside Earth | MB | 319 |
| 1488003 | Newlyn Wall Twin | GGW | 387 | 5035005 | Tapered Round 250 shade | PF | 178 | 6020025 | T Connector Left Nearside Earth | MW | 319 |
| 1488004 | Newlyn Wall Twin | GGB | 387 | 5036001 | Tacoma Round shade | WG | 49/149 | 6020026 | T Connector Left Nearside Earth | MB | 319 |
| 1488005 | Newlyn Surface | GGB | 399 | 5036003 | Tacoma Round shade | WR | 49/149 | 6020027 | T Connector Left Farside Earth | MW | 319 |
| 1488006 | Newlyn Surface | GGW | 399 | 5036004 | Tacoma Round shade | CR | 49/149 | 6020028 | T Connector Left Farside Earth | MB | 319 |
| 1489001 | Luna | WFr | 143 | 5036005 | Tacoma Round shade | SR | 49/149 | 6020040 | 2x1m Track | MW | 319 |
| 1489002 | Luna | SFr | 143 | 5036007 | Tacoma Tulip shade | WG | 49/149 | 6020041 | 2x1m Track | MB | 319 |
| 1489003 | Luna | SG | 143 | 5036008 | Tacoma Tulip shade | SR | 49/149 | 6030003 | Harvard Frosted Glass accessory | Fr | 334 |
| 1490001 | Comino 155 | P | 205 | 5036009 | Tacoma Reed shade | WG | 49/149 | 6034001 | Myos Extension Pole accessory | TB | 363 |
| 1490002 | Comino 320 | P | 205 | 5036010 | Tacoma Reed shade | SR | 49/149 | | | | |
| 1707003 | Micro Recess Unswitched | MN | 194 | 5038001 | Cambria 500 shade | WF | 289 | | | | |
| 5001001 | Rectangle 285 shade | WF | 137 | 5038002 | Cambria 600 shade | WF | 289 | | | | |
| 5001002 | Rectangle 400 shade | WF | 263 | 5038004 | Cambria 500 shade | PF | 289 | | | | |
| 5001003 | Rectangle 285 shade | BF | 137 | 5038006 | Cambria 600 shade | PF | 289 | | | | |
| 5001007 | Rectangle 285 shade | OF | 137 | 5038007 | Cambria 180 shade | WF | 138 | | | | |
| 5001017 | Rectangle 285 shade | PF | 137 | 5038008 | Cambria 180 shade | OF | 138 | | | | |
| 5001030 | Rectangle 400 shade | PF | 263 | 5038009 | Cambria 180 shade | PF | 138 | | | | |
| 5013020 | Tapered Pendant 320 shade | WF | 287 | 5040001 | Leda shade | MB | 187 | | | | |
| 5013022 | Tapered Pendant 320 shade | PF | 287 | 5040004 | Leda shade | MB | 187 | | | | |
| 5013024 | Tapered Drum 155 shade | MB | 166 | 5040005 | Leda shade | MG | 187 | | | | |

| | | | | | | | |
|-----------------------|---------|----------------------|------------|--------------------------------|---------|------------------------------|------------|
| A | | Dartmouth Spike Spot | 365 | Kymi | 213 | Pendant Suspension Kit 3 | 287 |
| Ako | 150 | Dartmouth Spot | 351 | Kyo | 221 | Pendant Suspension Kit 4 | 288 |
| Altea | 92 | Dayton | 69 | Kyoto | 60 | Pero | 214 |
| Amalfi | 221 | Denia | 91 | L | | Pienza | 211 |
| Amas | 220 | Denver | 89 | Lago | 54/141 | Pimlico | 335 |
| Amat | 220 | Digit | 197 | Leda Desk | 246 | Pinhole | 98/298 |
| Anton | 57 | Dio | 63 | Leda Floor | 247 | Portree Wall | 338 |
| Apollo | 314 | Dunbar 100 | 346 | Leda Swing Arm | 187 | R | |
| Apollo 100 Track Spot | 318 | Dunbar Coastal 160 | 392 | Leo | 203 | Ravello Floor | 261 |
| Aqua | 101 | E | | Leros Trimless | 230 | Ravello LED Reader | 183 |
| Aquina Ceiling | 90/276 | Eclipse Coastal | 393 | Liberty Wall | 41 | Ravello Table | 260 |
| Aquina Wall | 50 | Eclipse Round | 218 | Lima | 129 | Ravello Wall | 135 |
| Arbor | 132 | Edge Reader Mini | 201 | Limina | 265 | Renoir | 227 |
| Arezzo Ceiling | 87 | Edward Desk | 240 | Lucca | 202 | Richmond Lantern | 332 |
| Arezzo Wall | 59 | Edward Floor | 241 | Luga | 225 | Richmond Wall | 333 |
| Aria | 207 | Edward Twin | 167 | Luna | 143 | Riva | 53/133 |
| Artemis | 27 | Edward Wall | 166 | Lynx | 312 | Roma | 58 |
| Ascoli | 316/317 | Elba Ceiling | 267 | Lyra | 47 | S | |
| Ascoli Desk | 248 | Elba Wall | 151 | Lyra Ceiling | 86 | Sabina | 91 |
| Ascoli Floor | 249 | Elena | 52 | M | | Sagara | 46 |
| Ascoli Swing | 186 | Elis Single | 347 | Mallon LED | 93/275 | Salerno | 33/326 |
| Ascoli Track Spot | 318 | Ella Table | 236 | Marasino | 265 | Salina | 270 |
| Ascot | 73 | Ella Wall | 147 | Mascalì | 77 | Serge | 164 |
| Ashino | 139 | Enna Desk | 250 | Mashiko | 32 | Serifos | 216 |
| Atelier Desk | 242 | Enna Floor | 251 | Mashiko Round/Square | 85/273 | Shadow | 210 |
| Atelier Grande Wall | 172 | Enna Recess Switched | 192 | Mast Light Coastal Twin | 395 | Shadow Surface | 308 |
| Atelier Wall | 171 | Enna Square Switched | 190 | Mast Light Single | 348 | Side by Side | 178 |
| Atticus | 26 | Enna Surface | 191 | Messina | 325 | Side by Side Grande USB | 179 |
| Ava | 344 | Enna Surface USB | 189 | Micro Recess | 194 | Skye Spike Spot | 401 |
| Ava Coastal | 391 | Enna Swing | 188 | Millie | 43 | Soprano Bollard | 368 |
| Avignon | 154 | Enna Twin | 193 | Milo | 222 | Soprano Wall | 367 |
| B | | F | | Minima | 99/305 | Syros | 93 |
| Bari | 64 | Farringdon | 330 | Minima Slimline Adj Fire-rated | 305 | T | |
| Baton | 199 | Fife | 269 | Mitsu Floor | 257 | Tacoma | 49/149 |
| Bayville Spike Spot | 362 | Fosso | 203 | Mitsu Swing Arm | 171 | Tacoma Pendant | 81/281 |
| Bayville Spot | 352 | Fuse | 196 | Mitsu Table | 256 | Tacoma Surface | 83/279 |
| Beam One | 359 | G | | Mitsu Wall | 170 | Taiko | 274 |
| Beaumont Floor | 253 | Gerrit | 239 | Miura Desk USB | 243 | Taiko Pendant | 285 |
| Beaumont Reader | 175 | Ginestra | 294 | Miura Swing Arm | 169 | Tango | 71/231/357 |
| Beaumont Table | 253 | Gio | 185 | Miura Wall | 168 | Taro Square Twin Adj | 303 |
| Beaumont Wall | 125 | Goya | 226 | Mondrian | 229 | Tate | 131 |
| Beauville | 55/140 | Gramos Round | 360 | Montparnasse Pendant | 373 | Terra | 71/100/361 |
| Bevel | 271 | H | | Montparnasse Wall | 336 | Thurso | 44 |
| Blanco | 302 | Halo Portable | 234 | Montreal Coastal | 389 | Thurso Round | 340 |
| Blend | 219 | Harvard Lantern | 334 | Montreal | 160/343 | Tivola | 358 |
| Bologna | 217 | Harvard Pendant | 372 | Monza | 38 | Tokyo | 223 |
| Borgo | 70/233 | Harvard Wall | 31/156/327 | Mori | 355 | Toro | 144 |
| Borgo Trimless | 232 | Hashira | 152 | Mosto | 215 | Tosca | 198 |
| Boston | 30/157 | Hashira Pendant | 292 | Myos | 363 | Track Pendant Suspension Kit | 318 |
| Box Lantern | 328 | Homefield Ceiling | 376 | N | | Tressino | 339 |
| Bronte | 377 | Homefield Pedestal | 369 | Nagoya | 76 | Trimless | 97/301 |
| Burlington | 35 | Homefield Pendant | 295/375 | Napoli | 134 | Tube | 64 |
| C | | Homefield Wall | 324 | Napoli Reader | 181 | V | |
| Cabaret | 29 | I | | Nara | 79 | Vancouver | 100 |
| Cabin Wall | 45/337 | Imari Desk | 238 | Nena | 65 | Velo | 206 |
| Calvi Pendant 215 | 374 | Imari Fixed | 165 | Newlyn Surface | 399 | Venn Floor | 259 |
| Calvi Wall 215 | 331 | Incline | 356 | Newlyn Wall | 387 | Venn Reader | 180 |
| Cambria 580 | 268 | io Pendant | 290 | Niimi | 75 | Venn Table/Reader | 258 |
| Cambria Pendant | 289 | io Wall | 39/155 | Nomad | 371 | Venn Wall | 128 |
| Can 100 Track Spot | 318 | Ito | 162 | O | | Veo | 146 |
| Can | 313 | J | | Orb | 74 | Veo Pendant | 283 |
| Carlton Desk | 237 | Joel Floor | 245 | Ortona | 61 | Verona | 65 |
| Carlton Wall | 163 | Joel Table | 244 | Osca | 309 | Versailles | 37/159 |
| Caserta | 130 | Juno | 311 | Osca Pendant | 293 | Void | 96/299 |
| Catena | 75 | Jura | 161 | Oslo | 345 | Y | |
| Chios 150 | 344 | Jura Single | 354 | Oslo Coastal | 396 | Yuma | 153 |
| Club Floor | 255 | Jura Single Spot | 353 | Ottavino Pendant | 78 | Z | |
| Club Reader | 177 | Jura Spike Spot | 366 | Ottavino Wall | 42/145 | Zeppo Ceiling | 88/277 |
| Club Table | 255 | Jura Surface | 378 | Ottawa | 94/306 | Zeppo Pendant | 291 |
| Club Wall | 127 | K | | P | | Zeppo Portable | 235 |
| Coach 130 | 328 | Kashima | 69 | Padova | 62 | Zeppo Reader | 200 |
| Comino | 205 | Kea | 341 | Palermo | 28 | Zeppo Wall | 67/224 |
| Conic | 51 | Keta | 195 | Parallel | 222 | | |
| Cromarty | 400 | Kos | 95/307/379 | Park Lane | 136 | | |
| Cube | 66 | Kos Coastal | 397 | Park Lane Floor | 263 | | |
| Cut | 264 | Kos Recessed | 381 | Park Lane Grande | 137 | | |
| Cyl | 225 | Koto | 315 | Park Lane Reader | 182 | | |
| D | | Koto Track Spot | 318 | Park Lane Table | 262 | | |
| Dakota | 92 | Koza | 212 | Parma | 208/209 | | |
| Dartmouth Single | 349 | Kuro | 370 | Pella | 211 | | |



Design Rights

The majority of products shown in this catalogue have been designed by Astro Lighting Limited, which retains the ownership of all design rights in these Astro-designed products. Astro Lighting has a policy of constant product improvement, and whilst every care has been taken in the production of this catalogue, products supplied may differ in detail from the illustrations, images and descriptions given and therefore these descriptions and illustrations shall not form part of any contract. Details of alterations will be provided on request. Astro Lighting only use LEDs from the leading manufacturers. Nevertheless, colour temperatures can vary between batches and between manufacturers.

FR La majorité des produits présents dans ce catalogue ont été créés par Astro Lighting Ltd qui en détient tous les droits. Astro Lighting mène une politique d'amélioration constante de ses produits. De ce fait et, bien que le plus grand soin ait été apporté à la réalisation de ce catalogue, les produits fournis peuvent différer dans le détail des illustrations, des images et des descriptions fournies et, par conséquent ces descriptions et illustrations ne font pas partie de tout contrat. La description des éventuelles modifications peut être obtenue sur simple demande. Astro Lighting utilise exclusivement des LEDs de fabricants reconnus. Néanmoins les températures de couleur peuvent varier d'un fabricant à l'autre et d'un lot à l'autre.

DE La majorité des produits présents dans ce catalogue ont été créés par Astro Lighting Ltd qui en détient tous les droits. Astro Lighting mène une politique d'amélioration constante de ses produits. De ce fait et, bien que le plus grand soin ait été apporté à la réalisation de ce catalogue, les produits fournis peuvent différer dans le détail des illustrations, des images et des descriptions fournies et, par conséquent ces descriptions et illustrations ne font pas partie de tout contrat. La description des éventuelles modifications peut être obtenue sur simple demande. Astro Lighting utilise exclusivement des LEDs de fabricants reconnus. Néanmoins les températures de couleur peuvent varier d'un fabricant à l'autre et d'un lot à l'autre. La majorité des produits présents dans ce catalogue ont été créés par Astro Lighting Ltd qui en détient tous les droits.

IT La maggior parte dei prodotti illustrati nel presente catalogo è stata ideata da Astro Lighting Limited che detiene tutti i diritti di progettazione di tali prodotti Astro. Astro Lighting ha adottato da sempre una politica di costante sviluppo del prodotto ed ha elaborato questo catalogo con estrema cura ed attenzione. Prodotti forniti possono essere diversi nei dettagli dalle illustrazioni, le immagini e le descrizioni riportate e quindi queste descrizioni e le illustrazioni non fanno parte di alcun contratto. I dettagli delle modifiche verranno forniti su richiesta. Astro Lighting utilizza solamente LED di prima qualità. La temperatura di colore del LED potrebbe essere diversa a seconda dei lotti e dei produttori.

Astro Lighting Limited is registered with Recolight Ltd under the Waste Electrical and Electronic (Producer Responsibility) Regulations 2015.
WEEE producer registration no: WEE/KG0073UG



Global Locations

United Kingdom

The Astro Building
Unit 2, River Way
Harlow CM20 2GJ
astrolighting.com

Germany

astrolighting.com/de

North America

us.astrolighting.com

Italy

astrolighting.com/it

Enquiries

customerservice@astrolighting.com

To find all our international distributors please visit our website/Um unsere internationalen Fachhändler zu finden, besuchen Sie bitte unsere Website/Pour trouver tous nos revendeurs internationaux, veuillez consulter notre site web/Per localizzare tutti i nostri partner internazionali visita il nostro sito web.



With Thanks

Adventures in Furniture
Allermuir
Another Brand
Another Country
AYTM
Bert & May
Carl Hansen & Son
Case Furniture
Cera London
Choosing Keeping
Conran Shop
CP Hart
Derek Wilson
Dominik McHenry
Ex.T
french connection
George Smith
Goss & Genus
Hay
John Lewis
Kirby Design
Knots Rugs
Kristina Krogh
Larusi
Lyngby Porcelain
M.A.H
Made by Folk
Made in Ratio
Mandarin Stone
Mass Productions
Menu
Monologue
Moroso
Mourne Textiles
Muuto
Nor11
Piglet in Bed
Places & Spaces
Preedy Glass
Salvatori
Saunders Fine Art
Skagerak
Stitch by Stitch
Society Limonta
Soft Store
Stilleben
Studio Ore
Studioilse
The Poured Project
Triangle store
Uhlala
Viaduct
Vitra
Vola
Zanat

Styling & Photography

Sania Pell
Hannah Bort
Laura Fulmine
Hannah Franklin
Hannah Simmons

Beth Evans
Howard Lay
Jake Curtis
David Vintiner

