

LIGHTING  
LIGHTING  
LIGHTING  
LIGHTING  
LIGHTING  
LIGHTING  
LIGHTING  
LIGHTING  
LIGHTING  
LIGHTING

zafferano

# Lighting

CATALOGO / CATALOG

## **Zafferano Lampes-à-porter: luce ovunque serva.**

Le lampade ricaricabili Zafferano superano la tradizione, offrendo una luce versatile per ogni ambiente, anche quelli privi di corrente elettrica: dal giardino al salone storico, dal ristorante alla terrazza. Spesso adatte anche all'uso outdoor, si adattano a qualsiasi contesto grazie all'ampia gamma di colori e al design essenziale. Intensità e temperatura di colore sono regolabili intuitivamente, grazie a pulsanti e controlli "touch".

Pensate per durare nel tempo, tutte le lampade ricaricabili Zafferano sono garantite per tre anni, assicurando affidabilità e qualità; la sostituzione autonoma di schede LED e batterie ne prolunga l'utilizzo e riduce lo spreco di materiali. E con la tecnologia Wi-Fi integrata in alcuni modelli, il controllo della luce diventa ancora più semplice, anche da remoto.

Completa il catalogo una selezione di lampade a tensione di rete, scelte per la loro affinità estetica e funzionale con i modelli cordless: un'integrazione pensata per offrire soluzioni complementari a un pubblico attento al design e alla qualità delle fonti luminose, capace di portando lo stile e la vivacità Zafferano ovunque, ogni giorno.

## ***Zafferano Lampes-à-porter: your light, wherever you need it.***

*Zafferano cordless lamps provide versatile lighting for any environment, including those without access to electricity—from gardens to historic salons, from restaurants to terraces. Often suitable for outdoor use, they seamlessly adapt to any setting thanks to their essential design and wide range of colors. Light intensity and color temperature can be easily adjusted using buttons or touch controls.*

*Designed for long-term use, all Zafferano cordless lamps come with a three-year warranty, ensuring reliability and quality. The ability to independently replace LED boards and batteries extends their lifespan and reduces material waste. Additionally, with Wi-Fi technology integrated into select models, lighting control becomes even more convenient—even remotely.*

*This catalog is completed by a selection of mains-powered lamps, chosen for their aesthetic and functional affinity with the cordless models. An integration designed to offer complementary solutions to an audience attentive to design and the quality of light sources, bringing Zafferano's style and vibrancy everywhere, every day.*

**zafferano**

# Il valore di Zafferano

Scegliere Zafferano significa puntare su qualità, sicurezza, design e sull'affidabilità di un marchio riconosciuto e protetto.

## LA NOSTRA IDENTITÀ

Il nostro **purpose**: We bring joy into everyday life

I nostri **valori**: convivialità, pop-ness, eccellenza

La nostra **promessa**: prodotti belli, affidabili, longevi, capaci di portare colore, funzionalità e gioia negli spazi di tutti i giorni

## ORIGINALITÀ, FIDUCIA E AFFIDABILITÀ

Zafferano è una marca solida e riconoscibile: attiva da oltre 20 anni, presente a livello globale con **4 sedi nel mondo**, riferimento nel settore contract

La vera **Poldina** è Zafferano: l'originale garantisce sicurezza, affidabilità e assistenza

Il **design** dei nostri modelli più iconici, come **Poldina** e **Pina**, è **registrato**.

I prodotti Zafferano sono **personalizzabili** e offrono un'ampia gamma di collaborazioni creative, costantemente aggiornata per rispondere a ogni esigenza di stile

## QUALITÀ E SERVIZIO: COSA CI RENDE DIVERSI

**Design** curato in ogni dettaglio, estetico e funzionale

**Garanzia di 3 anni** su tutti i prodotti luce

**Certificazioni internazionali**: i nostri prodotti sono sicuri, ovunque nel mondo

Alti standard di **sicurezza**: sistemi di protezione su batterie e componenti elettronici

**IP54** o **IP65**: adatti all'esterno e resistenti alla pioggia

**Tecnologia professionale**: luce dimmerabile, temperature colore della luce selezionabili, basi di ricarica multiple

**Supporto post-vendita** rapido e ampia disponibilità di ricambi originali: batterie, LED, steli, basi

## DURATA = SOSTENIBILITÀ

I prodotti Zafferano durano a lungo nel tempo: il catalogo comprende di un'ampia gamma di **ricambi** e **accessori** con cui rinnovare la vita del prodotto, il che significa anche ridurre il suo impatto ambientale.

Per ricevere supporto e ulteriori dettagli, puoi contattare [info@zafferanoitalia.com](mailto:info@zafferanoitalia.com)

Ogni lampada Zafferano è un concentrato di qualità, design e affidabilità:

conoscere il prodotto è il primo passo per venderlo bene.

Usa queste linee guida per farne capire il valore, con competenza e convinzione.

# The Value of Zafferano

By choosing Zafferano, you are choosing quality, safety, design, and the reliability of a recognized and protected

## OUR IDENTITY

Our **purpose**: We bring joy into everyday life

Our **values**: conviviality, pop-ness, excellence

Our **promise**: beautiful, reliable, long-lasting products that bring color, functionality, and joy across all living spaces, everyday

## ORIGINALITY, TRUST, AND RELIABILITY

Zafferano is a strong and recognizable brand, active for over 20 years, a benchmark in the ho.re.ca. industry, supporting clients **worldwide** from its HQ and 3 subsidiaries

It produces the original **Poldina**: the authentic version that guarantees safety, reliability, and customer support

The **design** of most iconic Zafferano models, such as **Poldina** and **Pina**, is **registered**.

Zafferano products are **customizable** and offer a wide range of creative collaborations, constantly updated to meet every style requirement

## QUALITY AND SERVICE: WHAT SETS US APART

Carefully crafted **design** both aesthetic and functional

**3-year warranty** on all lighting products

**International certifications**: our products are safe worldwide

High **safety** standards: battery and electronic component protection systems

**IP54** or **IP65**: suitable for outdoor use and rainproof

**Professional technology**: dimmable light, selectable color temperatures, multiple charging bases

**Fast after-sales support** and a wide availability of original spare parts, including batteries, LEDs, stems, and bases.

## LONGEVITY = SUSTAINABILITY

Zafferano products are built to last: the catalog offers a wide range of **spare parts** and **accessories** to extend the product's lifespan helping reduce environmental impact

For support and further details, contact [info@zafferanoitalia.com](mailto:info@zafferanoitalia.com)

Each Zafferano lamp is a blend of quality, design, and reliability:

knowing the product is the first step to selling it well.

Use these guidelines to communicate its value with competence and confidence.



Cordless



Dimmable



Outdoor use



Selectable color temperature



Rechargeable



Customizable



# Zafferano Lighting

App



Grazie alla tecnologia Wi-Fi integrata, le nostre lampade ricaricabili offrono un controllo avanzato da remoto. Oltre alle funzioni di accensione, spegnimento e regolazione delle impostazioni, permettono funzionalità come il controllo simultaneo di gruppi di lampade, la disabilitazione del tasto touch fisico, il monitoraggio del livello della batteria e la regolazione precisa dell'intensità luminosa e della temperatura di colore (bianco dinamico). Con ogni aggiornamento software, vengono aggiunte automaticamente nuove funzionalità e miglioramenti.

*With integrated Wi-Fi technology, our cordless lamps offer advanced remote control. Beyond power on/off and setting adjustments, they offer additional features such as simultaneous control of multiple lamps, disabling the physical touch button, battery level monitoring, and precise adjustment of light intensity and color temperature (dynamic white). With each software update, new features and enhancements are automatically added.*



DOWNLOAD

## Telecomando / Remote Control

Con l'introduzione del controllo a distanza via radiofrequenza, la nostra offerta di lampade portatili si amplia con modelli dotati di una nuova modalità di utilizzo, intuitiva e versatile. Il telecomando dedicato consente di gestire in modo semplice e immediato le principali funzioni luminose.

Uno strumento pratico, pensato per contesti professionali come ristoranti, hotel o spazi espositivi, dove efficienza e rapidità di intervento sono fondamentali. Il telecomando consente di gestire tutte le principali funzioni luminose accensione e spegnimento, regolazione dell'intensità (4 livelli preimpostati) e della temperatura colore (4 step Kelvin) oltre a funzioni avanzate come il blocco del controllo touch e due tasti personalizzabili per opzioni extra.

*With the introduction of radio frequency remote control, our range of portable lamps expands to include models featuring a new, intuitive and versatile way of use. The dedicated remote makes it easy and immediate to manage the lamp's main lighting functions. It is a practical tool designed especially for professional use in restaurants, hotels, or exhibition spaces where efficiency and fast operation are essential. The remote control lets you manage all key lighting functions on/off, dimming (4 preset levels), and color temperature adjustment (4 Kelvin steps) plus advanced features like disabling the physical touch control and two customizable buttons for extra options.*



**Collezioni / Collections**



**Poldina**  
10



**Poldina Classic**  
36



**Poldina Reverso**  
42



**Poldina Reverso Solar**  
50



**Poldina Stopper**  
46



NEW

**Perpetua**  
72



**Pina**  
188



**Push-up**  
200



**Royal Family**  
114



**Sister Light**  
204

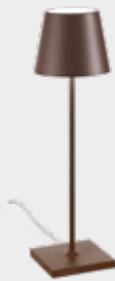

**Poldina 230V**  
58



**Amelie**  
136



**Angelina**  
80



**Barbell**  
54



**Carolina**  
84



**Soffio**  
118



**Super O**  
212



**Swap**  
228



**Teepee**  
122



**Tree of light**  
126



**Circe**  
142



**Damina**  
88



**Dondolina**  
92

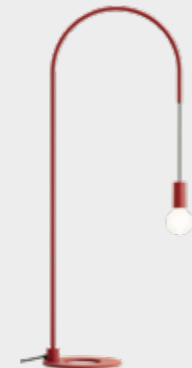

**Filo**  
96



**Flaminia**  
110



**Trilli**  
132



**Home**  
146



**Home Solar**  
152



**Ofelia**  
162



**Olivia**  
168



**Pencil**  
176

**Extra**



**Liolà**  
238



**Accessori Poldina**  
*Poldina accessories*  
68



**Accessori Swap**  
*Swap accessories*  
234



**Ricambi**  
*Spare parts*  
244



**Personalizzazioni**  
*Customization*  
254

# Poldina<sup>PRO</sup>

Poldina è una collezione di lampade a batteria, portatili e ricaricabili, disponibili in diverse tipologie: da tavolo in quattro modelli, da terra in due modelli, a picchetto, a sospensione e a parete. Nella parte superiore della testa è presente un controllo "touch", che permette l'accensione, la regolazione dell'intensità luminosa e la selezione della temperatura di colore della luce. Grazie all'alto indice di protezione, le lampade possono essere utilizzate anche all'esterno, ad eccezione dei modelli con finitura galvanica e a foglia metallica, per i quali non si consiglia un uso prolungato in ambienti esterni. Un sistema di controllo elettronico monitora e segnala l'autonomia residua della batteria, permettendo di ottimizzare le ricariche. Tutti i modelli sono dotati di base di ricarica a contatto. È possibile personalizzare alcuni modelli con cover in vari materiali, acquistabili separatamente (pag. 68-71).

*Poldina is a collection of cordless, rechargeable battery lamps, consisting of table lamps (four models), floor lamps (two models), garden stake lamp, suspension lamp and wall lamp. A touch control placed on the lamp head allows switching on/off, dimming, and selecting the color temperature (K). With their high protection rating, the lamps are suitable for both indoor and outdoor use, except for the models with a metallic leaf or glossy finish, which are not recommended for prolonged outdoor exposure. The lamps feature an electronic control system that monitors and indicates the remaining battery life, allowing for optimized charging. All models are equipped with a contact charging base. The lamps can be personalised with covers in various materials, to be purchased separately (pg 68-71).*



LINK TO VIDEO

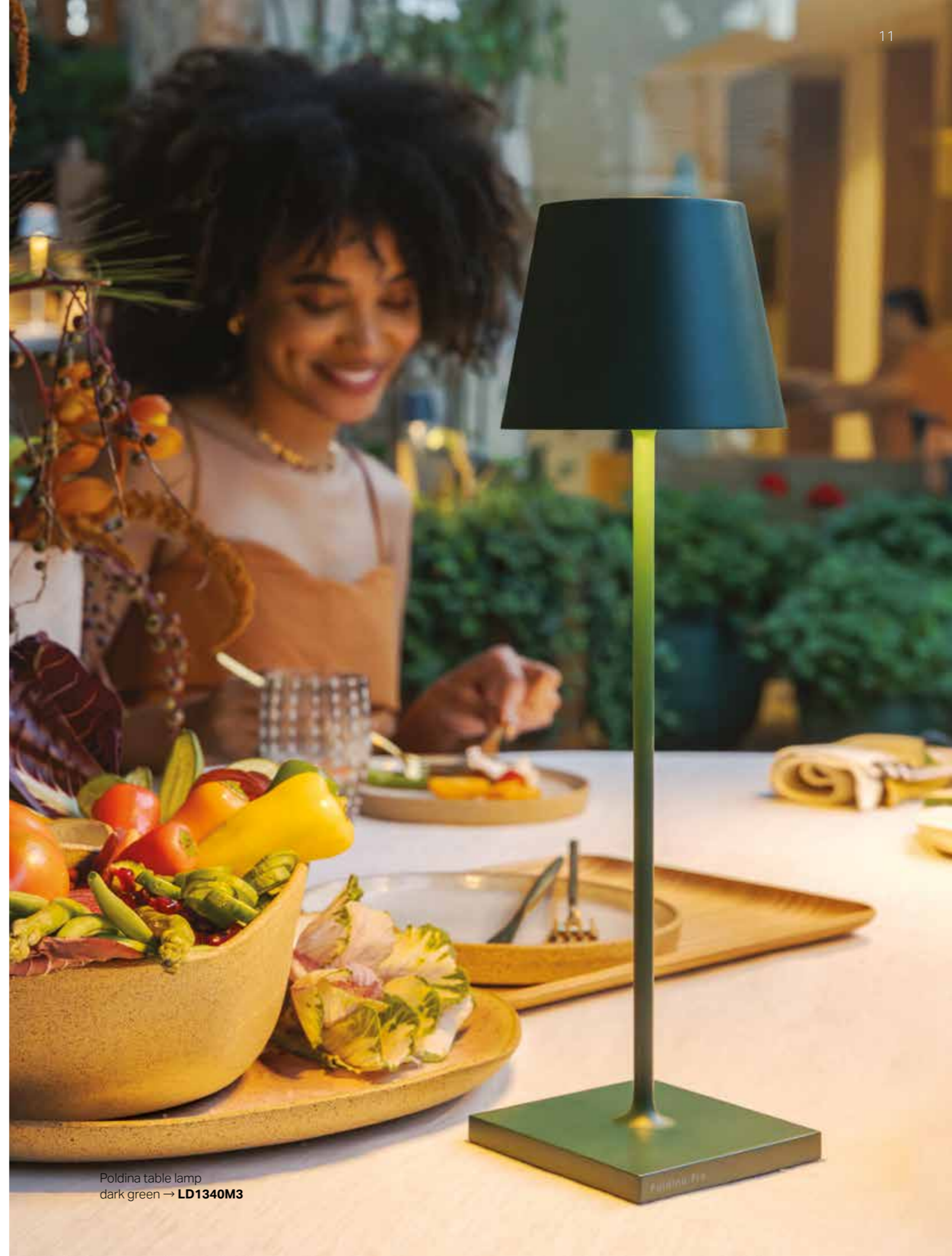

Poldina table lamp  
dark green → **LD1340M3**



Poldina mini table lamp  
corten → **LD1320R3**



Poldina micro table lamp glossy gold → **LD049003**



Poldina XXL floor-table lamp  
dark gray → **LD0360N3**



Poldina L floor-table lamp white  
→ **LD1390B3**

# Poldina <sup>PRO</sup>

Lampada da tavolo  
Table lamp

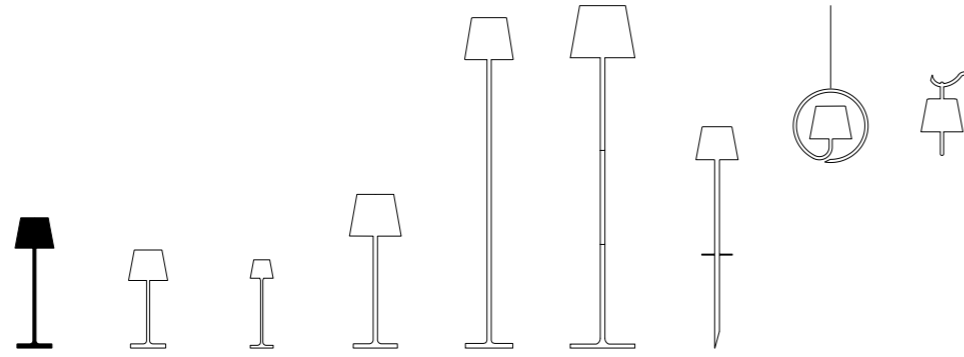

## Dati tecnici

### Technical data

#### LED TOUCH DIMMER

2200-2700-3000 K | CRI>80  
234-251-256 lm | 2.2 W | IP65  
50-60 Hz | 5 V max 1A



Corpo in pressofusione di alluminio verniciato  
*Painted die-cast aluminum body*

Diffusore in policarbonato  
*Polycarbonate diffuser*

Adatta all'uso esterno (lampada IP65) e interno (lampada su base di ricarica IP20)  
*Suitable for outdoor (lamp IP65) and indoor use (lamp on charging base IP20)*

Durata di circa 12 h alla massima potenza  
*Battery lasts about 12 h at full power*

Tempo di ricarica a 1A: 6/7 h  
*Charging time at 1A: 6/7 h*

Pacco batteria al litio ricaricabile e sostituibile  
*Rechargeable and replaceable lithium battery pack*

### Avvertenze

*Remarks*

Le lampade con finitura in foglia metallica (oro, argento, rame) e con finitura galvanica (oro e cromo) non sono adatte ad un uso prolungato in ambiente esterno.

*The lamps with metallic-leaf finishes (gold, silver and copper), and with glossy finishes (gold and chrome) are not suitable for prolonged outdoor use.*

Per effetto della natura manuale della tecnica adottata nella lavorazione con foglia metallica, l'aspetto finale della finitura delle lampade può risultare differente. Eventuali difformità attestano il pregio e l'unicità di ciascuna lampada e non vanno considerate come imperfezioni.

*Due to the manual nature of the technique adopted in the application of the metal foil, the final appearance of the lamps' finishing can be different. Any apparent imperfections attest to the quality and exclusivity of each lamp and should not be considered as imperfections.*

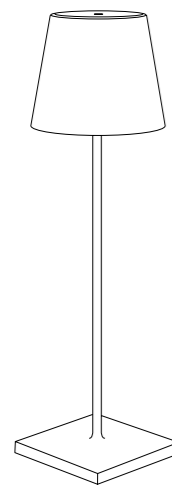

Ø 11 x 38 cm

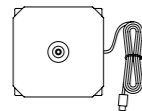

9,4 x 9,4 cm

### Componenti inclusi

*Components included*

Base di ricarica a contatto (USB-A)  
*Contact charging base (USB-A)*

### Accessori non inclusi

*Accessories not included*

Caricatore a spina / USB charger → **LD0490UA**  
5 V max 1A | 100-240V | USB-A - (pg. 247)

## Finiture

*Finishes*

IP65



**LD1340B3**  
Bianco / White  
RAL 9003



**LD1340R3**  
Corten



**LD1340N3**  
Grigio scuro / Dark gray



**LD1340D3**  
Nero / Black  
RAL 9004



**LD1340S3**  
Sabbia / Sand



**LD1340G3**  
Salvia / Sage green  
Pantone 5635 U



**LD1340P3**  
Rosa / Pink  
Pantone 968 U



**LD1340F3**  
Rosso / Red  
RAL 3000

Finiture  
Finishes

IP65



**LD1340A3**  
Blu avio / *Blue Avio*  
Pantone 7468 U



**LD1340X3**  
Bordeaux / *Burgundy*  
RAL 3005



**LD1340M3**  
Verde scuro / *Dark green*  
RAL 6005



**LD1340H3**  
Ocra / *Ochre*  
RAL 1006



**LD1340O3 \***  
Oro lucido / *Glossy gold*  
Galvanic Finish



**LD1340C3 \***  
Cromo lucido / *Glossy chrome*  
Galvanic Finish



**LD1340BFO \***  
Foglia color oro / *Gold color leaf*



**LD1340BFA \***  
Foglia color argento / *Silver color leaf*



**LD1340RFR \***  
Foglia color rame / *Copper color leaf*

\* Le lampade con finitura in foglia metallica (oro, argento, rame) e con finitura galvanica (oro e cromo) non sono adatte ad un uso prolungato in ambiente esterno.  
\* The lamps with metallic-leaf finishes (gold, silver and copper), and with glossy finishes (gold and chrome) are not suitable for prolonged outdoor use.

poldina x PEANUTS



**LD1340FP1**  
Aviator  
RAL 3000



**LD1340BP2**  
Heart  
RAL 9003



**LD1340BP3**  
Friends  
RAL 9003



**LD1340BP4**  
Strip  
RAL 9003



**LD1340RP5**  
Together



# Poldina mini <sup>PRO</sup>

Lampada da tavolo  
Table lamp

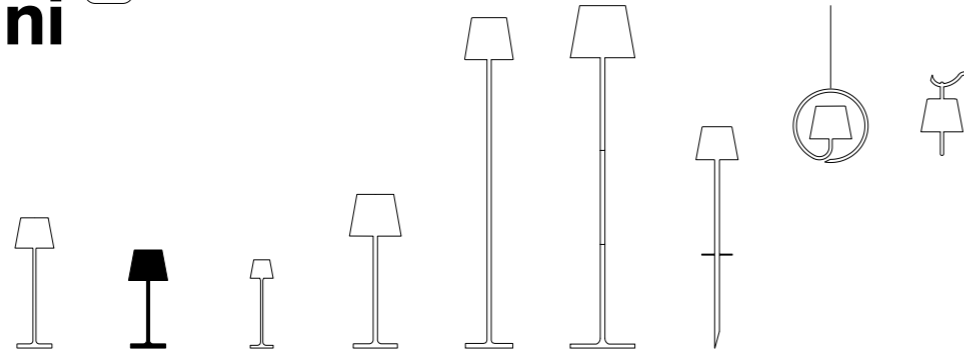

## Dati tecnici

### Technical data

#### LED TOUCH DIMMER

2200-2700-3000 K | CRI>80  
234-251-256 lm | 2.2 W | IP65  
50-60 Hz | 5 V max 1A



Corpo in pressofusione di alluminio verniciato  
*Painted die-cast aluminum body*

Diffusore in policarbonato  
*Polycarbonate diffuser*

Adatta all'uso esterno (lampada IP65) e interno (lampada su base di ricarica IP20)  
*Suitable for outdoor (lamp IP65) and indoor use (lamp on charging base IP20)*

Durata di circa 12 h alla massima potenza  
*Battery lasts about 12 h at full power*

Tempo di ricarica a 1A: 6/7 h  
*Charging time at 1A: 6/7 h*

Pacco batteria al litio ricaricabile e sostituibile  
*Rechargeable and replaceable lithium battery pack*

## Avvertenze

*Remarks*

Le lampade con finitura in foglia metallica (oro, argento, rame) e con finitura galvanica (oro e cromo) non sono adatte ad un uso prolungato in ambiente esterno. Le lampade con finitura oro lucido e cromo lucido sono dotate della funzione di selezione della temperatura di colore della luce tra 2700 e 3000 K.

*The lamps with metallic-leaf finishes (gold, silver and copper), and with glossy finishes (gold and chrome) are not suitable for prolonged outdoor use. The lamps with glossy gold and glossy chrome finish are equipped with a light color temperature selection function 2700 or 3000 K.*

Per effetto della natura manuale della tecnica adottata nella lavorazione con foglia metallica, l'aspetto finale della finitura delle lampade può risultare differente. Eventuali difformità attestano il pregio e l'unicità di ciascuna lampada e non vanno considerate come imperfezioni.

*Due to the manual nature of the technique adopted in the application of the metal foil, the final appearance of the lamps' finishing can be different. Any apparent imperfections attest to the quality and exclusivity of each lamp and should not be considered as imperfections.*

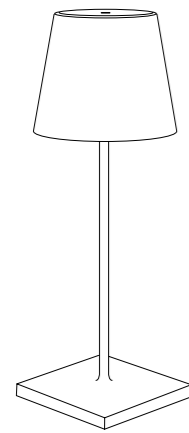

Ø 11 x 30 cm

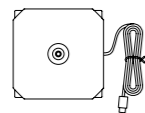

9,4 x 9,4 cm

## Componenti inclusi

### Components included

Base di ricarica a contatto (USB-A)  
Contact charging base (USB-A)

## Accessori non inclusi

### Accessories not included

Caricatore a spina / USB charger → **LD0490UA**  
5 V max 1A | 100-240V | USB-A - (pg. 247)

## Finiture

### Finishes

IP65



**LD1320B3**  
Bianco / White  
RAL 9003



**LD1320R3**  
Corten



**LD1320N3**  
Grigio scuro / Dark gray



**LD1320S3**  
Sabbia / Sand



**LD1320BFO \***  
Foglia color oro / Gold color leaf



**LD1320BFA \***  
Foglia color argento / Silver color leaf



**LD1320RFR \***  
Foglia color rame / Copper color leaf



**LD0320O3 \***  
Oro lucido / Glossy gold  
Galvanic Finish



**LD0320C3 \***  
Cromo lucido / Glossy chrome  
Galvanic Finish

\* Le lampade con finitura in foglia metallica (oro, argento, rame) e con finitura galvanica (oro e cromo) non sono adatte ad un uso prolungato in ambiente esterno. Le lampade con finitura oro lucido e cromo lucido sono dotate della funzione di selezione della temperatura di colore della luce tra 2700 e 3000 K.

\* The lamps with metallic-leaf finishes (gold, silver and copper), and with glossy finishes (gold and chrome) are not suitable for prolonged outdoor use. The lamps with glossy gold and glossy chrome finish are equipped with a light color temperature selection function 2700 or 3000 K.

# Poldina micro <sup>PRO</sup>

Lampada da tavolo  
Table lamp

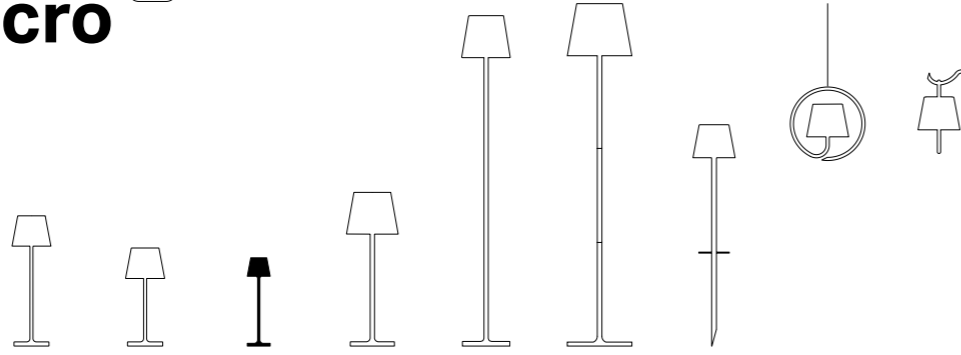

## Dati tecnici

### Technical data

#### LED TOUCH DIMMER

2200-2700-3000 K | CRI>80  
174-177-195 lm | 1.8 W | IP65  
5 V max 1A



Corpo in pressofusione di alluminio verniciato  
*Painted die-cast aluminum body*

Diffusore in policarbonato  
*Polycarbonate diffuser*

Adatta all'uso esterno (lampada IP65) e interno  
(lampada su base di ricarica IP20)  
*Suitable for outdoor (lamp IP65) and indoor use (lamp  
on charging base IP20)*

Durata di circa 7/8 h alla massima potenza  
*Battery lasts about 7/8 h at full power*

Tempo di ricarica a 1A: 3 h  
*Charging time at 1A: 3 h*

Pacco batteria al litio ricaricabile e sostituibile  
*Rechargeable and replaceable lithium battery pack*

#### Avvertenze

*Remarks*

Le lampade con finitura galvanica (oro e cromo) non sono adatte ad un  
uso prolungato in ambiente esterno.  
*The lamps with glossy finishes (gold and chrome) are not suitable for  
prolonged outdoor use.*

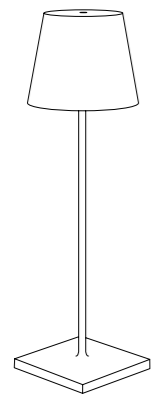

Ø 7 x 27,5 cm

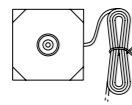

6,7 x 6,7 cm

#### Componenti inclusi

*Components included*

Base di ricarica a contatto (USB-A)  
*Contact charging base (USB-A)*

#### Accessori non inclusi

*Accessories not included*

Caricatore a spina / USB charger → **LD0490UA**  
5 V max 1A | 100-240V | USB-A - (pg. 247)

Poldina micro table lamp glossy gold  
→ **LD049003**



Finiture  
Finishes

IP65



**LD0490B3**  
Bianco / White  
RAL 9003



**LD0490R3**  
Corten



**LD0490N3**  
Grigio scuro /  
Dark gray



**LD0490D3**  
Nero / Black  
RAL 9004



**LD0490S3**  
Sabbia / Sand



**LD0490G3**  
Salvia / Sage  
green  
Pantone 5635 U



**LD0490H3**  
Ocra / Ochre  
RAL 1006



**LD0490P3**  
Rosa / Pink  
Pantone 968 U



**LD0490F3**  
Rosso / Red  
RAL 3000



**LD0490K3**  
Blu Capri / Blu  
Capri  
RAL 5019



**LD0490Z3**  
Arancio / Orange  
RAL 2008



**LD0490O3 \***  
Oro lucido /  
Glossy gold  
Galvanic Finish



**LD0490C3 \***  
Cromo lucido /  
Glossy chrome  
Galvanic Finish

\* Le lampade con finitura galvanica (oro e cromo) non sono adatte ad un uso prolungato in ambiente esterno.

\* The lamps with glossy finishes (gold and chrome) are not suitable for prolonged outdoor use.

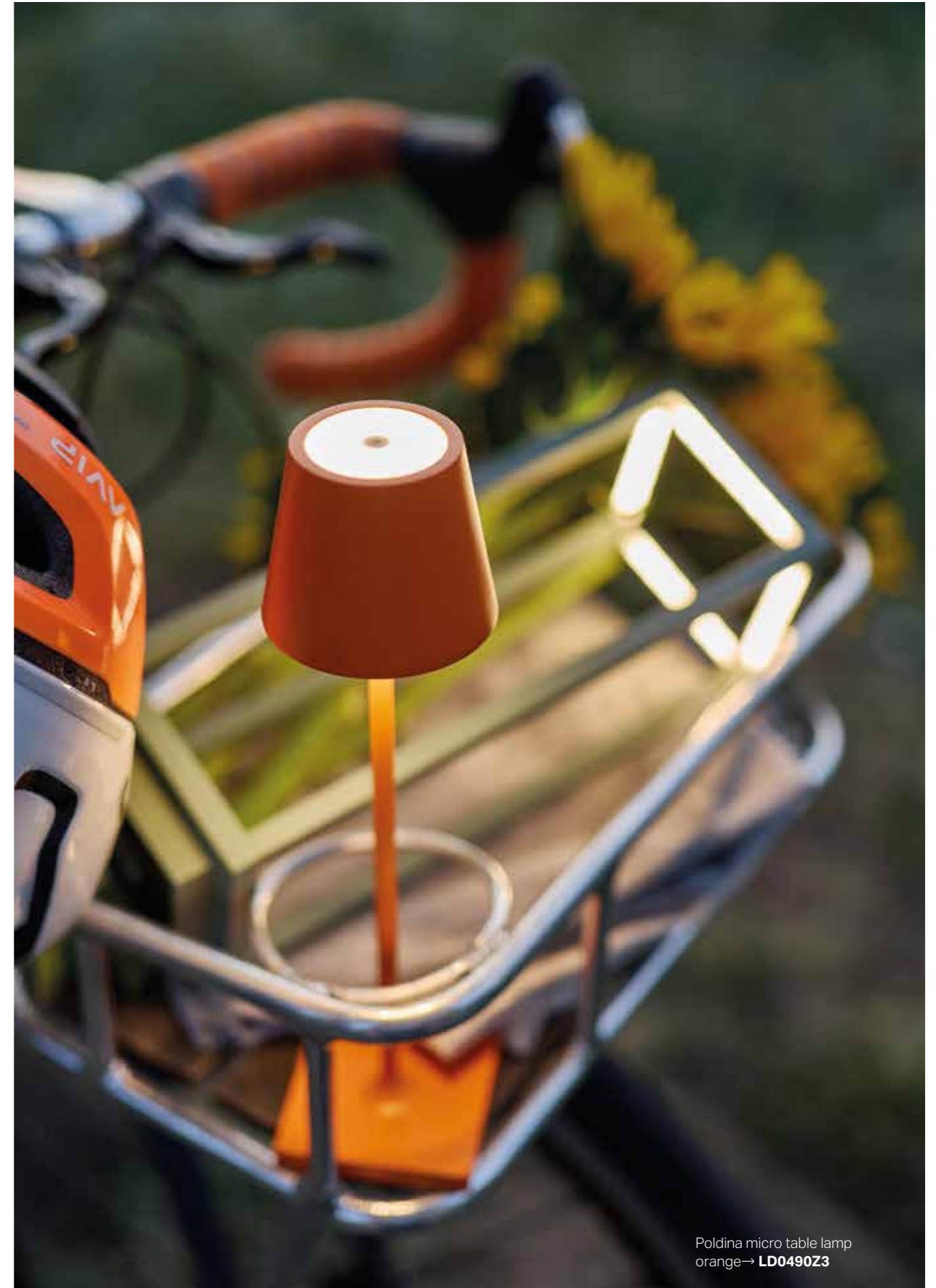

Poldina micro table lamp  
orange → **LD0490Z3**

# Poldina L DESK <sup>PRO</sup>

Lampada da tavolo  
Table lamp

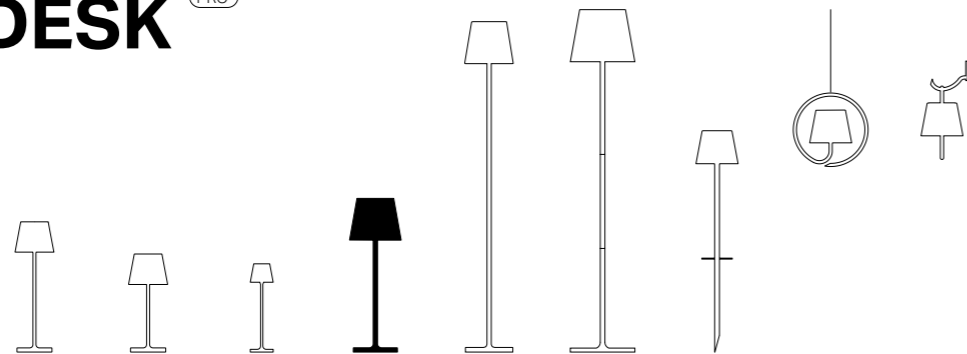

## Dati tecnici

### Technical data

#### LED TOUCH DIMMER

2200-2700-3000 K | CRI>80  
479- 540-550 lm | 5.5 W | IP54  
50-60 Hz | 5 V max 1A



Corpo in pressofusione di alluminio verniciato  
*Painted die-cast aluminum body*

Diffusore in policarbonato  
*Polycarbonate diffuser*

Adatta all'uso esterno (lampada IP54) e interno (lampada su base di ricarica IP20)  
*Suitable for outdoor (lamp IP54) and indoor use (lamp on charging base IP20)*

Durata di circa 11 h alla massima potenza  
*Battery lasts about 11 h at full power*

Tempo di ricarica a 1A: 11 h  
*Charging time at 1A: 11 h*

Pacco batteria al litio ricaricabile e sostituibile  
*Rechargeable and replaceable lithium battery pack*

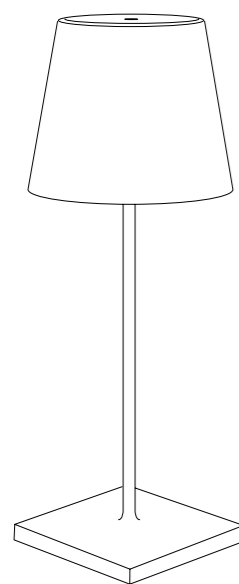

Ø 16,5 x 49,7 cm

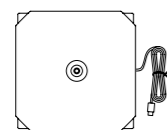

13,5 x 13,5 cm

### Componenti inclusi Components included

Base di ricarica a contatto (USB-A)  
Contact charging base (USB-A)

### Accessori non inclusi Accessories not included

Caricatore a spina / USB charger → **LD0490UA**  
5 V max 1A | 100-240V | USB-A - (pg. 247)

## Finiture Finishes

IP54



**LD1395B3**  
Bianco / White  
RAL 9003



**LD1395R3**  
Corten



**LD1395N3**  
Grigio scuro / Dark gray



# Poldina L <sup>PRO</sup>

Lampada da terra-tavolo  
Floor-table lamp

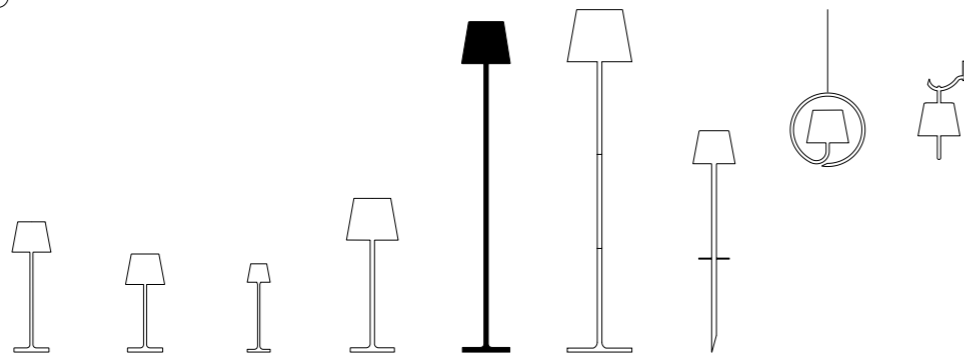

## Dati tecnici

### Technical data

#### LED TOUCH DIMMER

2200-2700-3000 K | CRI>80  
479- 540-550 lm | 5.5 W | IP54  
50-60 Hz | 5 V max 1A



Corpo in pressofusione di alluminio verniciato  
*Painted die-cast aluminum body*

Diffusore in policarbonato  
*Polycarbonate diffuser*

Adatta all'uso esterno (lampada IP54) e interno (lampada su base di ricarica IP20)  
*Suitable for outdoor (lamp IP54) and indoor use (lamp on charging base IP20)*

Durata di circa 11 h alla massima potenza  
*Battery lasts about 11 h at full power*

Tempo di ricarica a 1A: 11 h  
*Charging time at 1A: 11 h*

Pacco batteria al litio ricaricabile e sostituibile  
*Rechargeable and replaceable lithium battery pack*

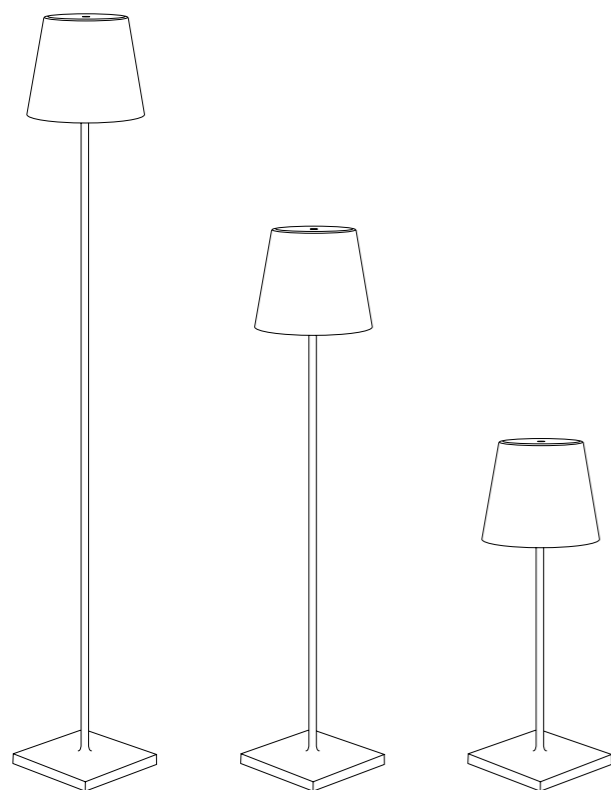

17 x 17 x 122 cm

17 x 17 x 87 cm

17 x 17 x 52 cm

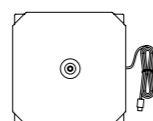

15 x 15 cm

## Componenti inclusi

### Components included

Base di ricarica a contatto (USB-A)  
*Contact charging base (USB-A)*

Stelo (2 pz.)  
*Stem (2 pcs.)*

## Accessori non inclusi

### Accessories not included

Caricatore a spina / USB charger → **LD0490UA**  
5 V max 1A | 100-240V | USB-A - (pg. 247)

## Finiture

### Finishes

IP54



**LD1390B3**

Bianco / White  
RAL 9003



**LD1390R3**

Corten



**LD1390N3**

Grigio scuro / Dark gray

# Poldina XXL <sup>PRO</sup>

Lampada da terra  
Floor lamp

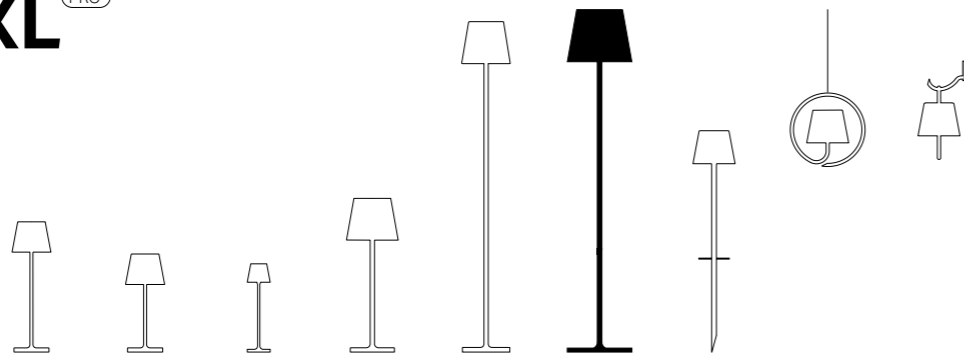

## Dati tecnici

### Technical data

#### LED TOUCH DIMMER

2700-3000 K | CRI>80  
470-500 lm | 6.5 W | IP54  
50-60 Hz | 5 V max 1A



Corpo in pressofusione di alluminio verniciato  
*Painted die-cast aluminum body*

Diffusore in policarbonato  
*Polycarbonate diffuser*

Adatta all'uso esterno (lampada IP54) e interno (lampada su base di ricarica IP20)  
*Suitable for outdoor (lamp IP54) and indoor use (lamp on charging base IP20)*

Durata di circa 15 h alla massima potenza  
*Battery lasts about 15 h at full power*

Tempo di ricarica a 1A: 20 h  
*Charging time at 1A: 20 h*

Pacco batteria al litio ricaricabile e sostituibile  
*Rechargeable and replaceable lithium battery pack*

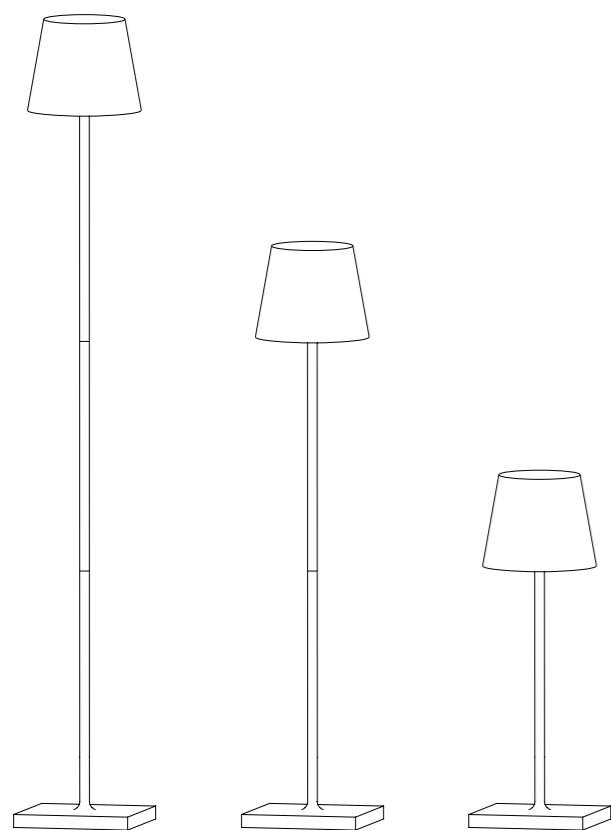

Ø 28 x 150 cm

Ø 28 x 110 cm

Ø 28 x 69,5 cm

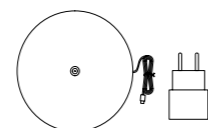

Ø 24,7 cm

## Componenti inclusi

### Components included

Base di ricarica a contatto (USB-A)  
*Contact charging base (USB-A)*

Caricatore a spina / USB charger → **LD0490UA**  
5 V max 1A | 100-240V | USB-A - (pg. 247)

Stelo (2 pz.)  
*Stem (2 pcs.)*

## Finiture

### Finishes

IP54



**LD0360B3**  
Bianco / White  
RAL 9003



**LD0360R3**  
Corten



**LD0360N3**  
Grigio scuro / Dark gray

# Poldina<sup>PRO</sup>

Lampada con picchetto  
Lamp with peg

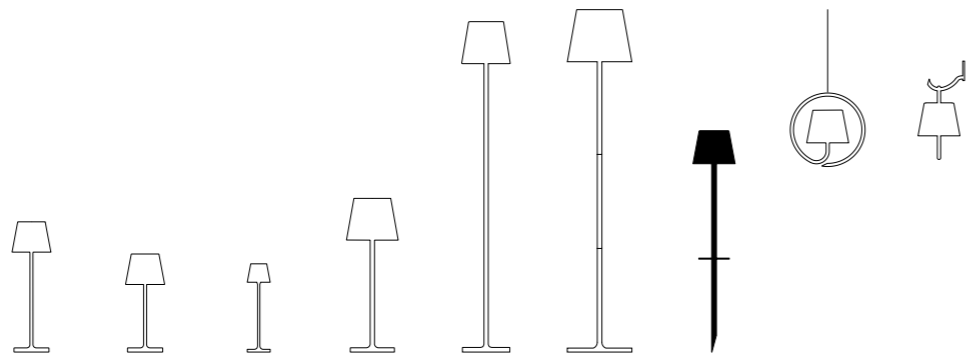

## Dati tecnici

### Technical data

#### LED TOUCH DIMMER

2200-2700-3000 K | CRI>80  
234-251-256 lm | 2.2 W | IP54  
5 V max 1A



Corpo in pressofusione di alluminio verniciato  
*Painted die-cast aluminum body*

Diffusore in policarbonato  
*Polycarbonate diffuser*

Adatta all'uso esterno (lampada IP54) e interno (lampada su base di ricarica IP20)  
*Suitable for outdoor (lamp IP54) and indoor use (lamp on charging base IP20)*

Durata di circa 12 h alla massima potenza  
*Battery lasts about 12 h at full power*

Tempo di ricarica a 1A: 6/7 h  
*Charging time at 1A: 6/7 h*

Pacco batteria al litio ricaricabile e sostituibile  
*Rechargeable and replaceable lithium battery pack*

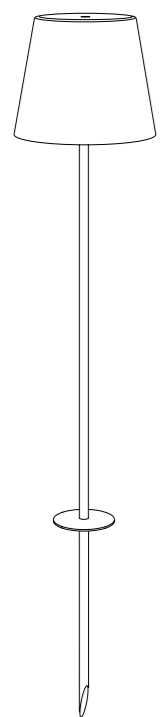

Ø 11 x 60 cm

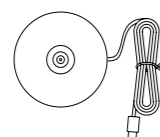

Ø 10,2 cm

#### Componenti inclusi

#### Components included

Base di ricarica a contatto (USB-A)  
*Contact charging base (USB-A)*

#### Accessori non inclusi

#### Accessories not included

Caricatore a spina / USB charger → **LD0490UA**  
5 V max 1A | 100-240V | USB-A - (pg. 247)

## Finiture

### Finishes

IP54



#### LD0682B3

Bianco / White  
RAL 9003



#### LD0682R3

Corten



#### LD0682N3

Grigio scuro / Dark gray

#### Prolunga stelo aggiuntiva (non inclusa)

#### Additional stem extension (not included)

25 cm

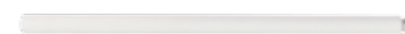

#### LD0283B3

Bianco / White  
RAL 9003

25 cm



#### LD0283R3

Corten

25 cm



#### LD0283N3

Grigio scuro / Dark gray

# Poldina<sup>PRO</sup>

Lampada a sospensione e lampada da parete  
*Sconce and wall lamp*

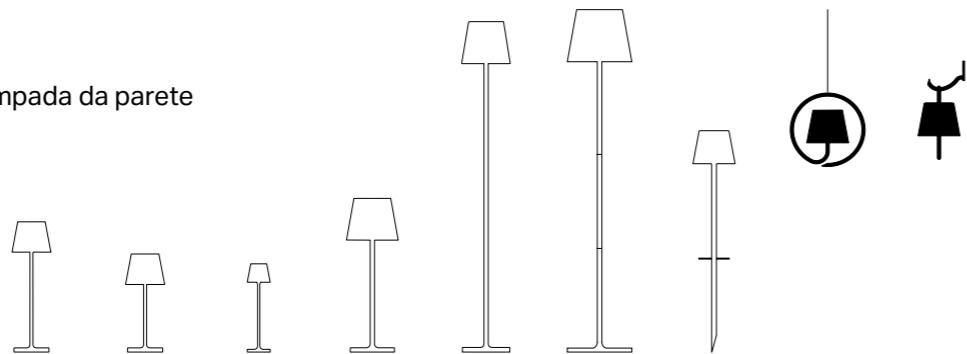

## Dati tecnici

### Technical data

#### LED TOUCH DIMMER

2200-2700-3000 K | CRI>80  
 234-251-256 lm | 2.2 W | IP54  
 5 V max 1A



Corpo in pressofusione di alluminio verniciato  
*Painted die-cast aluminum body*

Diffusore in policarbonato  
*Polycarbonate diffuser*

Adatta all'uso esterno (lampada IP54) e interno (lampada su base di ricarica IP20)  
*Suitable for outdoor (lamp IP54) and indoor use (lamp on charging base IP20)*

Durata di circa 12 h alla massima potenza  
*Battery lasts about 12 h at full power*

Tempo di ricarica a 1A: 6/7 h  
*Charging time at 1A: 6/7 h*

Pacco batteria al litio ricaricabile e sostituibile  
*Rechargeable and replaceable lithium battery pack*

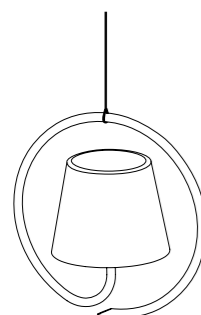

19,8 x 19,8 x 11 cm

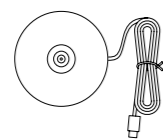

Ø 10,2 cm

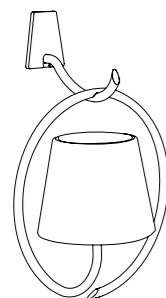

12,3 x 26,5 x 11 cm

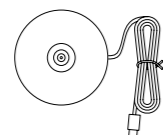

Ø 10,2 cm

#### Componenti inclusi Components included

Base di ricarica a contatto (USB-A)  
*Contact charging base (USB-A)*

#### Accessori non inclusi Accessories not included

Caricatore a spina / USB charger → **LD0490UA**  
 5 V max 1A | 100-240V | USB-A - (pg. 247)

## Finiture Finishes



**LD0686B3**  
 Bianco / White  
 RAL 9003



**LD0686R3**  
 Corten



**LD0686N3**  
 Grigio scuro / Dark gray



**LD0689B3**  
 Bianco / White  
 RAL 9003



**LD0689R3**  
 Corten



**LD0689N3**  
 Grigio scuro / Dark gray



# Poldina Classic <sup>PRO</sup>

Design Zafferano

Poldina Classic è una collezione di lampade da tavolo a batteria, portatili e ricaricabili, disponibili in due dimensioni. La struttura in alluminio pressofuso ed estruso, proposta nelle finiture opache oro, bianco e bronzo, è completata da un paralume in tessuto plissettato. La parte strutturale, priva di elettrificazione, accoglie il modulo luminoso con attacco magnetico, facilmente rimovibile per la ricarica sull'apposita base a contatto inclusa nella confezione: un'operazione semplice e immediata. Il modulo luminoso può essere acquistato anche separatamente. Questa caratteristica è particolarmente utile in ambito professionale, dove si possono avere moduli di riserva sempre pronti: in caso di necessità, un modulo scarico può essere sostituito all'istante con uno già carico e funzionante, senza dover attendere la ricarica della lampada. Nella parte superiore del modulo luminoso è presente un controllo touch, che permette l'accensione, la regolazione dell'intensità luminosa e la selezione della temperatura di colore della luce tra 2200, 2700 e 3000 K. Adatta esclusivamente a uso interno, Poldina Classic è dotata di un sistema di controllo elettronico che monitora e segnala l'autonomia residua della batteria, permettendo di ottimizzare le ricariche.

*Poldina Classic is a collection of cordless, rechargeable battery table lamps, available in two sizes. The die-cast and extruded aluminum structure, offered in matte gold, white, and bronze finishes, is paired with a pleated fabric lampshade.*

*The structure, without internal wiring, houses the LED module with magnetic attachment, which can be easily removed and recharged on the included contact charging base — a quick and effortless operation.*

*The LED module can also be purchased separately. This feature is especially useful in professional settings, where spare modules can be kept on hand: when needed, a depleted module can be immediately replaced with one that is already charged and ready to use, without waiting for the lamp to recharge.*

*A touch control placed on the lamp head allows switching on/off, dimming, and selecting the color temperature (2200, 2700 or 3000 K).*

*Designed for indoor use only, the lamp features an electronic control system that monitors and indicates the remaining battery life, allowing for optimized charging.*



LINK TO VIDEO



Poldina Classic table lamp  
gold → **LD123003**

# Poldina Classic <sup>PRO</sup>

Lampada da tavolo  
Table lamp

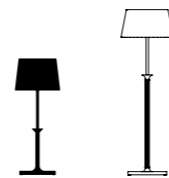

## Dati tecnici

### Technical data

#### LED TOUCH DIMMER

2200-2700-3000 K | CRI>90  
205-209-225 lm | 3.5 W | IP20  
5V max.2A



Corpo in pressofusione di alluminio verniciato  
*Painted die-cast aluminum body*

Paralume in tessuto ignifugo  
*Fire-retardant fabric lampshade*

Modulo luce in policarbonato opalino  
*Opal polycarbonate light module*

Adatta esclusivamente all'uso interno (IP20)  
*Suitable for indoor use only (IP20)*

Durata di circa 10 h alla massima potenza  
*Battery lasts about 10 h at full power*

Tempo di ricarica a 2A: 5 h  
*Charging time at 2A: 5 h*

Pacco batteria al litio ricaricabile e sostituibile  
*Rechargeable and replaceable lithium battery pack*

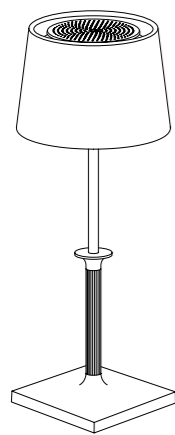

Ø 12,4 x 32 cm



Ø 8,6 x 5 cm

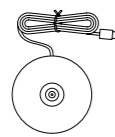

Ø 7,5 cm

### Componenti inclusi Components included

Base di ricarica a contatto (USB-C)  
*Contact charging base (USB-C)*

### Accessori non inclusi Accessories not included

Caricatore a spina / USB charger → **LD1490UA**  
5V max 2A | 200-240V | USB-C (pg. 247)

## Finiture Finishes

IP20



**LD1230B3**  
Bianco / White  
RAL 9003



**LD1230W3**  
Bronzo / Bronze  
MBR



**LD1230O3**  
Oro / Gold  
GHL



# Poldina Classic L DESK <sup>PRO</sup>

Lampada da tavolo  
Table lamp

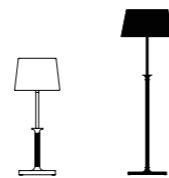

## Dati tecnici

### Technical data

#### LED TOUCH DIMMER

2200-2700-3000K | CRI>90  
205-209-225lm | 3.5W | IP20  
5Vdc max.2A



Corpo in pressofusione di alluminio verniciato  
*Painted die-cast aluminum body*

Paralume in tessuto ignifugo  
*Fire-retardant fabric lampshade*

Modulo luce in policarbonato opalino  
*Opal polycarbonate light module*

Adatta esclusivamente all'uso interno (lampada IP20)  
*Suitable for indoor use only (lamp IP20)*

Durata di circa 10 h alla massima potenza  
*Battery lasts about 10 h at full power*

Tempo di ricarica a 2A: 5 h  
*Charging time at 2A: 5 h*

Pacco batteria al litio ricaricabile e sostituibile  
*Rechargeable and replaceable lithium battery pack*

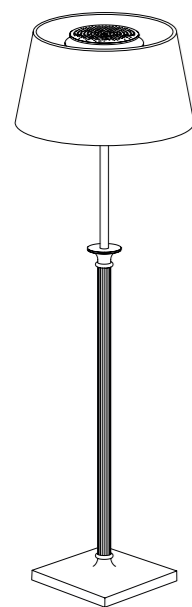

Ø 15,2 x 60 cm



Ø 8,6 x 5 cm

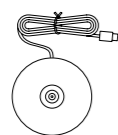

Ø 7,5 cm

#### Componenti inclusi Components included

Base di ricarica a contatto (USB-C)  
*Contact charging base (USB-C)*

#### Accessori non inclusi Accessories not included

Caricatore a spina / USB charger → **LD1490UA**  
5V max 2A | 200-240V | USB-C (pg. 247)

## Finiture Finishes

IP20



**LD1235B3**  
Bianco / White  
RAL 9003



**LD1235W3**  
Bronzo / Bronze  
MBR



**LD1235O3**  
Oro / Gold  
GHL



Poldina Classic L DESK gold → **LD1235O3**

# Poldina Reverso <sup>PRO</sup>

Design Zafferano

Poldina Reverso è una lampada da tavolo a batteria, portatile e ricaricabile, caratterizzata dalla presenza di un contenitore multiuso: prodotto in resina termoplastica adatta al contatto alimentare (PET), capacità 18 cl, esso è removibile e riutilizzabile. Nella parte inferiore della testa è presente un controllo "touch", che permette l'accensione, la regolazione dell'intensità luminosa e la selezione della temperatura di colore della luce. Grazie a un alto indice di protezione, la lampada è utilizzabile anche all'esterno. Un sistema di controllo elettronico monitora e segnala l'autonomia residua della batteria, permettendo di ottimizzare le ricariche. È dotata di base di ricarica a contatto.

*Poldina Reverso is a cordless, rechargeable battery table lamp, featuring a multipurpose storage tray: made of thermoplastic resin suitable for food contact (PET), capacity 18cl, the tray is removable and reusable. A touch control placed on the lower part of the lamp head allows switching on/off, dimming, and selecting the color temperature (K).*

*Suitable for both indoor and outdoor use, the lamp features an electronic control system that monitors and indicates the remaining battery life, allowing for optimized charging. The lamp is equipped with a contact charging base.*



LINK TO VIDEO



Poldina Reverso table  
lamp corten → **LD0420R3**

# Poldina Reverso <sup>PRO</sup>

Lampada da tavolo  
Table lamp



## Dati tecnici

### Technical data

#### LED TOUCH DIMMER

2200-2700-3000 K | CRI>80  
241-250-262 lm | 2.3 W | IP54  
50-60 Hz | 5 V max 1 A



Corpo in pressofusione di alluminio verniciato  
*Painted die-cast aluminum body*

Diffusore in policarbonato satinato  
*Satin polycarbonate diffuser*

Adatta all'uso esterno (lampada IP54) e interno  
(lampada su base di ricarica IP20)  
*Suitable for outdoor (lamp IP54) and indoor use (lamp on charging base IP20)*

Durata di circa 12 h alla massima potenza  
*Battery lasts about 12 h at full power*

Tempo di ricarica a 1A: 6/7 h  
*Charging time at 1A: 6/7 h*

Pacco batteria al litio ricaricabile e sostituibile  
*Rechargeable and replaceable lithium battery pack*

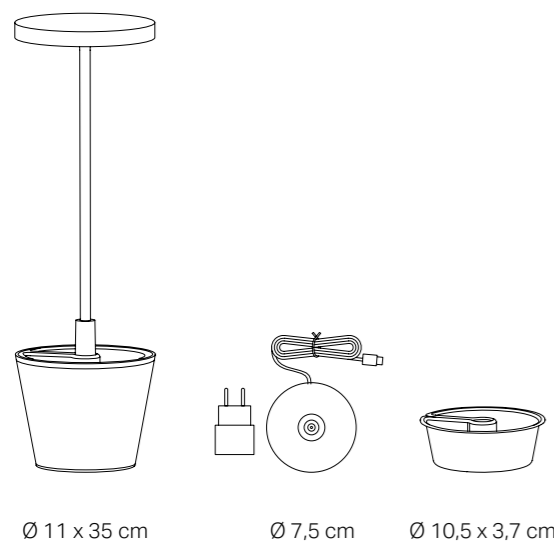

Ø 11 x 35 cm

Ø 7,5 cm

Ø 10,5 x 3,7 cm

## Componenti inclusi

### Components included

Base di ricarica a contatto (USB-A)  
*Contact charging base (USB-A)*

Alimentatore a spina / Charger  
5VDC max 1A | 100-240 V | USB-A

Vaschetta contenitore multiuso  
*Multipurpose container tray*

## Finiture

### Finishes

IP54



**LD0420B3**  
Bianco / White  
RAL 9003

**LD0420R3**  
Corten

**LD0420N3**  
Grigio scuro / Dark gray

**LD0420G3**  
Salvia / Sage green  
Pantone 5635 U

**LD0420S3**  
Sabbia / Sand



# Poldina Stopper <sup>PRO</sup>

Design Zafferano

Poldina Stopper è una lampada a batteria, portatile e ricaricabile, con tappo in silicone, che si può inserire su una bottiglia, trasformandola in un oggetto luminoso.

Nella parte superiore della testa è presente un controllo "touch", che permette l'accensione, la regolazione dell'intensità luminosa e la selezione della temperatura di colore della luce. Grazie a un alto indice di protezione, la lampada è utilizzabile anche all'esterno.

Un sistema di controllo elettronico monitora e segnala l'autonomia residua della batteria, permettendo di ottimizzare le ricariche. Il tappo in silicone (adatto al contatto alimentare) si adatta a diversi colli di bottiglia e si rimuove in modo pratico, permettendo di ricaricare comodamente la lampada sulla propria base di ricarica a contatto, fornita.

Poldina Stopper è utilizzabile anche con le bottiglie in ceramica "Lido", acquistabili separatamente.

*Poldina Stopper is a cordless, rechargeable battery table lamp. Thanks to a silicone stopper cork, the lamp can be placed on a bottle, turning it into a luminous object.*

*A touch control on the lamp head allows switching on/off, dimming, and selecting the color temperature (K).*

*Suitable for both indoor and outdoor use, the lamp features an electronic control system that monitors and indicates the remaining battery life, allowing for optimized charging.*

*The silicone cap (suitable for food contact) fits different bottle necks and can be easily removed, allowing the lamp to be conveniently recharged on its contact charging base, included.*

*Poldina Stopper can also be used with "Lido" ceramic bottles, to be purchased separately.*



LINK TO VIDEO



Poldina Stopper Avio blue → **LD0349A3**  
Lido ceramic bottle light blue → **RIG1501**

# Poldina Stopper <sup>PRO</sup>

Lampada per bottiglia  
Bottle lamp

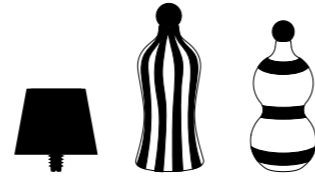

## Dati tecnici

### Technical data

#### LED TOUCH DIMMER

2200-2700-3000 K | CRI>80  
234-251-256 lm | 2.2 W | IP54  
5 V max 1A



Corpo in pressofusione di alluminio verniciato  
*Painted die-cast aluminum body*

Diffusore in policarbonato  
*Polycarbonate diffuser*

Adatta all'uso esterno (lampada IP54) e interno (lampada su base di ricarica IP20)  
*Suitable for outdoor (lamp IP54) and indoor use (lamp on charging base IP20)*

Durata di circa 12 h alla massima potenza  
*Battery lasts about 12 h at full power*

Tempo di ricarica a 1A: 6/7 h  
*Charging time at 1A: 6/7 h*

Pacco batteria al litio ricaricabile e sostituibile  
*Rechargeable and replaceable lithium battery pack*

Bottiglie in ceramica decorata a mano  
*Hand-painted ceramic bottle*

Tappo ermetico, in materiale plastico, adatto al contatto alimentare  
*Airtight plastic stopper, suitable for food contact*

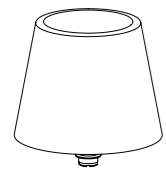

Ø 11,1 x 11,1 cm

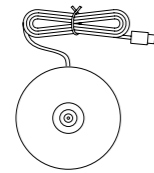

Ø 10,2 cm



Ø 2,5 x 3,8 cm

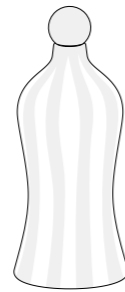

Ø 11 x 26,5 cm  
90 cl



Ø 10,4 x 24,5 cm  
82 cl

### Componenti inclusi Components included

Base di ricarica a contatto (USB-A)  
*Contact charging base (USB-A)*

Tappo in silicone per Poldina / *Poldina airtight plastic stopper*

### Accessori non inclusi Accessories not included

Caricatore a spina / *USB charger* → **LD0490UA**  
5 V max 1A | 100-240V | USB-A (pg. 247)

Bottiglia in ceramica / *Ceramic bottle*

## Finiture Finishes

IP54



**LD0349B3**  
Bianco / *White*  
RAL 9003



**LD0349A3**  
Blu avio  
*/ Blue Avio*  
Pantone 7468 U



**LD0349F3**  
Rosso / *Red*  
RAL 3000



**LD0349G3**  
Salvia  
*/ Sage green*  
Pantone 5635 U



**LD0349S3**  
Sabbia / *Sand*



**LD0349D3**  
Nero / *Black*  
RAL 9004

## Finiture Finishes



**RIG1501**  
Righe azzurre  
*Light blue stripes*



**RIG1502**  
Righe rosse  
*Red stripes*



**RIG1505**  
Righe verdi  
*Green stripes*



**RIG1507**  
Righe sabbia  
*Sand stripes*



**RIG1508**  
Righe nere  
*Black stripes*



**FAS1501**  
Fasce azzurre  
*Light blue bands*



**FAS1502**  
Fasce rosse  
*Red bands*



**FAS1505**  
Fasce verdi  
*Green bands*



**FAS1507**  
Fasce sabbia  
*Sand bands*



**FAS1508**  
Fasce nere  
*Black bands*

# Poldina Reverso Solar L

Design Zafferano

Poldina Reverso Solar è una lampada da terra portatile e ricaricabile dotata di pannello solare e due elementi contenitori integrati nella base, utilizzabili a scopo funzionale (ad esempio come fioriere o cestini) oppure decorativo (riempiti con sabbia, sassi, ecc.).

Progettata per l'uso in esterni e interni (IP65), è realizzata in materiale plastico stampato e alluminio verniciato. Completano la dotazione i sensori crepuscolare e di movimento, che attivano e regolano automaticamente la luce in base alla luminosità ambientale e alla presenza di persone.

L'illuminazione LED può essere gestita in modalità manuale oppure da remoto, tramite radiofrequenza (con telecomando, incluso). È possibile dimmerare la lampada, su 4 livelli. Inoltre è possibile regolare la temperatura di colore della luce, tra 4 valori preimpostati (2200K, 2700K, 3000K, 4000K).

La batteria può essere ricaricata tramite pannello solare ma anche tramite cavo USB type-C.

*Poldina Reverso Solar is a cordless, rechargeable floor lamp equipped with a solar panel and featuring two built-in compartments at the base. These can be used functionally (e.g., as planters or bins) or decoratively (filled with sand, stones, etc.). Designed for both outdoor and indoor use (IP65), it is made of molded plastic and powder-coated aluminum. The integrated dusk and motion sensors automatically turn the light on and adjust brightness according to ambient light and presence detection. The LED lighting can be controlled manually or remotely via radio frequency, using the included remote control. The lamp is dimmable, offering four brightness levels, and the color temperature can be adjusted to four preset values: 2200K, 2700K, 3000K, 4000K. The battery can be recharged via the solar panel or with a USB type-C cable.*



LINK TO VIDEO



Poldina Reverso Solar L  
floor lamp Black → **LD1430D3**

# Poldina Reverso Solar L RF

Lampada solare da terra  
Solar floor lamp



## Dati tecnici

### Technical data

#### LED TOUCH DIMMER

2200-2700-3000-4000 K | CRI>90  
1079-1181-1320-1398 lm | 11.7 W | IP65  
PD 65W max. 3A / PD 5Vdc max. 3A



Dotata di sensore crepuscolare e di movimento  
Fitted with dusk and motion sensors

Diffusore in policarbonato  
Polycarbonate diffuser

Adatta all'uso esterno (lampada IP65)  
Suitable for outdoor (lamp IP65)

Durata batteria: luce piena 8 h; micro 32,5 h  
Work time: full power 8 h; energy saving 32,5 h

Tempo di ricarica PD 65W max. 15V 3A: 2 ½ h  
Charging time PD 65W max. 15V 3A: 2 ½ h

Pacco batteria al litio ricaricabile e sostituibile  
Rechargeable and replaceable lithium battery pack

Tecnologia Radiofrequenza (RSK)  
Radio-frequency technology (RSK)

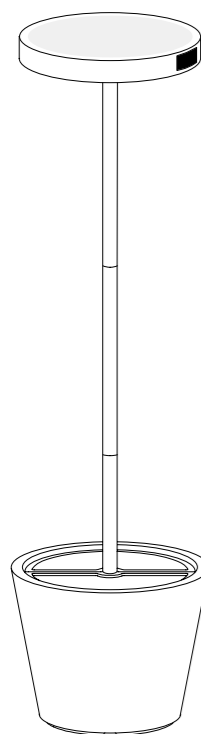

Ø 43,5 x 156 cm

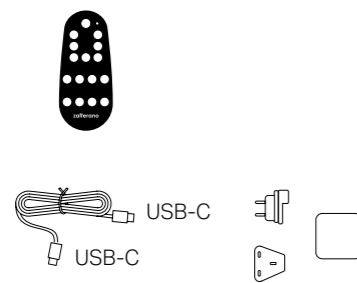

3 m



Accessori non inclusi  
Accessories not included

Ripiano / Shelf (pg. 246) → **LD1431D3** Nero / Black  
**LD1431G3** Salvia / Sage green  
**LD1431R3** Corten

## Componenti inclusi

### Components included

Cavo USB-c (lunghezza: 3m) incluso  
USB-c cable (length: 3m) included

Telecomando a radiofrequenza per controllo da remoto  
Radio-frequency remote control

Vaschetta contenitore multiuso  
Multipurpose container tray

Caricatore a spina  
USB charger

## Finiture Finishes

IP65



**LD1430R3**  
Corten

**LD1430D3**  
Nero / Black  
RAL 9004

**LD1430G3**  
Salvia / Sage green  
Pantone 5635 U

# Barbell Solar RF

Design Zafferano

Barbell è una lampada da terra portatile e ricaricabile dotata di pannello solare, sensore crepuscolare e sensore di movimento.

Progettata per l'uso in esterni e interni (IP65), è realizzata in materiale plastico stampato e alluminio verniciato. Completano la dotazione i sensori crepuscolare e di movimento, che attivano e regolano automaticamente la luce in base alla luminosità ambientale e alla presenza di persone.

L'illuminazione LED può essere gestita in modalità manuale oppure da remoto, tramite radiofrequenza (con telecomando, incluso). È possibile dimmerare la lampada, su 4 livelli. Inoltre è possibile regolare la temperatura di colore della luce, tra 4 valori preimpostati (2200K, 2700K, 3000K, 4000K).

La batteria può essere ricaricata tramite pannello solare ma anche tramite cavo USB type-C.

*Barbell is a cordless, rechargeable floor lamp equipped with a solar panel. Designed for both outdoor and indoor use (IP65), it is made of molded plastic and powder-coated aluminum. The dusk and motion sensors automatically turn the light on and adjust brightness according to ambient light and presence detection. The LED lighting can be controlled manually or remotely via radio frequency, using the included remote control. The lamp is dimmable, offering four brightness levels, and the color temperature can be adjusted to four preset values: 2200K, 2700K, 3000K, 4000K. The battery can be recharged via the solar panel or with a USB type-C cable.*



LINK TO VIDEO



Barbell Solar  
floor lamp Black → LD1530D3

# Barbell Solar RF

Lampada solare da terra  
*Solar floor lamp*



## Dati tecnici

### Technical data

#### LED TOUCH DIMMER

2200-2700-3000-4000 K | CRI>90  
1079-1181-1320-1398 lm | 11.7 W | IP65  
PD 65W max. 3A / PD 5Vdc max. 3A

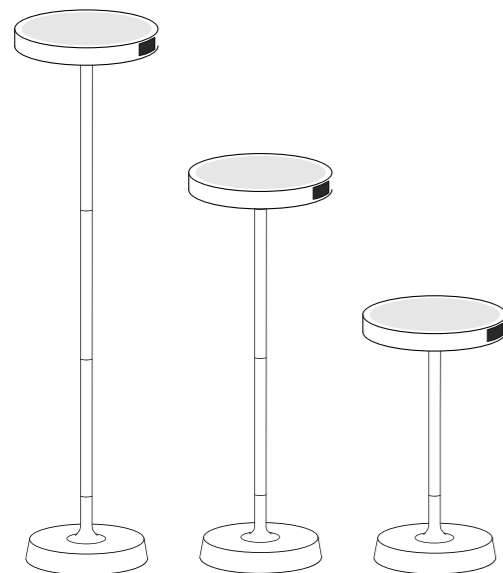

Ø 40 x 156,7 cm

Ø 40 x 113,7 cm

Ø 40 x 70,7 cm

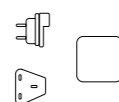
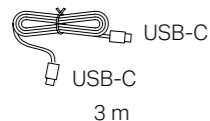

#### Componenti inclusi *Components included*

Telecomando a radiofrequenza per controllo da remoto  
*Radio-frequency remote control*

Cavo USB-c (lunghezza: 3m) incluso  
*USB-c cable (length: 3m) included*

Caricatore a spina  
*USB charger*

Dotata di sensore crepuscolare e di movimento  
*Fitted with dusk and motion sensors*

Diffusore in policarbonato  
*Polycarbonate diffuser*

Adatta all'uso esterno (lampada IP65)  
*Suitable for outdoor (lamp IP65)*

Durata batteria: luce piena 8 h; micro 37 h  
*Work time: full power 8 h; energy saving 37 h*

Tempo di ricarica PD 65W max. 15V 3A: 2 ½ h  
*Charging time PD 65W max. 15V 3A: 2 1/2 h*

Pacco batteria al litio ricaricabile e sostituibile  
*Rechargeable and replaceable lithium battery pack*

Tecnologia Radiofrequenza (RSK)  
*Radio-frequency technology (RSK)*



#### Accessori non inclusi *Accessories not included*

Vaschetta contenitore multiuso  
*Multipurpose container tray*

Ripiano / Shelf (pg. 246) → **LD1431D3** Nero / Black  
**LD1431G3** Salvia / Sage green  
**LD1431R3** Corten

## Finiture *Finishes*

IP65



**LD1530R3**  
Corten



**LD1530D3**  
Nero / Black  
RAL 9004



**LD1530G3**  
Salvia / Sage green  
Pantone 5635 U

# Poldina 230V

Design Zafferano

Poldina 230V è una collezione di lampade a tensione di rete, disponibili in diverse tipologie: da tavolo, da parete, da terra e a sospensione. È la variante alimentata a corrente della lampada più iconica del brand Zafferano, pensata per chi desidera la stessa eleganza e funzionalità, con un utilizzo continuo e senza necessità di ricarica. Le lampade sono realizzate con struttura in alluminio o pressofusione di alluminio, verniciata nei colori bianco opaco, corten o grigio scuro, e sono dotate di diffusore in policarbonato trasparente. La sorgente luminosa può essere a LED (dimmerabile) oppure a incandescenza con attacco E27 (lampadina non inclusa). La versione da tavolo a LED offre anche la funzione di selezione della temperatura di colore. Grazie all'alto indice di protezione, la tipologia da parete può essere usata anche all'esterno. È possibile personalizzare alcuni modelli con cover in vari materiali, acquistabili separatamente (pag. 68-71).

*Poldina 230V is a collection of mains-powered lamps, consisting of different types: table, wall, floor, and pendant. It is the wired version of Zafferano's most iconic lamp, designed for those who want the same elegance and functionality, with continuous use and no need for recharging.*

*The lamps feature a structure made of aluminum or die-cast aluminum, painted in matte white, corten, or dark gray, and are equipped with a transparent polycarbonate diffuser. The light source can be either LED (dimmable) or incandescent with an E27 socket (bulb not included). The LED table version also offers a color temperature selection function. Thanks to its high protection rating, the wall-mounted version can also be used outdoors. Some models can be customized with covers in various materials, to be purchased separately (pg. 68-71).*



LINK TO VIDEO



Poldina<sup>230V</sup> floor lamp + table lamp  
→ LL0360B3 + LD0345B3



Poldina<sup>230V</sup> sconce  
→ LL0348B3



Poldina<sup>230V</sup> suspension lamp  
→ LD0366R3

# Poldina 230V

Lampada da tavolo  
Table lamp

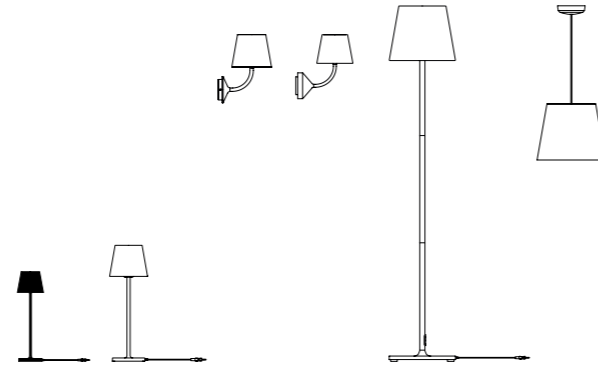

## Dati tecnici

### Technical data

#### LED TOUCH DIMMER

2200-2700-3000 K | CRI>80  
400-440-451 lm | 8.0 W | IP40  
220-240V | 50-60 Hz



Corpo in pressofusione di alluminio verniciato  
*Painted die-cast aluminum body*

Diffusore in policarbonato  
*Polycarbonate diffuser*

Adatta all'uso interno (lampada IP40)  
*Suitable for indoor use (lamp IP40)*

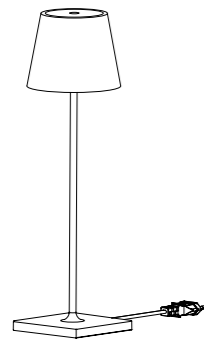

Ø 11 x 38 cm

## Finiture Finishes



IP40

**LD0345B3**  
Bianco / White  
RAL 9003

**LD0345N3**  
Grigio scuro / Dark gray

**LD0345R3**  
Corten

# Poldina 230V

Lampada da tavolo  
Table lamp

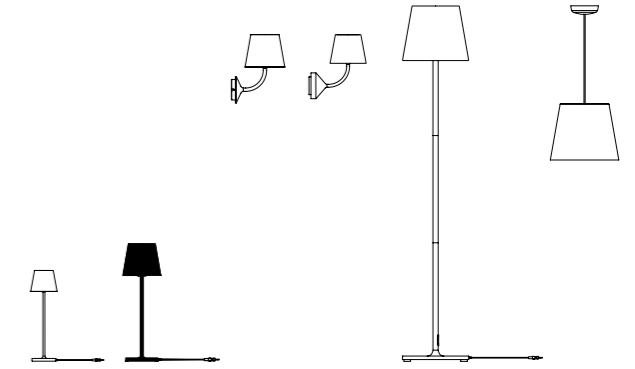

## Dati tecnici

### Technical data

**E27** | 220-240V | 50-60 Hz | 8 W | **IP40**

Lampadina / Bulb:  
Globo G45: Ø 45 x 84 mm



*Painted die-cast aluminum body*

*Diffusore in policarbonato  
Polycarbonate diffuser*

*Adatta all'uso interno (lampada IP40)  
Suitable for indoor use (lamp IP40)*

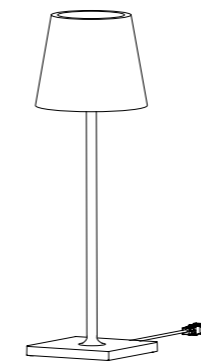

Ø 16,5 x 50,5 cm

## Finiture Finishes



IP40

**LL0395B3**  
Bianco / White  
RAL 9003

**LL0395N3**  
Grigio scuro / Dark gray

**LL0395R3**  
Corten

# Poldina 230V

Lampada da parete  
Sconce

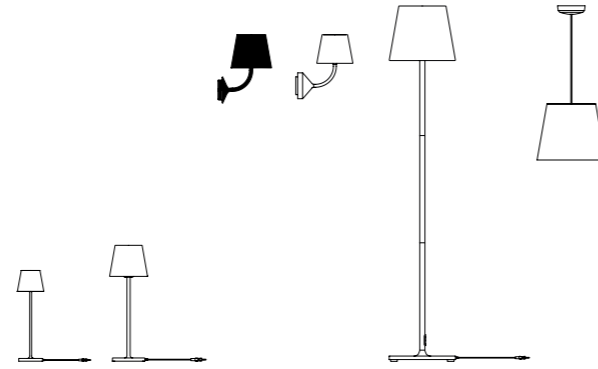

## Dati tecnici

### Technical data

**E27** | 220-240V | 50-60 Hz | 8 W | **IP54**

Lampadina (non inclusa) / *Bulb (not included)*:  
Globo G45: Ø 45 x 84 mm



Corpo in pressofusione di alluminio verniciato  
*Painted die-cast aluminum body*

Diffusore in policarbonato  
*Polycarbonate diffuser*

Adatta all'uso esterno (lampada IP54) e interno  
*Suitable for outdoor (lamp IP54) indoor use*

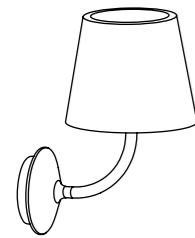

22,2 x 28,4 cm

## Finiture

### Finishes

IP54



**LL0348B3**  
Bianco / *White*  
RAL 9003

**LL0348N3**  
Grigio scuro / *Dark gray*

**LL0348R3**  
Corten

# Poldina 230V

Lampada da parete  
Sconce

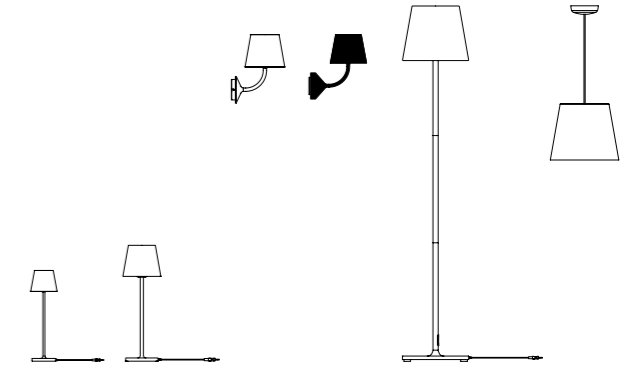

## Dati tecnici

### Technical data

**LED TRIAC**

2700 K | CRI>80  
446 lm | 5.4 W | IP54  
220-240V | 50-60 Hz



Corpo in pressofusione di alluminio verniciato  
*Painted die-cast aluminum body*

Diffusore in policarbonato  
*Polycarbonate diffuser*

Adatta all'uso esterno (lampada IP54) e interno  
*Suitable for outdoor (lamp IP54) indoor use*

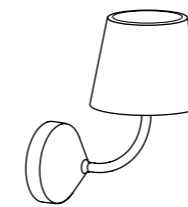

17,5 x 19,7 cm

## Finiture

### Finishes

IP54



**LD0348B3**  
Bianco / *White*  
RAL 9003

**LD0348N3**  
Grigio scuro / *Dark gray*

**LD0348R3**  
Corten

# Poldina 230V

Lampada da terra  
Floor lamp

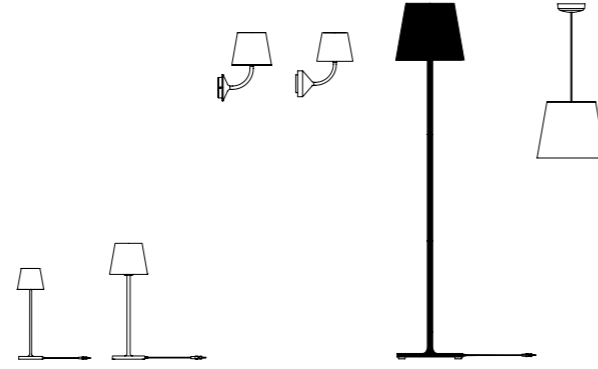

## Dati tecnici

Technical data

**E27** | 220-240V | 50-60 Hz | 15 W | **IP40**



Corpo in pressofusione di alluminio verniciato  
Painted die-cast aluminum body

Diffusore in policarbonato  
Polycarbonate diffuser

Adatta all'uso interno (lampada IP40)  
Suitable for indoor use (lamp IP40)

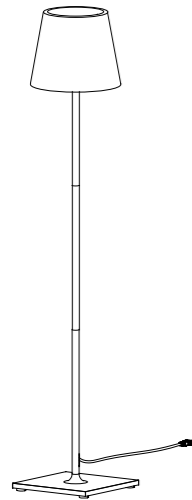

Ø 28 x 150 cm

## Finiture

Finishes



IP40

**LL0360B3**  
Bianco / White  
RAL 9003

**LL0360N3**  
Grigio scuro / Dark gray

**LL0360R3**  
Corten

# Poldina 230V

Lampada a sospensione  
Pendant

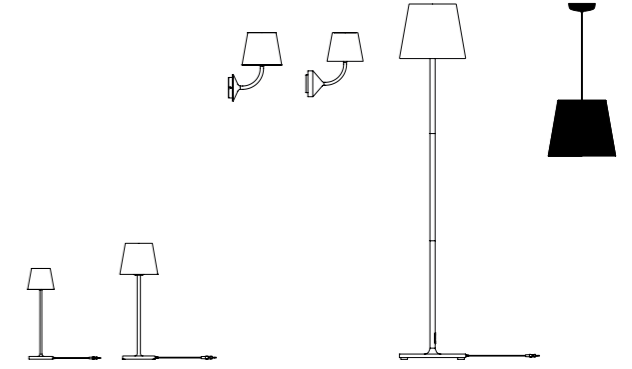

## Dati tecnici

Technical data

**LED TRIAC**

2700 K | CRI>80  
1314 lm | 12.5 W | IP40 - IP54  
220-240V | 50-60 Hz



Corpo in pressofusione di alluminio verniciato  
Painted die-cast aluminum body

Diffusore in policarbonato  
Polycarbonate diffuser

Adatta all'uso interno (lampada IP54 - rosone IP40)  
Suitable for indoor use (lamp IP54 - canopy IP40)

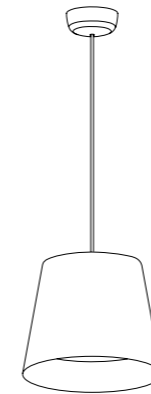

Ø 28 x 23 cm

## Finiture

Finishes



IP40 - IP54

**LD0366B3**  
Bianco / White  
RAL 9003

**LD0366N3**  
Grigio scuro / Dark gray  
RAL 9004

**LD0366R3**  
Corten

Componenti inclusi  
Components included

Rosone bianco  
White canopy

# Accessori Accessories

Cover e paralumi realizzati in diversi materiali – metallo stampato, ceramica dipinta a mano, giacinto d'acqua intrecciato a mano e tessuto – progettati per le lampade da tavolo Poldina. Questi accessori permettono di personalizzare il prodotto, modificarne l'estetica e, in alcuni casi, creare effetti luminosi inediti, adattandolo a differenti contesti d'uso e soluzioni progettuali.

*Covers and lampshades made from various materials – printed metal, hand-painted ceramic, handwoven water hyacinth, and fabric – designed for Poldina cordless table lamps. These accessories allow for product customization, aesthetic variation, and, in some cases, the creation of unique lighting effects, making them adaptable to different usage contexts and design solutions.*



# Poldina

Cover in metallo  
Metallic cover

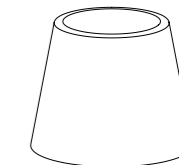

Ø 11,5 x 9 cm

Compatibile con i modelli di Poldina Pro: tavolo, mini tavolo, picchetto, sospensione, parete, stopper; Poldina 230V: tavolo, parete (LD0348).  
Compatible with Poldina Pro models: table, mini table, lamp with peg, suspension, wall, stopper; Poldina 230V: table and wall (LD0348).



**LD035115**  
Fiori rosa  
Pink flowers



**LD035116**  
Fiori verdi  
Green flowers



**LD035117**  
Fiori rossi  
Red flowers



**LD035118**  
Fiori verdi scuro  
Dark green flowers



**LD035119**  
Ortensia rosa  
Pink hydrangea



**LD035120**  
Ortensia blu  
Blue hydrangea



**LD035108**  
Pesci blu Avio  
Avio blue fishes



**LD035121**  
Pere gialle  
Yellow pears



**LD035122**  
Mele rosse  
Red apples



**LD035123**  
Righe marroni-verdi  
Brown-green stripes



**LD035142**  
Righe ocra  
Ochre stripes



**LD035143**  
Righe marroni  
Brown stripes



**LD035144**  
Aviator



**LD035145**  
Heart



**LD035146**  
Friends



**LD035147**  
Strip



**LD035148**  
Together

# Poldina

Cover in ceramica  
Ceramic cover

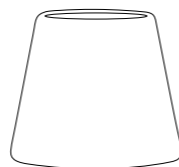

Ø 13 x 10 cm

Compatibile con i modelli di Poldina Pro: tavolo, mini tavolo, picchetto, sospensione, parete; Poldina stopper; Poldina 230V: tavolo, parete (LD0348)  
Compatible with Poldina Pro models: table, mini table, lamp with peg, suspension, wall; Poldina stopper; Poldina 230V: table and wall (LD0348).



**LD035000**  
Righe verdi  
Green stripes

**LD035001**  
Righe gialle  
Yellow stripes

**LD035002**  
Righe blu Capri  
Capri blue stripes

**LD035003**  
Righe rosse  
Red stripes

**LD035010**  
Righe nere  
Black stripes

**LD035004**  
Pesci azzurri  
Light blue fish



Ø 8,5 x 6,6 cm

Compatibile con i modelli di Poldina Pro: micro tavolo.  
Compatible with Poldina Pro models: micro table.



**LD049900**  
Righe verdi  
Green stripes

**LD049902**  
Righe blu Capri  
Capri blue stripes

**LD049903**  
Righe rosse  
Red stripes

**LD049905**  
Righe arancio  
Orange stripes

**LD049910**  
Righe nere  
Black stripes

**LD049904**  
Pesci azzurri  
Light blue fish

# Poldina

Cover in giacinto d'acqua  
Water hyacinth woven cover

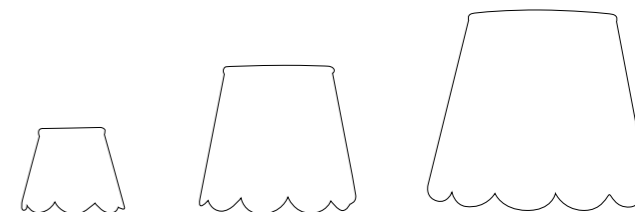

Ø 14,5 x 12,5 cm

Ø 19,5 x 17,5 cm

Ø 31,5 x 27 cm

Compatibile con i modelli di Poldina Pro: tavolo, mini tavolo, picchetto, sospensione, parete, stopper; Poldina 230V: tavolo, parete (LD0348).

Compatible with Poldina Pro models: table, mini table, lamp with peg, suspension, wall, stopper; Poldina 230V: table and wall (LD0348).

Compatibile con i modelli di Poldina Pro: L desk tavolo, L tavolo-terra; Poldina 230V: tavolo (LL0395), parete (LL0348)  
Compatible with Poldina Pro models: L desk table, L floor-table; Poldina 230V: table (LL0395), wall (LL0348)

Compatibile con i modelli di Poldina Pro: tavolo, mini tavolo, picchetto, sospensione, parete, stopper; Poldina 230V: tavolo, parete (LD0348).

Compatible with Poldina Pro models: table, mini table, lamp with peg, suspension, wall, stopper; Poldina 230V: table and wall (LD0348).



**LD035500**



**LD035501**



**LD035502**

# Perpetua PRO

Design BrogliatoTraverso

Nata reinterpretando l'archetipo del candelabro, Perpetua è una collezione di lampade senza fili pensata per durare nel tempo.

Prodotta nella versione da tavolo, è disponibile in tre forme (due a stelo singolo e una a due bracci) e in tre finiture: nero, rosso e foglia color oro.

Il pacco batterie, la cui forma cilindrica richiama quella di una candela, si aggancia magneticamente alla struttura in alluminio pressofuso, la quale integra una sorgente luminosa LED che emette una luce intensa e diretta verso il basso.

Il comando touch, collocato al posto dello stoppino, permette l'accensione, lo spegnimento, la regolazione dell'intensità luminosa e la selezione di quattro temperature di colore.

Il pacco batteria si ricarica tramite l'apposita base a contatto; all'occorrenza, esso può essere sostituito con un elemento già carico, consentendo un utilizzo della lampada senza interruzioni. Come accessorio è disponibile anche una base di ricarica multipla, molto compatta, che consente di ricaricare contemporaneamente fino a otto "candele": una soluzione ideale per l'uso professionale.

Grazie al grado di protezione IP54, le lampade possono essere utilizzate anche all'esterno, ad eccezione dei modelli con finitura a foglia metallica, per i quali non si consiglia un uso prolungato in ambienti esterni.

*Referencing the archetypal candlestick, Perpetua is a collection of cordless lamps designed to last over time.*

*Produced as a table version, it is available in three shapes (two single-stem models and one two-arm model) and in three finishes: black, red, and gold color leaf.*

*The battery pack, whose cylindrical form recalls a candle, attaches magnetically to the die-cast aluminum structure, which integrates an LED light source emitting an intense, downward-directed beam.*

*A touch control, positioned where the wick would traditionally be, allows switching the lamp on and off, adjusting light intensity, and selecting four color temperatures.*

*The battery pack recharges via the dedicated contact charging base; when needed, it can be replaced with a fully charged unit, ensuring uninterrupted use of the lamp. As an accessory, a compact multi-unit charging base is also available, allowing up to eight battery packs to be recharged simultaneously: an ideal solution for restaurants and professional settings.*

*Thanks to its IP54 protection rating, the lamp can also be used outdoors, with the exception of models featuring a metal leaf finish, which are not recommended for prolonged outdoor use.*



LINK TO VIDEO



Perpetua table lamp  
→ LD1172D3 + LD1170D3 + LD1171D3



Perpetua table lamp  
→ LD1171F3 + LD1171DFO + LD1171D3



Perpetua table lamp  
→ LD1172F3

# Perpetua <sup>PRO</sup>

Lampada da tavolo  
Table lamp

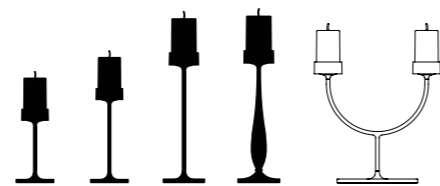

## Dati tecnici

### Technical data

#### LED TOUCH DIMMER

2200-2700-3000-4000K | CRI>90  
216-222-240-261lm | 2.2W | IP54  
5 Vdc max 2A

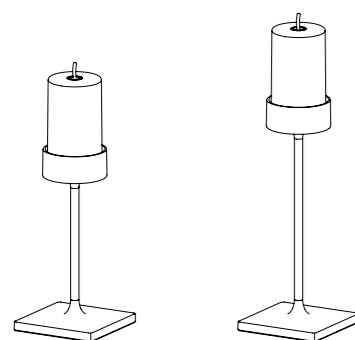

8,7 x 25,6 cm

8,7 x 30,6 cm

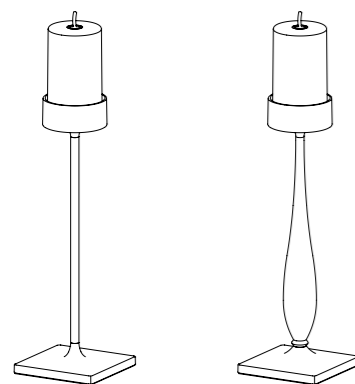

8,7 x 35,6 cm

8,7 x 35,6 cm

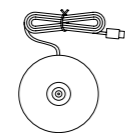

Ø 5,6 cm

Componenti inclusi  
Components included

Base di ricarica a contatto (USB-C)  
Contact charging base (USB-C)

Corpo in pressofusione di alluminio verniciato  
*Painted die-cast aluminum body*

Diffusore in policarbonato  
*Polycarbonate diffuser*

Adatta all'uso esterno (lampada IP54) e interno  
(lampada su base di ricarica IP20)  
*Suitable for outdoor (lamp IP54) and indoor use (lamp  
on charging base IP20)*

Durata di circa 8 h alla massima potenza  
*Battery lasts about 8 h at full power*

Tempo di ricarica a 2A: 3 h  
*Charging time at 2A: 3 h*

Pacco batteria al litio ricaricabile e sostituibile  
*Rechargeable and replaceable lithium battery pack*

### Avvertenze Remarks

Le lampade con finitura in foglia oro non sono adatte ad un uso prolungato in ambiente esterno.  
*The lamps with gold metallic-leaf finish are not suitable for prolonged outdoor use.*

Per effetto della natura manuale della tecnica adottata nella lavorazione con foglia metallica, l'aspetto finale della finitura delle lampade può risultare differente. Eventuali difformità attestano il pregio e l'unicità di ciascuna lampada e non vanno considerate come imperfezioni.

*Due to the manual nature of the technique adopted in the application of the metal foil, the final appearance of the lamps' finishing can be different. Any apparent imperfections attest to the quality and exclusivity of each lamp and should not be considered as imperfections.*

### Accessori non inclusi Accessories not included

Caricatore a spina / USB charger → **LD1490UA**  
5V max 2A | 200-240V | USB-C (pg. 247)

Base di ricarica a contatto multipla 8 posti → **LD1170RP**  
*Multi-contact charging base 8 slots (pg.249)*

## Finiture Finishes

IP54



**LD1174D3**  
Nero / Black  
RAL 9005



**LD1173D3**  
Nero / Black  
RAL 9005



**LD1170D3**  
Nero / Black  
RAL 9005



**LD1171D3**  
Nero / Black  
RAL 9005



**LD1174F3**  
Rosso / Red  
RAL 3000



**LD1173F3**  
Rosso Red  
RAL 9003



**LD1170F3**  
Rosso / Red  
RAL 3000



**LD1171F3**  
Rosso / Red  
RAL 3000



**LD1174DFO \***  
Foglia color oro /  
Gold color leaf



**LD1173DFO \***  
Foglia color oro /  
Gold color leaf



**LD1170DFO \***  
Foglia color oro /  
Gold color leaf



**LD1171DFO \***  
Foglia color oro /  
Gold color leaf

\* Le lampade con finitura in foglia oro non sono adatte ad un uso prolungato in ambiente esterno.

\* The lamps with gold metallic-leaf finish are not suitable for prolonged outdoor use.

# Perpetua <sup>PRO</sup>

Lampada da tavolo  
Table lamp

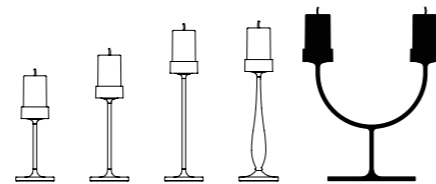

## Dati tecnici

### Technical data

#### LED TOUCH DIMMER

2200-2700-3000-4000K | CRI>90  
2x216-2x222-2x240-2x261lm | 2x2.2W | IP54  
5 Vdc max 2A



Corpo in pressofusione di alluminio verniciato  
*Painted die-cast aluminum body*

Diffusore in policarbonato  
*Polycarbonate diffuser*

Adatta all'uso esterno (lampada IP54) e interno  
(lampada su base di ricarica IP20)  
*Suitable for outdoor (lamp IP54) and indoor use (lamp  
on charging base IP20)*

Durata di circa 8 h alla massima potenza  
*Battery lasts about 8 h at full power*

Tempo di ricarica a 2A: 3 h  
*Charging time at 2A: 3 h*

Pacco batteria al litio ricaricabile e sostituibile  
*Rechargeable and replaceable lithium battery pack*

#### Avvertenze Remarks

Le lampade con finitura in foglia oro non sono adatte ad un uso prolungato in ambiente esterno.  
*The lamps with gold metallic-leaf finish are not suitable for prolonged outdoor use.*

Per effetto della natura manuale della tecnica adottata nella lavorazione con foglia metallica, l'aspetto finale della finitura delle lampade può risultare differente. Eventuali difformità attestano il pregio e l'unicità di ciascuna lampada e non vanno considerate come imperfezioni.

*Due to the manual nature of the technique adopted in the application of the metal foil, the final appearance of the lamps' finishing can be different. Any apparent imperfections attest to the quality and exclusivity of each lamp and should not be considered as imperfections.*

#### Accessori non inclusi Accessories not included

Caricatore a spina / USB charger → **LD1490UA**  
5V max 2A | 200-240V | USB-C (pg. 247)

Base di ricarica a contatto multipla 8 posti → **LD1170RP**  
*Multi-contact charging base 8 slots (pg.249)*

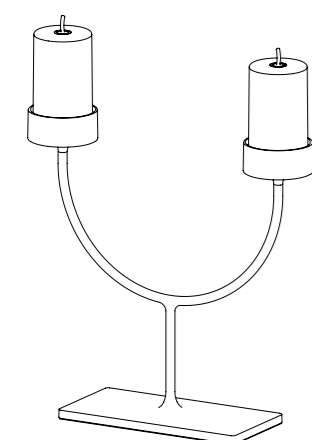

18 x 35,6 cm

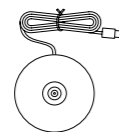

Ø 5,6 cm

#### Componenti inclusi Components included

Base di ricarica a contatto (USB-C)  
*Contact charging base (USB-C)*

## Finiture Finishes

IP54



#### LD1172D3

Nero / Black  
RAL 9005



#### LD1172F3

Rosso / Red  
RAL 3000



#### LD1172DFO\*

Foglia color oro /  
Gold color leaf



\* Le lampade con finitura in foglia oro non sono adatte ad un uso prolungato in ambiente esterno.

\* The lamps with gold metallic-leaf finish are not suitable for prolonged outdoor use.

# Angelina<sup>PRO</sup>

Design Zafferano



Angelina è una lampada da tavolo a batteria, portatile e ricaricabile, con testa orientabile. Nella parte inferiore della testa è presente un controllo "touch", che permette l'accensione, la regolazione dell'intensità luminosa e la selezione della temperatura di colore della luce. La lampada è adatta esclusivamente a uso interno. Un sistema di controllo elettronico monitora e segnala l'autonomia residua della batteria, permettendo di ottimizzare le ricariche. È dotata di base di ricarica a contatto.

*Angelina is a cordless, rechargeable battery table lamp with a tilting lamp head. A touch control placed on the lower part of the lamp head allows switching on/off, dimming, and selecting the color temperature (K). Designed for indoor use only, the lamp features an electronic control system that monitors and indicates the remaining battery life, allowing for optimized charging. The lamp is equipped with a contact charging base.*



LINK TO VIDEO



Angelina table lamp  
red → LD1210F3

# Angelina<sup>PRO</sup>

Lampada da tavolo  
Table lamp



## Dati tecnici

### Technical data

#### LED TOUCH DIMMER

2200-2700-3000 K | CRI>90  
200-213-239 lm | 2.2 W | IP20  
5V max.2A



Corpo in pressofusione di alluminio verniciato  
*Painted die-cast aluminum body*

Diffusore in policarbonato opale  
*Opal polycarbonate diffuser*

Testa orientabile  
*Tilttable head*

Adatta all'uso interno (lampada IP20)  
*Suitable for indoor (lamp IP20)*

Durata di circa 10/11 h alla massima potenza  
*Battery lasts about 10/11 h at full power*

Tempo di ricarica a 2A: 3/4 h  
*Charging time at 2A: 3/4 h*

Pacco batteria al litio ricaricabile e sostituibile  
*Rechargeable and replaceable lithium battery pack*

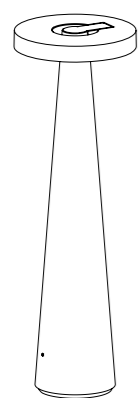

Ø 8,6 x 26 cm

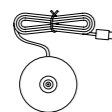

Ø 5,1 cm



#### Componenti inclusi Components included

Base di ricarica a contatto (USB-A)  
*Contact charging base (USB-A)*

#### Accessori non inclusi Accessories not included

Caricatore a spina / USB charger → **LD0300UC**  
5 V max 2,1A | 100-240V | USB-A (pg. 247)

## Finiture Finishes

IP20



**LD1210B3**  
Bianco / White  
RAL 9003



**LD1210D3**  
Nero / Black  
RAL 9004



**LD1210F3**  
Rosso / Red  
RAL 3000



**LD1210Y3**  
Grigio / Gray  
RAL 7040



# Carolina<sup>PRO</sup>

Design Zafferano

Carolina è una lampada da tavolo a batteria, portatile e ricaricabile. Un pulsante integrato nella parte superiore della base della lampada permette l'accensione, la regolazione dell'intensità luminosa e la selezione della temperatura di colore della luce. Grazie all'elevato grado di protezione, la lampada può essere utilizzata anche all'esterno, ad eccezione dei modelli con finitura galvanica, per i quale non si consiglia un uso prolungato in ambienti esterni. Un sistema di controllo elettronico monitora e segnala l'autonomia residua della batteria, permettendo di ottimizzare le ricariche. È dotata di base di ricarica a contatto.

*Carolina is a cordless, rechargeable battery table lamp. A button integrated into the upper part of the lamp base allows switching on/off, dimming, and selecting the color temperature (K). With its high protection rating, the lamp is suitable for both indoor and outdoor use, except for the models with a galvanic finish, which are not recommended for prolonged outdoor exposure. The lamp features an electronic control system that monitors and indicates the remaining battery life, allowing for optimized charging. The lamp is equipped with a contact charging base.*



LINK TO VIDEO



Carolina table lamp Glossy white  
→ LD1460BB

# Carolina <sup>PRO</sup>

Lampada da tavolo  
Table lamp



## Dati tecnici

### Technical data

#### LED TOUCH DIMMER

2200-2700-3000 K | CRI>80  
161-194-182 lm | 2.0 W | IP65  
5 V max 1A



Corpo in pressofusione di alluminio verniciato  
*Painted die-cast aluminum body*

Paralume in metallo spazzolato o verniciato lucido  
*Brushed metal or polished painted lampshade*

Diffusore in policarbonato opale  
*Opal polycarbonate diffuser*

Adatta all'uso esterno (lampada IP65) e interno  
(lampada su base di ricarica IP20)

*Suitable for outdoor (lamp IP65) and indoor use (lamp on charging base IP20)*

Durata di circa 9 h alla massima potenza  
*Battery lasts about 9 h at full power*

Tempo di ricarica a 1A: 3 ½ h  
*Charging time at 1A: 3 ½ h*

Pacco batteria al litio ricaricabile e sostituibile  
*Rechargeable and replaceable lithium battery pack*

#### Avvertenze Remarks

Le lampade con finitura galvanica non sono adatte ad un uso prolungato in ambiente esterno.

*The lamps with glossy finishes are not suitable for prolonged outdoor use.*

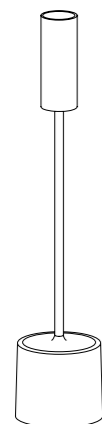

Ø 6 x 28,6 cm

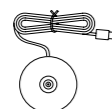

Ø 6,7 cm

#### Componenti inclusi Components included

Base di ricarica a contatto (USB-C)  
*Contact charging base (USB-C)*

#### Accessori non inclusi Accessories not included

Caricatore a spina / *USB charger* → **LD1490UA**  
5V max 2A | 200-240V | USB-C (pg. 247)

## Finiture Finishes

IP65



**LD1460BB**  
Bianco lucido / *Glossy white*



**LD1460BO \***  
Bianco lucido - Ottone  
spazzolato / *Glossy white -  
Brushed brass \**



**LD1460DO \***  
Nero lucido - Ottone  
spazzolato / *Glossy black -  
Brushed brass \**



**LD1460IW \***  
Avorio lucido - Bronzo  
spazzolato / *Glossy ivory -  
Brushed bronze \**



**LD146000 \***  
Ottone Spazzolato /  
*Brushed Brass*

\* Le lampade con finitura galvanica non sono adatte ad un uso prolungato in ambiente esterno.

*\* The lamps with glossy finishes are not suitable for prolonged outdoor use.*

# Damina<sup>PRO</sup>

Design Zafferano

Damina è una lampada da tavolo a batteria, portatile e ricaricabile. Nella parte superiore della testa è presente un controllo "touch", che permette l'accensione, la regolazione dell'intensità luminosa e la selezione della temperatura di colore della luce. Grazie a un alto indice di protezione, la lampada è utilizzabile anche all'esterno. Un sistema di controllo elettronico monitora e segnala l'autonomia residua della batteria, permettendo di ottimizzare le ricariche. È dotata di base di ricarica a contatto.

*Damina is a cordless, rechargeable battery table lamp. A touch control placed on the lamp head allows switching on/off, dimming, and selecting the color temperature (K). Suitable for both indoor and outdoor use, the lamp features an electronic control system that monitors and indicates the remaining battery life, allowing for optimized charging. The lamp is equipped with a contact charging base.*



LINK TO VIDEO



Damina table lamp  
gray → **LD1600Y3**

# Damina<sup>PRO</sup>

Lampada da tavolo  
Table lamp



## Dati tecnici

### Technical data

#### LED TOUCH DIMMER

2200-2700-3000 K | CRI>90  
164-171-185 lm | 1.8 W | IP65  
5V max.1A



Corpo in pressofusione di alluminio verniciato  
*Painted die-cast aluminum body*

Diffusore in policarbonato opale  
*Opal polycarbonate diffuser*

Adatta all'uso esterno (lampada IP65) e interno  
(lampada su base di ricarica IP20)  
*Suitable for outdoor (lamp IP65) and indoor use (lamp  
on charging base IP20)*

Durata di circa 8 h alla massima potenza  
*Battery lasts about 8 h at full power*

Tempo di ricarica a 1A: 4 h  
*Charging time at 1A: 4 h*

Pacco batteria al litio ricaricabile e sostituibile  
*Rechargeable and replaceable lithium battery pack*

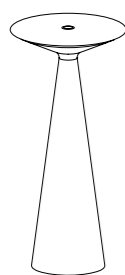

Ø 9 x 19,3 cm

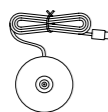

Ø 5,5 cm

#### Componenti inclusi Components included

Base di ricarica a contatto (USB-C)  
*Contact charging base (USB-C)*

#### Accessori non inclusi Accessories not included

Caricatore a spina / USB charger → **LD1490UA**  
5V max 2A | 200-240V | USB-C (pg. 247)

## Finiture Finishes

IP65



**LD1600B3**  
Bianco / White  
RAL 9003



**LD1600D3**  
Nero / Black  
RAL 9004



**LD1600F3**  
Rosso / Red  
RAL 3000



**LD1600Y3**  
Grigio / Gray  
RAL 7040



# Dondolina<sup>PRO</sup>



Design Pio e Tito Tosso

Dondolina è una lampada da tavolo a batteria, portatile e ricaricabile. Il baricentro ottimizzato consente alla lampada di restare sempre in equilibrio verticale: se spinta, inclinata o addirittura distesa, essa torna automaticamente in posizione eretta, assicurando stabilità e funzionalità.

Nella parte superiore della testa è presente un controllo "touch", che permette l'accensione, la dimmerazione a 4 step e la selezione della temperatura di colore della luce. La lampada offre inoltre la possibilità di memorizzare manualmente l'impostazione della dimmerazione: all'accensione successiva, l'intensità luminosa sarà quella selezionata in precedenza. Grazie all'alto indice di protezione, la lampada è utilizzabile anche all'esterno.

Un sistema di controllo elettronico garantisce un flusso luminoso costante fino all'esaurimento della batteria, monitora e segnala l'autonomia residua, permettendo di ottimizzare le ricariche. È dotata di base di ricarica a contatto.

*Dondolina is a cordless, rechargeable battery lamp. The optimized center of gravity allows the lamp to remain perfectly balanced in a vertical position: if pushed, tilted, or even laid down, it automatically returns - like a roly-poly toy - to an upright position, ensuring stability and functionality.*

*A touch control placed on the lamp head allows switching on/off, 4-step dimming (100%, 60%, 30%, 6%) and selecting the color temperature (K). The lamp also has memory function for dimming setting: when turned on again, the light level will be the previously selected one. Suitable for both indoor and outdoor use, the lamp features an electronic control system that ensures a constant light output until the battery is depleted, monitors the remaining battery autonomy, and indicates it, helping to optimize charging. The lamp is equipped with a contact charging base.*



LINK TO VIDEO



Dondolina table lamp  
bronze → LD1110W3

# Dondolina<sup>PRO</sup>

Lampada da tavolo  
Table lamp



## Dati tecnici

### Technical data

#### LED TOUCH DIMMER

2200-2700-3000 K | CRI>90  
224-280-308 lm | 2.2 W | IP65  
5V max.2A

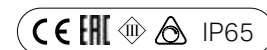

Corpo in pressofusione di alluminio verniciato  
*Painted die-cast aluminum body*

Diffusore in policarbonato  
*Polycarbonate diffuser*

Adatta all'uso esterno (lampada IP65) e interno (lampada su base di ricarica IP20)  
*Suitable for outdoor (lamp IP65) and indoor use (lamp on charging base IP20)*

Durata di circa 8/9 h alla massima potenza  
*Battery lasts about 8/9 h at full power*

Tempo di ricarica a 2A: 2/3 h  
*Charging time at 2A: 2/3 h*

Pacco batteria al litio ricaricabile e sostituibile  
*Rechargeable and replaceable lithium battery pack*

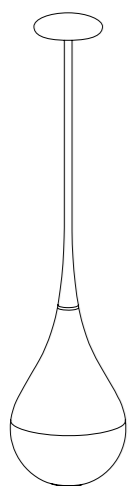

Ø 9 x 37 cm

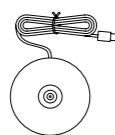

Ø 7,5 cm

### Componenti inclusi Components included

Base di ricarica a contatto (USB-C)  
*Contact charging base (USB-C)*

### Accessori non inclusi Accessories not included

Caricatore a spina / USB charger → **LD1490UA**  
5V max 2A | 200-240V | USB-C (pg. 247)

## Finiture Finishes

IP65



**LD1110B3**  
Bianco / White  
WRW



**LD1110D3**  
Nero / Black  
RAL 9004



**LD1110F3**  
Rosso / Red  
RAL 3000



**LD1110W3**  
Bronzo / Bronze  
MBR



**LD1110O3**  
Oro opaco / Matt  
gold  
MGO



# Filo

Design Federico de Majo

Filo è una collezione di lampade a tensione di rete, per uso interno, disponibili in diverse tipologie: da parete in due dimensioni, da terra e da tavolo in due modelli: con base e con morsetto.

Le lampade sono realizzate con una struttura in metallo, disponibile in tre finiture opache: rosso, bianco o nero. La parte superiore delle lampade può ruotare attorno al proprio asse verticale (200°), consentendo di orientare facilmente la luce secondo le necessità.

Ogni modello è fornito con cavo nero e una speciale lampadina LED E27 appositamente sviluppata, completa di cover in tinta con la struttura: il LED è inglobato in una calotta in silicone che funge da lente, concentrando la luce verso il basso e garantendo un'ottima illuminazione del piano, senza abbagliamento laterale. Inoltre, un piccolo peso è integrato nella sorgente luminosa per mantenere il cavo perfettamente teso.

*Filo is a collection of mains-powered indoor lamps, available in different types: sconces (in two sizes), floor lamp, and table lamp in two versions, with base or with clamp. The lamps feature a painted metal structure, available in three matte finishes — red, white, or black. The upper part of the lamp can rotate around its vertical axis (200°), allowing the light to be easily directed as needed.*

*All models are supplied with a black cable and a specially designed LED E27 bulb with a cover matching the structure. The LED is embedded in a silicone dome that acts as a lens, focusing the light downwards and ensuring excellent surface illumination without lateral glare. In addition, a small weight is integrated into the light source to keep the cable perfectly taut.*



LINK TO VIDEO



Filo table lamp red  
→ LL1260F3

Table lamp with clamp black  
 → LL1262D3



Sconce lamp white  
 → LL1263B3



Filo floor lamp red  
→ LL1261F3



Table lamp with clamp black  
→ LL1262D3

# Filo

Lampada da tavolo  
*Table lamp*

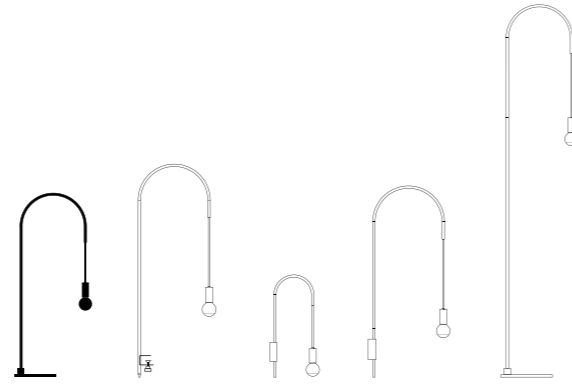

## Dati tecnici

### Technical data

**E27** | 220-240V | 50-60Hz | 1x max 60W | **IP20**

Corpo in metallo verniciato  
*Painted metal body*

Cavo e filo di colore nero  
*Black cable and wire*

Arco rotante  
*Rotating arc*

Adatta all'uso interno (lampada IP20)  
*Suitable for indoor (lamp IP20)*



Con interruttore  
*With switch*

CE ENEC IP20

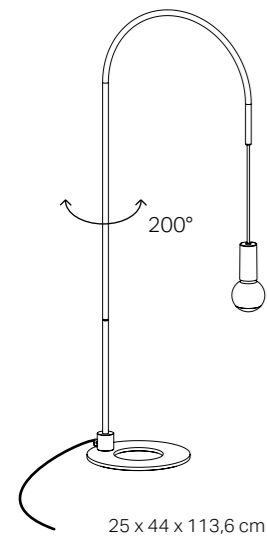

## Finiture *Finishes*

IP20



**LL1260B3**  
Bianco / *White*  
RAL 9003



**LL1260F3**  
Rosso / *Red*  
RAL 3000



**LL1260D3**  
Nero / *Black*  
RAL 9005

## Componenti inclusi *Components included*

Lampadina E27  
*Bulb E27*  
3000K | CRI 80 | 806 lm | 5,9 W  
**LD0812800** (pg. 246)



# Filo

Lampada da tavolo con morsetto  
Table lamp with clamp

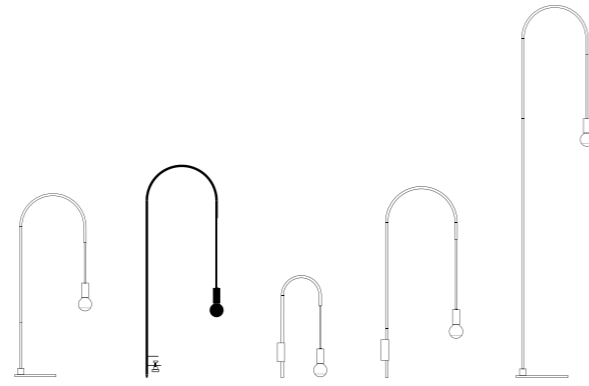

## Dati tecnici

### Technical data

**E27** | 220-240V | 50-60Hz | 1x max 60W | **IP20**

Corpo in metallo verniciato  
Painted metal body

Cavo e filo di colore nero  
Black cable and wire

Arco rotante  
Rotating arc

Adatta all'uso interno (lampada IP20)  
Suitable for indoor (lamp IP20)

CE ENEC IP20

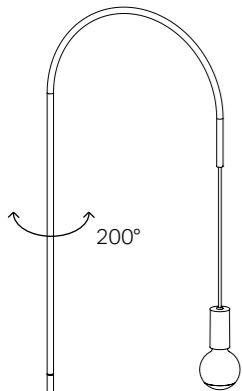

Con interruttore  
With switch

8 x 41,3 x 152,3 cm

## Componenti inclusi Components included

Lampadina E27  
Bulb E27  
3000K | CRI 80 | 806 lm | 5,9 W  
**LD0812800** (pg. 246)



## Finiture Finishes

IP20

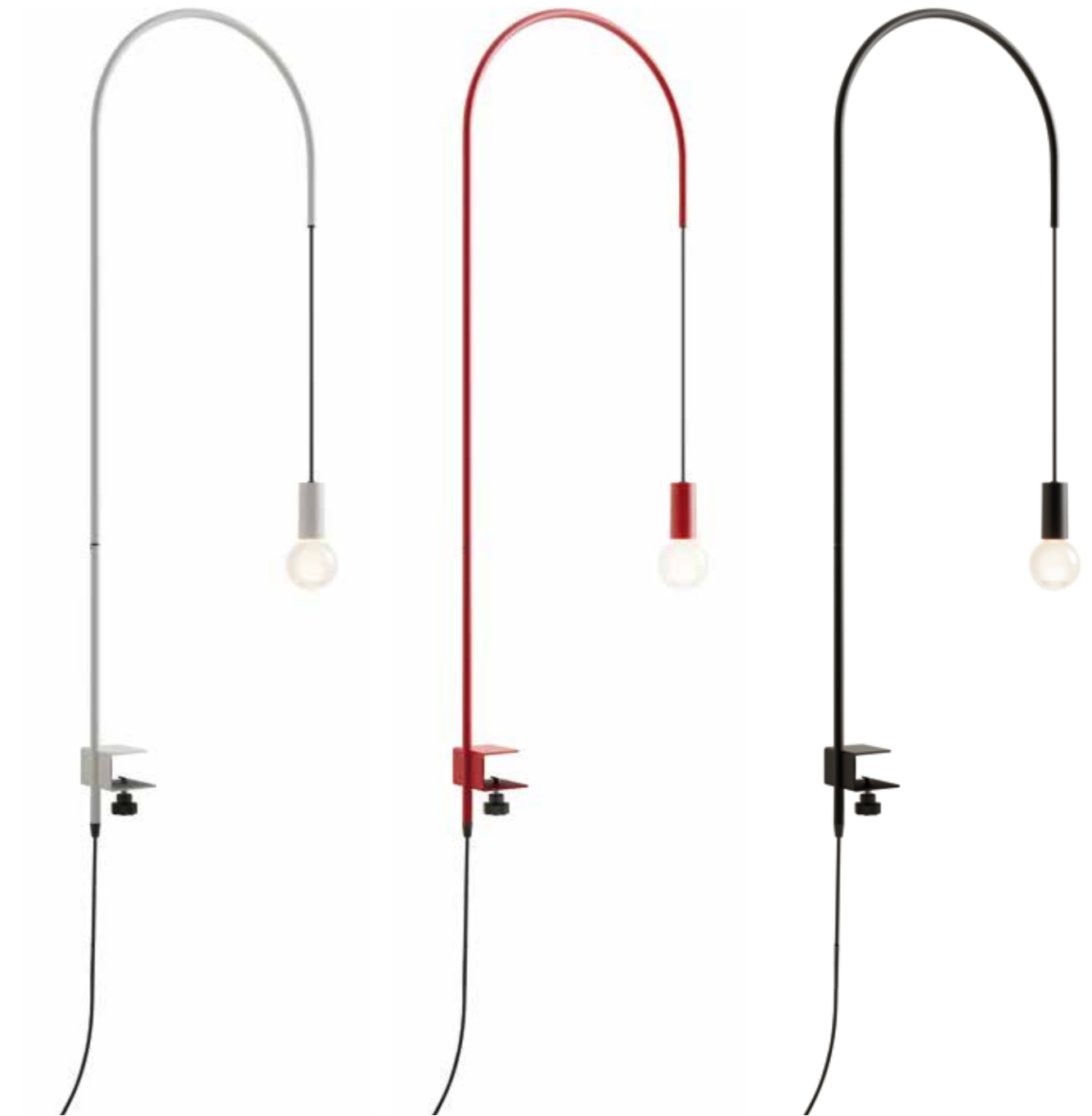

**LL1262B3**  
Bianco / White  
RAL 9003

**LL1262F3**  
Rosso / Red  
RAL 3000

**LL1262D3**  
Nero / Black  
RAL 9005

# Filo

Lampada da parete  
Sconce

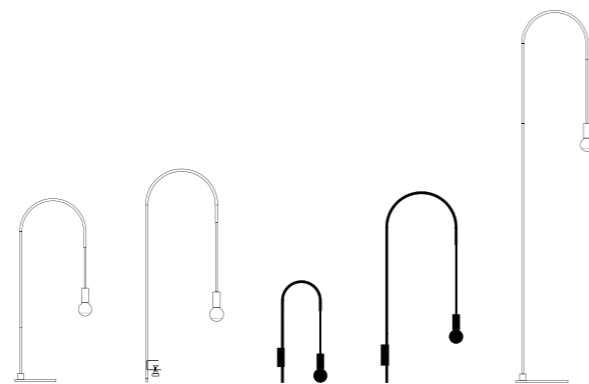

## Dati tecnici

### Technical data

**E27** | 220-240V | 50-60Hz | 1x max 60W | **IP20**

Corpo in metallo verniciato  
*Painted metal body*

Cavo e filo di colore nero  
*Black cable and wire*

Arco rotante  
*Rotating arc*

Adatta all'uso interno (lampada IP20)  
*Suitable for indoor (lamp IP20)*

CE ENEC IP20

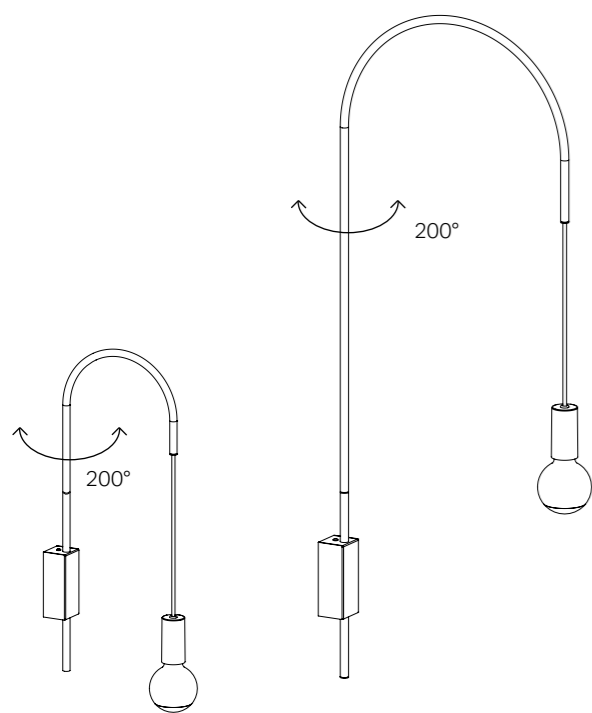

4 x 27,4 x 61,2 cm

4 x 45,4 x 110,3 cm

## Componenti inclusi Components included

Lampadina E27  
*Bulb E27*  
3000K | CRI 80 | 806 lm | 5,9 W  
**LD0812800** (pg. 246)



## Finiture

### Finishes

IP20



**LL1263B3**  
Bianco / *White*  
RAL 9003



**LL1263F3**  
Rosso / *Red*  
RAL 3000



**LL1263D3**  
Nero / *Black*  
RAL 9005



**LL1264B3**  
Bianco / *White*  
RAL 9003



**LL1264F3**  
Rosso / *Red*  
RAL 3000



**LL1264D3**  
Nero / *Black*  
RAL 9005

# Filo

Lampada da terra  
Floor lamp

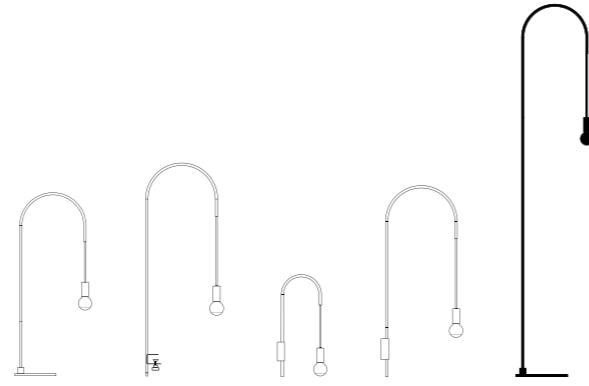

## Dati tecnici

### Technical data

**E27** | 220-240V | 50-60Hz | 1x max 60W | **IP20**

Corpo in metallo verniciato  
*Painted metal body*

Cavo e filo di colore nero  
*Black cable and wire*

Arco rotante  
*Rotating arc*

Adatta all'uso interno (lampada IP20)  
*Suitable for indoor (lamp IP20)*

CE ENEC IP20

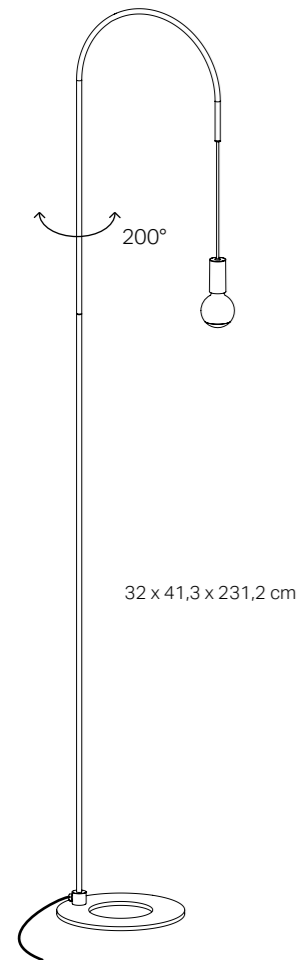

Con interruttore  
*With switch*

## Componenti inclusi Components included

Lampadina E27  
*Bulb E27*  
3000K | CRI 80 | 806 lm | 5,9 W  
**LD0812800** (pg. 246)



## Finiture Finishes

IP20



**LL1261B3**  
Bianco / *White*  
RAL 9003

**LL1261F3**  
Rosso / *Red*  
RAL 3000

**LL1261D3**  
Nero / *Black*  
RAL 9005

# Flaminia <sup>PRO</sup>

Design Zafferano

Flaminia è una lampada da tavolo a batteria, portatile e ricaricabile, caratterizzata da un paralume in tessuto plissettato. Il modulo luminoso, dotato di attacco magnetico, può essere facilmente rimosso dalla lampada, rendendo semplice e immediata l'operazione di ricarica sull'apposita base a contatto, inclusa nella confezione. Il modulo luminoso è acquistabile anche separatamente. Questo consente a chi utilizza la lampada in ambito professionale, di poter disporre di moduli di riserva: in caso di necessità, si può sostituire immediatamente un modulo scarico con uno già carico e pronto all'uso, senza dover attendere la ricarica della lampada. Nella parte superiore del modulo è presente un controllo "touch", che permette l'accensione, la regolazione dell'intensità luminosa e la selezione della temperatura di colore della luce. La lampada è adatta esclusivamente a uso interno. Un sistema di controllo elettronico monitora e segnala l'autonomia residua della batteria, permettendo di ottimizzare le ricariche.

*Flaminia is a cordless, rechargeable battery table lamp, featuring a pleated fabric lampshade. The LED module, equipped with a magnetic mount, can be easily detached, removed and recharged on the included contact charging base, making the process quick and effortless. The LED module is also available for separate purchase. This allows professionals, such as those in the hospitality industry, to keep spare modules on hand: if needed, a depleted module can be immediately replaced with one that is already charged and ready to use, without having to wait for the lamp to recharge.*

*A touch control placed on the lamp head allows switching on/off, dimming, and selecting the color temperature (K).*

*Designed for indoor use only, the lamp features an electronic control system that monitors and indicates the remaining battery life, allowing for optimized charging.*



LINK TO VIDEO



Flaminia table lamp bronze  
→ LD1240W3

# Flaminia<sup>PRO</sup>

Lampada da tavolo  
Table lamp



## Dati tecnici

### Technical data

#### LED TOUCH DIMMER

2200-2700-3000 K | CRI>90  
205-209-225 lm | 3.5 W | IP20  
5V max.2A



Corpo in pressofusione di alluminio verniciato  
*Painted die-cast aluminum body*

Paralume in tessuto ignifugo  
*Fire-retardant fabric lampshade*

Modulo luce in policarbonato opalino  
*Opal polycarbonate light module*

Adatta esclusivamente all'uso interno (IP20)  
*Suitable for indoor use only (IP20)*

Durata di circa 10 h alla massima potenza  
*Battery lasts about 10 h at full power*

Tempo di ricarica a 2A: 5 h  
*Charging time at 2A: 5 h*

Pacco batteria al litio ricaricabile e sostituibile  
*Rechargeable and replaceable lithium battery pack*

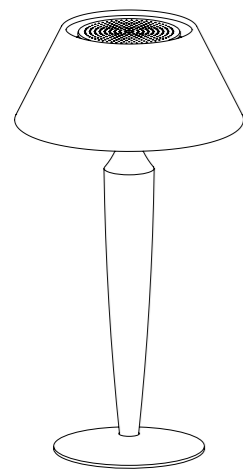

Ø 12,7 x 32 cm



Ø 8,6 x 5 cm

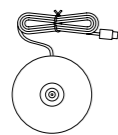

Ø 7,5 cm

### Componenti inclusi Components included

Base di ricarica a contatto (USB-C)  
*Contact charging base (USB-C)*

### Accessori non inclusi Accessories not included

Caricatore a spina / USB charger → **LD1490UA**  
5V max 2A | 200-240V | USB-C (pg. 247)

## Finiture Finishes

IP20



**LD1240O3**  
Oro / Gold



**LD1240W3**  
Bronzo / Bronze

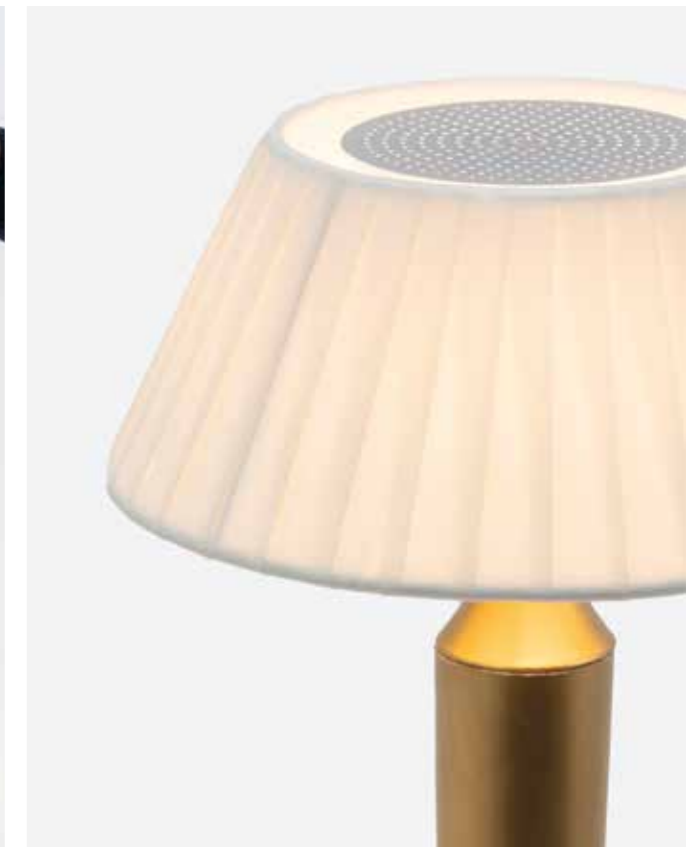

# Royal Family<sup>PRO</sup>

Design LuccheseDesign

Royal Family è una lampada da tavolo a batteria, portatile e ricaricabile, è controllabile anche da remoto, mediante l'utilizzo dell'applicazione Zafferano Lighting (pag. 6). Nella parte superiore della testa è presente un controllo "touch", che permette l'accensione, la dimmerazione a 4 step (100%, 60%, 30%, 6%) e la selezione della temperatura di colore della luce. Grazie all'elevato grado di protezione, la lampada può essere utilizzata anche all'esterno, ad eccezione del modello con finitura a foglia metallica, per il quale non si consiglia un uso prolungato in ambienti esterni. Un sistema di controllo elettronico assicura un flusso luminoso costante fino all'esaurimento della batteria, monitora l'autonomia residua e la segnala, aiutando a ottimizzare le ricariche. È dotata di base di ricarica a contatto.

*Royal Family is a cordless, rechargeable battery table lamp embellished with hand-blown and handcrafted borosilicate glass decorative elements; it can be remotely controlled using the Zafferano Lighting app (see page 6).*

*A touch control placed on the lamp head allows turning on/off, 4-step dimming (100%, 60%, 30%, 6%) and selecting the color temperature (K).*

*With its high protection rating, the lamp is suitable for both indoor and outdoor use, except for the model with a metallic leaf finish, which is not recommended for prolonged outdoor exposure. The lamp features an electronic control system that ensures a constant light output until the battery is depleted, monitors the remaining battery autonomy, and indicates it, helping to optimize charging. The lamp is equipped with a contact charging base.*



LINK TO VIDEO



Royal Family table lamp  
titanium → **LD1160T3**

# Royal Family Wi-Fi<sup>PRO</sup>

Lampada da tavolo  
Table lamp



## Dati tecnici

### Technical data

#### LED TOUCH DIMMER

2200-2700-3000-4000 K | CRI>90  
300-342-343-359 lm | 3.2 W | IP65  
5 V max 2A

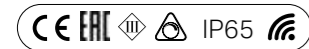

Corpo in pressofusione di alluminio verniciato  
*Painted die-cast aluminum body*

Elementi decorativi in vetro  
*Decorative glass elements*

Diffusore in policarbonato prismatico  
*Prismatic polycarbonate diffuser*

Adatta all'uso esterno (lampada IP65) e interno (lampada su base di ricarica IP20)  
*Suitable for outdoor (lamp IP65) and indoor use (lamp on charging base IP20)*

Durata 8-36 h, in base alla regolazione del flusso luminoso e alle impostazioni del Wi-Fi  
*Battery lasts 8-36 h, depending on the luminous flux and Wi-Fi setting*

Tempo di ricarica a 2A: 4 h  
*Charging time at 2A: 4 h*

Pacco batteria al litio ricaricabile e sostituibile  
*Rechargeable and replaceable lithium battery pack*

Firmware del dispositivo aggiornabile da remoto  
*Remotely upgradable device firmware*

#### Avvertenze Remarks

Per poter funzionare in modalità Wi-Fi, la lampada deve essere collegata a una rete con frequenza 2,4 GHz.

*In order to work in Wi-Fi mode, the lamp must be connected to a 2.4 GHz frequency network.*

La lampada con finitura in foglia metallica oro non è adatta ad un uso prolungato in ambiente esterno.

*The lamp with gold metallic-leaf finish is not suitable for prolonged outdoor use.*

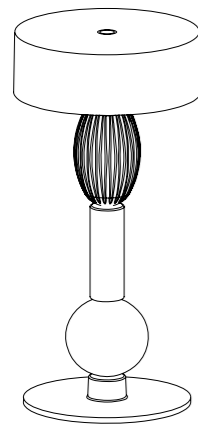

Ø 13,2 x 28 cm

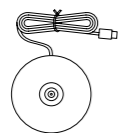

Ø 11,3 cm

#### Componenti inclusi Components included

Base di ricarica a contatto (USB-C)  
*Contact charging base (USB-C)*

#### Accessori non inclusi Accessories not included

Caricatore a spina / USB charger → **LD1490UA**  
5V max 2A | 200-240V | USB-C (pg. 247)

## Finiture Finishes

IP65



**LD1160B3**  
Bianco / White  
WRW



**LD1160T3**  
Titanio / Titanium  
MTI



**LD1160BFO \***  
Foglia color oro / Gold color leaf



\* La lampada con finitura in foglia metallica oro non è adatta ad un uso prolungato in ambiente esterno.

*\* The lamp with gold metallic-leaf finish is not suitable for extended outdoor use.*

# Soffio <sup>PRO</sup>

Design Federico de Majo

Soffio è una lampada da tavolo a batteria, portatile e ricaricabile, con diffusore in vetro soffiato in due modelli, uno dei quali può essere utilizzato come vaso contenitore.

Sulla base della lampada è presente un controllo "touch", che permette l'accensione, la dimmerazione a 4 step e la selezione della temperatura di colore della luce. La lampada offre inoltre la possibilità di memorizzare manualmente l'impostazione della dimmerazione: all'accensione successiva, l'intensità luminosa sarà quella selezionata in precedenza. Grazie a un alto indice di protezione, la lampada è utilizzabile anche all'esterno.

Un sistema di controllo elettronico garantisce un flusso luminoso costante fino all'esaurimento della batteria, monitora e segnala l'autonomia residua, permettendo di ottimizzare le ricariche. È dotata di base di ricarica a contatto.

*Soffio is a cordless, rechargeable battery lamp, with a blown glass diffuser available in two models, one of which can also be used as a container vase.*

*A touch control placed on the base allows switching on/off, 4-step dimming (100%, 60%, 30%, 6%), and selecting the color temperature (K). The lamp also offers the option to manual save the dimming setting: when turned on again, the light intensity will be the previously selected one.*

*Suitable for both indoor and outdoor use, both lamps feature an electronic control system that ensures a constant light output until the battery is depleted, monitors the remaining battery autonomy, and indicates it, helping to optimize charging.*

*The lamp is equipped with a contact charging base.*



LINK TO VIDEO



Soffio table lamp matte  
gold - amber → **LD1121004**

# Soffio<sup>PRO</sup>

Lampada da tavolo  
Table lamp

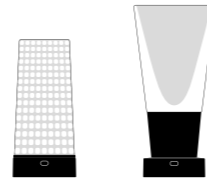

## Dati tecnici

### Technical data

#### LED TOUCH DIMMER

2200-2700-3000 K | CRI>80  
244-263-273 lm | 2.0 W | IP65  
5 V max 2A



Corpo in pressofusione di alluminio verniciato  
*Painted die-cast aluminum body*

Elemento in vetro borosilicato  
*Borosilicate glass element*

Diffusore in policarbonato opale  
*Opal polycarbonate diffuser*

Adatta all'uso esterno (lampada IP65) e interno  
(lampada su base di ricarica IP20)  
*Suitable for outdoor (lamp IP65) and indoor use (lamp  
on charging base IP20)*

Durata di circa 10/11 h alla massima potenza  
*Battery lasts about 10/11 h at full power*

Tempo di ricarica a 2A: 3/4 h  
*Charging time at 2A: 3/4 h*

Pacco batteria al litio ricaricabile e sostituibile  
*Rechargeable and replaceable lithium battery pack*

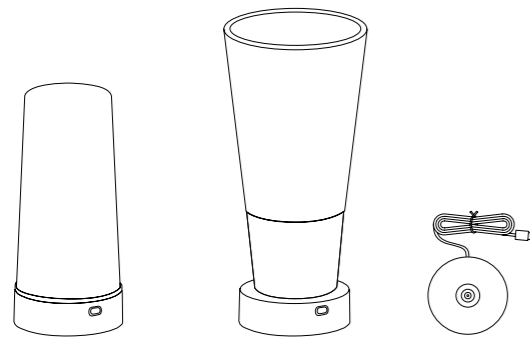

Ø 9,5 x 20,8 cm

Ø 12,3 x 26,5 cm

Ø 7,5 cm

### Componenti inclusi Components included

Base di ricarica a contatto (USB-C)  
*Contact charging base (USB-C)*

### Accessori non inclusi Accessories not included

Caricatore a spina / USB charger → **LD1490UA**  
5V max 2A | 200-240V | USB-C (pg. 247)

## Finiture Finishes

IP65



**LD1122001**  
Oro - Sabbiato / Gold -  
Sandblasted



**LD1122004**  
Oro - Ambra / Gold -  
Amber



**LD1121001**  
Oro - Sabbiato / Gold -  
Sandblasted



**LD1121004**  
Oro - Ambra / Gold -  
Amber



# Teepee

Design Zafferano

Teepee è una lampada da tavolo a batteria, portatile e ricaricabile, con diffusore in polietilene. Sotto il diffusore è presente un controllo "touch", che permette l'accensione, la regolazione dell'intensità luminosa e la selezione della temperatura di colore della luce. La lampada possiede inoltre la funzione di memoria per l'impostazione della dimmerazione: ad ogni accensione, l'intensità luminosa verrà ripristinata a quella selezionata in precedenza. Grazie all'alto indice di protezione, la lampada è utilizzabile anche all'esterno.

Un sistema di controllo elettronico monitora e segnala l'autonomia residua della batteria, permettendo di ottimizzare le ricariche. Si ricarica con cavetto USB type-C.

*Teepee is a cordless, rechargeable battery table lamp, with a polyethylene diffuser. A touch control placed on the lower part of the diffuser allows switching on/off, dimming, and selecting the color temperature (K). The lamps also feature a memory function for the dimming setting: each time they are turned on, the light intensity will be restored to the previously selected level.*

*Suitable for both indoor and outdoor use, the lamp features an electronic control system that monitors and indicates the remaining battery life, allowing for optimized charging. The battery charges via a USB type-C cable.*



LINK TO VIDEO



Teepee floor lamp  
black → LD1140D3

# Teepee

Lampada da tavolo  
Table lamp



## Dati tecnici

### Technical data

#### LED TOUCH DIMMER

2200-2700-3000 K | CRI>80  
250-278-294 lm | 2.0 W | IP65  
5 V max 1 A



Struttura in metallo verniciato

*Painted metal frame*

Diffusore in polietilene

*Polyethylene diffuser*

Adatta all'uso esterno (lampada IP65) e interno  
(lampada in ricarica con cavo IP20)

*Suitable for outdoor (lamp IP65) and indoor use  
(lampcharging with cable IP20)*

Durata di circa 10 h alla massima potenza

*Battery lasts about 10 h at full power*

Tempo di ricarica a 1A: 5 h

*Charging time at 1A: 5 h*

Pacco batteria al litio ricaricabile e sostituibile

*Rechargeable and replaceable lithium battery pack*

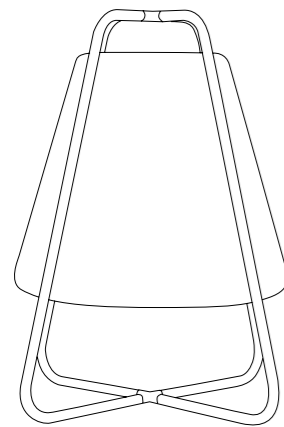

Ø 36,1 x 42 cm

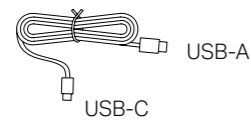

1 m

## Componenti inclusi Components included

Cavo USB-a / USB-c - 1m  
*USB-a / USB-c cable - 1m*

## Accessori non inclusi Accessories not included

Caricatore a spina / *USB charger* → **LD0490UA**  
5 V max 1 A | 100-240V | USB-A (pg. 247)

## Finiture

### Finishes

IP65



#### LD1140B3

Bianco / *White*  
RAL 9003



#### LD1140D3

Nero / *Black*  
RAL 9005



Teepee floor lamp  
black → **LD1140D3**

# Tree of light

Design Tomaso Schiaffino

Tree of Light è una lampada da terra con diffusori in polietilene opale e struttura in metallo e polietilene, disponibile in tre varianti colore: bianco, nero e verde salvia. Il coperchio della base della lampada è mobile: può essere sollevato all'altezza desiderata, bloccato e utilizzato come piano di appoggio. È completa di lampadine LED ad alta potenza per un illuminamento ottimale. Adatta per uso interno ed esterno.

*Tree of Light is a floor lamp with opal polyethylene diffusers and a structure made of metal and polyethylene, available in three color options: white, black, and sage green. The lamp base has a movable cover that can be raised to the desired height, locked and used as a tabletop.*

*The lamp is supplied with high-power LED bulbs for optimal illumination. Suitable for indoor and outdoor use.*



LINK TO VIDEO

Tree of light  
floor lamp white → **LL1450B3**





Tree of light  
floor lamp Sage green → **LL1450G3**

# Tree of light

Lampada da terra  
Floor lamp

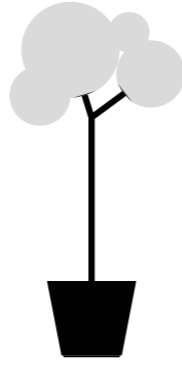

## Dati tecnici

### Technical data

**E27** | 220-240V | 50-60Hz | 2 x max 70W | **IP54 - IP44**

CE ENEC IP65 - IP44

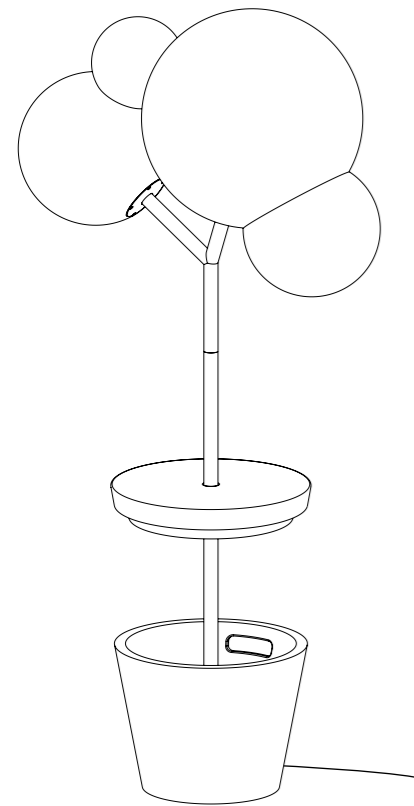

50 x 89 x 184,8 cm

Struttura in metallo e polietilene  
*Painted metal and polyethylene frame*  
Schermo diffusore in polietilene  
*Polyethylene diffuser*

Adatta all'uso esterno:

- IP54 se collegata all'alimentazione di rete con il connettore fornito in dotazione
- IP44 se collegata all'alimentazione di rete con la spina fornita in dotazione

Suitable for outdoor use:

- IP54 when connected to the mains power supply with the supplied connector
- IP44 when connected to the mains power supply with the supplied plug



## Finiture Finishes

IP54 | IP44



**LL1450B3**  
Bianco / White  
RAL 9003



**LL1450G3**  
Salvia / Sage green  
Pantone 5635 U



**LL1450D3**  
Nero / Black  
RAL 9004

## Componenti inclusi Components included

Ripiano / Shelf

2x Lampadina E27  
2x Bulb E27  
3000K | 24 W

**LMP00007114802700** (pg. 246)

# Trilli <sup>PRO</sup>

Design Federico de Majo

Trilli è una lampada da tavolo a batteria, portatile e ricaricabile, controllabile anche da remoto mediante l'utilizzo dell'applicazione Zafferano Lighting (pag. 6). Il paralume e la base sono in ceramica, prodotta e decorata a mano in Italia; su richiesta, gli elementi in ceramica sono personalizzabili. Nella parte superiore della testa è presente un controllo "touch", che permette l'accensione, la dimmerazione a 4 step (100%, 60%, 30%, 6%) e la selezione della temperatura di colore della luce. Grazie a un alto indice di protezione, la lampada è utilizzabile anche all'esterno. Un sistema di controllo elettronico assicura un flusso luminoso costante fino all'esaurimento della batteria, monitora l'autonomia residua e la segnala, aiutando a ottimizzare le ricariche. È dotata di base di ricarica a contatto.

*Trilli is a cordless, rechargeable battery table lamp that can be remotely controlled using the Zafferano Lighting app (see page 6). The lampshade and the base are made of ceramic, handmade and decorated in Italy; upon request, these ceramic elements can be customized. A touch control placed on the lamp head allows switching on/off, 4-step dimming (100%, 60%, 30%, 6%) and selecting the color temperature (K). Suitable for both indoor and outdoor use, the lamp features an electronic control system that ensures a constant light output until the battery is depleted, monitors the remaining battery autonomy, and indicates it, helping to optimize charging. The lamp is equipped with a contact charging base.*



LINK TO VIDEO



Trilli Wi-Fi table lamp  
white-ochre → **LD2090BH**

# Trilli Wi-Fi <sup>PRO</sup>

Lampada da tavolo  
Table lamp



## Dati tecnici

### Technical data

#### LED TOUCH DIMMER

2200-2700-3000-4000 K | CRI>90  
300-342-343-359 lm | 3.2 W | IP65  
5 V max 2A

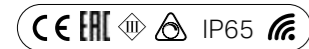

Corpo in pressofusione di alluminio verniciato  
*Painted die-cast aluminum body*  
Elementi in ceramica fatta e decorata a mano in Italia  
*Ceramic elements made and decorated by hand in Italy*  
Diffusore in policarbonato prismatico  
*Prismatic polycarbonate diffuser*

Adatta all'uso esterno (lampada IP65) e interno  
(lampada su base di ricarica IP20)  
*Suitable for outdoor (lamp IP65) and indoor use  
(lamp on charging base IP20)*

Durata 8-36 h, in base alla regolazione del flusso  
luminoso e alle impostazioni del Wi-Fi  
*Battery lasts 8-36 h, depending on the luminous  
flux and Wi-Fi setting*

Tempo di ricarica a 2A: 4 h  
*Charging time at 2A: 4 h*

Pacco batteria al litio ricaricabile e sostituibile  
*Rechargeable and replaceable lithium battery pack*

Firmware del dispositivo aggiornabile da remoto  
*Remotely upgradable device firmware*

#### Avvertenze

##### Remarks

Per poter funzionare in modalità Wi-Fi, la lampada deve essere  
collegata a una rete con frequenza 2,4 GHz.

*In order to work in Wi-Fi mode, the lamp must be connected to a 2.4  
GHz frequency network.*

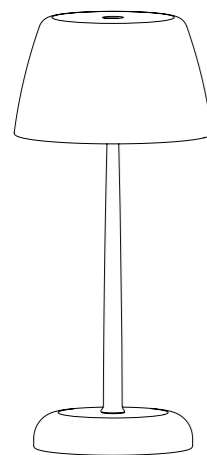

Ø 16,2 x 33,2 cm

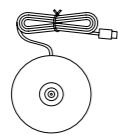

Ø 11,3 cm

#### Componenti inclusi Components included

Base di ricarica a contatto (USB-C)  
Contact charging base (USB-C)

#### Accessori non inclusi Accessories not included

Caricatore a spina / USB charger → **LD1490UA**  
5V max 2A | 200-240V | USB-C (pg. 247)

## Finiture Finishes

IP65



#### LD2090BD

Bianco - Nero / White - Black



#### LD2090BR

Bianco - Ruggine / White - Rust



#### LD2090BH

Bianco - Ocra / White - Ochre



# Amelie <sup>PRO</sup>

Design Sara Moroni



reddot winner 2023



INTERIOR DESIGN

Amelie è una collezione di lampade a batteria, portatili e ricaricabili, disponibile nei modelli da tavolo e a sospensione. La lampada da tavolo viene fornita con un tappo in silicone e un gancio che permettono di trasformarla in una sospensione.

Un controllo "touch" presente nella parte superiore della testa permette l'accensione, la regolazione dell'intensità luminosa e la selezione della temperatura di colore della luce. Le lampade possiedono inoltre la funzione di memoria per l'impostazione della dimmerazione: ad ogni accensione, l'intensità luminosa verrà ripristinata a quella selezionata in precedenza. Grazie a un alto indice di protezione, le lampade sono utilizzabili anche all'esterno. Sono dotate di base di ricarica a contatto.

*Amelie is a collection of cordless, rechargeable battery lamps, consisting of a table lamp and a suspension lamp. The table lamp is supplied with a silicone cap and a hook, so that this can be transformed into a suspension lamp.*

*A touch control on the lamp head allows switching on/off, dimming, and selecting the color temperature (K). The lamps also feature a memory function for the dimming setting: each time they are turned on, the light intensity will be restored to the previously selected level. Thanks to the high protection rating, the lamps are suitable for both indoor and outdoor use. The lamps are equipped with a contact charging base.*



LINK TO VIDEO



Amelie table lamp  
leaf green → **LD1090V3**

# Amelie <sup>PRO</sup>

Lampada da tavolo  
Table lamp

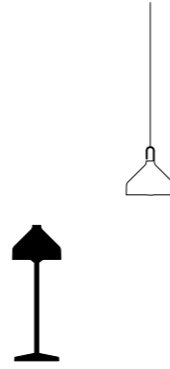

## Dati tecnici

### Technical data

#### LED TOUCH DIMMER

2200-2700-3000 K | CRI>80  
253-300-308 lm | 3.0 W | IP65  
5 V max 1A



Corpo in pressofusione di alluminio verniciato  
*Painted die-cast aluminum body*

Diffusore in policarbonato opale  
*Opal polycarbonate diffuser*

Adatta all'uso esterno (lampada IP65) e interno  
(lampada su base di ricarica IP20)  
*Suitable for outdoor (lamp IP65) and indoor use (lamp  
on charging base IP20)*

Durata di circa 10 h alla massima potenza  
*Battery lasts about 10 h at full power*

Tempo di ricarica a 1A: 6 h  
*Charging time at 1A: 6 h*

Pacco batteria al litio ricaricabile e sostituibile  
*Rechargeable and replaceable lithium battery pack*

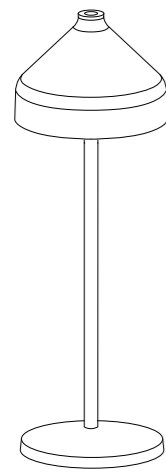

Ø 12 x 34 cm

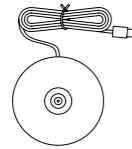

Ø 12 cm

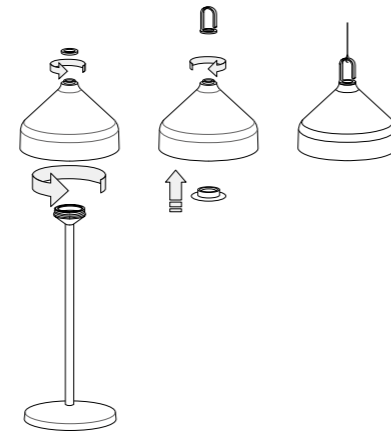

### Componenti inclusi Components included

Base di ricarica a contatto (USB-C)  
*Contact charging base (USB-C)*

Accessorio per utilizzo a sospensione  
(tappo in silicone e gancio)  
*Accessories to use as a suspension lamp  
(silicon cap and hook)*

### Accessori non inclusi Accessories not included

Caricatore a spina / USB charger → **LD1490UA**  
5V max 2A | 200-240V | USB-C (pg. 247)

## Finiture Finishes

IP65



**LD1090B3**  
Bianco / White  
RAL 9016



**LD1090D3**  
Nero / Black  
RAL 9011



**LD1090V3**  
Verde foglia / Green leaf  
Pantone 150 60 10



**LD1090T3**  
Terracotta / Terracotta  
Pantone 49-12 C



Amelie table lamp  
terracotta → **LD1090T3**

# Amelie<sup>PRO</sup>

Lampada a sospensione  
Suspension lamp

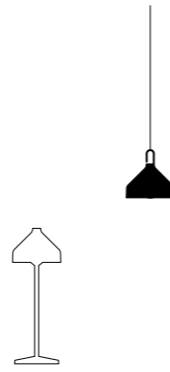

## Dati tecnici

### Technical data

#### LED TOUCH DIMMER

2200-2700-3000 K | CRI>80  
253-300-308 lm | 3.0 W | IP65  
5 V max 1A



Corpo in pressofusione di alluminio verniciato  
*Painted die-cast aluminum body*

Diffusore in policarbonato opale  
*Opal polycarbonate diffuser*

Adatta all'uso esterno (lampada IP65) e interno  
(lampada su base di ricarica IP20)  
*Suitable for outdoor (lamp IP65) and indoor use (lamp  
on charging base IP20)*

Durata di circa 10 h alla massima potenza  
*Battery lasts about 10 h at full power*

Tempo di ricarica a 1A: 6 h  
*Charging time at 1A: 6 h*

Pacco batteria al litio ricaricabile e sostituibile  
*Rechargeable and replaceable lithium battery pack*

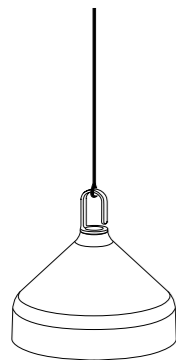

Ø 12 x 12 cm

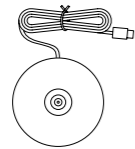

Ø 12 cm

#### Componenti inclusi Components included

Base di ricarica a contatto (USB-C)  
*Contact charging base (USB-C)*

Tappo in silicone e gancio  
*Silicon cap and hook*

#### Accessori non inclusi Accessories not included

Caricatore a spina / *USB charger* → **LD1490UA**  
5V max 2A | 200-240V | USB-C (pg. 247)

## Finiture Finishes

IP65



**LD1091B3**  
Bianco / *White*  
RAL 9016



**LD1091D3**  
Nero / *Black*  
RAL 9011



**LD1091V3**  
Verde foglia / *Green leaf*  
Pantone 150 60 10



**LD1091T3**  
Terracotta / *Terracotta*  
Pantone 49-12 C



Amelie suspension lamp  
green leaf → **LD1091V3**

# Circe<sup>PRO</sup>

Design Zafferano

Circe è una lampada da tavolo a batteria, portatile e ricaricabile. Nella parte superiore della testa è presente un pulsante che permette l'accensione, la regolazione dell'intensità luminosa e la selezione della temperatura di colore della luce (bianco dinamico). Le lampade possiedono inoltre la funzione di memoria per l'impostazione della dimmerazione: ad ogni accensione, l'intensità luminosa verrà ripristinata a quella selezionata in precedenza. Grazie all'elevato indice di protezione, la lampada può essere utilizzata anche all'esterno, ad eccezione dei modelli con finitura galvanica, per i quali non si consiglia un uso prolungato in ambienti esterni. È dotata di base di ricarica a contatto.

*Circe is a cordless, rechargeable battery table lamp. The knob on the lamp head allows switching on/off, dimming, and tuning the color temperature (tunable CCT). The lamps also feature a memory function for the dimming setting: each time they are turned on, the light intensity will be restored to the previously selected level. With its high protection rating, the lamp is suitable for both indoor and outdoor use, except for the models with a glossy finish, which are not suitable for prolonged outdoor exposure. The lamp is equipped with a contact charging base.*



LINK TO VIDEO



Circe table lamp  
corten → **LD1005R3**

# Circe <sup>PRO</sup>

Lampada da tavolo  
Table lamp



## Dati tecnici

### Technical data

#### LED ROTATING DIMMER

2200-3000 K | CRI>80  
214-224 lm | 2.2 W | IP65  
5 V max 1A



Corpo in pressofusione di alluminio verniciato  
*Painted die-cast aluminum body*

Diffusore in policarbonato prismatico  
*Prismatic polycarbonate diffuser*

Adatta all'uso esterno (lampada IP65) e interno  
(lampada su base di ricarica IP20)  
*Suitable for outdoor (lamp IP65) and indoor use (lamp  
on charging base IP20)*

Durata di circa 9 h alla massima potenza  
*Battery lasts about 9 h at full power*

Tempo di ricarica a 1A: 6 h  
*Charging time at 1A: 6 h*

Pacco batteria al litio ricaricabile e sostituibile  
*Rechargeable and replaceable lithium battery pack*

#### Avvertenze Remarks

Le lampade con finitura lucida (oro e oro rosa) non sono adatte  
per uso esterno.  
*The lamps with glossy finishes (gold and rose gold)  
are not suitable for outdoor use.*

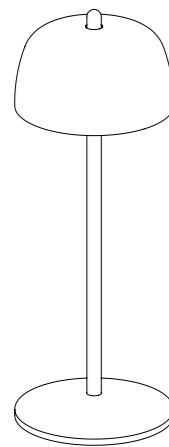

Ø 11 x 30 cm

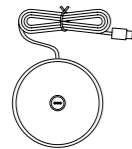

Ø 11,6 cm

#### Componenti inclusi Components included

Base di ricarica a contatto (USB-A)  
*Contact charging base (USB-A)*

#### Accessori non inclusi Accessories not included

Caricatore a spina / *USB charger* → **LD0490UA**  
5 V max 1A | 100-240V | USB-A (pg. 247)

## Finiture Finishes

IP65



**LD1005B3**  
Bianco / *White*  
RAL 9002



**LD1005R3**  
Corten



**LD1005N3**  
Nero / *Black*  
RAL 9005



**LD1005O3**  
Oro lucido / *Glossy gold* \*  
Galvanic Finish



**LD1005E3**  
Oro rosa lucido / *Glossy rose gold* \*  
Galvanic Finish

\* Le lampade con finitura galvanica (oro e oro rosa) non sono adatte ad un uso prolungato in ambiente esterno.

\* *The lamps with glossy finishes (gold and rose gold) are not suitable for prolonged outdoor use.*

# Home <sup>PRO</sup>

Design Zafferano

Home è una lampada da tavolo a batteria, portatile e ricaricabile. Sulla base è presente un controllo "touch", che permette l'accensione e la regolazione dell'intensità luminosa. Grazie all'alto indice di protezione, la lampada è utilizzabile anche all'esterno. Un sistema di controllo elettronico monitora e segnala l'autonomia residua della batteria, permettendo di ottimizzare le ricariche ed effettuarle sempre in maniera corretta. È dotata di base di ricarica a contatto. Home può diventare una lampada da parete tramite l'apposito accessorio, acquistabile separatamente (pag. 150).

*Home is a cordless, rechargeable battery table lamp.*

*A touch control placed on the base allows switching on/off and dimming. Suitable for both indoor and outdoor use, the lamp features an electronic control system that monitors and indicates the remaining battery life, allowing for optimized charging. The lamp is equipped with a contact charging base.*

*Home can become a sconce thanks its dedicated accessory, to be purchased separately (page 150).*



LINK TO VIDEO

Home table lamp white  
→ LD1258B3



# Home <sup>PRO</sup>

Lampada da tavolo  
Table lamp



## Dati tecnici

### Technical data

#### LED TOUCH DIMMER

3000 K | CRI>80  
260 lm | 2.2 W | IP54  
50-60 Hz | 5 V max 1A



Corpo in pressofusione di alluminio verniciato  
*Painted die-cast aluminum body*

Diffusore in policarbonato  
*Polycarbonate diffuser*

Adatta all'uso esterno (lampada IP54) e interno (lampada su base di ricarica IP20)  
*Suitable for outdoor (lamp IP54) and indoor use (lamp on charging base IP20)*

Durata di circa 12 h alla massima potenza  
*Battery lasts about 12 h at full power*

Tempo di ricarica a 1A: 6/8 h  
*Charging time at 1A: 6/8 h*

Pacco batteria al litio ricaricabile e sostituibile  
*Rechargeable and replaceable lithium battery pack*

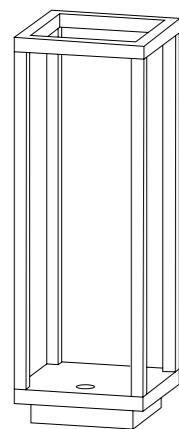

10 x 10 x 29,4 cm

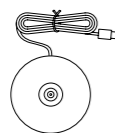

Ø 7,5 cm

### Componenti inclusi Components included

Base di ricarica a contatto (USB-A)  
*Contact charging base (USB-A)*

### Accessori non inclusi Accessories not included

Caricatore a spina / USB charger → **LD0490UA**  
5 V max 1A | 100-240V | USB-A (pg. 247)

## Finiture Finishes

IP54



**LD1258B3**  
Bianco / White  
RAL 9003



**LD1258N3**  
Grigio scuro / Dark gray



**LD1258R3**  
Corten



Home table lamp white  
→ **LD1258B3**  
Photo Digital Snack

# Home <sup>PRO</sup>

Supporto parete  
Wall lamp kit



## Dati tecnici Technical data

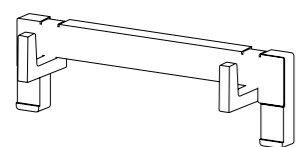

9,7 x 3 cm

## Finiture Finishes



**LD0259B3**  
Bianco / White  
RAL 9003



**LD0259R3**  
Corten



**LD0259N3**  
Grigio scuro /  
Dark gray

Supporto in pressofusione d'alluminio verniciato  
Painted die-cast aluminum element

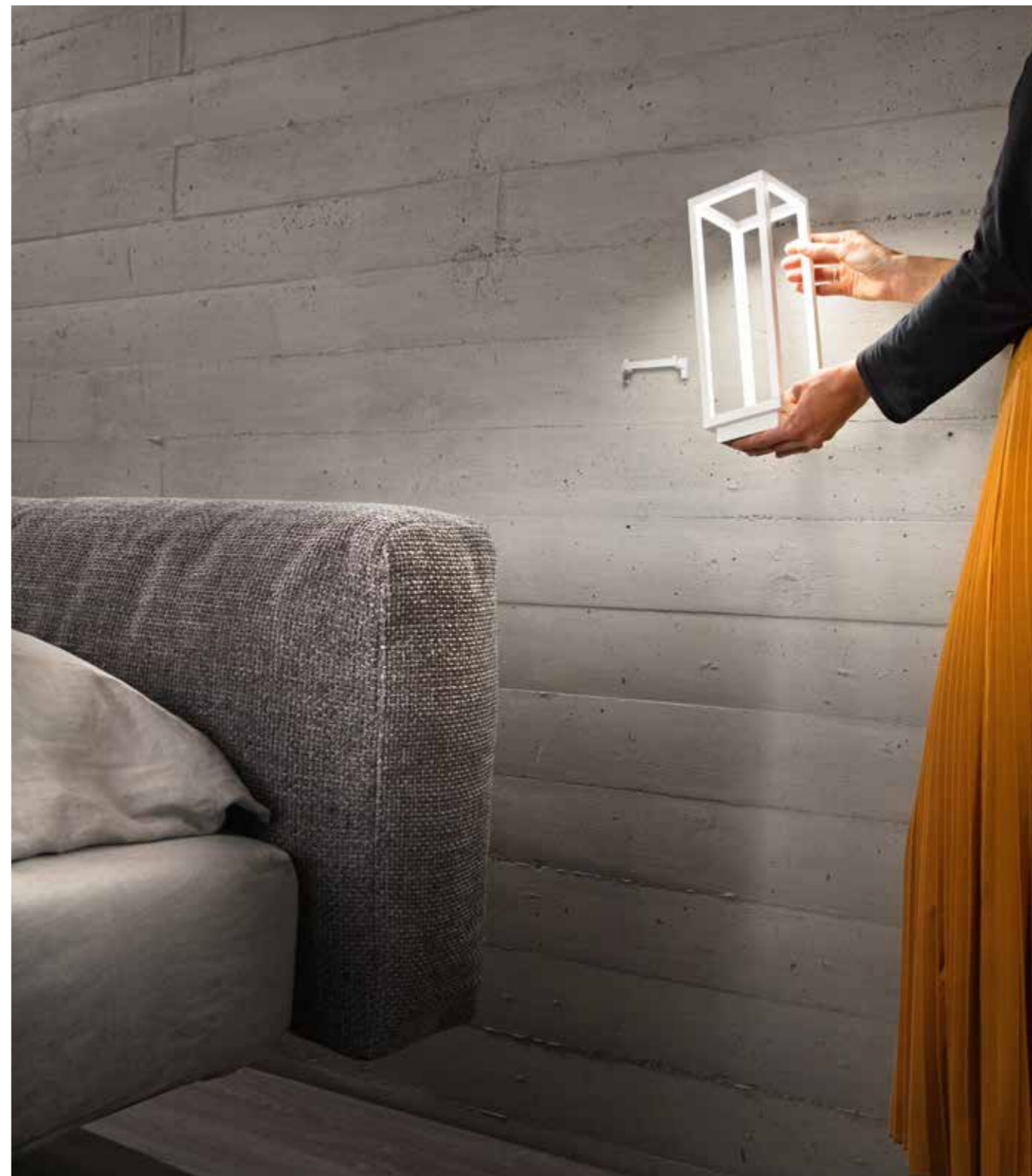

Home table lamp white  
+ Home wall lamp kit white  
→ **LD1258B3 + LD0259B3**

Supporto che trasforma la lampada da tavolo Home in lampada da parete. La lampada può essere usata nel suo supporto fisso, ma anche rimossa e portata con sé da un ambiente all'altro.

*A wall bracket that turns Home into a wall lamp. The lamp can be used in its fixed housing or detached and carried from one place to another*

# Home Solar

Design Zafferano

Home Solar è una collezione di lampade adatte all'uso esterno, prive di collegamento alla rete elettrica e dotate di pannello solare. La collezione comprende quattro modelli, di diversa altezza: una lampada da tavolo, una da terra – entrambe con maniglia - e due paletti.

I modelli **Home solar** (pag. 156) sono dotati di sensore crepuscolare e sensore di movimento, attivabili separatamente tramite due interruttori:

Quando il sensore crepuscolare è attivo (☾), e rileva una luminosità ambientale minore di 150 Lux, la lampada si accende al 50% della sua intensità;

Quando anche il sensore di movimento è attivo (👤) e rileva un movimento, la lampada si accende alla massima intensità per poi ridursi automaticamente al 10%.

I paletti sono forniti di picchetto per installazione diretta su terreno. È possibile acquistare separatamente una base zavorrata per una maggiore stabilità al terreno (pag. 158).

I modelli **Home solar 2** (pag. 160) sono dotati di sensore crepuscolare attivabile tramite interruttore.

Quando il sensore è attivo (indicatore arancione), la lampada si accende automaticamente con luce inferiore a 50 Lux. In modalità manuale (indicatore blu), la lampada rimane accesa e l'intensità luminosa può essere regolata tramite comando touch. Entrambi i modelli sono predisposti per installazione a parete mediante accessorio opzionale. Il modello da terra è dotato anche di una base zavorrata, necessaria per garantire stabilità quando la lampada viene installata all'esterno.

I modelli con maniglia possono essere ricaricati anche tramite cavo USB type-C.

*Home Solar is a collection of outdoor lamps powered by integrated solar panels, with no connection to the electrical grid. The collection includes four models, of different heights: a table lamp, a floor lamp - both with a handle - and two bollard lamps.*

**Home solar** models (page 156) are equipped with both a dusk sensor and a motion sensor, each controlled via separate switches:

When the dusk sensor is active (☾) and detects ambient light below 150 Lux, the lamp turns on at 50% brightness. When the motion sensor is also active (👤) and detects movement, the lamp switches to full brightness, then automatically dims to 10%.

The bollard lamps come with a metal peg for direct installation into the ground. A stabilizing base for enhanced stability is available separately (page 158)

The models **Home solar 2** (page 160) are equipped with a dusk sensor, which can be activated via a switch. When the sensor is active (orange indicator), the lamp switches on automatically when ambient light falls below 50 Lux. In manual mode (blue indicator), the lamp remains on and brightness can be adjusted via touch control. Both models can be wall-mounted using an optional accessory.

The floor model is also equipped with a stabilizing base, necessary to ensure stability when the lamp is installed on the ground outdoors. These lamps can also be recharged via USB type-C cable.



LINK TO VIDEO

Home Solar bollard  
dark gray → LD0257G3



Home Solar 2 table lamp  
→ **LD2111R3**



Home Solar 2 table lamp  
→ **LD2110G3**



# Home Solar

Lampada solare da terra  
*Sola floor lamp*

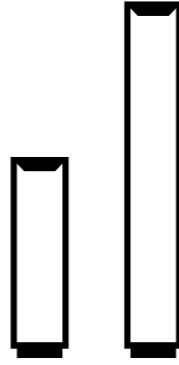

## Dati tecnici

### Technical data

#### LED

3,7 V | 3000 K | CRI>84 | 2,2W  
415 lm | beam angle 50°  
IP54

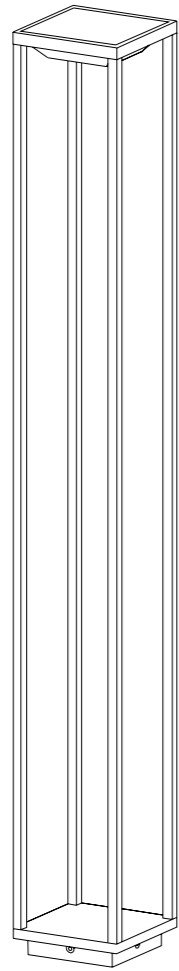

14 x 14 x 100 cm

Dotata di sensore crepuscolare e di movimento  
*Fitted with dusk and motion sensors*

Corpo in pressofusione di alluminio verniciato  
*Painted die-cast aluminum body*

Diffusore in policarbonato  
*Polycarbonate diffuser*

Adatta all'uso esterno (lampada IP54)  
*Suitable for outdoor (lamp IP54)*

Durata batteria: luce piena 5-6 h; micro 14-18 h  
*Work time: full power 5-6 h; energy saving 14-18 h*

Tempo di ricarica: 6/8 h (luce solare)  
*Charging time at: 6/8 h (sunshine)*

Batteria compatibile / *Compatible battery*  
**BAT04701906701900** (pg. 253)

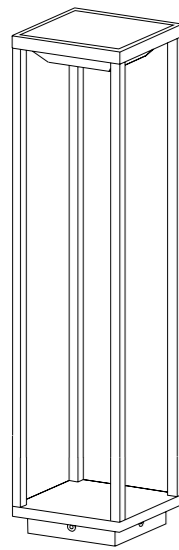

14 x 14 x 50 cm

## Componenti inclusi

*Components included*

Picchetto  
*Peg*



## Finiture

*Finishes*

IP54



**LD0256R3**  
Corten



**LD0256G3**  
Grigio scuro / *Dark gray*



**LD0257R3**  
Corten



**LD0257G3**  
Grigio scuro / *Dark gray*

## Metodo di fissaggio corretto / *Correct fixing procedure*

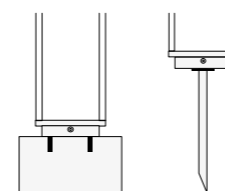

1. Lampada fissata su un plinto in cemento con viti idonee (incluse).
  2. Lampada fissata sul terreno con picchetto in metallo (incluso).
- 1. Lamp fixed to a cement plinth with suitable anchor screws (included).*  
*2. Lamp fixed in the ground with a metal peg (included).*

Modalità di installazioni differenti da quelle illustrate sono da ritenersi non idonee.  
*Installation procedures other than those illustrated are considered unsuitable.*

# Home Solar

Base zavorrata  
*Stabilizing base*

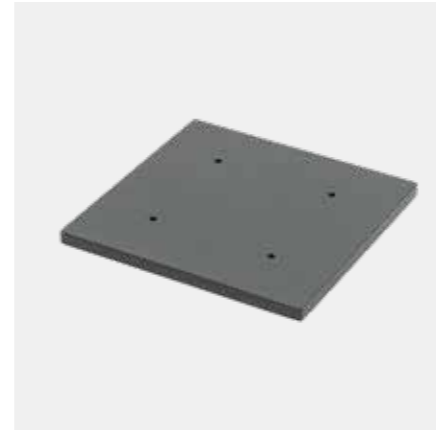

Dati tecnici  
*Technical data*



16 x 16 x 0,8 cm

Finiture  
*Finishes*



**LD0255R3**  
Corten



**LD0255G3**  
Grigio scuro /  
*Dark gray*

Supporto in pressofusione d'alluminio verniciato  
*Painted die-cast aluminum element*



Base zavorrata per stabilizzare la lampada senza ancorarla al terreno.  
*Stabilizing base to stabilise the lamp without anchoring it to the ground.*



Home Solar bollard dark gray +  
Stabilizing base dark gray  
→ **LD0256G3 + LD0255G3**

# Home Solar 2

Lampada solare da tavolo e da terra  
Solar table lamp and floor lamp

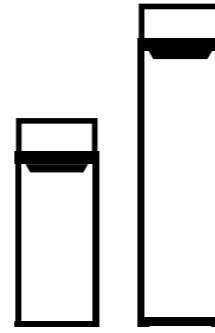

## Dati tecnici

### Technical data

#### LED TOUCH DIMMER

3000 K | CRI>80  
314 lm | 2.0 W | IP54  
50-60 Hz | 5V max.1A

CE ENEC IP54

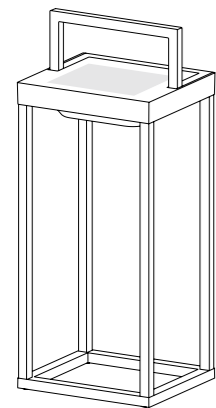
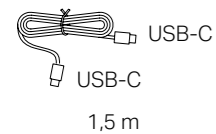

15 x 13 x 37,3 cm

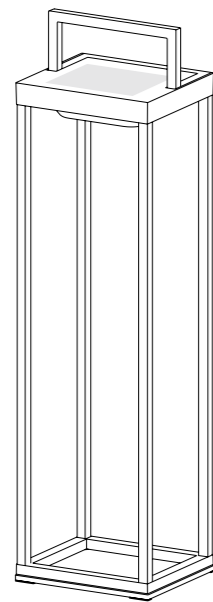

15 x 13 x 56,4 cm

Dotata di sensore crepuscolare  
*Fitted with dusk sensor*

Corpo in pressofusione di alluminio verniciato  
*Painted die-cast aluminum body*

Diffusore in policarbonato  
*Polycarbonate diffuser*

Adatta all'uso esterno (lampada IP54)  
*Suitable for outdoor (lamp IP54)*

Durata batteria: luce piena 10 h; micro 120 h  
*Work time: full power 10 h; energy saving 120 h*

Tempo di ricarica: 5 h (Type-C | 1A) | 19 h (luce solare)  
*Charging time: 5 h (Type-C | 1A) | 19 h (direct sunlight)*

Pacco batteria al litio ricaricabile e sostituibile  
*Rechargeable and replaceable lithium battery pack*



## Componenti inclusi

### Components included

Accessorio per utilizzo a parete per **LD2110**  
*Accessories to use as a sconce lamp for **LD2110***

Accessorio per utilizzo a parete e base zavorrata  
per **LD2111**  
*Accessories to use as a sconce lamp and stabilizing base  
for **LD2111***

Cavo USB-c / USB-c - 1,5 m  
*USB-c / USB-c cable - 1,5 m*

## Accessori non inclusi

### Accessories not included

Caricatore a spina / *USB charger* → **LD1490UA**  
5V max 2A | 200-240V | USB-C (pg. 247)

## Finiture

### Finishes

IP54



**LD2110B3**  
Bianco / *White*  
RAL 9003



**LD2110D3**  
Nero / *Black*  
RAL 9005



**LD2110G3**  
Salvia / *Sage green*  
Pantone 5635 U



**LD2110R3**  
Corten



**LD2111B3**  
Bianco / *White*  
RAL 9003



**LD2111D3**  
Nero / *Black*  
RAL 9005



**LD2111G3**  
Salvia / *Sage green*  
Pantone 5635 U



**LD2111R3**  
Corten

# Ofelia <sup>PRO</sup>

Design Zafferano

Ofelia è una collezione di lampade da tavolo a batteria, portatili e ricaricabili, disponibili in due modelli. Nella parte superiore della testa è presente un controllo "touch", che permette l'accensione, la regolazione dell'intensità luminosa e la selezione della temperatura di colore della luce. Le lampade possiedono inoltre la funzione di memoria per l'impostazione della dimmerazione: ad ogni accensione, l'intensità luminosa verrà ripristinata a quella selezionata in precedenza. Grazie all'alto indice di protezione, sono utilizzabili anche all'esterno. Le lampade sono dotate di base di ricarica a contatto.

*Ofelia is a collection of cordless, rechargeable battery table lamps. The collection includes a table lamp in two heights. A touch control on the lamp head allows switching on/off, dimming, and selecting the color temperature (K). The lamps also feature a memory function for the dimming setting: each time they are turned on, the light intensity will be restored to the previously selected level. Thanks to the high IP rating, the lamps are suitable for both indoor and outdoor use.*

*The lamps are equipped with a contact charging base.*



LINK TO VIDEO

Ofelia table lamp dark gray  
→ LD2870N3



# Ofelia<sup>PRO</sup>

Lampada da tavolo  
Table lamp

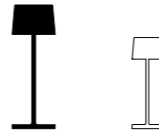

## Dati tecnici

### Technical data

#### LED TOUCH DIMMER

2200-2700-3000 K | CRI>80  
231-244-252 lm | 2.2 W | IP65  
50-60 Hz | 5 V max 1A



Corpo in pressofusione di alluminio verniciato

*Painted die-cast aluminum body*

Diffusore in policarbonato prismatico

*Prismatic polycarbonate diffuser*

Adatta all'uso esterno (lampada IP65) e interno  
(lampada su base di ricarica IP20)

*Suitable for outdoor (lamp IP65) and indoor use  
(lamp on charging base IP20)*

Durata di circa 9 h alla massima potenza

*Battery lasts about 9 h at full power*

Tempo di ricarica a 1A: 6 h

*Charging time at 1A: 6 h*

Pacco batteria al litio ricaricabile e sostituibile

*Rechargeable and replaceable lithium battery pack*

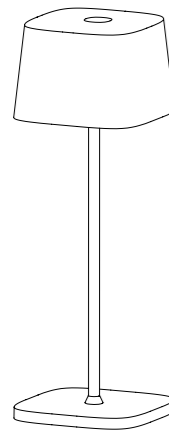

10 x 10 x 29 cm

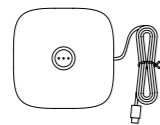

11,6 x 11,6 cm

### Componenti inclusi Components included

Base di ricarica a contatto (USB-C)  
Contact charging base (USB-C)

### Accessori non inclusi Accessories not included

Caricatore a spina / USB charger → **LD1490UA**  
5V max 2A | 200-240V | USB-C (pg. 247)

## Finiture

### Finishes

IP65



#### LD2870B3

Bianco / White  
RAL 9016

#### LD2870R3

Corten

#### LD2870N3

Grigio scuro / Dark  
gray  
RAL 7024

#### LD2870S3

Sabbia / Sand  
RAL 1014

#### LD2870G3

Salvia / Sage green  
Pantone 5635 U



Ofelia table lamp sage green  
→ **LD2870G3**

# Ofelia micro<sup>PRO</sup>

Lampada da tavolo  
Table lamp

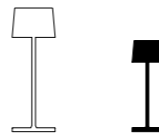

## Dati tecnici

### Technical data

#### LED TOUCH DIMMER

2200-2700-3000 K | CRI>80  
183-195-216 lm | 2.2 W | IP65  
5 V max 1A



Corpo in pressofusione di alluminio verniciato  
*Painted die-cast aluminum body*

Diffusore in policarbonato prismatico  
*Prismatic polycarbonate diffuser*

Adatta all'uso esterno (lampada IP65) e interno  
(lampada su base di ricarica IP20)  
*Suitable for outdoor (lamp IP65) and indoor use (lamp  
on charging base IP20)*

Durata di circa 9 h alla massima potenza  
*Battery lasts about 9 h at full power*

Tempo di ricarica a 1A: 4.5 h  
*Charging time at 1A: 4.5 h*

Pacco batteria al litio ricaricabile e sostituibile  
*Rechargeable and replaceable lithium battery pack*

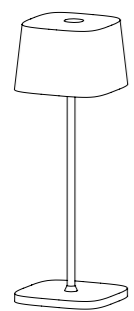

6,7 x 6,7 x 20 cm

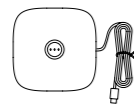

7,1 x 7,1 cm

## Componenti inclusi Components included

Base di ricarica a contatto (USB-C)  
*Contact charging base (USB-C)*

## Accessori non inclusi Accessories not included

Caricatore a spina / USB charger → **LD1490UA**  
5V max 2A | 200-240V | USB-C (pg. 247)

## Finiture Finishes

IP65



**LD1880B3**  
Bianco / White  
RAL 9016



**LD1880R3**  
Corten



**LD1880N3**  
Grigio scuro / Dark  
gray  
RAL 7024



**LD1880S3**  
Sabbia / Sand  
RAL 1014



**LD1880G3**  
Salvia / Sage green  
Pantone 5635 U



# Olivia <sup>PRO</sup>

Design Zafferano

Olivia è una collezione di lampade da tavolo a batteria, portatili e ricaricabili, disponibili in tre modelli. Nella parte superiore della testa è presente un controllo "touch", che permette l'accensione, la regolazione dell'intensità luminosa e la selezione della temperatura di colore della luce. Le lampade possiedono inoltre la funzione di memoria per l'impostazione della dimmerazione: ad ogni accensione, l'intensità luminosa verrà ripristinata a quella selezionata in precedenza. Grazie all'elevato indice di protezione, le lampade possono essere utilizzate anche all'esterno, ad eccezione del modello con finitura a foglia metallica, per il quale non si consiglia un uso prolungato in ambienti esterni. Sono dotate di base di ricarica a contatto.

*Olivia is a collection of cordless, rechargeable battery table lamps. The collection includes a table lamp in three heights. A touch control on the lamp head allows switching on/off, dimming, and selecting the color temperature (K). The lamps also feature a memory function for the dimming setting: each time they are turned on, the light intensity will be restored to the previously selected level. With their high protection rating, the lamps are suitable for both indoor and outdoor use, except for the model with a metallic leaf finish, which is not recommended for prolonged outdoor exposure. The lamps are equipped with a contact charging base.*



LINK TO VIDEO



Olivia table lamp corten → **LD2850R3**  
Tirache bicolor tumbler Red gray → **TR00111**

# Olivia<sup>PRO</sup>

Lampada da tavolo  
Table lamp

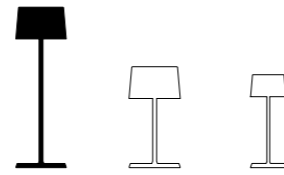

## Dati tecnici

### Technical data

#### LED TOUCH DIMMER

2200-2700-3000 K | CRI>80  
232-243-251 lm | 2.2 W | IP65  
50-60 Hz | 5 V max 1A



Corpo in pressofusione di alluminio verniciato  
*Painted die-cast aluminum body*

Diffusore in policarbonato prismatico  
*Prismatic polycarbonate diffuser*

Adatta all'uso esterno (lampada IP65) e interno  
(lampada su base di ricarica IP20)  
*Suitable for outdoor (lamp IP65) and indoor use (lamp  
on charging base IP20)*

Durata di circa 9 h alla massima potenza  
*Battery lasts about 9 h at full power*

Tempo di ricarica a 1A: 6 h  
*Charging time at 1A: 6 h*

Pacco batteria al litio ricaricabile e sostituibile  
*Rechargeable and replaceable lithium battery pack*

### Avvertenze Remarks

Le lampade con finitura in foglia metallica oro non sono adatte ad un uso prolungato in ambiente esterno.  
*The lamps with gold metallic-leaf finishes are not suitable for prolonged outdoor use.*

Per effetto della natura manuale della tecnica adottata nella lavorazione con foglia metallica, l'aspetto finale della finitura delle lampade può risultare differente. Eventuali difformità attestano il pregio e l'unicità di ciascuna lampada e non vanno considerate come imperfezioni.  
*Due to the manual nature of the technique adopted in the application of the metal foil, the final appearance of the lamps' finishing can be different. Any apparent imperfections attest to the quality and exclusivity of each lamp and should not be considered as imperfections.*

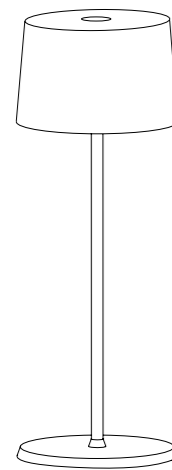

Ø 11 x 35 cm

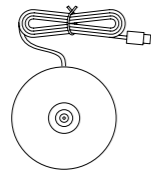

Ø 11,6 cm

### Componenti inclusi Components included

Base di ricarica a contatto (USB-C)  
*Contact charging base (USB-C)*

### Accessori non inclusi Accessories not included

Caricatore a spina / *USB charger* → **LD1490UA**  
5V max 2A | 200-240V | USB-C (pg. 247)

## Finiture Finishes

IP65



**LD2850B3**  
Bianco / *White*  
RAL 9016



**LD2850R3**  
Corten



**LD2850N3**  
Grigio scuro / *Dark gray*  
RAL 7012



**LD2850S3**  
Sabbia / *Sand*  
RAL 1014



**LD2850Y3**  
Giallo Oro / *Golden Yellow*



**LD2850BFO \***  
Foglia color oro / *Gold color leaf*

\* Le lampade con finitura foglia metallica oro non sono adatte ad un uso prolungato in ambiente esterno.

\* *The lamps with gold metallic-leaf finishes are not suitable for prolonged outdoor use.*

# Olivia mini<sup>PRO</sup>

Lampada da tavolo  
Table lamp

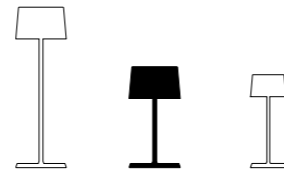

## Dati tecnici

### Technical data

#### LED TOUCH DIMMER

2200-2700-3000 K | CRI>80  
232-243-251 lm | 2.2 W | IP65  
50-60 Hz | 5 V max 1A



Corpo in pressofusione di alluminio verniciato  
*Painted die-cast aluminum body*

Diffusore in policarbonato prismatico  
*Prismatic polycarbonate diffuser*

Adatta all'uso esterno (lampada IP65) e interno  
(lampada su base di ricarica IP20)  
*Suitable for outdoor (lamp IP65) and indoor use (lamp  
on charging base IP20)*

Durata di circa 9 h alla massima potenza  
*Battery lasts about 9 h at full power*

Tempo di ricarica a 1A: 6 h  
*Charging time at 1A: 6 h*

Pacco batteria al litio ricaricabile e sostituibile  
*Rechargeable and replaceable lithium battery pack*

## Avvertenze

### Remarks

La lampada con finitura in foglia non è adatta per uso esterno.  
*The lamp with leaf finish is not suitable for outdoor use.*

Per effetto della natura manuale della tecnica adottata nella lavorazione con foglia metallica, l'aspetto finale della finitura della lampada può risultare differente. Eventuali difformità attestano il pregio e l'unicità di ciascuna lampada e non vanno considerate come imperfezioni.  
*Due to the manual nature of the technique adopted in the application of the metal foil, the final appearance of the lamps' finishing can be different. Any apparent imperfections attest to the quality and exclusivity of each lamp and should not be considered as imperfections.*

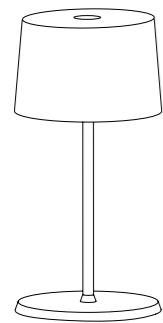

Ø 11 x 22 cm

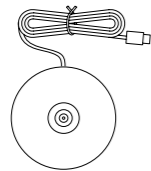

Ø 11,6 cm

## Componenti inclusi

### Components included

Base di ricarica a contatto (USB-C)  
*Contact charging base (USB-C)*

## Accessori non inclusi

### Accessories not included

Caricatore a spina / *USB charger* → **LD1490UA**  
5V max 2A | 200-240V | USB-C (pg. 247)

## Finiture

### Finishes

IP65



#### LD2860B3

Bianco / *White*  
RAL 9016



#### LD2860R3

Corten



#### LD2860N3

Grigio scuro / *Dark gray*  
RAL 7012



#### LD2860Y3

Giallo Oro / *Golden Yellow*



#### LD2860BFO \*

Foglia color oro / *Gold  
color leaf*

\* Le lampade con finitura giallo oro e in foglia metallica oro non sono adatte ad un uso prolungato in ambiente esterno.

\* *The lamps with golden yellow and gold metallic-leaf finishes are not suitable for prolonged outdoor use.*

# Olivia micro<sup>PRO</sup>

Lampada da tavolo  
Table lamp

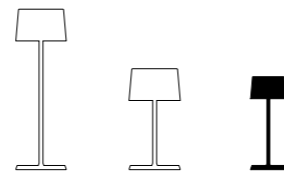

## Dati tecnici

### Technical data

#### LED TOUCH DIMMER

2200-2700-3000 K | CRI>80  
183-187-225 lm | 2.2 W | IP65  
5 V max 1A



Corpo in pressofusione di alluminio verniciato  
*Painted die-cast aluminum body*

Diffusore in policarbonato prismatico  
*Prismatic polycarbonate diffuser*

Adatta all'uso esterno (lampada IP65) e interno (lampada su base di ricarica IP20)  
*Suitable for outdoor (lamp IP65) and indoor use (lamp on charging base IP20)*

Durata di circa 9 h alla massima potenza  
*Battery lasts about 9 h at full power*

Tempo di ricarica a 1A: 4.5 h  
*Charging time at 1A: 4.5 h*

Pacco batteria al litio ricaricabile e sostituibile  
*Rechargeable and replaceable lithium battery pack*

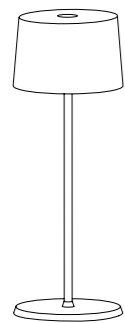

Ø 7,5 x 20 cm



Ø 7,9 cm

## Componenti inclusi Components included

Base di ricarica a contatto (USB-C)  
*Contact charging base (USB-C)*

## Accessori non inclusi Accessories not included

Caricatore a spina / USB charger → **LD1490UA**  
5V max 2A | 200-240V | USB-C (pg. 247)

## Finiture Finishes

IP65



**LD1840B3**  
Bianco / White  
RAL 9016



**LD1840R3**  
Corten



**LD1840N3**  
Grigio scuro / Dark gray  
RAL 7012



**LD1840S3**  
Sabbia / Sand  
RAL 1014



Olivia table lamp dark gray → **LD2850N3**  
Olivia mini table lamp dark gray → **LD2860N3**  
Olivia micro table lamp dark gray → **LD1840N3**

# Pencil <sup>PRO</sup>

Design Federico de Majo



Progetto selezionato dall'Osservatorio Permanente del Design ADI per ADI Design Index 2022.

Project selected by the ADI Permanent Design Observatory for ADI Design Index 2022.

Pencil è un sistema di illuminazione composto da un modulo luminoso a batteria portatile e ricaricabile e dagli accessori dedicati che lo trasformano in lampada da terra, a sospensione e da parete (in due modelli).

Il modulo Pencil può essere usato nel suo alloggiamento fisso, ma anche rimosso, portato con sé da un ambiente all'altro, e usato autonomamente, fino all'esaurimento della batteria (fino a 58 ore). La sorgente a LED produce una luce intensa e ben direzionata: il controllo "touch" presente all'estremità del modulo permette l'accensione, la dimmerazione a 4 step (100%, 60%, 30%, 6%) e la selezione della temperatura di colore della luce. Grazie all'alto indice di protezione, Pencil è utilizzabile anche all'esterno.

Un sistema di controllo elettronico assicura un flusso luminoso costante fino all'esaurimento della batteria, monitora l'autonomia residua e la segnala, aiutando a ottimizzare le ricariche.

*Pencil is a lighting system consisting of a cordless, rechargeable battery light module and dedicated accessories that transform it into a floor lamp, a suspension lamp, or a sconce (available in two models).*

*The light module can be used in its fixed housing but can also be removed, carried from one space to another, and used independently until the battery runs out (up to 58 hours). The LED light source provides intense, well-directed illumination. A touch control at the end of the module allows switching on/off, 4-step dimming (100%, 60%, 30%, 6%) and selecting the color temperature (K).*

*Suitable for both indoor and outdoor use, the lamp features an electronic control system that ensures a constant light output until the battery is depleted, monitors the remaining battery autonomy, and indicates it, helping to optimize charging.*

Pencil lighting module white  
→ **LD0802B3**

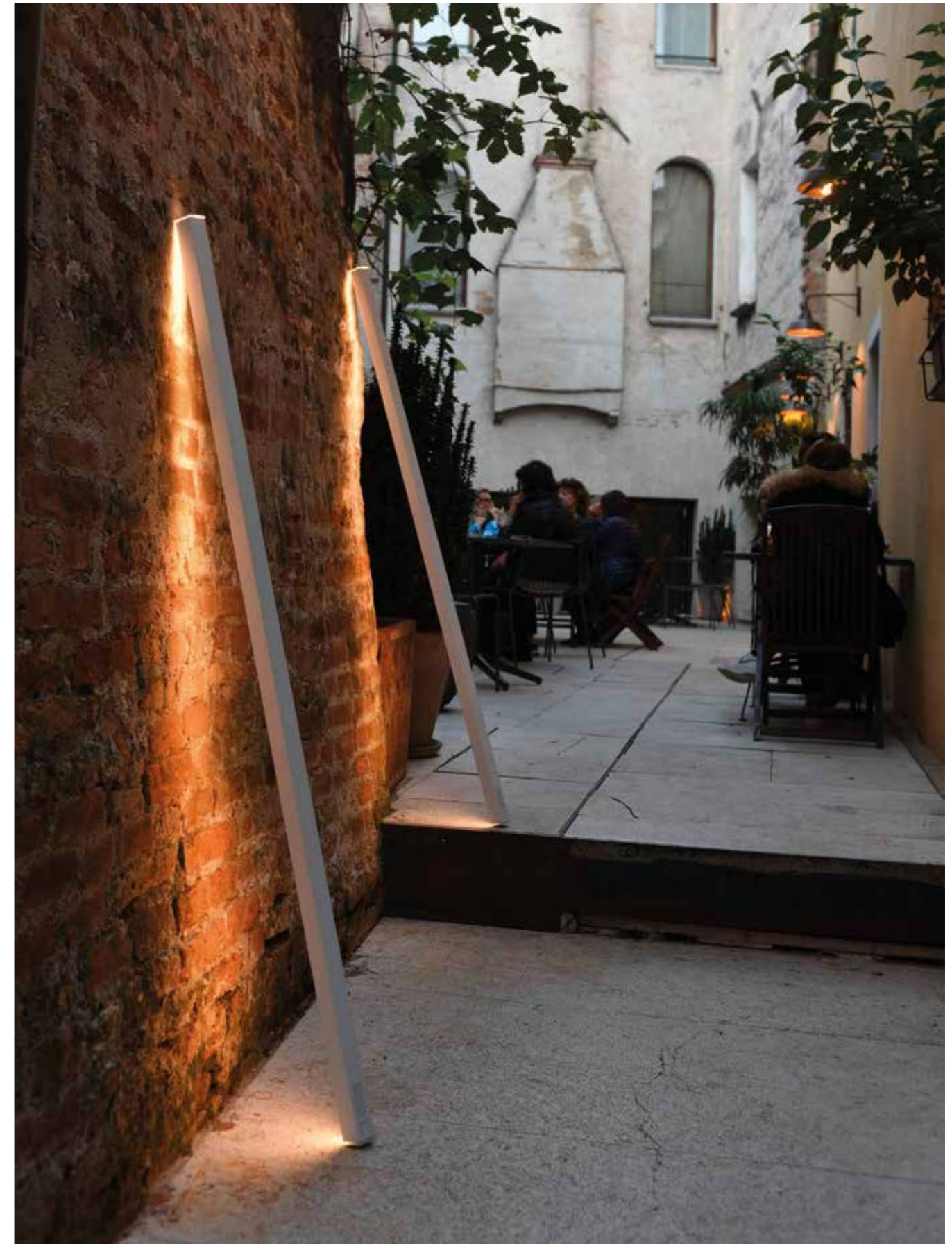

LINK TO VIDEO

Pencil lighting module white  
+ docking station white  
→ **LD0802B3 + LD0810B3**  
Osteria Stasera Corder - Treviso, Italy  
Photo phEsci Francesco Esci

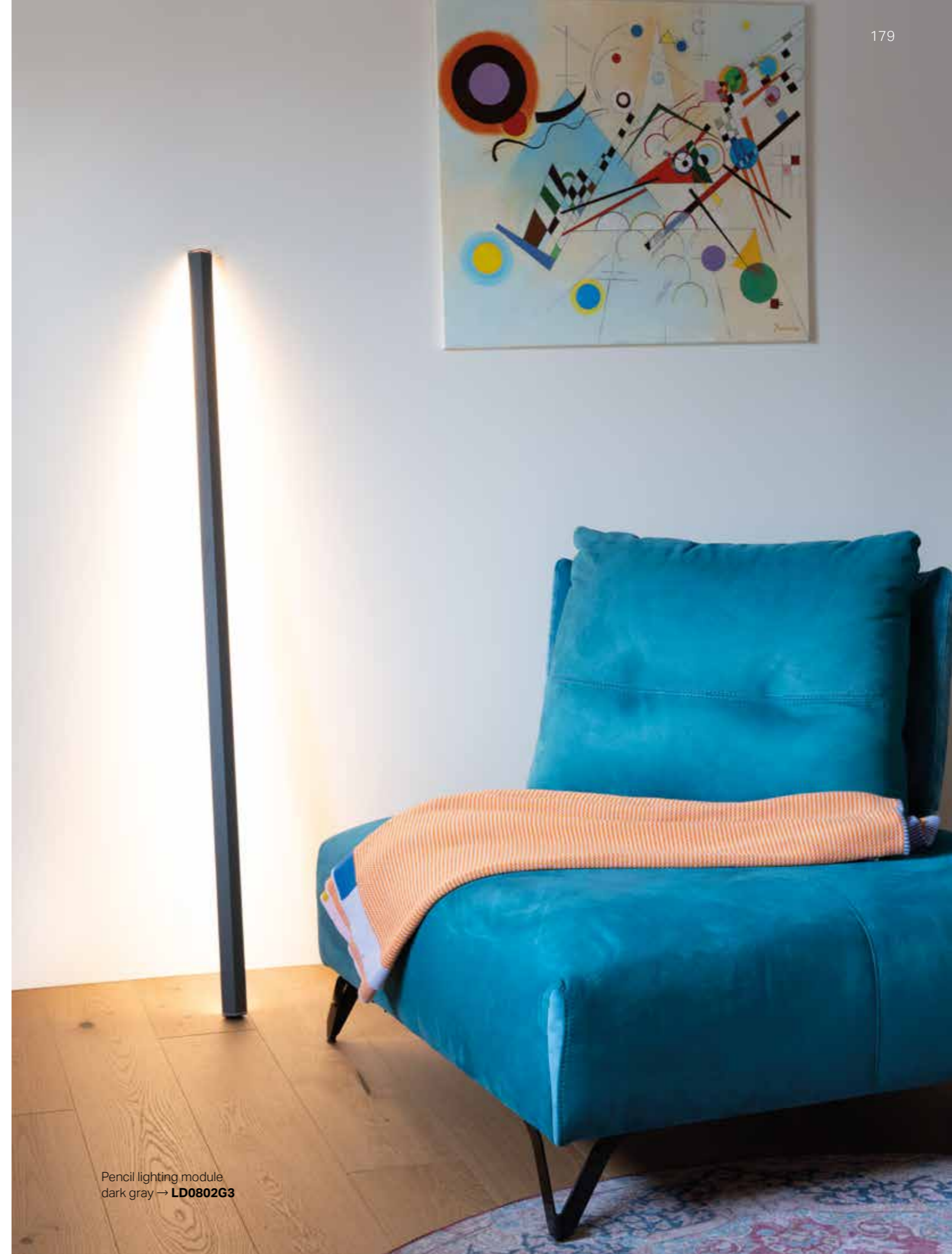

Pencil lighting module  
dark gray → **LD0802G3**

# Pencil<sup>PRO</sup>

Modulo luce  
Lighting module



## Dati tecnici

### Technical data

#### LED TOUCH DIMMER

2700-3150-4000 K | CRI>90  
580-650-680 lm | 6 W | IP65  
19 V max 2,5 A

#### LED TOUCH DIMMER

2700-3150-4000 K | CRI>90  
1160-1300-1360 lm | 12 W | IP65  
19 V max 2,5 A

#### LED TOUCH DIMMER

2700-3150-4000 K | CRI>90  
1740-1950-2040 lm | 18 W | IP65  
19 V max 2,5 A

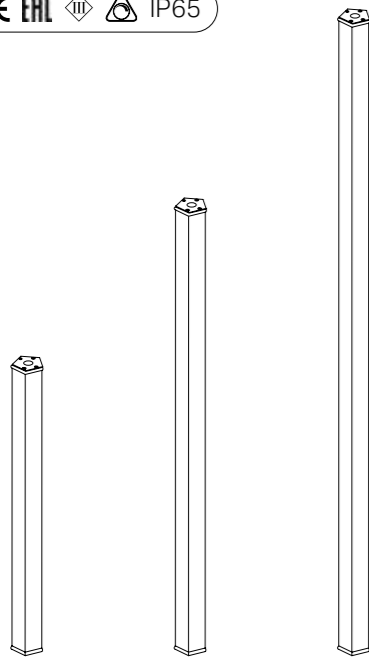

Ø 5,4 x 50 cm    Ø 5,4 x 98 cm    Ø 5,4 x 146 cm

Pacchi batterie al litio ricaricabili e sostituibili  
*Rechargeable and replaceable lithium battery packs*

Durata 8 - 58 h, in base alla regolazione del flusso luminoso  
*Battery lasts 8 - 58 h, depending on the luminous flux setting.*

Ricarica con connettore 3.5/1.3, oppure a contatto (quando usato su base ricarica)  
*Rechargeable with a 3.5/1.3 connector, or by contact (when used with the charging base)*

Tempi di ricarica a 2,5 A: 6/9/12 h (rispettivamente per misura piccola/media/grande)  
*Recharging times at 2.5 A: 6/9/12 h (for small/medium/ large size respectively)*

Corpo in estrusione d'alluminio verniciato  
*Painted extruded aluminum fixture*

Diffusore in policarbonato opale satinato  
*Satin opal polycarbonate diffuser*

Adatta all'uso esterno (lampada IP65) e interno (lampada su base di ricarica IP20)  
*Suitable for outdoor (lamp IP65) and indoor use (lamp on charging base IP20)*

Resistenza agli urti (IK07) e alla nebbia salina (1500h)  
*Impact resistance (IK07) and salt spray resistance (1500h)*

## Finiture Finishes



IP65

Bianco / White  
RAL 9003

Corten

Grigio scuro / Dark gray  
RAL 7012

Small

**LD0800B3**

**LD0800R3**

**LD0800G3**

Medium

**LD0801B3**

**LD0801R3**

**LD0801G3**

Large

**LD0802B3**

**LD0802G3**

## Caricabatterie Battery charger

Componente necessario, da acquistare separatamente (**LD0800CS**)  
*Necessary accessory, yet it must be purchased separately (**LD0800CS**)*

47,5W • 100-240V • 50-60Hz  
19 V max 2,5A

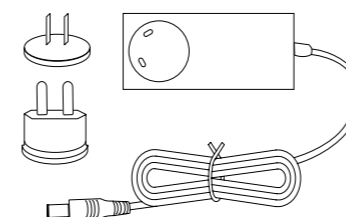

Il caricabatterie permette di ricaricare Pencil in due modi: collegando il cavo (fig. 1) direttamente al modulo luminoso; oppure collegando il cavo alla base di stazionamento e ricarica in cui il modulo viene posizionato (fig. 2).

*The battery charger allows the recharging of Pencil in two ways: either by connecting cable directly to the lighting module (fig. 1); or by connecting the cable to the docking station where the module is placed (fig. 2).*

Componente non incluso  
*Component not included*

Caricatore / Charger → **LD0800CS** (pg. 247) \*  
19 V max 2,5 A | 100-240V

\* Componente necessario, da acquistare separatamente  
*\* Necessary accessory, yet it must be purchased separately*

# Pencil<sup>PRO</sup>

Base di stazionamento e ricarica\*  
*Docking and charging station\**

\* Solo se connesso al caricatore (non incluso)  
 \* Only if connected with the charger (not included)



## Dati tecnici Technical data

19 V max 3,16A



## Finiture Finishes



**LD0810B3**  
 Bianco / White  
 RAL 9003



**LD0810R3**  
 Corten



**LD0810G3**  
 Grigio scuro /  
 Dark gray  
 RAL 7012

Corpo in alluminio verniciato  
*Painted aluminum fixture*

Componente non incluso  
*Component not included*

Caricabatterie / Charger (pg. 247)

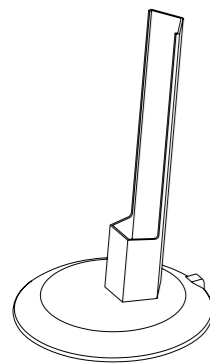

Ø 20 x 32 cm

Accessorio con doppia funzione: è principalmente una base di stazionamento, che trasforma Pencil in lampada da terra o da tavolo; collegato al caricabatterie, diventa una base di ricarica a contatto per il modulo luminoso. Il modulo luminoso può essere usato nel suo alloggiamento fisso, ma anche rimosso e portato con sé da un ambiente all'altro.

*A dual-function accessory: it is mainly used as a docking station, turning the lighting module Pencil into a floor or table lamp. Connected to the battery charger, it becomes a contact charging base for the lighting module. The lighting module can be used in its fixed housing, or detached and carried from one place to another.*

# Pencil<sup>PRO</sup>

Supporti tavolo  
*Table bases*



## Dati tecnici Technical data



## Finiture Finishes



**LD081400**  
 Trasparente / Clear

Supporti in PMMA trasparente  
*Transparent PMMA structure*

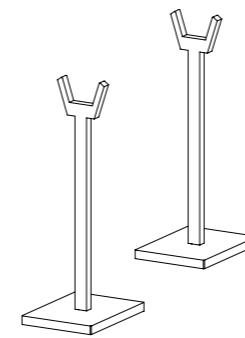

12 x 9 x 28 cm

Elementi che trasformano Pencil in una lampada da tavolo. Il modulo luminoso può essere usato nel suo supporto, ma anche rimosso e portato con sé da un ambiente all'altro.

*Elements that turn Pencil into a table lamp. The lighting module can be used in its fixed housing or detached and carried from one place to another.*

# Pencil<sup>PRO</sup>

Supporti parete orizzontale  
Horizontal wall lamp brackets



Dati tecnici  
Technical data

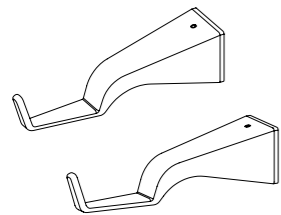

10 x 3 x 2,5 cm

Finiture  
Finishes



**LD0813B3**  
Bianco / White  
RAL 9003



**LD0813R3**  
Corten



**LD0813G3**  
Grigio scuro /  
Dark gray  
RAL 7012

Supporti in pressofusione d'alluminio verniciato  
Painted die-cast aluminum elements

Supporti che trasformano Pencil in una lampada da parete orizzontale. Il modulo luminoso può essere usato nel suo supporto fisso, ma anche rimosso e portato con sé da un ambiente all'altro.

*Brackets that turn Pencil into a horizontal wall lamp. The lighting module can be used in its fixed housing or detached and carried from one place to another.*

# Pencil<sup>PRO</sup>

Supporto parete verticale  
Vertical wall lamp kit



Dati tecnici  
Technical data

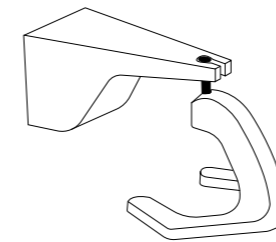

6,4 x 3,8 x 4,7 cm

Finiture  
Finishes



**LD0815B3**  
Bianco / White  
RAL 9003



**LD0815R3**  
Corten



**LD0815G3**  
Grigio scuro /  
Dark gray  
RAL 7012

Supporto in pressofusione d'alluminio verniciato con particolari cromati  
Painted die-cast aluminum element with chromed details

Elemento che trasforma Pencil in una lampada da parete verticale, che ruota sul proprio asse longitudinale a 360°, in entrambi i sensi. Il modulo luminoso può essere usato nel suo supporto fisso, ma anche rimosso e portato con sé da un ambiente all'altro.

*Element that turns Pencil into a vertical wall lamp, rotating on its longitudinal axis by 360°, in both directions. The lighting module can be used in its fixed housing or detached and carried from one place to another.*

# Pencil<sup>PRO</sup>

Supporto sospensione orizzontale  
*Horizontal suspension kit*



Dati tecnici  
*Technical data*

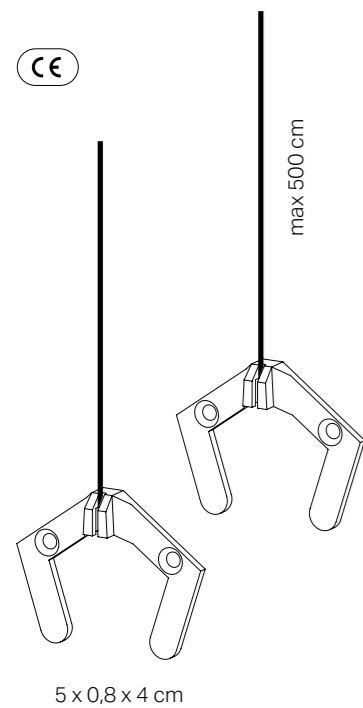

Finiture  
*Finishes*



**LD0812B3**  
Bianco / *White*  
RAL 9003



**LD0812R3**  
Corten



**LD0812G3**  
Grigio scuro /  
*Dark gray*  
RAL 7012

Supporto in pressofusione d'alluminio  
verniciato con particolari cromati  
*Painted die-cast aluminum element with  
chromed details*

Componenti inclusi  
*Components included*

Cavo in acciaio e staffe  
*Steel cable and brackets*

Elementi che trasformano Pencil in una lampada a sospensione orizzontale a luce diretta. Il modulo luminoso può essere usato nel suo supporto fisso, ma anche rimosso e portato con sé da un ambiente all'altro.

*Element that turns Pencil into a horizontal suspension lamp. The lighting module can be used in its fixed housing or detached and carried from one place to another.*

# Pencil<sup>PRO</sup>

Supporto sospensione verticale  
*Vertical suspension kit*



Dati tecnici  
*Technical data*

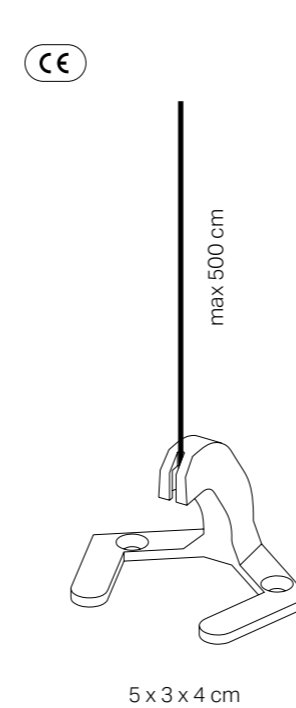

Finiture  
*Finishes*



**LD0811B3**  
Bianco / *White*  
RAL 9003



**LD0811R3**  
Corten



**LD0811G3**  
Grigio scuro /  
*Dark gray*  
RAL 7012

Supporto in pressofusione d'alluminio  
verniciato con particolari cromati  
*Painted die-cast aluminum element with  
chromed details*

Componenti inclusi  
*Components included*

Cavo in acciaio e staffe  
*Steel cable and brackets*

Elemento che trasforma Pencil in una lampada a sospensione verticale. Il modulo luminoso può essere usato nel suo supporto fisso, ma anche rimosso e portato con sé da un ambiente all'altro.

*Element that turns Pencil into a vertical suspension lamp. The lighting module can be used in its fixed housing, or detached and carried from one place to another.*

# Pina <sup>PRO</sup>

Design Zafferano

Pina è una collezione di lampade a batteria, portatili e ricaricabili, disponibili nei modelli da tavolo (due varianti) e da terra, alcuni con testa orientabile. Un controllo "touch", presente sulla testa o sulla base della lampada, permette l'accensione, la regolazione dell'intensità luminosa e la selezione della temperatura di colore della luce. Grazie all'elevato grado di protezione, le lampade possono essere utilizzate anche all'esterno, ad eccezione dei modelli con finitura a foglia metallica, per i quali non si consiglia un uso prolungato in ambienti esterni. Un sistema di controllo elettronico monitora e segnala l'autonomia residua della batteria, permettendo di ottimizzare le ricariche. Tutti i modelli sono dotati di base di ricarica a contatto.

*Pina is a collection of cordless, rechargeable battery lamps, some featuring a tilting and adjustable lamp head. The collection includes two table lamps and a floor lamp. A touch control placed either on the base or on the lamp head allows switching on/off, dimming, and selecting the color temperature (K). With their high protection rating, the lamps are suitable for both indoor and outdoor use, except for the models with a metallic leaf finish, which are not recommended for prolonged outdoor exposure. All models feature an electronic control system that monitors the remaining autonomy, ensuring a constant luminous flux until the battery is depleted: recharging is therefore optimized and always properly done. All models are equipped with a contact charging base.*



LINK TO VIDEO



Pina table lamp  
sand → LD2650S3



Pina XXL floor lamp  
titanium → **LD2670T3**



Pina L desk floor-table  
lamp white → **LD2660B3**

# Pina <sup>PRO</sup>

Lampada da tavolo  
Table lamp

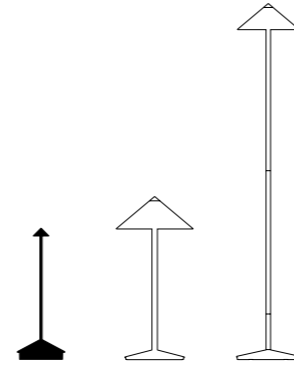

## Dati tecnici

### Technical data

#### LED TOUCH DIMMER

2200-2700-3000 K | CRI>80  
178-204-206 lm | 2.2 W | IP54  
50-60 Hz | 5 V max 1A



Corpo in pressofusione di alluminio verniciato  
*Painted die-cast aluminum body*

Diffusore in policarbonato  
*Polycarbonate diffuser*

Adatta all'uso esterno (lampada IP54) e interno (lampada su base di ricarica IP20)  
*Suitable for outdoor (lamp IP54) and indoor use (lamp on charging base IP20)*

Durata di circa 12 h alla massima potenza  
*Battery lasts about 12 h at full power*

Tempo di ricarica a 1A: 6/7 h  
*Charging time at 1A: 6/7 h*

Pacco batteria al litio ricaricabile e sostituibile  
*Rechargeable and replaceable lithium battery pack*

#### Avvertenze Remarks

Le lampade con finitura in foglia metallica (oro, argento, rame) non sono adatte ad un uso prolungato in ambiente esterno.  
*The lamps with metallic-leaf finishes (gold, silver and copper) are not suitable for prolonged outdoor use.*

Per effetto della natura manuale della tecnica adottata nella lavorazione con foglia metallica, l'aspetto finale della finitura delle lampade può risultare differente. Eventuali difformità attestano il pregio e l'unicità di ciascuna lampada e non vanno considerate come imperfezioni.  
*Due to the manual nature of the technique adopted in the application of the metal foil, the final appearance of the lamps' finishing can be different. Any apparent imperfections attest to the quality and exclusivity of each lamp and should not be considered as imperfections.*

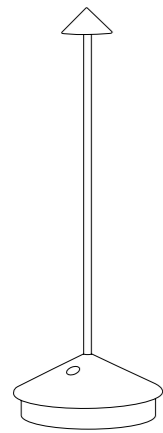

Ø 10,5 x 29 cm

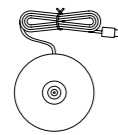

Ø 7,5 cm

#### Componenti inclusi

##### Components included

Base di ricarica a contatto (USB-A)  
*Contact charging base (USB-A)*

#### Accessori non inclusi

##### Accessories not included

Caricatore a spina / USB charger → **LD0490UA**  
5 V max 1A | 100-240V | USB-A (pg. 247)

## Finiture Finishes

IP54



**LD2650B3**  
Bianco / White  
RAL 9003



**LD2650R3**  
Corten



**LD2650N3**  
Grigio scuro / Dark gray



**LD2650D3**  
Nero / Black  
RAL 9004



**LD2650S3**  
Sabbia / Sand



**LD2650O3**  
Oro / Gold  
GHL



**LD2650T3**  
Titanio / Titanium  
MTI



**LD2650W3**  
Bronzo / Bronze  
MBR

**Finiture**  
*Finishes*



**LD2650BFO \***  
Foglia color oro / *Gold color leaf*  
RAL 9003



**LD2650BFA \***  
Foglia color argento / *Silver color leaf*  
RAL 9003



**LD2650RFR \***  
Foglia color rame / *Copper color leaf*  
RAL 9003

Pina table lamp  
gold color leaf → **LD2650BFO**



\* Le lampade con finitura in foglia metallica (oro, argento, rame) non sono adatte ad un uso prolungato in ambiente esterno.

\* *The lamps with metallic-leaf finishes (gold, silver and copper) are not suitable for prolonged outdoor use.*

# Pina L DESK<sup>PRO</sup>

Lampada da tavolo  
Table lamp

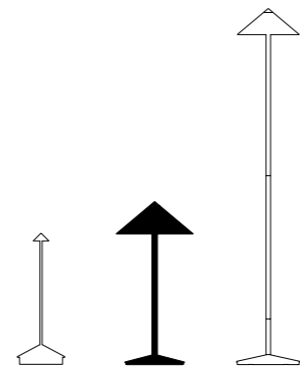

## Dati tecnici

### Technical data

#### LED TOUCH DIMMER

2200-2700-3000 K | CRI>90  
554-655-663 lm | 6.0 W | IP65  
5 V max 2A



Corpo in pressofusione di alluminio verniciato  
*Painted die-cast aluminum body*

Diffusore in policarbonato opale  
*Opal polycarbonate diffuser*

Testa magnetica orientabile  
*Magnetic swivel head*

Adatta all'uso esterno (lampada IP65) e interno (lampada su base di ricarica IP20)  
*Suitable for outdoor (lamp IP65) and indoor use (lamp on charging base IP20)*

Durata di circa 12/13 h alla massima potenza  
*Battery lasts about 12/13 h at full power*

Tempo di ricarica a 2A: 8/9 h  
*Charging time at 2A: 8/9 h*

Pacco batteria al litio ricaricabile e sostituibile  
*Rechargeable and replaceable lithium battery pack*

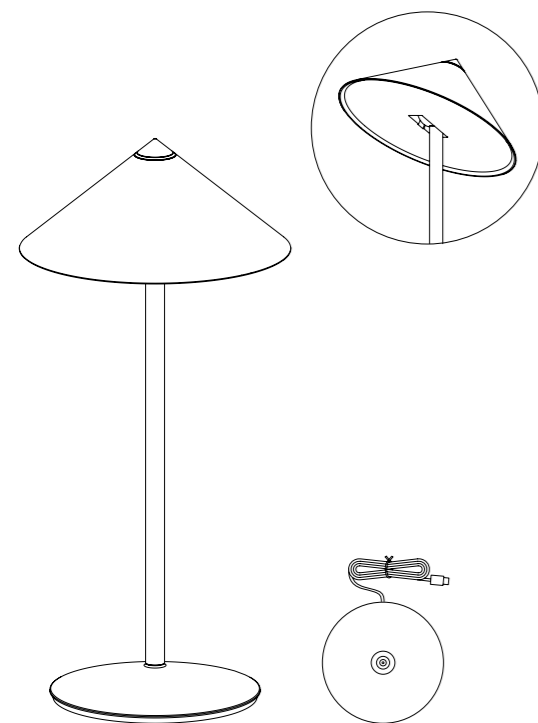

Ø 25,8 x 55 cm

Ø 20 cm

### Componenti inclusi Components included

Base di ricarica a contatto (USB-A)  
*Contact charging base (USB-A)*

### Accessori non inclusi Accessories not included

Caricatore / *Charger* → **LD0300UC**  
5 V max 2,1 A | 100-240V | USB-A (pg. 247)

## Finiture Finishes

IP65



**LD2660B3**  
Bianco / *White*  
WRW



**LD2660T3**  
Titanio / *Titanium*  
MTI



**LD2660W3**  
Bronzo / *Bronze*  
MBR



**LD2660O3**  
Oro / *Gold*  
GHL



# Pina XXL <sup>PRO</sup>

Lampada da terra  
Floor lamp

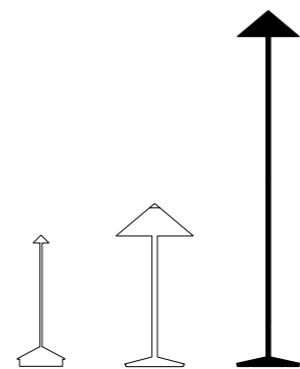

## Dati tecnici

### Technical data

#### LED TOUCH DIMMER

2200-2700-3000 K | CRI>90  
554-655-663 lm | 6.0 W | IP65  
5 V max 2A

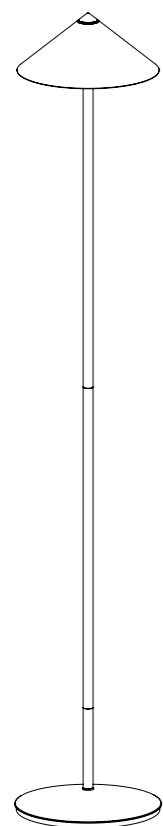

Ø 25,8 x 150 cm

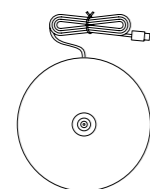
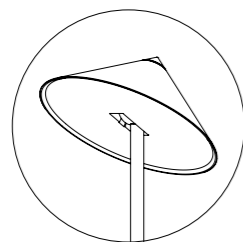

Ø 24,7 cm

Corpo in pressofusione di alluminio verniciato  
*Painted die-cast aluminum body*

Diffusore in policarbonato opale  
*Opal polycarbonate diffuser*

Testa magnetica orientabile  
*Magnetic swivel head*

Adatta all'uso esterno (lampada IP65) e interno (lampada su base di ricarica IP20)  
*Suitable for outdoor (lamp IP65) and indoor use (lamp on charging base IP20)*

Durata di circa 12/13 h alla massima potenza  
*Battery lasts about 12/13 h at full power*

Tempo di ricarica a 2A: 8/9 h  
*Charging time at 2A: 8/9 h*

Pacco batteria al litio ricaricabile e sostituibile  
*Rechargeable and replaceable lithium battery pack*

### Componenti inclusi Components included

Base di ricarica a contatto (USB-A)  
*Contact charging base (USB-A)*

Stelo (2 pz.)  
*Stem (2 pcs.)*

### Accessori non inclusi Accessories not included

Caricatore / *Charger* → **LD0300UC**  
5 V max 2,1 A | 100-240V | USB-A (pg. 247)

## Finiture Finishes

IP65



**LD2670B3**  
Bianco / *White*  
WRW

**LD2670T3**  
Titanio / *Titanium*  
MTI

**LD2670W3**  
Bronzo / *Bronze*  
MBR

**LD2670O3**  
Oro / *Gold*  
GHL

# Push-up<sup>PRO</sup>

Design Zafferano

Push-up è una lampada da tavolo a batteria, portatile e ricaricabile. Premendo la parte superiore della lampada, questa si solleva e contemporaneamente si accende; premendo nuovamente fino alla chiusura, la lampada si spegne.

Sotto la base è presente un controllo "touch", che – quando la parte superiore della lampada è sollevata – permette lo spegnimento, la regolazione dell'intensità luminosa e la selezione della temperatura di colore della luce.

Grazie all'alto indice di protezione, la lampada è utilizzabile anche all'esterno.

Un sistema di controllo elettronico monitora e segnala l'autonomia residua della batteria, permettendo di ottimizzare le ricariche ed effettuarle sempre in maniera corretta. È dotata di base di ricarica a contatto.

*Push-up is a cordless, rechargeable battery table lamp. Pushing the lid down, lifts the diffuser up and turns the light on; pushing the lid back down, closes the lamp while turning the light off. A touch control hidden under the base allows switching on/off, dimming, and selecting the color temperature (K). Suitable for both indoor and outdoor use, it features an electronic control system that monitors and indicates the remaining battery life, allowing for optimized charging. The lamp is equipped with a contact charging base.*



LINK TO VIDEO



Push-up table lamp  
ochre → **LD1050H3**

# Push-up<sup>PRO</sup>

Lampada da tavolo  
Table lamp



## Dati tecnici

### Technical data

#### LED TOUCH DIMMER

2200-2700-3000 K | CRI>80  
207-235-248 lm | 2.2 W | IP54  
5 V max 1A



Corpo in pressofusione di alluminio verniciato  
*Painted die-cast aluminum body*

Diffusore in policarbonato  
*Polycarbonate diffuser*

Adatta all'uso esterno (lampada IP54) e interno  
(lampada su base di ricarica IP20)  
*Suitable for outdoor (lamp IP54) and indoor use (lamp  
on charging base IP20)*

Durata di circa 11/12 h alla massima potenza  
*Battery lasts about 11/12 h at full power*

Tempo di ricarica a 1A: 5/6 h  
*Charging time at 1A: 5/6 h*

Pacco batteria al litio ricaricabile e sostituibile  
*Rechargeable and replaceable lithium battery pack*

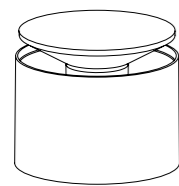

Ø 12 x 8,3-10 cm

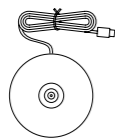

Ø 10 cm

### Componenti inclusi Components included

Base di ricarica a contatto (USB-A)  
*Contact charging base (USB-A)*

### Accessori non inclusi Accessories not included

Caricatore a spina / USB charger → **LD0490UA**  
5 V max 1A | 100-240V | USB-A (pg. 247)

## Finiture Finishes

IP54



**LD1050B3**  
Bianco / White  
RAL 9003



**LD1050R3**  
Corten



**LD1050N3**  
Grigio scuro / Dark  
gray



**LD1050S3**  
Sabbia / Sand



**LD1050H3**  
Ocra / Ochre  
RAL 1006



Push-up table lamp  
dark gray → **LD1050N3**

# Sister Light PRO

Design Federico de Majo

Sister Light è una collezione di lampade da tavolo a batteria, portatili e ricaricabili, disponibili in due modelli, controllabili anche da remoto mediante l'utilizzo dell'applicazione Zafferano Lighting (pag. 6).

Nella parte superiore della testa è presente un controllo "touch", che permette l'accensione, la dimmerazione a 4 step (100%, 60%, 30%, 6%) e la selezione della temperatura di colore della luce. Grazie all'alto indice di protezione, le lampade sono utilizzabili anche all'esterno.

Un sistema di controllo elettronico assicura un flusso luminoso costante fino all'esaurimento della batteria, monitora l'autonomia residua e la segnala, aiutando a ottimizzare le ricariche. Tutti i modelli si ricaricano in due modi: svitando la testa e posizionandola sulla base di ricarica a contatto (inclusa), oppure appoggiando direttamente l'intera lampada sulla base di ricarica.

*Sister Light is a collection of cordless, rechargeable battery lamps that can be remotely controlled using the Zafferano Lighting app (see page 6).*

*The collection includes a table lamp in two heights. A touch control placed on the lamp head allows switching on/off, 4-step dimming (100%, 60%, 30%, 6%) and selecting the color temperature (K).*

*Suitable for both indoor and outdoor use, the lamps feature an electronic control system that ensures a constant light output until the battery is depleted, monitors the remaining battery autonomy, and indicates it, helping to optimize charging. All models can be recharged in two ways: by unscrewing the lamp head and placing it on the contact charging base (included), or by placing the entire lamp directly on the charging base.*



LINK TO VIDEO

Sister Light Wi-Fi table lamp  
copper → **LD2080R3**  
42 Restaurant & Bar  
Esztergom, Hungary  
Photo Patrik Fábian



Sister Light Wi-Fi mini table  
green → **LD2181V3**

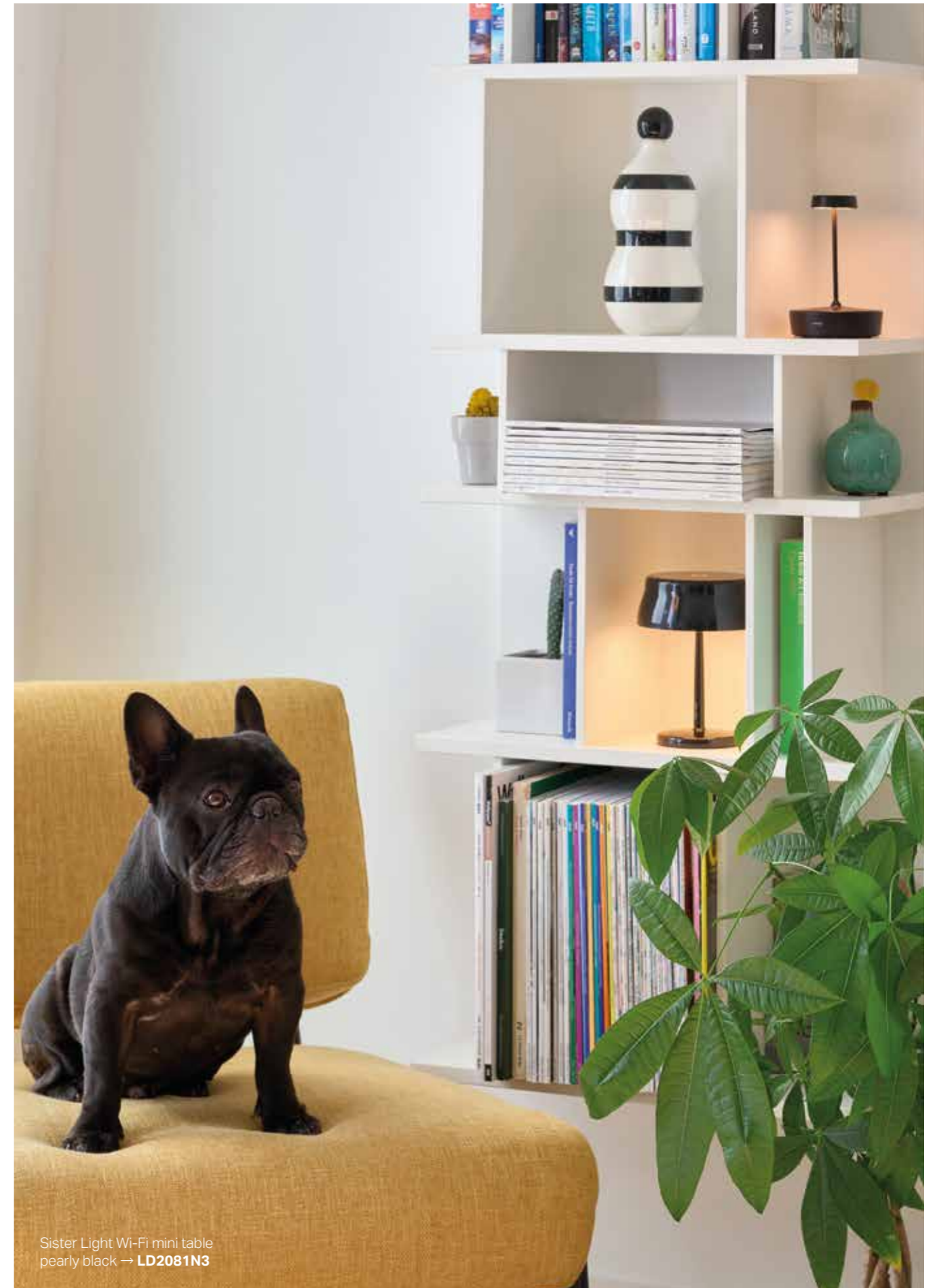

Sister Light Wi-Fi mini table  
pearly black → **LD2081N3**

# Sister Light Wi-Fi <sup>PRO</sup>

Lampada da tavolo  
Table lamp

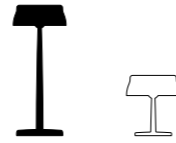

## Dati tecnici

### Technical data

#### LED TOUCH DIMMER

2200-2700-3000-4000 K | CRI>90  
300-342-343-359 lm | 3.2 W | IP65  
5 V max 2A



Corpo in alluminio anodizzato spazzolato  
(oro, rame, verde) oppure verniciato  
(bianco perlato, nero perlato, avorio)  
*Brushed anodized (gold, copper, green) or painted  
aluminum body (pearly white, pearly black, ivory)*

Diffusore in policarbonato prismatico  
*Prismatic polycarbonate diffuser*

Adatta all'uso esterno (lampada IP65) e interno  
(lampada su base di ricarica IP20)  
*Suitable for outdoor (lamp IP65) and indoor use  
(lamp on charging base IP20)*

Resistenza agli urti (IK07) e alla nebbia salina (oltre 1000 h)  
*Impact resistance (IK07) and salt spray resistance (over  
1000 h)*

Durata 8 - 36 h, in base alla regolazione del flusso  
luminoso e alle impostazioni del Wi-Fi  
*Battery lasts 8 - 36 h, depending on the luminous  
flux and Wi-Fi setting*

Tempo di ricarica a 2A: 4 h  
*Charging time at 2A: 4 h*

Pacco batteria al litio ricaricabile e sostituibile  
*Rechargeable and replaceable lithium battery pack*

Firmware del dispositivo aggiornabile da remoto  
*Remotely upgradable device firmware*

#### Avvertenze Remarks

Per poter funzionare in modalità Wi-Fi, la lampada deve essere  
collegata a una rete con frequenza 2,4 GHz.

*In order to work in Wi-Fi mode, the lamp must be connected to a 2.4  
GHz frequency network.*



Ø 13,2 x 33 cm

Ø 11,3 cm

Ø 7,5 cm

#### Componenti inclusi Components included

Base di ricarica a contatto (USB-A)  
*Contact charging base (USB-A)*

Adattatore per base di ricarica a contatto  
*Contact charging base adapter*

#### Accessori non inclusi Accessories not included

Caricatore / *Charger* → **LD0300UC**  
5 V max 2,1 A | 100-240V | USB-A (pg. 247)

## Finiture Finishes

IP65



**LD208003**  
Oro / Gold



**LD2080R3**  
Rame / Copper



**LD2080V3**  
Verde / Green



**LD2080B3**  
Bianco perlato / Pearly white  
RAL 9010



**LD2080D3**  
Nero perlato / Pearly Black  
RAL 9011



**LD2080I3**  
Avorio / Ivory  
RAL 1015

# Sister Light Wi-Fi mini <sup>PRO</sup>

Lampada da tavolo  
Table lamp

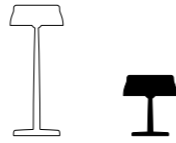

## Dati tecnici

### Technical data

#### LED TOUCH DIMMER

2200-2700-3000-4000 K | CRI>90  
300-342-343-359 lm | 3.2 W | IP65  
5 V max 2A



Corpo in alluminio anodizzato spazzolato  
(oro, rame, verde) oppure verniciato  
(bianco perlato, nero perlato, avorio)  
*Brushed anodized (gold, copper, green) or painted  
aluminum body (pearly white, pearly black, ivory)*

Diffusore in policarbonato prismatico  
*Prismatic polycarbonate diffuser*

Adatta all'uso esterno (lampada IP65) e interno  
(lampada su base di ricarica IP20)  
*Suitable for outdoor (lamp IP65) and indoor use  
(lamp on charging base IP20)*

Resistenza agli urti (IK07) e alla nebbia salina (oltre 1000 h)  
*Impact resistance (IK07) and salt spray resistance (over  
1000 h)*

Durata 8 - 36 h, in base alla regolazione del flusso  
luminoso e alle impostazioni del Wi-Fi  
*Battery lasts 8 - 36 h, depending on the luminous  
flux and Wi-Fi setting*

Tempo di ricarica a 2A: 4 h  
*Charging time at 2A: 4 h*

Pacco batteria al litio ricaricabile e sostituibile  
*Rechargeable and replaceable lithium battery pack*

Firmware del dispositivo aggiornabile da remoto  
*Remotely upgradable device firmware*

#### Avvertenze Remarks

Per poter funzionare in modalità Wi-Fi, la lampada deve essere  
collegata a una rete con frequenza 2,4 GHz.

*In order to work in Wi-Fi mode, the lamp must be connected to a 2.4  
GHz frequency network.*

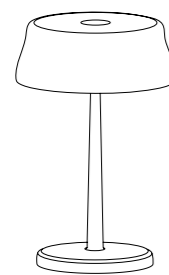

Ø 13,2 x 17 cm

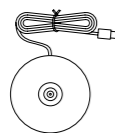

Ø 7,5 cm

#### Componenti inclusi Components included

Base di ricarica a contatto (USB-A)  
Contact charging base (USB-A)

#### Accessori non inclusi Accessories not included

Caricatore / Charger → **LD0300UC**  
5 V max 2,1 A | 100-240V | USB-A (pg. 247)

## Finiture Finishes

IP65



#### LD2081O3

Oro / Gold



#### LD2081R3

Rame / Copper



#### LD2081V3

Verde / Green



#### LD2081B3

Bianco perlato / Pearly white  
RAL 9010



#### LD2081D3

Nero perlato / Pearly Black  
RAL 9011



#### LD2081I3

Avorio / Ivory  
RAL 1015

# Super O<sup>PRO</sup>

Design Studio Kairos

Super O è una collezione di lampade a batteria, portatili e ricaricabili, disponibili in varie tipologie: da tavolo, da terra in tre varianti, terra sospesa in tre varianti, da parete in due modelli, e a sospensione.

Il modulo luminoso si fissa alla montatura di ciascun modello tramite un magnete, e – ruotando a 360° – permette di orientare la luce; inoltre, si rimuove in modo pratico e si ricarica comodamente connettendolo all'apposito disco di ricarica a contatto, incluso. Un controllo "touch" presente nella parte superiore del modulo permette l'accensione, la dimmerazione a 4 step (100%, 60%, 30%, 6%) e la selezione della temperatura di colore della luce.

Un sistema di controllo elettronico monitora l'autonomia residua e garantisce un flusso luminoso costante fino all'esaurimento della batteria, permettendo di ottimizzare le ricariche ed effettuarle sempre in maniera corretta. Adatta esclusivamente a uso interno.

*Super O is a collection of cordless, rechargeable battery lamps consisting of table lamp, floor lamp (three variants), ceiling-suspended floor lamp (three variants), sconce (two variants), and a pendant.*

*The LED module is attached to the frame of the lamps with a magnetic mount. It can rotate 360°, allowing to direct the flow of light; and can be easily removed from the frame and conveniently recharged on the provided contact charging puck.*

*A touch sensor on the module allows switching on/off, 4-step dimming (100%, 60%, 30%, 6%) and selecting the color temperature (K).*

*Suitable for indoor use only, the lamp features an electronic control system that ensures a constant light output until the battery is depleted, monitors the remaining battery autonomy, and indicates it, helping to optimize charging.*



LINK TO VIDEO



Super O ceiling-suspended floor lamp  
(1 Lighting module), black → **LD1157N3**



Super O sconce white → **LD1151B3**  
Liola multipurposed three-legged black → **ZLS0104**  
Lido bottle, blue stripes → **RIG1501**

Super O floor lamp (2 Lighting modules)  
black → **LD1155N3**

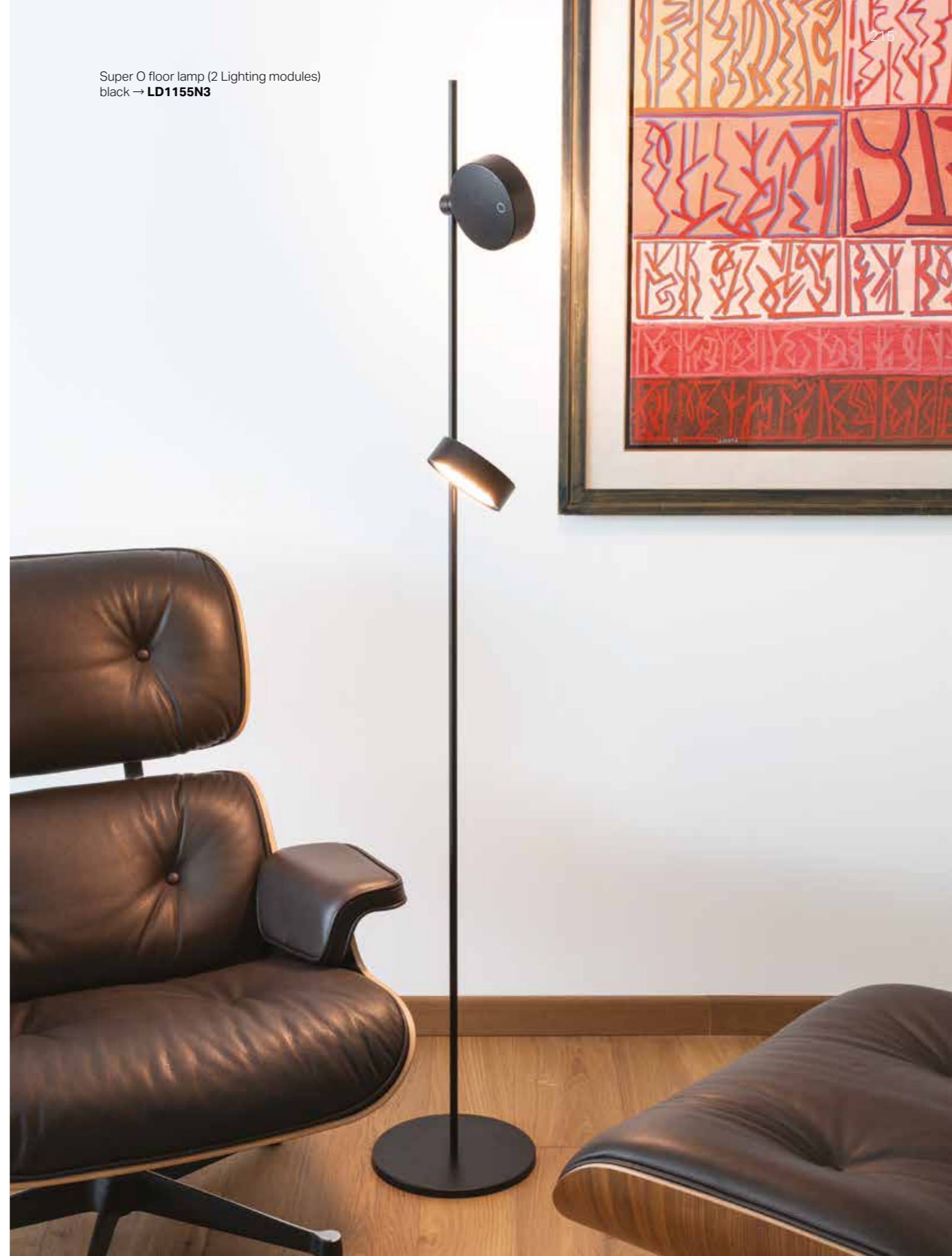

# Super O<sup>PRO</sup>

Lampada da tavolo  
Table lamp

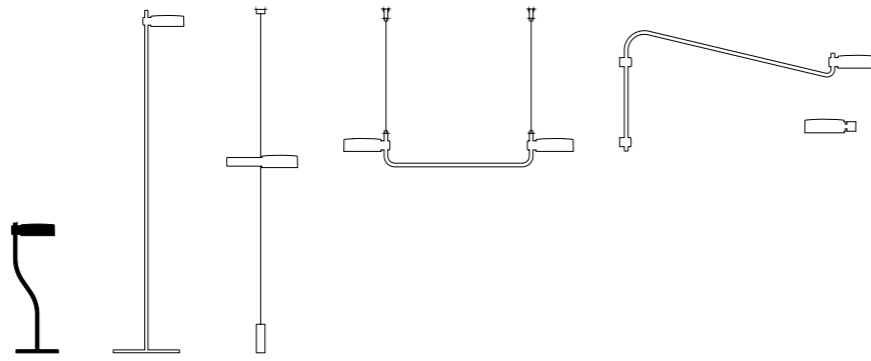

## Dati tecnici

### Technical data

#### LED TOUCH DIMMER

2700-3150-4000 K | CRI>90  
287-331-336 lm | 3.5 W | IP65  
5 V max 2A



Corpo in pressofusione di alluminio verniciato  
*Painted die-cast aluminum body*

Diffusore in policarbonato prismatico  
*Prismatic polycarbonate diffuser*

Adatta all'uso interno  
*Suitable for indoor use*

Durata 11-160 h, in base alla regolazione del flusso luminoso  
*Battery lasts 11-160 h, depending on the luminous flux setting*

Tempo di ricarica a 2A: 5 h  
*Charging time at 2A: 5 h*

Pacco batteria al litio ricaricabile e sostituibile  
*Rechargeable and replaceable lithium battery pack*

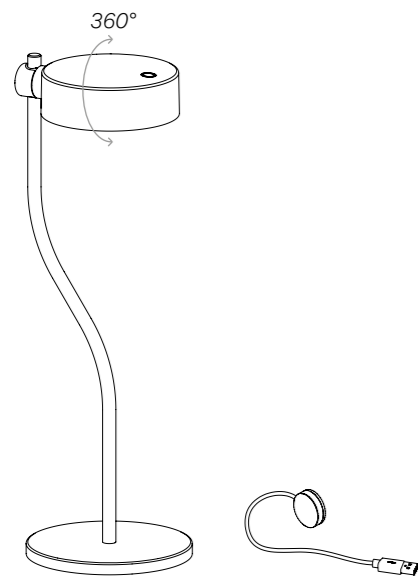

16,6 x 46 x 15 cm

Ø 3 x 1 cm

#### Componenti inclusi Components included

Disco per ricarica a contatto (USB-A)  
*Contact charging puck (USB-A)*

#### Accessori non inclusi Accessories not included

Caricatore / *Charger* → **LD0300UC**  
5 V max 2,1 A | 100-240V | USB-A (pg. 247)

## Finiture Finishes

IP65



#### LD1152B3

Bianco / *White*  
RAL 9003

#### LD1152N3

Nero / *Black*  
RAL 9005



Super O table lamp  
white → **LD1152B3**

# Super O<sup>PRO</sup>

Lampada da terra  
Floor lamp

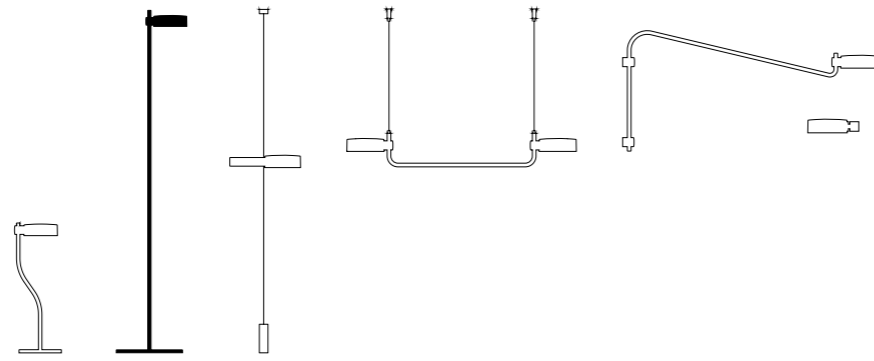

## Dati tecnici

### Technical data

#### LED TOUCH DIMMER

2700-3150-4000 K | CRI>90  
287-331-336 lm | 3.5 W | IP65  
5 V max 2A

CE ENEC IP65

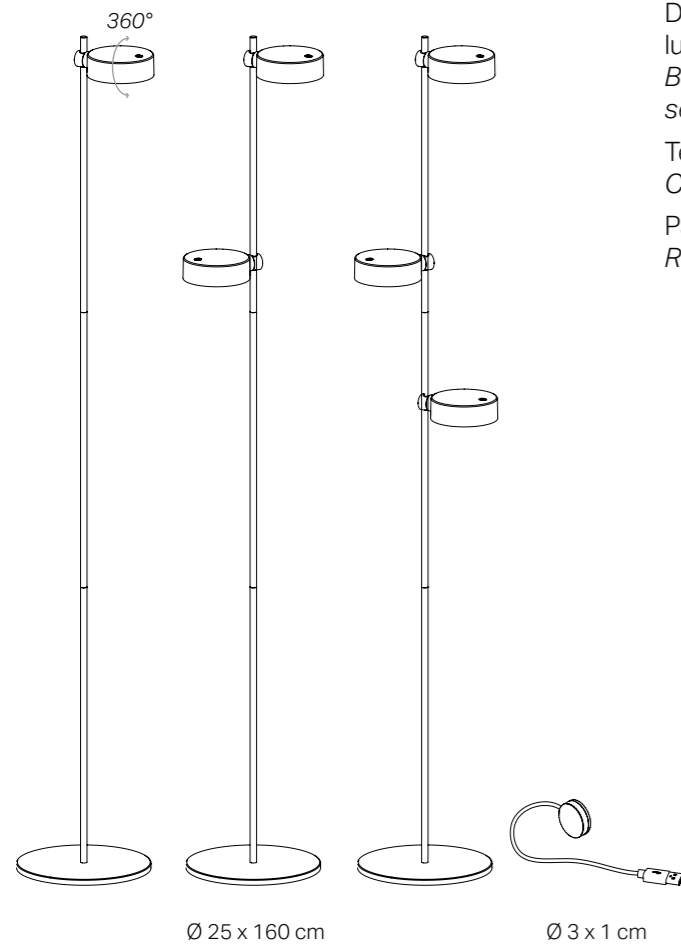

Corpo in pressofusione di alluminio verniciato  
*Painted die-cast aluminum body*

Diffusore in policarbonato prismatico  
*Prismatic polycarbonate diffuser*

Adatta all'uso interno  
*Suitable for indoor use*

Durata 11-160 h, in base alla regolazione del flusso luminoso  
*Battery lasts 11-160 h, depending on the luminous flux setting*

Tempo di ricarica a 2A: 5 h  
*Charging time at 2A: 5 h*

Pacco batteria al litio ricaricabile e sostituibile  
*Rechargeable and replaceable lithium battery pack*

#### Componenti inclusi Components included

Disco per ricarica a contatto  
*Contact charging puck*

#### Accessori non inclusi Accessories not included

Caricatore / *Charger* → **LD0300UC**  
5 V max 2,1 A | 100-240V | USB-A (pg. 247)

## Finiture Finishes

IP65

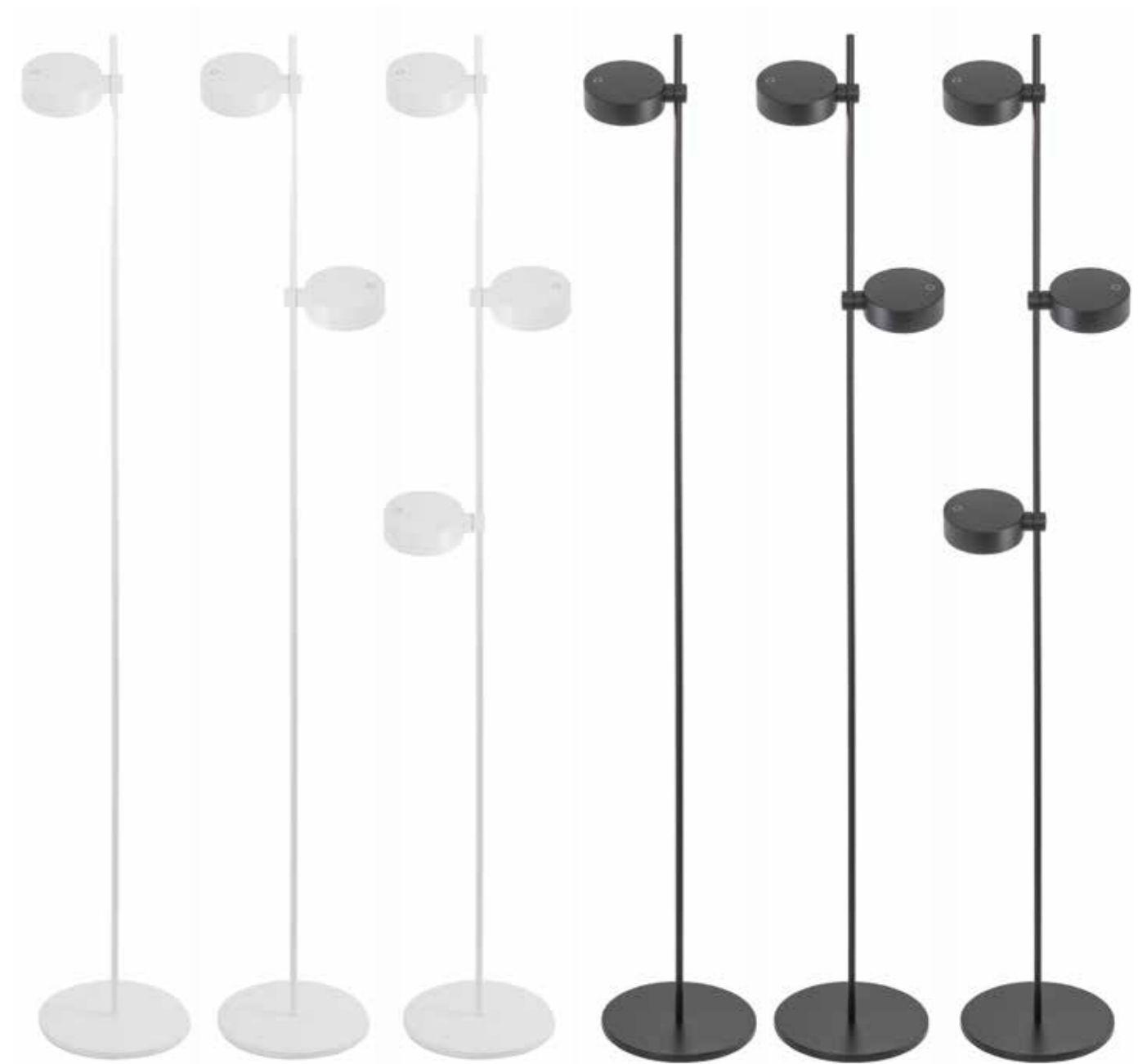

Bianco / *White*  
RAL 9003

1 Modulo luce  
*1 Lighting module*  
**LD1154B3**

2 Moduli luce  
*2 Lighting modules*  
**LD1155B3**

3 Moduli luce  
*3 Lighting modules*  
**LD1156B3**

Nero / *Black*  
RAL 9005

1 Modulo luce  
*1 Lighting module*  
**LD1154N3**

2 Moduli luce  
*2 Lighting modules*  
**LD1155N3**

3 Moduli luce  
*3 Lighting modules*  
**LD1156N3**

# Super O<sup>PRO</sup>

Lampada da terra sospesa  
Ceiling – suspended floor lamp

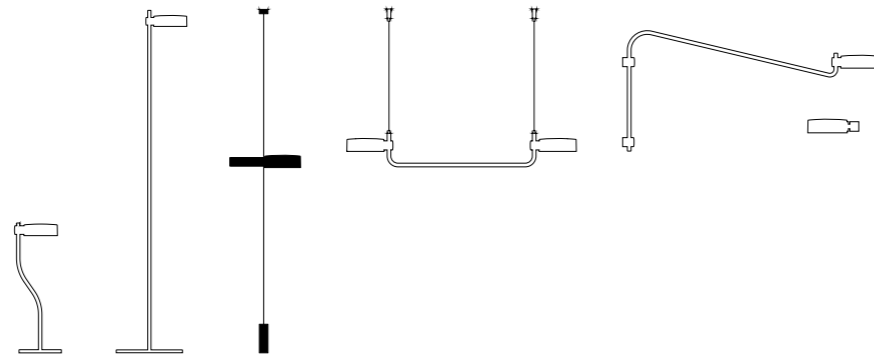

## Dati tecnici

### Technical data

#### LED TOUCH DIMMER

2700-3150-4000 K | CRI>90  
287-331-336 lm | 3.5 W | IP65  
5 V max 2A



Corpo in pressofusione di alluminio verniciato  
*Painted die-cast aluminum body*

Diffusore in policarbonato prismatico  
*Prismatic polycarbonate diffuser*

Adatta all'uso interno  
*Suitable for indoor use*

Durata 11-160 h, in base alla regolazione del flusso luminoso  
*Battery lasts 11-160 h, depending on the luminous flux setting*

Tempo di ricarica a 2A: 5 h  
*Charging time at 2A: 5 h*

Pacco batteria al litio ricaricabile e sostituibile  
*Rechargeable and replaceable lithium battery pack*

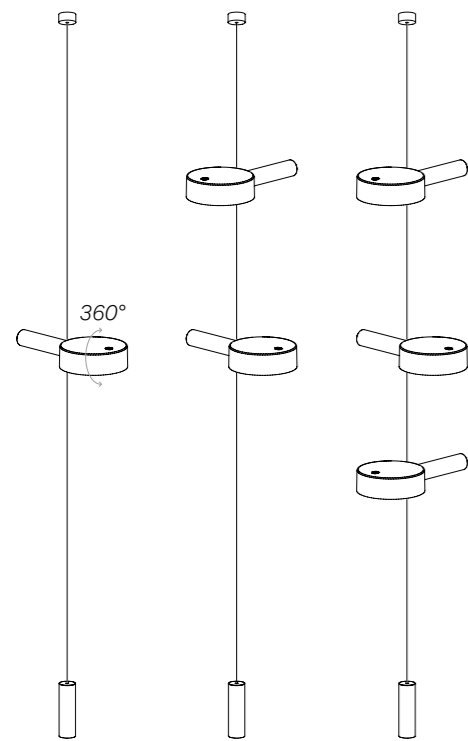

24,7 x 500 x 12,5 cm

Ø 3 x 1 cm

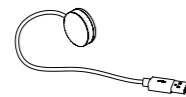

#### Componenti inclusi Components included

Disco per ricarica a contatto / *Contact charging puck*  
Cavo di colore grigio scuro / *Dark gray cable*  
Cavo di colore rosso / *Red cable*  
Contrappeso da terra / *Floor counterweight*  
Contrappeso modulo luce  
*Counterweight for lighting module*

#### Accessori non inclusi Accessories not included

Caricatore / *Charger* → **LD0300UC**  
5 V max 2,1 A | 100-240V | USB-A (pg. 247)

## Finiture Finishes

IP65

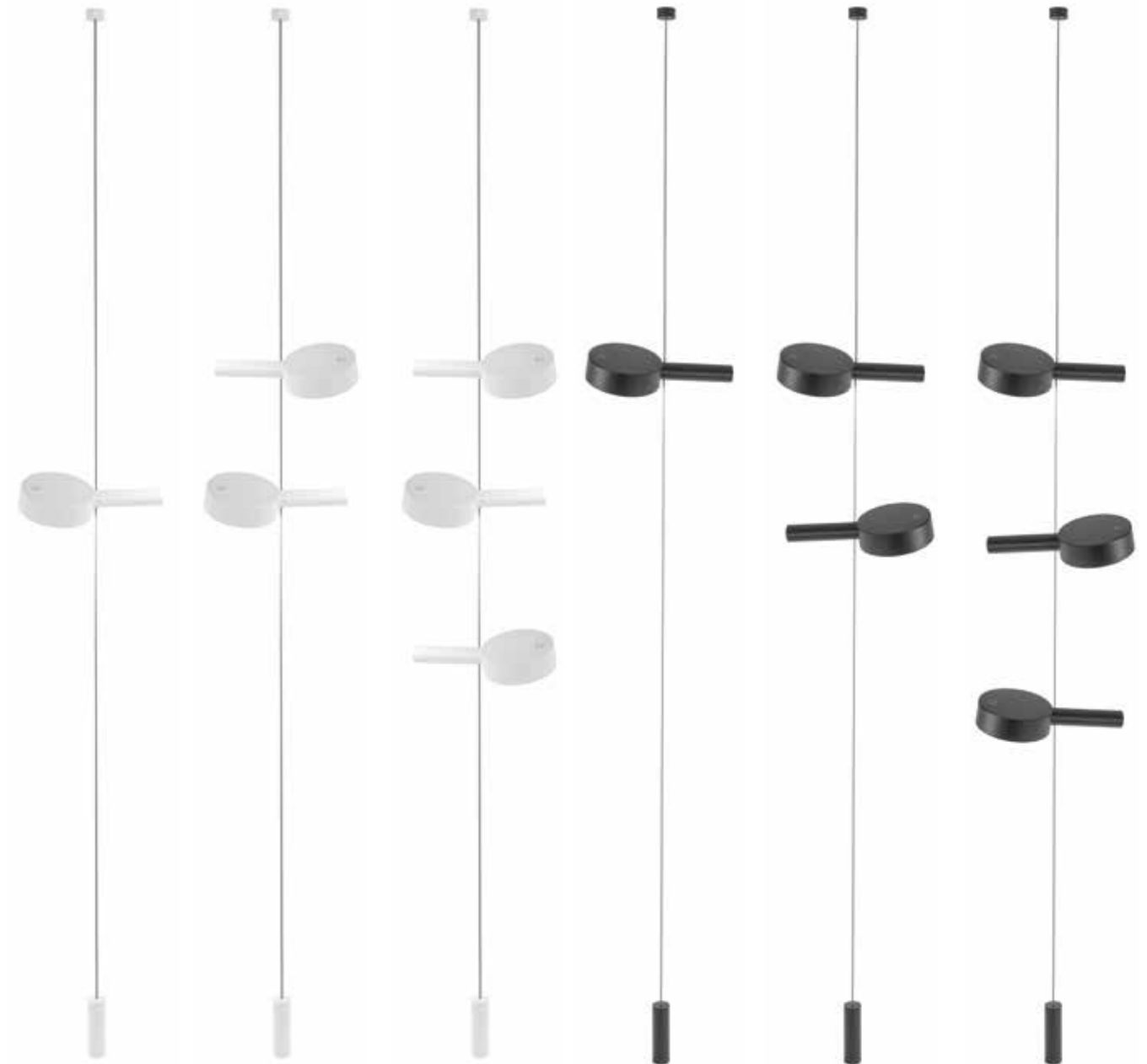

Bianco / *White*  
RAL 9003

1 Modulo luce  
*1 Lighting module*  
**LD1157B3**

2 Moduli luce  
*2 Lighting modules*  
**LD1158B3**

3 Moduli luce  
*3 Lighting modules*  
**LD1159B3**

Nero / *Black*  
RAL 9005

1 Modulo luce  
*1 Lighting module*  
**LD1157N3**

2 Moduli luce  
*2 Lighting modules*  
**LD1158N3**

3 Moduli luce  
*3 Lighting modules*  
**LD1159N3**

# Super O<sup>PRO</sup>

Lampada a sospensione  
Suspension lamp

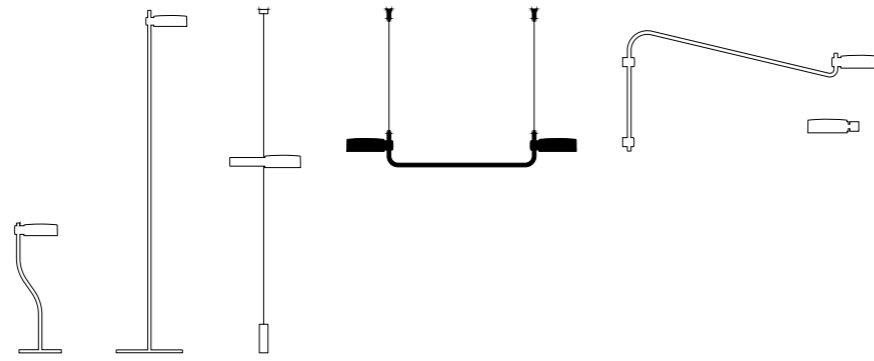

## Dati tecnici

### Technical data

#### LED TOUCH DIMMER

2700-3150-4000 K | CRI>90  
287-331-336 lm | 3.5 W | IP65  
5 V max 2A



Corpo in pressofusione di alluminio verniciato  
*Painted die-cast aluminum body*

Diffusore in policarbonato prismatico  
*Prismatic polycarbonate diffuser*

Adatta all'uso interno  
*Suitable for indoor use*

Durata 11-160 h, in base alla regolazione del flusso luminoso  
*Battery lasts 11-160 h, depending on the luminous flux setting*

Tempo di ricarica a 2A: 5 h  
*Charging time at 2A: 5 h*

Pacco batteria al litio ricaricabile e sostituibile  
*Rechargeable and replaceable lithium battery pack*

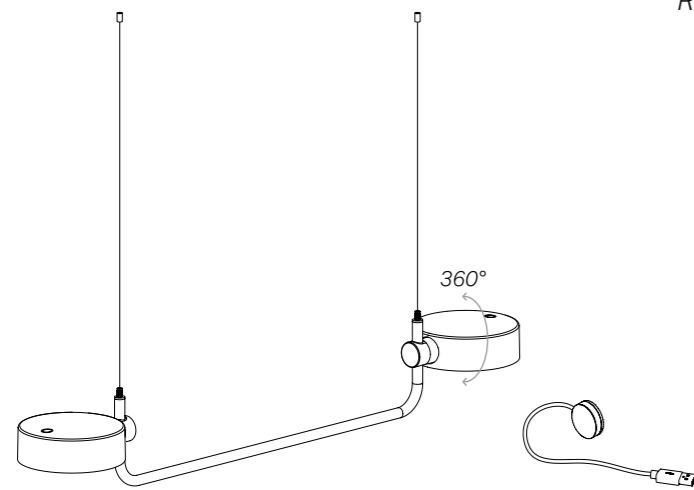

77 x 300 x 12,5 cm

Ø 3 x 1 cm

### Componenti inclusi Components included

Disco per ricarica a contatto  
*Contact charging puck*

### Accessori non inclusi Accessories not included

Caricatore / *Charger* → **LD0300UC**  
5 V max 2,1 A | 100-240V | USB-A (pg. 247)

## Finiture Finishes

IP65



### LD1153B3

Bianco / *White*  
RAL 9003

### LD1153N3

Nero / *Black*  
RAL 9005



Super O suspension lamp  
black → **LD1153N3**

# Super O<sup>PRO</sup>

Lampada da parete  
Wall lamp

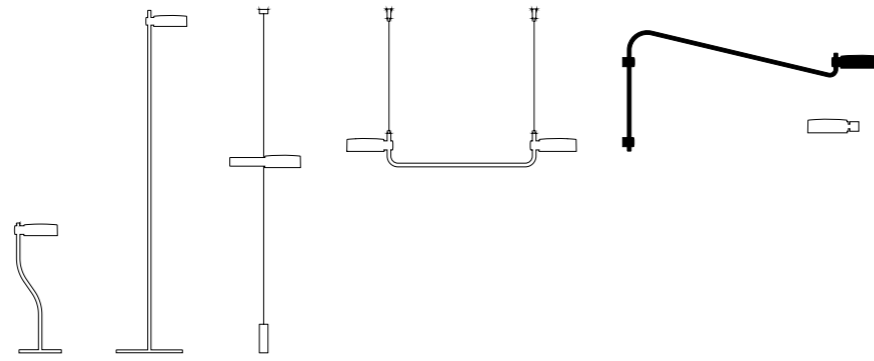

## Dati tecnici

### Technical data

#### LED TOUCH DIMMER

2700-3150-4000 K | CRI>90  
287-331-336 lm | 3.5 W | IP65  
5 V max 2A



Corpo in pressofusione di alluminio verniciato  
*Painted die-cast aluminum body*

Diffusore in policarbonato prismatico  
*Prismatic polycarbonate diffuser*

Adatta all'uso interno  
*Suitable for indoor use*

Durata 11-160 h, in base alla regolazione del flusso luminoso  
*Battery lasts 11-160 h, depending on the luminous flux setting*

Tempo di ricarica a 2A: 5 h  
*Charging time at 2A: 5 h*

Pacco batteria al litio ricaricabile e sostituibile  
*Rechargeable and replaceable lithium battery pack*

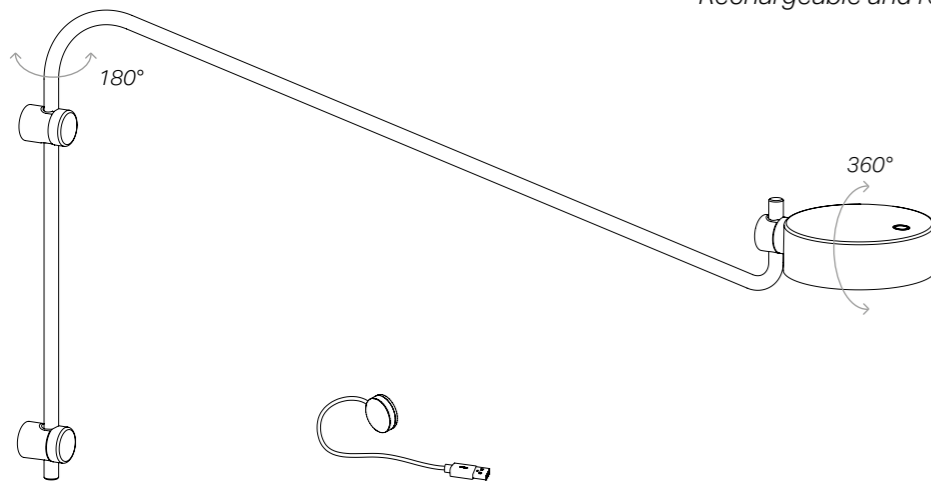

85,3 x 40,5 x 12,5 cm

Ø 3 x 1 cm

#### Componenti inclusi Components included

Disco per ricarica a contatto  
*Contact charging puck*

#### Accessori non inclusi Accessories not included

Caricatore / *Charger* → **LD0300UC**  
5 V max 2,1 A | 100-240V | USB-A (pg. 247)

## Finiture Finishes

IP65



#### LD1151B3

Bianco / *White*  
RAL 9003

#### LD1151N3

Nero / *Black*  
RAL 9005



Super O wall lamp  
black → **LD1151N3**

# Super O<sup>PRO</sup>

Lampada da parete  
Wall lamp

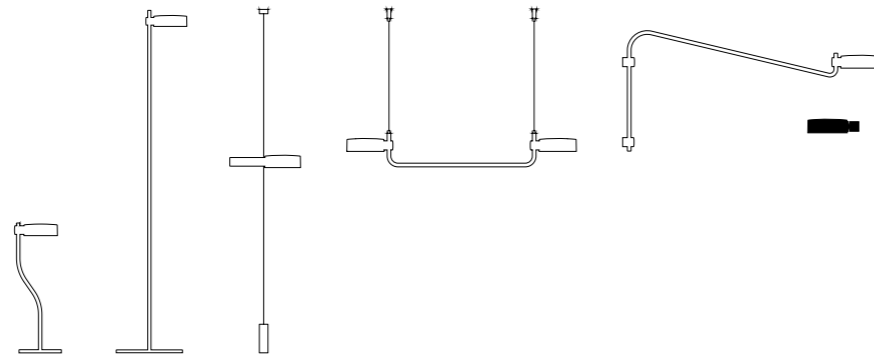

## Dati tecnici

### Technical data

#### LED TOUCH DIMMER

2700-3150-4000 K | CRI>90  
287-331-336 lm | 3.5 W | IP65  
5 V max 2A



Corpo in pressofusione di alluminio verniciato  
*Painted die-cast aluminum body*

Diffusore in policarbonato prismatico  
*Prismatic polycarbonate diffuser*

Adatta all'uso interno  
*Suitable for indoor use*

Durata 11-160 h, in base alla regolazione del flusso luminoso  
*Battery lasts 11-160 h, depending on the luminous flux setting*

Tempo di ricarica a 2A: 5 h  
*Charging time at 2A: 5 h*

Pacco batteria al litio ricaricabile e sostituibile  
*Rechargeable and replaceable lithium battery pack*

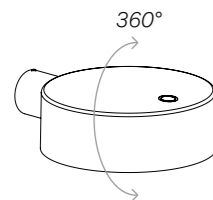

16,2 x 4,3 x 12,5 cm

Ø 3 x 1 cm

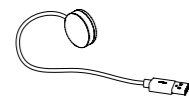

## Componenti inclusi

*Components included*

Disco per ricarica a contatto  
*Contact charging puck*

## Accessori non inclusi

*Accessories not included*

Caricatore / *Charger* → **LD0300UC**  
5 V max 2,1 A | 100-240V | USB-A (pg. 247)

## Finiture

*Finishes*

IP65



**LD1150B3**  
Bianco / *White*  
RAL 9003



**LD1150N3**  
Nero / *Black*  
RAL 9005



# Swap <sup>PRO</sup>

Design Studio Kairos and Federico de Majo

Swap è una collezione di lampade da tavolo a batteria, portatili e ricaricabili, disponibili in due modelli.

Nella parte superiore della testa è presente un controllo "touch", che permette l'accensione, la dimmerazione a 4 step e la selezione della temperatura di colore della luce. Grazie all'alto indice di protezione, le lampade sono utilizzabili anche all'esterno. Un sistema di controllo elettronico monitora e segnala l'autonomia residua della batteria, permettendo di ottimizzare le ricariche. Le lampade sono dotate di base di ricarica a contatto.

Le lampade della collezione Swap sono personalizzabili con cover e paralumi in vari materiali, acquistabili separatamente (pag. 234-237).

*Swap is a collection of cordless, rechargeable battery table lamps. The collection includes a table lamp in two heights. A touch control placed on the lamp head allows switching on/off, 4-step dimming (100%, 60%, 30%, 6%) and selecting the color temperature (K).*

*Suitable for both indoor and outdoor use, the lamps feature an electronic control system that monitors and indicates the remaining battery life, allowing for optimized charging. All models are equipped with a contact charging base.*

*Swap lamps can be customised with covers and lampshades in various materials, to be purchased separately (pg. 234-237)*



LINK TO VIDEO



Swap table lamp white  
→ LD3130B3

# Swap<sup>PRO</sup>

Lampada da tavolo  
Table lamp

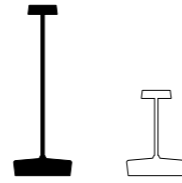

## Dati tecnici

### Technical data

#### LED TOUCH DIMMER

2200-2700-3000K | CRI>90  
175-198-205lm | 2.0W | IP65  
| 5Vdc max.2A



Corpo in pressofusione di alluminio verniciato  
*Painted die-cast aluminum body*

Diffusore in policarbonato satinato  
*Satin polycarbonate diffuser*

Testa predisposta al fissaggio magnetico delle cover  
*Heads prepared for magnetic cover attachment*

Adatta all'uso esterno (lampada IP65) e interno  
(lampada su base di ricarica IP20)  
*Suitable for outdoor (lamp IP65) and indoor use (lamp  
on charging base IP20)*

Resistenza alla nebbia salina (1500h)  
*Salt spray resistance (1500h)*

Durata di circa 16/17 h alla massima potenza  
*Battery lasts about 16/17 h at full power*

Tempo di ricarica a 2A: 3/4 h  
*Charging time at 2A: 3/4 h*

Pacco batteria al litio ricaricabile e sostituibile  
*Rechargeable and replaceable lithium battery pack*

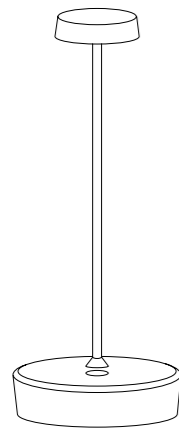

Ø 10 x 29 cm

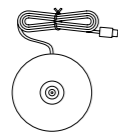

Ø 7,5 cm

### Componenti inclusi Components included

Base di ricarica a contatto (USB-C)  
*Contact charging base (USB-C)*

### Accessori non inclusi Accessories not included

Caricatore a spina / USB charger → **LD1490UA**  
5V max 2A | 200-240V | USB-C (pg. 247)

## Finiture Finishes

IP65



**LD3130B3**  
Bianco / White  
RAL 9003



**LD3130R3**  
Corten / Corten



**LD3130D3**  
Nero / Black  
RAL 9004



**LD3130W3**  
Bronzo / Bronze  
MBR



**LD3130O3**  
Oro opaco / Matt gold  
MGO

# Swap mini<sup>PRO</sup>

Lampada da tavolo  
Table lamp

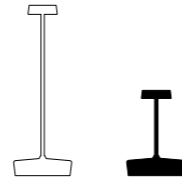

## Dati tecnici

### Technical data

#### LED TOUCH DIMMER

2200-2700-3000K | CRI>90  
175-198-205lm | 2.0W | IP65  
| 5Vdc max.2A



Corpo in pressofusione di alluminio verniciato  
*Painted die-cast aluminum body*

Diffusore in policarbonato satinato  
*Satin polycarbonate diffuser*

Testa predisposta al fissaggio magnetico delle cover  
*Heads prepared for magnetic cover attachment*

Adatta all'uso esterno (lampada IP65) e interno (lampada su base di ricarica IP20)  
*Suitable for outdoor (lamp IP65) and indoor use (lamp on charging base IP20)*

Resistenza alla nebbia salina (1500h)  
*Salt spray resistance (1500h)*

Durata di circa 16/17 h alla massima potenza  
*Battery lasts about 16/17 h at full power*

Tempo di ricarica a 2A: 3/4 h  
*Charging time at 2A: 3/4 h*

Pacco batteria al litio ricaricabile e sostituibile  
*Rechargeable and replaceable lithium battery pack*

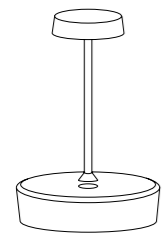

Ø 10 x 14,8 cm

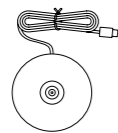

Ø 7,5 cm

### Componenti inclusi Components included

Base di ricarica a contatto (USB-C)  
*Contact charging base (USB-C)*

### Accessori non inclusi Accessories not included

Caricatore a spina / USB charger → **LD1490UA**  
5V max 2A | 200-240V | USB-C (pg. 247)

## Finiture Finishes

IP65



#### LD3131B3

Bianco / White  
RAL 9003



#### LD3131R3

Corten / Corten



#### LD3131D3

Nero / Black  
RAL 9004



#### LD3131W3

Bronzo / Bronze  
MBR



#### LD3131O3

Oro opaco / Matt gold  
MGO

# Swap<sup>PRO</sup>

Paralume in metallo  
Metallic lampshade



Compatibile con i modelli di Swap Pro: tavolo, mini tavolo.  
Compatible with Swap Pro: table, mini table.



**LD2145B3**  
Bianco / White



**LD2145R3**  
Corten



**LD2145N3**  
Nero / Black



**LD2145W3**  
Bronzo opaco /  
Matte bronze



**LD2145O3**  
Oro opaco / Matte  
gold

Compatibile con i modelli di Swap Pro: tavolo, mini tavolo.  
Compatible with Swap Pro: table, mini table.



**LD2141B3**  
Bianco / White



**LD2141R3**  
Corten



**LD2141N3**  
Nero / Black



**LD2141W3**  
Bronzo opaco /  
Matte bronze



**LD2141O3**  
Oro opaco / Matte  
gold



**LD2140B3**  
Bianco / White



**LD2140R3**  
Corten



**LD2140N3**  
Nero / Black



**LD2140W3**  
Bronzo opaco /  
Matte bronze



**LD2140O3**  
Oro opaco / Matte  
gold



Swap table lamp + metallic lampshade  
→ LD3130R3 + LD2140R3  
Photo Digital Snack

# Swap<sup>PRO</sup>

Paralume in tessuto plissettato  
*Pleated fabric lampshade*

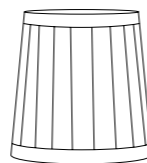

Ø 11,3 x 11,7 cm

Compatibile con il modello di Swap Pro: tavolo, mini tavolo.

*Compatible with Swap Pro table, mini table.*



**LD2146B3**  
Bianco / *White*

**LD2146R3**  
Corten

**LD2146N3**  
Nero / *Black*

**LD2146W3**  
Bronzo opaco /  
*Matte bronze*

**LD2146O3**  
Oro opaco / *Matte gold*

Componenti inclusi  
*Components included*

Blocco di fissaggio in tinta con la finitura della lampada.  
*Fixing block to match the finish of the lamp.*



# Swap<sup>PRO</sup>

Cover in giacinto d'acqua  
*Water hyacinth woven cover*

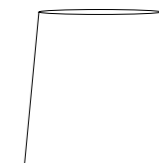

Ø 11,8 x 11,7 cm

Compatibile con il modello di Swap Pro: tavolo, mini tavolo.

*Compatible with Swap Pro table, mini table.*



**LD2147B3**  
Bianco / *White*

**LD2147R3**  
Corten

**LD2147N3**  
Nero / *Black*

**LD2147W3**  
Bronzo opaco /  
*Matte bronze*

**LD2147O3**  
Oro opaco / *Matte gold*

Componenti inclusi  
*Components included*

Blocco di fissaggio in tinta con la finitura della lampada.  
*Fixing block to match the finish of the lamp.*



# Liolà

Design Studio Kairos

Collezione di piani d'appoggio multiuso con gambe in legno massello, disponibili in tre modelli: basso, alto oppure XXL. Estremamente versatili, possono essere usati come tavolini, porta piante, svuota tasche... ma anche per appendere indumenti. Realizzati in collaborazione con artigiani e laboratori selezionati, i Liolà sono progettati per un uso professionale nel settore ristorazione, ma sono adatti anche all'uso domestico. La ricerca sulle forme e sui materiali e la cura del dettaglio caratterizzano anche questo prodotto Zafferano, che anticipa un orientamento della gamma verso una concezione più "lifestyle".

*Collection of multipurpose three-legged, standing tops available in three versions: low, tall or XXL. Extremely versatile, they can be used as side tables, plant holders, dresser valet... but also as clothes hanger.*

*Made in collaboration with selected artisans and workshops, they are designed for professional use in restaurants, but are also suitable for home use. The research of shapes and materials and the attention to details characterize these Zafferano products, which anticipate the orientation of the range towards a more "lifestyle" concept.*



LINK TO VIDEO



Liolà multipurpose three-legged high  
white - natural wood → **ZLS0101**  
Super O table lamp white → **LD1152B3**



Liola multipurpose three-legged XXL  
white - natural wood → **ZLS0201**

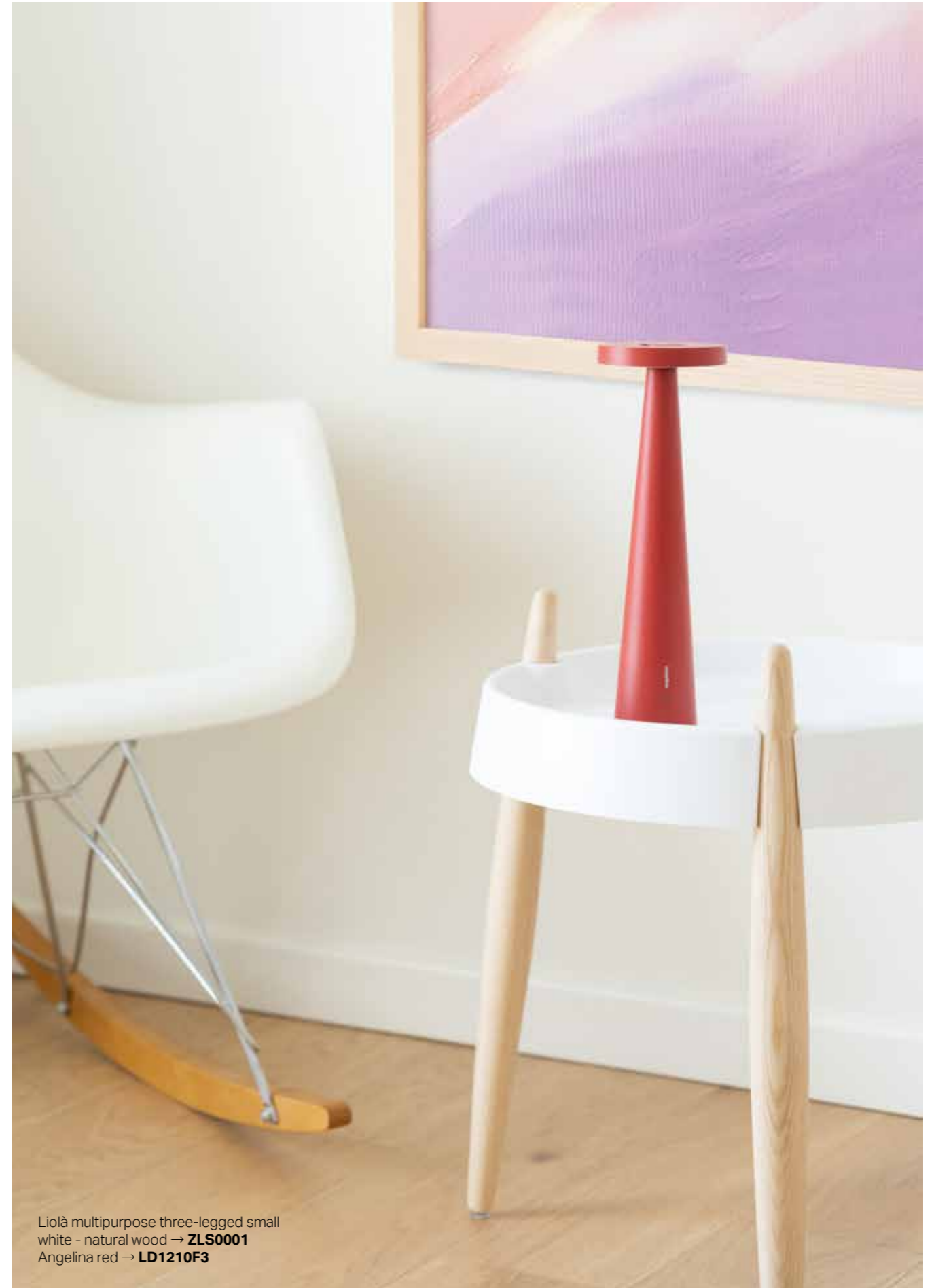

Liola multipurpose three-legged small  
white - natural wood → **ZLS0001**  
Angelina red → **LD1210F3**

# Liolà

Piano d'appoggio multiuso  
*Multipurpose three-legged*

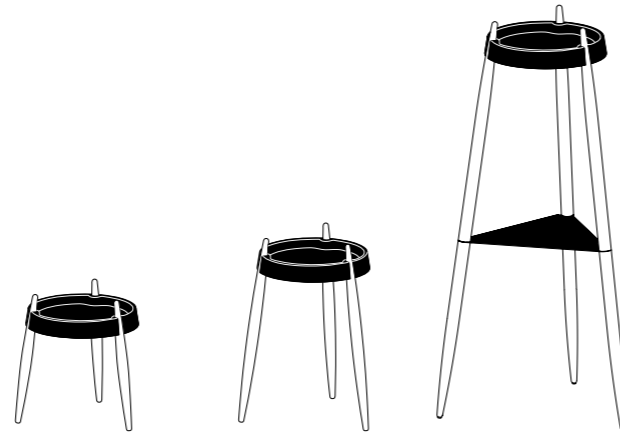

## Dati tecnici Technical data

Piano in termoplastico  
*Thermoplastic top*

Gambe in legno di frassino  
*Wood legs*

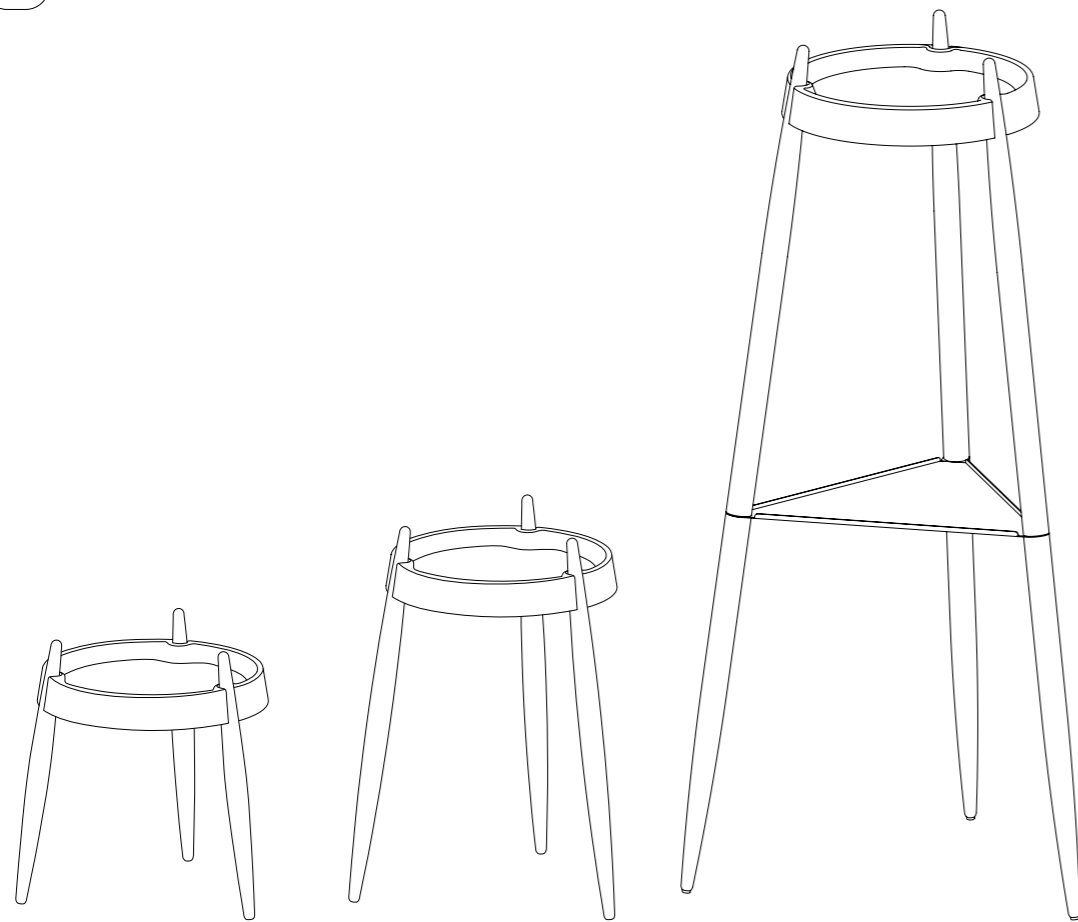

Ø 49 x 47 cm

Ø 54,7 x 67 cm

Ø 73,8 x 135 cm

## Finiture Finishes



**ZLS0001**  
 Bianco - Frassino naturale  
*White - Natural wood*



**ZLS0002**  
 Bianco - Frassino nero  
*White - Black wood*



**ZLS0004**  
 Nero - Frassino naturale  
*Black - Natural wood*



**ZLS0005**  
 Nero - Frassino nero  
*Black - Black wood*



**ZLS0101**  
 Bianco - Frassino naturale  
*White - Natural wood*



**ZLS0102**  
 Bianco - Frassino nero  
*White - Black wood*



**ZLS0104**  
 Nero - Frassino naturale  
*Black - Natural wood*



**ZLS0105**  
 Nero - Frassino nero  
*Black - Black wood*



**ZLS0201**  
 Bianco - Frassino naturale  
*White - Natural wood*



**ZLS0202**  
 Bianco - Frassino nero  
*White - Black wood*



**ZLS0204**  
 Nero - Frassino naturale  
*Black - Natural wood*



**ZLS0205**  
 Nero - Frassino nero  
*Black - Black wood*

# Basi di ricarica e caricatori

## Contact charging base and charger



Amelie collection  
Base di ricarica a contatto  
Contact charging base  
**LD1090RB**



Angelina  
Base di ricarica a contatto  
Contact charging base  
**LD1210RB**



Carolina  
Base di ricarica a contatto  
Contact charging base  
**LD1460RB**



Circe  
Base di ricarica a contatto  
Contact charging base  
**LD1005RB**

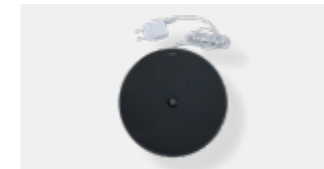

Poldina XXL  
Base di ricarica a contatto  
Contact charging base  
**LD0360RB**

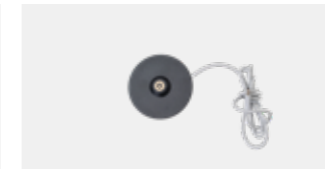

Poldina Classic / Flaminia  
Base di ricarica a contatto  
Contact charging base  
**LD1230RB**



Poldina Reverso  
Base di ricarica a contatto  
Contact charging base  
**LD0420RB**

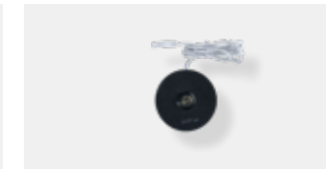

Poldina Stopper  
Base di ricarica a contatto  
Contact charging base  
**LD0349RB**



Damina  
Base di ricarica a contatto  
Contact charging base  
**LD1600RB**

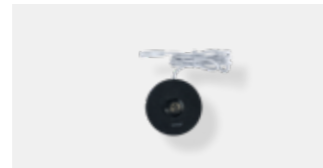

Dondolina  
Base di ricarica a contatto  
Contact charging base  
**LD1110RB**



Ofelia  
Base di ricarica a contatto  
Contact charging base  
**LD2870RB**



Ofelia micro  
Base di ricarica a contatto  
Contact charging base  
**LD1880RB**

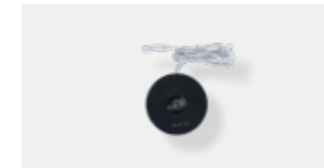

Push-up  
Base di ricarica a contatto  
Contact charging base  
**LD1050RB**

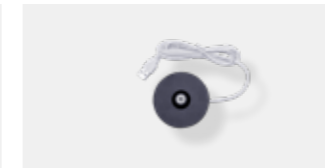

Royal Family  
Base di ricarica a contatto  
Contact charging base  
**LD1160RB**

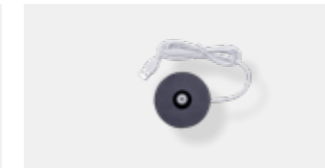

Sister Light collection  
Base di ricarica a contatto  
Contact charging base  
**LD1080RB**



Sister Light Wi-Fi table lamp  
Adattatore per base di ricarica  
Charging base adapter  
**LD1080BS**



Olivia, Olivia mini  
Base di ricarica a contatto  
Contact charging base  
**LD2850RB**

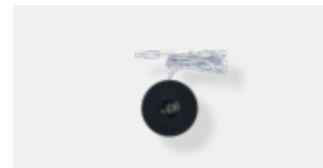

Home  
Base di ricarica a contatto  
Contact charging base  
**LD1258RB**



Olivia micro  
Base di ricarica a contatto  
Contact charging base  
**LD1840RB**



Perpetua  
Base di ricarica a contatto  
Contact charging base  
**LD1170RB**



Soffio  
Base di ricarica a contatto  
Contact charging base  
**LD1120RB**

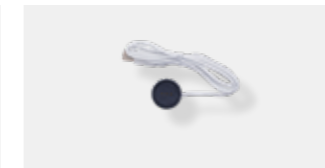

Super O collection  
Disco per ricarica a contatto  
Contact charging puck  
**LD1060RB**

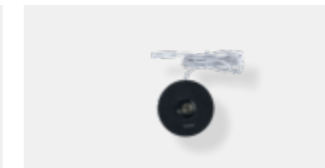

Swap collection  
Base di ricarica a contatto  
Contact charging base  
**LD3130RB**

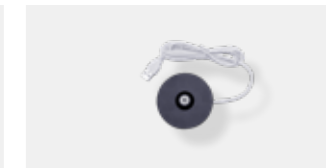

Trilli  
Base di ricarica a contatto  
Contact charging base  
**LD2090RB**

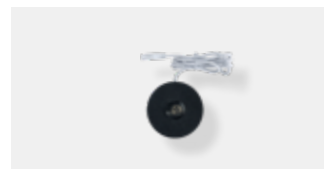

Pina table lamp  
Base di ricarica a contatto  
Contact charging base  
**LD2650RB**



Pina L desk  
Base di ricarica a contatto  
Contact charging base  
**LD2660RB**

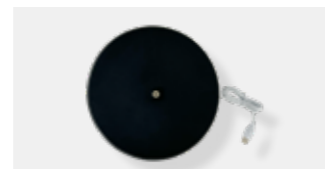

Pina XXL  
Base di ricarica a contatto  
Contact charging base  
**LD2670RB**



Poldina, Poldina mini  
Base di ricarica a contatto  
Contact charging base  
**LD1340RB**



Teepee  
Cavo di ricarica con entrata  
USB-A e uscita USB-C  
Charging cable with USB-A input  
and USB-C output  
**CBL04200010000000**



Poldina reverso L solar RF  
Barbell solar RF  
Cavo di ricarica con entrata  
USB-C e uscita USB-C  
Charging cable with USB-C input  
and USB-C output  
**CBL04300030000000**



Poldina L  
Base di ricarica a contatto  
Contact charging base  
**LD1390RB**



Poldina L desk  
Base di ricarica a contatto  
Contact charging base  
**LD1395RB**

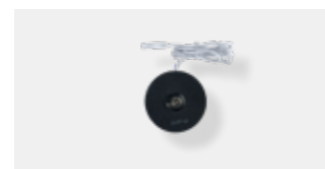

Poldina lamp with peg, Poldina  
suspension lamp, Poldina wall lamp  
Base di ricarica a contatto  
Contact charging base  
**LD0688RB**



Poldina micro  
Base di ricarica a contatto  
Contact charging base  
**LD0490RB**

# Accessori e ricambi

## Accessories and spare parts

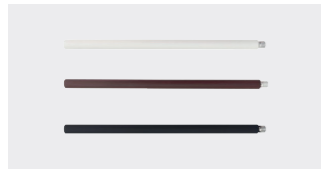

Poldina  
Prolunga stelo aggiuntiva  
*Additional stem extension*

**LD0283B3** Bianco / White  
**LD0283R3** Corten  
**LD0283N3** Grigio scuro / Dark Gray



Poldina Reverso  
Contenitore multiuso  
*Multipurpose container tray*

**LD0420V1**



Poldina Stopper  
Tappo per testa in silicone  
*Silicone head plug*

**LD0349TP**



Poldina Classic / Flaminia  
Modulo luce aggiuntivo  
*Additional lighting module*

**LD123000**



Alimentatore a spina con entrata  
USB-C  
*USB-C port power charger*

INPUT: AC 100-240V | 50-60Hz  
OUTPUT: 5 V - max 2 A

**LD1490UA**

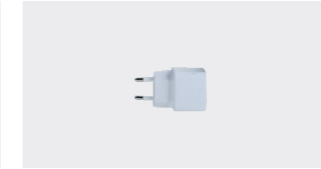

Alimentatore a spina con entrata  
USB-A  
*USB-A port power charger*

INPUT: AC 100-240V | 50-60Hz  
OUTPUT: 5 V - max 1 A

**LD0490UA**



Alimentatore a spina con entrata  
USB-A e cavo di ricarica con entra-  
ta micro USB  
*Charger with USB-A input and  
charging cable with USB-C input*

INPUT: AC 100-240V | 50-60Hz  
OUTPUT: 5 V - max 1 A

**LD0280UA**



Alimentatore a spina con entrata  
USB-C e spina intercambiabile  
*(EU/USA/UK)  
USB-C port power charger and an  
interchangeable plug suitable for*

*EU/USA/UK*  
*(Poldina reverso L solar RF, Barbell  
solar RF)*

INPUT: AC 100-240V | 50-60Hz  
OUTPUT: 5.0V-3.0A//9.0V-  
3.0A//12.0V-3.0A//15.0V-  
3.0A//20.0V-3.25A

**LD1430UC**



Perpetua  
Modulo batteria aggiuntivo  
*Additional battery module*

**LD117002**



Poldina Reverso Solar  
Telecomando a radiofrequenza  
per controllo da remoto  
*Radio-frequency remote control*

**LD1430RF**



Poldina Reverso Solar / Barbell  
Ripiano  
*Shelf*

**LD1431D3** Grigio scuro / Dark Gray  
**LD1431G3** Verde salvia / Sage green  
**LD1431R3** Corten



Tree of light  
Vaschetta contenitore multiuso  
*Multipurpose container tray*

**LD1432D3**



Filo  
Lampadina E27  
*Bulb E27*

**LD0812800**



Tree of light  
Lampadina E27  
*Bulb E27*

**LMP00007114802700**



Super O  
Modulo luce aggiuntivo  
*Additional lighting module*

**LD1060B3** Bianco / White  
**LD1060N3** Nero / Black



Super O  
Supporto parete con snodo  
*Wall bracket with joint*

**LD1061B3** Bianco / White  
**LD1061N3** Nero / Black



Alimentatore a spina con  
doppia entrata USB-A e spina  
intercambiabile  
*(EU/USA/UK)  
Dual USB-A port power charger  
and an interchangeable plug  
suitable for EU/USA/UK*

*(Sister Light, Pina L Desk, Pina XXL,  
Super O, Angelina )*

INPUT: AC 100-240V | 50-60Hz  
OUTPUT: 5 V - max 2,1 A

**LD0300UC**



Alimentatore a spina con  
connettore 3.5/1.3  
*(Pencil modulo luce, Pencil base ricarica)  
Charger with a 3.5/1.3 connector  
(Pencil lighting module, Pencil  
charging base)*

48W  
INPUT: AC 100-240V | 50-60Hz  
OUTPUT: 19 V - max 2,5 A

**LD0800CS**



Super O  
Supporto testa universale  
*Universal head support*

**LD1062B3** Bianco / White  
**LD1062N3** Nero / Black

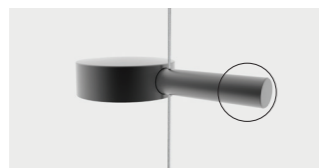

Super O  
Contrappeso per modulo luce  
*Counterweight for additional  
light module*

**LD1063B3** Bianco / White  
**LD1063N3** Nero / Black



Home Solar  
Base zavorrata  
*Stabilizing base*

**LD0255R3** Corten  
**LD0255G3** Grigio scuro / Dark gray

**LD1350RP**Base di ricarica a contatto multipla (max 6 posti) / *Multi-contact charging base (max 6 slots)*

→ Dondolina, Flaminia, Home, Pina, Poldina, Poldina mini, Poldina Classic, Poldina Reverso, Push-up, Royal Family, Soffio, Sister Light, Swap, Swap mini, Trilli

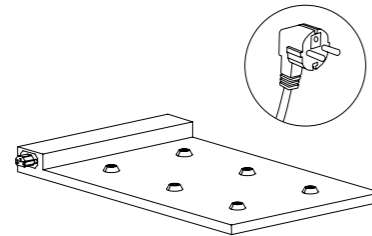

32,7 x 51 x 5,8 cm

35W  
INPUT: AC100-240V 50/60Hz  
OUTPUT: 5V Max. 7A

Base di ricarica a contatto multipla (max 6 posti) e modulare: più basi possono essere collegate in sequenza per caricare contemporaneamente più lampade. Particolarmente adatto all'uso professionale.  
*Modular multi-contact (max 6 slots) charging base: it can be connected in sequence to simultaneously charge multiple sets of lamps. Particularly suitable for professional use.*

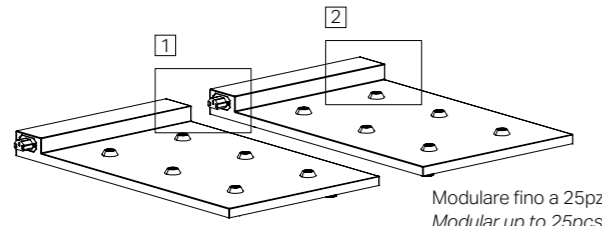
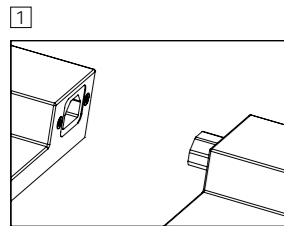
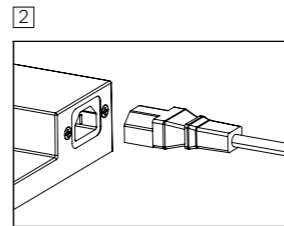
Modulare fino a 25pz  
*Modular up to 25pcs***LD1490RP**Base di ricarica a contatto multipla (max 12 posti) / *Multi-contact charging base (max 12 slots)*

→ Angelina, Carolina, Damina, Poldina micro

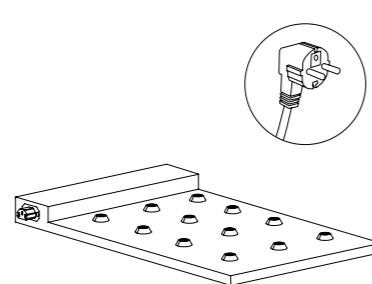

32,7 x 51 x 5,8 cm

70W  
INPUT: AC 100-240V 50/60Hz  
OUTPUT: 5V Max. 14A

Base di ricarica a contatto multipla (max 12 posti) e modulare: più basi possono essere collegate in sequenza per caricare contemporaneamente più lampade. Particolarmente adatto all'uso professionale.  
*Modular multi-contact (max 12 slots) charging base: it can be connected in sequence to simultaneously charge multiple sets of lamps. Particularly suitable for professional use.*

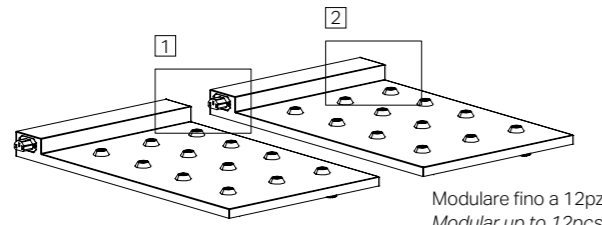
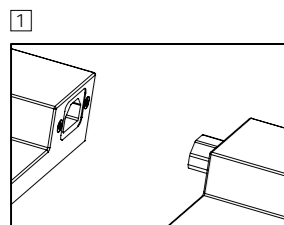
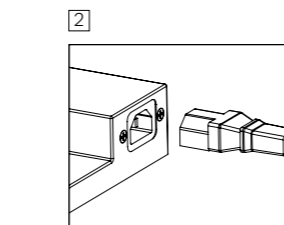
Modulare fino a 12pz  
*Modular up to 12pcs***LD0870RP**Base di ricarica a contatto multipla (max 6 posti) / *Multi-contact charging base (max 6 slots)*

→ Amelie, Circe, Ofelia, Ofelia micro, Olivia, Olivia mini, Olivia micro

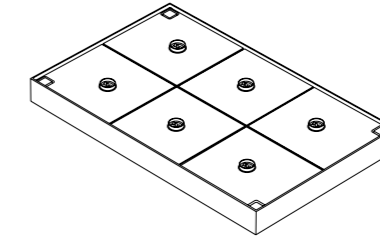

29 x 47 x 4 cm

45W  
INPUT: AC 100-240V | 50-60Hz  
OUTPUT: 9 V max 5A

Base di ricarica a contatto multipla (max 6 posti) e modulare: più basi possono essere impilate (fino a max 3 livelli) per caricare contemporaneamente più lampade. Particolarmente adatto all'uso professionale.  
*Modular multi-contact (max 6 slots) charging base: it can be stacked (up to max 3 levels) to simultaneously charge multiple sets of lamps. Particularly suitable for professional use.*

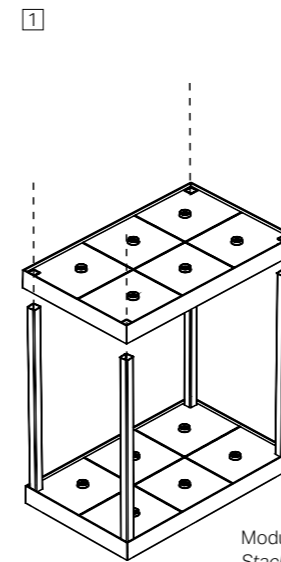
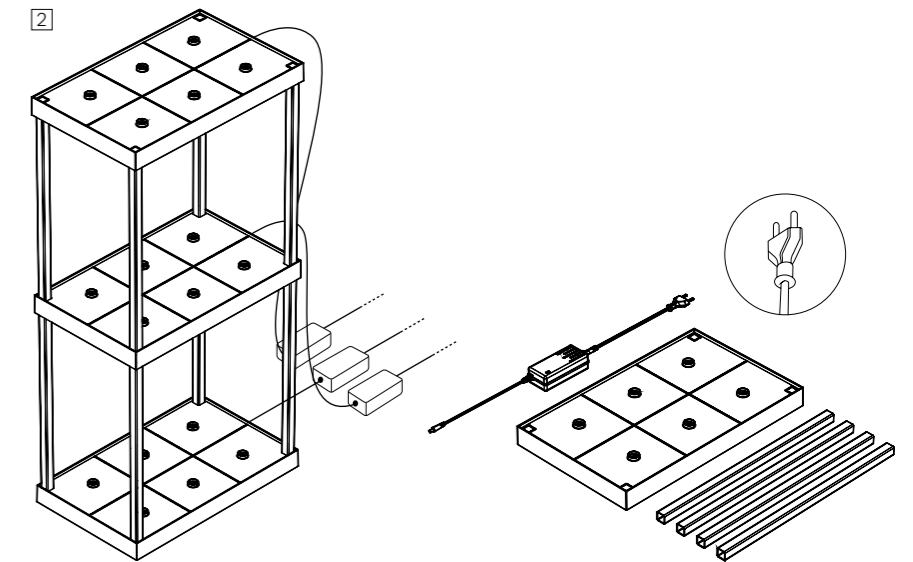
Modulare fino a 3 livelli.  
*Stackable up to 3 levels.***LD1170RP**Base di ricarica a contatto multipla (max 8 posti) / *Multi-contact charging base (max 8 slots)*

→ Perpetua

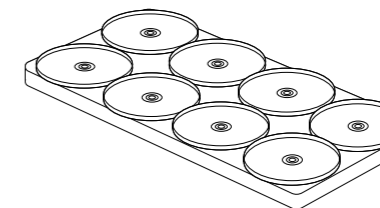

11 x 22 x 1,3 cm

45W  
INPUT: AC 100-240V | 50-60Hz  
OUTPUT: 5Vdc max 8A

**LD0340TR**

Trolley per basi di ricarica multiple (max 6 pezzi)  
Trolley for multiple charging bases (up to 6 pcs)

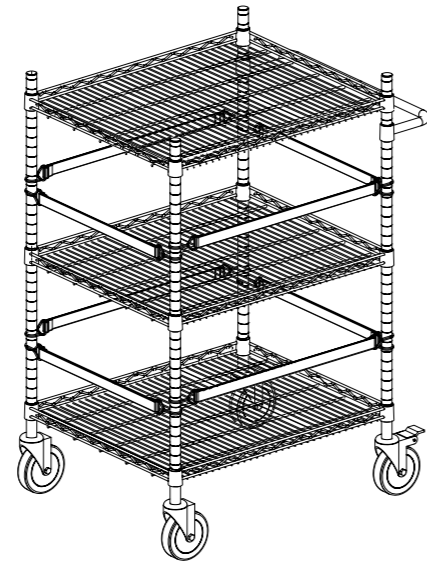

61,5 x 86,7 x h 110 cm

4 ruote piroettanti (2 con freni)  
4 swiveling wheels (two braked)

Massimo 3 livelli, massimo 2 basi di ricarica multiple per livello  
3 tiers max, max 2 multicharging base per tier

Adatto all'uso esterno  
Suitable for outdoor use

**Avvertenze**  
**Remarks**

Basi di ricarica a contatto **non incluse**  
Multi charging bases **not included**

**LD0340RA-12**

Caricatore multiplo 12 prese USB type-A  
12 x USB type-A ports multi charger

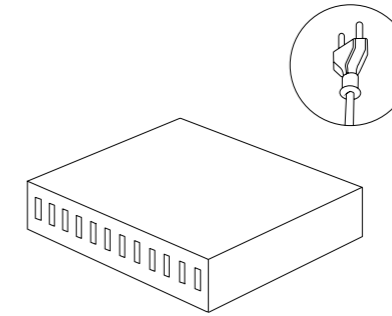

12,7 x 15,2 x 3,3 cm

150W  
INPUT: AC 100-240V | 50-60Hz  
OUTPUT: 5 V - max 2,4A (12 pcs.)

Caricatore multipresa USB (12 x USB-A).  
Permette la carica di max 12 dispositivi  
contemporaneamente. Particolarmente  
adatto all'uso professionale.  
USB multi-socket charger (12 x USB-A). Can  
charge of up to 12 devices simultaneously.  
Particularly suitable for professional use.

**LD1350RA**

Caricatore multiplo 8 prese USB type-C + 2 prese USB type-A  
8 x USB type-C + 2 x USB type-A ports multi charger

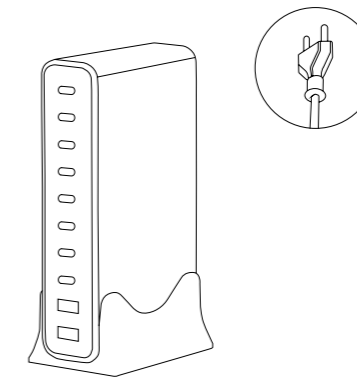

5 x 7,5 x 13,5 cm

800W  
INPUT: AC 100-240V | 50-60Hz  
OUTPUT: 5 - 9 - 12 - 15 - 20 - 28V

Caricatore multipresa USB (8 x USB-C  
+ 2 x USB-A). Permette la carica di max  
10 dispositivi contemporaneamente.  
Particolarmente adatto all'uso professionale.  
USB multi-socket charger (8 x USB-C + 2  
x USB-A). Can charge of up to 10 devices  
simultaneously. Particularly suitable for  
professional use.

# Batterie ricaricabili

## Rechargeable batteries

Le batterie ricaricabili sono soggette a un naturale processo di usura. La loro durata media è di circa 450 cicli di ricarica completa, ma può ridursi in caso di uso non appropriato, come ad esempio: ① l'utilizzo di un alimentatore a spina non idoneo; ② l'inattività prolungata della lampada; ③ la permanenza prolungata sulla base di ricarica sotto tensione; ④ l'esposizione a temperature estreme, sia molto alte che molto basse;

Le lampade ricaricabili Zafferano sono dotate di batterie al litio ricaricabili e sostituibili, appartenenti alle tipologie Li-ion (ioni di litio) o Li-Po (polimeri di litio), selezionate in base alle caratteristiche tecniche di ciascun modello.

Quando la lampada non si ricarica più oppure la sua autonomia risulta notevolmente ridotta, è necessario procedere con la sostituzione della batteria. I ricambi originali Zafferano sono disponibili a catalogo e identificati da un apposito codice.

La garanzia sulle batterie copre esclusivamente eventuali difetti di fabbricazione, che - se presenti - si manifestano già nei primi cicli di utilizzo.

*Rechargeable batteries are subject to natural wear. Their average lifespan is around 450 full charge cycles, but this may be reduced in case of improper use, such as: ① using an unsuitable USB charger; ② prolonged inactivity of the lamp; ③ keeping the lamp on the charging base under power for extended periods; ④ exposing the lamp to extreme temperatures, whether very high or very low; Zafferano rechargeable lamps are equipped with rechargeable and replaceable lithium batteries, either Li-ion (lithium-ion) or Li-Po (lithium-polymer), selected based on the technical specifications of each model.*

*When the lamp no longer charges, or its battery life is significantly reduced, it is necessary to replace the battery. Original Zafferano replacement parts are available in the catalog and identified by a specific code.*

*The battery warranty covers manufacturing defects only, which—if present—become evident within the first few charging cycles.*



**Video tutorial:**  
sostituzione batterie  
**Tutorial video:**  
battery replacement

**BAT04703203201200** 3,7V | 1300mA/H

Pacco batteria sostitutiva singola (necessari 2 pz. per **Carolina**)  
Single replacement battery pack (2 pcs. needed for **Carolina**)



**BAT04704004001000** 3,7V | 1900mA/H

Pacco batteria sostitutiva singola (necessario 1 pz. per **Poldina micro**)  
Single replacement battery pack (1 pc. needed for **Poldina micro**)



**BAT04701906701900** 3,7V | 2200mA/H

Pacco batteria sostitutiva singola (necessario 1pz. per **Home Solar**; necessari 2 pz. per **Angelina, Pina, Push-up, Home**; necessari 3 pz. per **Poldina L desk, Poldina L**)

Single replacement battery pack (1pc. needed for **Home Solar**; 2 pcs. needed for **Angelina, Pina, Push-up, Home**; 3 pcs. needed for **Poldina L desk, Poldina L**)



**BAT04701906701902** 3,7V | 2600mA/H

Pacco batteria sostitutiva singola (necessari 2 pz. per **Swap, Swap mini, Soffio**)

Single replacement battery pack (2 pcs. needed for **Swap, Swap mini, Soffio**)



**BAT04701906701903** 3,7V | 2600mA/H

Pacco batteria sostitutiva singola (necessari 2 pz. per **Damina**)  
Single replacement battery pack (2 pcs. needed for **Damina**)



**BAT04709003005000** 3,7V | 3000mA/H

Pacco batteria sostitutiva doppia (necessari 1 pz. per **Olivia micro, Ofelia micro**)

Double replacement battery pack (1 pc. needed for **Olivia micro, Ofelia micro**)



**BAT04703706701900** 3,7V | 4400mA/H

Pacco batteria sostitutiva doppia (necessario 1 pz. per **Poldina tavolo, Poldina mini tavolo, Poldina picchetto, Poldina sospensione, Poldina parete, Poldina Reverso, Poldina Stopper, Circe, Amelie, Olivia, Olivia mini, Ofelia**; necessari 3 pz. per **Pina L desk, Pina XXL**)

Double replacement battery pack (1 pc. needed for **Poldina table lamp, Poldina mini table lamp, Poldina lamp with peg, Poldina suspension lamp, Poldina wall lamp, Poldina Reverso, Poldina Stopper, Circe, Amelie, Olivia, Olivia mini, Ofelia**; 3 pcs. needed for **Pina L desk, Pina XXL**)



**BAT04703706701904** 3,7V | 4400mA/H

Pacco batteria sostitutiva doppia (necessari 2 pz. per **Teepee**)  
Double replacement battery pack (2 pcs. needed for **Teepee**)



**BAT04703706701901** 3,7V | 5000mA/H

Pacco batteria sostitutiva doppia (necessari 2 pz. per **Super O**)  
Double replacement battery pack (2 pcs. needed for **Super O**)



**BAT04703706701902** 3,7V | 4400mA/H

Pacco batteria sostitutiva doppia (necessari 3 pz. per **Poldina XXL terra-tavolo**)

Double replacement battery pack (3 pcs. needed for **Poldina XXL floor-table lamp**)

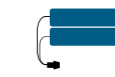

**BAT04703706701907** 3,7V | 5200mA/H

Pacco batteria sostitutiva doppia (necessario 1 pz. per **Perpetua**)  
Double replacement battery pack (1 pc. needed for **Perpetua**)



**BAT04703706701903** 3,7V | 5200mA/H

Pacco batteria sostitutiva doppia (necessario 1 pz. per **Dondolina**)  
Double replacement battery pack (1 pc. needed for **Dondolina**)



**BAT04703706701906** 3,7V | 5200mA/H

Pacco batteria sostitutiva doppia (necessari 1 pz. per **Flaminia, Poldina Classic**)

Double replacement battery pack (1 pc. needed for **Flaminia, Poldina Classic**)



**BAT04703706701905** 18V | 2600mA/H

Pacco batteria sostitutiva doppia (necessario 1 pz. per **Poldina Reverso Solar, Barbell**)

Double replacement battery pack (1 pc. needed for **Poldina Reverso Solar, Barbell**)



**BAT04705506701900** 3,7V | 7500mA/H

Pacco batteria sostitutiva tripla (necessario 1 pz. per **Royal Family, Sister Light, Trilli**)

Triple replacement battery pack (1 pc. needed for **Royal Family, Sister Light, Trilli**)



**BAT04702719700300** 11,1V | 5000mA/H

Pacco batteria sostitutiva per **modulo Pencil piccolo**  
Replacement battery pack for **small Pencil module**



**BAT04702739200600** 11,1V | 10000mA/H

Pacco batteria sostitutiva per **modulo Pencil medio**  
Replacement battery pack for **medium Pencil module**



**BAT04702758700900** 11,1V | 15000mA/H

Pacco batteria sostitutiva per **modulo Pencil grande**  
Replacement battery pack for **large Pencil module**



# Personalizzazione *Customization*

Le lampade portatili Zafferano sono personalizzabili, per adattarle alle esigenze di specifici brand o progetti. A seconda del modello, è possibile applicare loghi, texture o immagini sulla base o sulla testa della lampada; è possibile inoltre stampare interamente le cover in metallo per Poldina, utilizzando una tecnologia che assicura un'elevata qualità e definizione del decoro.

*Zafferano cordless lamps can be customized to meet the needs of specific brands or projects. Depending on the model, logos, textures, or images can be applied to the base or the lamp head. Additionally, metal covers for Poldina can be printed using a technology that ensures high-quality and precisely defined decorations.*

## Punti personalizzabili *Customizable spots*

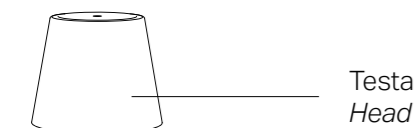

Testa  
*Head*

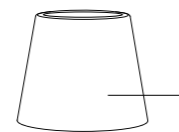

Cover in metallo  
*Metallic cover*

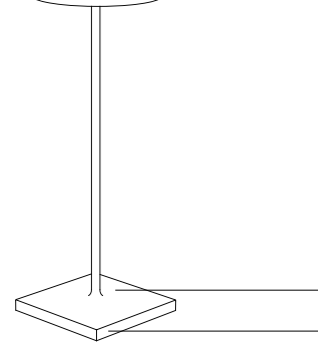

Superficie della base  
*Surface of the base*

Lato della base  
*Side of the base*

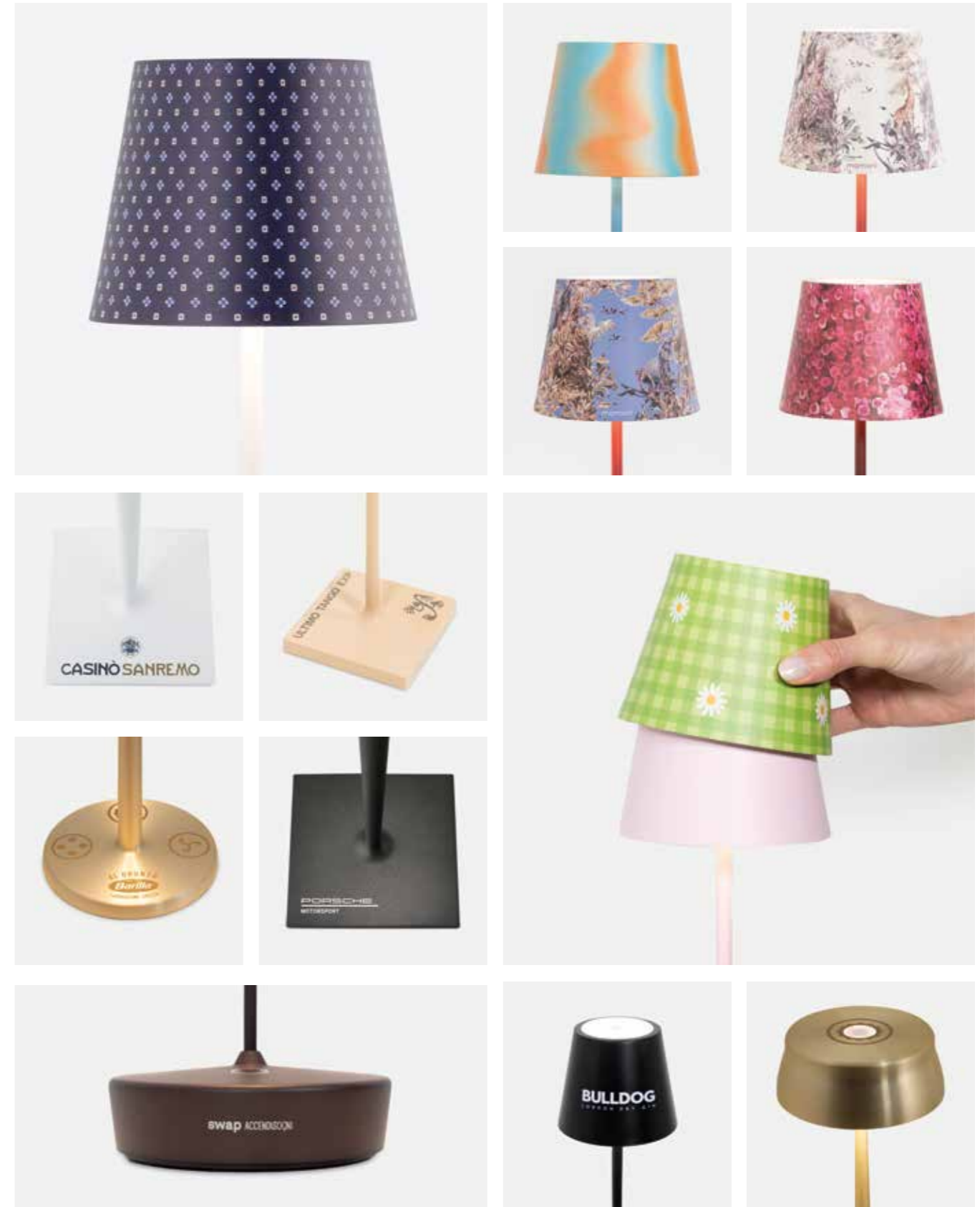



CE  
Dichiara che il prodotto soddisfa gli standard dell'UE per la salute, la sicurezza e la protezione ambientale.  
*Declares that the product meets EU standards for health, safety, and environmental protection.*



CLASS II  
Apparecchio dotato di doppio isolamento e/o isolamento rinforzato in ogni parte e senza dispositivo di messa a terra.  
*Light fitting equipped with double isolation and/or isolation reinforced in every part and without earthing device.*



CLASS III  
Apparecchio basato su un'alimentazione a bassissima tensione di sicurezza, in cui non si producono tensioni superiori alla stessa.  
*Light fitting based on a very low safety voltage power supply, in which no tensions higher than the same are produced.*



IP PROTECTION DEGREE  
IP20: apparecchio protetto dalla penetrazione di corpi solidi di dimensioni maggiori a 12mm e non protetto dai liquidi.  
IP54: apparecchio protetto da polveri e da spruzzi d'acqua.  
IP65: apparecchio fortemente protetto da polveri e da getti d'acqua.  
*IP20: protected from the penetration of solid objects greater than 12 mm and non protected from liquids.  
IP54: protected from dust and splashing water.  
IP65: highly protected from dust and water jets.*



EAC  
È una attestazione di conformità che conferma con il marchio apposto sui prodotti che questi sono conformi ai Regolamenti Tecnici dell'Unione Doganale euroasiatica (TR-TC).  
*The EAC Declaration is a document confirming that the product has passed all set procedures of assessment its conformity to the Customs Union requirements.*



DIMMABLE  
Indica che è possibile regolare l'intensità luminosa della lampada.  
*Indicates that the light intensity of the lamp can be adjusted.*

Headquarters  
**Zafferano SRL**  
Viale dell'Industria, 26  
31055 Quinto di Treviso (Italy)  
T +39 0422 470344  
info@zafferanoitalia.com  
zafferanoitalia.com

Subsidiaries  
**Zafferano America LLC**  
301 Penhorn Avenue Suite 5  
Secaucus, NJ 07094 (USA)  
T +1 888 744 5277  
info@zafferanoamerica.com  
zafferanoamerica.com

**Zafferano Design Brasil**  
Rua Butanta 500, Cjt 62,  
São Paulo, SP, 05424-000 (Brazil)  
T +55-11-964048444  
info@zaffdesign.com.br  
zaffdesign.com.br

**Zafferano Asia Limited**  
Business License Nr  
/ Unified Serial Code:  
91310000MAE8KY802R  
*Lighting:*  
export2@zafferanoitalia.com  
*Tableware:*  
commerciale@zafferanoitalia.com

Stores  
**Zafferano Store Milano**  
Via Fatebenefratelli, 23  
Milan (Italy)

**Zafferano Store Treviso**  
Viale dell'Industria, 26  
Quinto di Treviso (Italy)

**Zafferano Store New York**  
121 Varick Street  
New York, NY 10013 (USA)

**Zafferano Store São Paulo**  
Shopping Cidade Jardim  
Av. Magalhães de Castro 12000  
São Paulo, SP, 05676-120 (Brazil)

© Copyright Zafferano SRL  
Art direction, Graphic design  
Zafferano Design  
©2025 Peanuts Worldwide LLC  
www.peanuts.com

Photography  
Zaff Design  
Digital Snack  
Quasar  
Alberto Sinigaglia  
InTheMiddleStudio  
Bruger

Location  
Lago Design  
Villa del Conte, Padua, Italy  
Ristorante Porta San Tomaso,  
Treviso, Italy  
Atelièr Home, Treviso Italy

Printing  
Grafiche Antiga  
January 2026

**CATLAP26-01**

L'azienda si riserva di apportare modifiche e/o migliorie di carattere tecnico ed estetico ai propri modelli e prodotti in qualsiasi momento e senza preavviso.  
*The company reserves the right to make modifications and improvements of a technical or aesthetic nature to the products at any time without notice.*

Il prodotto è coperto da garanzia per vizi e difetti, nei termini previsti dall'Art. 9 delle Condizioni Generali di Vendita.  
*The product is covered by warranty for defects and faults, under the terms provided in Art. 9 of the General Conditions of Sale.*



