

LIGHTING  
COLLECTION

**VG**



2014

## LIGHTING COLLECTION

La volontà di VG è quella di partecipare alla creazione di luoghi fortemente caratterizzati, ambienti in cui rifugiarsi per evadere dalla realtà esaltando l'espressione della propria personalità, spazi in cui tornare a respirare e sognare.

Riportare la natura in casa, darle spazio in giardino, costruire una casa colorata e decorata, accostare oggetti luminosi a luci sfolgoranti dal vago sapore orientale, recuperare il contatto con l'autenticità creativa dell'oggetto nato dal pensiero e dalla cultura tipicamente italiana, un'unica commistione di complementi per arredare spazi con un'identità precisa, unica nel suo genere, non moderna, non classica ma in grado di dialogare con ogni stile: questo è l'obiettivo del concept progettuale di VG.

*VG participates in creating very distinct environments, spaces in which you can escape from reality; to seek refuge whilst expressing your personality; spaces in which you can breathe and dream.*

*Bringing nature into your home, giving it space in the garden, building a colourful and decorated house, placing brilliant objects in bright lights with a vaguely Eastern flavour, regaining contact with the authenticity of an object created from a typically Italian concept and culture, a unique mix of furnishings to decorate spaces with a distinct identity, one of a kind, not modern, not classic, yet able to communicate with any style: this is the goal of VG design concept.*

# VG

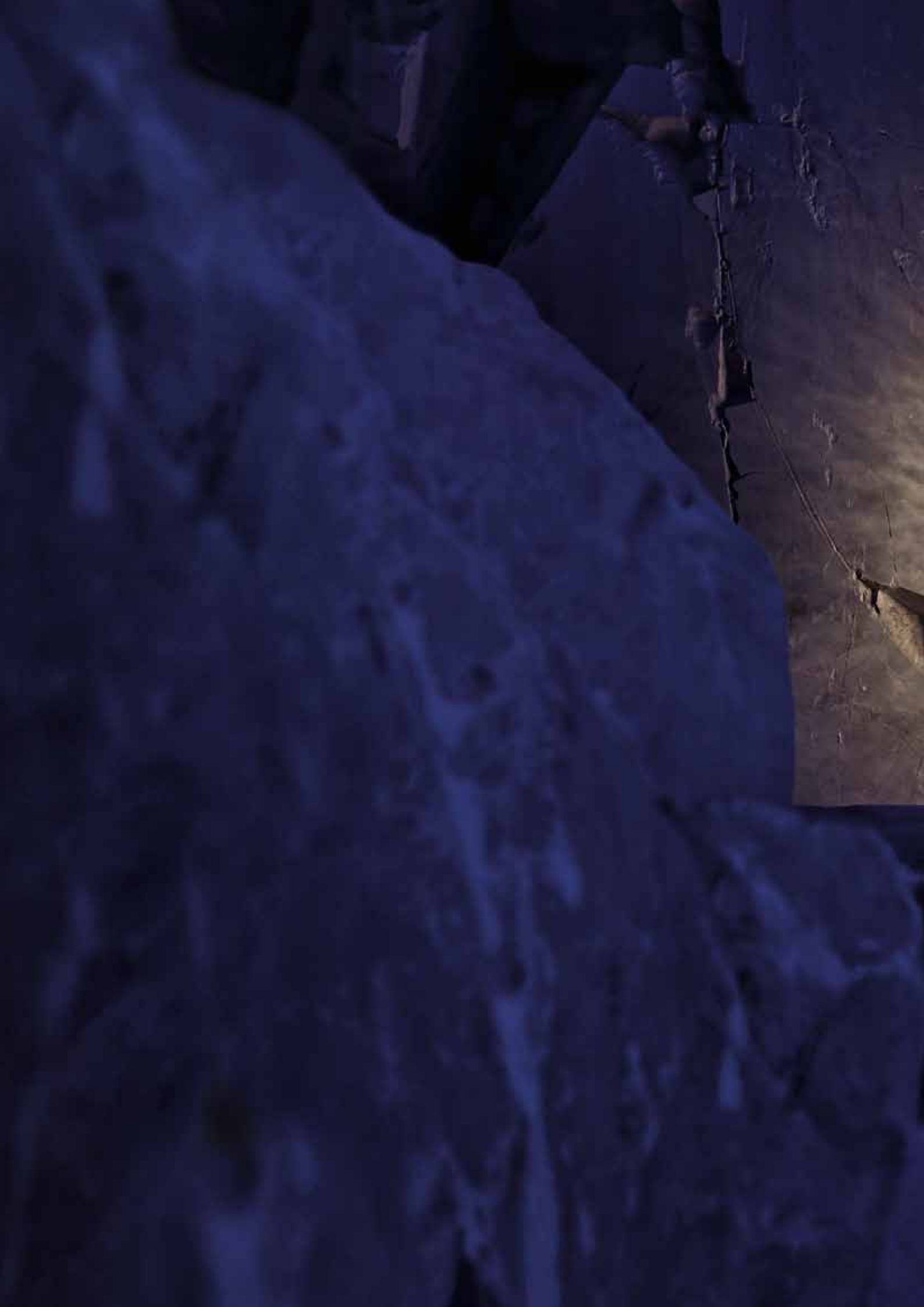

# INDEX

pag.

2 **company profile**

4 **bespoke**

**clusters & chandeliers**

8 octopus

12 tutankhamon

16 lightfall sensation

22 lightfall egg

**floor & table lamps**

32 egg 30 / 50 / 75

36 egg 90 / 120 / 150

38 small flame

40 big flame

42 heartbeat

44 exclamation small

46 exclamation big

48 rectangular separè

50 nuvola

**wall lamps**

56 egg 50 / 90

58 heartbeat

60 ionico egg

62 drop

66 arras

70 domino

**pendant lamps**

72 sensation

76 egg 30 / 50 / 75

78 egg 90 / 120 / 150

80 square

82 rectangular

88 airship

90 rusty

92 trotty

**inside out**

98 obice small

100 obice

102 trotty

104 arena

106 sakata

108 tippy

110 jeta

112 kloë

114 **technical specifications**

## VG COMPANY PROFILE

VG nasce nel 1991 a Treviso, a 20 km da Venezia. Da questa città unica al mondo apprende l'arte delle cose belle, delle proporzioni architettoniche, dell'impiego di materiali diversi e dell'ispirazione a culture lontane rielaborate dalla geniale artigianalità italiana. Tutto ciò è VG: un insieme di oggetti, unici ed autentici, a disposizione di interior designers per realizzare progetti sempre esclusivi, diversi, mai omologati, di un lusso colto e moderatamente ostentativo, espressione di una continua ricerca di design sofisticatamente decorativo.

*VG was founded in 1991 in Treviso, 20 km from Venice. This unique city can teach the art of beautiful things, architectural proportions, the use of different materials and inspiration from distant cultures, reworked by brilliant Italian craftsmanship. VG is all of this: it makes a collection of authentic and unique objects available to interior designers for use in exclusive projects, always different, never conformist, characterised by a cultured and moderately ostentatious luxury, the result of continuous research on stylishly decorative design.*

### HOTELS & RESORTS



### SPA & WELLNESS



### RESTAURANTS



BARS



DISCOS, CLUBS & CASINOS



WEDDINGS & EVENTS



PRIVATE RESIDENCE & VILLAS



## VG BESPOKE

L'incanto non ha limiti: VG è a disposizione di contractor ed interior designer per la progettazione di varianti su misura e composizioni totalmente personalizzate.

*There is no limit to the enchantment: VG is at the service of contractors and interior designers for the design of made-to-measure variants and completely customized compositions.*

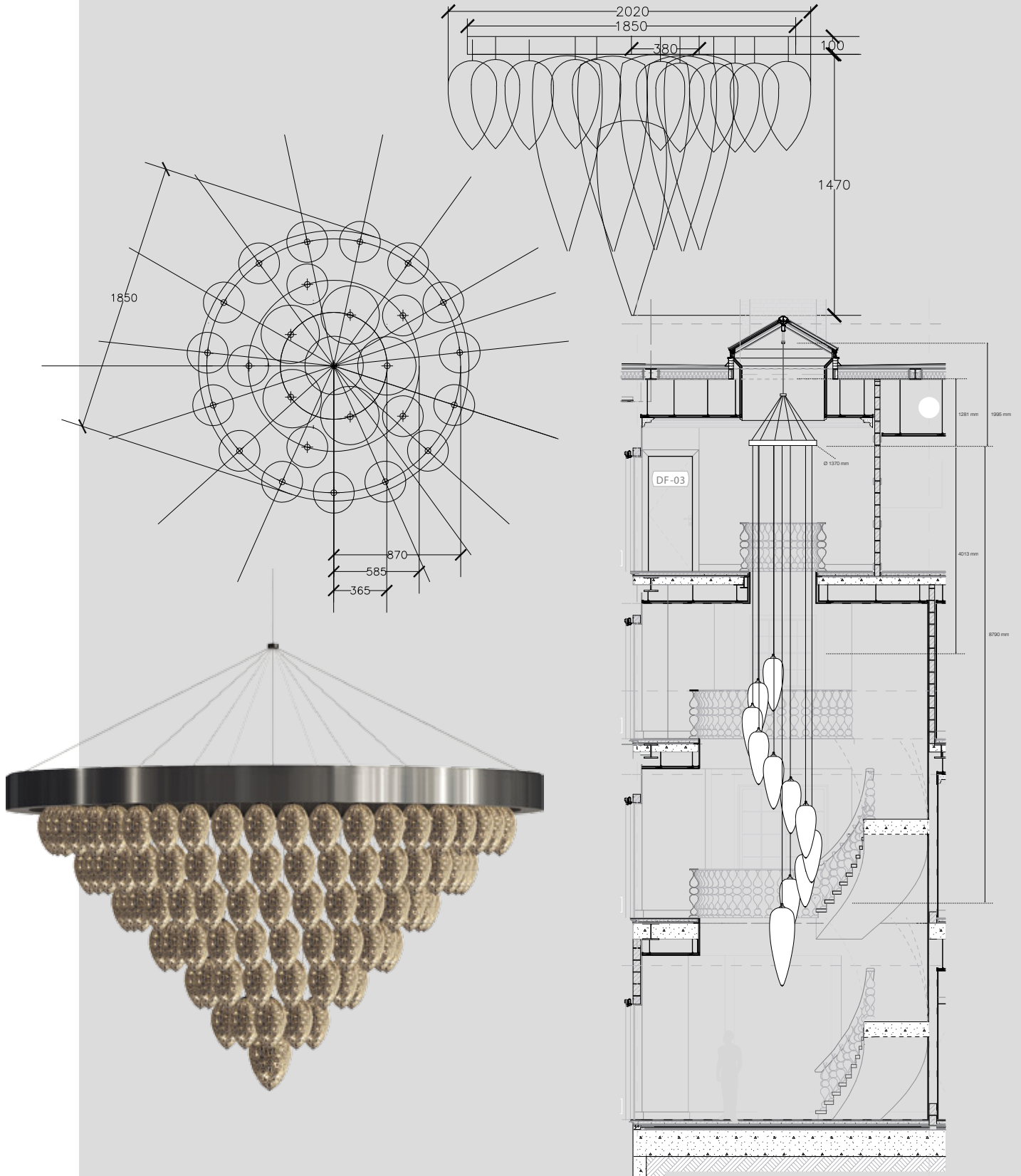

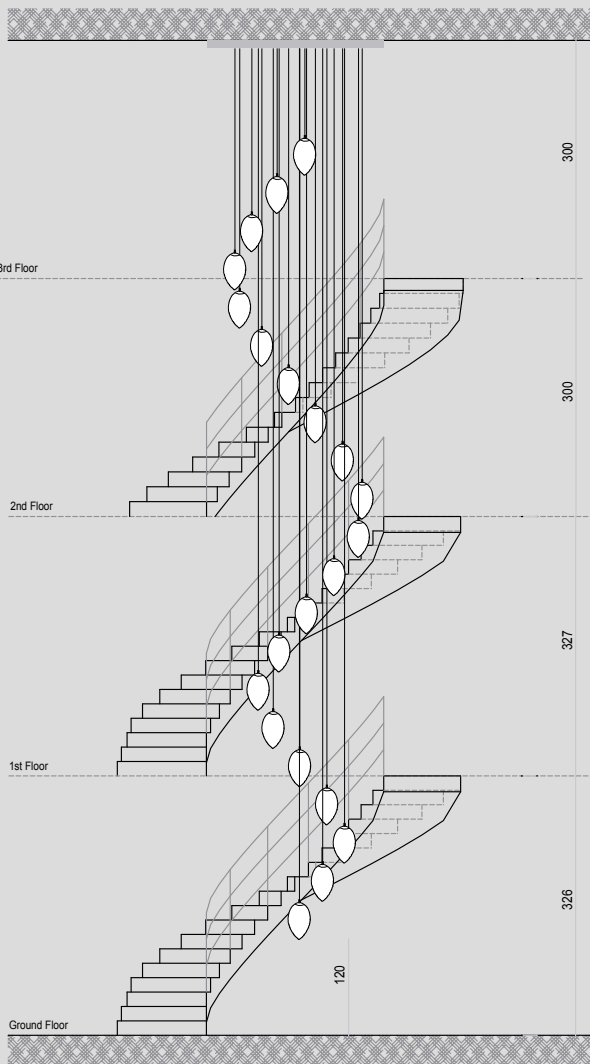

## OCTOPUS

Prezioso ed imponente, Octopus si ispira ai lunghi e sinuosi tentacoli del polpo, che riproduce in versione stilizzata. In perfetta armonia con atmosfere classiche e un po' barocche, con le sue dimensioni importanti si rende protagonista indiscusso di ogni ambientazione. Ogni lampadario della collezione può essere realizzato su misura in base ai desideri e alle necessità del cliente finale.

*Valuable and impressive, Octopus is based on the long and winding tentacles of the octopus, which is reproduced in a stylized version. In perfect harmony with classic environments and a touch of Baroque, its significant dimensions makes it the undisputed protagonist in any environment. Every chandelier of the collection can be customized made according to the wishes and requirements of the end user.*

CHANDELIERS

*full customized*





# OCTOPUS



Materiali - <i>Materials</i>	<i>pirex, acciaio / pyrex, stainless steel</i>
Porta lampada - <i>Bulb holder</i>	E14
Lampadina - <i>Bulb</i>	36 x 50 W max

*lampadine non incluse  
bulbs not included*

### Finitura - *Finish*



*Cromo lucido  
polished chrome*



*\* Oro galvanizzato  
galvanized gold*

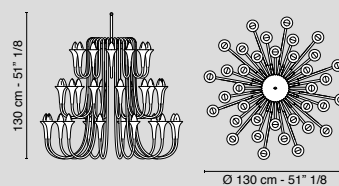

Ø 130 cm - 51" 1/8

IP 20    

*\* su richiesta  
on request*

Codice - *Code*  
**7511554.00**



## ARABESQUE TUTANKHAMON

Il lampadario oversize Tutankhamon trasforma lo spazio in vero lusso, dove arabeschi di luce giocano in un audace intreccio fra classico e contemporaneo, dando vita ad atmosfere ed ambienti inconfondibili. Le dimensioni sono completamente customizzabili, grazie all'esperienza dell'ufficio tecnico dell'azienda che, affiancando il cliente, studia soluzioni ad-hoc per ogni progetto.

*The oversized Tutankhamon chandelier transforms the environment into true luxury, where arabesques of light play in a bold intertwining between classic and contemporary, creating unique atmospheres and environments. The dimensions can be completely customized, thanks to the expertise of the Company's technical department and together with the customer ad-hoc solutions are found for every project.*

CHANDELIERS

*full customized*



ARABESQUE TUTANKHAMON

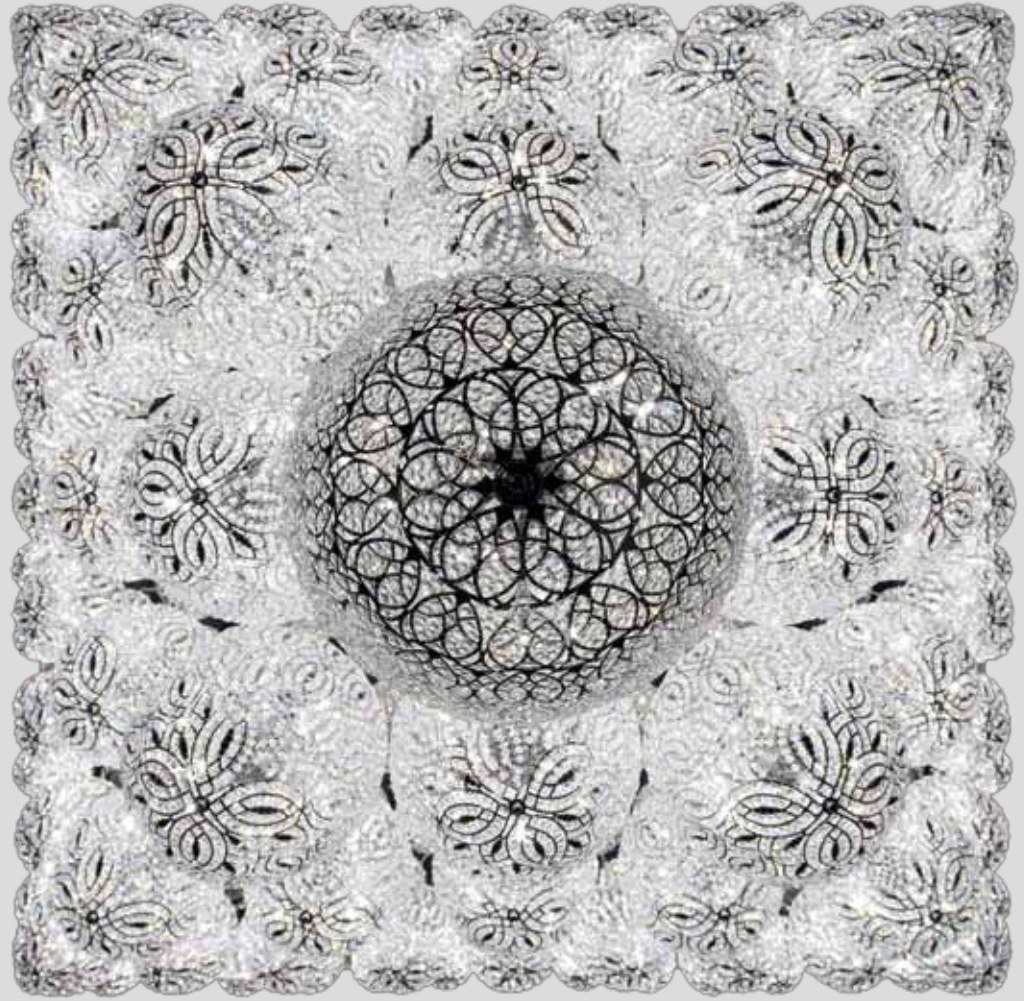

CHANDELIERS

*full customized*

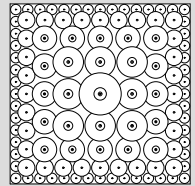
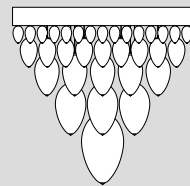



## ARABESQUE LIGHTFALL SENSATION

Una sontuosa cascata di cristalli intagliati illumina gli ambienti più preziosi con una pioggia di splendenti bagliori. L'illuminazione trascende la propria usuale funzione e diventa lo strumento ideale capace di dare vita ad ambientazioni e atmosfere irripetibili. La collezione è completamente personalizzabile per dimensioni e finiture.

*A lavish cascade of carved crystal lights up the finest of interiors with a shower of bright lights. The lighting transcends their usual function and becomes the ideal instrument capable of bringing unique environments and atmospheres to life. The collection can be fully customized in terms of dimensions and finishes.*

CLUSTERS

*full customized*



ARABESQUE LIGHTFALL SENSATION

CLUSTERS

*full customized*

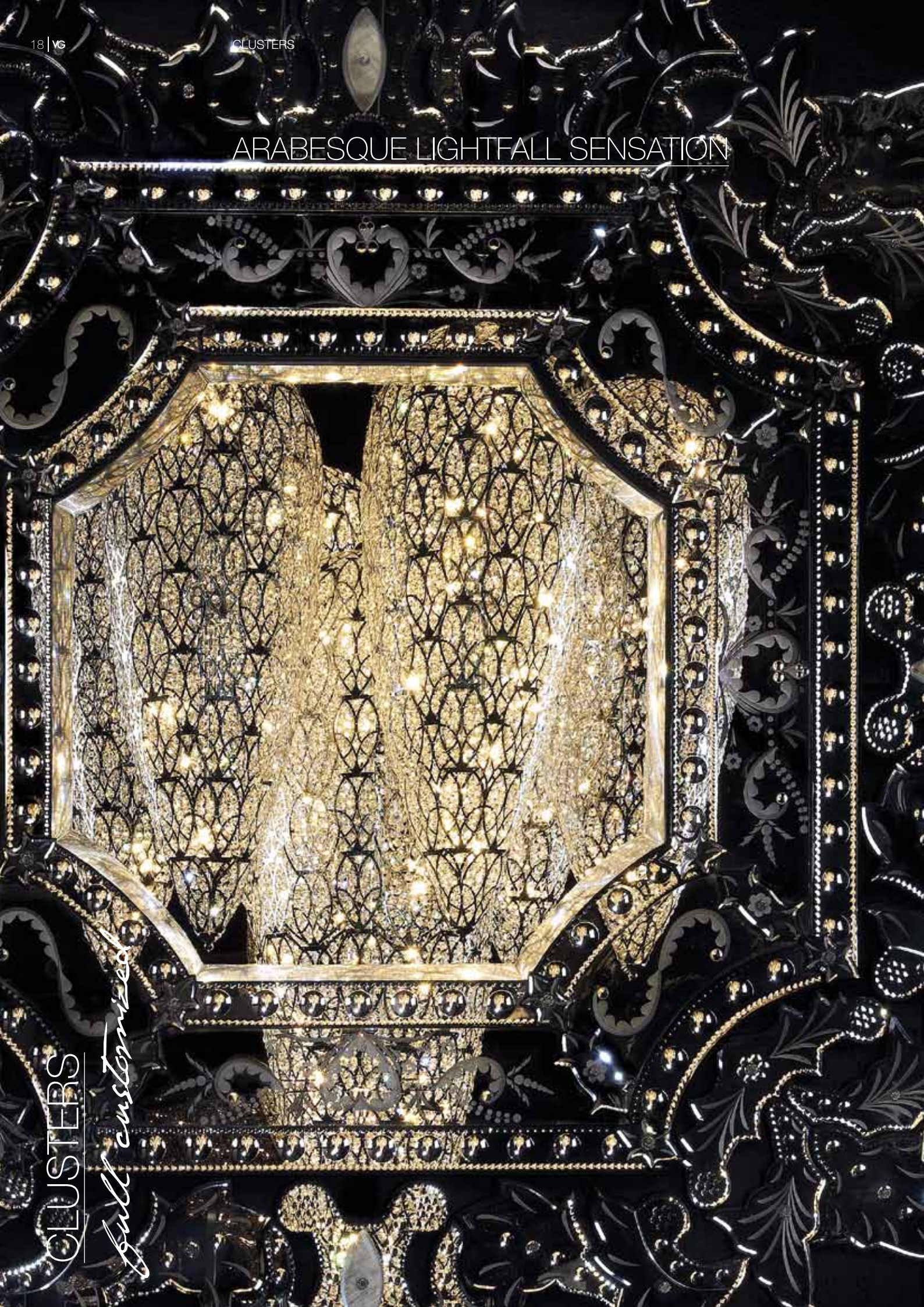



# ARABESQUE LIGHTFALL SENSATION



**CLUSTERS**

*full customized*

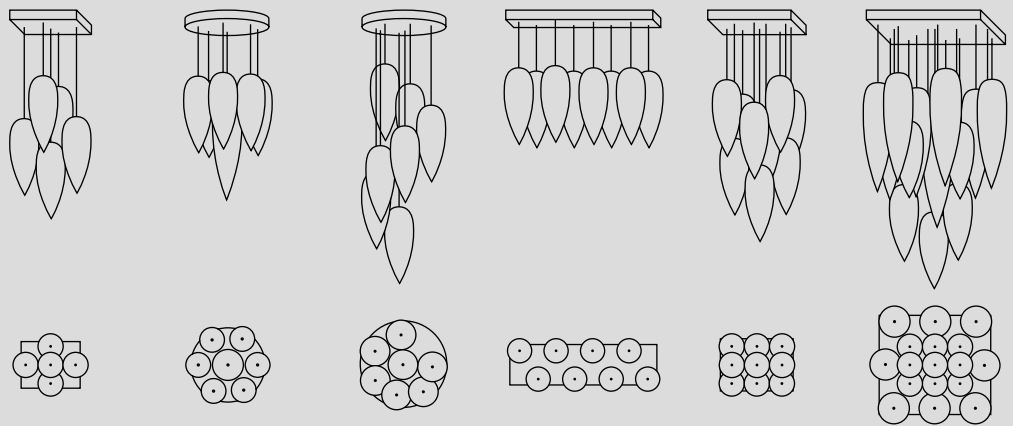



## ARABESQUE LIGHTFALL EGG

Sfavillanti e maestosi, gli arabeschi di cristallo delle lampade Egg creano accenti di luce che vestono lo spazio di suggestiva eleganza. La goccia di cristallo intagliato, impreziosita dagli inserti in acciaio cromato, è una vera e propria icona VG, che può essere declinata in numerose variabili, dalle diverse dimensioni e composizioni.

*Sparkling and majestic, crystal arabesques of Egg lights create light emphasis that cover the space with striking elegance. The drop of carved crystal, enriched with chrome steel inserts, is a true VG icon, which can be articulated in several variables, in different dimensions and compositions.*

CLUSTERS

*full customized*





# ARABESQUE LIGHTFALL EGG



CLUSTERS

*full customized*

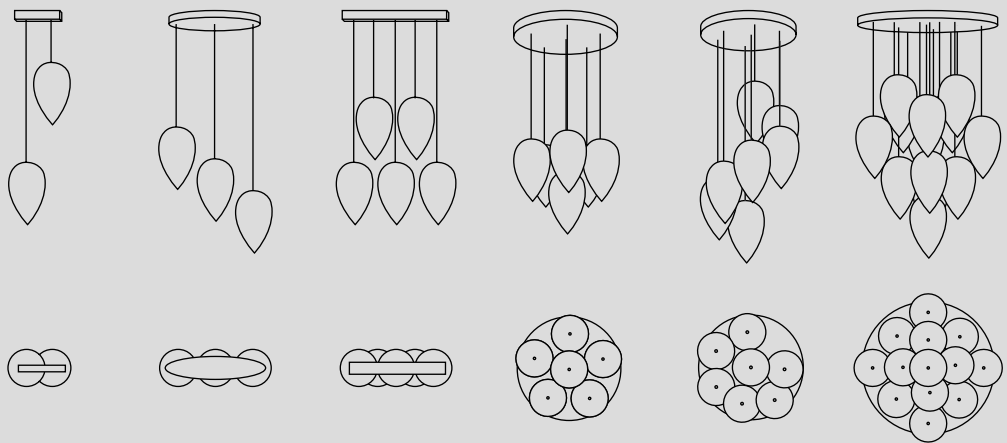



ARABESQUE LIGHTFALL EGG

CLUSTERS

*full customized*





ARABESQUE LIGHTFALL EGG



CLUSTERS

*full customized*

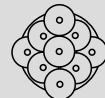
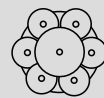
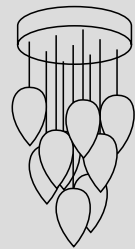
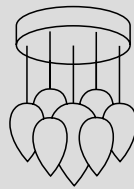



Le lampade da terra e da tavolo VG creano scenografie coordinate fortemente suggestive, dal grande impatto estetico ed emozionale. Con il loro fascino discreto riescono a risaltare ogni tipo di ambientazione, sia classica che contemporanea.

*VG floor and table lamps create highly suggestive coordinated sets having a great aesthetic and emotional impact. With their discreet charm they highlight any kind of environment, classic and contemporary.*

FLOOR & TABLE LAMPS





# ARABESQUE EGG 30 / 50 / 75

## EGG 30

	HALOGEN	LED
Lampadina - <i>Bulb</i>	3 x G9 34 W	3 x G4 2.3 W
Consumo - <i>Power</i>	102 W	6,9 W
Flusso - <i>Flux</i>	3 x 435 Lm	3 x 190 Lm
Dimmer	incluso - <i>included</i>	-
Codice - <i>Code</i>	7511339.98	7511339.11

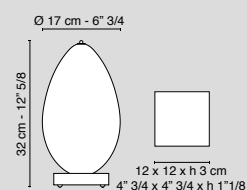

## EGG 50

	HALOGEN	LED
Lampadina - <i>Bulb</i>	6 x G9 34 W	6 x G4 2.3 W
Consumo - <i>Power</i>	204 W	13,8 W
Flusso - <i>Flux</i>	6 x 435 Lm	6 x 190 Lm
Dimmer	incluso - <i>included</i>	-
Codice - <i>Code</i>	7511340.98	7511340.11

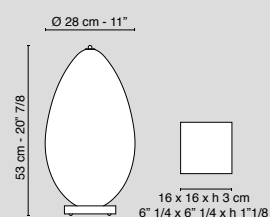

## EGG 75

	HALOGEN	LED
Lampadina - <i>Bulb</i>	10 x G9 34 W	10 x G4 2.3 W
Consumo - <i>Power</i>	340 W	23 W
Flusso - <i>Flux</i>	10 x 435 Lm	10 x 190 Lm
Dimmer	su richiesta - <i>on request</i>	
Codice - <i>Code</i>	7511421.98	7511421.11

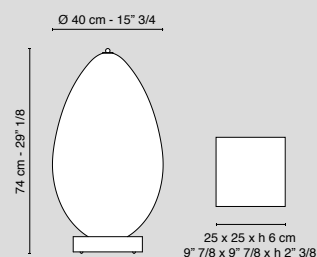

Finitura - *Finish*



cromo lucido  
*polished chrome*



\* oro galvanizzato  
*galvanized gold*







# ARABESQUE EGG 90 / 120 / 150

## EGG 90

	HALOGEN	LED
Lampadina - <i>Bulb</i>	15 x G9 34 W	15 x G4 2.3 W
Consumo - <i>Power</i>	510 W	34,5 W
Flusso - <i>Flux</i>	15 x 435 Lm	15 x 190 Lm
Dimmer	su richiesta-on request	
Codice - <i>Code</i>	7510892.98	7510892.11

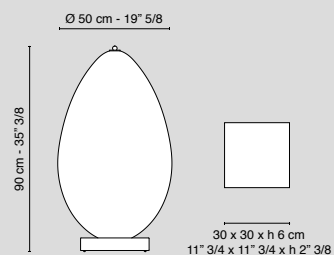

## EGG 120

	HALOGEN	LED
Lampadina - <i>Bulb</i>	20 x G9 34 W	20 x G4 2.3 W
Consumo - <i>Power</i>	680 W	46 W
Flusso - <i>Flux</i>	20 x 435 Lm	20 x 190 Lm
Dimmer	su richiesta-on request	
Codice - <i>Code</i>	7511419.98	7511419.11

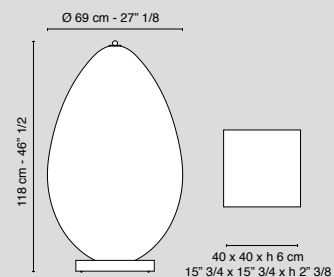

## EGG 150

	HALOGEN	LED
Lampadina - <i>Bulb</i>	34 x G9 34 W	34 x G4 2.3 W
Consumo - <i>Power</i>	1156 W	78,2 W
Flusso - <i>Flux</i>	34 x 435 Lm	34 x 190 Lm
Dimmer	su richiesta-on request	
Codice - <i>Code</i>	7511420.98	7511420.11

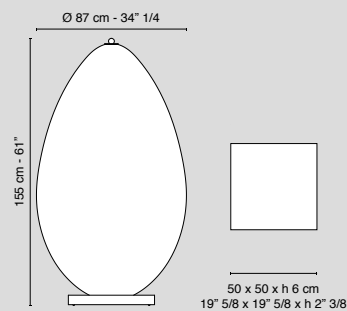

Finitura - *Finish*



cromo lucido  
*polished chrome*



\* oro galvanizzato  
*galvanized gold*



## ARABESQUE SMALL FLAME



	<b>HALOGEN</b>	<b>LED</b>
Lampadina - <i>Bulb</i>	16 x G9 34 W	16 x G4 2.3 W
Consumo - <i>Power</i>	544 W	36,8 W
Flusso - <i>Flux</i>	16 x 435 Lm	16 x 190 Lm
Dimmer	su richiesta - <i>on request</i>	
Codice - <i>Code</i>	7511203.98	7511203.11

### Finitura - *Finish*



cromo lucido  
*polished chrome*



\* oro galvanizzato  
*galvanized gold*

Ø 40 cm - 15" 3/4

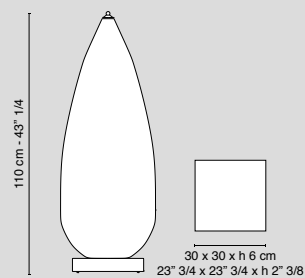



## ARABESQUE BIG FLAME



	HALOGEN	LED
Lampadina - <i>Bulb</i>	23 x G9 34 W	23 x G4 2.3 W
Consumo - <i>Power</i>	782 W	52,9 W
Flusso - <i>Flux</i>	23 x 435 Lm	23 x 190 Lm
Dimmer	su richiesta-on request	
Codice - <i>Code</i>	7511173.98	7511173.11

Finitura - *Finish*



cromo lucido  
*polished chrome*



\* oro galvanizzato  
*galvanized gold*

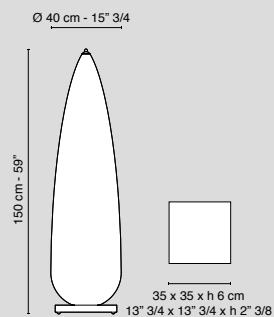



V.G.

V.G.

## ARABESQUE HEARTBEAT



	HALOGEN	LED
Lampadina - <i>Bulb</i>	15 x G9 34 W	15 x G4 2.3 W
Consumo - <i>Power</i>	510 W	34,5 W
Flusso - <i>Flux</i>	15 x 435 Lm	15 x 190 Lm
Dimmer	su richiesta - <i>on request</i>	
Codice - <i>Code</i>	7511174.98	7511174.11

Finitura - *Finish*



cromo lucido  
*polished chrome*



\* oro galvanizzato  
*galvanized gold*

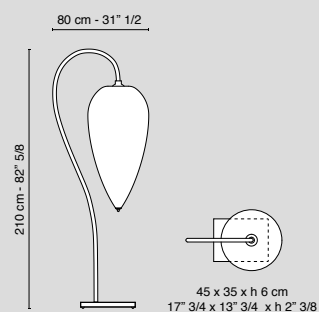



## ARABESQUE EXCLAMATION SMALL



	HALOGEN	LED
Lampadina - Bulb	14 x G9 34 W	14 x G4 2.3 W
Consumo - Power	476 W	32,2 W
Flusso - Flux	14 x 435 Lm	14 x 190 Lm
Dimmer	su richiesta-on request	
Codice - Code	7511172.98	7511172.11

Finitura - Finish



cromo lucido  
polished chrome



\* oro galvanizzato  
galvanized gold



\* su richiesta  
on request

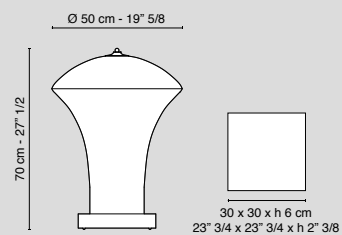



## ARABESQUE EXCLAMATION BIG



	HALOGEN	LED
Lampadina - <i>Bulb</i>	22 x G9 34 W	22 x G4 2.3 W
Consumo - <i>Power</i>	748 W	50,6 W
Flusso - <i>Flux</i>	22 x 435 Lm	22 x 190 Lm
Dimmer	su richiesta - <i>on request</i>	
Codice - <i>Code</i>	7511175.98	7511175.11

Finitura - *Finish*



cromo lucido  
*polished chrome*



\* oro galvanizzato  
*galvanized gold*

IP 20    

\* su richiesta  
*on request*

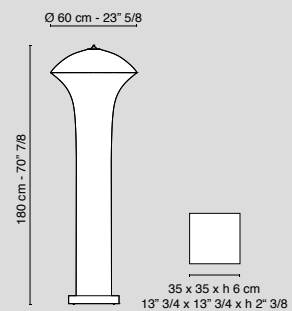



## ARABESQUE RECTANGULAR SEPARÉ



	HALOGEN	LED
Lampadina - <i>Bulb</i>	26 x G9 34 W	26 x G4 2.3 W
Consumo - <i>Power</i>	884 W	59,8 W
Flusso - <i>Flux</i>	26 x 435 Lm	26 x 190 Lm
Dimmer	su richiesta - <i>on request</i>	
Codice - <i>Code</i>	7511327.98	7511327.11

Finitura - *Finish*



cromo lucido  
*polished chrome*



\* oro galvanizzato  
*galvanized gold*

IP 20    

\* su richiesta  
*on request*

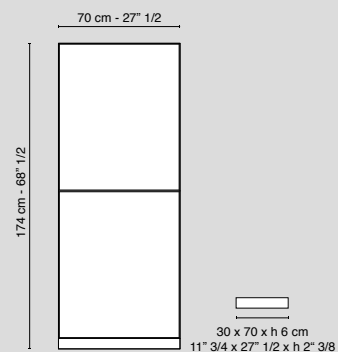







# NUVOLA



## NUVOLA x 1

Materiali - Materials	acciaio - tessuto / stainless steel - fabric
Porta lampada - Bulb holder	E27
Lampadina - Bulb	1 x 60 W max
Codice - Code	7510560.00 <small>lampadine non include bulbs not included</small>

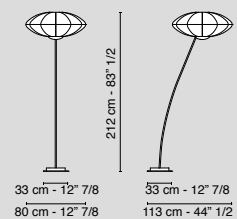

## NUVOLA x 2

Materiali - Materials	acciaio - tessuto / stainless steel - fabric
Porta lampada - Bulb holder	E27
Lampadina - Bulb	2 x 60 W max
Codice - Code	7510559.00 <small>lampadine non include bulbs not included</small>

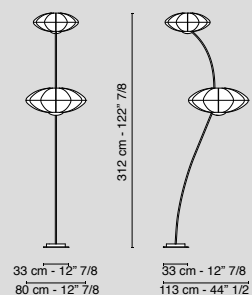

## NUVOLA x 3

Materiali - Materials	acciaio - tessuto / stainless steel - fabric
Porta lampada - Bulb holder	E27
Lampadina - Bulb	3 x 60 W max
Codice - Code	7510558.00 <small>lampadine non include bulbs not included</small>

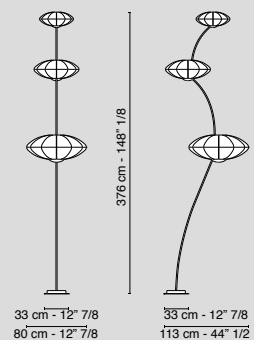



Gocce sinuose e molteplici forme decorano le pareti dando vita ad ambientazioni sofisticate che esaltano al meglio l'armonia dei particolari. Un tocco di fascino per ogni ambientazione: dagli spazi più sfarzosi ai living moderni. Diverse proposte per soddisfare le più varie esigenze stilistiche ed architettoniche.

*Winding drops and multiple shapes decorate the walls, creating sophisticated environments that highlight at the best harmony of the details. A touch of glamour for any environment: the most luxurious to modern living spaces. Several proposals to meet the most diverse requirements in terms of style and architecture.*



# ARABESQUE EGG 50 / 90

## EGG 50

	HALOGEN	LED
Lampadina - <i>Bulb</i>	6 x G9 34 W	6 x G4 2.3 W
Consumo - <i>Power</i>	204 W	13,8 W
Flusso - <i>Flux</i>	6 x 435 Lm	6 x 190 Lm
Codice - <i>Code</i>	7511348.00	7511348.11

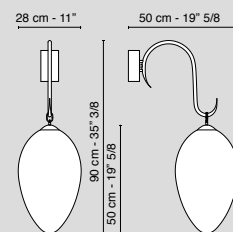

## EGG 90

	HALOGEN	LED
Lampadina - <i>Bulb</i>	15 x G9 34 W	15 x G4 2.3 W
Consumo - <i>Power</i>	510 W	23 W
Flusso - <i>Flux</i>	15 x 435 Lm	15 x 190 Lm
Codice - <i>Code</i>	7511133.98	7511133.11

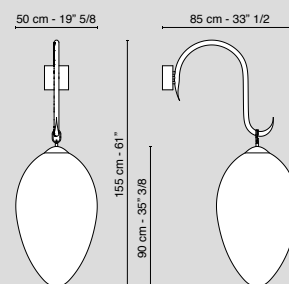

### Finitura - *Finish*



Cromo lucido  
polished chrome



\* oro galvanizzato  
galvanized gold





## ARABESQUE HEARTBEAT



	HALOGEN	LED
Lampadina - <i>Bulb</i>	16 x G9 34 W	16 x G4 2.3 W
Consumo - <i>Power</i>	544 W	36,8 W
Flusso - <i>Flux</i>	16 x 435 Lm	16 x 190 Lm
Codice - <i>Code</i>	7511216.98	7511216.11

Finitura - *Finish*



cromo lucido  
*polished chrome*



\* oro galvanizzato  
*galvanized gold*

IP 20    

\* su richiesta  
*on request*

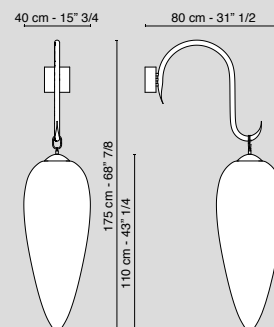



## ARABESQUE IONICO EGG



	HALOGEN	LED*
Lampadina - Bulb	6 x G9 34 W	
Consumo - Power	204 W	
Flusso - Flux	6 x 435 Lm	
Codice - Code	7511407.98	

Finitura - Finish



cromo lucido  
polished chrome



\* oro galvanizzato  
galvanized gold

IP 20    

\* su richiesta  
on request

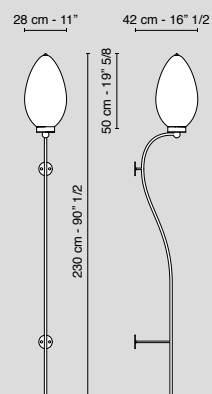







# ARABESQUE DROP



## SMALL

	HALOGEN	LED
Lampadina - <i>Bulb</i>	8 x G9 34 W	8 x G4 2.3 W
Consumo - <i>Power</i>	272 W	18,4 W
Flusso - <i>Flux</i>	8 x 435 Lm	8 x 190 Lm
Codice - <i>Code</i>	7511336.98	7511336.11

20 cm - 7" 7/8

15 cm - 5" 7/8

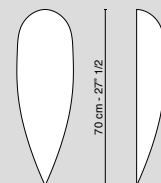

## MEDIUM

	HALOGEN	LED
Lampadina - <i>Bulb</i>	11 x G9 34 W	11 x G4 2.3 W
Consumo - <i>Power</i>	374 W	25,3 W
Flusso - <i>Flux</i>	11 x 435 Lm	11 x 190 Lm
Codice - <i>Code</i>	7511335.98	7511335.11

33 cm - 12" 7/8

22 cm - 8" 5/8

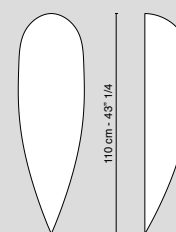

## BIG

	HALOGEN	LED
Lampadina - <i>Bulb</i>	14 x G9 34 W	14 x G4 2.3 W
Consumo - <i>Power</i>	476 W	32,2 W
Flusso - <i>Flux</i>	14 x 435 Lm	14 x 190 Lm
Codice - <i>Code</i>	7521913.98	7521913.11

42 cm - 16" 1/2

27 cm - 10" 5/8

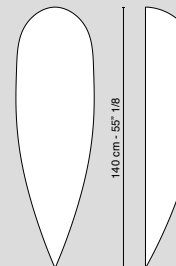

Finitura - *Finish*



cromo lucido  
*polished chrome*



\* oro galvanizzato  
*galvanized gold*







# ARABESQUE ARRAS

## SQUARE SMALL

	HALOGEN	LED
Lampadina - <i>Bulb</i>	8 x G9 34 W	8 x G4 2.3 W
Consumo - <i>Power</i>	272 W	18,4 W
Flusso - <i>Flux</i>	8 x 435 Lm	8 x 190 Lm
Codice - <i>Code</i>	7511451.98	7511451.11

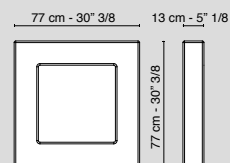

## SQUARE BIG

	HALOGEN	LED
Lampadina - <i>Bulb</i>	25 x G9 34 W	25 x G4 2.3 W
Consumo - <i>Power</i>	850 W	57,5 W
Flusso - <i>Flux</i>	25 x 435 Lm	25 x 190 Lm
Codice - <i>Code</i>	7511452.98	7511452.11

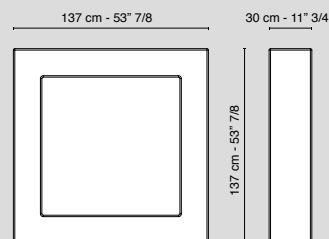

## RECTANGULAR SMALL

	HALOGEN	LED
Lampadina - <i>Bulb</i>	11 x G9 34 W	11 x G4 2.3 W
Consumo - <i>Power</i>	374 W	25,3 W
Flusso - <i>Flux</i>	11 x 435 Lm	11 x 190 Lm
Codice - <i>Code</i>	7511453.98	7511453.11

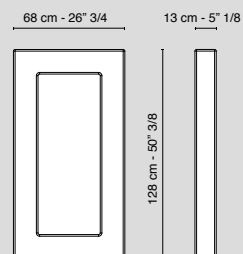

## RECTANGULAR BIG

	HALOGEN	LED
Lampadina - <i>Bulb</i>	28 x G9 34 W	28 x G4 2.3 W
Consumo - <i>Power</i>	952 W	65 W
Flusso - <i>Flux</i>	28 x 435 Lm	28 x 190 Lm
Codice - <i>Code</i>	7511454.98	7511454.11

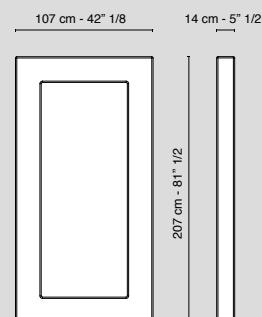

Finitura - *Finish*



cromo lucido  
*polished chrome*



\* oro galvanizzato  
*galvanized gold*

Rivestimento della  
cornice secondo  
campionario VG  
*Frame covering  
according to  
VG pattern book*



# ARABESQUE DOMINO

## SQUARE SMALL

	HALOGEN	LED
Lampadina - <i>Bulb</i>	8 x G9 34 W	8 x G4 2.3 W
Consumo - <i>Power</i>	272 W	18,4 W
Flusso - <i>Flux</i>	8 x 435 Lm	8 x 190 Lm
Codice - <i>Code</i>	7511324.98	7511324.11

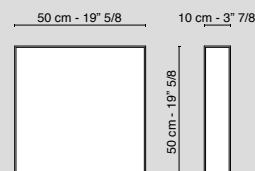

## SQUARE BIG

	HALOGEN	LED
Lampadina - <i>Bulb</i>	25 x G9 34 W	25 x G4 2.3 W
Consumo - <i>Power</i>	850 W	57,5 W
Flusso - <i>Flux</i>	25 x 435 Lm	25 x 190 Lm
Codice - <i>Code</i>	7511323.98	7511323.11

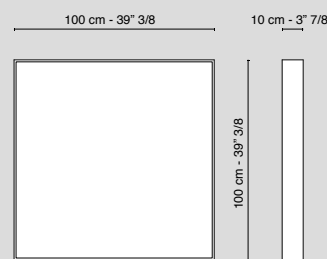

## RECTANGULAR SMALL

	HALOGEN	LED
Lampadina - <i>Bulb</i>	11 x G9 34 W	11 x G4 2.3 W
Consumo - <i>Power</i>	374 W	25,3 W
Flusso - <i>Flux</i>	11 x 435 Lm	11 x 190 Lm
Codice - <i>Code</i>	7511325.98	7511325.11

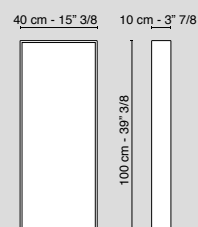

## RECTANGULAR BIG

	HALOGEN	LED
Lampadina - <i>Bulb</i>	28 x G9 34 W	28 x G4 2.3 W
Consumo - <i>Power</i>	952 W	65 W
Flusso - <i>Flux</i>	28 x 435 Lm	28 x 190 Lm
Codice - <i>Code</i>	7511326.98	7511326.11

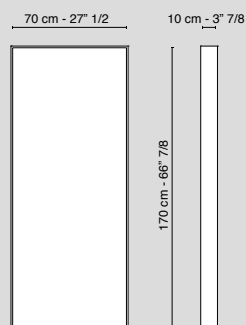

Finitura - *Finish*



cromo lucido  
*polished chrome*



\* oro galvanizzato  
*galvanized gold*

VG LOUNGE BAR

LUXURY  
*creation*



Le lampade a sospensione VG rendono possibili infiniti scenari luminosi, che si svelano con un semplice sguardo verso l'alto. La luce diventa la sintesi perfetta tra sogno e realtà.

*VG hanging lamps allow infinite lighting sets up to be created, which are revealed by simply glancing upwards. The light becomes the perfect synthesis between dream and reality.*



# ARABESQUE SENSATION



## SMALL

	HALOGEN	LED
Lampadina - <i>Bulb</i>	16 x G9 34 W	16 x G4 2.3 W
Consumo - <i>Power</i>	544 W	36,8 W
Flusso - <i>Flux</i>	16 x 435 Lm	16 x 190 Lm
Codice - <i>Code</i>	7511170.98	7511170.11

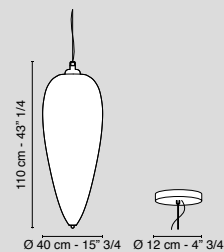

## BIG

	HALOGEN	LED
Lampadina - <i>Bulb</i>	23 x G9 34 W	23 x G4 2.3 W
Consumo - <i>Power</i>	782 W	52,9 W
Flusso - <i>Flux</i>	23 x 435 Lm	23 x 190 Lm
Codice - <i>Code</i>	7511171.98	7511171.11

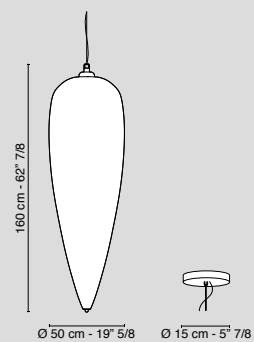

### Finitura - *Finish*



cromo lucido  
*polished chrome*



\* oro galvanizzato  
*galvanized gold*



# ARABESQUE EGG 30 / 50 / 75

## EGG 30

	HALOGEN	LED
Lampadina - <i>Bulb</i>	3 x G9 34 W	3 x G4 2.3 W
Consumo - <i>Power</i>	102 W	6,9 W
Flusso - <i>Flux</i>	3 x 435 Lm	3 x 190 Lm
Codice - <i>Code</i>	7511331.98	7511331.11

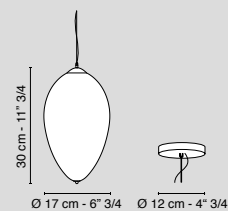

## EGG 50

	HALOGEN	LED
Lampadina - <i>Bulb</i>	6 x G9 34 W	6 x G4 2.3 W
Consumo - <i>Power</i>	204 W	13,8 W
Flusso - <i>Flux</i>	6 x 435 Lm	6 x 190 Lm
Codice - <i>Code</i>	7511332.98	7511332.11

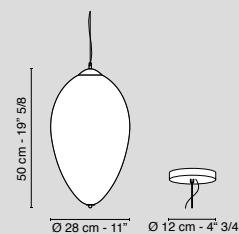

## EGG 75

	HALOGEN	LED
Lampadina - <i>Bulb</i>	10 x G9 34 W	10 x G4 2.3 W
Consumo - <i>Power</i>	340 W	23 W
Flusso - <i>Flux</i>	10 x 435 Lm	10 x 190 Lm
Codice - <i>Code</i>	7511424.98	7511424.11

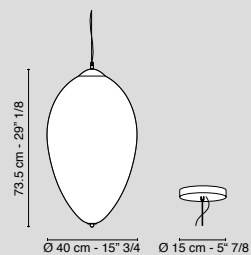

### Finitura - *Finish*



Cromo lucido  
 *polished chrome*



\* Oro galvanizzato  
 *galvanized gold*





# ARABESQUE EGG 90 / 120 / 150



## EGG 90

	HALOGEN	LED
Lampadina - <i>Bulb</i>	15 x G9 34 W	15 x G4 2.3 W
Consumo - <i>Power</i>	510 W	34,5 W
Flusso - <i>Flux</i>	15 x 435 Lm	15 x 190 Lm
Codice - <i>Code</i>	7510891.98	7510891.11

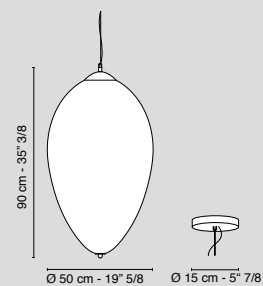

## EGG 120

	HALOGEN	LED
Lampadina - <i>Bulb</i>	20 x G9 34 W	20 x G4 2.3 W
Consumo - <i>Power</i>	680 W	46 W
Flusso - <i>Flux</i>	20 x 435 Lm	20 x 190 Lm
Codice - <i>Code</i>	7511422.98	7511422.11

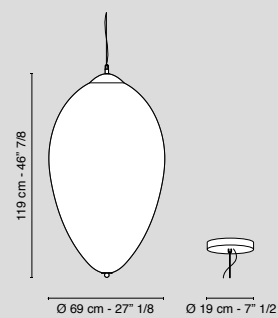

## EGG 150

	HALOGEN	LED
Lampadina - <i>Bulb</i>	34 x G9 34 W	34 x G4 2.3 W
Consumo - <i>Power</i>	1156 W	78,2 W
Flusso - <i>Flux</i>	34 x 435 Lm	34 x 190 Lm
Codice - <i>Code</i>	7511423.98	7511423.11

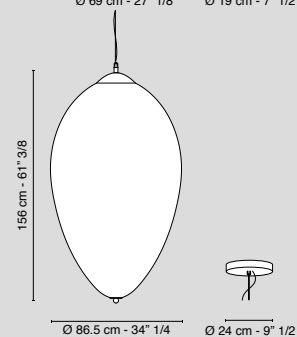

Finitura - *Finish*



cromo lucido  
*polished chrome*



\* oro galvanizzato  
*galvanized gold*



# ARABESQUE SQUARE

## SV 50

	HALOGEN	LED
Lampadina - Bulb	8 x G9 34 W	8 x G4 2.3 W
Consumo - Power	272 W	18,4 W
Flusso - Flux	8 x 435 Lm	8 x 190 Lm
Codice - Code	7511321.98	7511321.11

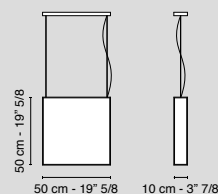

## SV 100

	HALOGEN	LED
Lampadina - Bulb	18 x G9 34 W	18 x G4 2.3 W
Consumo - Power	612 W	41,5 W
Flusso - Flux	18 x 435 Lm	18 x 190 Lm
Codice - Code	7511377.98	7511377.11

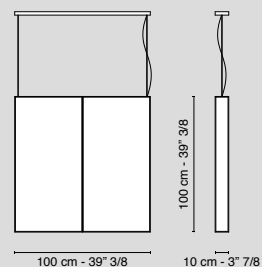

## SH 50

	HALOGEN	LED
Lampadina - Bulb	8 x G9 34 W	8 x G4 2.3 W
Consumo - Power	272 W	18,4 W
Flusso - Flux	8 x 435 Lm	8 x 190 Lm
Codice - Code	7511322.98	7511322.11

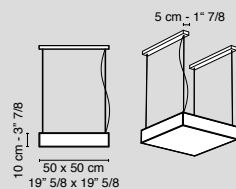

## SH 100

	HALOGEN	LED
Lampadina - Bulb	18 x G9 34 W	18 x G4 2.3 W
Consumo - Power	612 W	41,5 W
Flusso - Flux	18 x 435 Lm	18 x 190 Lm
Codice - Code	7511378.98	7511378.11

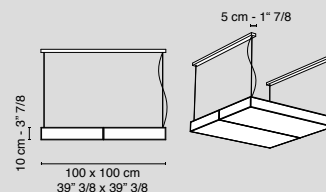

Finitura - Finish



Cromo lucido  
polished chrome



\* Oro galvanizzato  
galvanized gold

IP 20    

\* su richiesta  
on request





# ARABESQUE RECTANGULAR

## RV 40

	HALOGEN	LED
Lampadina - <i>Bulb</i>	10 x G9 34 W	10 x G4 2.3 W
Consumo - <i>Power</i>	340 W	23 W
Flusso - <i>Flux</i>	10 x 435 Lm	10 x 190 Lm
Codice - <i>Code</i>	7511374.98	7511374.11

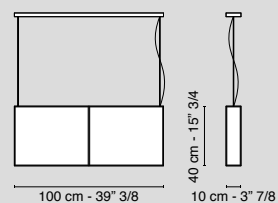

## RV 70

	HALOGEN	LED
Lampadina - <i>Bulb</i>	26 x G9 34 W	26 x G4 2.3 W
Consumo - <i>Power</i>	884 W	59,8 W
Flusso - <i>Flux</i>	26 x 435 Lm	26 x 190 Lm
Codice - <i>Code</i>	7511330.98	7511330.11

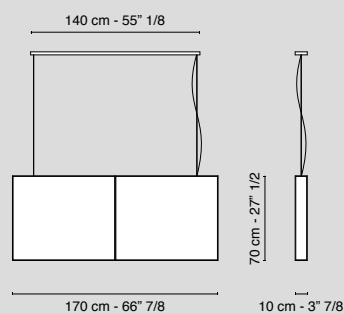

Finitura - *Finish*



cromo lucido  
*polished chrome*



\* oro galvanizzato  
*galvanized gold*

IP 20    

\* su richiesta  
*on request*





# ARABESQUE RECTANGULAR

## RV 100

	HALOGEN	LED
Lampadina - <i>Bulb</i>	10 x G9 34 W	10 x G4 2.3 W
Consumo - <i>Power</i>	340 W	23 W
Flusso - <i>Flux</i>	10 x 435 Lm	10 x 190 Lm
Codice - <i>Code</i>	7511375.98	7511375.11

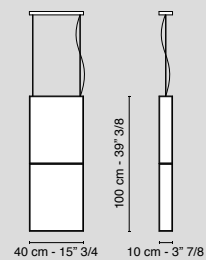

## RV 170

	HALOGEN	LED
Lampadina - <i>Bulb</i>	26 x G9 34 W	26 x G4 2.3 W
Consumo - <i>Power</i>	884 W	59,8 W
Flusso - <i>Flux</i>	26 x 435 Lm	26 x 190 Lm
Codice - <i>Code</i>	7511328.98	7511328.11

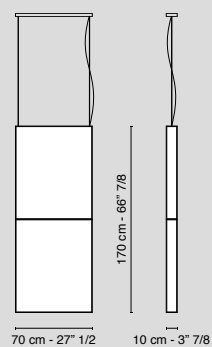

### Finitura - *Finish*



cromo lucido  
*polished chrome*



\* oro galvanizzato  
*galvanized gold*

IP 20    

\* su richiesta  
*on request*





# ARABESQUE RECTANGULAR



## RH 100

	HALOGEN	LED
Lampadina - <i>Bulb</i>	10 x G9 34 W	10 x G4 2.3 W
Consumo - <i>Power</i>	340 W	23 W
Flusso - <i>Flux</i>	10 x 435 Lm	10 x 190 Lm
Codice - <i>Code</i>	7511376.98	7511376.11

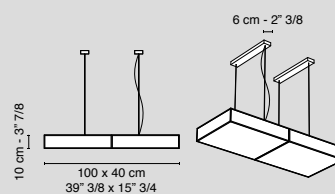

## RH 170

	HALOGEN	LED
Lampadina - <i>Bulb</i>	26 x G9 34 W	26 x G4 2.3 W
Consumo - <i>Power</i>	884 W	59,8 W
Flusso - <i>Flux</i>	26 x 435 Lm	26 x 190 Lm
Codice - <i>Code</i>	7511329.98	7511329.11

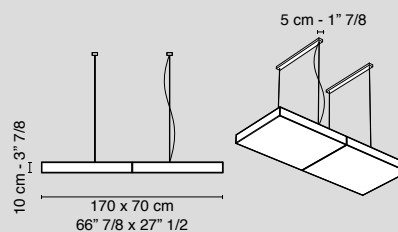

### Finitura - *Finish*



cromo lucido  
*polished chrome*



\* oro galvanizzato  
*galvanized gold*



# ARABESQUE AIRSHIP



	HALOGEN	LED
Lampadina - <i>Bulb</i>	12 x G9 34 W	12 x G4 2.3 W
Consumo - <i>Power</i>	408 W	27,6 W
Flusso - <i>Flux</i>	12 x 435 Lm	12 x 190 Lm
Codice - <i>Code</i>	7521911.98	7521911.11

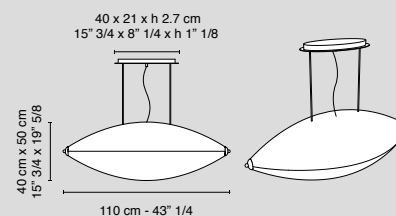

## Finitura - *Finish*



cromo lucido  
*polished chrome*



\* oro galvanizzato  
*galvanized gold*



# RUSTY



Lampadina - <i>Bulb</i>	1 x E27 fluo 20 W
Consumo - <i>Power</i>	20 W
Flusso - <i>Flux</i>	1200 Lm
Frequenza - <i>Frequency</i>	50 - 60 Hz
Alimentazione - <i>Supply</i>	230/240 V
Materiali - <i>Materials</i>	LDPE Rotazionale industriale LDPE Industrial rotational

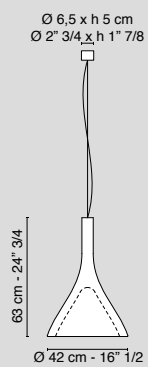

Colori - *Colours*



neutro/*neutral*



Codice - *Code*

**7511545.93**



TROTTY

Lampadina - <i>Bulb</i>	1 x E27 fluo 20 W
Consumo - <i>Power</i>	20 W
Flusso - <i>Flux</i>	1200 Lm
Frequenza - <i>Frequency</i>	50 - 60 Hz
Alimentazione - <i>Supply</i>	230/240 V
Materiali - <i>Materials</i>	LDPE Rotazionale industriale LDPE Industrial rotational

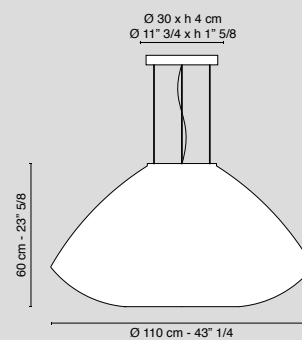
Colori - *Colours*neutro/*neutral*Codice - *Code***7511569.93**



Immediatamente riconoscibili per il fascino e la magia che sanno comunicare fin dal primo sguardo, i vasi-lampada per interni ed esterni Inside Out giocano sapientemente con materiali e finiture per creare scenografiche combinazioni di cromie e forme.

*Instantly recognised by the charm and magic they convey at a first glance, Inside Out lamp-vases for indoors and outdoors play expertly with materials and finishes to create scenic combinations of colours and shapes.*



**VG**  
newtrend

SHOWROOM

INSIDE OUT









# OBICE SMALL



## FLUORESCENT

Lampadina - Bulb	1 x E27 fluo 20 W
Consumo - Power	20 W
Flusso - Flux	1200 Lm
Frequenza - Frequency	50 - 60 Hz
Alimentazione - Supply	230/240 V



Colori - Colours Su richiesta - On request



## Accessori - Accessories

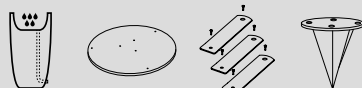

Materiali - Materials

LDPE Rotazionale industriale  
LDPE Industrial rotational

## LED

Lampadina - Bulb	1 x E27 led 5 W
Consumo - Power	5 W
Flusso - Flux	180 Lm
Frequenza - Frequency	50 - 60 Hz
Alimentazione - Supply	100/240 V



Colori - Colours

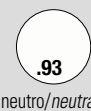

Codice - Code

**7522148**

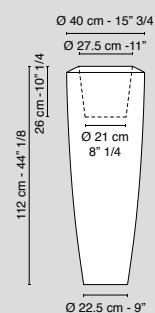



# OBICE



## FLUORESCENT

Lampadina - Bulb	1 / 2 x E27 fluo 20 W
Consumo - Power	20 / 40 W
Flusso - Flux	1200 / 2400 Lm
Frequenza - Frequency	50 - 60 Hz
Alimentazione - Supply	230/240 V



Colori - Colours Su richiesta - On request



neutro/neutral arancio/orange rosso/red fucsia/fuchsia verde/green

Accessori - Accessories

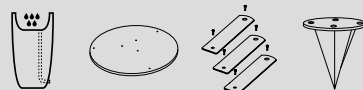

Materiali - Materials

LDPE Rotazionale industriale  
LDPE Industrial rotational

## LED

Lampadina - Bulb	1x E27 led 5 W
Consumo - Power	5 W
Flusso - Flux	180 Lm
Frequenza - Frequency	50 - 60 Hz
Alimentazione - Supply	100/240 V



Colori - Colours



neutro/neutral

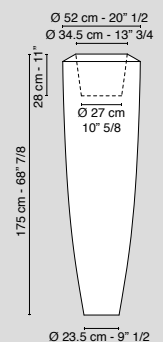

Codice - Code

**7521435**



# TROTTY

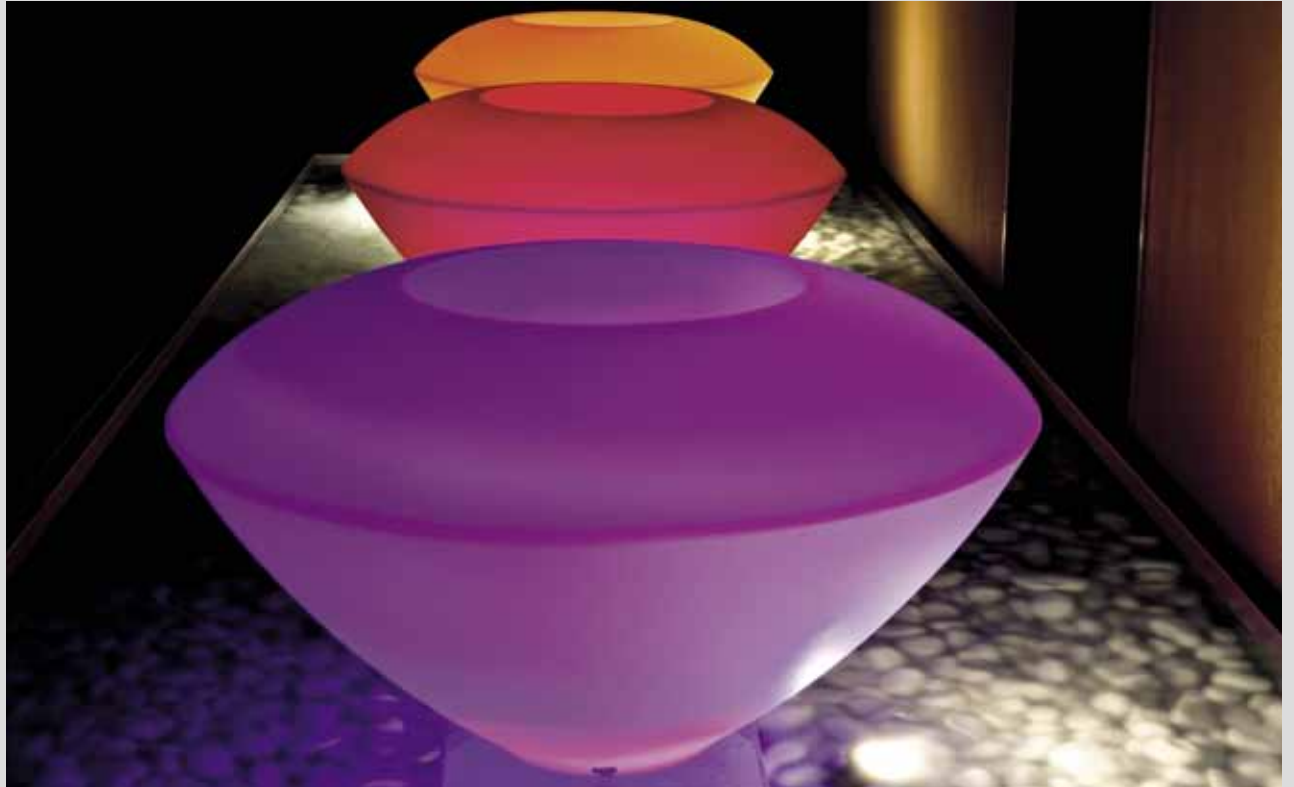

## FLUORESCENT

Lampadina - Bulb	1 x E27 fluo 20 W
Consumo - Power	20 W
Flusso - Flux	1200 Lm
Frequenza - Frequency	50 - 60 Hz
Alimentazione - Supply	230/240 V



Colori - Colours Su richiesta - On request

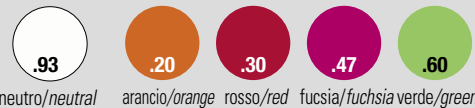

neutro/neutral arancio/orange rosso/red fucsia/fuchsia verde/green

## LED

Lampadina - Bulb	1 x E27 led 5 W
Consumo - Power	5 W
Flusso - Flux	180 Lm
Frequenza - Frequency	50 - 60 Hz
Alimentazione - Supply	100/240 V



Colori - Colours



neutro/neutral

## Accessori - Accessories

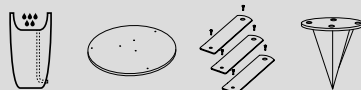

Materiali - Materials

LDPE Rotazionale industriale  
LDPE Industrial rotational

Codice - Code

**7521433**

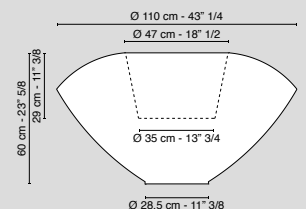



# ARENA



## FLUORESCENT

Lampadina - Bulb	1 x E27 fluo 20 W
Consumo - Power	20 W
Flusso - Flux	1200 Lm
Frequenza - Frequency	50 - 60 Hz
Alimentazione - Supply	230/240 V



Colori - Colours Su richiesta - On request

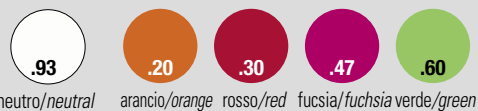

neutro/neutral arancio/orange rosso/red fucsia/fuchsia verde/green

Accessori - Accessories

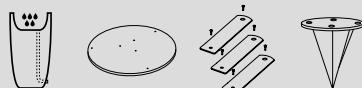

Materiali - Materials

LDPE Rotazionale industriale  
LDPE Industrial rotational

## LED

Lampadina - Bulb	1 x E27 led 5 W
Consumo - Power	5 W
Flusso - Flux	180 Lm
Frequenza - Frequency	50 - 60 Hz
Alimentazione - Supply	100/240 V



Colori - Colours



neutro/neutral

Codice - Code

**7521434**

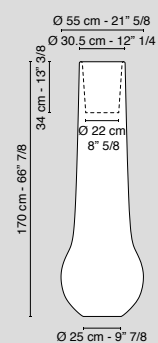



# SAKATA



## FLUORESCENT

Lampadina - <i>Bulb</i>	1 x E27 fluo 20 W
Consumo - <i>Power</i>	20 W
Flusso - <i>Flux</i>	1200 Lm
Frequenza - <i>Frequency</i>	50 - 60 Hz
Alimentazione - <i>Supply</i>	230/240 V



Colori - *Colours* Su richiesta - *On request*



neutro/neutral arancio/orange rosso/red fucsia/fuchsia verde/green

Accessori - *Accessories*

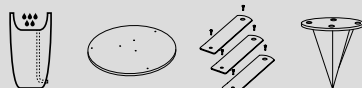

Materiali - *Materials*

LDPE Rotazionale industriale  
LDPE Industrial rotational

## LED

Lampadina - <i>Bulb</i>	1 x E27 led 5 W
Consumo - <i>Power</i>	5 W
Flusso - <i>Flux</i>	180 Lm
Frequenza - <i>Frequency</i>	50 - 60 Hz
Alimentazione - <i>Supply</i>	100/240 V



Colori - *Colours*



neutro/neutral

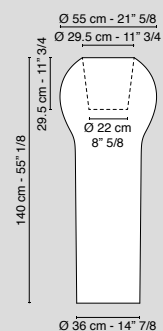

Codice - *Code*

**7521432**

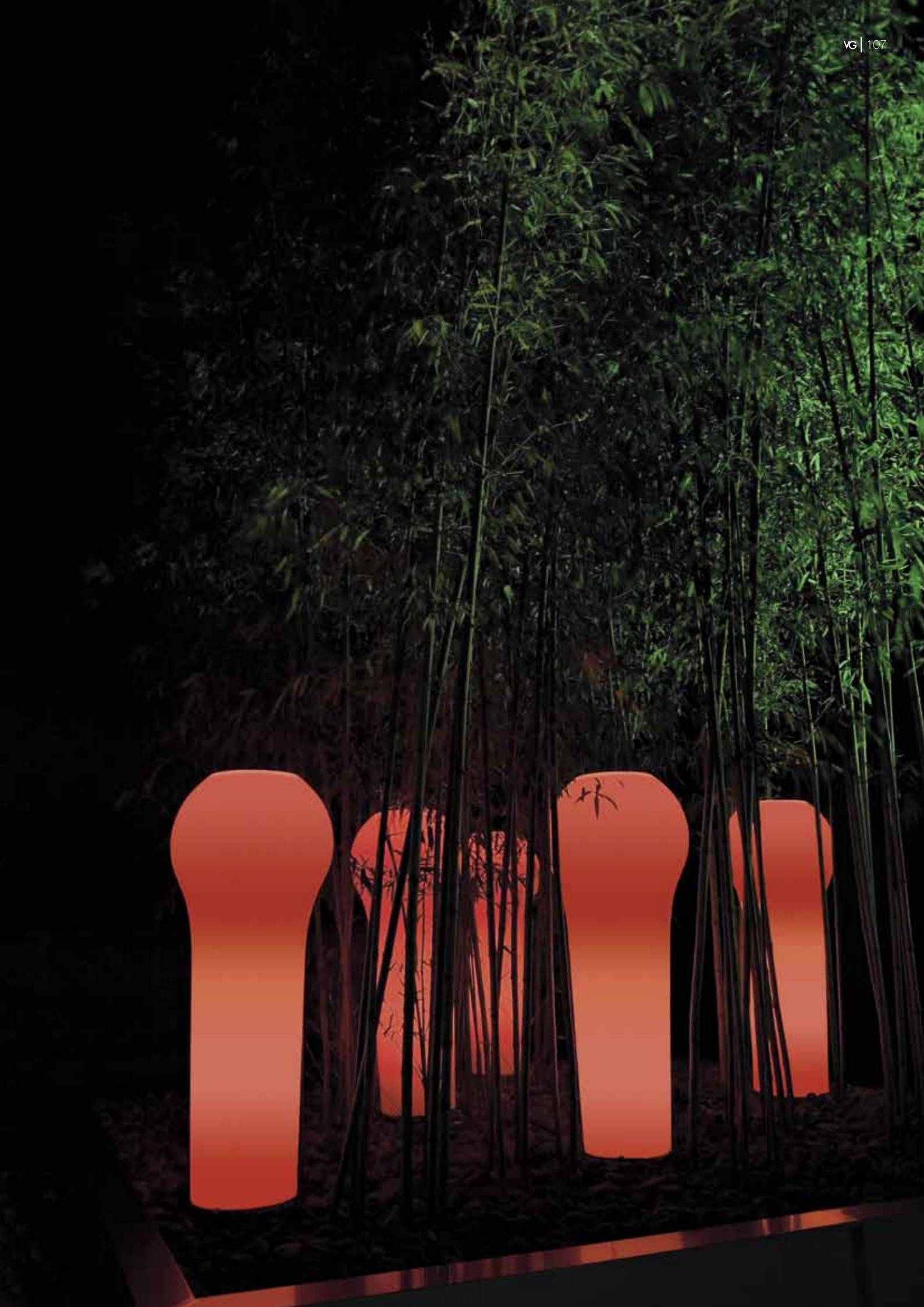

# TIPPY



## FLUORESCENT

Lampadina - Bulb	1 x E27 fluo 20 W
Consumo - Power	20 W
Flusso - Flux	1200 Lm
Frequenza - Frequency	50 - 60 Hz
Alimentazione - Supply	230/240 V



Colori - Colours Su richiesta - On request

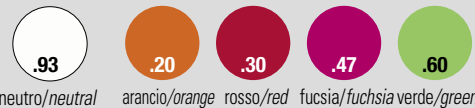

neutro/neutral arancio/orange rosso/red fucsia/fuchsia verde/green

Accessori - Accessories

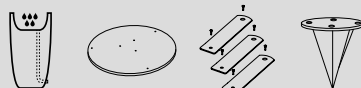

Materiali - Materials

LDPE Rotazionale industriale  
LDPE Industrial rotational

## LED

Lampadina - Bulb	1 x E27 led 5 W
Consumo - Power	5 W
Flusso - Flux	180 Lm
Frequenza - Frequency	50 - 60 Hz
Alimentazione - Supply	100/240 V



Colori - Colours



neutro/neutral

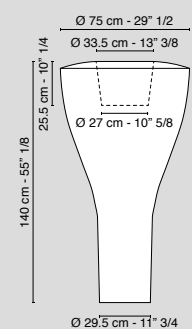

Codice - Code

**7521430**



# JETA



## FLUORESCENT

Lampadina - Bulb	1 / 2 x E27 fluo 20 W
Consumo - Power	20 / 40 W
Flusso - Flux	1200 / 2400 Lm
Frequenza - Frequency	50 - 60 Hz
Alimentazione - Supply	230/240 V



Colori - Colours Su richiesta - On request

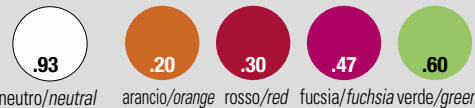

Accessori - Accessories

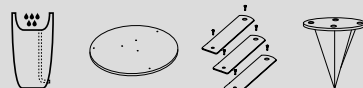

Materiali - Materials

LDPE Rotazionale industriale  
LDPE Industrial rotational

## LED

Lampadina - Bulb	1x E27 led 5 W
Consumo - Power	5 W
Flusso - Flux	180 Lm
Frequenza - Frequency	50 - 60 Hz
Alimentazione - Supply	100/240 V



Colori - Colours

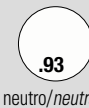

Codice - Code

**7521969**

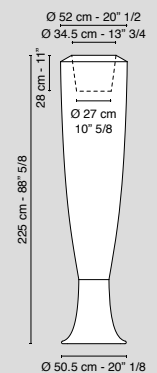



# KLOE



## FLUORESCENT

Lampadina - <i>Bulb</i>	1 x E27 fluo 20 W
Consumo - <i>Power</i>	20 W
Flusso - <i>Flux</i>	1200 Lm
Frequenza - <i>Frequency</i>	50 - 60 Hz
Alimentazione - <i>Supply</i>	230/240 V



Colori - *Colours* Su richiesta - *On request*

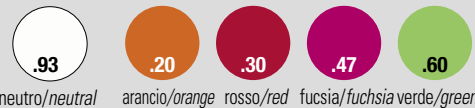

neutro/neutral arancio/orange rosso/red fucsia/fuchsia verde/green

Accessori - *Accessories*

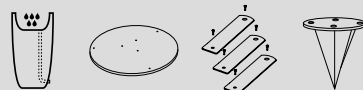

Materiali - *Materials*

LDPE Rotazionale industriale  
LDPE Industrial rotational

## LED

Lampadina - <i>Bulb</i>	1 x E27 led 5 W
Consumo - <i>Power</i>	5 W
Flusso - <i>Flux</i>	180 Lm
Frequenza - <i>Frequency</i>	50 - 60 Hz
Alimentazione - <i>Supply</i>	100/240 V



Colori - *Colours*



neutro/neutral

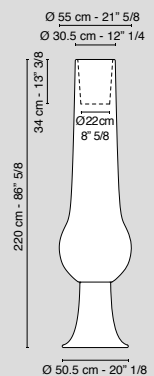

Codice - *Code*

**7521973**



## IP PROTECTION

Indica il grado di protezione contro la penetrazione di corpi solidi e liquidi nell'apparecchio

*Designates the degree of protection against the penetration of solid and liquids parts and contact with live parts*

### **PRIMO CODICE IP / FIRST CODE IP**

PROTEZIONE DAI SOLIDI

*PROTECTION AGAINST SOLID PARTS*

- |          |  |
|----------|--|
| <b>0</b> | Non protetto<br><i>Unprotected</i>   |
| <b>1</b> | Protetto contro corpi solidi estranei di diametro 50 mm<br><i>Protected against the entry of solid parts havings dimensions of more than 50 mm</i>     |
| <b>2</b> | Protetto contro corpi solidi estranei di diametro 12,5 mm<br><i>Protected against the entry of solid parts havings dimensions of more than 12,5 mm</i> |
| <b>3</b> | Protetto contro corpi solidi estranei di diametro 2,5 mm<br><i>Protected against the entry of solid parts havings dimensions of more than 2,5 mm</i>   |
| <b>4</b> | Protetto contro corpi solidi estranei di diametro 1 mm<br><i>Protected against the entry of solid parts havings dimensions of more than 1 mm</i>       |
| <b>5</b> | Protetto contro la polvere<br><i>Protected against entry of dust</i>   |
| <b>6</b> | Totalmente protetto contro la polvere<br><i>Fully protected against entry of dust</i>  |

### **SECONDO CODICE IP / SECOND CODE IP**

PROTEZIONE DAI LIQUIDI

*PROTECTION AGAINST LIQUID*

- |          |  |
|----------|--|
| <b>0</b> | Non protetto<br><i>Unprotected</i>   |
| <b>1</b> | Protetto contro la caduta verticale di gocce d'acqua<br><i>Protected against vertical falling of water drops</i>   |
| <b>2</b> | Protetto contro la pioggia con un angolo di 15°<br><i>Protected against rain having maximum inclination of 15°</i> |
| <b>3</b> | Protetto contro la pioggia con un angolo di 60°<br><i>Protected against rain having maximum inclination of 60°</i> |
| <b>4</b> | Protetto contro spruzzi d'acqua<br><i>Protected against sprinklings</i>  |
| <b>5</b> | Protetto contro i getti d'acqua<br><i>Protected against water jets</i>   |
| <b>6</b> | Protetto contro i getti d'acqua potenti<br><i>Protected against heavy water jets</i>                               |
| <b>7</b> | Protetto contro gli effetti dell'immersione temporanea<br><i>Temporary immersion proof</i>                         |
| <b>8</b> | Protetto contro gli effetti della sommersione continua<br><i>Permanent immersion proof</i>                         |

## ICON LEGENDA



Tutti i prodotti VGnewtrend sono certificati CE  
*All VGnewtrend items are CE certified*



Indica il cablaggio elettrico CL1  
*Designates CL1 electric wiring*



Indica il cablaggio elettrico CL2  
*Designates CL2 electric wiring*



Adatte al montaggio diretto su materiali potenzialmente infiammabili  
*Suitable for installation on potentially flammable surfaces*



Lampada fluorescente compatta  
*Compact fluorescent bulb*



LED RGB Full Colour con telecomando  
*LED RGB Full Colour with remote control*



Adatto all'utilizzo in interno  
*Suitable for indoor use*



Adatto all'utilizzo in esterno  
*Suitable for outdoor use*



Kit drenaggio  
*Drainage set*



Staffe di fissaggio a pavimento  
*Clamps for fixing on the floor*



Piastra di fissaggio  
*Fixing plate*



Picchetti di fissaggio in terreno, sabbia o erba  
*Stake for fixing in soil, sand or grass*



## ARABESQUE TECHNICAL SPECS



### TEMPERATURA COLORE DELLA LUCE - LIGHT COLOUR TEMPERATURE

HALOGEN	LED
2700° K	3000° K

### SPECIFICHE TECNICHE / TECHNICAL SPECS

	HALOGEN - CE listed	LED - CE listed
Lampadina - Bulb	G9 34 W	G4 2.3 W
		
Rendimento luminoso Electrical efficiency	12,8 Lm/W	82 Lm/W
Frequenza - Frequency	50 / 60 hz	50 / 60 hz
Voltaggio - Voltage	220 - 240 V	100 - 240 V
Classe - Class	I <sup>+</sup>	I <sup>+</sup>
Certificazione - Certification	06/95/CE 60598CE	06/95/CE 60598CE
Utilizzo - Use	Interno - Indoor	Interno - Indoor

Le istruzioni per la sostituzione delle lampadine si trovano all'interno del box - Instructions for bulbs replacement can be found inside the box

### ALTRE CERTIFICAZIONI - OTHER CERTIFICATIONS



SASO Certificate

su richiesta  
on request

## GOLDEN FINISH



Lusso intenso, invitante, squisitamente regale. Le luci ARABESQUE sono disponibili anche nella variante color oro, per un'atmosfera ancora più profonda e conturbante.

*Intense, inviting luxury, exquisitely regal. ARABESQUE lights are also available in the golden finishing colour variant, for an even more profound, evocative atmosphere.*

## VOLUMES AND WEIGHTS

	<b>Lampada Lamps</b>	<b>Volume Volume</b>	<b>Peso Weight</b>		<b>Lampada Lamps</b>	<b>Volume Volume</b>	<b>Peso Weight</b>
<b>Chandelier</b>	Octopus	1,69 m <sup>3</sup> /cbm	35 kg / 77 lb	<b>Pendant</b>	Sensation small	0,25 m <sup>3</sup> /cbm	10 kg / 22 lb
<b>Floor &amp; Table</b>	Egg 30	0,009 m <sup>3</sup> /cbm	4 kg / 8,8 lb		Sensation big	0,52 m <sup>3</sup> /cbm	19 kg / 41,8 lb
	Egg 50	0,041 m <sup>3</sup> /cbm	6 kg / 13,2 lb		Egg 30	0,008 m <sup>3</sup> /cbm	2,5 kg / 4,4 lb
	Egg 75	0,11 m <sup>3</sup> /cbm	10 kg / 22 lb		Egg 50	0,03 m <sup>3</sup> /cbm	4 kg / 8,8 lb
	Egg 90	0,266 m <sup>3</sup> /cbm	15 kg / 33 lb		Egg 75	0,11 m <sup>3</sup> /cbm	7,5 kg / 16,5 lb
	Egg 120	0,56 m <sup>3</sup> /cbm	40 kg / 88 lb		Egg 90	0,266 m <sup>3</sup> /cbm	10 kg / 22,05 lb
	Egg 150	1,17 m <sup>3</sup> /cbm	48 kg / 105,6 lb		Egg 120	0,56 m <sup>3</sup> /cbm	30 kg / 66 lb
	Small Flame	0,25 m <sup>3</sup> /cbm	10 kg / 22,05 lb		Egg 150	1,16 m <sup>3</sup> /cbm	40 kg / 88 lb
	Big Flame	0,33 m <sup>3</sup> /cbm	18 kg / 39,6 lb		Square SV 50	0,025 m <sup>3</sup> /cbm	9,5 kg / 20,9 lb
	Heartbeat	1,04 m <sup>3</sup> /cbm	38 kg / 83,6 lb		Square SV 100	0,24 m <sup>3</sup> /cbm	34 kg / 74,8 lb
	Exclamation Small	0,25 m <sup>3</sup> /cbm	13,2 kg / 29,04 lb		Square SH 50	0,025 m <sup>3</sup> /cbm	9,5 kg / 20,9 lb
	Exclamation Big	0,81 m <sup>3</sup> /cbm	32 kg / 70,4 lb		Square SH 100	0,24 m <sup>3</sup> /cbm	34 kg / 74,8 lb
	Rectangular Separé	0,36 m <sup>3</sup> /cbm	50 kg / 110 lb		Vertical RV 40	0,09 m <sup>3</sup> /cbm	14 kg / 30,8 lb
	Nuvola x 1	0,3 m <sup>3</sup> /cbm	25 kg / 66,13 lb		Vertical RV 70	0,11 m <sup>3</sup> /cbm	31 kg / 68,2 lb
	Nuvola x 2	0,4 m <sup>3</sup> /cbm	30 kg / 55 lb		Vertical RV 100	0,09 m <sup>3</sup> /cbm	14 kg / 30,8 lb
	Nuvola x 3	0,45 m <sup>3</sup> /cbm	30 kg / 55 lb		Vertical RV 170	0,11 m <sup>3</sup> /cbm	31 kg / 68,2 lb
<b>Wall</b>	Egg 50	0,11 m <sup>3</sup> /cbm	5 kg / 11 lb		Vertical RH 100	0,09 m <sup>3</sup> /cbm	14 kg / 30,8 lb
	Egg 90	0,3 m <sup>3</sup> /cbm	15 kg / 33 lb		Vertical RH 170	0,11 m <sup>3</sup> /cbm	31 kg / 68,2 lb
	Heartbeat	0,28 m <sup>3</sup> /cbm	13 kg / 28,6 lb		Airship	0,266 m <sup>3</sup> /cbm	15 kg / 33 lb
	Ionic	0,30 m <sup>3</sup> /cbm	12 kg / 26,4 lb		Rusty	0,12 m <sup>3</sup> /cbm	4,5 Kg / 9,92 lb
	Drop small	0,021 m <sup>3</sup> /cbm	5 kg / 11 lb	Trotty	0,72 m <sup>3</sup> /cbm	21 Kg / 46,3 lb	
	Drop medium	0,07 m <sup>3</sup> /cbm	9 kg / 19,8 lb	<b>Inside Out</b>	Obice Small	0,17 m <sup>3</sup> /cbm	6 Kg / 13,23 lb
	Drop big	0,26 m <sup>3</sup> /cbm	12 kg / 26,4 lb		Obice	0,48 m <sup>3</sup> /cbm	20 Kg / 44,10 lb
	Arras square small	0,07 m <sup>3</sup> /cbm	20 kg / 44 lb		Trotty	0,72 m <sup>3</sup> /cbm	18 Kg / 39,68 lb
	Arras square big	0,36 m <sup>3</sup> /cbm	30 kg / 66 lb		Arena	0,58 m <sup>3</sup> /cbm	20 Kg / 44,10 lb
	Arras rect. small	0,11 m <sup>3</sup> /cbm	29 kg / 63,8 lb		Sakata	0,53 m <sup>3</sup> /cbm	20 Kg / 44,10 lb
	Arras rect. big	0,31 m <sup>3</sup> /cbm	45 kg / 99 lb		Tippy	0,67 m <sup>3</sup> /cbm	20 Kg / 44,10 lb
	Domino square small	0,03 m <sup>3</sup> /cbm	8 kg / 17,6 lb		Jeta	0,8 m <sup>3</sup> /cbm	30 Kg / 66,13 lb
	Domino square big	0,05 m <sup>3</sup> /cbm	28 kg / 61,7 lb		Kloe	0,8 m <sup>3</sup> /cbm	30 Kg / 66,13 lb
	Domino rect. small	0,04 m <sup>3</sup> /cbm	13 kg / 28,6 lb				
	Domino rect. big	0,12 m <sup>3</sup> /cbm	35 kg / 77 lb				



## **GRAPHIC PROJECT**

Nicola De Marchi

## **PHOTO**

Andrea Pancino  
Nicola De Marchi

## **COPYWRITER**

Alessandra Gucci  
Mario Graziati

## **SUPPORT BY**

Laura Conte  
Luca Pavan  
Nicola Pellizzon  
Silvia Zugno

## **Note**

Abbiamo preso tutte le precauzioni perchè le descrizioni e le dimensioni dei prodotti siano accurate alla data della stampa di questo catalogo. Tuttavia, è possibile la presenza di alcuni errori per i quali non accettiamo responsabilità.

## **Notes**

Every care has been taken to ensure that all descriptions and dimensions are accurate at the time of printing. However, some errors, which we are not liable for, are still possible.



### **Jupiter Intl Srl**

Via Gramsci, 1/2 - 31055  
Quinto di Treviso (TV) - Italy  
Tel. +39 0422 4724  
info@vgnewtrend.it

### **SHOWROOM**

Treviso (TV) - Italy

[www.vgnewtrend.it](http://www.vgnewtrend.it)



