D
ANDY
HOME COLLECTION

The logo consists of the word 'DANDY' in a large, white, serif font. The letter 'D' is significantly larger than the others and overlaps the 'A'. A small graphic of the Italian flag (green, white, and red vertical stripes) is positioned between the 'A' and 'N'. Below 'DANDY', the words 'HOME' and 'COLLECTION' are written in a smaller, red, sans-serif font, with 'HOME' on the left and 'COLLECTION' on the right.

"Senza i dettagli, è come lo stile"
Viganò

— *"The Details create the style"*

WELCOME IN **DANDY**
HOME

The concept of "Dandy Home Collection" aims at living a unique fashion - oriented lifestyle. The exclusive character of the products is inspired by the world of fashion through new combinations of materials and details.

A great collection of Leather upholstered products and furniture accessories, created and managed by designer Giuseppe Viganò.

Dandy Home Collection is entirely manufactured in Italy and distributed by Gamma Arredamenti International S.p.A. all over the world.



Designer Giuseppe Viganò

INDEX

SOFA

BORDER	162
COCOON	54
EDWIN	102
ESCAPE	70
GREGORY	38
HOLLYWOOD	110
JACK	142
KARL	78
KONG	124
LIMOUSINE	134
MARLON	114
McQUEEN	120
PUZZLE	24
RENEGADE	98
VESSEL	150
VINCENT	4

OCCASIONAL CHAIRS

CHARLOTTE	140
COCOON BERGÈRE	62
CRUISE	32
DEAN	118
GEM	160
GLOSS	130
HARLEY	108
JACKIE	18
LOBSTER	132
LOLITA	128
LOVE	90
LUNA	50
SCARLETT	94
SPIDER	68
TRENCH	148

SALLY	87
SPIDER chair	172
SPIDER stool	174

TABLES & CONSOLLE

BASKET coffee tables	38
BELTS coffee tables	15
CLEPSYDRA coffee tables	56
CRUISE coffee tables	17
DRUMS coffee tables	113
ESCAPE coffee tables	74
KARL coffee tables	85
KONG coffee tables	127
PUZZLE coffee tables	24
SIDE coffee tables	99
STRIPES coffee tables	41
VINCENT coffee tables	4

VENUS consolle	20
VENUS dining table	168

ACCESSORIES

BAGS	158
BIG BAG	149
BASKET LAMPS	40
BOULEVARD BOOKSHELF	154
BROOKLYN BOOKSHELF	86
COCOON SMART ACCESSORIES	67
ROGER SMART ACCESSORIES	36
TURTLE SMART ACCESSORIES	22
SMART STOOLS	70
FLOOR PILLOWS	76
ROYAL PILLOWS	156

VINCENT
GLOSS
VINCENT COFFEE TABLES
BASKET COFFEE TABLE
SIDE COFFEE TABLE
BRIDGET BAG



















20 VENUS CONSOLLE
BUBBLE Gamma Collection



21 VENUS CONSOLLE
JACKIE
ZOOM MIRROR Gamma Collection
BUBBLE Gamma Collection
TURTLE SMART ACCESSORIES







PUZZLE
SPIDER
BROOKLYN BOOKSHELF
SALLY CHAIR
SMART STOOL













- SPIDER
- ESCAPE COFFEE TABLES
- STRIPES COFFEE TABLE
- BASKET LAMPS
- ROYAL PILLOWS





















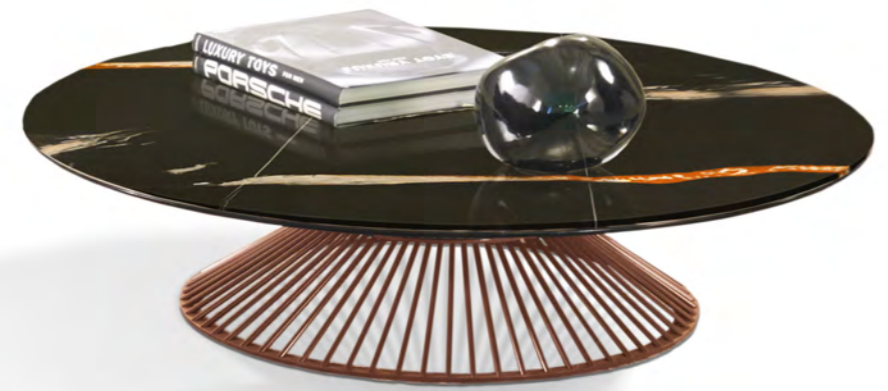











- ESCAPE COFFEE TABLE
- ESCAPE STOOL
- SMART STOOL
- ROYAL PILLOW









































































































INDEX

BED

COCOON NIGHT 178
JACK NIGHT PLUS 194
JAZZ NIGHT 198
MARLON NIGHT 186
McQUEEN NIGHT 190
OXER NIGHT 202

OCCASIONAL CHAIRS

COCOON BERGÈRE 199
DEAN 186
LOLITA 189
LUNA 181
TRENCH 197

COFFEE TABLES

CLEPSYDRA coffee tables 197
CRUISE coffee tables 191
DRUMS coffee tables 180
KONG coffee tables 198

ACCESSORIES

BAKU night stands 182
BAKU dresser 183
SKY night stands 187
BIG BAG 181
COCOON BENCH 178
COCOON SMART ACCESSORIES 184
COCOON MIRROR 183
JACK MIRROR 197
FLOOR PILLOWS 199
ROYAL PILLOWS 196









DEAN
SKY NIGHT STANDS
KONG COFFEE TABLE
ROYAL PILLOWS





















BORDER

Design Giuseppe Viganò

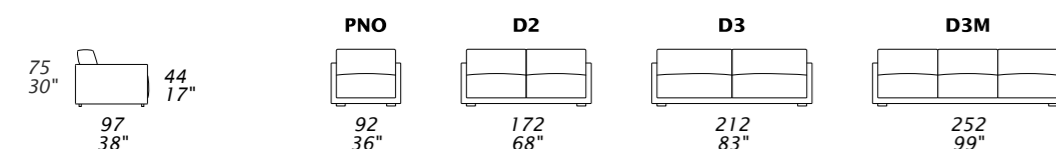

X all items in group X have the same seat width – tutti gli elementi del gruppo X hanno lo stesso modulo di seduta

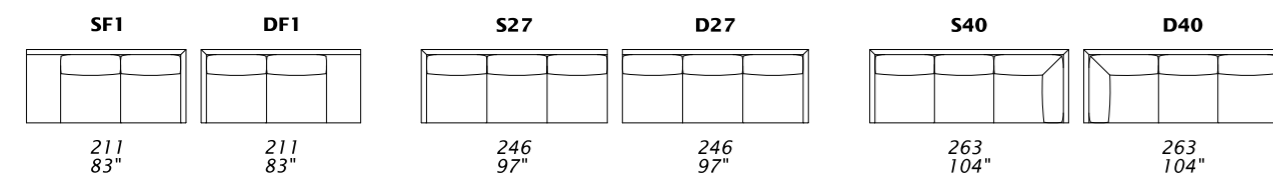
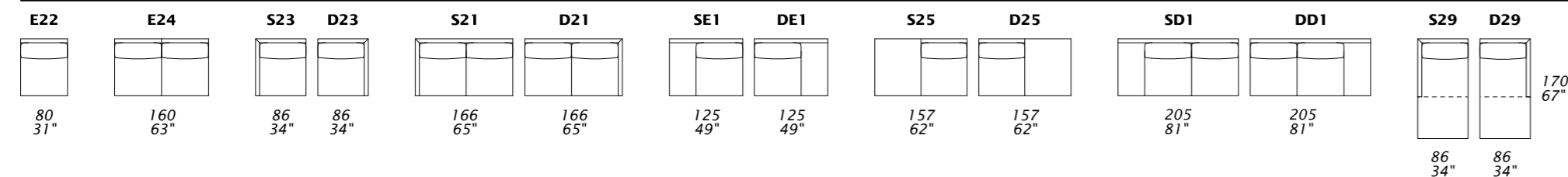

J all items in group J have the same seat width – tutti gli elementi del gruppo J hanno lo stesso modulo di seduta

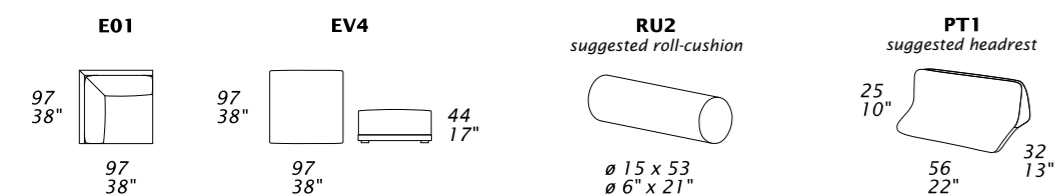
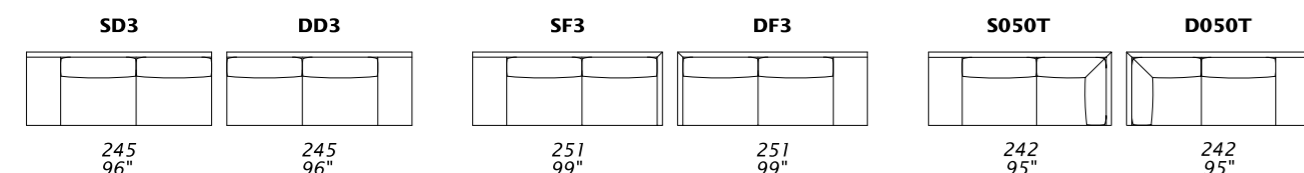
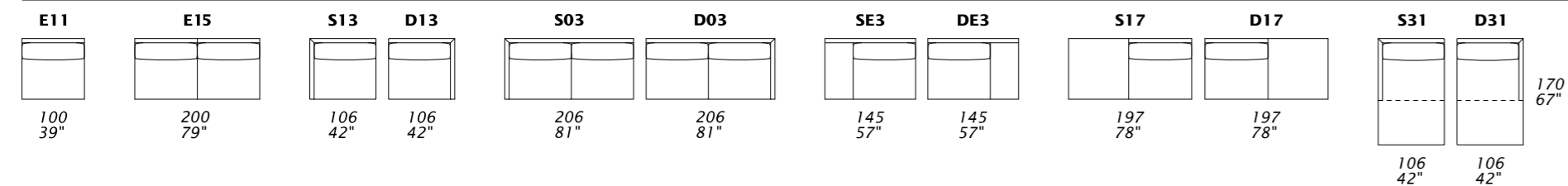

Dimensions: the first figure shows sizes in centimeters, the second in inches.
 Each piece is made by hand and has its own uniqueness. Measures may vary with a tolerance up to 3%.
 Mixing above groups (X - J) will create sectionals with different seat widths.
 Corner piece E01 is an odd piece and can be used with all above groups X - J.
 Seat depth 63 cm - 25".

Technical sheet

COCOON

Design Giuseppe Viganò

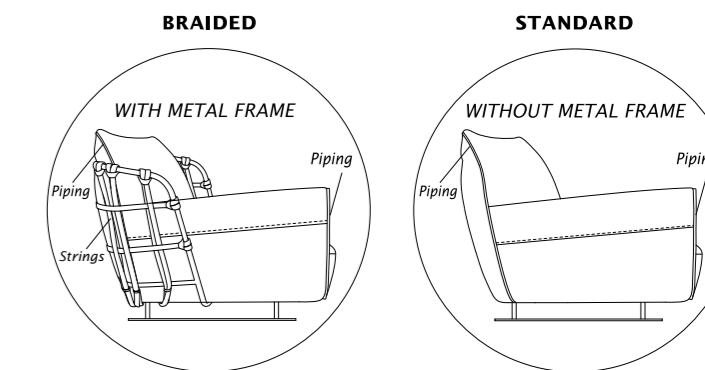
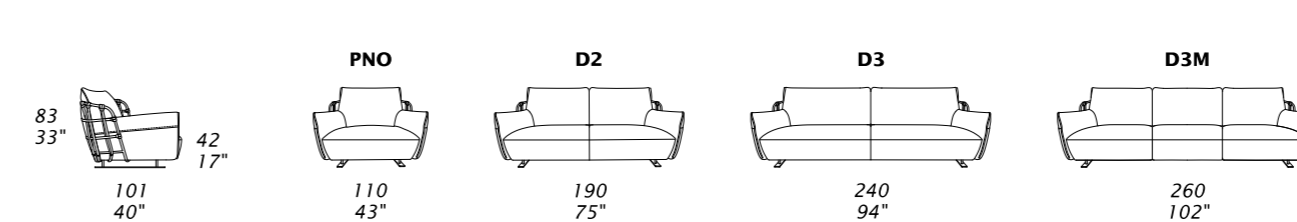

X all items in group X have the same seat width – tutti gli elementi del gruppo X hanno lo stesso modulo di seduta

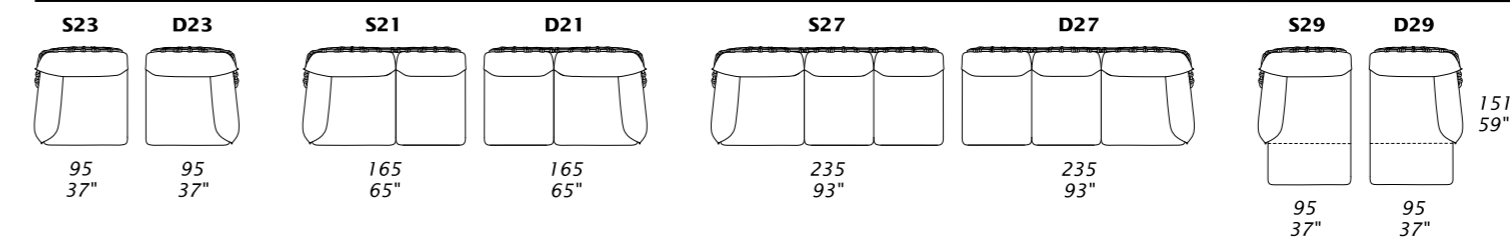

J all items in group J have the same seat width – tutti gli elementi del gruppo J hanno lo stesso modulo di seduta

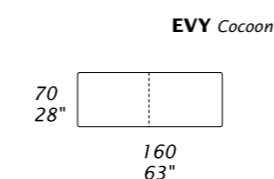
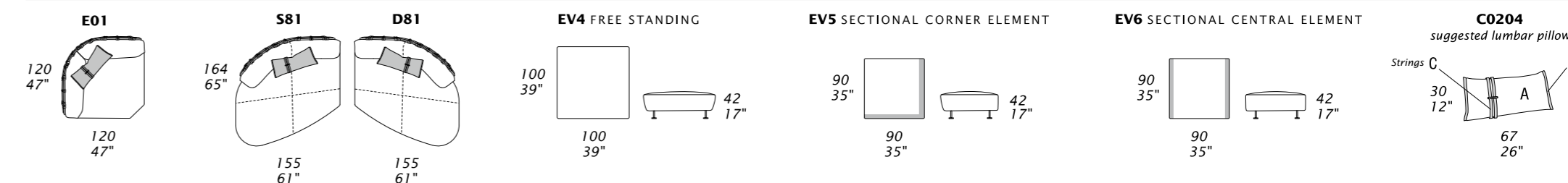
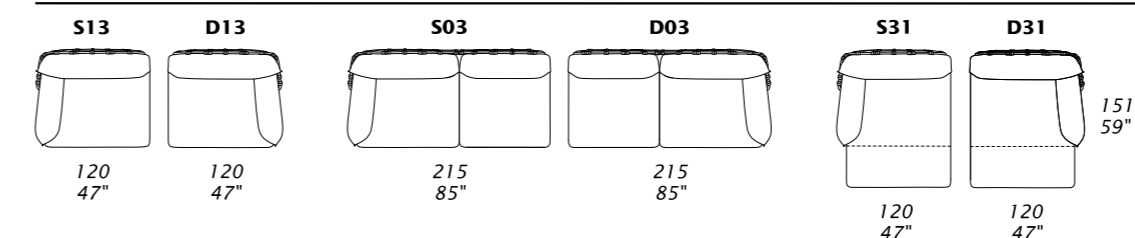

Dimensions: the first figure shows sizes in centimeters, the second in inches.
 Each piece is made by hand and has its own uniqueness. Measures may vary with a tolerance up to 3%.
 Mixing above groups (X - J) will create sectionals with different seat widths.
 Corner pieces E01 and S81/D81 are odd pieces and can be used with all above groups X - J.
 Seat depth 65 cm - 26".

Technical sheet

EDWIN

Design Giuseppe Viganò

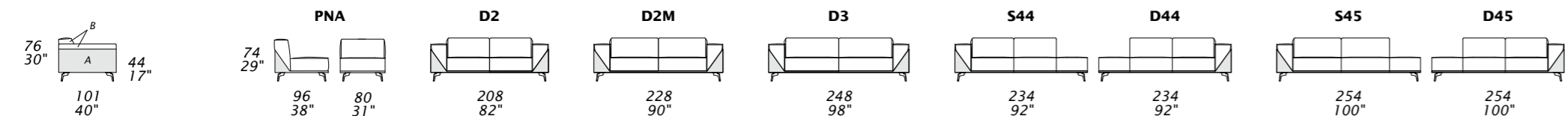

X all items in group X have the same seat width – tutti gli elementi del gruppo X hanno lo stesso modulo di seduta

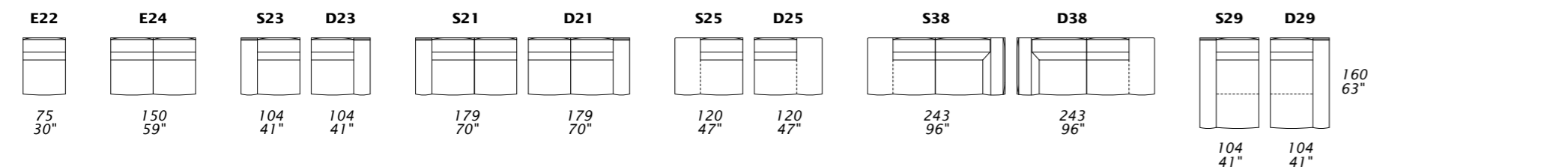

Y all items in group Y have the same seat width – tutti gli elementi del gruppo Y hanno lo stesso modulo di seduta

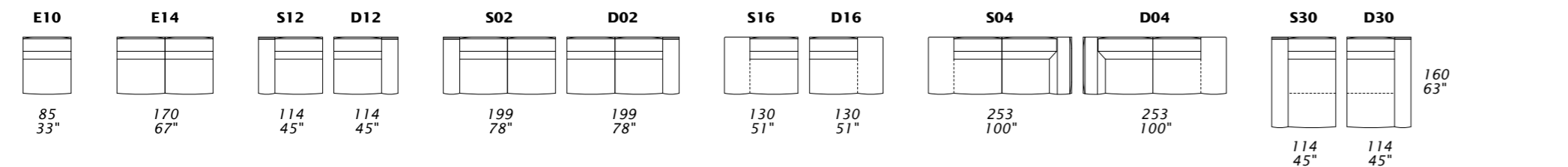

J all items in group J have the same seat width – tutti gli elementi del gruppo J hanno lo stesso modulo di seduta

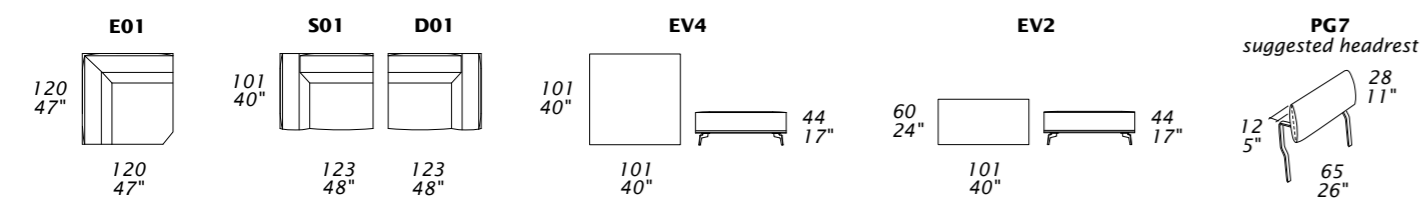
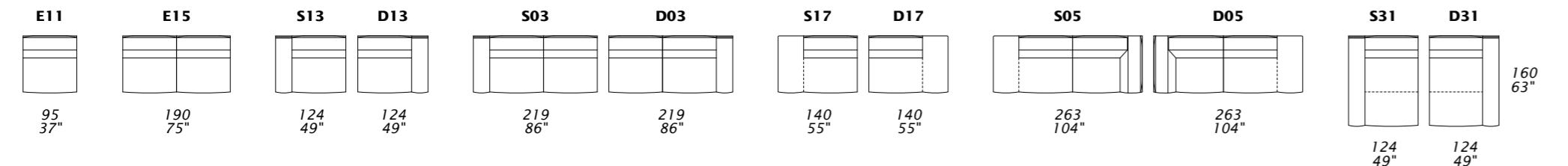

Dimensions: the first figure shows sizes in centimeters, the second in inches.
 Each piece is made by hand and has its own uniqueness. Measures may vary with a tolerance up to 3%.
 Mixing above groups (X - Y - J) will create sectionals with different seat widths.
 Corner pieces E01, S01 and D01 are odd pieces and can be used with all above groups X - Y - J.
 Seat depth 62 cm - 24".

ESCAPE

Design Giuseppe Viganò

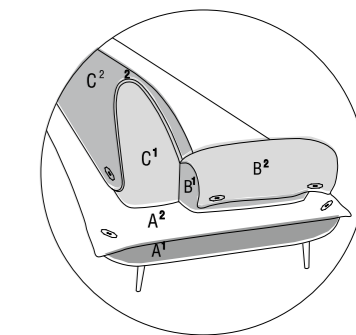
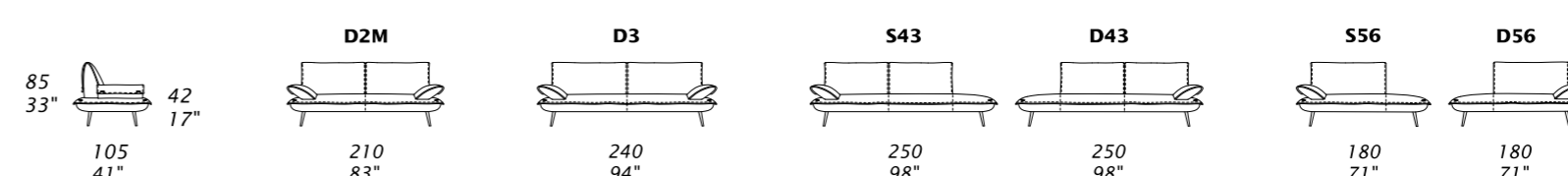

Y all items in group Y have the same seat width – tutti gli elementi del gruppo Y hanno lo stesso modulo di seduta

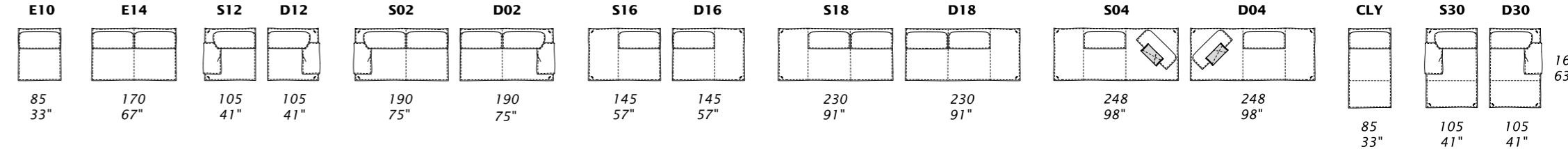

J all items in group J have the same seat width – tutti gli elementi del gruppo J hanno lo stesso modulo di seduta

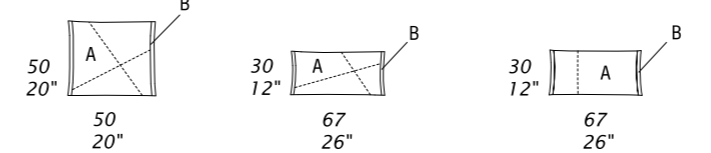
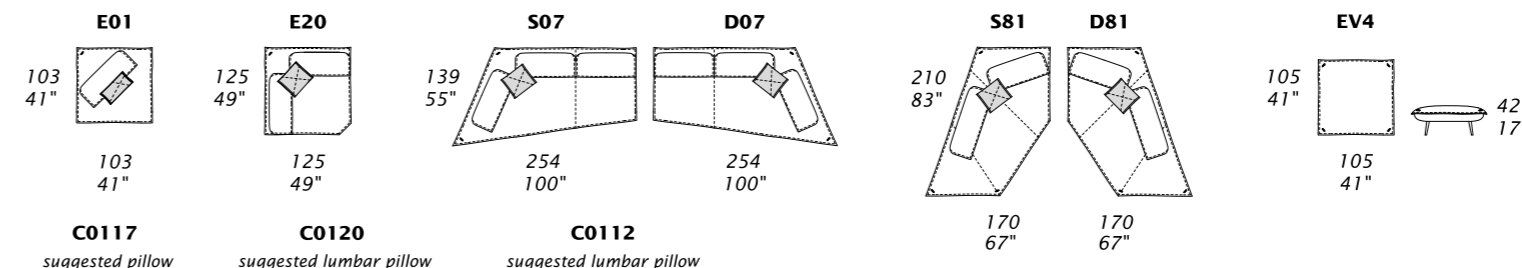
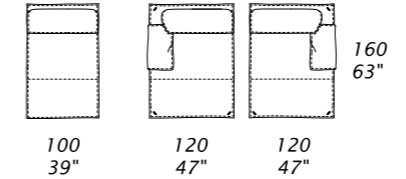
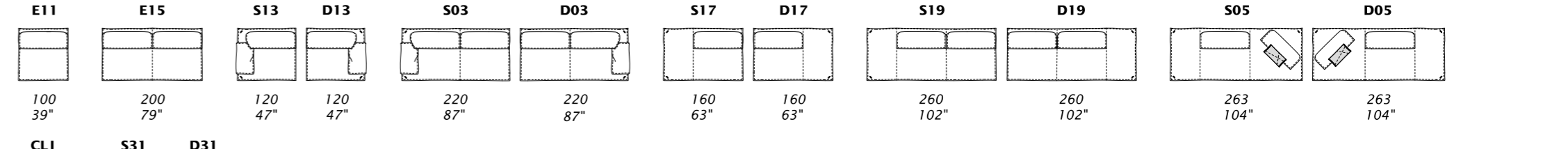

Dimensions: the first figure shows sizes in centimeters, the second in inches.
 Each piece is made by hand and has its own uniqueness. Measures may vary with a tolerance up to 3%.
 Mixing above groups (Y - J) will create sectionals with different seat widths.
 Corner pieces E01, E20, S07/D07 and S81/D81 are odd pieces and can be used with all above groups Y - J.
 Seat depth 65 cm - 26".

_ THE PART **B** OF THE PILLOWS IS AVAILABLE IN: **CUC 501C AND CUC 510B SPECIAL STITCHINGS**

GREGORY

Design Giuseppe Viganò

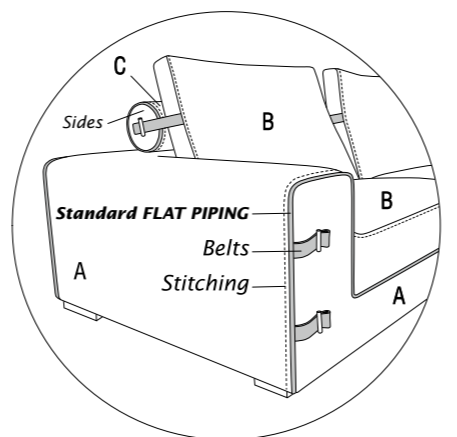
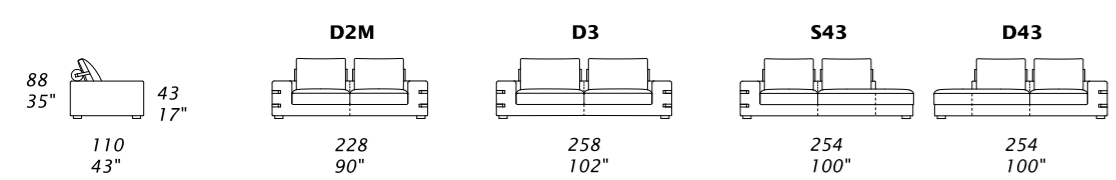

Y all items in group Y have the same seat width – tutti gli elementi del gruppo Y hanno lo stesso modulo di seduta

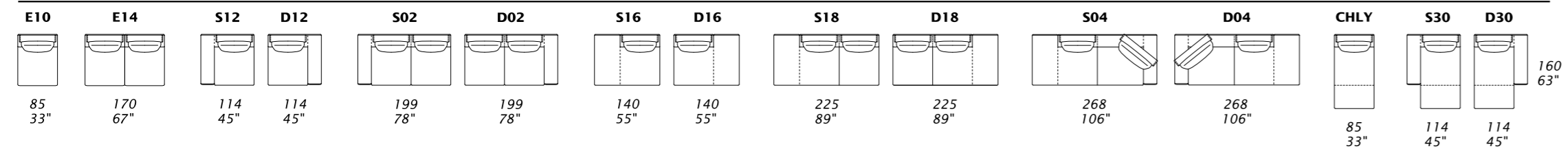

J all items in group J have the same seat width – tutti gli elementi del gruppo J hanno lo stesso modulo di seduta

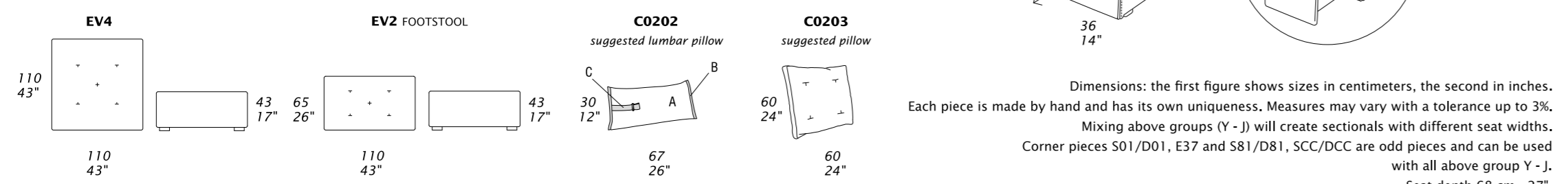
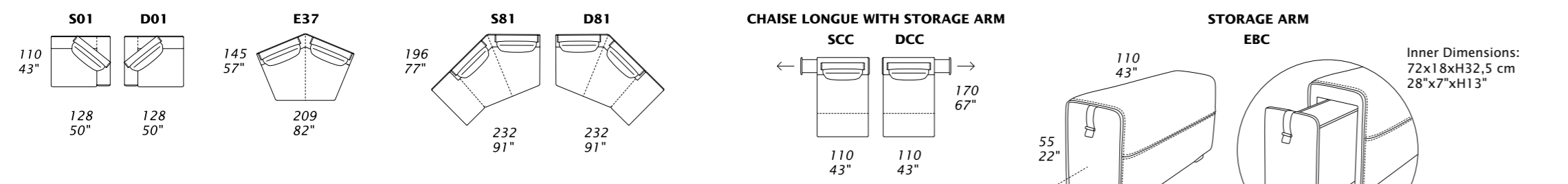
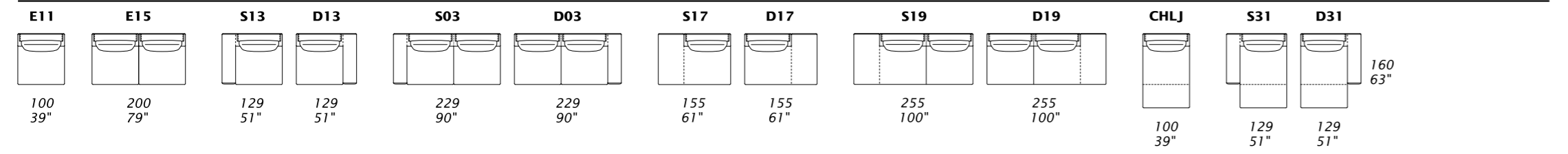

EV4, EV2 AND C0203 STANDARD WITH TUFTING

Dimensions: the first figure shows sizes in centimeters, the second in inches. Each piece is made by hand and has its own uniqueness. Measures may vary with a tolerance up to 3%. Mixing above groups (Y - J) will create sectionals with different seat widths. Corner pieces S01/D01, E37 and S81/D81, SCC/DCC are odd pieces and can be used with all above group Y - J. Seat depth 68 cm - 27".

HOLLYWOOD

Design Giuseppe Viganò

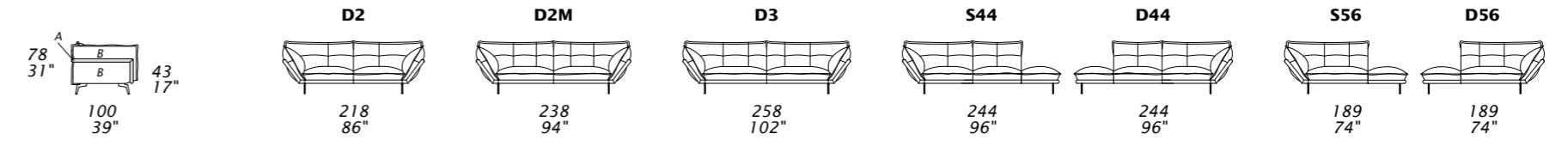

X all items in group X have the same seat width – tutti gli elementi del gruppo X hanno lo stesso modulo di seduta

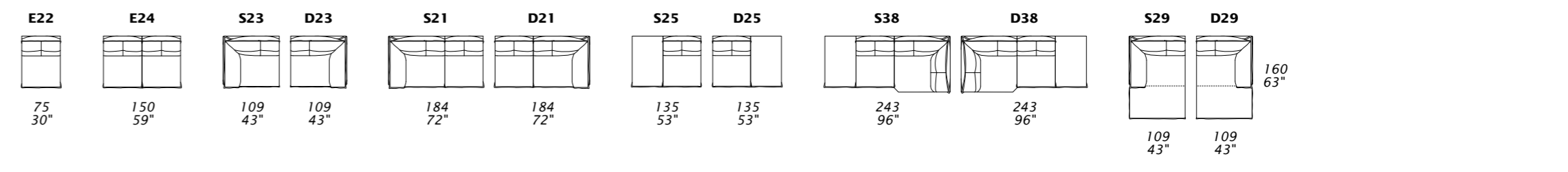

Y all items in group Y have the same seat width – tutti gli elementi del gruppo Y hanno lo stesso modulo di seduta

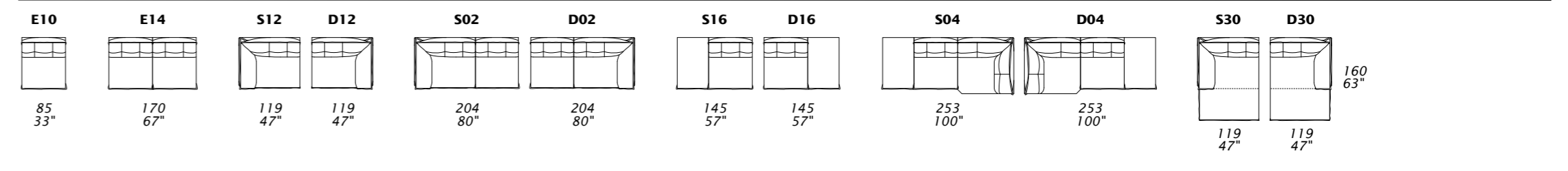

J all items in group J have the same seat width – tutti gli elementi del gruppo J hanno lo stesso modulo di seduta

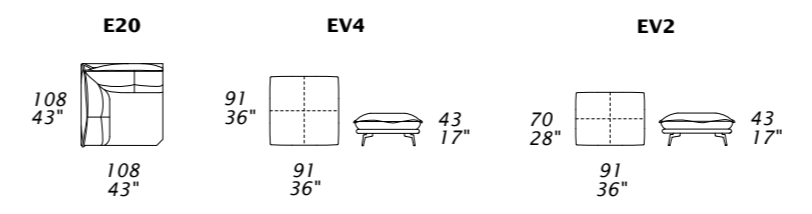
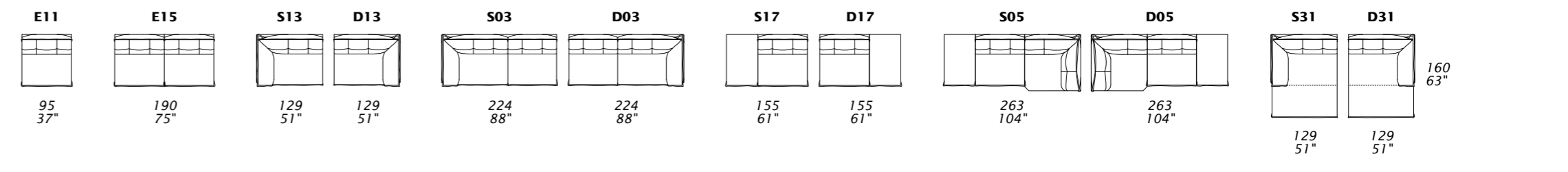

Dimensions: the first figure shows sizes in centimeters, the second in inches. The soft rim (2,5 cm/1 inch) is not included in measures. Each piece is made by hand and has its own uniqueness. Measures may vary with a tolerance up to 3%. Mixing above groups (X - Y - J) will create sectionals with different seat widths. Corner piece E20 is an odd piece and can be used with all above groups X - Y - J. Seat depth 60 cm - 24".

JACK

Design Giuseppe Viganò

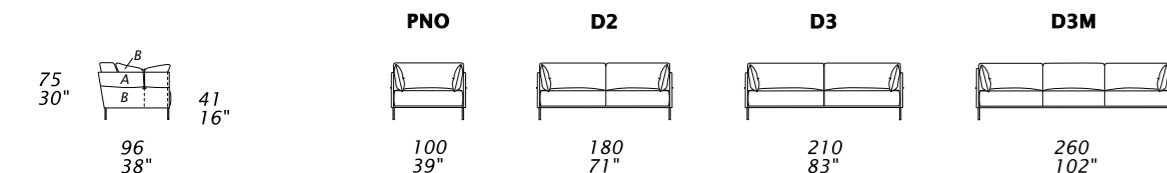

X

all items in group X have the same seat width – tutti gli elementi del gruppo X hanno lo stesso modulo di seduta

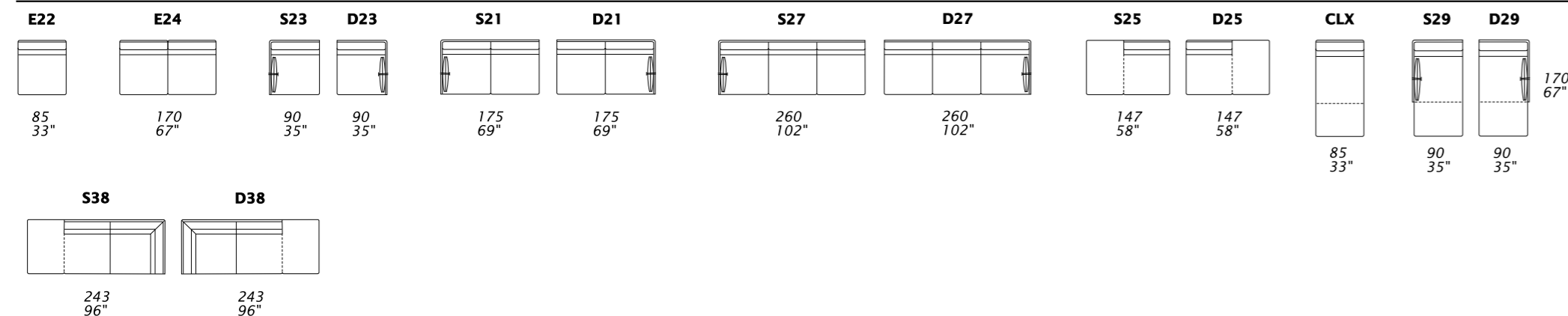

J

all items in group J have the same seat width – tutti gli elementi del gruppo J hanno lo stesso modulo di seduta

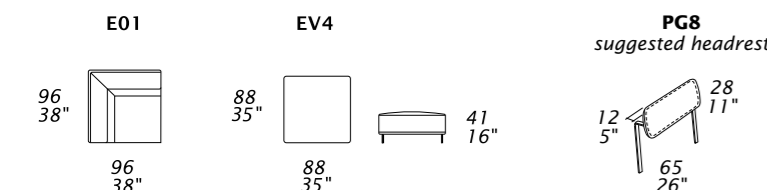
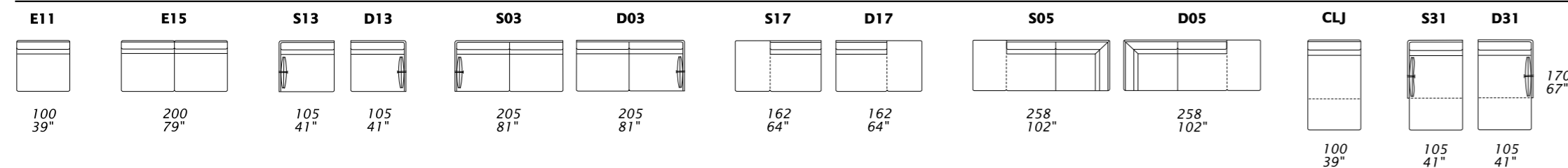

Dimensions: the first figure shows sizes in centimeters, the second in inches.
 Each piece is made by hand and has its own uniqueness. Measures may vary with a tolerance up to 3%.
 Mixing above groups (X - J) will create sectionals with different seat widths.
 Corner piece E01 is an odd piece and can be used with all above groups X - J.
 Seat depth 62 cm - 24".

Technical sheet

KARL

Design Giuseppe Viganò

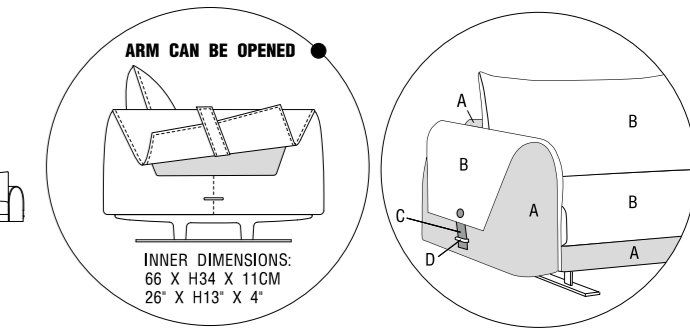
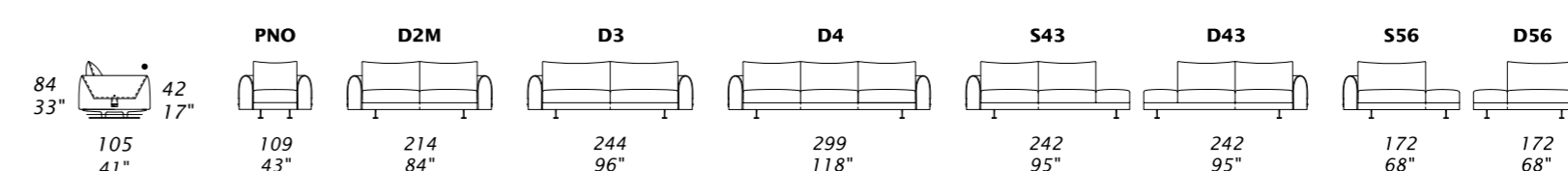

Y

all items in group Y have the same seat width – tutti gli elementi del gruppo Y hanno lo stesso modulo di seduta

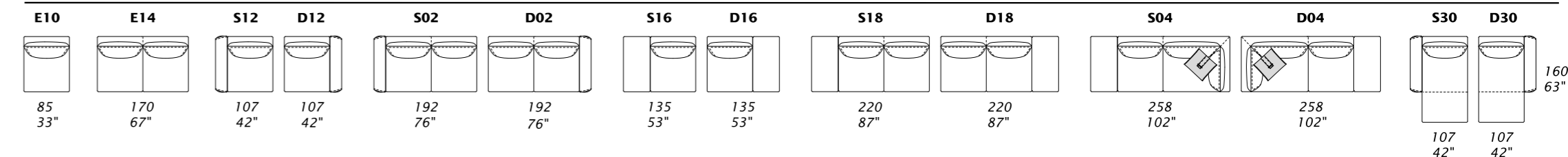

J

all items in group J have the same seat width – tutti gli elementi del gruppo J hanno lo stesso modulo di seduta

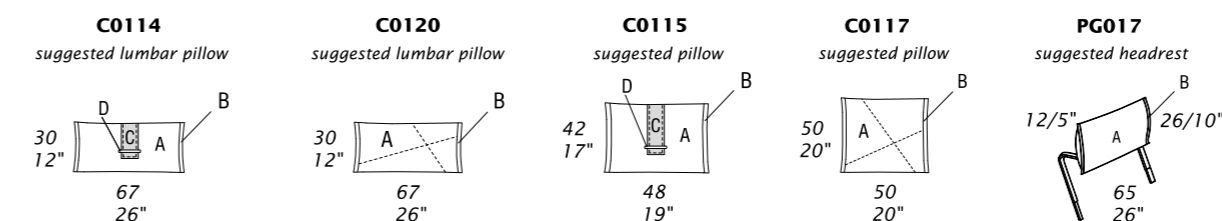
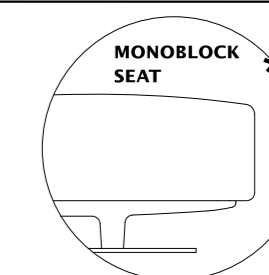
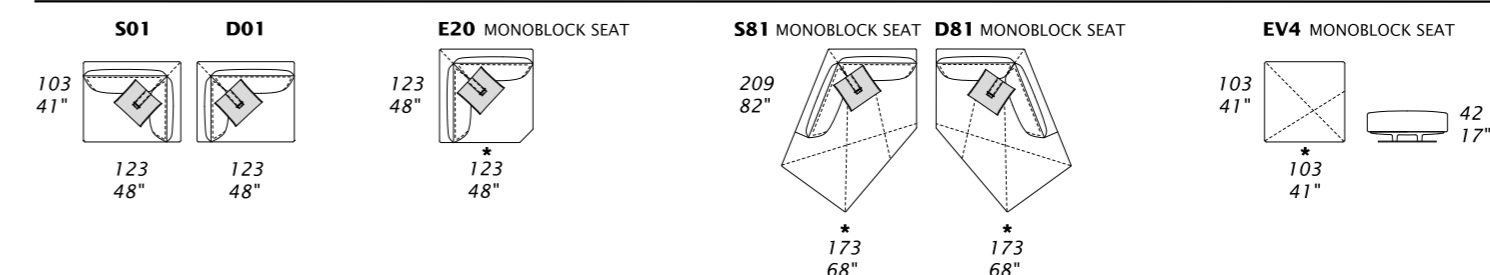
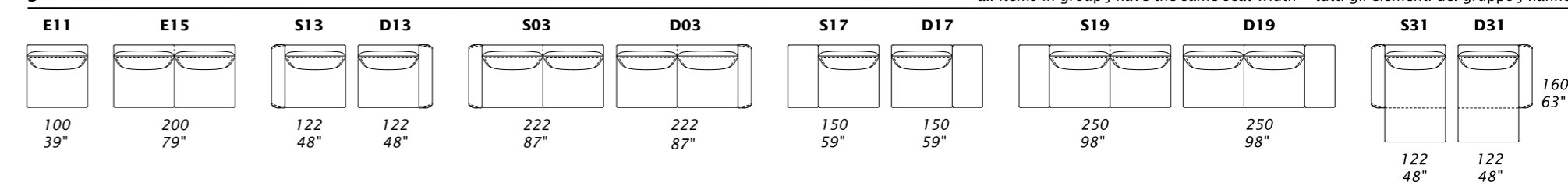

_ THE PART B OF THE PILLOWS IS AVAILABLE IN: CUC 501C AND CUC 510B SPECIAL STITCHINGS

Dimensions: the first figure shows sizes in centimeters, the second in inches.
 Each piece is made by hand and has its own uniqueness. Measures may vary with a tolerance up to 3%.
 Mixing above groups (Y - J) will create sectionals with different seat widths.
 Corner pieces S01/D01, E20 and S81/D81 are odd pieces and can be used with all above groups Y - J.
 Seat depth 60 cm - 24".

Technical sheet

KONG

Design Giuseppe Viganò

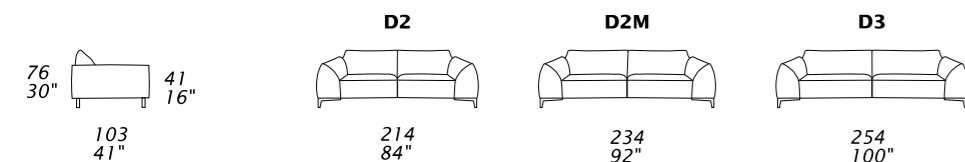

X all items in group X have the same seat width – tutti gli elementi del gruppo X hanno lo stesso modulo di seduta

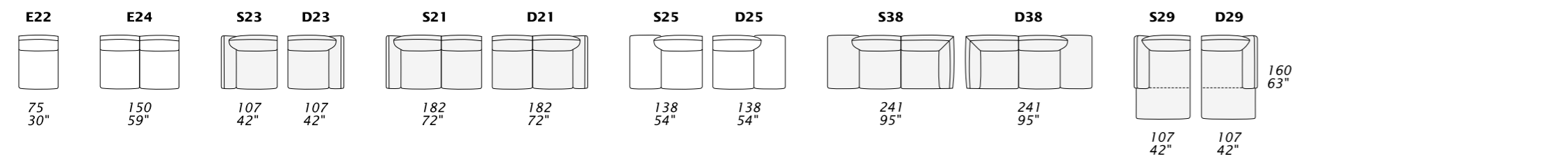

Y all items in group Y have the same seat width – tutti gli elementi del gruppo Y hanno lo stesso modulo di seduta

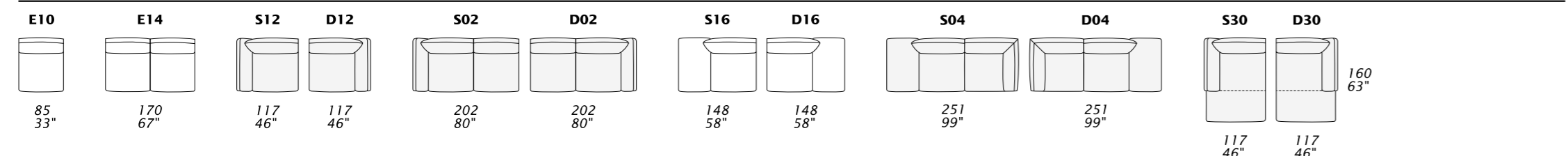

J all items in group J have the same seat width – tutti gli elementi del gruppo J hanno lo stesso modulo di seduta

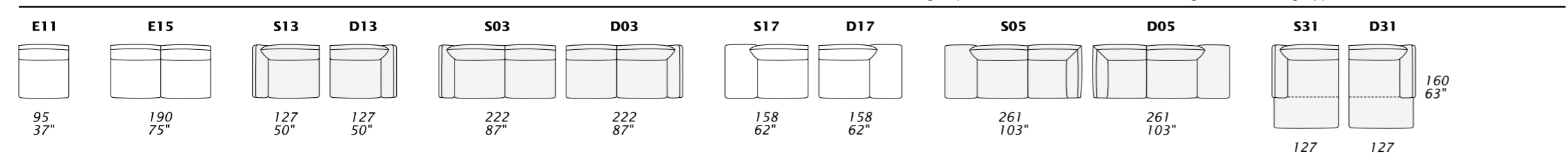

S56 259 102"
D56 259 102"

Standard back

Back cushions with wings

When the following sectional elements are ordered together with S56/D56, the back cushion will be produced with a wing on the side, as shown in the pricelist picture.

S/D23 - S/D21 - S/D38 - S/D29 - S/D12 - S/D02 - S/D04
S/D30 - S/D13 - S/D03 - S/D05 - S/D31

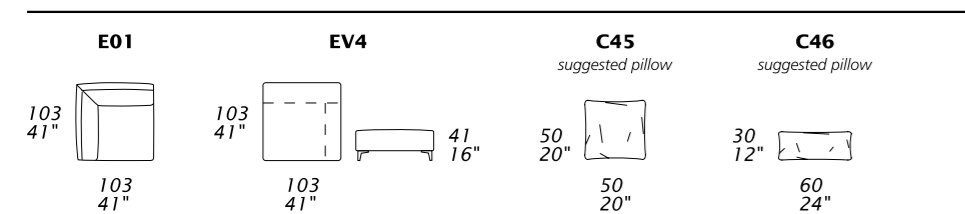

Dimensions: the first figure shows sizes in centimeters, the second in inches.
Each piece is made by hand and has its own uniqueness. Measures may vary with a tolerance up to 3%.
Mixing above groups (X - Y - J) will create sectionals with different seat widths.
Corner piece E01 is an odd piece and can be used with all above groups X - Y - J.
Seat depth 64 cm - 25".

LIMOUSINE

Design Giuseppe Viganò

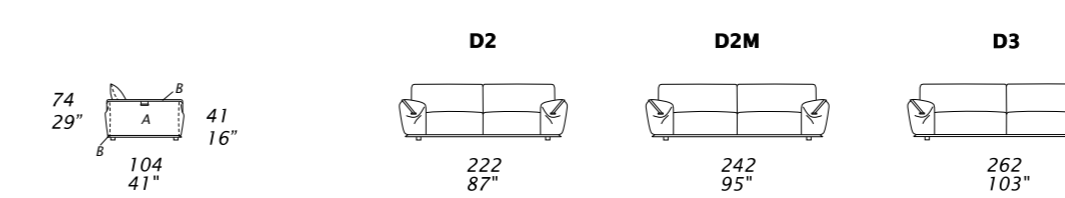

X all items in group X have the same seat width – tutti gli elementi del gruppo X hanno lo stesso modulo di seduta

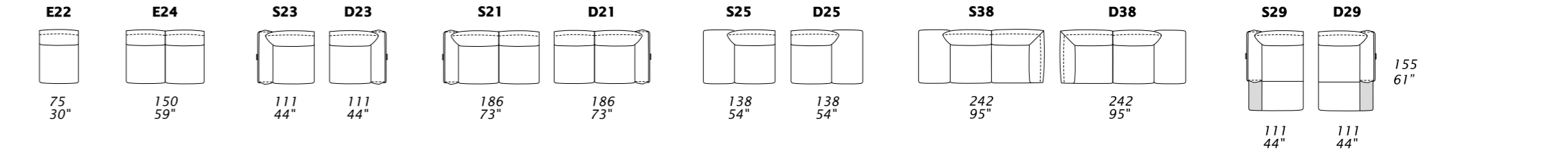

Y all items in group Y have the same seat width – tutti gli elementi del gruppo Y hanno lo stesso modulo di seduta

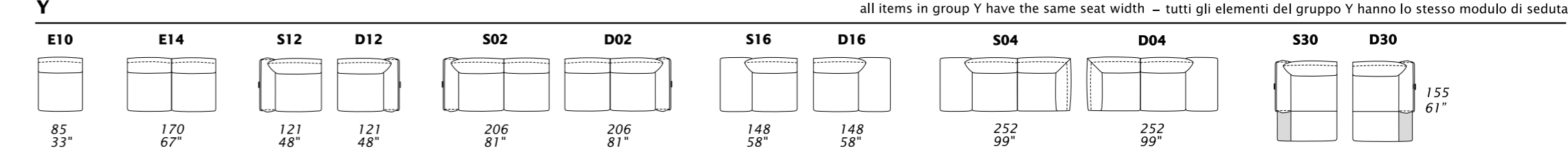

J all items in group J have the same seat width – tutti gli elementi del gruppo J hanno lo stesso modulo di seduta

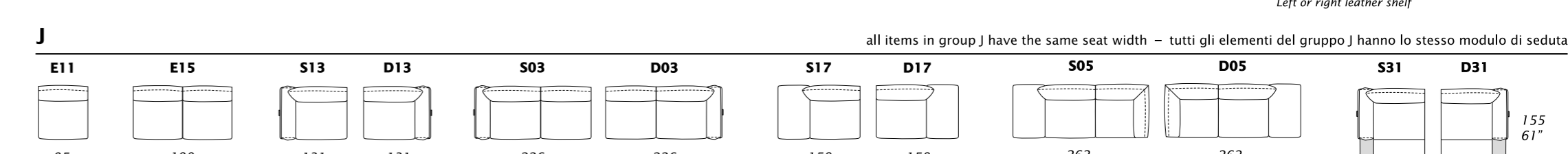

S56 259 102"
D56 259 102"

Standard back

Back cushions with wings

When the following sectional elements are ordered together with S56/D56, the back cushion will be produced with a wing on the side, as shown in the pricelist picture.

S/D23 - S/D21 - S/D38 - S/D29 - S/D12 - S/D02 - S/D04
S/D30 - S/D13 - S/D03 - S/D05 - S/D31

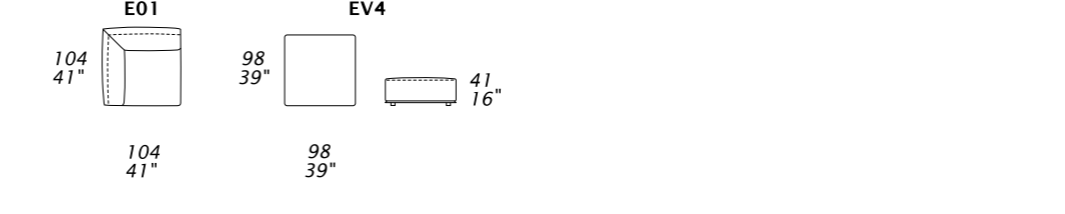

Dimensions: the first figure shows sizes in centimeters, the second in inches.
Each piece is made by hand and has its own uniqueness. Measures may vary with a tolerance up to 3%.
Mixing above groups (X - Y - J) will create sectionals with different seat widths.
Corner piece E01 is an odd piece and can be used with all above groups X - Y - J.
Seat depth 64 cm - 25".

MARLON

Design Giuseppe Viganò

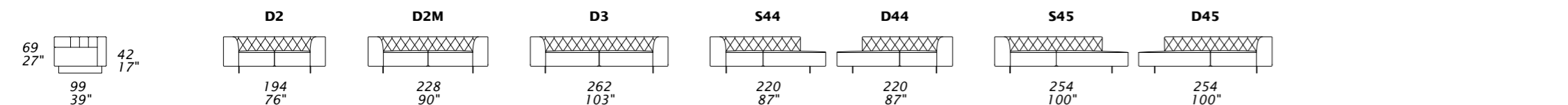

X all items in group X have the same seat width – tutti gli elementi del gruppo X hanno lo stesso modulo di seduta

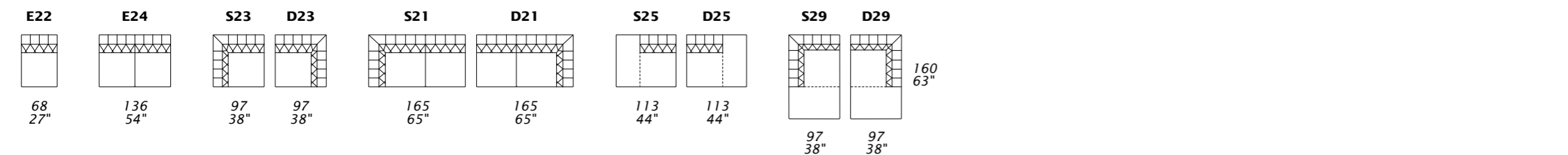

Y all items in group Y have the same seat width – tutti gli elementi del gruppo Y hanno lo stesso modulo di seduta

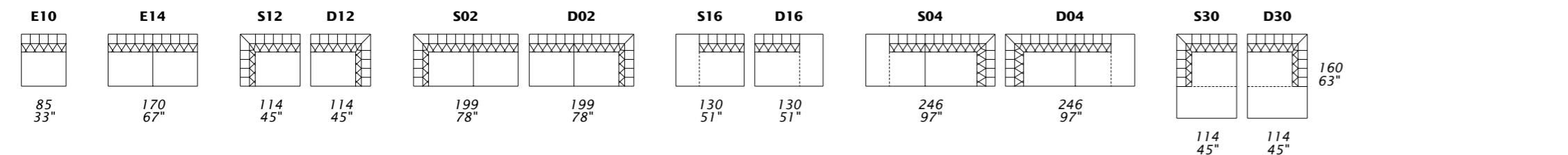

J all items in group J have the same seat width – tutti gli elementi del gruppo J hanno lo stesso modulo di seduta

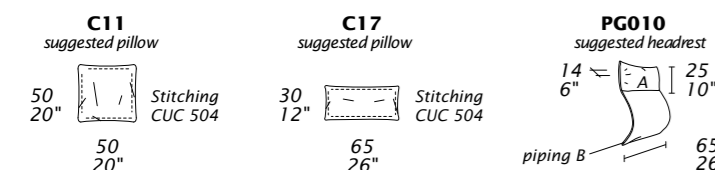
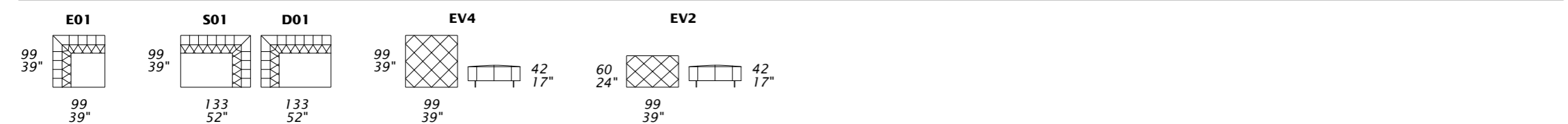
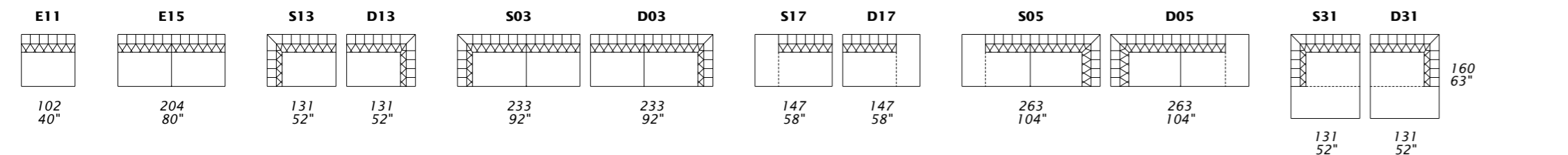

Dimensions: the first figure shows sizes in centimeters, the second in inches.
 Each piece is made by hand and has its own uniqueness. Measures may vary with a tolerance up to 3%.
 Mixing above groups (X - Y - J) will create sectionals with different seat widths.
 Corner pieces E01, S01/D01 are odd pieces and can be used with all above groups X - Y - J.
 Seat depth 65 cm - 26".

McQUEEN

Design Giuseppe Viganò

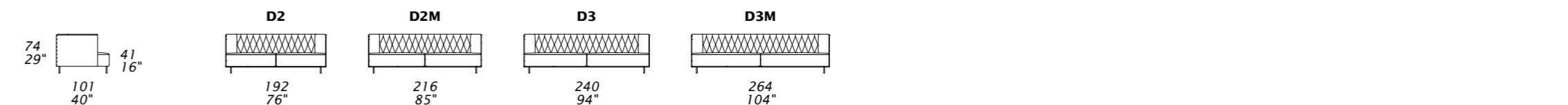

X all items in group X have the same seat width – tutti gli elementi del gruppo X hanno lo stesso modulo di seduta

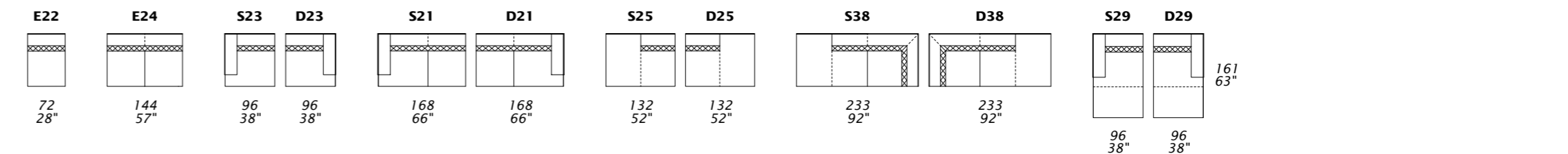

Y all items in group Y have the same seat width – tutti gli elementi del gruppo Y hanno lo stesso modulo di seduta

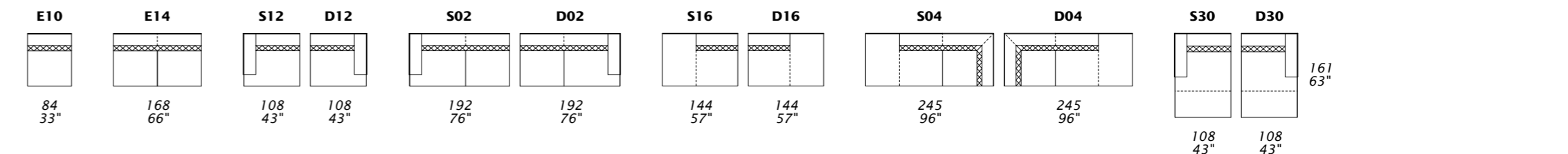

J all items in group J have the same seat width – tutti gli elementi del gruppo J hanno lo stesso modulo di seduta

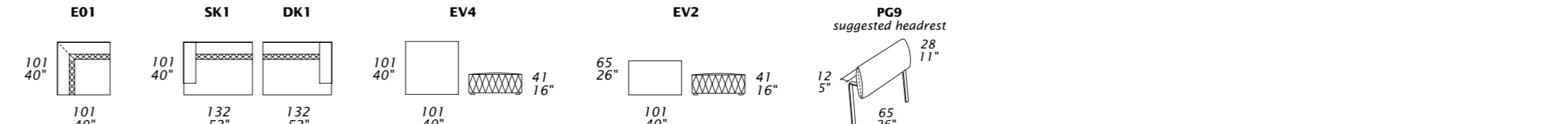
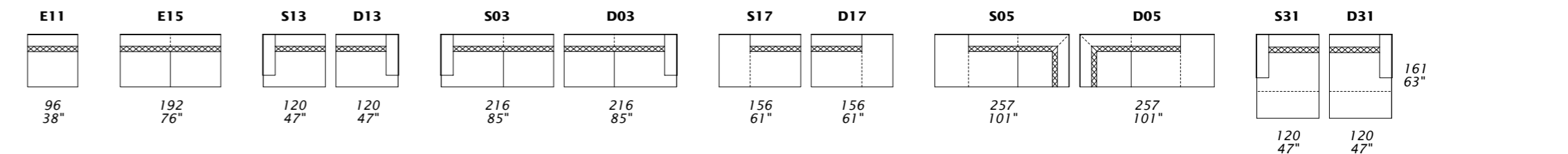

Dimensions: the first figure shows sizes in centimeters, the second in inches.
 Each piece is made by hand and has its own uniqueness. Measures may vary with a tolerance up to 3%.
 Mixing above groups (X - Y - J) will create sectionals with different seat widths.
 Corner piece E01 is an odd piece and can be used with all above groups X - Y - J.
 Seat depth 63 cm - 25".

PUZZLE

Design Giuseppe Viganò

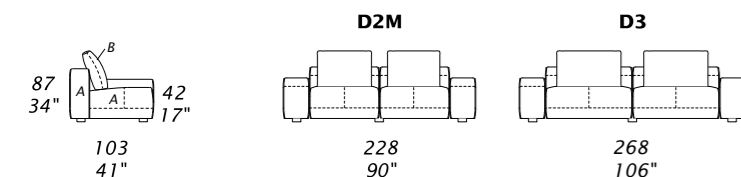

Y all items in group Y have the same seat width – tutti gli elementi del gruppo Y hanno lo stesso modulo di seduta

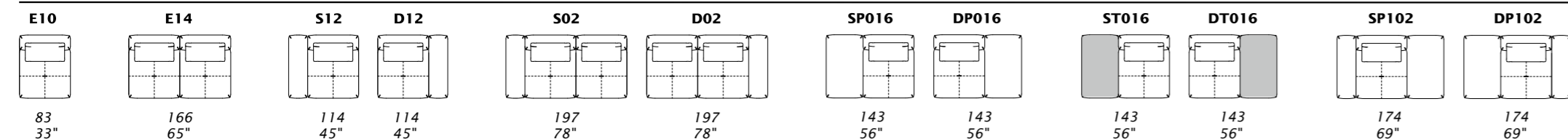

left or right glass, ceramic, marble table

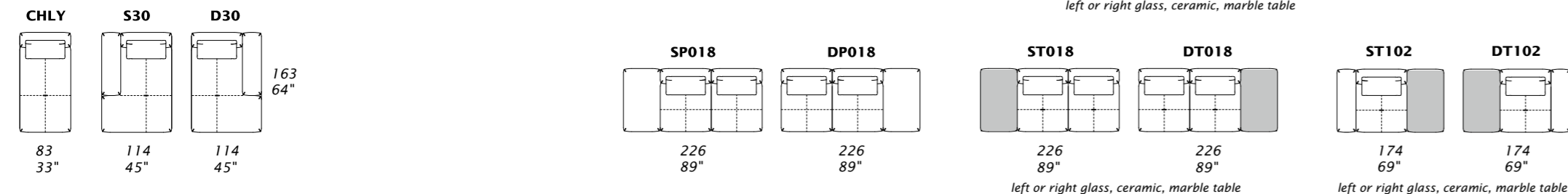

left or right glass, ceramic, marble table

left or right glass, ceramic, marble table

EVY SECTIONAL CENTRAL AND FREESTANDING ELEMENT



RECTANGULAR CORNER

ELEMENTS WITHOUT BACK FRAME

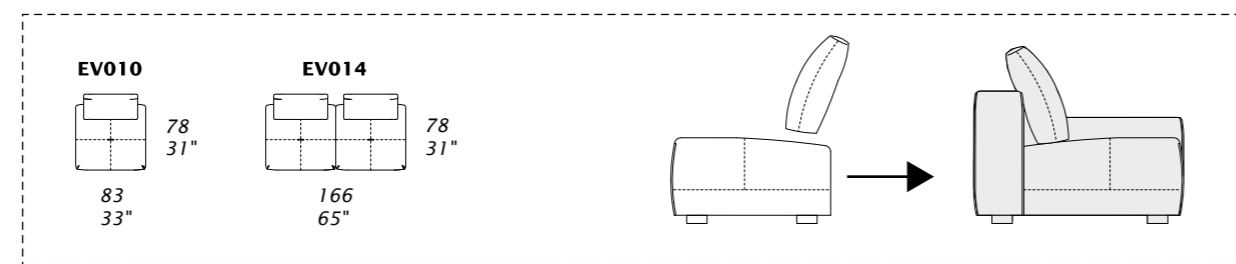

PUZZLE

Design Giuseppe Viganò

J all items in group J have the same seat width – tutti gli elementi del gruppo J hanno lo stesso modulo di seduta

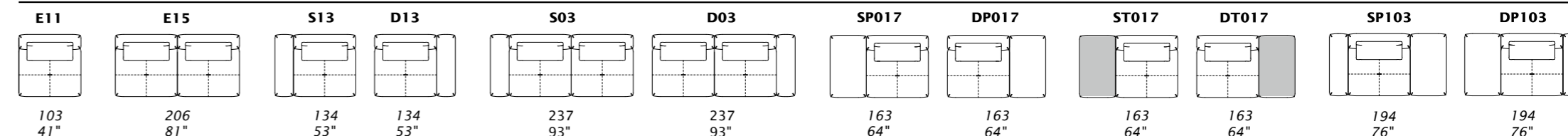

left or right glass, ceramic, marble table

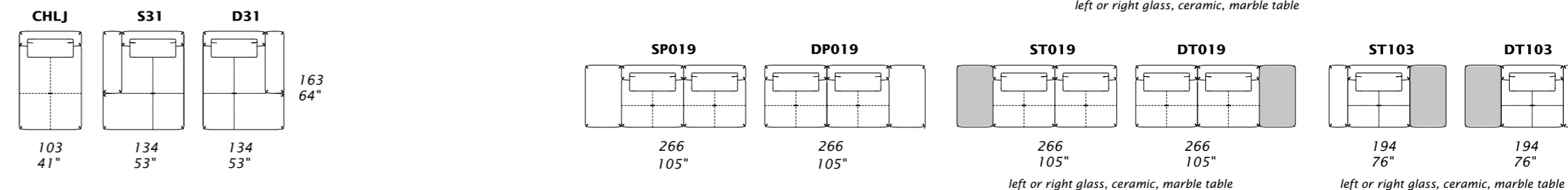

left or right glass, ceramic, marble table

left or right glass, ceramic, marble table

EVJ SECTIONAL CENTRAL AND FREESTANDING ELEMENT



RECTANGULAR CORNER

ELEMENTS WITHOUT BACK FRAME

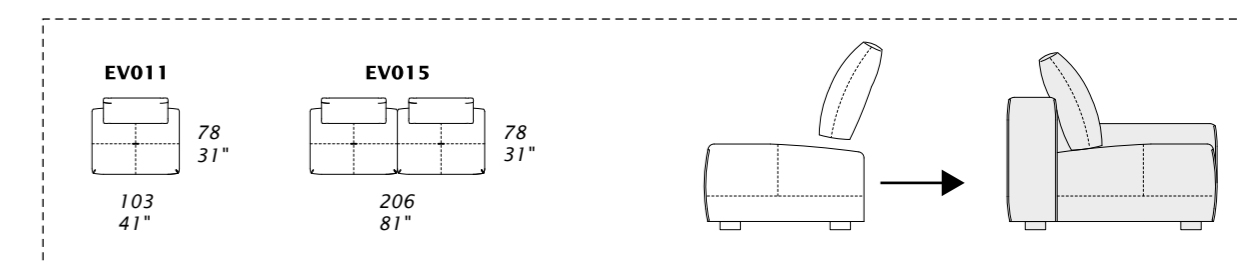

EV4 FREESTANDING

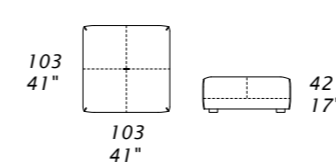

EV5 SECTIONAL CORNER ELEMENT

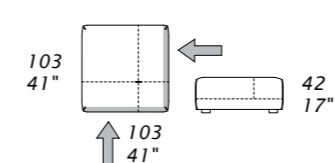

EV7 SECTIONAL CENTRAL AND CORNER ELEMENT

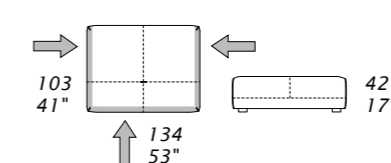

C0123
suggested pillow

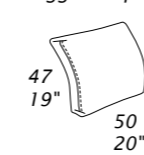

C0124
suggested back cushion

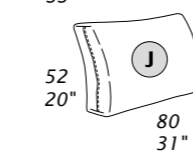

C0125
suggested back cushion

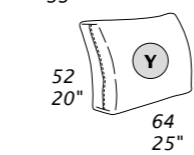

Dimensions: the first figure shows sizes in centimeters, the second in inches.
Each piece is made by hand and has its own uniqueness. Measures may vary with a tolerance up to 3%.
Mixing above groups (Y - J) will create sectionals with different seat widths.
Corner pieces S01/D01 are odd pieces and can be used with all above groups Y - J.
Seat depth 57 cm - 22".

Technical sheet

Dimensions: the first figure shows sizes in centimeters, the second in inches.
Each piece is made by hand and has its own uniqueness. Measures may vary with a tolerance up to 3%.
Mixing above groups (Y - J) will create sectionals with different seat widths.
Corner pieces S01/D01 are odd pieces and can be used with all above groups Y - J.
Seat depth 57 cm - 22".

Technical sheet

RENEGADE

Design Giuseppe Viganò

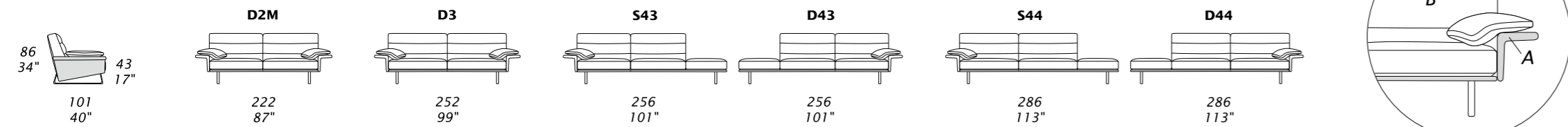

Y all items in group Y have the same seat width – tutti gli elementi del gruppo Y hanno lo stesso modulo di seduta

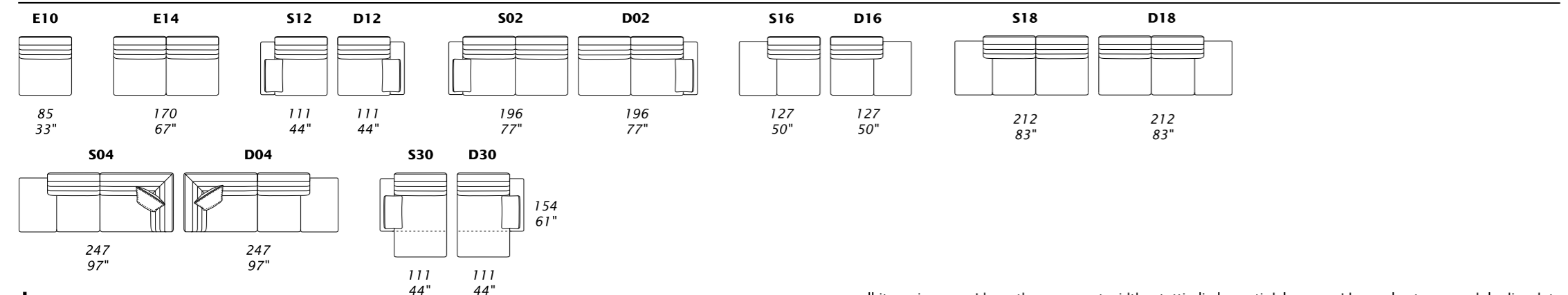

J all items in group J have the same seat width – tutti gli elementi del gruppo J hanno lo stesso modulo di seduta

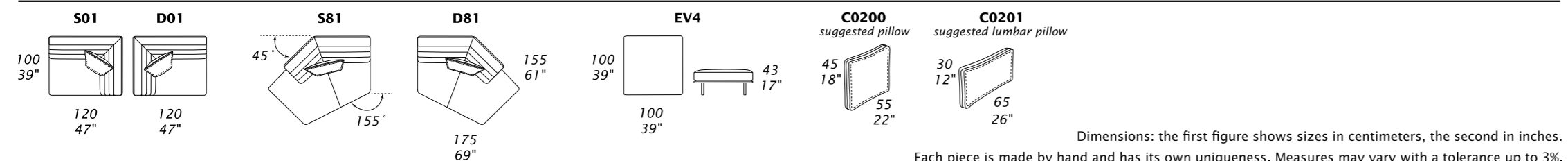
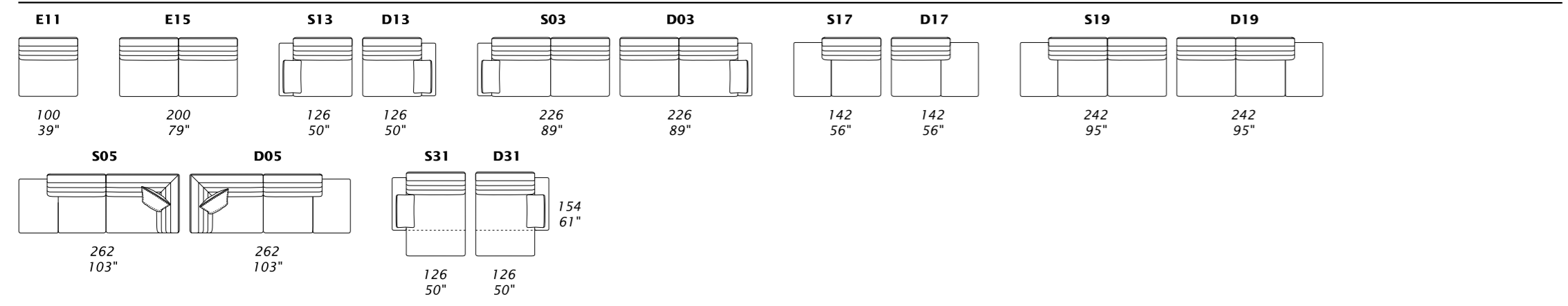

Dimensions: the first figure shows sizes in centimeters, the second in inches.
Each piece is made by hand and has its own uniqueness. Measures may vary with a tolerance up to 3%.
Mixing above groups (Y - J) will create sectionals with different seat widths.
Corner pieces S01/D01 and S81/D81 are odd pieces and can be used with all above groups Y - J.
Seat depth 62 cm - 24".

Technical sheet

VESSEL

Design Giuseppe Viganò

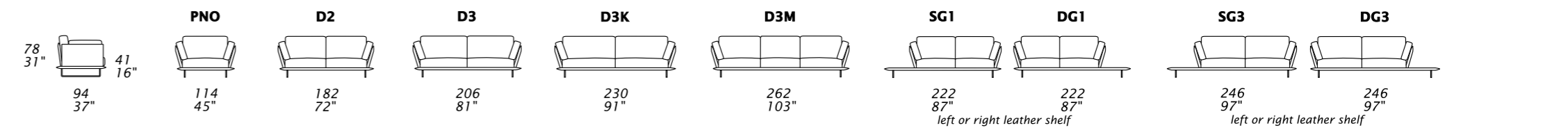

X all items in group X have the same seat width – tutti gli elementi del gruppo X hanno lo stesso modulo di seduta

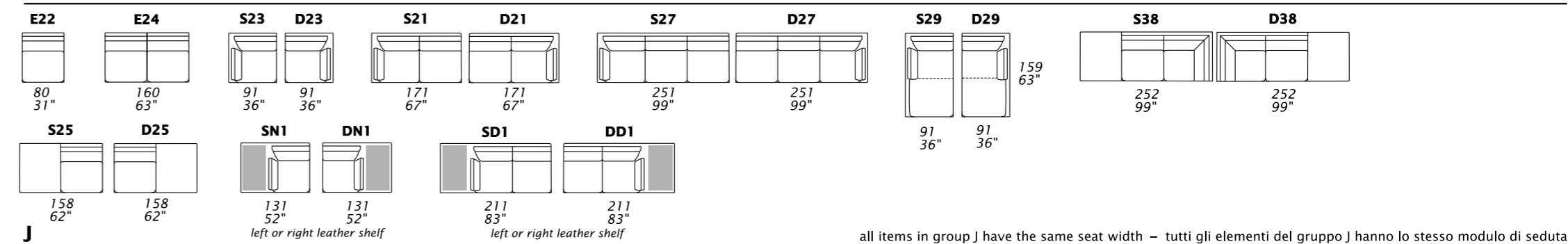

J all items in group J have the same seat width – tutti gli elementi del gruppo J hanno lo stesso modulo di seduta

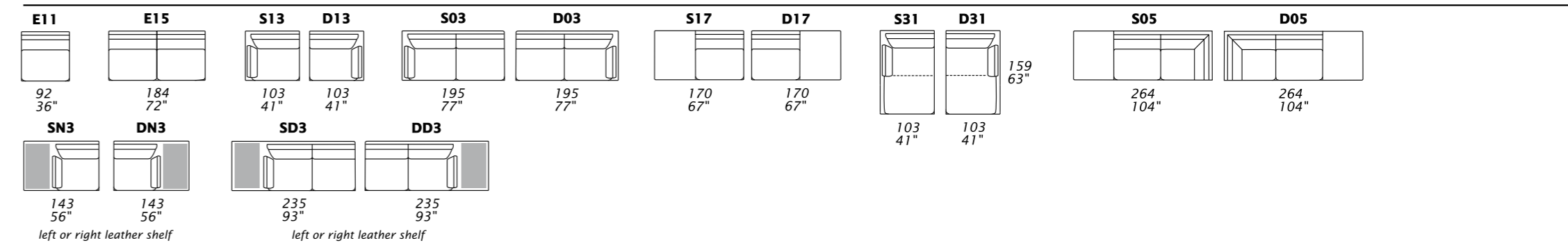

K all items in group K have the same seat width – tutti gli elementi del gruppo K hanno lo stesso modulo di seduta

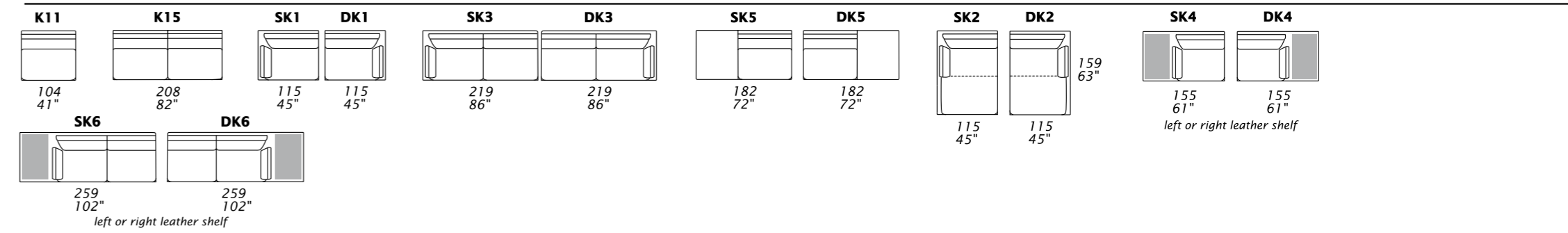

Dimensions: the first figure shows sizes in centimeters, the second in inches.
Each piece is made by hand and has its own uniqueness. Measures may vary with a tolerance up to 3%.
Mixing above groups (X - J - K) will create sectionals with different seat widths.
Corner piece E01 is an odd piece and can be used with all above groups X - J - K.
Seat depth 60 cm - 24".

Technical sheet

VINCENT

Design Giuseppe Viganò

FREE STANDING MODULES

- NOTES: - AVAILABLE WITH BOOKRACK BACKREST
- AVAILABLE ONLY WITH FIXED STANDARD UPHOLSTERED ARMREST
- FOR SOFAS WITH BOOKRACK ARMREST, PROCEED BY USING THE MODULES BELONGING TO FAMILY GROUP "X" or "J"

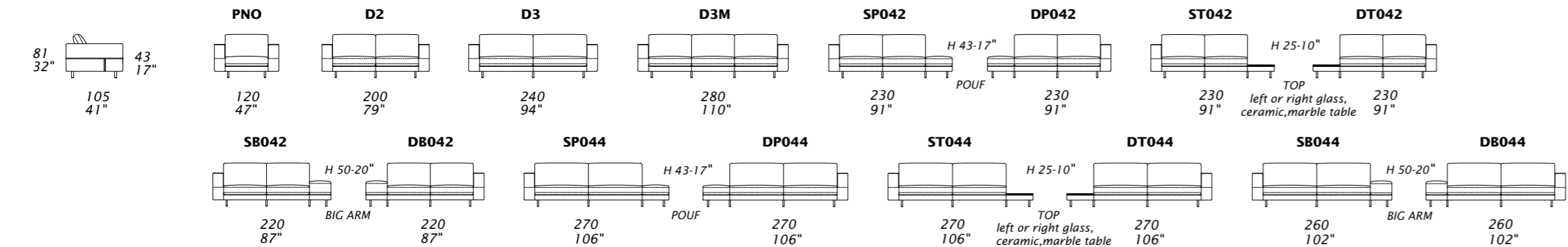

X 80 seat width all items in group X have the same seat width – tutti gli elementi del gruppo X hanno lo stesso modulo di seduta

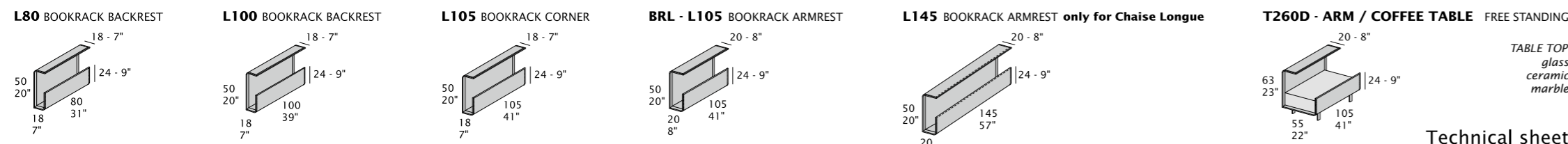
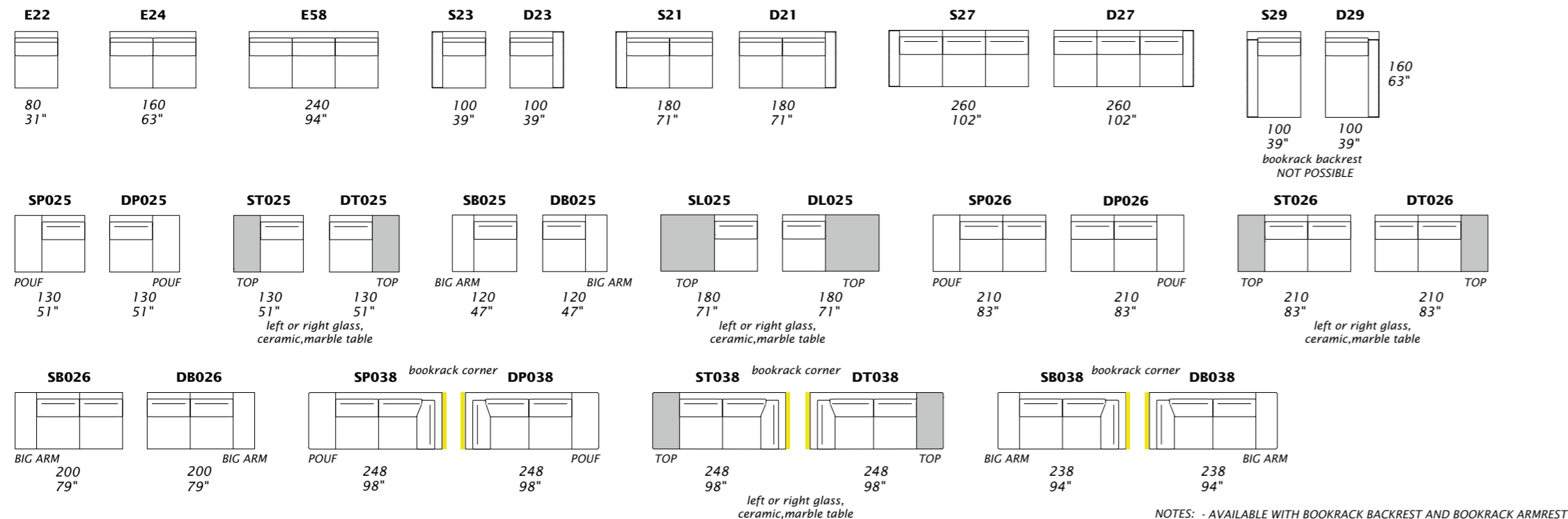

Technical sheet

VINCENT

Design Giuseppe Viganò

J 100 seat width all items in group J have the same seat width – tutti gli elementi del gruppo J hanno lo stesso modulo di seduta

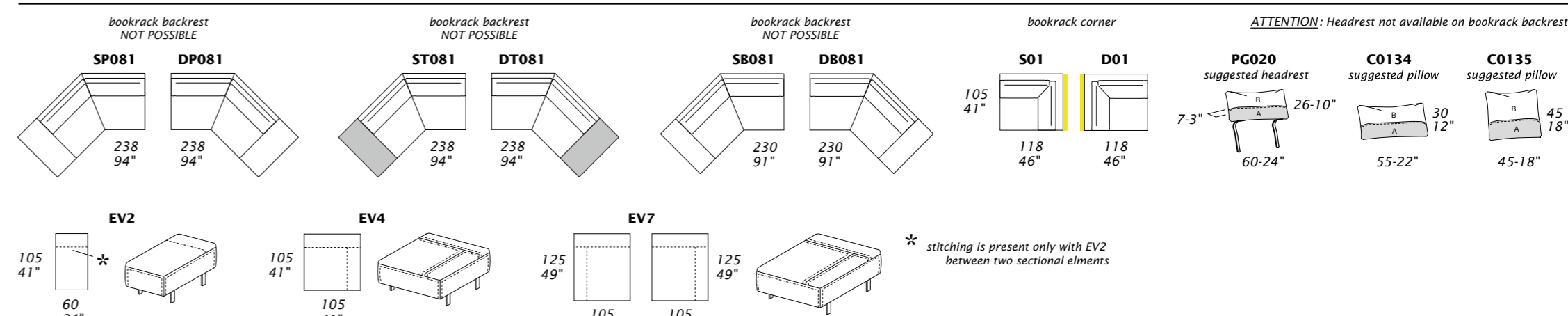
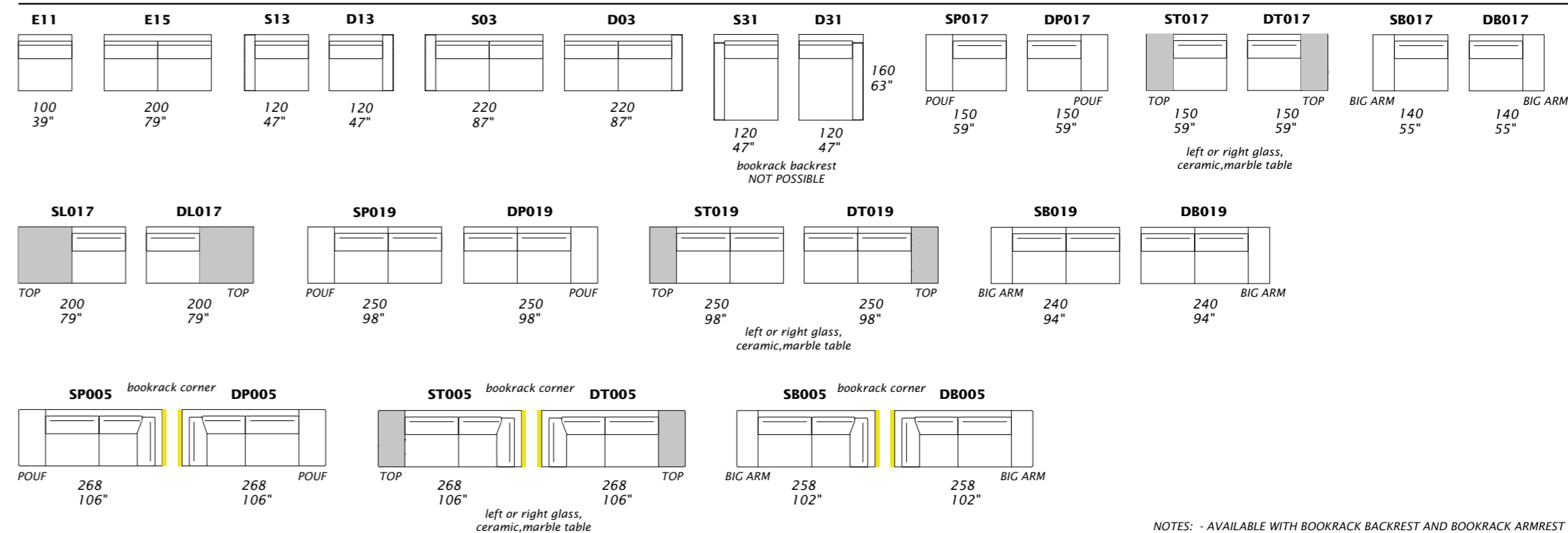

Dimensions: the first figure shows sizes in centimeters, the second in inches.
 Each piece is made by hand and has its own uniqueness. Measures may vary with a tolerance up to 3%.
 Mixing above groups (X - J) will create sectionals with different seat widths.
 Corner pieces S01-D01 and S/DP081, S/DT081 and S/DB081 are odd pieces and can be used with all aboce groups X - J.
 Seat depth 60 cm - 24".

Technical sheet

CHARLOTTE

Design Giuseppe Viganò

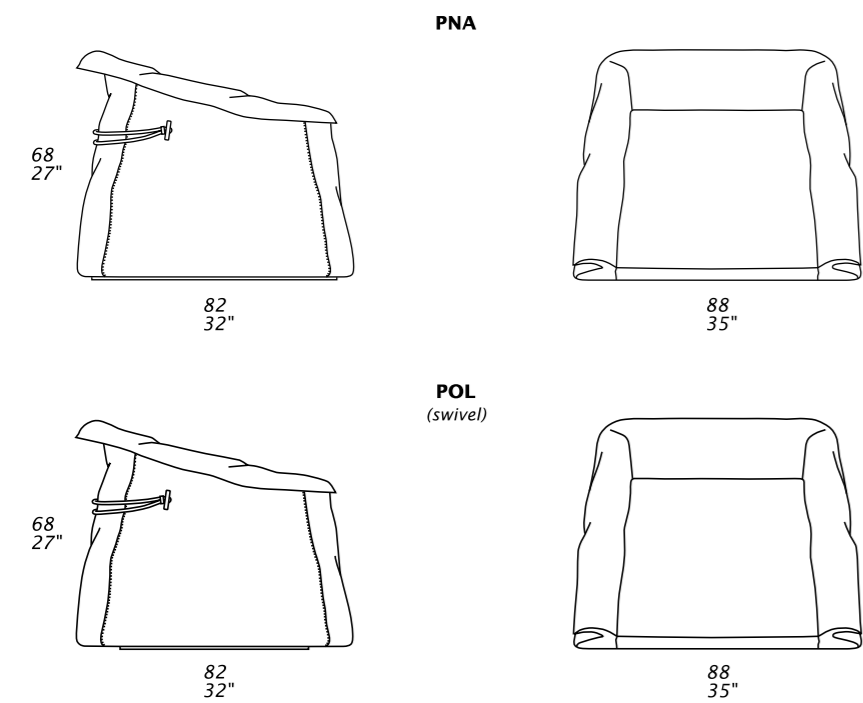
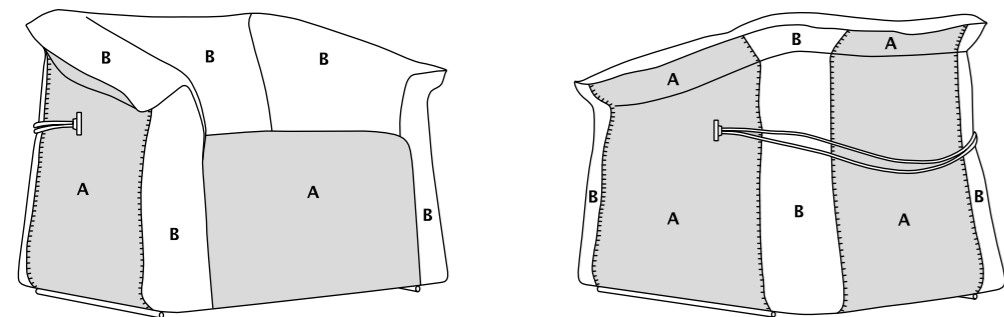

Dimensions: the first figure shows sizes in centimeters, the second in inches.
Each piece is made by hand and has its own uniqueness. Measures may vary with a tolerance up to 3%.
Seat depth 53 cm - 21".
Seat height 39 cm - 15".

Technical sheet

COCOON BERGÈRE

Design Giuseppe Viganò

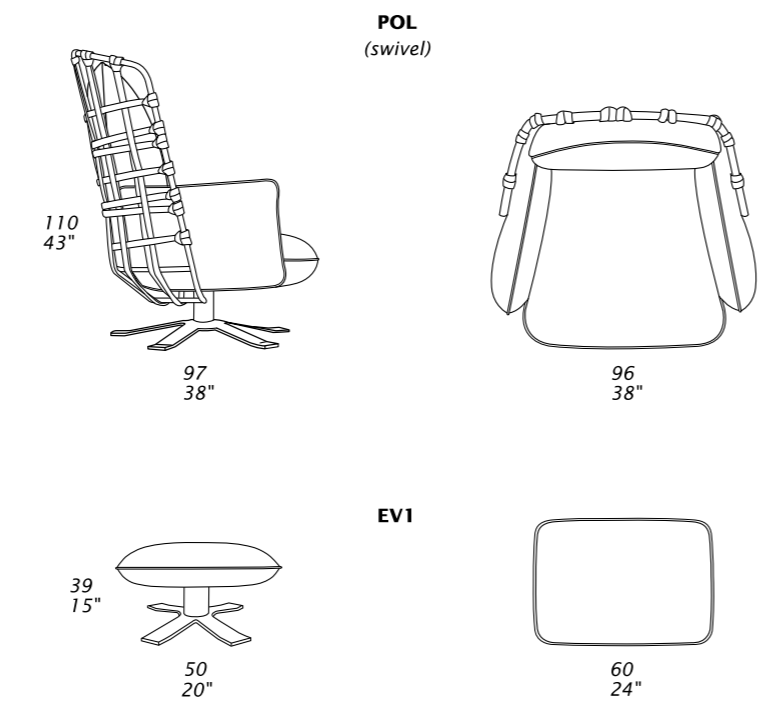
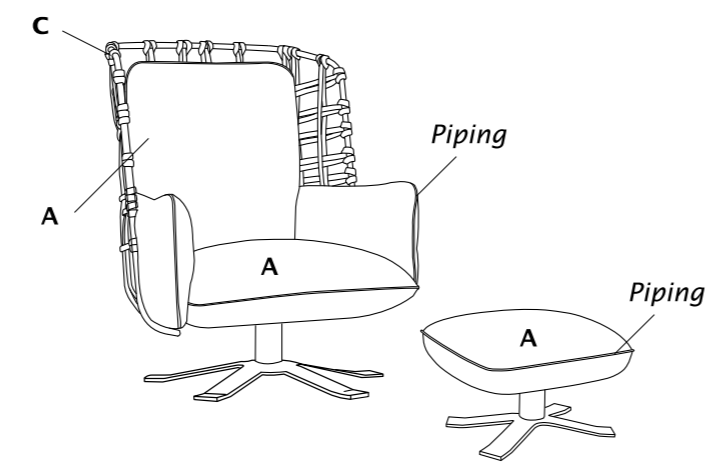

Dimensions: the first figure shows sizes in centimeters, the second in inches.
Each piece is made by hand and has its own uniqueness. Measures may vary with a tolerance up to 3%.
Seat depth 55 cm - 22".
Seat height 43 cm - 17".

Technical sheet

CRUISE

Design Giuseppe Viganò

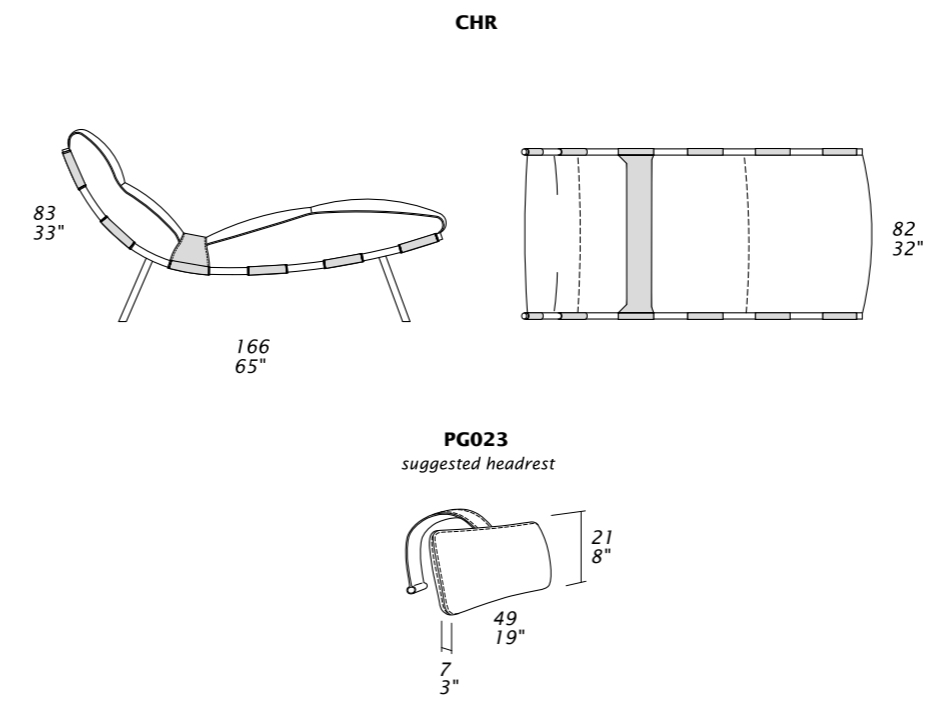
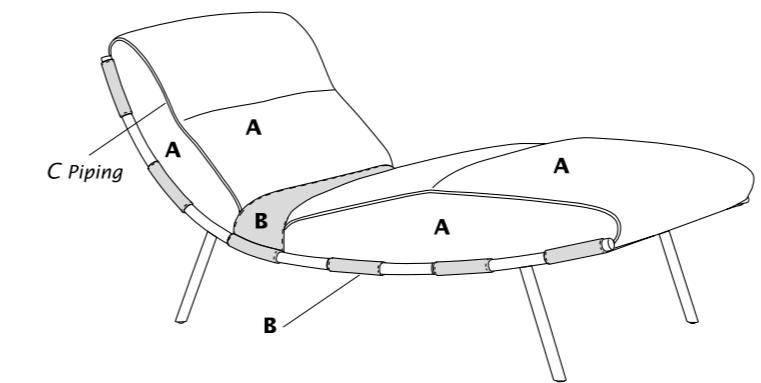

Dimensions: the first figure shows sizes in centimeters, the second in inches.
Each piece is made by hand and has its own uniqueness. Measures may vary with a tolerance up to 3%.
Seat depth 100 cm - 39".
Seat height 53 cm - 21".

Technical sheet

DEAN

Design Giuseppe Viganò

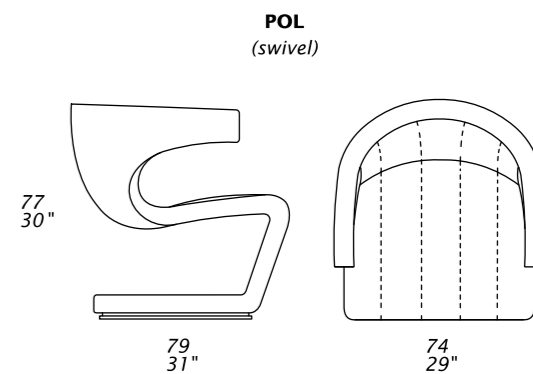
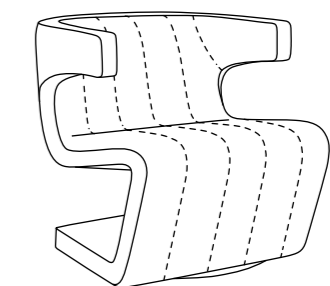

Dimensions: the first figure shows sizes in centimeters, the second in inches.
Each piece is made by hand and has its own uniqueness. Measures may vary with a tolerance up to 3%.
Seat depth 49 cm - 19".
Seat height 44 cm - 17".

Technical sheet

GEM

Design Giuseppe Viganò

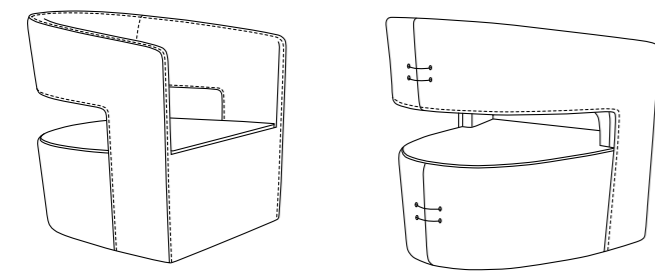

PNA

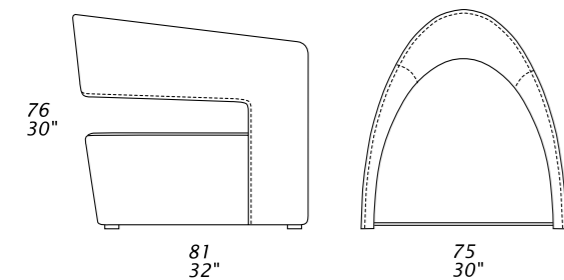

POL
(swivel)

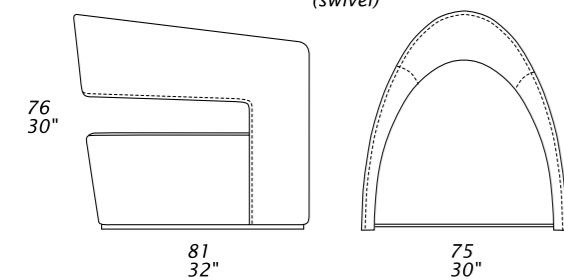

Dimensions: the first figure shows sizes in centimeters, the second in inches.
Each piece is made by hand and has its own uniqueness. Measures may vary with a tolerance up to 3%.
Seat depth 59 cm - 23".
Seat height 40 cm - 16".

Technical sheet

GLOSS

Design Giuseppe Viganò

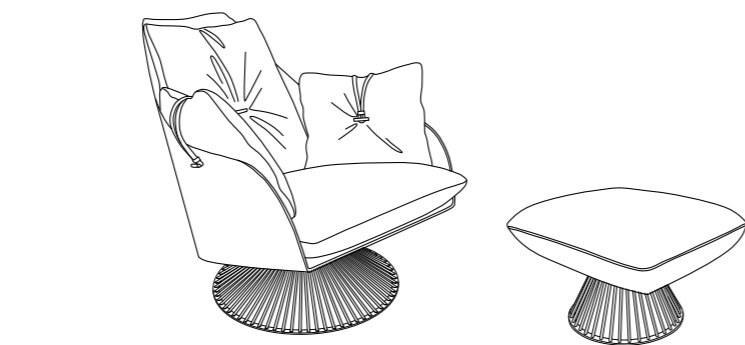

POL
(swivel)

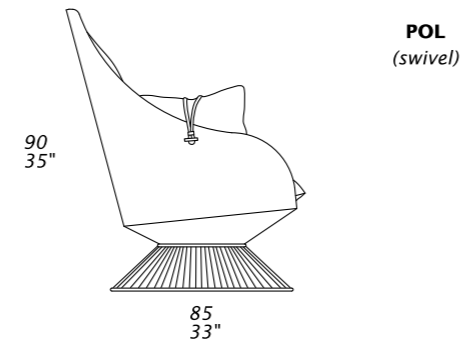

POS
(swivel)

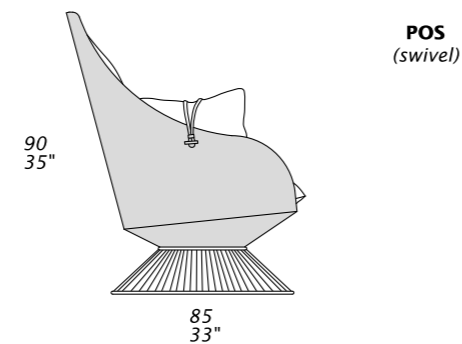

EV1



Dimensions: the first figure shows sizes in centimeters, the second in inches.
Each piece is made by hand and has its own uniqueness. Measures may vary with a tolerance up to 3%.
Seat depth 61 cm - 24".
Seat height 44 cm - 17".

Technical sheet

HARLEY

Design Giuseppe Viganò



POL
(swivel)

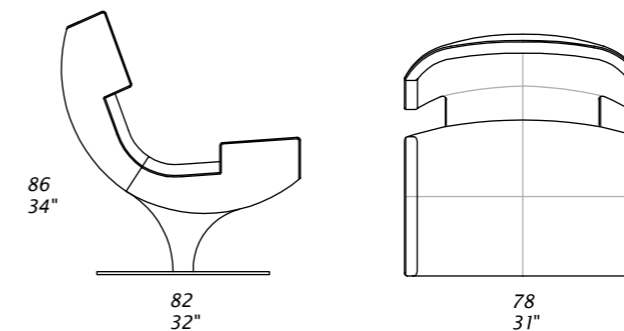

Dimensions: the first figure shows sizes in centimeters, the second in inches.
Each piece is made by hand and has its own uniqueness. Measures may vary with a tolerance up to 3%.
Seat depth 54 cm - 21".
Seat height 41 cm - 16".

Technical sheet

JACKIE

Design Giuseppe Viganò

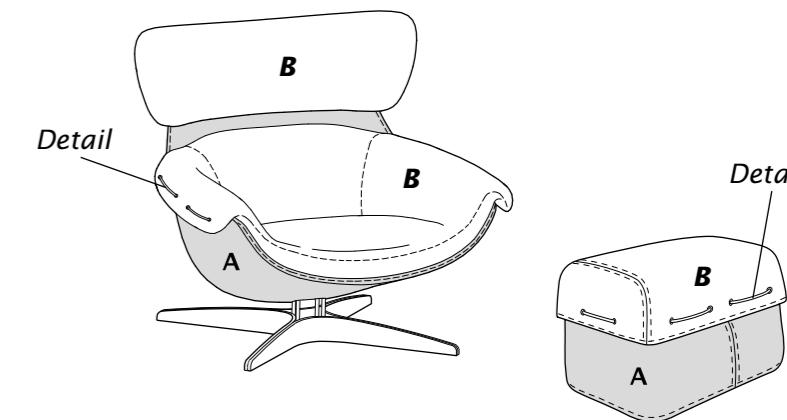

POL
(swivel)

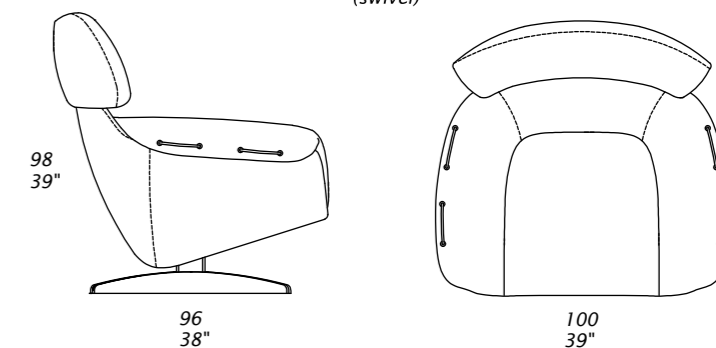

EV1

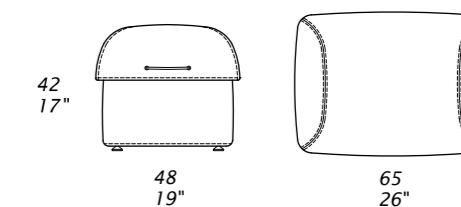

Dimensions: the first figure shows sizes in centimeters, the second in inches.
Each piece is made by hand and has its own uniqueness. Measures may vary with a tolerance up to 3%.
Seat depth 57 cm - 22".
Seat height 44 cm - 17".

Technical sheet

LOBSTER

Design Giuseppe Viganò

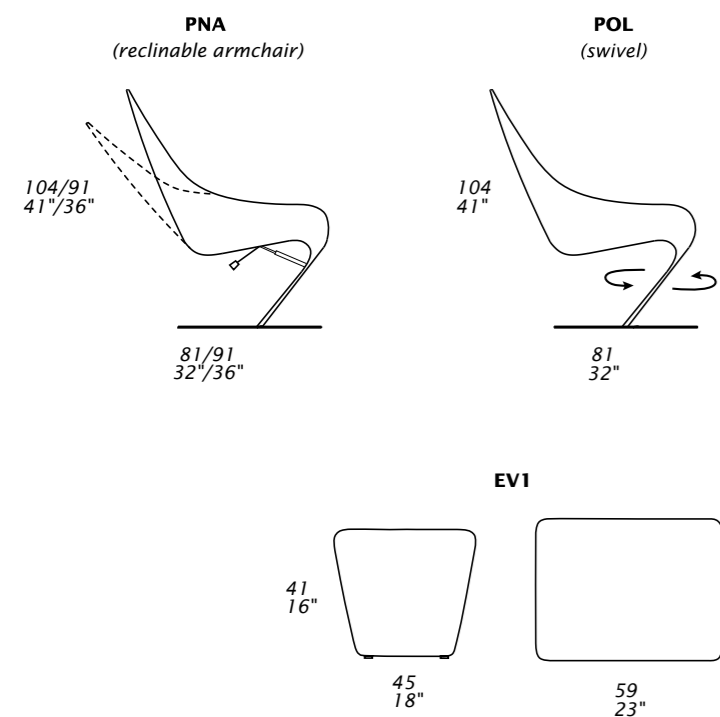
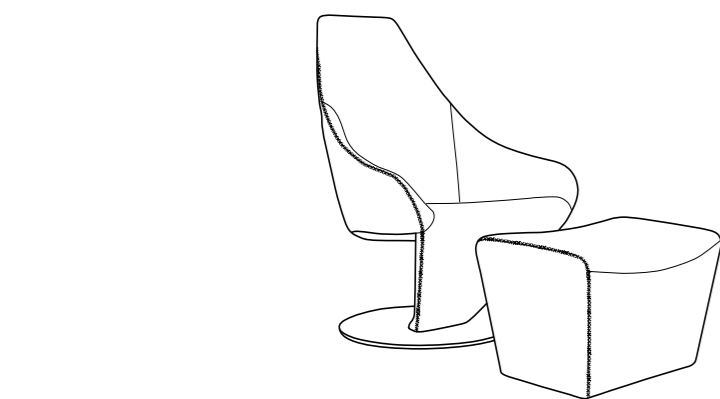

Dimensions: the first figure shows sizes in centimeters, the second in inches.
Each piece is made by hand and has its own uniqueness. Measures may vary with a tolerance up to 3%.
Seat depth 51 cm - 20".
Seat height 42 cm - 17".

Technical sheet

LOLITA

Design Giuseppe Viganò

STANDARD FEATURES
- LEGS AVAILABLE IN PAINTED METAL OR WOOD LEGS
- WOOD LEGS FINISHES: NOCE CANALETTO OR FRASSINO

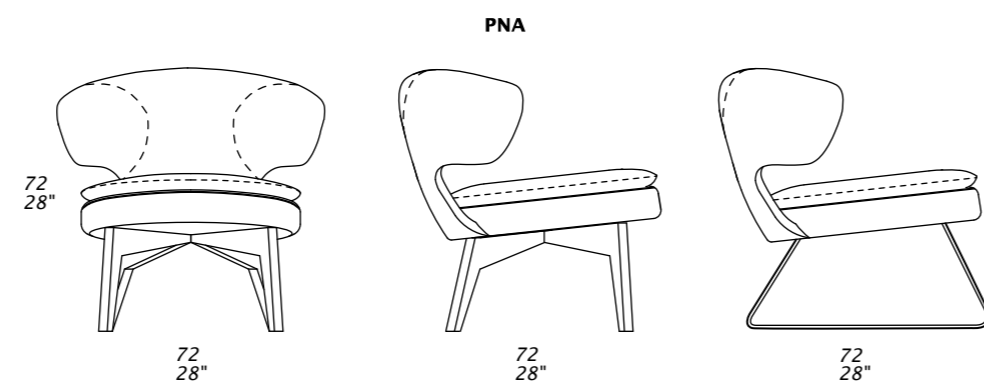
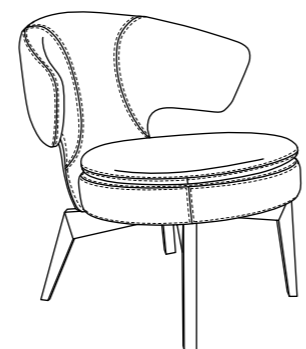

WOOD LEGS FINISHES



Dimensions: the first figure shows sizes in centimeters, the second in inches.
Each piece is made by hand and has its own uniqueness. Measures may vary with a tolerance up to 3%.
Seat depth 57 cm - 22".
Seat height 43 cm - 17".

Technical sheet

LOVE

Design Giuseppe Viganò

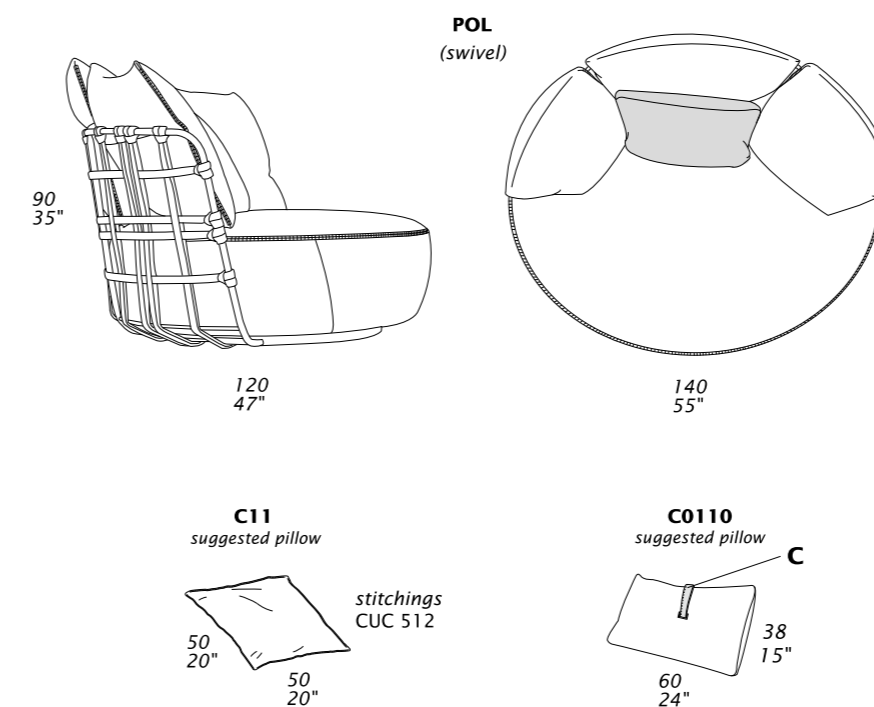
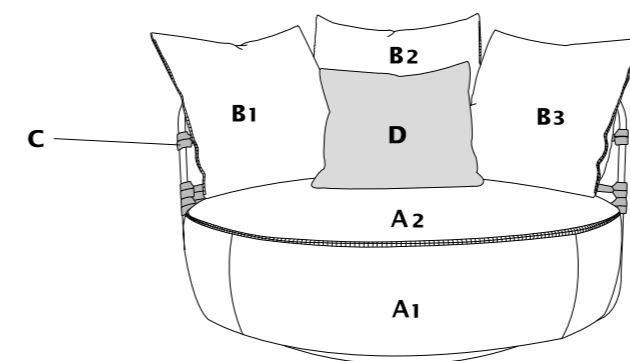

Dimensions: the first figure shows sizes in centimeters, the second in inches.
Each piece is made by hand and has its own uniqueness. Measures may vary with a tolerance up to 3%.
Seat depth 72 cm - 28".
Seat height 42 cm - 17".

Technical sheet

LUNA

Design Giuseppe Viganò

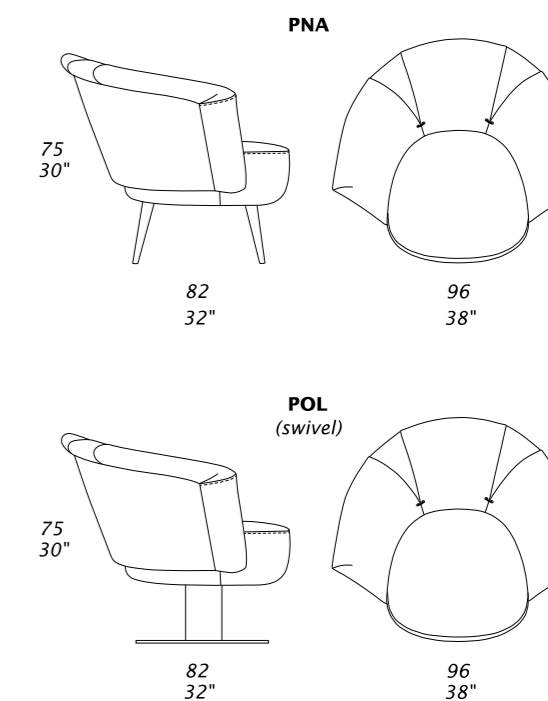
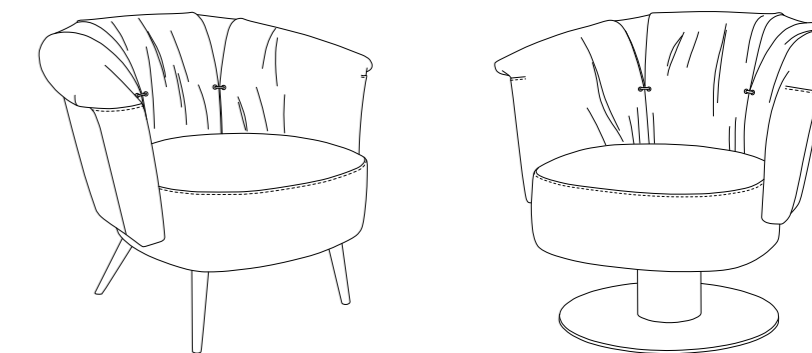

Dimensions: the first figure shows sizes in centimeters, the second in inches.
Each piece is made by hand and has its own uniqueness. Measures may vary with a tolerance up to 3%.
Seat depth 60 cm - 24".
Seat height 45 cm - 18".

Technical sheet

SCARLETT

Design Giuseppe Viganò

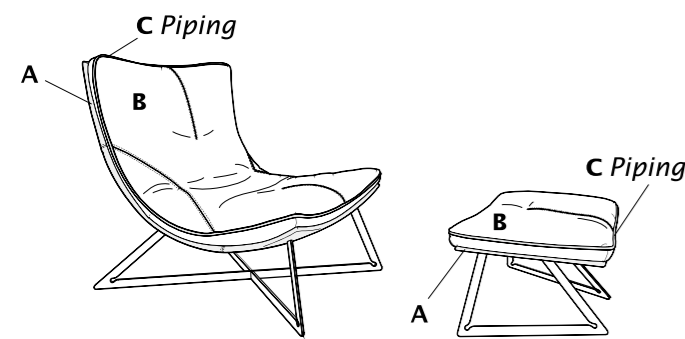

CHS

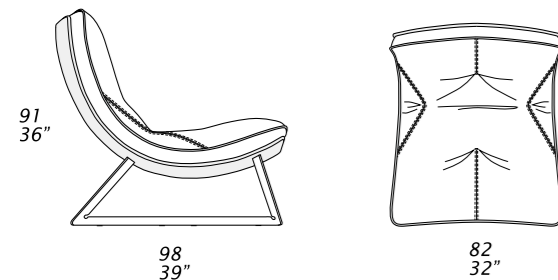

EV2

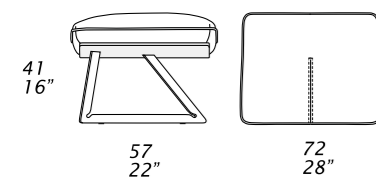

PG013

suggested headrest

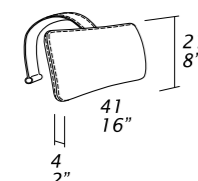

Dimensions: the first figure shows sizes in centimeters, the second in inches.
Each piece is made by hand and has its own uniqueness.
Measures may vary with a tolerance up to 3%.
Seat depth 58 cm - 23".
Seat height 42 cm - 17".

Technical sheet

SPIDER

Design Giuseppe Viganò

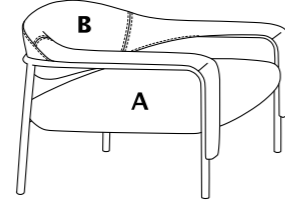

PNA

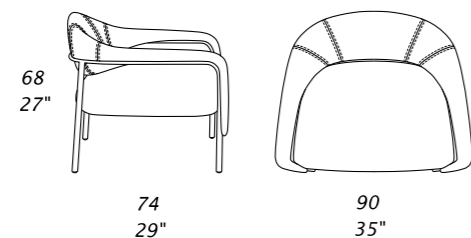

Dimensions: the first figure shows sizes in centimeters, the second in inches.
Each piece is made by hand and has its own uniqueness.
Measures may vary with a tolerance up to 3%.
Seat depth 60 cm - 24".
Seat height 41 cm - 16".

Technical sheet

TRENCH

Design Giuseppe Viganò

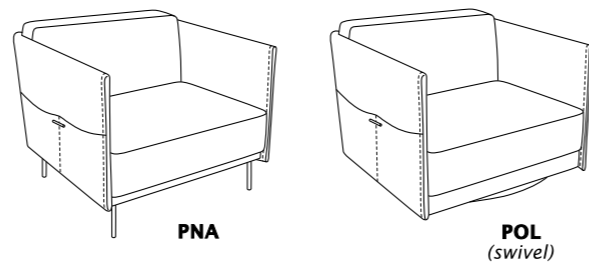

PNA

POL
(swivel)

PNA

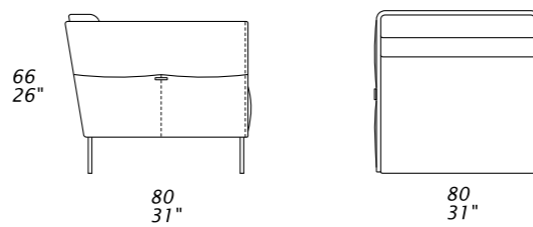

PNA

POL
(swivel)

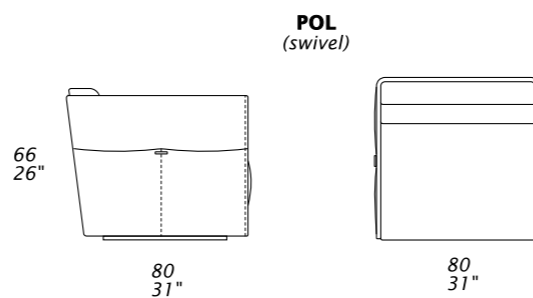

POL
(swivel)

POL
(swivel)

Dimensions: the first figure shows sizes in centimeters, the second in inches.
Each piece is made by hand and has its own uniqueness.
Measures may vary with a tolerance up to 3%.
Seat depth 56 cm - 22".
Seat height 41 cm - 16".

Technical sheet

SALLY

Design Giuseppe Viganò

NOTES
- METAL LEGS AND BUTTON AVAILABLE IN ALL CUSTOMIZING FINISHES
- BELT ONLY AVAILABLE IN LEATHER

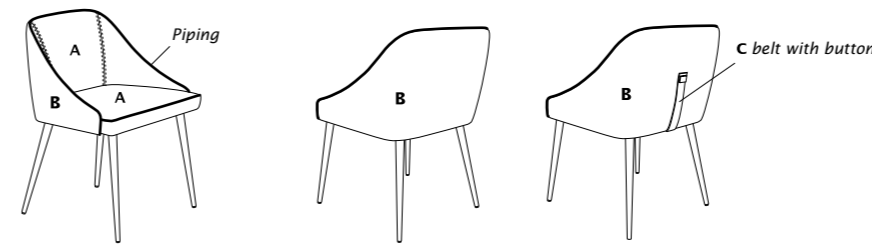

CHA

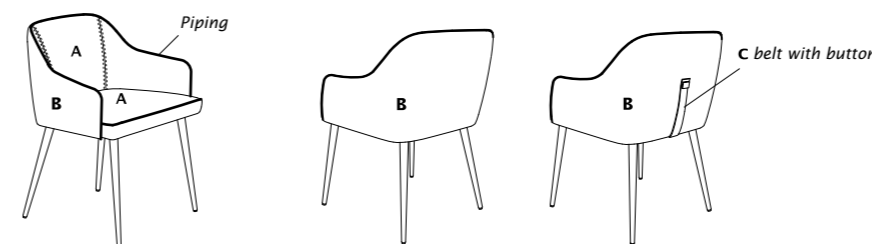
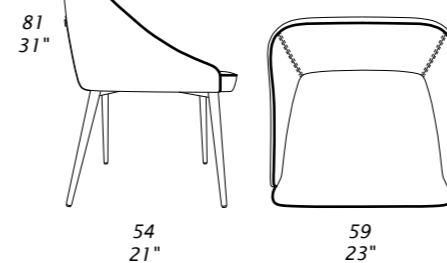

CHABR

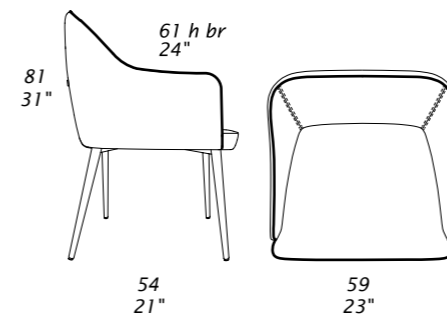

Dimensions: the first figure shows sizes in centimeters, the second in inches.
Each piece is made by hand and has its own uniqueness. Measures may vary with a tolerance up to 3%.
Seat depth 42 cm - 17".
Seat height 50 cm - 20".

Technical sheet

SPIDER

Design Giuseppe Viganò

NOTES
- METAL BASE AVAILABLE IN ALL CUSTOMIZING FINISHES

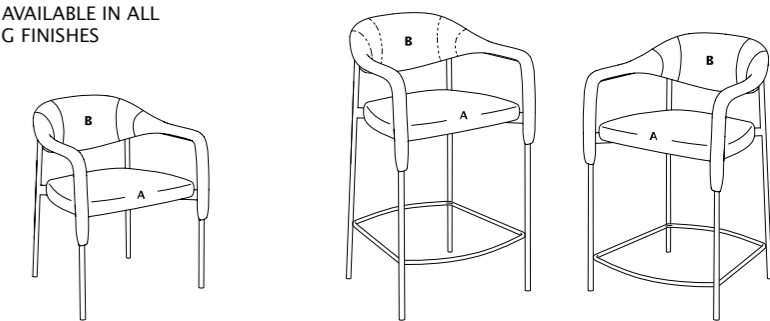

CHR

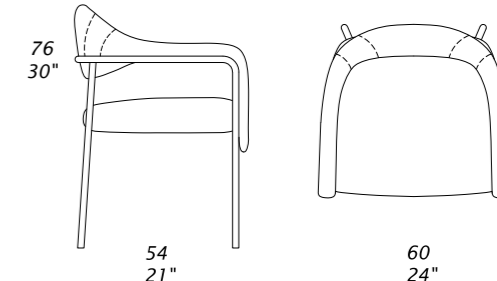

Seat depth 44 cm - 17"
Seat height 47 cm - 18"

CHRST
Bar stool

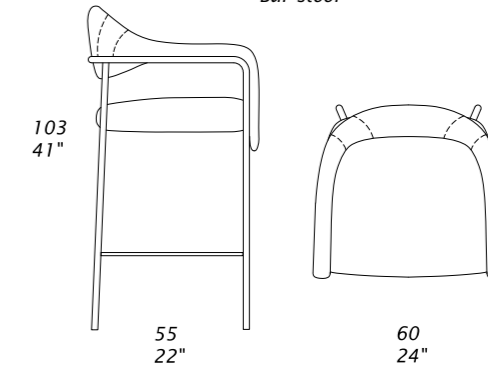

Seat depth 44 cm - 17"
Seat height 74 cm - 29"
Footrest height 26 cm - 10"

CHRCO
Counter stool

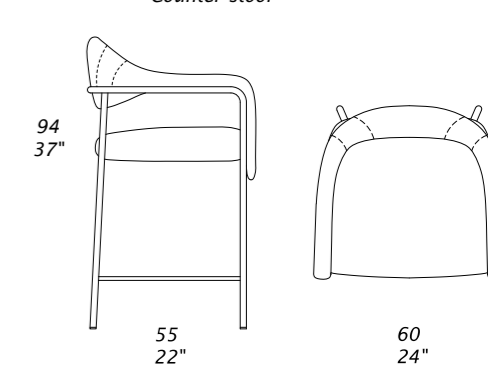

Seat depth 44 cm - 17"
Seat height 65 cm - 26"
Footrest height 17 cm - 7"

Dimensions: the first figure shows sizes in centimeters, the second in inches.
Each piece is made by hand and has its own uniqueness. Measures may vary with a tolerance up to 3%.

Technical sheet

COCOON NIGHT

Design Giuseppe Viganò

BRAIDED

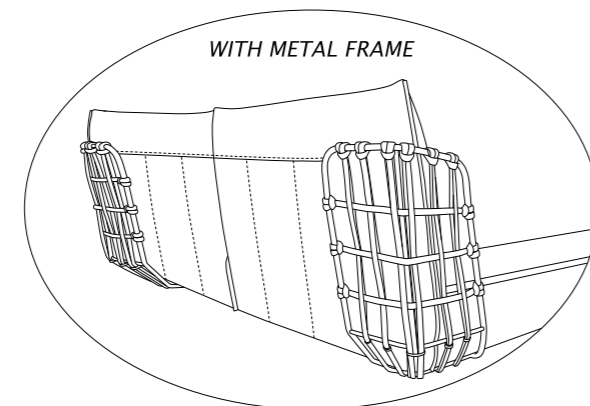

STANDARD

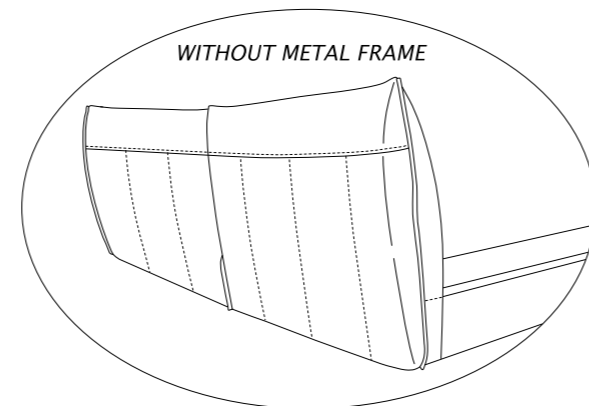

EUROPEAN SIZES

	L05	L15	L25	L35	L45
	materasso 80 x 200 mattress 31" x 79"	materasso 160 x 200 mattress 63" x 79"	materasso 180 x 200 mattress 71" x 79"	materasso 190 x 200 mattress 75" x 79"	materasso 200 x 200 mattress 79" x 79"
103 41"					
	244 96"	109 43"	189 74"	209 82"	219 86"
					229 90"

AMERICAN SIZES

	L10	L20	L30	L40
	materasso 137 x 190.5 mattress 54" x 75"	materasso 152 x 203.5 mattress 60" x 80"	materasso 193 x 203.5 mattress 76" x 80"	materasso 183 x 213.5 mattress 72" x 84"
103 41"				
	234 92"	165 65"	247 97"	180 71"
			247 97"	221 87"
			257 101"	211 83"

BRAIDED VERSION

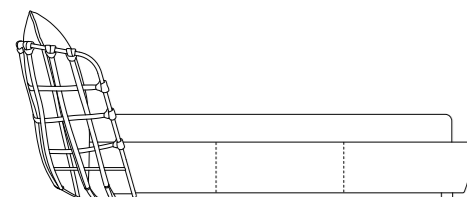

BHB BRAIDED CORNERS

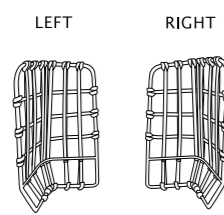

IN THE BRAIDED VERSION THE DIMENSIONS
WILL BE INCREASED OF 8 CM - 3" IN WIDTH
AND 4 CM - 2" IN DEPTH

Dimensions: the first figure shows sizes in centimeters, the second in inches.
Each piece is made by hand and has its own uniqueness. Measures may vary with a tolerance up to 3%.
Base height 35 cm - 14".
Wood legs, height 6 cm - 2".

Technical sheet

JACK NIGHT PLUS

Design Giuseppe Viganò

EUROPEAN SIZES

	L05	L15	L25	L35	L45
	materasso 80 x 200 mattress 31" x 79"	materasso 160 x 200 mattress 63" x 79"	materasso 180 x 200 mattress 71" x 79"	materasso 190 x 200 mattress 75" x 79"	materasso 200 x 200 mattress 79" x 79"
89 35"					
	238 94"	104 41"	184 72"	204 80"	214 84"
					224 88"

AMERICAN SIZES

	L10	L20	L30	L40
	materasso 137 x 190.5 mattress 54" x 75"	materasso 152 x 203.5 mattress 60" x 80"	materasso 193 x 203.5 mattress 76" x 80"	materasso 183 x 213.5 mattress 72" x 84"
89 35"				
	229 90"	161 63"	242 95"	176 69"
			242 95"	217 85"
			252 99"	207 81"

Dimensions: the first figure shows sizes in centimeters, the second in inches.
Each piece is made by hand and has its own uniqueness. Measures may vary with a tolerance up to 3%.
Base height 27 cm - 11".
Metal legs, height 15 cm - 6".

Technical sheet

JAZZ NIGHT

Design Giuseppe Viganò

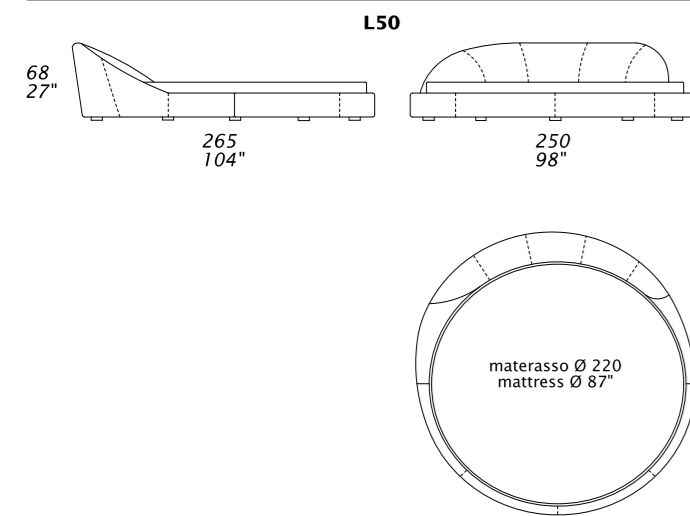

Dimensions: the first figure shows sizes in centimeters, the second in inches.
Each piece is made by hand and has its own uniqueness. Measures may vary with a tolerance up to 3%.
Base height 25 cm - 10".
Wood legs, height 4 cm - 1" 1/2.

Technical sheet

MARLON NIGHT

Design Giuseppe Viganò

EUROPEAN SIZES

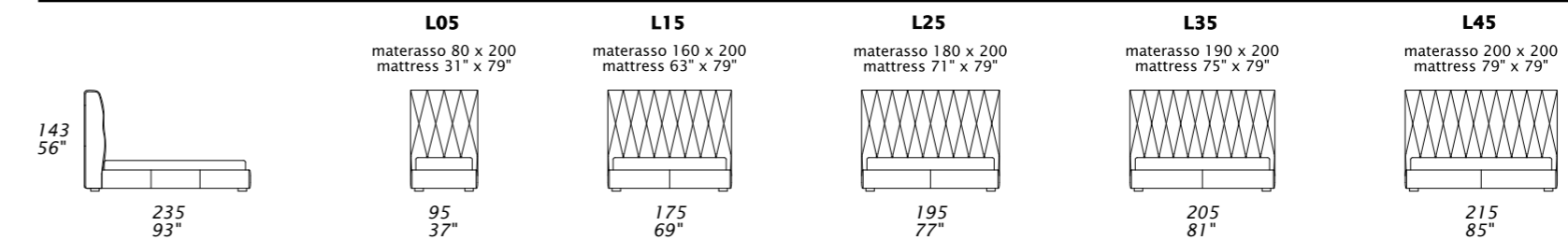

AMERICAN SIZES

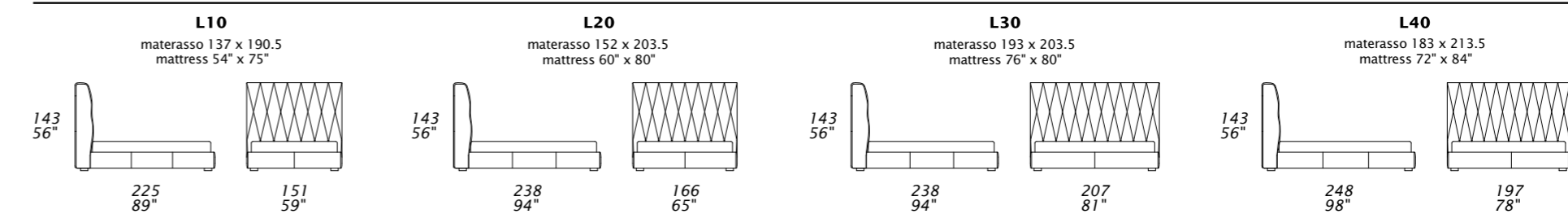

Dimensions: the first figure shows sizes in centimeters, the second in inches.
Each piece is made by hand and has its own uniqueness. Measures may vary with a tolerance up to 3%.
Base height 30 cm - 12".
Wood legs, height 4 cm - 1" 1/2.

Technical sheet

McQUEEN NIGHT

Design Giuseppe Viganò

EUROPEAN SIZES

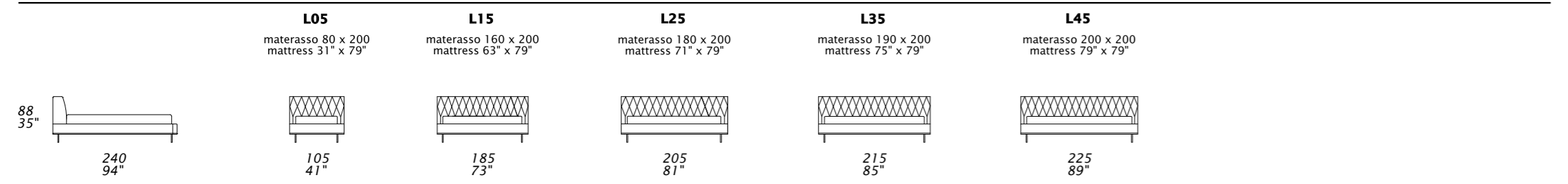

AMERICAN SIZES

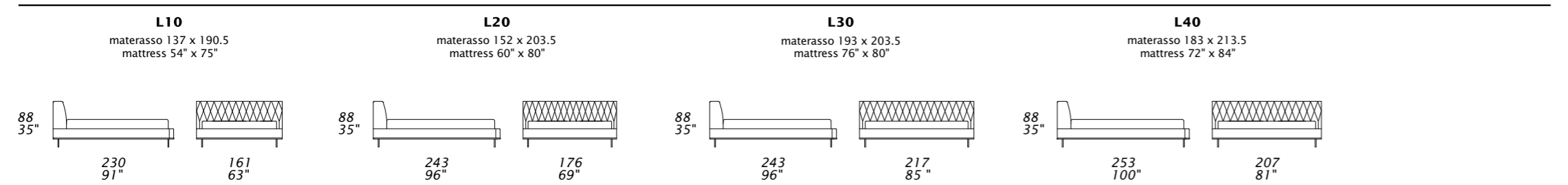

Dimensions: the first figure shows sizes in centimeters, the second in inches.
 Each piece is made by hand and has its own uniqueness. Measures may vary with a tolerance up to 3%.
 Base height 31 cm - 12".
 Metal legs, height 14 cm - 6".
 Metal legs available in all customizing finishes

Technical sheet

OXER NIGHT

Design Giuseppe Viganò

EUROPEAN SIZES

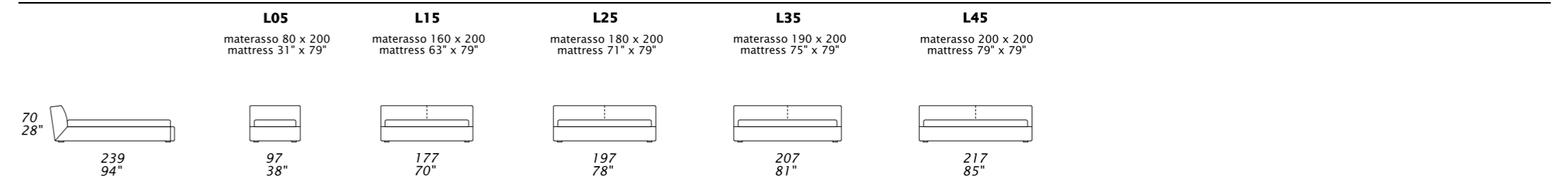

AMERICAN SIZES

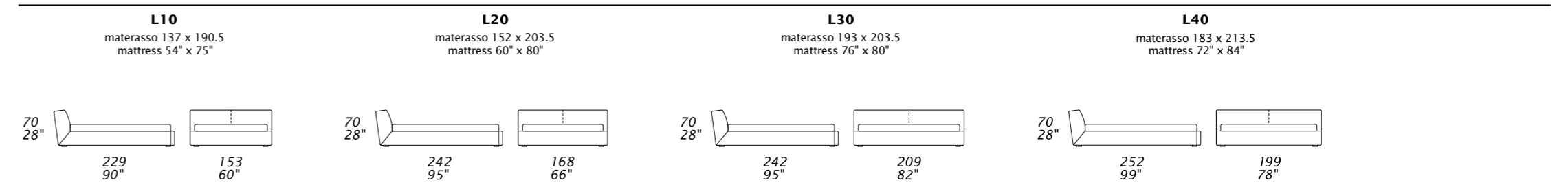

TALL HEADBOARD VERSION

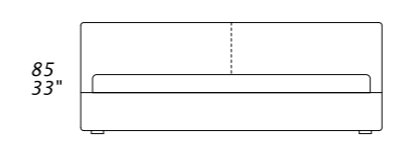

Dimensions: the first figure shows sizes in centimeters, the second in inches.
 Each piece is made by hand and has its own uniqueness. Measures may vary with a tolerance up to 3%.
 Base height 28 cm - 11".
 Wood legs, height 3 cm - 1" 1/4.

Technical sheet

VENUS DINING TABLE

Design Giuseppe Viganò

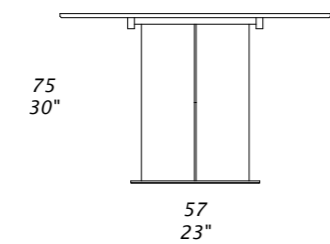
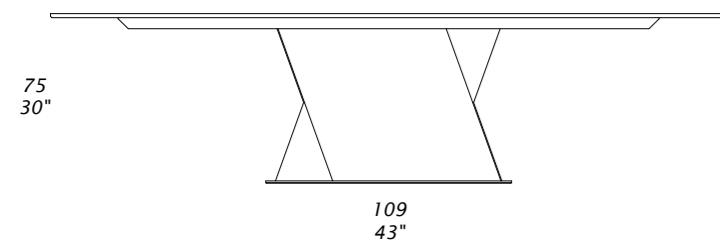

STANDARD FEATURES
-WOODEN FRAME UPHOLSTERED WITH LEATHER
-METAL INSERTS AVAILABLE IN ALL CUSTOMIZING FINISHES
-GLASS TOP AVAILABLE IN ALL CUSTOMIZING FINISHES
-CERAMIC TOP AVAILABLE IN ALL CUSTOMIZING FINISHES EXCEPT FOR TERRA, ANTRACITE AND OSSIDO BRUNO
-MARBLE TOP AVAILABLE IN ALL CUSTOMIZING FINISHES
-METAL INSERTS AVAILABLE IN ALL CUSTOMIZING FINISHES

T281B
200x120 - 79x47"

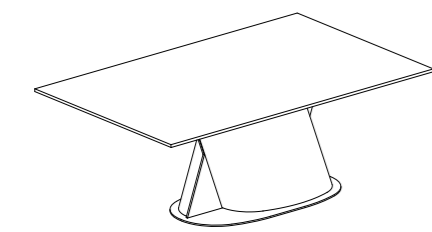

T283B
240x120 - 94x47"

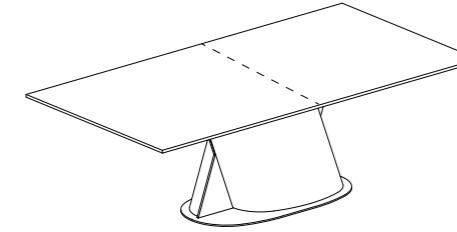

T285B
300x120 - 118x47"

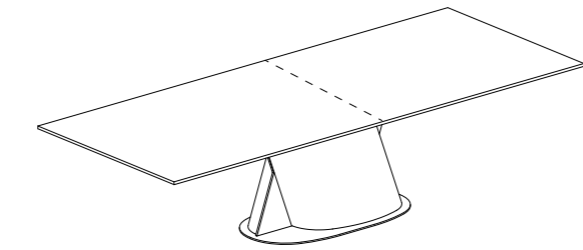

T282B
200x120 - 79x47"

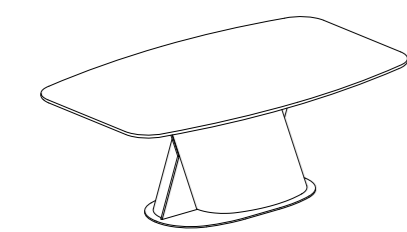

T284B
240x120 - 94x47"

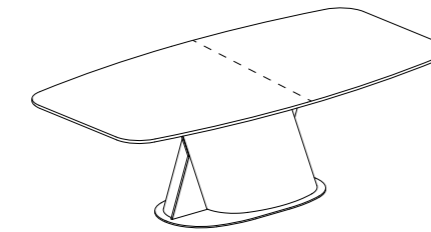

T286B
300x120 - 118x47"

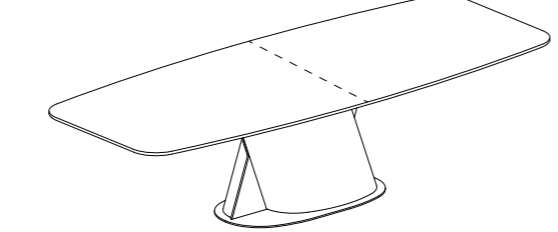

Dimensions: the first figure shows sizes in centimeters, the second in inches.
Each piece is made by hand and has its own uniqueness. Measures may vary with a tolerance up to 3%.
On marble finishes, only for length over 200 cm - 79", the top is split in two parts at the center, across its width.
On Sahara Noir marble top, for length over 200 cm - 79", the joint line is pronounced where the two tabletop parts are connected, compared to other marble finishes.

VENUS CONSOLLE

Design Giuseppe Viganò

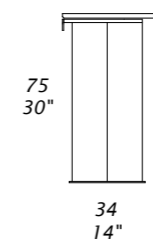
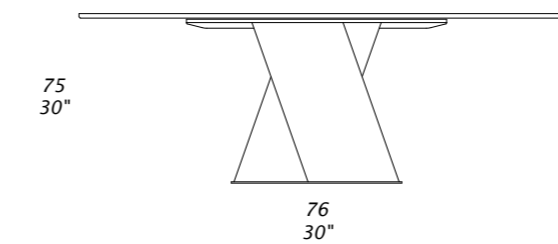

STANDARD FEATURES
-WOODEN FRAME UPHOLSTERED WITH LEATHER
-GLASS TOP AVAILABLE IN ALL CUSTOMIZING FINISHES
-CERAMIC TOP AVAILABLE IN ALL CUSTOMIZING FINISHES
-MARBLE TOP AVAILABLE IN ALL CUSTOMIZING FINISHES
-METAL INSERTS AVAILABLE IN ALL CUSTOMIZING FINISHES

NOTES
THE CONSOLLE MUST BE FIXED TO THE WALL

K085B
130x50 - 51x20"



K086B
150x50 - 59x20"



K087B
200x50 - 79x20"

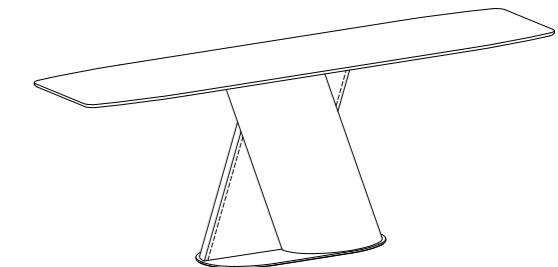

K075B
130x50 - 51x20"

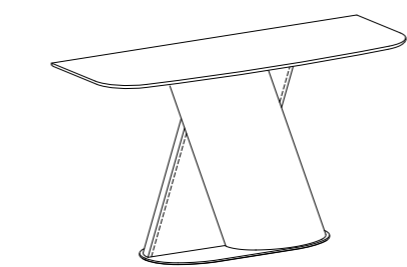

K076B
150x50 - 59x20"

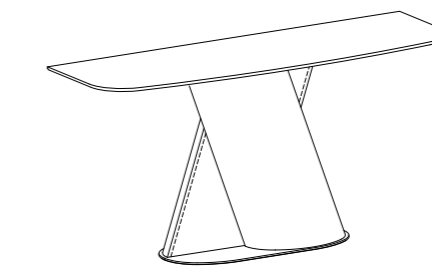

K077B
200x50 - 79x20"

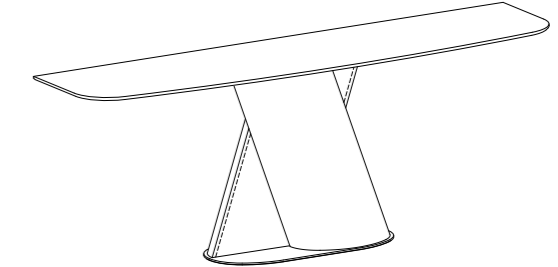

Dimensions: the first figure shows sizes in centimeters, the second in inches.
Each piece is made by hand and has its own uniqueness. Measures may vary with a tolerance up to 3%.

COFFEE TABLES

Design Giuseppe Viganò

BASKET

STANDARD FEATURES

- GLASS TOP AVAILABLE IN ALL CUSTOMIZING FINISHES
- MIRROR TOP AVAILABLE IN MIRROR, BRONZE MIRROR AND SMOKED MIRROR FINISHES
- CERAMIC TOP AVAILABLE IN ALL CUSTOMIZING FINISHES
- MARBLE TOP AVAILABLE IN ALL CUSTOMIZING FINISHES
- METAL BASE AVAILABLE IN ALL CUSTOMIZING FINISHES

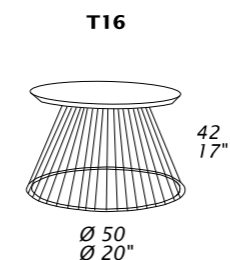
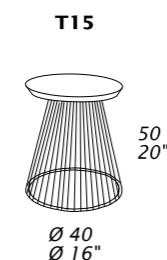
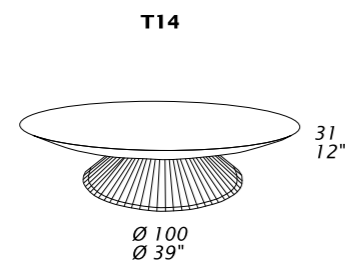

BELTS

STANDARD FEATURES

- GLASS TOP AVAILABLE IN ALL CUSTOMIZING FINISHES
- MIRROR TOP AVAILABLE IN MIRROR, BRONZE MIRROR AND SMOKED MIRROR FINISHES
- CERAMIC TOP AVAILABLE IN ALL CUSTOMIZING FINISHES
- MARBLE TOP AVAILABLE IN ALL CUSTOMIZING FINISHES
- METAL BASE AVAILABLE IN ALL CUSTOMIZING FINISHES OR COVERED WITH LEATHER
- BUCKLE AVAILABLE IN ALL CUSTOMIZING METAL FINISHES OR COVERED WITH LEATHER

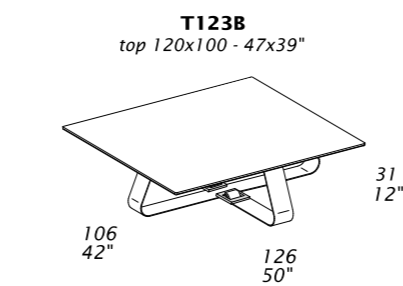
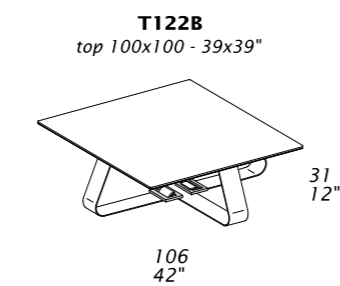
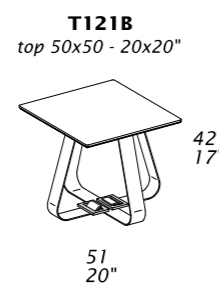
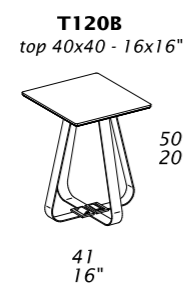
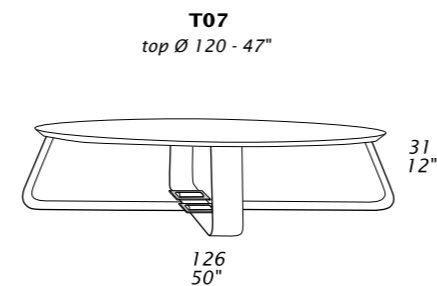
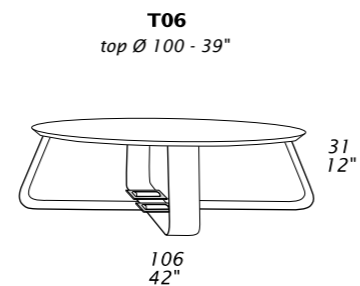
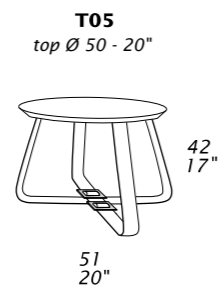
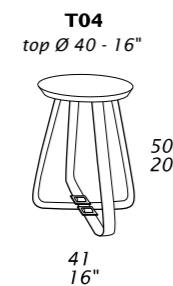

CLEPSYDRA

STANDARD FEATURES

- POLYURETHANE RESIN FRAME COVERED WITH LEATHER
- GLASS TOP AVAILABLE IN ALL CUSTOMIZING FINISHES
- MIRROR TOP AVAILABLE IN MIRROR, BRONZE MIRROR AND SMOKED MIRROR FINISHES
- CERAMIC TOP AVAILABLE IN ALL CUSTOMIZING FINISHES
- MARBLE TOP AVAILABLE IN ALL CUSTOMIZING FINISHES
- METAL DETAIL AVAILABLE IN ALL CUSTOMIZING FINISHES

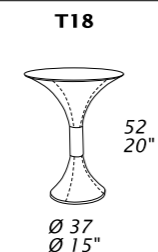
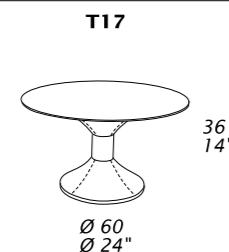

Dimensions: the first figure shows sizes in centimeters, the second in inches.
Each piece is made by hand and has its own uniqueness. Measures may vary with a tolerance up to 3%.

Technical sheet

COFFEE TABLES

Design Giuseppe Viganò

CRUISE

STANDARD FEATURES

- GLASS TOP AVAILABLE IN ALL CUSTOMIZING FINISHES
- CERAMIC TOP AVAILABLE IN ALL CUSTOMIZING FINISHES
- MARBLE TOP AVAILABLE IN ALL CUSTOMIZING FINISHES
- METAL BASE COVERED WITH LEATHER AVAILABLE IN ALL CUSTOMIZING FINISHES

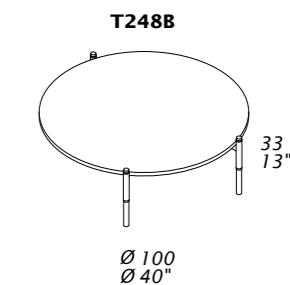
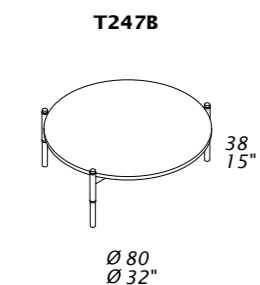
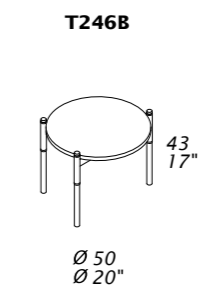
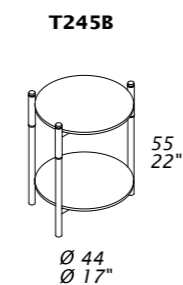

DRUMS

STANDARD FEATURES

- HARD WOOD FRAME AND POLYURETHANE COVERED WITH LEATHER
- GLASS TOP AVAILABLE IN ALL CUSTOMIZING FINISHES
- MIRROR TOP AVAILABLE IN MIRROR, BRONZE MIRROR AND SMOKED MIRROR FINISHES
- CERAMIC TOP AVAILABLE IN ALL CUSTOMIZING FINISHES
- MARBLE TOP AVAILABLE IN ALL CUSTOMIZING FINISHES

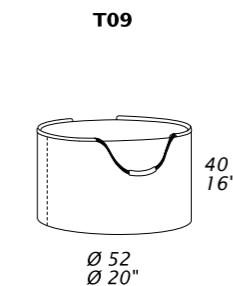
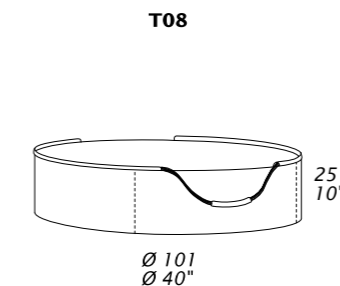

ESCAPE

STANDARD FEATURES

- GLASS TOP AVAILABLE IN ALL CUSTOMIZING FINISHES
- CERAMIC TOP AVAILABLE IN ALL CUSTOMIZING FINISHES
- MARBLE TOP AVAILABLE IN ALL CUSTOMIZING FINISHES
- METAL BASE AVAILABLE IN ALL CUSTOMIZING FINISHES

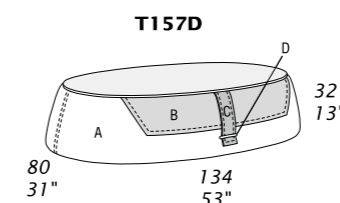
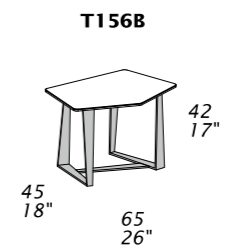
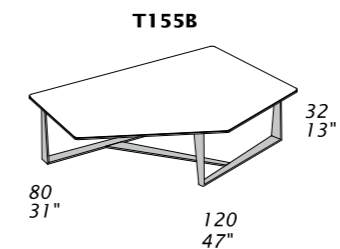

KARL

STANDARD FEATURES

- HARD WOOD FRAME AND POLYURETHANE COVERED WITH LEATHER
- GLASS TOP AVAILABLE IN ALL CUSTOMIZING FINISHES
- CERAMIC TOP AVAILABLE IN ALL CUSTOMIZING FINISHES
- MARBLE TOP AVAILABLE IN ALL CUSTOMIZING FINISHES

Dimensions: the first figure shows sizes in centimeters, the second in inches.
Each piece is made by hand and has its own uniqueness. Measures may vary with a tolerance up to 3%.

Technical sheet

COFFEE TABLES

Design Giuseppe Viganò

KONG

STANDARD FEATURES

- HARD WOOD FRAME COVERED WITH LEATHER
- GLASS TOP AVAILABLE IN ALL CUSTOMIZING FINISHES
- MIRROR TOP AVAILABLE IN MIRROR, BRONZE MIRROR AND SMOKED MIRROR FINISHES
- CERAMIC TOP AVAILABLE IN ALL CUSTOMIZING FINISHES
- MARBLE TOP AVAILABLE IN ALL CUSTOMIZING FINISHES
- WOOD LEGS AVAILABLE IN NOCE CANALETTO AND FRASSINO

T29H

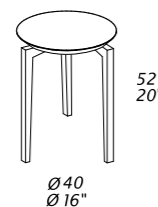

T30H

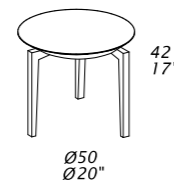

T31H

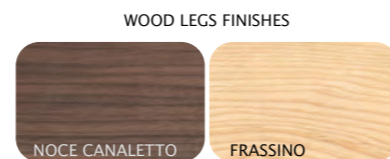
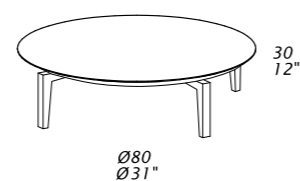

PUZZLE

STANDARD FEATURES

- HARD WOOD FRAME COVERED WITH LEATHER
- GLASS TOP AVAILABLE IN ALL CUSTOMIZING FINISHES
- MIRROR TOP AVAILABLE IN MIRROR, BRONZE MIRROR AND SMOKED MIRROR FINISHES
- CERAMIC TOP AVAILABLE IN ALL CUSTOMIZING FINISHES
- MARBLE TOP AVAILABLE IN ALL CUSTOMIZING FINISHES

T190A

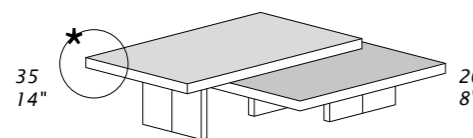

T191A

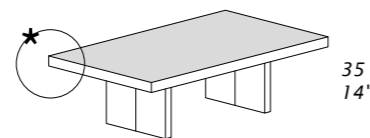

T192A

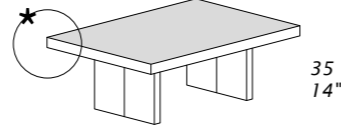

T193A

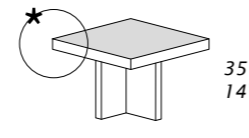

T158B

ONLY AVAILABLE WITH GLASS OR CERAMIC TOP
AND METAL BASE IN ALL CUSTOMIZING METAL FINISHES

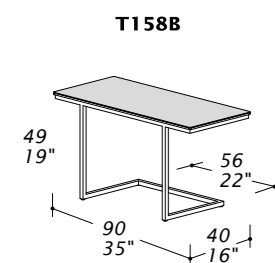

* CORNERS DETAIL

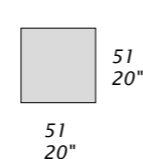
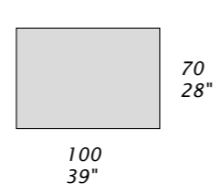
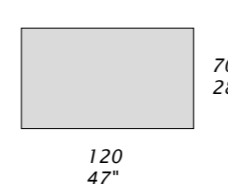
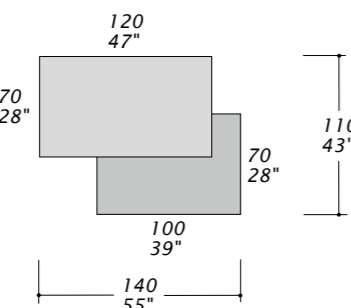

SIDE

STANDARD FEATURES

- GLASS TOP AVAILABLE IN ALL CUSTOMIZING FINISHES
- CERAMIC TOP AVAILABLE IN ALL CUSTOMIZING FINISHES
- METAL BASE AVAILABLE IN ALL CUSTOMIZING FINISHES

T142B

top 50x50 - 20x20"

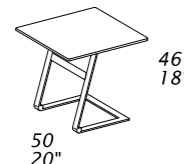

Dimensions: the first figure shows sizes in centimeters, the second in inches.
Each piece is made by hand and has its own uniqueness. Measures may vary with a tolerance up to 3%.

Technical sheet

COFFEE TABLES

Design Giuseppe Viganò

STRIPES

STANDARD FEATURES

- GLASS TOP AVAILABLE IN ALL CUSTOMIZING FINISHES
- CERAMIC TOP AVAILABLE IN ALL CUSTOMIZING FINISHES
- METAL BASE (A) AVAILABLE IN ALL CUSTOMIZING FINISHES EXCEPT CHROME
- METAL SUPPORT (B) AVAILABLE IN ALL CUSTOMIZING FINISHES

T125B

top 40x40 - 16x16"

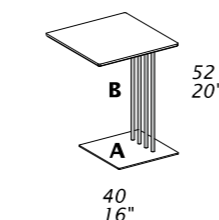

T126B

top 50x50 - 20x20"

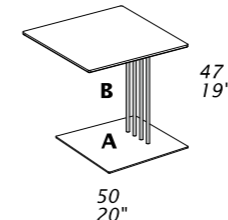

VINCENT

STANDARD FEATURES

- HARD WOOD FRAME COVERED WITH LEATHER
- GLASS TOP AVAILABLE IN ALL CUSTOMIZING FINISHES
- CERAMIC TOP AVAILABLE IN ALL CUSTOMIZING FINISHES
- MARBLE TOP AVAILABLE IN ALL CUSTOMIZING FINISHES
- METAL LEGS AVAILABLE IN ALL CUSTOMIZING FINISHES

NOTES

- LOW VERSION H 19 - 7" (legs H 13 - 5")
- HIGH VERSION H 27 - 11" (legs H 21 - 8")

T250D

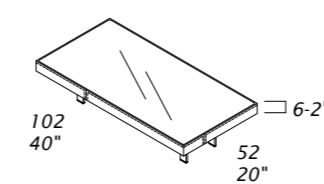

T251D

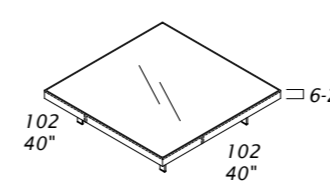

T252D

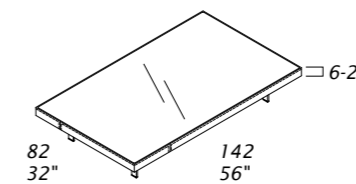

Dimensions: the first figure shows sizes in centimeters, the second in inches.
Each piece is made by hand and has its own uniqueness. Measures may vary with a tolerance up to 3%.

Technical sheet

MIRRORS

Design Giuseppe Viganò

STANDARD FEATURES

- HARD WOOD FRAME COVERED WITH LEATHER

ES4

Ellipse

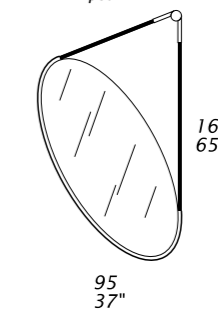

specchio cm 70 x 150
mirror 28" x 59"

ES5

Ellipse

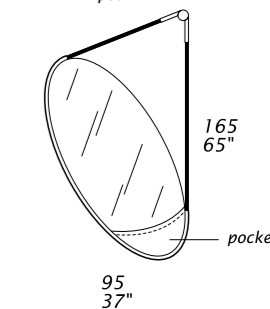

specchio cm 70 x 150
mirror 28" x 59"

ES9

Jack Mirror

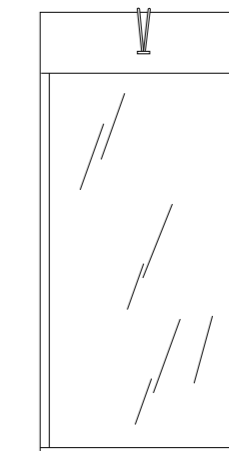

specchio cm 84 x 177
mirror 33" x 70"

ES012

Cocoon Mirror

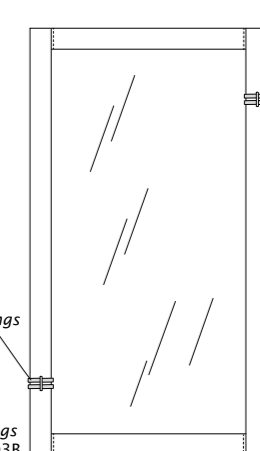

specchio cm 86 x 176
mirror 34" x 69"

ES013

Cocoon Mirror

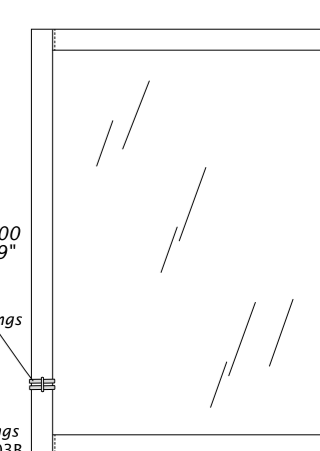

specchio cm 126 x 176
mirror 50" x 69"

Dimensions: the first figure shows sizes in centimeters, the second in inches.
Each piece is made by hand and has its own uniqueness. Measures may vary with a tolerance up to 3%.

Technical sheet

NIGHT STANDS

Design Giuseppe Viganò

STANDARD FEATURES

- HARD WOOD FRAME COVERED WITH LEATHER
- GLASS TOP AVAILABLE IN ALL CUSTOMIZING FINISHES
- CERAMIC TOP AVAILABLE IN ALL CUSTOMIZING FINISHES
- MARBLE TOP AVAILABLE IN ALL CUSTOMIZING FINISHES

SKY K009-A Wood Legs

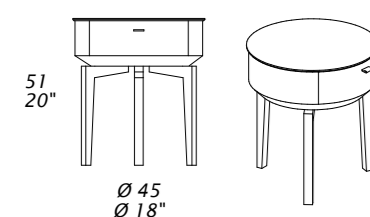

SKY K009-B Metal Base

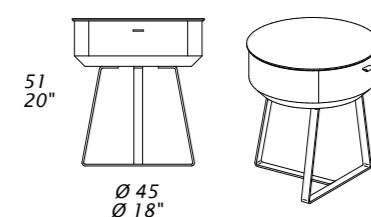

SKY K009-C Cone Legs

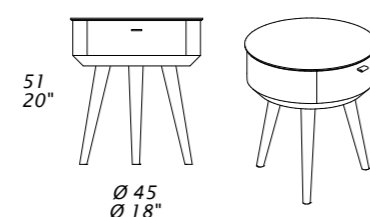

SKY K009-D Metal Legs

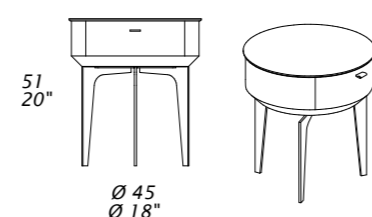

SKY K009-E Metal Base

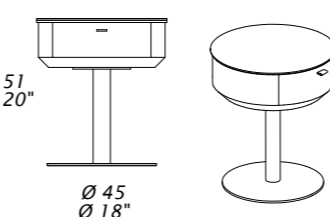

WOOD LEGS FINISHES



BAKU K015-D

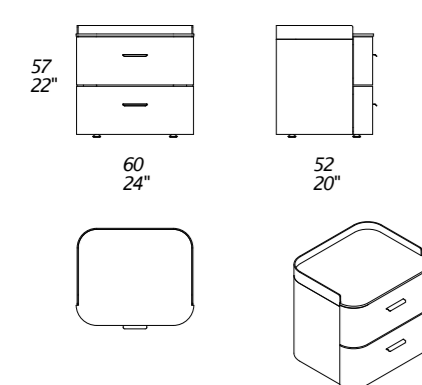

BAKU K018-D

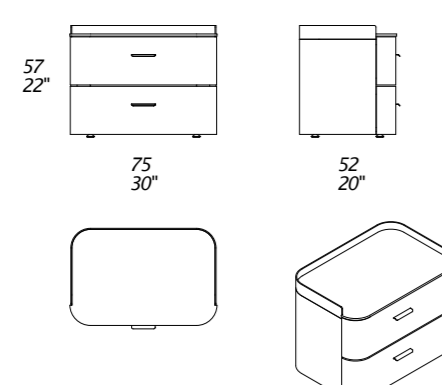

BAKU K017-D

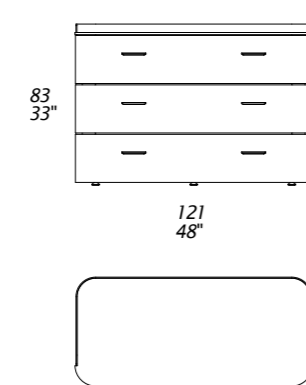

BAKU K016-D

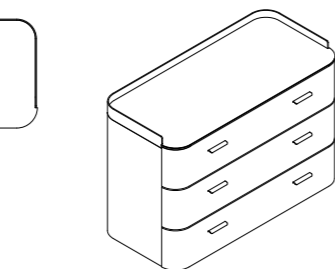
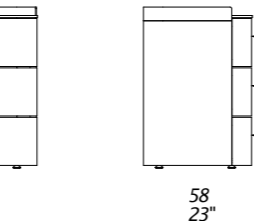
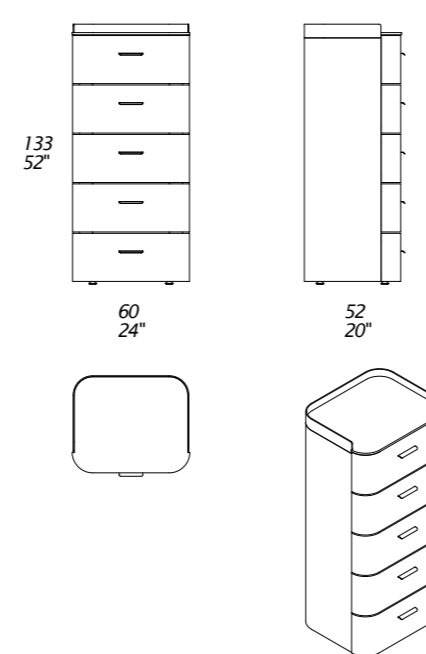

Dimensions: the first figure shows sizes in centimeters, the second in inches.
Each piece is made by hand and has its own uniqueness. Measures may vary with a tolerance up to 3%.
Metal legs (SKY) and details (BAKU) are available in all customizing finishes.
K009-A with wood legs: Noce Canaletto or Frassino.

Technical sheet

BOULEVARD

Design Giuseppe Viganò

STANDARD FEATURES

- WOOD PANELS COVERED WITH LEATHER
- CHROME METAL SUPPORT
- LEATHER TIES
- SHELVES IN SMOKED GLASS OR EXTRA CLEAR GLASS

NOTE

- CUSTOMER CAN CHOOSE CONFIGURATIONS OF PANELS & SHELVES

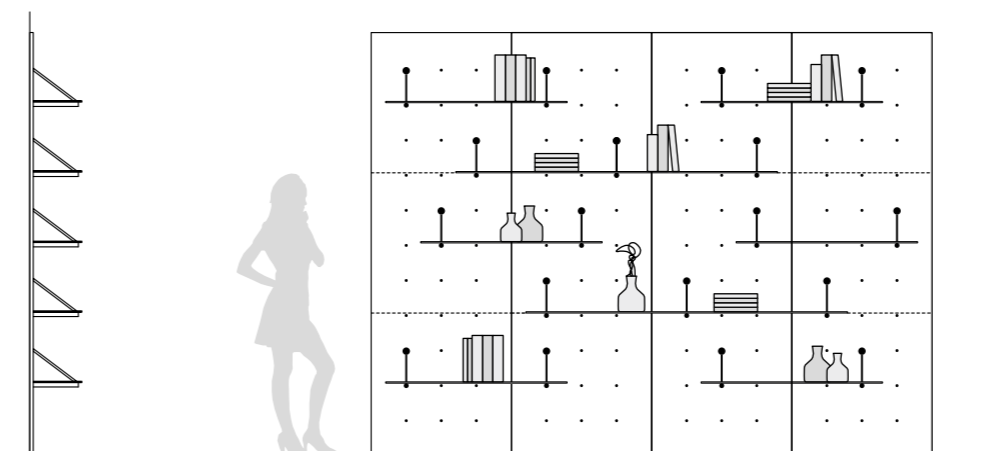

PA1

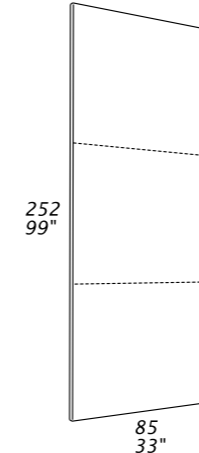

GLASS SHELVES (AVAILABLE IN DIFFERENT SIZES)

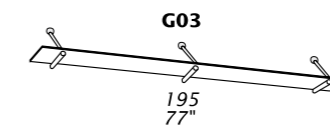
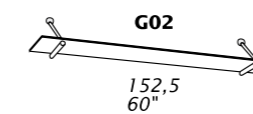
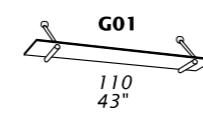

Dimensions: the first figure shows sizes in centimeters, the second in inches.
Each piece is made by hand and has its own uniqueness. Measures may vary with a tolerance up to 3%.

Technical sheet

BASKET LAMPS

Design Giuseppe Viganò

L001B

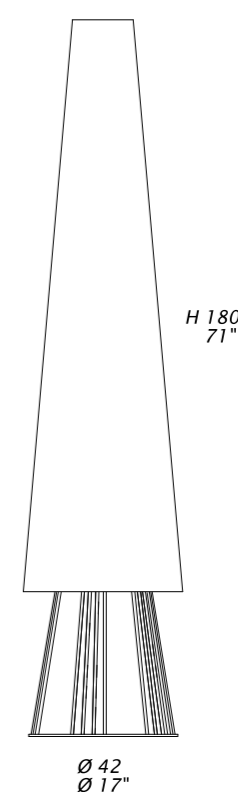

L002B

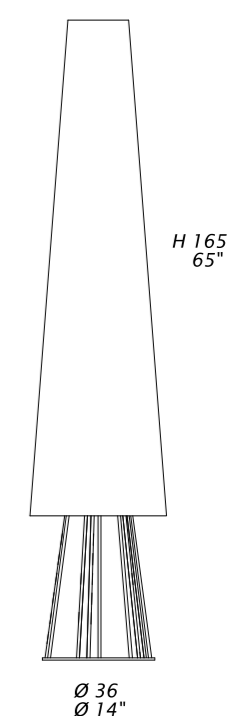

STANDARD FEATURES

- FLOOR LAMP WITH METAL FRAME AVAILABLE IN ALL CUSTOMIZING FINISHINGS.
- LAMP SHADE IN VISCOSE COUPLED WITH PVC, AVAILABLE IN THE FOLLOWING COLORS:



62 TAUPE



63 BROWN

TECHNICAL SHEET

- LIGHT SOURCES NOT SUPPLIED
- MAX 150 W HALO / LED - FLUO COMPATIBLE
- SOCKET E27, VOLTAGE 220 - 240 V
- SOCKET E26, VOLTAGE 110 - 120 V

Dimensions: the first figure shows sizes in centimeters, the second in inches.
Each piece is made by hand and has its own uniqueness. Measures may vary with a tolerance up to 3%.

Technical sheet

BROOKLYN

Design Giuseppe Viganò

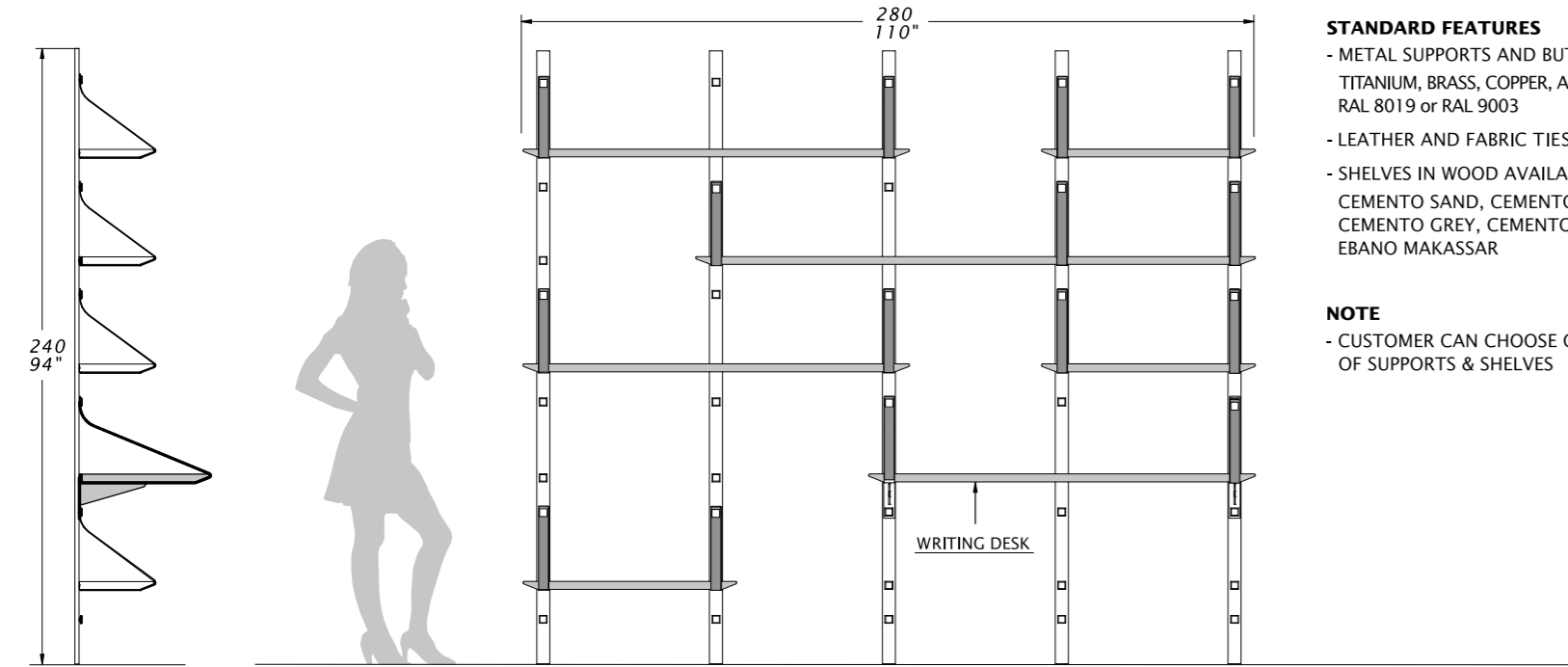

STANDARD FEATURES

- METAL SUPPORTS AND BUTTONS AVAILABLE IN: TITANIUM, BRASS, COPPER, ANTHRACITE, RAL 8019 or RAL 9003
- LEATHER AND FABRIC TIES
- SHELVES IN WOOD AVAILABLE IN COLORS: CEMENTO SAND, CEMENTO TAUPE, CEMENTO GREY, CEMENTO BLACK, EBANO MAKASSAR

NOTE

- CUSTOMER CAN CHOOSE CONFIGURATIONS OF SUPPORTS & SHELVES

SHELVES

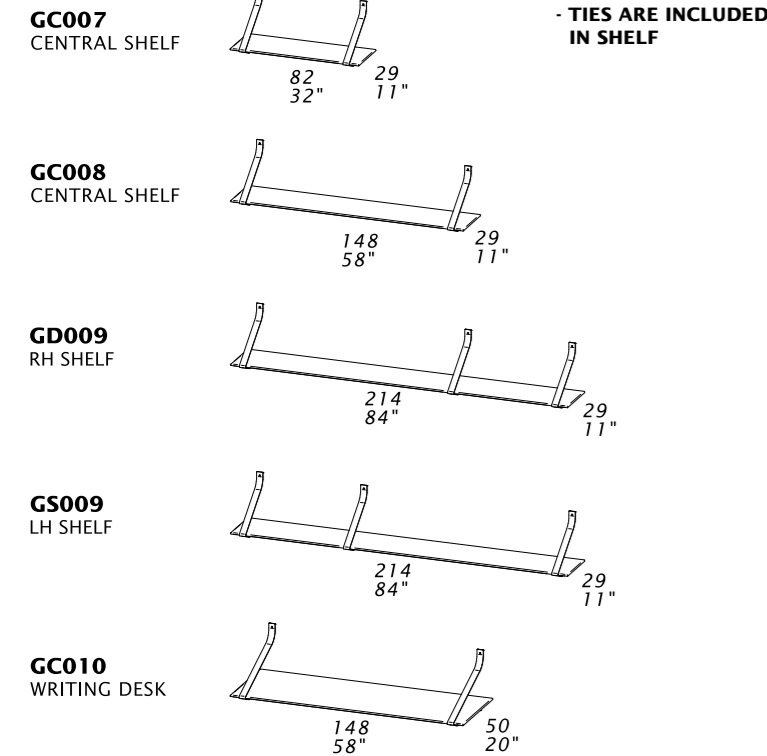

SUPPORTS

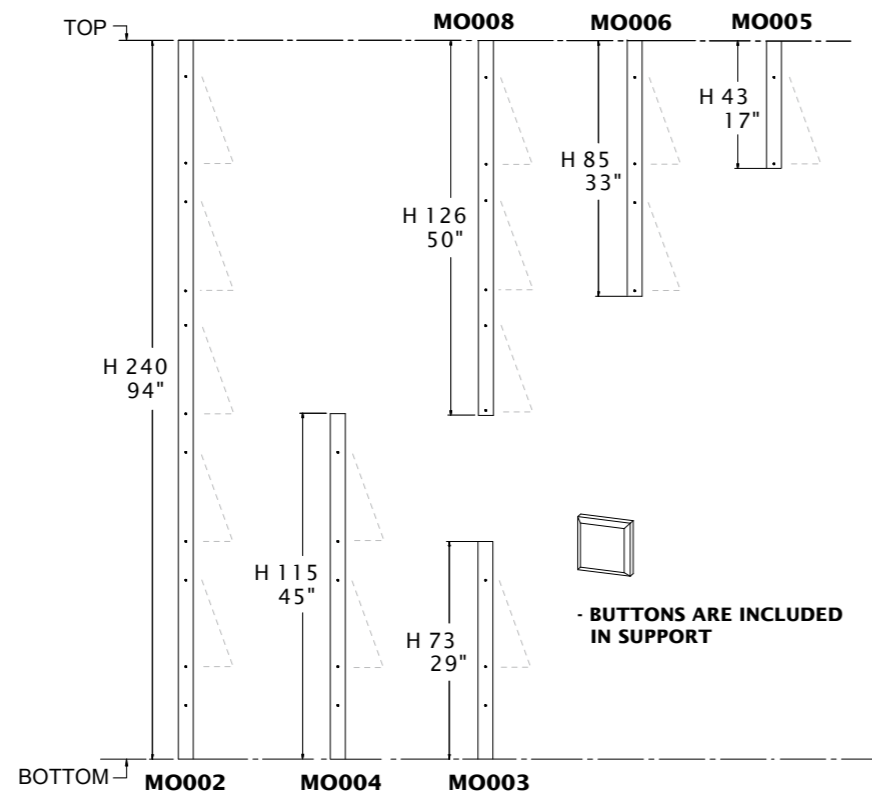

SHELVES FINISHES

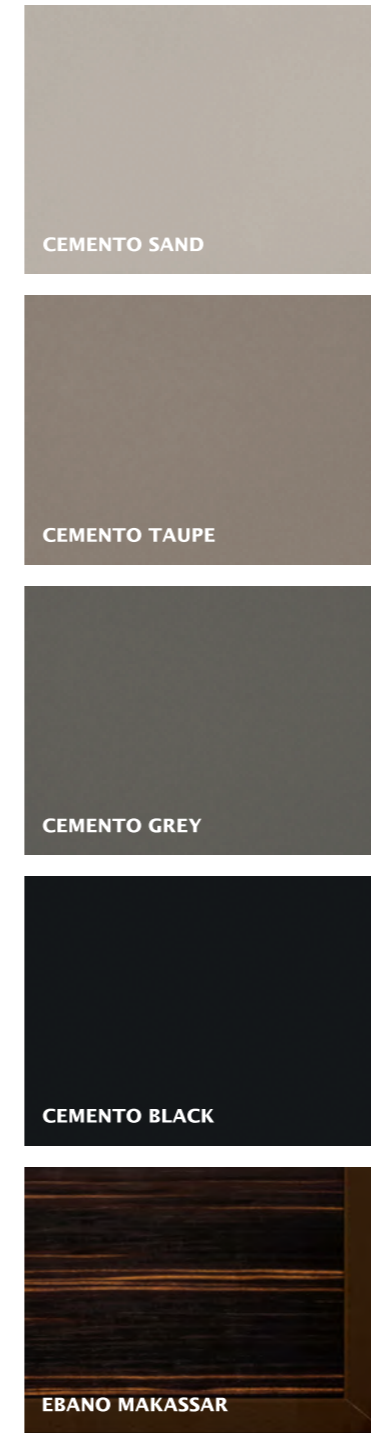

OLIVER TV UNIT

STANDARD FEATURES

- HARD WOOD FRAME COVERED WITH LEATHER
- GLASS TOP AVAILABLE IN ALL CUSTOMIZING FINISHES
- CERAMIC TOP AVAILABLE IN ALL CUSTOMIZING FINISHES
- MARBLE TOP AVAILABLE IN ALL CUSTOMIZING FINISHES
- METAL LEGS AVAILABLE IN ALL CUSTOMIZING FINISHES:
 - DOUBLE METAL TUBE LEG
 - FLAT SLED METAL LEG

NOTES

- THE BACK OF THE CABINET IS COVERED WITH LEATHER WITH OPENING FOR CABLE PASSAGE
- MAKE SURE TO SPECIFY IN THE ORDER IF YOU WANT THE BACK CLOSED COVERED WITH LEATHER

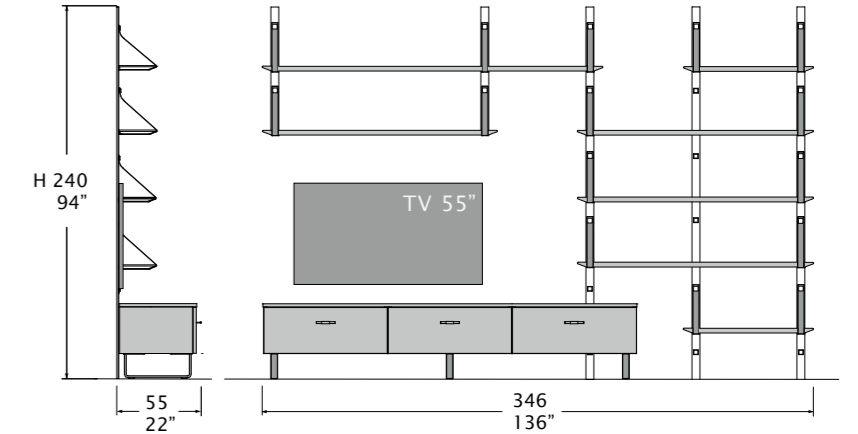

BROOKLYN BOOKSHELF COMPOSITION REFERENCE IMAGE

K030-D

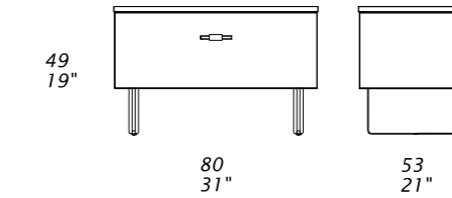
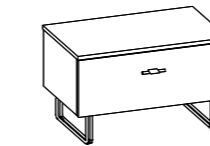

K031-D

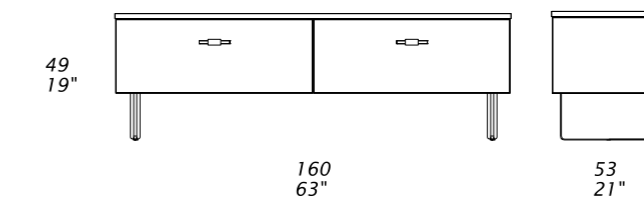
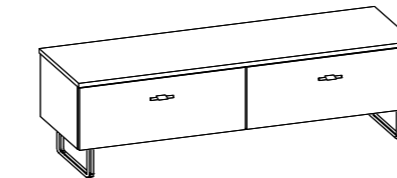

K032-D

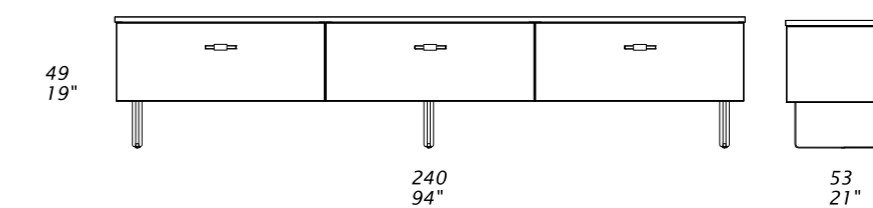
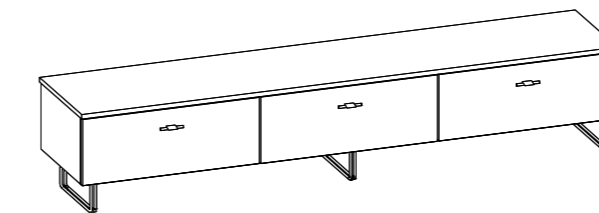

Dimensions: the first figure shows sizes in centimeters, the second in inches. Each piece is made by hand and has its own uniqueness. Measures may vary with a tolerance up to 3%.

BENCHES

ASTON

STANDARD FEATURES

- HARD WOOD FRAME
- PADDING IN POLYURETHANE
- HANDMADE CAPITONNÉ.
- SEAT HEIGHT 39 CM - 15"

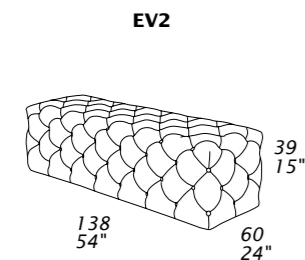

COCOON

STANDARD FEATURES

- HARD WOOD FRAME
- SEAT CUSHION IN POLYURETHANE COVERED WITH WADDING
- METAL LEGS AVAILABLE IN ALL CUSTOMIZING FINISHES

NOTES

- METAL LEGS AVAILABLE ONLY WITH MAORI LEATHER STRINGS

P020D

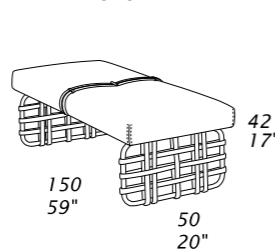

FLAMINGO

STANDARD FEATURES

- HARD WOOD FRAME
- SEAT CUSHION IN POLYURETHANE COVERED WITH WADDING
- SEAT HEIGHT 40 CM - 16"
- LEGS HEIGHT 31 CM - 12"

NOTES

- METAL LEGS AVAILABLE IN ALL CUSTOMIZING FINISHES

P019D

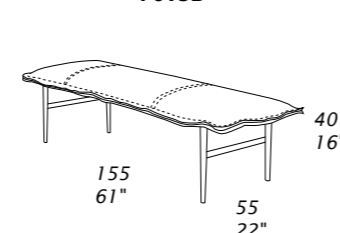

NEW YORK

STANDARD FEATURES

- HARD WOOD FRAME
- SEAT CUSHION IN POLYURETHANE COVERED WITH WADDING
- SEAT HEIGHT 42 CM - 17"
- LEGS HEIGHT 30 CM - 12"

NOTES

- METAL LEGS AVAILABLE IN ALL CUSTOMIZING FINISHES

P016D

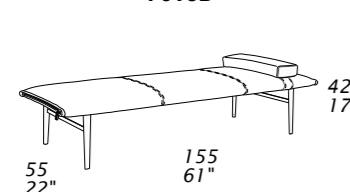

PASSEPARTOUT

STANDARD FEATURES

- HARD WOOD FRAME
- SEAT CUSHION IN POLYURETHANE COVERED WITH WADDING
- SEAT HEIGHT 39 CM - 15"
- LEGS HEIGHT 19 CM - 7"

NOTES

- METAL LEGS AVAILABLE IN ALL CUSTOMIZING FINISHES

P012D

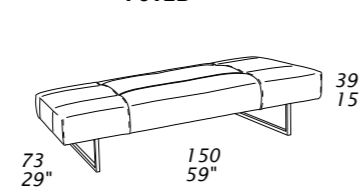

PEPPER

STANDARD FEATURES

- HARD WOOD FRAME
- SEAT CUSHION IN POLYURETHANE COVERED WITH WADDING
- SEAT HEIGHT 39 CM - 15"
- LEGS HEIGHT 26 CM - 10"

NOTES

- METAL LEGS AVAILABLE IN ALL CUSTOMIZING FINISHES
- P007-A WITH WOOD LEGS

P007-A WOOD LEGS

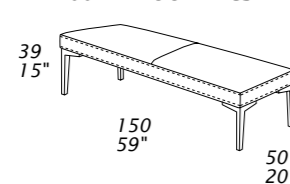

P007-C CONE LEGS

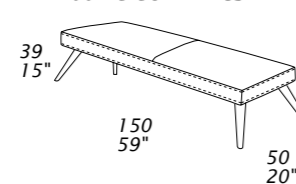

P007-D METAL LEGS

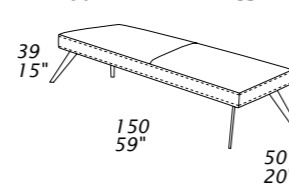

P007-A WOOD LEGS FINISHES



SAYONARA

STANDARD FEATURES

- HARD WOOD FRAME
- SEAT CUSHION IN POLYURETHANE COVERED WITH WADDING
- SEAT HEIGHT 39 CM - 15"
- LEGS HEIGHT 26 CM - 10"

NOTES

- METAL LEGS AVAILABLE IN ALL CUSTOMIZING FINISHES
- P009-A WITH WOOD LEGS

P009-A WOOD LEGS

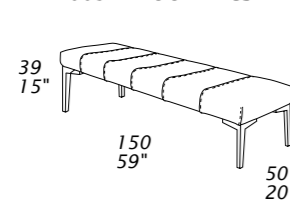

P009-C CONE LEGS

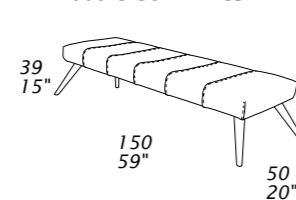

P009-D METAL LEGS

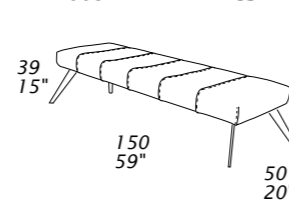

P009-A WOOD LEGS FINISHES

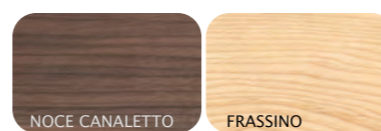

Dimensions: the first figure shows sizes in centimeters, the second in inches.
Each piece is made by hand and has its own uniqueness. Measures may vary with a tolerance up to 3%.

BENCHES

TULIP

STANDARD FEATURES

- HARD WOOD FRAME
- SEAT CUSHION IN POLYURETHANE COVERED WITH WADDING
- SEAT HEIGHT 39 CM - 15"
- LEGS HEIGHT 26 CM - 10"

NOTES

- METAL LEGS AVAILABLE IN ALL CUSTOMIZING FINISHES
- P008-A WITH WOOD LEGS

P008-A WOOD LEGS

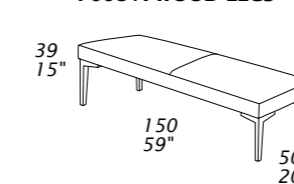

P008-C CONE LEGS

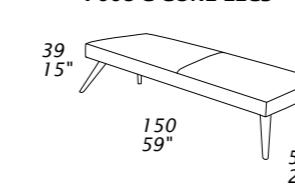

P008-D METAL LEGS

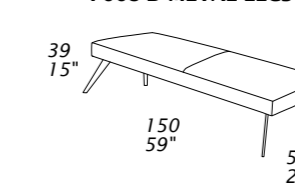

P008-A WOOD LEGS FINISH

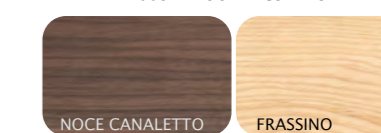

TUXEDO

STANDARD FEATURES

- HARD WOOD FRAME
- SEAT CUSHION IN POLYURETHANE COVERED WITH WADDING
- METAL LEGS HEIGHT 18 CM - 7"

NOTES

- METAL LEGS AVAILABLE IN ALL CUSTOMIZING FINISHES

P27

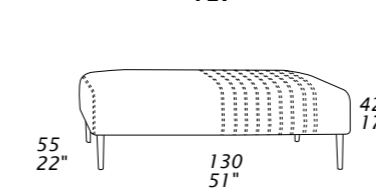

RENEGADE

STANDARD FEATURES

- HARD WOOD FRAME
- SEAT CUSHION IN POLYURETHANE COVERED WITH WADDING
- METAL LEGS HEIGHT 20 CM - 8"

NOTES

- METAL LEGS AVAILABLE IN ALL CUSTOMIZING FINISHES

P011D

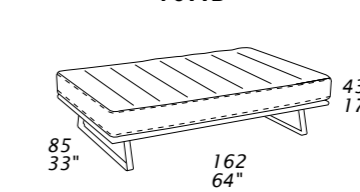

YOKO

STANDARD FEATURES

- HARD WOOD FRAME
- SEAT CUSHION IN POLYURETHANE COVERED WITH WADDING
- SEAT HEIGHT 40 CM - 16"
- LEGS HEIGHT 26 CM - 10"

NOTES

- METAL LEGS AVAILABLE IN ALL CUSTOMIZING FINISHES
- P024-A WITH WOOD LEGS

P024-A WOOD LEGS

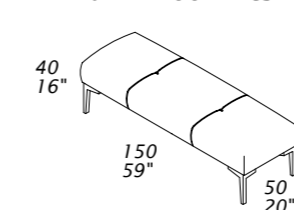

P024-C CONE LEGS

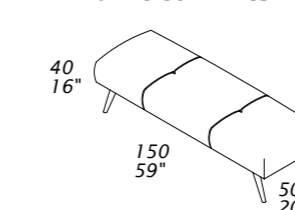

P024-D METAL LEGS

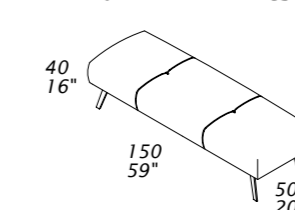

P024-A WOOD LEGS FINISHES



Dimensions: the first figure shows sizes in centimeters, the second in inches.
Each piece is made by hand and has its own uniqueness. Measures may vary with a tolerance up to 3%.

OTTOMANS

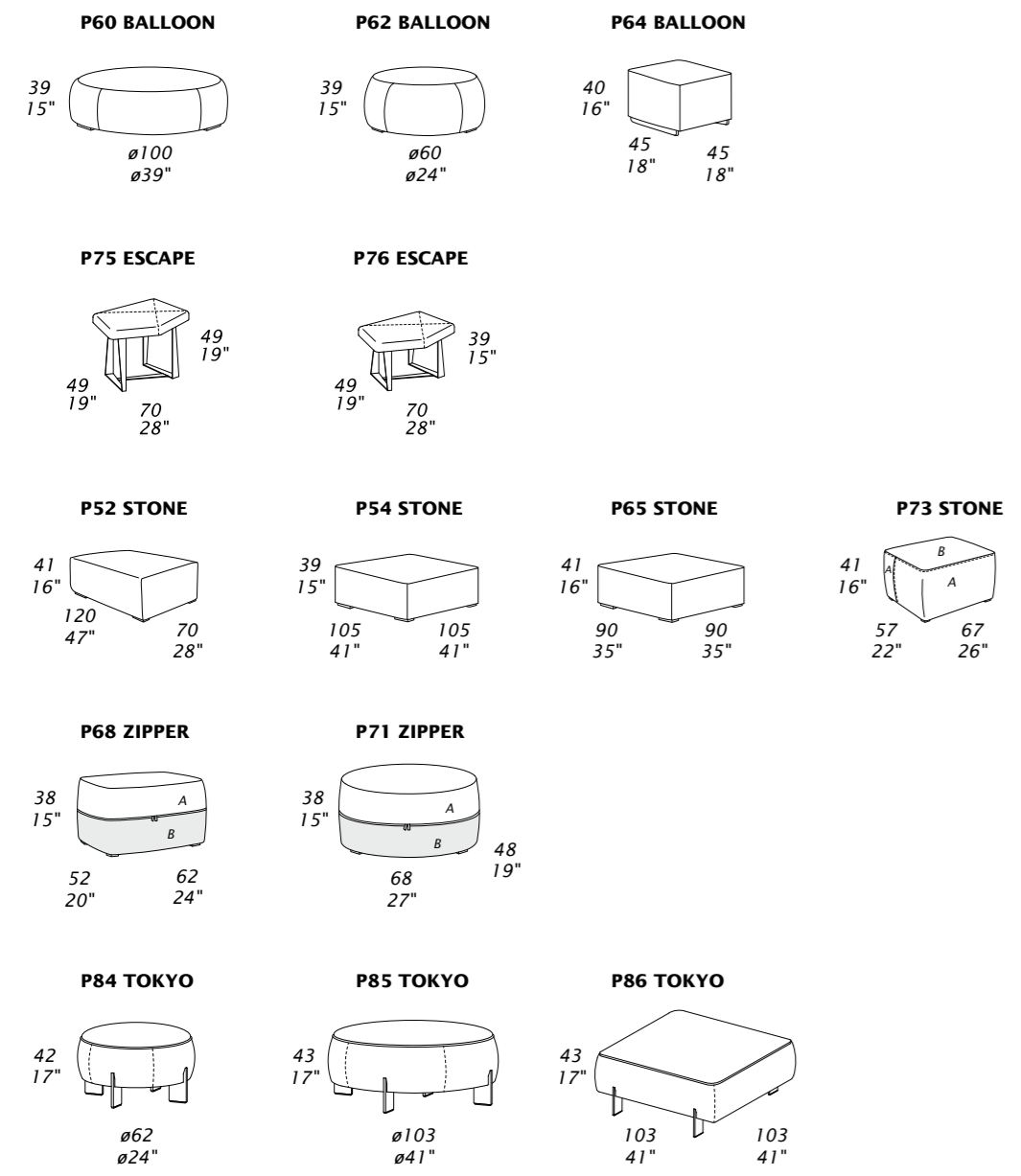

Dimensions: the first figure shows sizes in centimeters, the second in inches.
Each piece is made by hand and has its own uniqueness. Measures may vary with a tolerance up to 3%.

FLOOR PILLOWS

Design Giuseppe Viganò

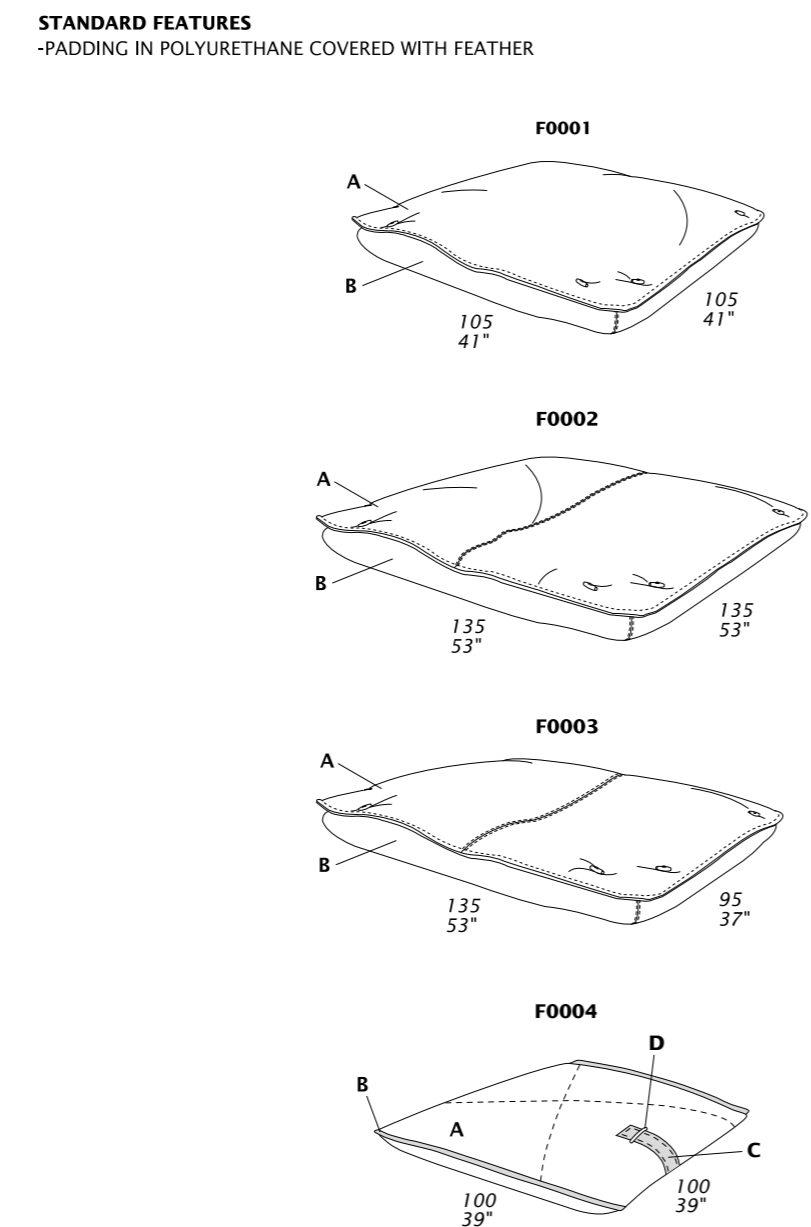

STANDARD FEATURES
-PADDING IN POLYURETHANE COVERED WITH FEATHER

Dimensions: the first figure shows sizes in centimeters, the second in inches.
Each piece is made by hand and has its own uniqueness. Measures may vary with a tolerance up to 3%.

BAGS

Design Giuseppe Viganò

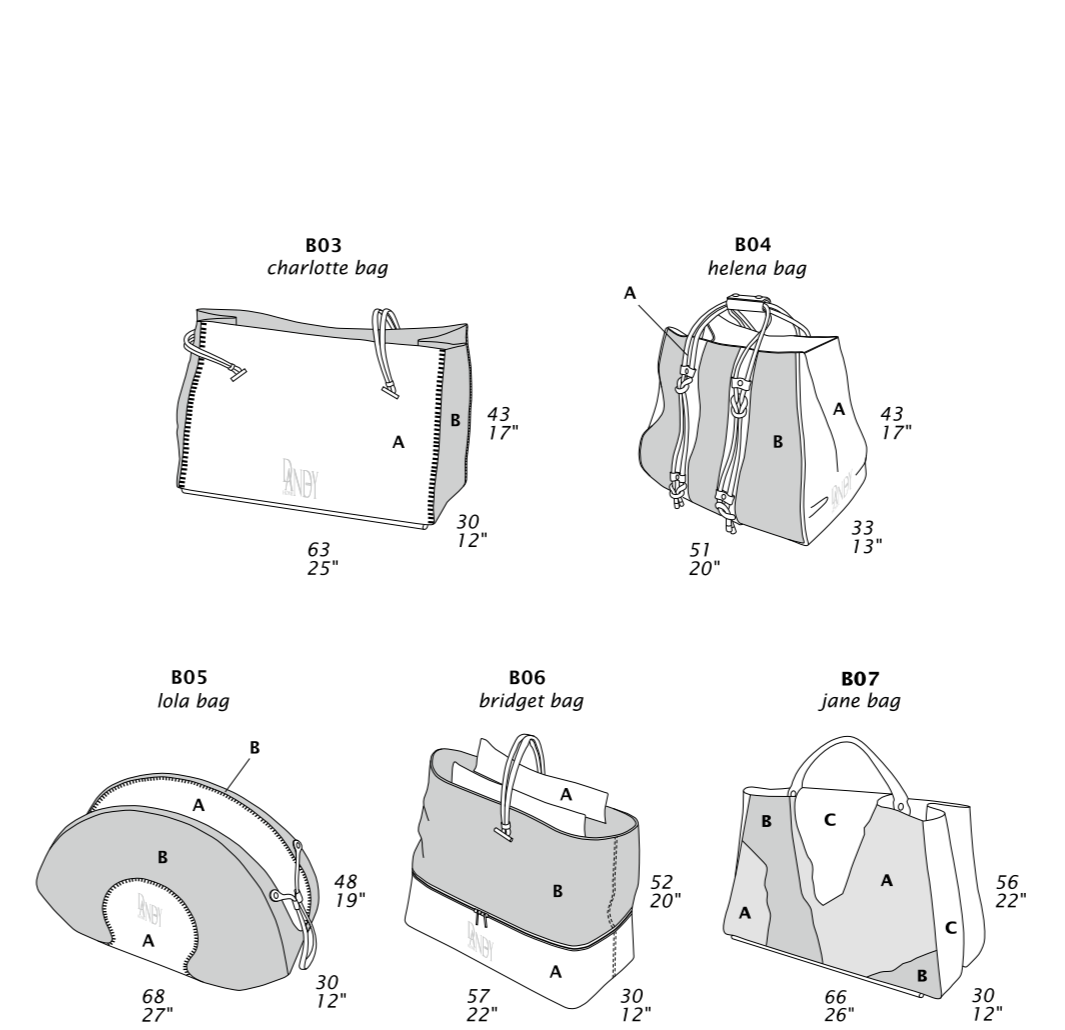

Dimensions: the first figure shows sizes in centimeters, the second in inches.
Each piece is made by hand and has its own uniqueness. Measures may vary with a tolerance up to 3%.
Dandy's Newspapers Bag, coordinated in the same cover and style to the sofa.

BIG BAG

Design Giuseppe Viganò

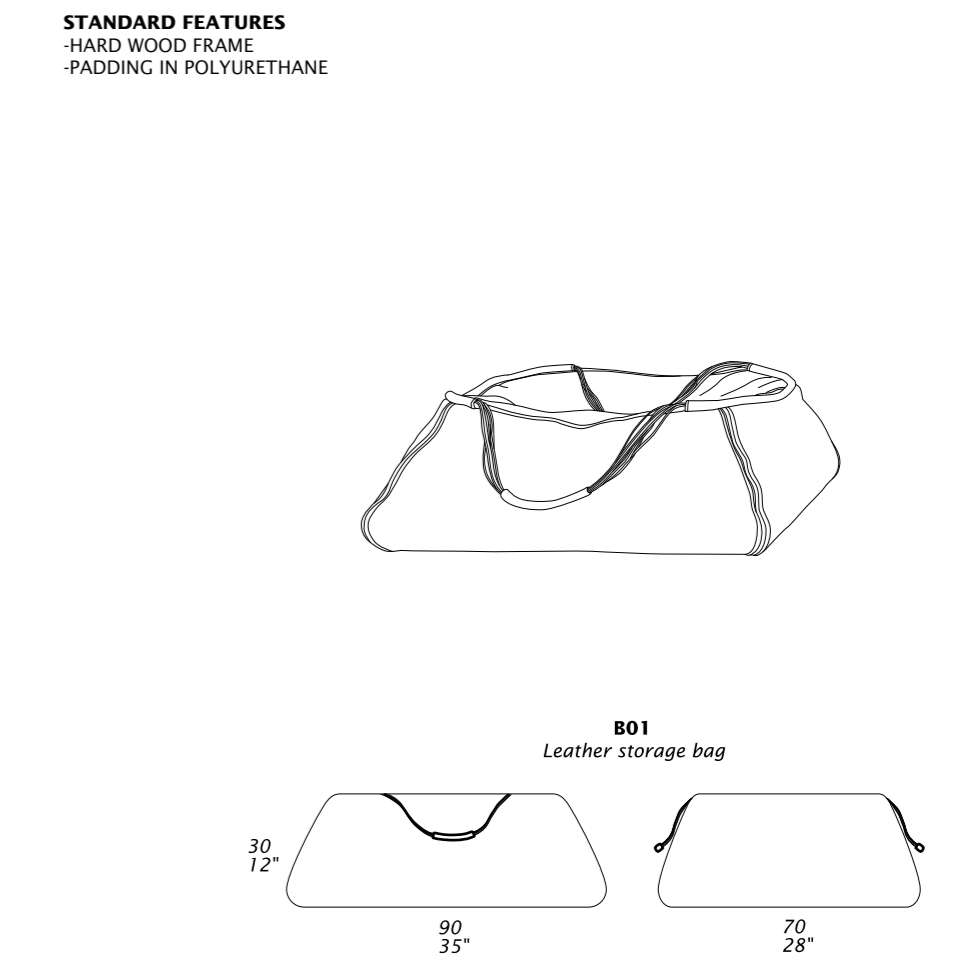

STANDARD FEATURES
-HARD WOOD FRAME
-PADDING IN POLYURETHANE

Dimensions: the first figure shows sizes in centimeters, the second in inches.
Each piece is made by hand and has its own uniqueness. Measures may vary with a tolerance up to 3%.

SMART STOOLS

Design Giuseppe Viganò

TABLE

TOP AVAILABLE ON UP-CHARGE IN:
 - GLASS AVAILABLE IN ALL CUSTOMIZING FINISHES
 - CERAMIC AVAILABLE IN ALL CUSTOMIZING FINISHES

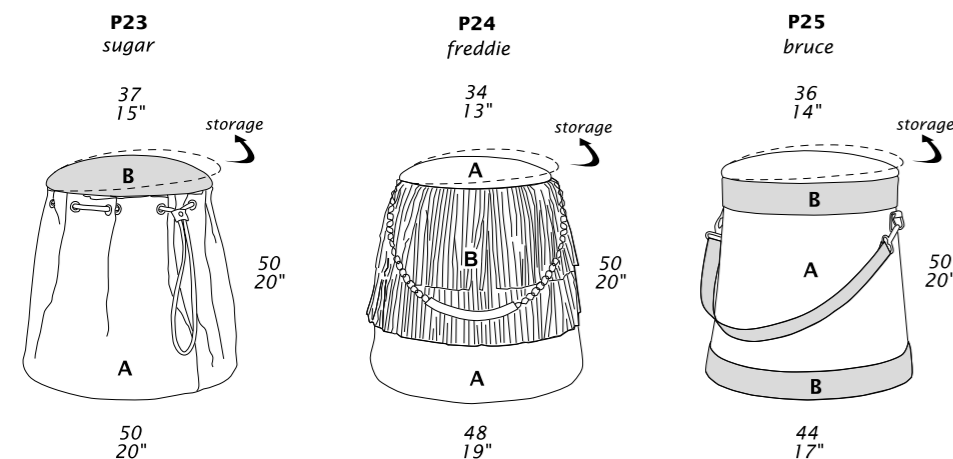

Dimensions: the first figure shows sizes in centimeters, the second in inches.
 Each piece is made by hand and has its own uniqueness. Measures may vary with a tolerance up to 3%.
 Smart stools coordinated in the same cover and style to the sofa.

Technical sheet

SMART ACCESSORIES

Design Giuseppe Viganò

TABLE

TOP AVAILABLE ON UP-CHARGE IN:
 - GLASS AVAILABLE IN ALL CUSTOMIZING FINISHES
 - CERAMIC AVAILABLE IN ALL CUSTOMIZING FINISHES
 - P83 AVAILABLE ALSO WITH MARBLE

NOTES

- COCOON STRINGS AVAILABLE ONLY WITH MAORI LEATHER
 - ROGER B ELEMENT ONLY AVAILABLE IN LEATHER
 - TURTLE HANDLES ONLY AVAILABLE IN MAORI LEATHER

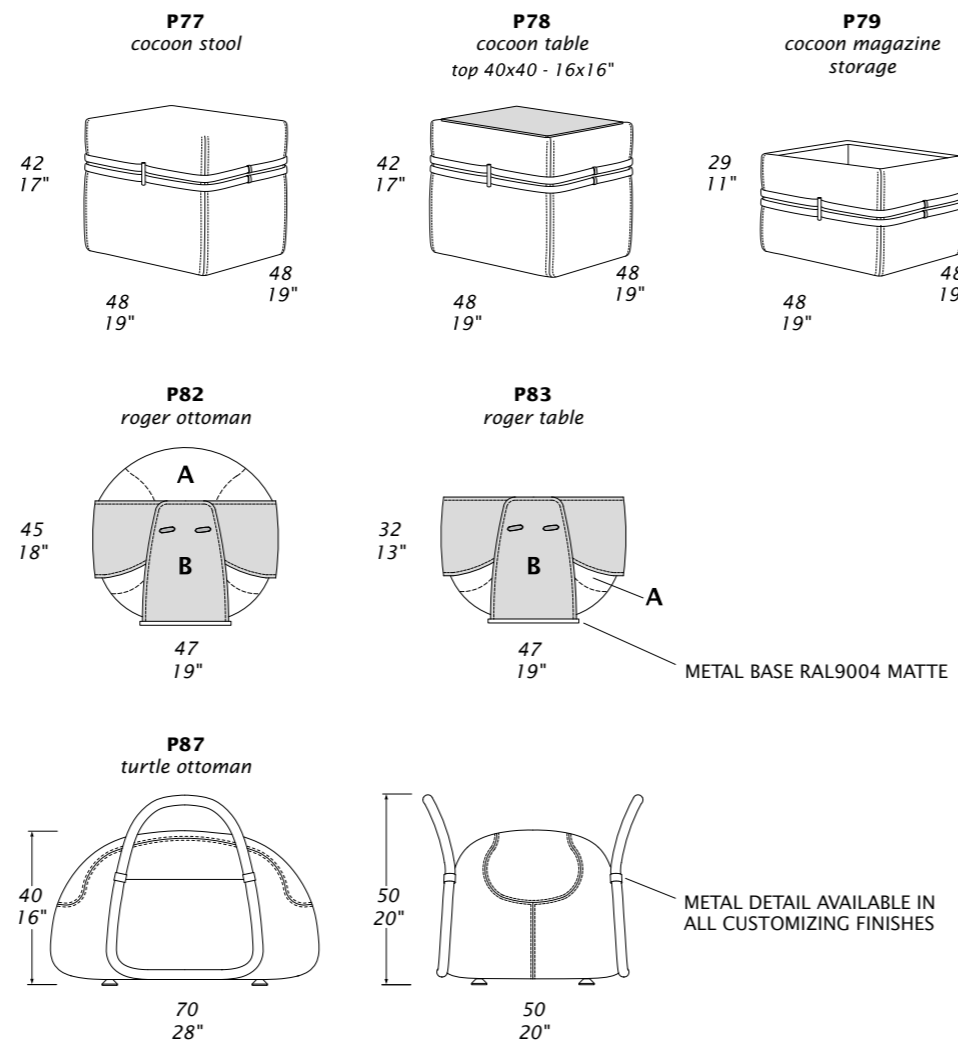

Dimensions: the first figure shows sizes in centimeters, the second in inches.
 Each piece is made by hand and has its own uniqueness. Measures may vary with a tolerance up to 3%.
 Smart accessories coordinated in the same cover and style to the sofa.

Technical sheet

ROYAL PILLOWS

STANDARD FEATURES

- PILLOWS WITH FEATHER FILLING
 - ROLL CUSHION WITH POLYURETHANE FILLING

NOTES

- AVAILABLE WITH ANY STITCHING OF THE COLLECTION

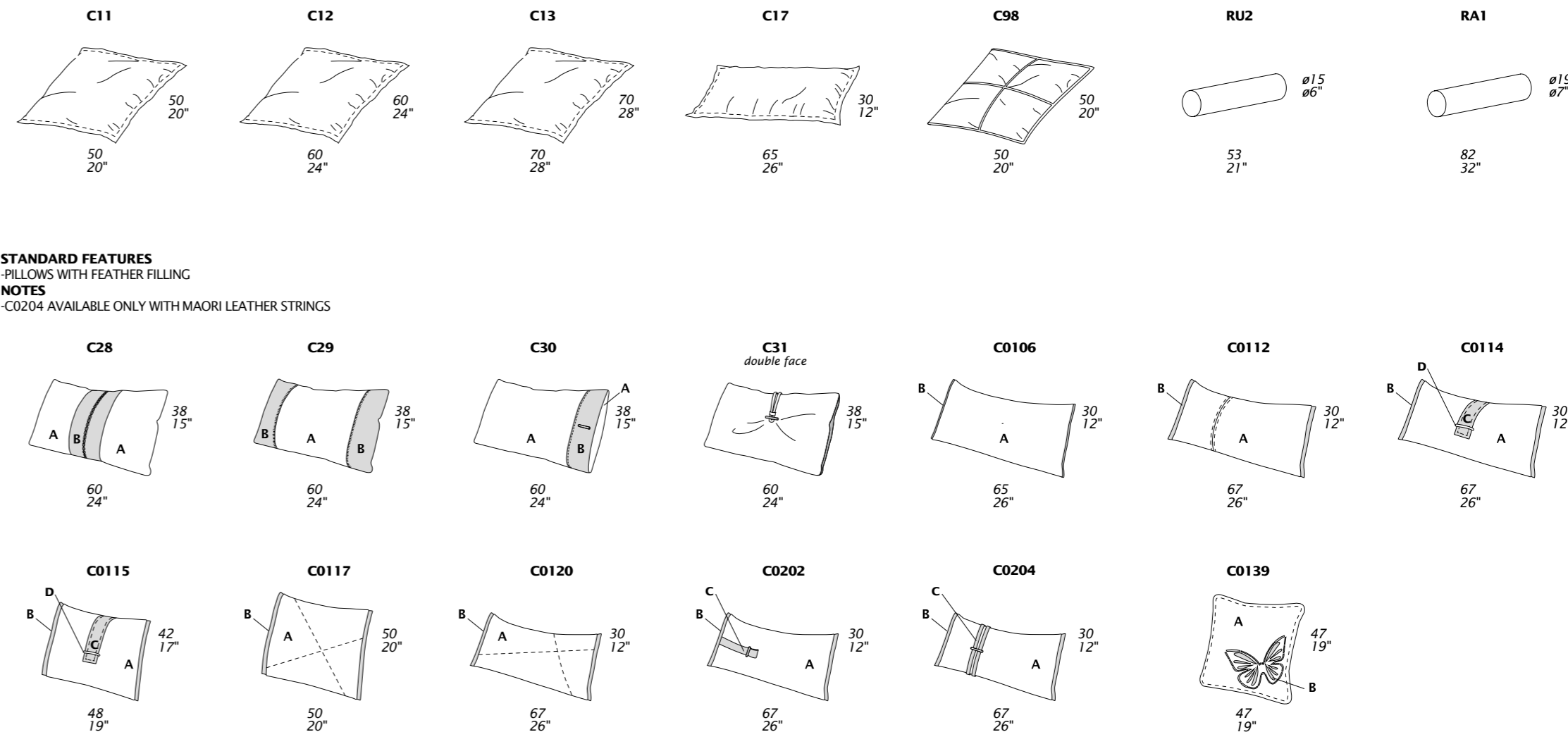

STANDARD FEATURES

- PILLOWS WITH FEATHER FILLING

NOTES

- C0204 AVAILABLE ONLY WITH MAORI LEATHER STRINGS

Dimensions: the first figure shows sizes in centimeters, the second in inches.
 Each piece is made by hand and has its own uniqueness. Measures may vary with a tolerance up to 3%.

Technical sheet

CUSTOMIZING

METAL FINISHES



RAL 9003 - SIGNAL WHITE

RAL 8019 - GREY BROWN

RAL 9005 - JET BLACK

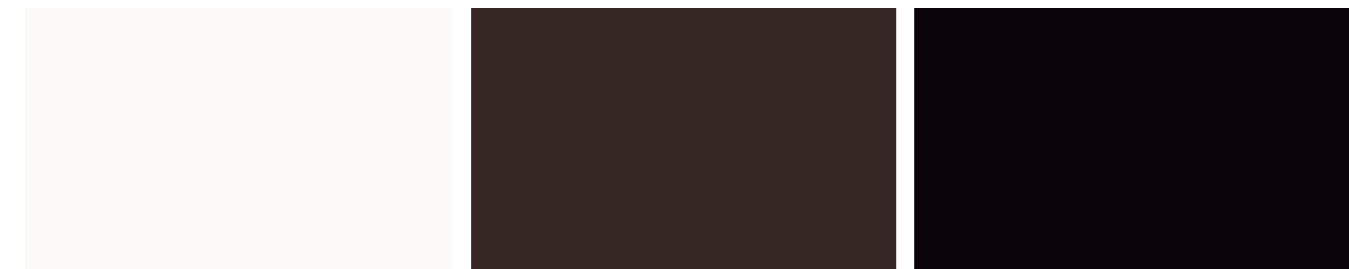

WOOD

WENGÉ COL.06

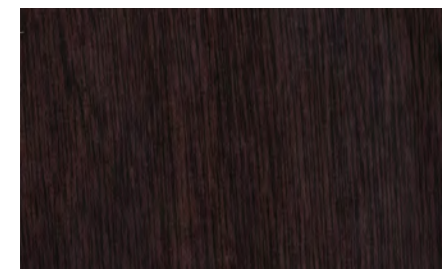

GLASS TOP FINISHES

BACK LAQUERED BLACK - RAL 9005

BACK LAQUERED WHITE - RAL 9003

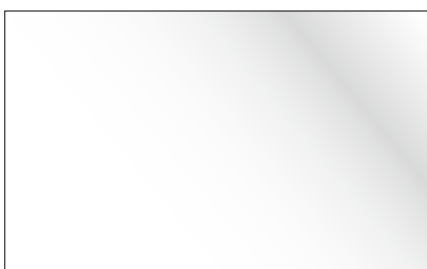
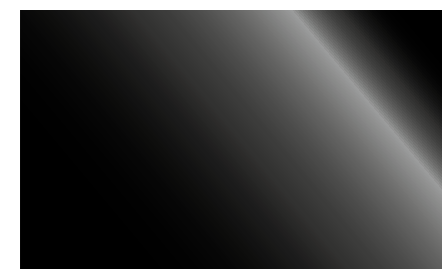

CUSTOMIZING

CERAMIC TOP FINISHES

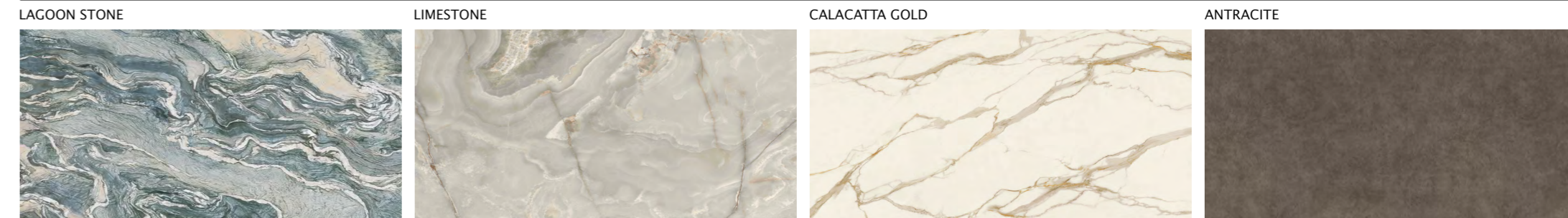

TERRA

NOIR DESIR

OSSIDO BRUNO

STONE GREY

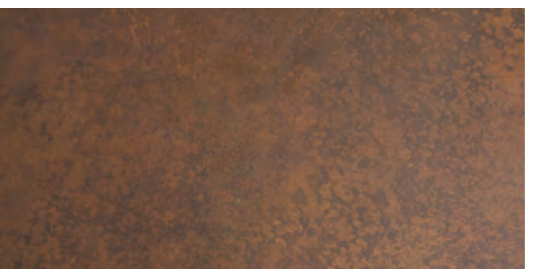
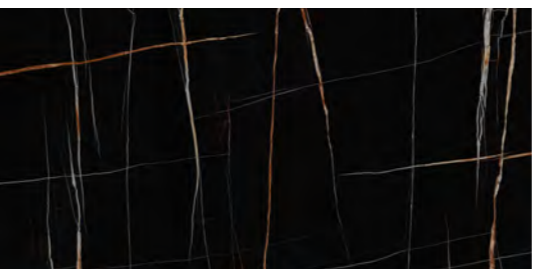
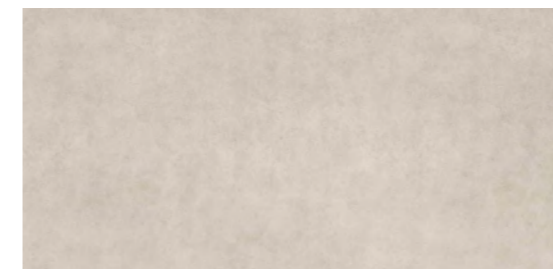

PATAGONIA

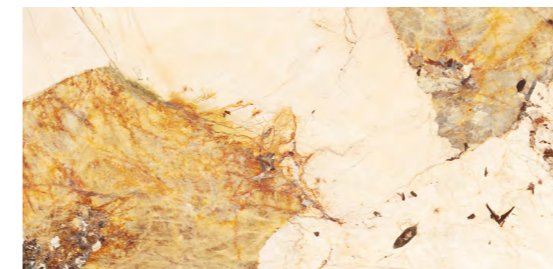

N.B. EACH CERAMIC CAN EXHIBIT COLOUR AND STRUCTURAL DIFFERENCES.

MARBLE TOP FINISHES

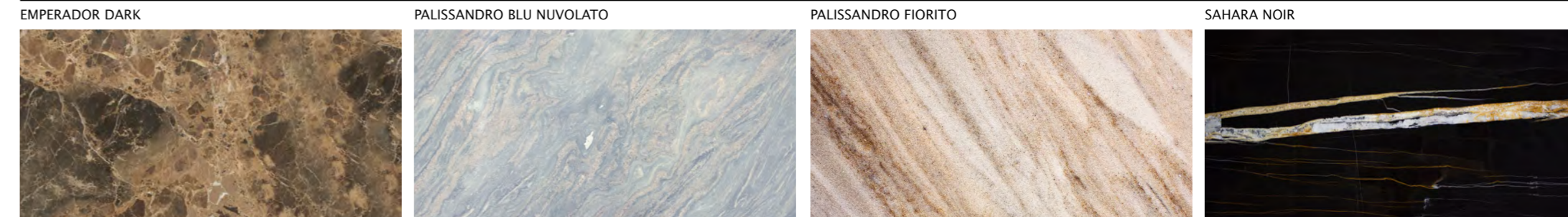

N.B. EACH MARBLE, BEING A NATURAL PRODUCT, IS A ONE-OF-A-KIND PIECE AND CAN THEREFORE EXHIBIT COLOUR AND STRUCTURAL DIFFERENCES.

AD STUDIO VIGANÒ

PHOTO EOLO RADONI

PREPRESS MONOGRAMMA

PRINT GRAFICA GIOIA

DANDY
HOME COLLECTION

100% hand made in Italy

by

GAMMA ARREDAMENTI INTERNATIONAL Spa

PART OF

DEXELANCE

HEADQUARTERS

Via PITAGORA 3 - 47121 FORLÌ (FC) - Italia

PH. +39 0543 708311

e-mail: info@gammarr.it

USA Branch

GAMMA ARREDAMENTI INTERNATIONAL Inc.

7-F WENDY COURT, GREENSBORO, NC 27409

PH. +1 336 886 8060

e-mail: infousa@gammarr.it

