



OUTDOOR

FRITZ HANSEN



Contents

Welcome to Fritz Hansen	6
Outdoor Designs Crafted to Last	9
Dining	11
Lounge	43
Sunlounging	67
Umbrellas	81
Materials	91
Collection	107

Welcome to Fritz Hansen

Discover our curated range of outdoor furniture, umbrellas and cushions. Co-created with renowned architects and designers, the collection's design language originates from Danish functionalism and woodcraft traditions in outdoor furniture, transformed into contemporary and relevant pieces.

Explore pieces known for their functionality, durability and relevance over the decades - and new designs yet to write history.





Outdoor Designs Crafted to Last

At Fritz Hansen, longevity is more than a design principle: it's a way of thinking. From the materials we choose to the way each piece is crafted, everything is considered with time in mind. We create furniture not for seasons, but for generations.

Every curve, joint and surface is made to endure daily life, gaining character, not wear. Our designs are built with integrity, using high-quality materials that age gracefully. Spare parts and thoughtful construction ensure that each piece can be cared for, maintained, and enjoyed well into the future. In a world that moves quickly, we take a longer view. Because true sustainability starts with making something so well, there's no reason to replace it.

Dining



Outdoor tables and chairs for shared meals.



Vind

The Vind series is defined by sculptural lightness and references to sails and Denmark's maritime landscape. Cleanly cut aluminium frames are paired with handwoven polyester cord seats, balancing visual clarity with lightness, comfort and durability. Crafted for longevity and everyday use, Vind brings a quiet, contemporary expression to outdoor dining and social spaces. Designed by Kasper Salto.



“I think a chair should be very comfortable, no matter how long you sit. I’ve used a double-curved geometry in the back. It allows you to sit in several ways, and the chair adapts better to the body with that form.”

KASPER SALTO, DESIGNER

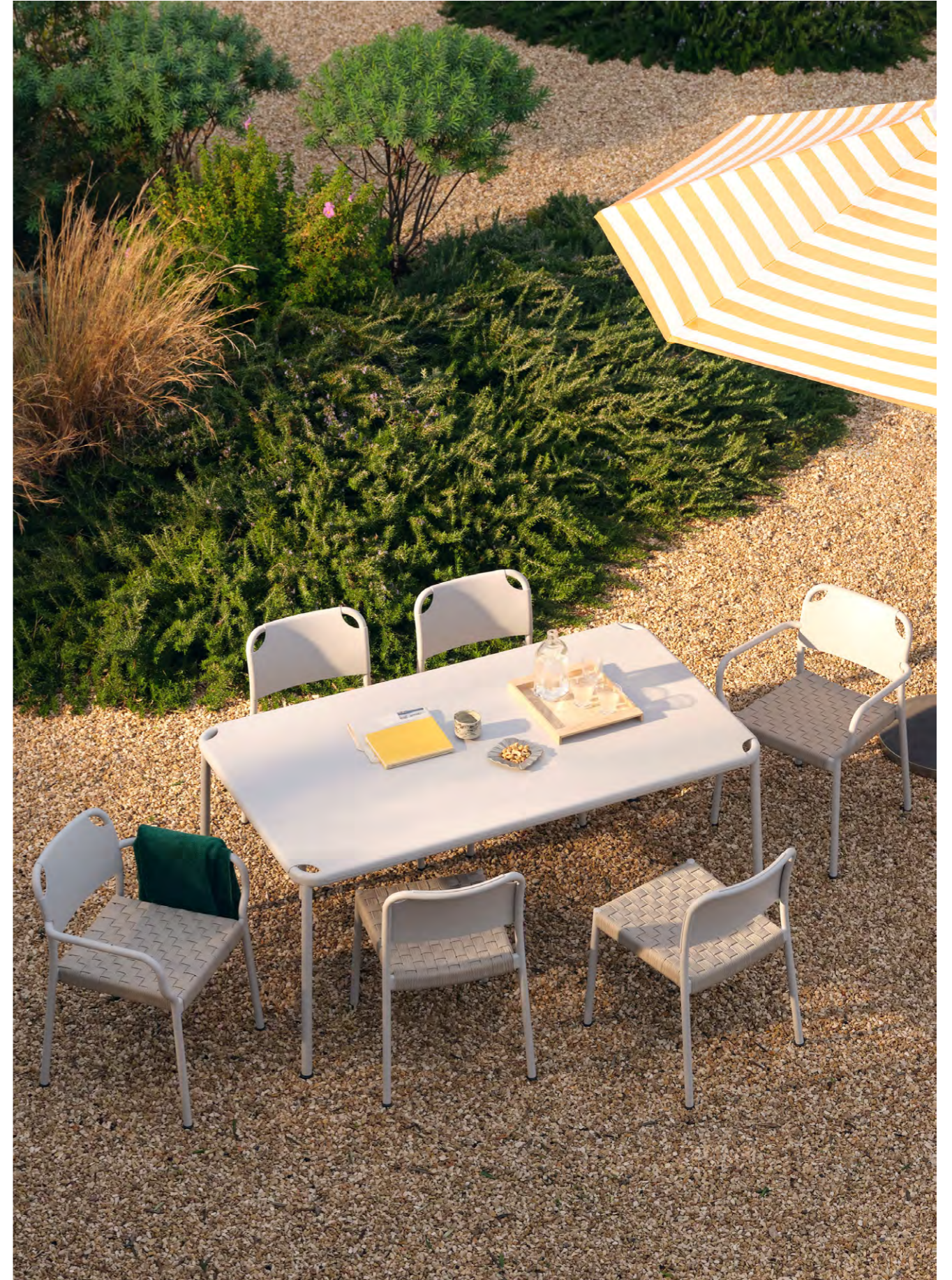

Kasper Salto,
Designer



VIND SERIES

An Outdoor Series Designed for Louisiana Museum of Modern Art

The Vind series continues the long-standing dialogue between Kasper Salto and Fritz Hansen. Created for the outdoor spaces of the Louisiana Museum of Modern Art, the series takes its name from the Danish word for wind and reflects the openness and calm of the coastal landscape that surrounds the museum.

"It's made to serve people well, like a good host that doesn't draw attention to itself!"
— Kasper Salto

For Salto, Vind begins with a simple ambition: to create furniture that behaves well. "The Vind chair is a tool for sitting," he says. Designed to serve rather than stand out, Vind is quiet in its presence, supporting architecture, landscape, and social life without competing for attention.

Comfort is at the heart of the design. A double-curved backrest follows the body naturally, encouraging relaxed posture over long periods outdoors. This is paired with a handwoven seat where craftsmanship plays a defining role.





The woven surface offers softness and subtle elasticity, making cushions unnecessary and inviting people to linger, unhurried.

Made from aluminium, Vind is light to move yet impressively strong, without the heaviness or rust concerns associated with outdoor steel furniture. Stackable and easy to handle, the chairs adapt effortlessly to changing settings and uses.

Comprising chairs and a dining table in a restrained palette, the Vind Series is designed to belong quietly to its surroundings. Shaped by wind, place, and human use, it is outdoor furniture that serves its purpose with ease, wherever it is placed.

“It’s comfortable, strong,
long-lasting, and
calm in its expression.”

KASPER SALTO, DESIGNER

About the designer

Danish designer Kasper Salto is guided by the principle of less but better. Trained as a cabinetmaker before studying industrial design at the Royal Danish Academy, he creates furniture shaped by care for the human experience. Salto advocates for design that prioritises quality, longevity, and purpose. “We can’t afford not to care,” he says, a reminder that thoughtful design takes time and that the best products are created to last.



Workshop



Prototype



Drachmann

Designed in collaboration with Danish designers, Mogens Holmriis and Bernt Santesson, the balanced forms of the Drachmann series of tables and seating pairs Nordic nostalgia with modern simplicity.

Drachmann Bench Cushion in Lines, Light Apricot/Dark Green Stripe



Drachmann Chair, Table 156 and Bench 165 & Messina Umbrella (Ø270) in Off-White



Drachmann Bench (200) with Cushion in Heritage, Papyrus and Table (190)



Ballare

The Ballare series is defined by a warm character, durable materials, and careful detailing. Crafted in teak with stainless steel fittings, the designs are made for use under open skies and will develop a natural patina over time. The series includes dining tables in both fixed and extendable formats, as well as a matching chair. Designed by Danish designer Jakob Berg.





Ballare Armchair and Table (Extendable)



Colour: Light Ivory



Pelagus

The Pelagus series contains a range of differently sized tables and comfortable chairs in genuine, long-lasting materials. Crafted in solid teak and powder coated aluminium, the series' signature look is slender, contemporary and light without compromising comfort or utility.

Pelagus Armchair in Light Ivory and Chair Cushion in Panama, Ash



“When designing Pelagus, we envisioned moments of relaxation and enjoyment, aiming to create furniture that is generous, inviting and comfortable.”

NOTE DESIGN STUDIO





Selandia

Selandia's signature slight curves and elegant Nordic look with subtle French references that hint at long summer nights in the open air. Crafted from FSC™-certified teak, the Selandia series of tables and chairs is made to age beautifully. Spare parts are available to ensure it lasts a lifetime.

Selandia Table

Selandia Armchair and Chair with Cushion in Heritage, Papyrus & Messina Umbrella (Ø300) in Off-White



Cadence

Cadence outdoor series by contemporary Parisian designer, Aurélien Barbry, is characterised by simplicity and functional beauty, crafted in highest-quality, long lasting teak. An architectural repetition lends the Cadence series a clean and modern elegance.

Cadence Bench, Chair and Table &
Messina Umbrella (300) in Lines, Light Apricot/Dark Green Stripe

“The Cadence Bench is the result of an idea to challenge the function of the ubiquitous seating design, and an investigation into how I could design this piece of furniture differently. I wanted to use a minimum of materials and create something airy, playful, modern and easy to build.”

AURÉLIEN BARBRY, DESIGNER

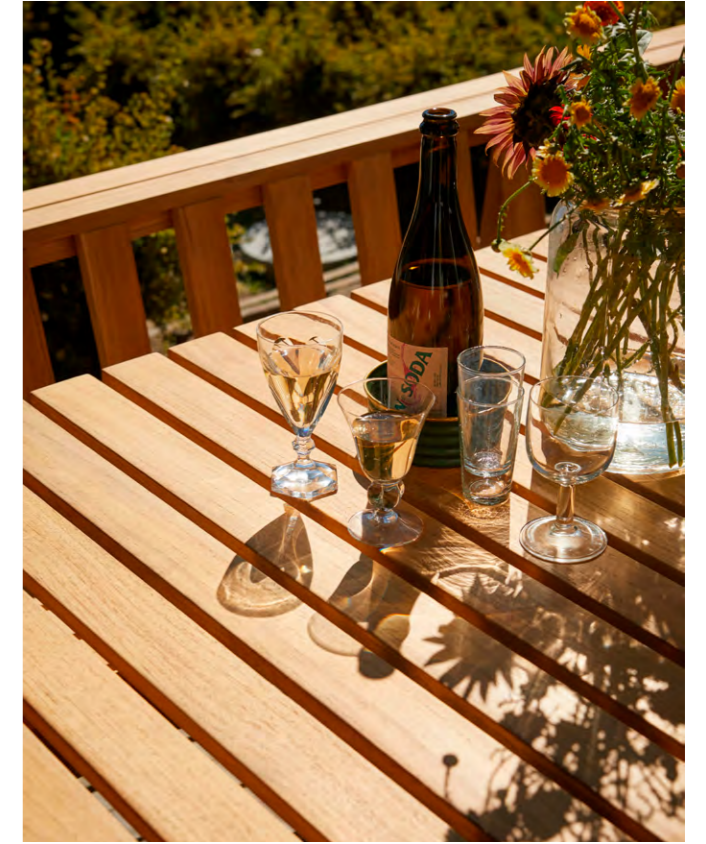

Cadence Table and Chair

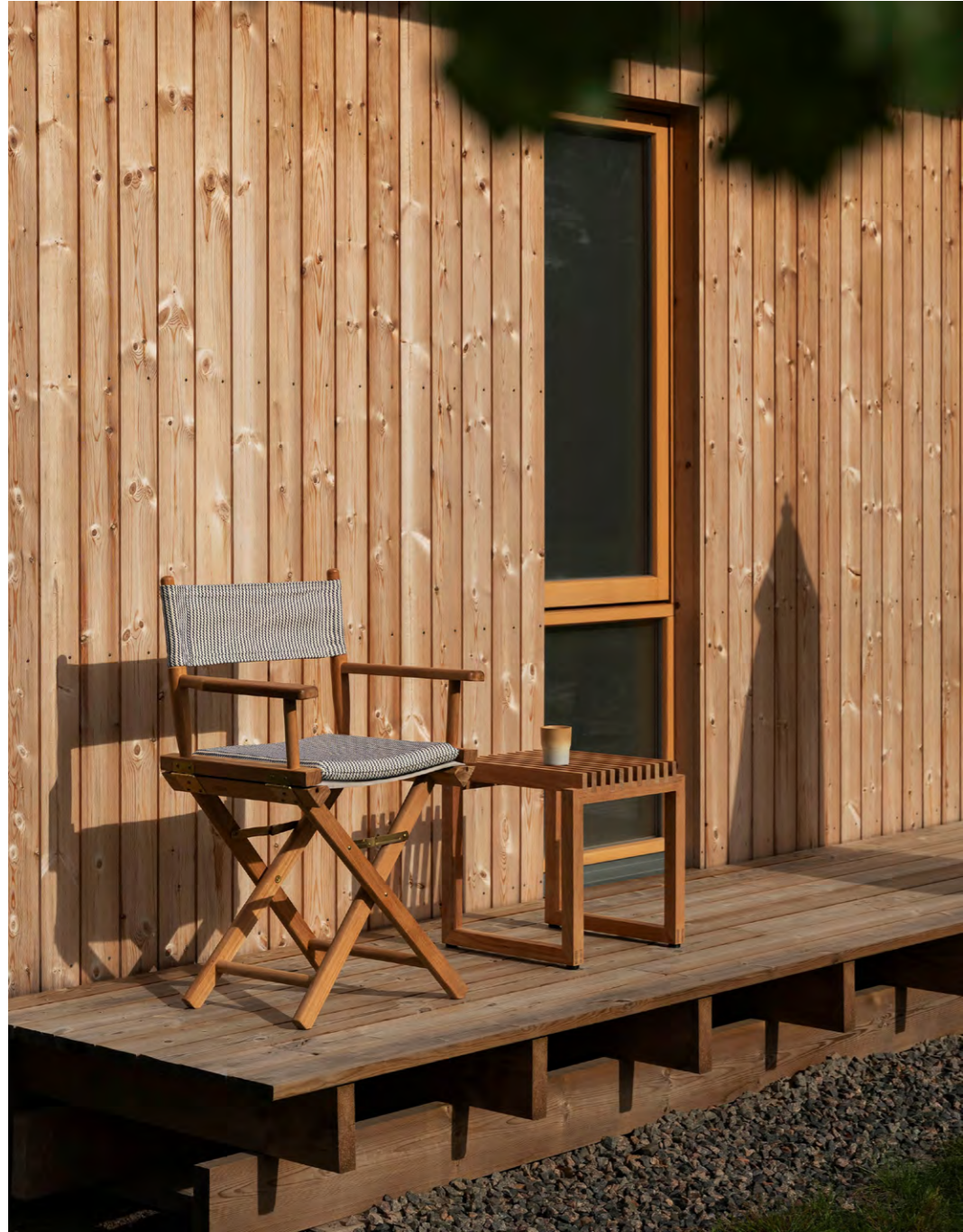

Director's Chair

Director's Chair is a Nordic interpretation of the classic director's chair, defined by a clear silhouette and a foldable construction. Crafted with a solid teak frame and brass fittings, the construction is precise and durable, with materials chosen to age well over time. Available in both indoor and outdoor-ready versions.



Vendia

Made with smaller spaces in mind, Vendia series delivers the elegance of traditional outdoor furniture in a scaled-down design. Ideal for balconies, patios and terraces where space is at a premium.



Lilium

Inspired by the shape of a lily pad and crafted in teak and stainless steel, the sturdy yet lightweight Lilium series offers a contemporary and elegant dining experience.





Skagen

Drawing inspiration from the natural beauty of Northern Denmark, the Skagen series is an open invitation to elegant outdoor dining.



Lounge

Outdoor seating for relaxed moments.

Tradition Sofa in Panama, Charcoal & Barriere cushion (60x50) in Honey Yellow



Virkelyst

Clean lines, discreet details, high comfort. The thick, soft and comfortable cushions in Virkelyst are made for relaxing for hours in sunny outdoor spaces.





Virkelyst Chair and Sofa (3-seater) in Panama, Cloud White and Table



Tradition Sofa in Lopi, Light Sand

“Tradition elaborates on traditional spindle furniture designs, drawing clear references to mid-century renditions of chairs. At the same time, it draws on the way we seek to create personal spaces in furniture design for rest and relaxation.”

POVL B. ESKILDSEN, DESIGNER



Tradition Lounge Chair in Lopi, Light Sand and Table (H27, H40)

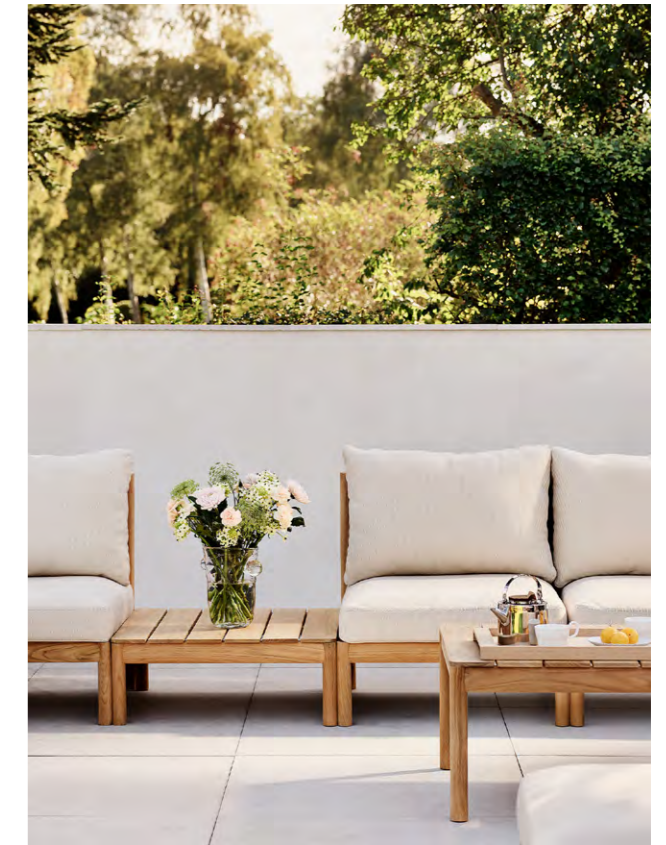

Tradition

Tradition is a modular outdoor lounge series defined by its spindle-back frame and generous comfort. Crafted from FSC™-certified core teak and paired with soft, weather-resistant cushions, the series brings together precision woodcraft, naturally oil-rich teak, and textiles designed for lasting outdoor enjoyment.

Seating modules are complemented by matching tables, allowing Tradition to adapt easily to different spaces and ways of spending time outdoors.



Tradition Sofa in Summertime, Clementine and Table (H27, H40)



Pelagus

Bring outdoor spaces to life with the minimalist and elegant Pelagus series. High on comfort with a clean design, the series' signature look is slender, contemporary and light without compromising comfort or functionality. Designed in collaboration with Swedish Note Design Studio.

Pelagus Lounge Chair, Tradition Table (H40)
& Messina Umbrella (Ø210) in Off-White



Between Lines

Crafted with comfort, quality and durability in mind, Between Lines deck chair and stool have a restful expression, perfect for enjoying life slowly in the great outdoors. Designed in collaboration with Danish designer Stine Weigelt.

“The name ‘Between Lines’ emerged from observing how light moves through the chair’s lines. The shadows on the ground became a natural extension of the design, constantly changing depending on light and surroundings.”

STINE WEIGELT, DESIGNER





Between Lines Deck Chair



“I wanted to make it as pleasant as possible for people to enjoy the nature. The sun moves so the double bench can be used on either side and while seeking to design a backrest for comfort I also tried to achieve beauty. The end result is somehow reminiscent of a Japanese daruma or edamame bean, bringing a sort of unexpected softness and dynamism to the strong straight lines of the long teak planks of the seat...”

HUGO PASSOS, DESIGNER



Banco

The Banco bench by Portuguese designer Hugo Passos enhances the outdoor experience with its simple yet elegant design, crafted for comfort and support. Made from FSC™-certified teak, its gentle curves and timeless material patinate to a beautiful silver-grey, offering a perfect space to enjoy nature.





Lilium

The Lilium series is a contemporary take on outdoor furniture designed by the renowned Danish architects Bjarke Ingels Group (BIG). Made of just two materials: teak and stainless steel, Lilium is long-lasting furniture, perfect for outdoor events and gatherings.

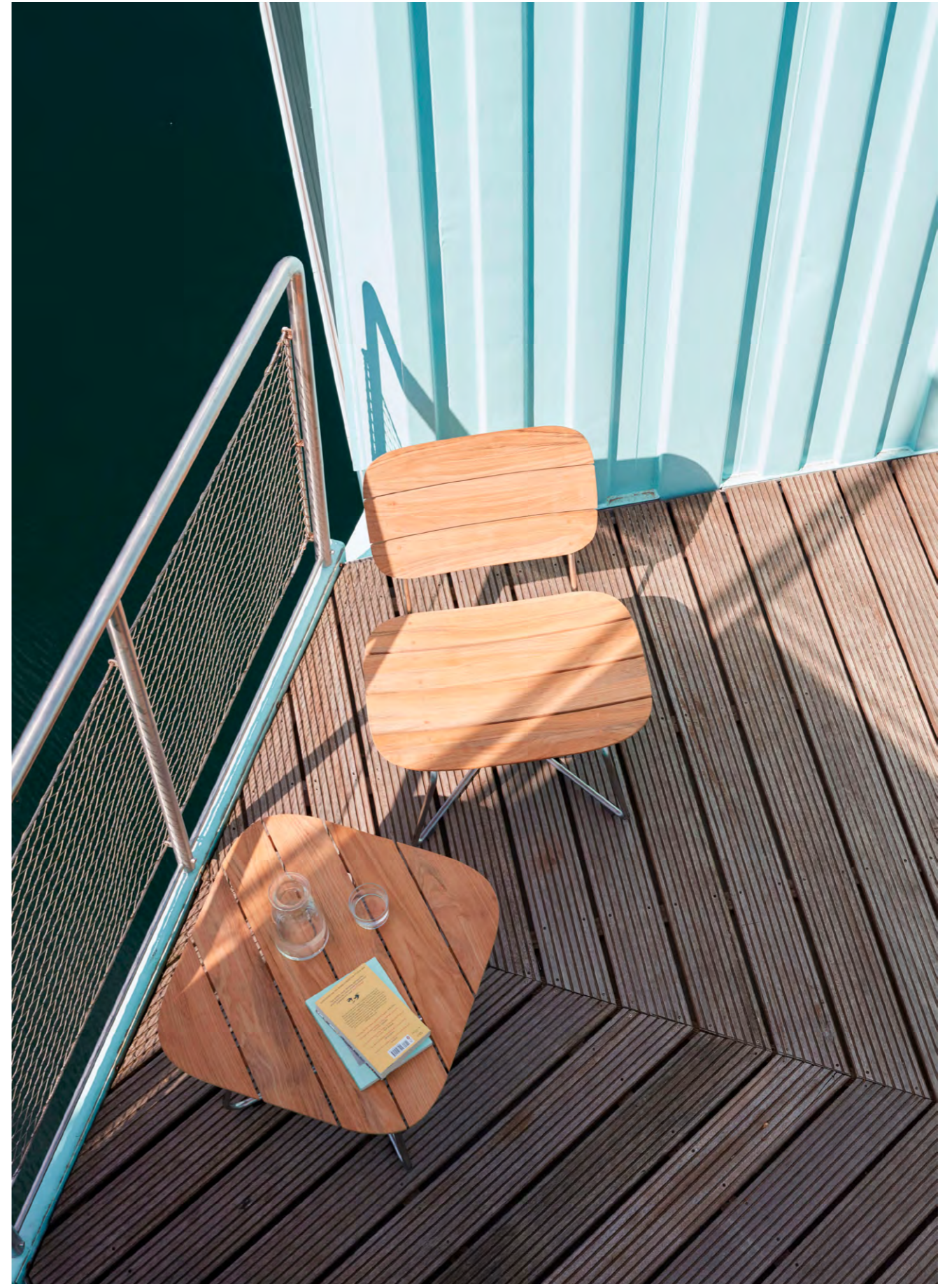



“It is essential that the bench does not make noise or disturb the spatial experience. An expression that closes in on itself and leaves the surrounding space undisturbed.”

NIELS HVASS, DESIGNER

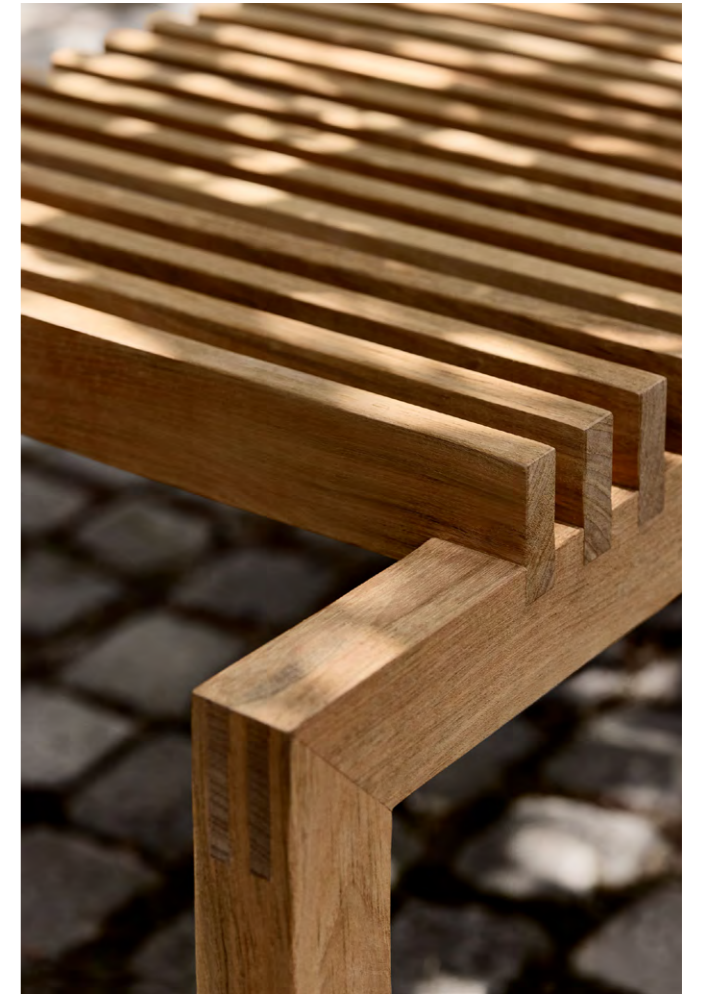

Cutter

The iconic Cutter bench and stool in teak are minimalistic, functional and eye-catching designs for everyday outdoor and indoor use. Designed in collaboration with Danish designer, Niels Hvass.



Textile: Lopi, Honey Yellow

England

A reimagining of the classic park bench found in idyllic English gardens, bringing charm and elegance wherever it is placed. Crafted from teak, it offers durability and lasting comfort with each unhurried moment.





Sunlounging

Outdoor loungers for time in the sun.

Pelagus



“Whoever you are and wherever you are, at home or in a hotel in LA, Italy or Morocco, when you lie down on the sunbed you just want that relaxed laidback feeling.”

NOTE DESIGN STUDIO

Pelagus Sunbed with Cushion in Panama, Charcoal



Pelagus Sunbed, Cutter Stool & Atlantis Umbrella (Ø330) in Off-White



Pelagus Sunbed

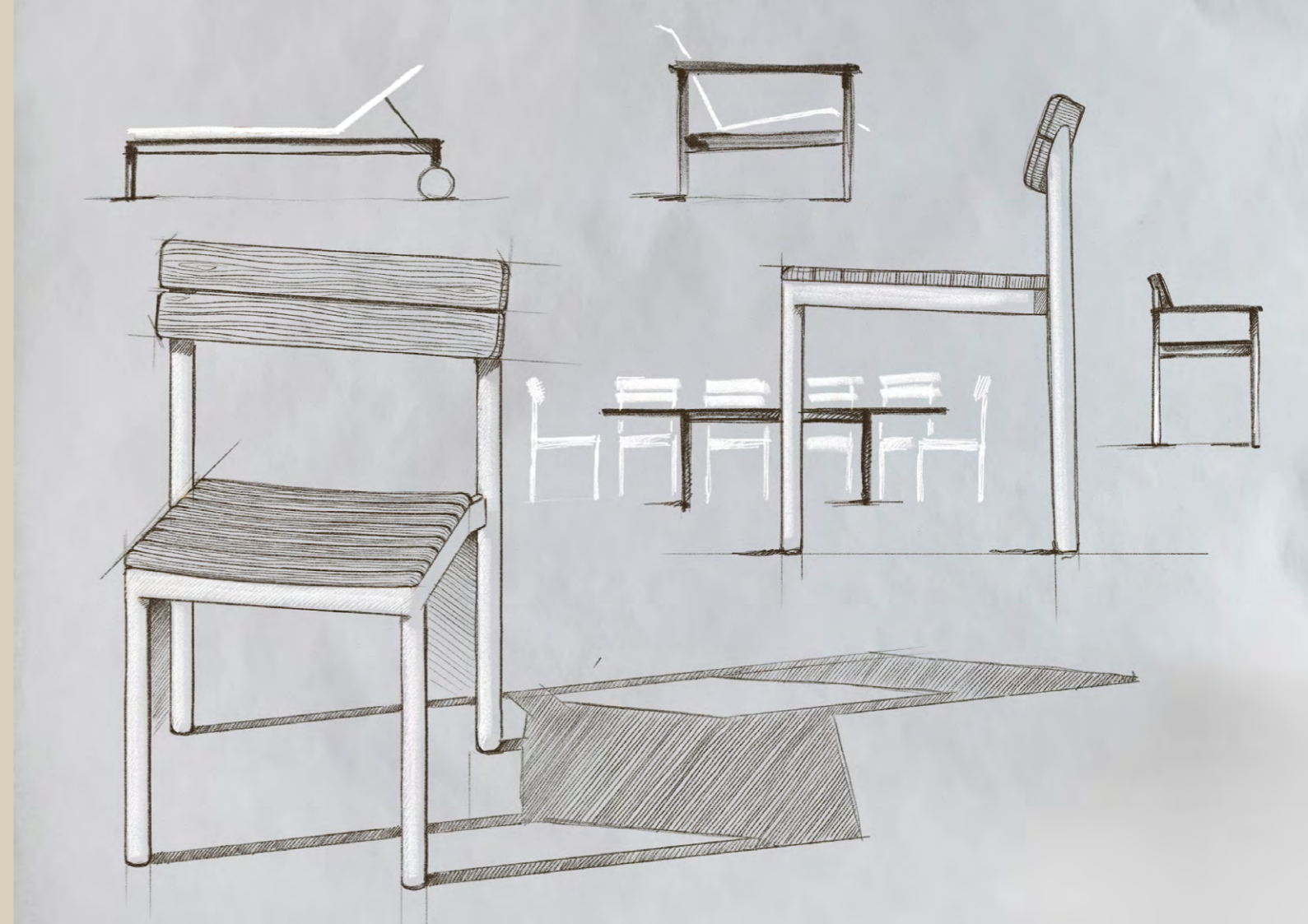

PELAGUS SERIES

Bring Spaces to Life

Pelagus is designed to blend in rather than stand out. Its calm expression and generous comfort allow spaces to unfold naturally, supporting moments of rest, conversation, and togetherness without dictating how they should happen.

“Furniture should seamlessly blend into any environment without overwhelming it.”

NOTE DESIGN STUDIO

The Pelagus Series is designed by Note Design Studio and shaped by a relaxed, adaptable approach to outdoor life. Inspired by the rhythm of the Stockholm archipelago, Pelagus is furniture made to feel at ease in many settings, from urban terraces to places closer to nature.

About the designer
 Note Design Studio is a multidisciplinary design studio based in Stockholm. Working across architecture, interiors, furniture, and graphic design, the studio approaches each project holistically, always considering how objects live within a space. Their work is defined by clarity, curiosity, and a strong sense of atmosphere, creating designs that feel both thoughtful and quietly expressive.





Pelagus Sunbed with armrests



“The design has lived on for more than 35 years. One reason is its graphic look – many beautiful photos have been taken of it. Then there’s its ability to be packed away when not in use, and, of course, its flexibility. It doesn’t have to be fully extended to be functional. Closed, it becomes a table. It’s a piece of furniture with many uses.”

POVL B. ESKILDSEN, DESIGNER



Riviera

Renowned for its flexibility and straightforward appearance, Riviera transforms to suit myriad purposes. The ingenious construction is adjustable by design in both expression and functionality. Add a cushion for extra comfort, neatly pack away when not in use. Designed in 1991 by Danish designer Povl B. Eskildsen.





Riviera Lounge with Cushion in Beatrice, Blue



Steamer

Sail away on Steamer Deck Chair – a modern rendition of the classic sun lounger, its flowing lines are inspired by the curves of a cruise ship.

Steamer Deck Chair



Columbus

The Columbus Sunbed is shaped from solid teak with wonderfully comfortable SunTexture fabric. Stable and durable, its back wheels make it easy to move into the sun or shade, while the backrest is adjustable to multiple positions.

Columbus Sunbed



Umbrellas

Outdoor umbrellas crafted to provide shade.



Atlantis Umbrella (Ø330) in Off-White



Atlantis

A leather-reinforced textile adds strength, while an aluminium-reinforced pole protects the wood from wear and scratches. The double-pulley system makes opening and closing the Atlantis umbrella series easy.

Atlantis Umbrella in Off-White



Messina Umbrella (Ø300) in Lines, Lemon/Sand Stripe



Messina

Crafted from long-lasting lacquered kapur wood and with a clean design, Messina will protect from the sun, shading hot summer days for many years to come.

Messina Umbrella (Ø270) in Off-White



Pelagus Sunbed



Messina Umbrella (Ø270) in Golden Yellow Stripe

Materials

Materials chosen for durability, performance, and long-term use outdoors.

Teak

We use teak for most of our outdoor furniture, as it requires little care and maintenance. All of the teak in our outdoor furniture is FSC™-certified. The high content of natural oils makes the teak highly weather and rot resistant and is, therefore, an excellent choice for outdoor furniture.

We only use core teak because it is richer in natural oils making it evenly grained, more weather resistant and longer lasting than the outer teak wood.



Teak is a heavy, hard and sturdy wood type but also an organic material. Teak will naturally expand and contract with changes in temperature and humidity, and can cause small scratches or marks to appear. Remember to re-tighten the fittings from time to time.

Brand new teak furniture has natural colour differences found in the freshly cut wood. Once the furniture has been exposed to the sun, these colour differences will even out. As a natural part of the aging process, the surface of teak will change when first exposed to rain; this is the primary stage of a process of wood that ages beautifully over time.



New



Patinated

CARE & MAINTENANCE

The easiest way to maintain teak is to leave it untreated. This does not affect the durability or quality of the furniture. Untreated teak will develop a patina over time and eventually become a beautiful silvery-grey colour.

It is important to prolong the furniture's lifespan by cleaning it at least once a year. This will remove algae and dirt and make the furniture more resistant in all weathers, all year round. To preserve or intensify the original honey-golden colour of fresh teak, use a suitable furniture oil on a regular basis.

See care guide:



Aluminium

Aluminium is used in several of our outdoor furniture series for its strength, light weight, and resistance to corrosion. The material performs reliably outdoors and can be recycled.

Selected finishes are chosen for durability and everyday use. Over time, aluminium surfaces may show subtle signs of wear, reflecting use rather than deterioration.



CARE & MAINTENANCE

Regular cleaning with mild soap and water is sufficient to maintain the surface. Abrasive cleaners should be avoided.

Upholstery

The outdoor collection includes a selection of upholstery types developed specifically for outdoor use. The upholstery is chosen to support comfort and elevate aesthetics, while meeting the practical demands of outdoor environments.



Textile

Our outdoor textiles are developed to perform in changing weather conditions, resisting water, dirt, and mildew while offering high colour and light-fastness. The result is durable textiles with smooth, tactile surfaces suited to everyday outdoor use.

Designed to dry quickly after exposure to rain or moisture, the textiles support comfortable use throughout the day. Easy to maintain, the upholstery can be cleaned with minimal effort, helping cushions and pillows retain their appearance and comfort over time.

Our textiles for outdoor cushions and pillows are OEKO-TEX®-certified*.



Sling & SunTexture

Sling and SunTexture fabrics are used in selected outdoor seating where flexibility and support are integral to comfort. Tensioned across the frame, the material adapts to the body while maintaining its shape, offering a responsive seating surface without the need for additional cushioning.

Developed for outdoor use, sling and SunTexture fabrics are chosen for their durability and resistance to weather exposure, providing consistent performance with minimal maintenance.

CARE & MAINTENANCE

Cushions and Pillows:

Wipe the fabric with a firmly wrung cloth. In case of more obstinate stains, please follow washing instructions on the product.

For tough stains, mix 20% household bleach with 80% water. Apply the solution, scrub with a sponge or soft brush, soak for a couple of hours, then rinse thoroughly with clean water. If the upholstery is not removable, the textile must only be washed with a wrung cloth.

Umbrellas:

If the fabric becomes dirty, try to remove the dirt with a brush or damp cloth. Washing in a machine is not recommended.

Sling and SunTexture:

To remove stains, use a wrung cloth with soap and water and finish by wiping with a dry cloth.

Please always check and follow washing instructions on product.

CUSHIONS & PILLOWS

Pick and choose from our range of different colours, styles and expressions to create your own look and feel for your outdoor spaces.

Select availability for each product series.

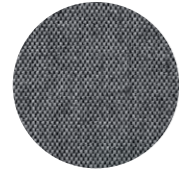

Panama
Ash



Panama
Charcoal

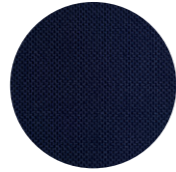

Panama
Marine



Natté
Cloud White

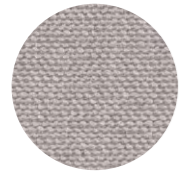

Gaià Sunset
Ice

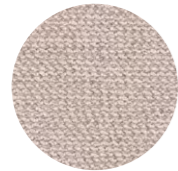

Gaià Sunset
Marble



Gaià Sunset
Papyrus

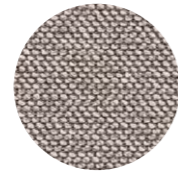

Gaià Sunset
Limestone

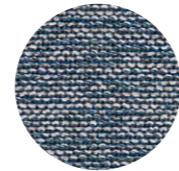

Gaià Sunset
Denim

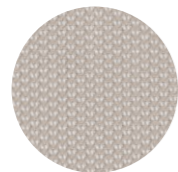

Lopi
Light Sand



Lopi
Honey Yellow

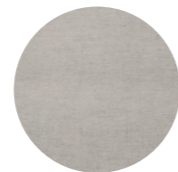

Heritage
Papyrus



Beatrice
Sand



Beatrice
Blue



Liso
Golden Yellow
Stripe



Lines
Lemon/Sand
Stripe



Lines
Light Apricot/
Dark Green
Stripe



Summertime
Beige



Summertime
Nero



Summertime
Navy



Summertime
Clementine



For details specific to UK/IE please visit fritzhausen.com

TEXTILE AVAILABILITY

	Natté	Panama				Heritage	Lopi		Lines		Liso	Beatrice		Summertime				Gaia Sunset				
	Cloud White	Ash	Charcoal	Marine	White	Papyrus	Light Sand	Honey Yellow	Lemon/Sand Stripe	Light Apricot/ Dark Green Stripe	Golden Yellow Stripe	Blue	Beige	Clementine	Navy	Nero	Sand	Denim	Ice	Limestone	Marble	Papyrus
Barriere - Deck Chair Cushion	•	•	•	•		•					•											
Barriere - Pillow 50×40						•		•	•	•	•	•	•	•	•	•	•	•	•	•	•	•
Barriere - Pillow 60×50						•		•	•	•	•	•	•	•	•	•	•	•	•	•	•	•
Barriere - Seat Cushion 43×43		•	•	•	•																	
Between Lines - Deck Chair Cushion		•	•			•			•													
Director's Chair						•									•							
Drachmann - Chair Cushion		•	•	•		•			•	•												
Drachmann - Bench 120 Cushion		•	•	•		•			•	•												
Drachmann - Bench 165 Cushion		•	•	•		•			•	•												
Drachmann - Bench 200 Cushion		•	•	•		•			•	•												
Lilium - Chair/Armchair Cushion		•	•	•	•	•																
Lilium - Lounge Chair Cushion		•	•	•	•	•																
Lilium - Bench Cushion		•	•	•	•	•																
Pelagus - Chair/Armchair Cushion		•	•					•														
Pelagus - Counter/Bar Stool Cushion		•	•					•														
Pelagus - Lounge Chair Cushion		•	•					•				•	•	•	•	•	•	•	•	•	•	•
Pelagus - Sunbed Cushion		•	•					•				•	•	•	•	•	•	•	•	•	•	•
Riviera - Lounge Cushion		•	•		•	•					•	•	•	•	•	•	•	•	•	•	•	•
Riviera - Sunbed Cushion	•	•	•			•					•	•	•	•	•	•	•	•	•	•	•	•
Selandia - Chair Cushion	•	•	•	•	•	•				•												
Selandia - Armchair Cushion	•	•	•	•	•	•				•												
Skagen - Chair Cushion	•	•	•	•		•					•											
Skagen - Bench Cushion	•	•	•	•		•					•											
Tradition - Series			•				•	•				•	•	•	•	•	•	•	•	•	•	•
Virkelyst - Series	•	•	•			•		•			•	•	•	•	•	•	•	•	•	•	•	•



Model: Atlantis

UMBRELLAS

Stay cool in the shade with beautiful, durable umbrellas crafted from long-lasting materials. Water and stain resistant textiles with maximum sun protective rating (UPF50+), and wooden poles that can withstand wind and weather.

Available in calm off-white colour or vibrant stripes variations.



Off-White



Golden Yellow
Stripe



Dark Blue
Stripe



Lemon/Sand
Stripe



Light Apricot/
Dark Green
Stripe

For details specific to UK/IE please visit fritzhansen.com



Virkelyst Chair and Sofa (2-seater) in Natté, Cloud White and Table High

Collection

Explore the outdoor collection.

BALLARE

The Ballare series of elegant outdoor furniture is crafted for lasting beauty. Blurring the lines between indoor and outdoor living, the minimalist designs feature soft curves and considered details that make them a delight to look at as well as to use. The natural teak surface will develop a rich patina over time, enhancing its warm, refined character in any garden or terrace.



ARMCHAIR
Design: Jakob Berg
Material: Teak (FSC™ 100%)

Stackable

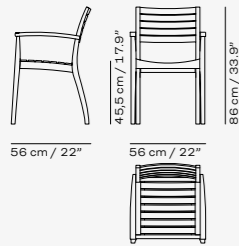

TABLE
Design: Jakob Berg
Material: Teak (FSC™ 100%)

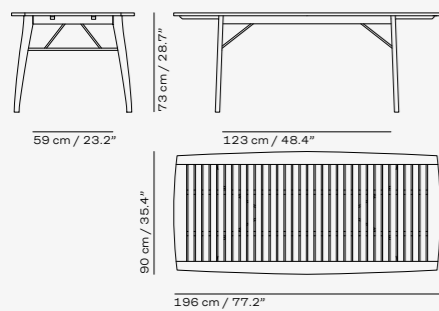
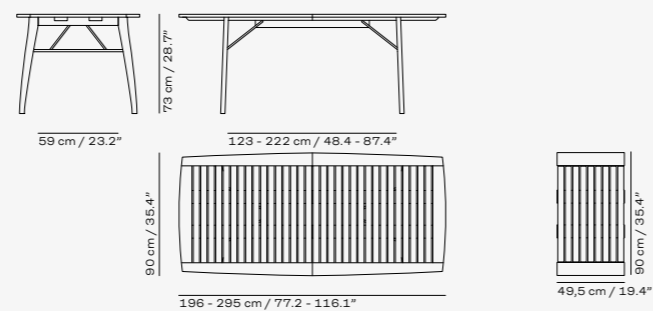

TABLE (EXTENDABLE)
Design: Jakob Berg
Material: Teak (FSC™ 100%)
Included: 2 x Extension plates



BANCO

Shaped for comfort and support, the Banco Bench was imagined to enhance the experience of the outdoors. Detailed with gentle curves that underscore the hand-crafted feel, it is made from FSC-certified teak which patinates to a beautiful silver-grey hue over time. The bench provides plenty of space and comfort to sit and take in the beauty of nature.



BENCH
Design: Hugo Passos
Material: Teak (FSC™ 100%)

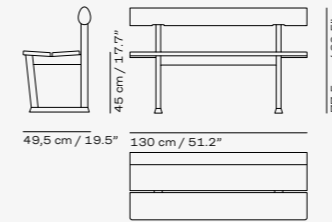

BENCH DOUBLE
Design: Hugo Passos
Material: Teak (FSC™ 100%)

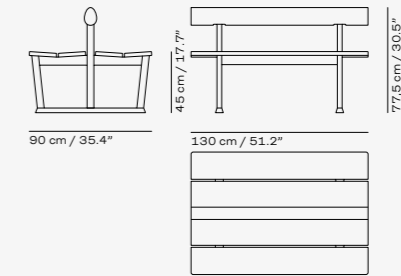

BARRIERE

The Barriere series is a range of beautiful cushions designed to make seating experiences better and softer. Designed for all weather conditions, the cushions are made to last year after year with resilient and weatherproof materials.



DECORATIVE PILLOW 50×40
Design: Skagerak Design
Material: Outdoor textile / Fibre Filling

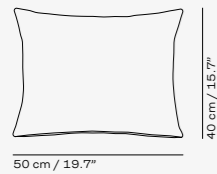

DECORATIVE PILLOW 60×50
Design: Skagerak Design
Material: Outdoor textile / Fibre Filling

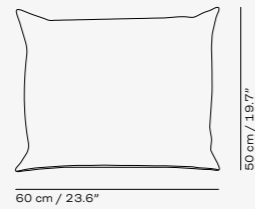

SEAT CUSHION 43×43
Design: Skagerak Design
Material: Outdoor textile / Kapok

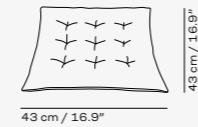

BETWEEN LINES

Made with comfort, quality and durability in mind, the Between Lines series has a restful expression which makes it perfect for enjoying life slowly in the great outdoors. Designed by Danish furniture designer Stine Weigelt. Natural in both function and design, the Deck Chair is a modern take on the American Adirondack. It features long, angular lines that are perfectly positioned for comfort.



DECK CHAIR
Design: Stine Weigelt
Material: Teak (FSC™ 100%)

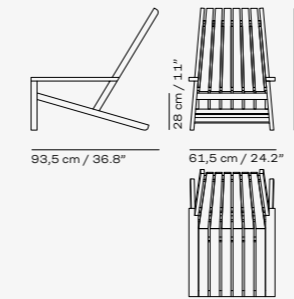

DECK CHAIR CUSHION
Design: Stine Weigelt
Material: Outdoor textile / Fast-drying outdoor foam

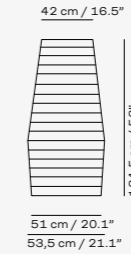

DECK STOOL
Design: Stine Weigelt
Material: Teak (FSC™ 100%)

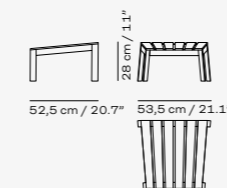

CADENCE

With functionality and simplicity at heart, the Cadence series is characterised by its light appearance and architectural repetition in neat, wooden slats. Crafted in highest quality solid teak with stainless steel fittings, the furniture weathers beautifully over time, requiring minimal maintenance and patinating to a silver-grey hue.



CHAIR
Design: Aurélien Barbry
Material: Teak (FSC™ 100%)

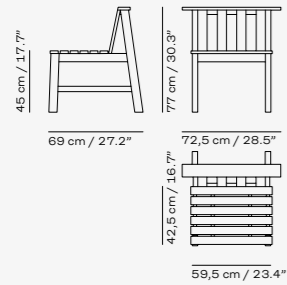

BENCH
Design: Aurélien Barbry
Material: Teak (FSC™ 100%)

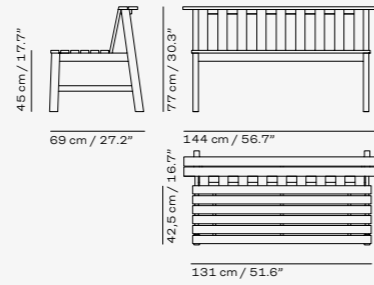
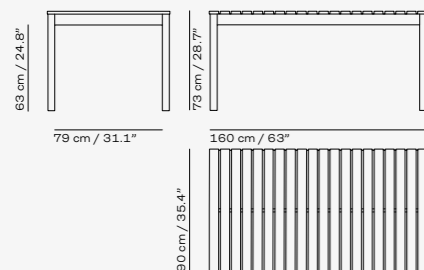

TABLE
Design: Aurélien Barbry
Material: Teak (FSC™ 100%)



COLUMBUS

The Columbus series takes its design cues from traditional American-style garden chairs. Pared back to a simpler, Scandinavian expression with slatted seats and visible fittings, the series is equally suited to al fresco dining or relaxing on a sunny terrace.



SUNBED
Design: Skagerak Design
Material: Teak (FSC™ 100%) / SunTexture

Adjustable

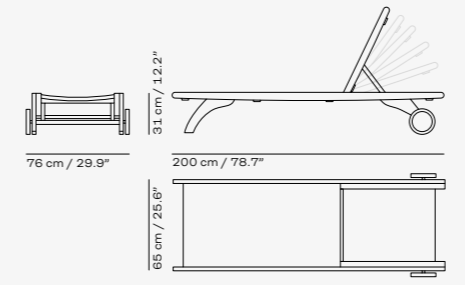

CUTTER

The iconic Cutter series is a minimalistic and functional design. Inspired by the German Bauhaus movement, the series contains many options and combinations giving a wonderful array of choice to suit many places.

Note: Only the teak bench and stool are suitable for outdoor use. Other variants are only for indoor use.



STOOL

Design: Niels Hvass
Material: Teak (FSC™ 100%)

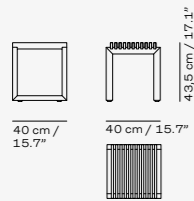

BENCH

Design: Niels Hvass
Material: Teak (FSC™ 100%)

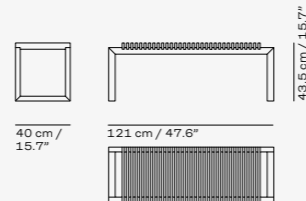

DIRECTOR'S CHAIR

Director's Chair steps outside in an outdoor-ready design that pairs upholstered comfort with foldable practicality. Available in weather-resistant textile, it brings the familiar silhouette to terraces, gardens and balconies with ease. Crafted in solid teak with brass fittings, it offers the same elegance and functionality as the indoor original.



ARMCHAIR

Design: Skagerak Design
Material: Outdoor textile / Fast-drying outdoor foam

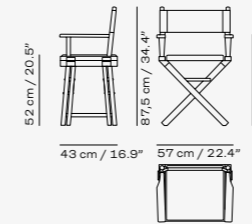

DRACHMANN

The signature Drachmann series draws inspiration from the beautiful garden of Danish romantic poet and painter, Holger Drachmann. A careful balance of Nordic nostalgia and modern simplicity underlies its enduring popularity.



CHAIR
Design: Bernt Santesson
Material: Teak (FSC™ 100%)

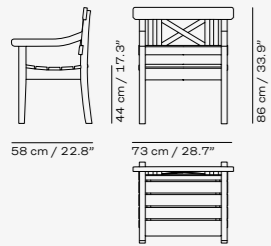

CHAIR CUSHION
Design: Skagerak Design
Material: Outdoor textile / Fast-drying outdoor foam

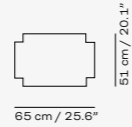

BENCH 165
Design: Bernt Santesson
Material: Teak (FSC™ 100%)

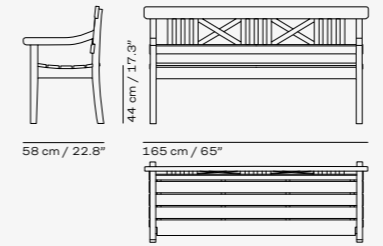

BENCH CUSHION 165
Design: Skagerak Design
Material: Outdoor textile / Fast-drying outdoor foam

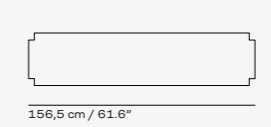

BENCH 120
Design: Bernt Santesson
Material: Teak (FSC™ 100%)

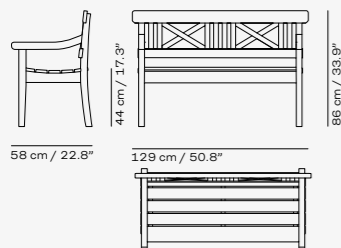

BENCH CUSHION 120
Design: Skagerak Design
Material: Outdoor textile / Fast-drying outdoor foam

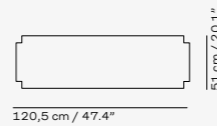

BENCH 200
Design: Bernt Santesson
Material: Teak (FSC™ 100%)

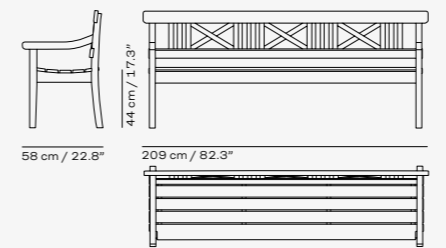

BENCH CUSHION 200
Design: Skagerak Design
Material: Outdoor textile / Fast-drying outdoor foam

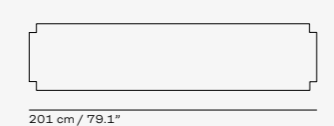

DRACHMANN

The signature Drachmann series draws inspiration from the beautiful garden of Danish romantic poet and painter, Holger Drachmann. A careful balance of Nordic nostalgia and modern simplicity underlies its enduring popularity.



TABLE Ø126
Design: Mogens Holmriis
Material: Teak (FSC™ 100%)

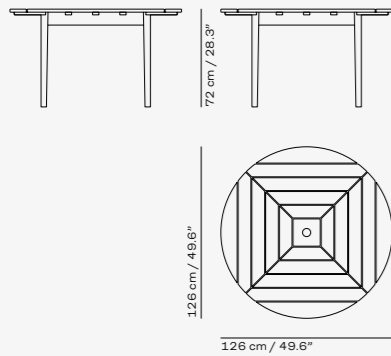

TABLE 86
Design: Mogens Holmriis
Material: Teak (FSC™ 100%)

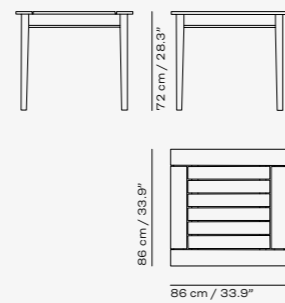

TABLE 156
Design: Mogens Holmriis
Material: Teak (FSC™ 100%)

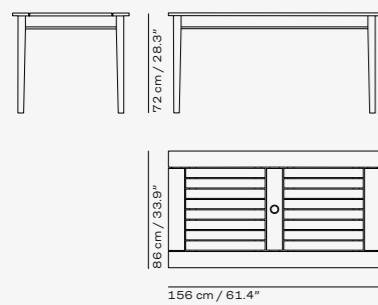
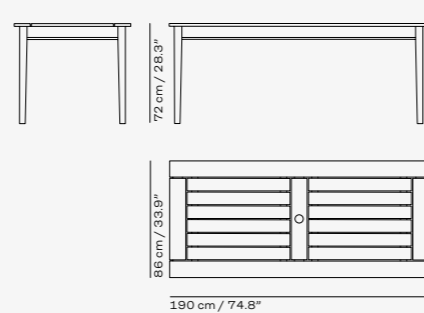

TABLE 190
Design: Mogens Holmriis
Material: Teak (FSC™ 100%)



ENGLAND

Looking to the wooden benches found in parks and gardens across Britain, the England Series is a modern interpretation of a classic design, complete with comfortable contours and a sturdy and durable construction. A comfortable garden seat for up to four people.



BENCH 152
Design: Skagerak Design
Material: Teak (FSC™ 100%)

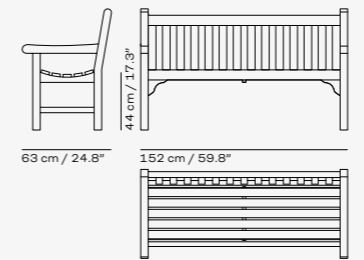

BENCH 180
Design: Skagerak Design
Material: Teak (FSC™ 100%)

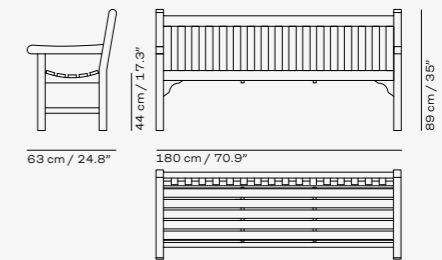

LILIUM

The Lilium collection is a contemporary take on outdoor furniture that also sits wonderfully indoors. Designed by renowned BIG – Bjarke Ingels Group – Lilium is long-lasting furniture perfect for outdoor events and gatherings.



ARMCHAIR
Design: BIG – Bjarke Ingels Group
Material: Teak (FSC™ 100%) / Stainless steel

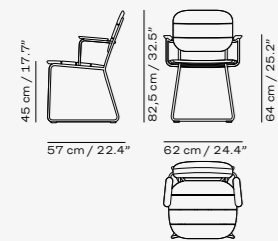

CHAIR
Design: BIG – Bjarke Ingels Group
Material: Teak (FSC™ 100%) / Stainless steel

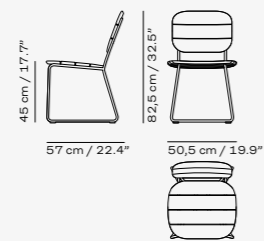

ARMCHAIR/CHAIR CUSHION
Design: BIG – Bjarke Ingels Group
Material: Outdoor textile / Neoprene



BENCH
Design: BIG – Bjarke Ingels Group
Material: Teak (FSC™ 100%) / Stainless steel

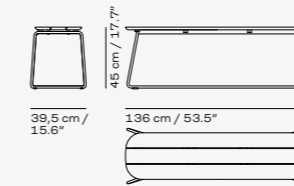

BENCH CUSHION
Design: BIG – Bjarke Ingels Group
Material: Outdoor textile / Neoprene

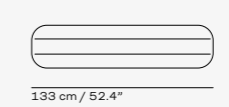

LOUNGE CHAIR
Design: BIG – Bjarke Ingels Group
Material: Teak (FSC™ 100%) / Stainless steel

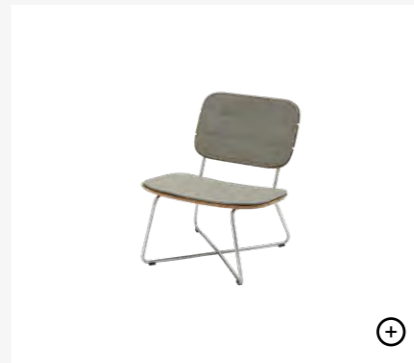
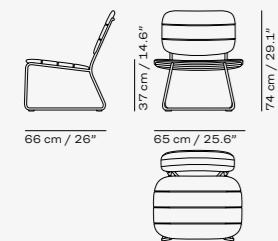

LOUNGE CHAIR CUSHION
Design: BIG – Bjarke Ingels Group
Material: Outdoor textile / Neoprene

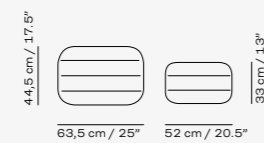

LOUNGE TABLE
Design: BIG – Bjarke Ingels Group
Material: Teak (FSC™ 100%) / Stainless steel

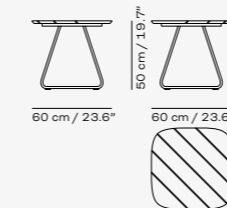
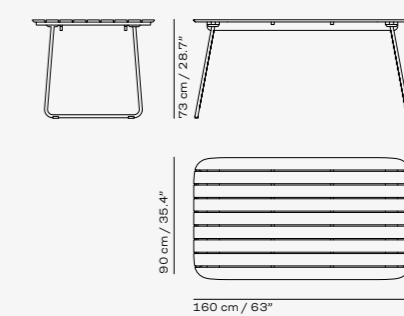

TABLE
Design: BIG – Bjarke Ingels Group
Material: Teak (FSC™ 100%) / Stainless steel



PELAGUS

Pelagus has a graceful contemporary expression that sits lightly in nature and holds its own in urban environments. The collection is high on comfort and versatility. It is furniture that suits a lifestyle as diverse as that lived in urban cosmopolitans or far from the city and grounded in nature.



ARMCHAIR
Design: Note Design Studio
Material: Teak (FSC™ 100%) / Aluminium

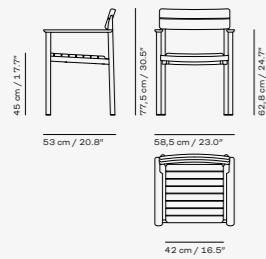

CHAIR
Design: Note Design Studio
Material: Teak (FSC™ 100%) / Aluminium

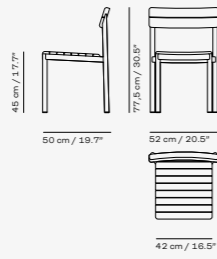

ARMCHAIR/CHAIR CUSHION
Design: Note Design Studio
Material: Outdoor textile / Fast-drying outdoor foam



SUNBED
Design: Note Design Studio
Material: Teak (FSC™ 100%) / Sling textile

Adjustable
Add-on: Armrest

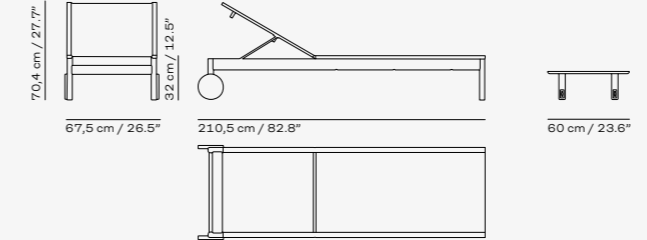

SUNBED CUSHION
Design: Note Design Studio
Material: Outdoor textile / Fast-drying outdoor foam

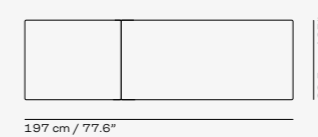

COUNTER STOOL
Design: Note Design Studio
Material: Teak (FSC™ 100%) / Aluminium

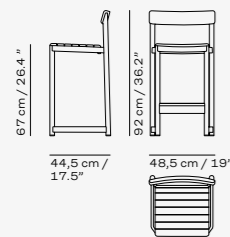

BAR STOOL
Design: Note Design Studio
Material: Teak (FSC™ 100%) / Aluminium

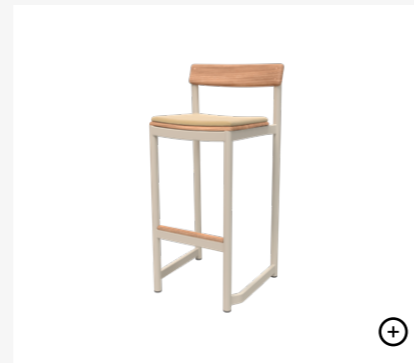
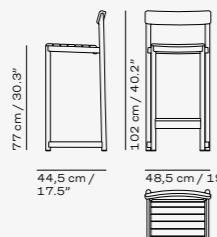

COUNTER/BAR STOOL CUSHION
Design: Note Design Studio
Material: Outdoor textile / Fast-drying outdoor foam

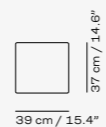

LOUNGE CHAIR
Design: Note Design Studio
Material: Teak (FSC™ 100%) / Sling textile

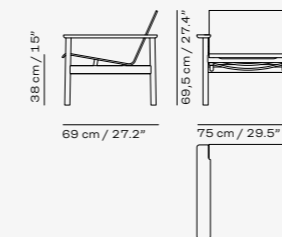

LOUNGE CHAIR CUSHION
Design: Note Design Studio
Material: Outdoor textile / Fast-drying outdoor foam

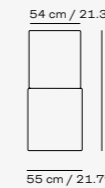

PELAGUS

Pelagus has a graceful contemporary expression that sits lightly in nature and holds its own in urban environments. The collection is high on comfort and versatility. It is furniture that suits a lifestyle as diverse as that lived in urban cosmopolitans or far from the city and grounded in nature.



CAFÉ TABLE
Design: Note Design Studio
Material: Teak (FSC™ 100%) / Aluminium

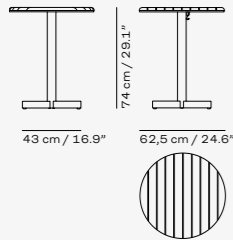

HIGH TABLE 95
Design: Note Design Studio
Material: Teak (FSC™ 100%) / Aluminium

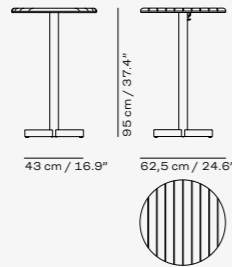

HIGH TABLE 105
Design: Note Design Studio
Material: Teak (FSC™ 100%) / Aluminium

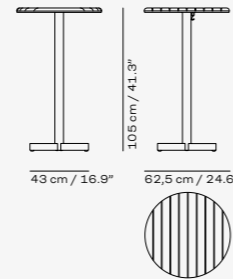

TABLE 75X75
Design: Note Design Studio
Material: Teak (FSC™ 100%) / Aluminium

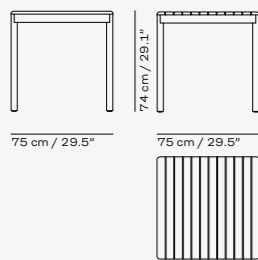
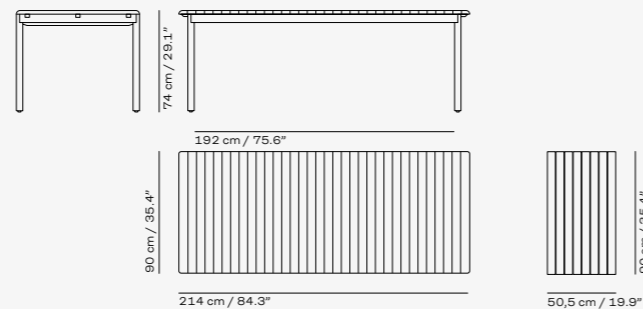

TABLE
Design: Note Design Studio
Material: Teak (FSC™ 100%) / Aluminium
Add-on:
Extension plate
(2 pcs.)



RIVIERA

Designed in 1991, the versatile Riviera Collection has become an outdoor classic, renowned for its flexibility and straightforward appearance. The ingenious construction is adjustable by design, allowing the pieces in the Riviera collection to transform in both expression and functionality and can easily be supplemented by a comfortable cushion.



SUNBED
Design: Povl B. Eskildsen
Material: Teak (FSC™ 100%)

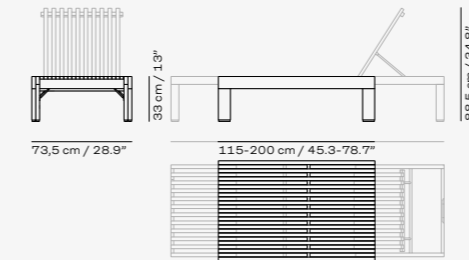

Adjustable
SUNBED CUSHION
Design: Povl B. Eskildsen
Material: Outdoor textile / Fast-drying outdoor foam

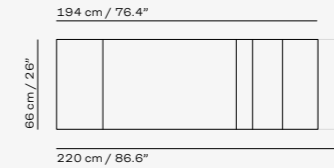

LOUNGE
Design: Povl B. Eskildsen
Material: Teak (FSC™ 100%)

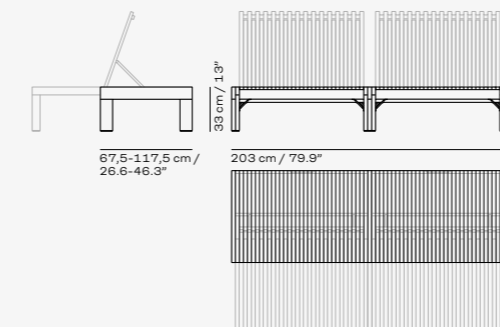

Adjustable
LOUNGE CUSHION
Design: Povl B. Eskildsen
Material: Outdoor textile / Fast-drying outdoor foam

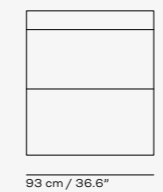

SELANDIA

Selandia series is known for its signature slight curves and elegant Nordic look with subtle French references that hint at long summer nights in the open air.



ARMCHAIR *Foldable*
Design: Anders & Lars Hegelund
Material: Teak (FSC™ 100%)

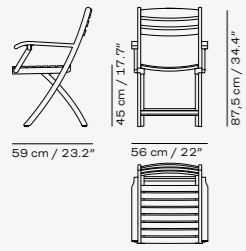

ARMCHAIR CUSHION
Design: Skagerak Design
Material: Outdoor textile / Fast-drying outdoor foam



2-SEATER *Foldable*
Design: Anders & Lars Hegelund
Material: Teak (FSC™ 100%)

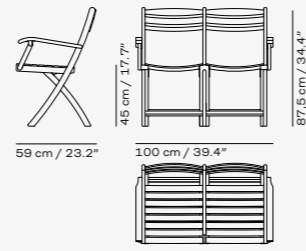

TABLE Ø94
Design: Anders & Lars Hegelund
Material: Teak (FSC™ 100%)

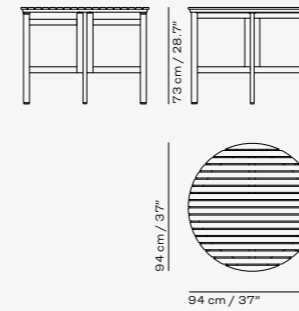
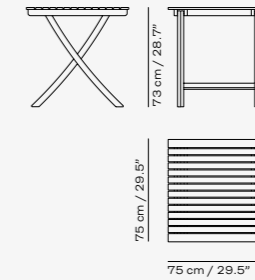
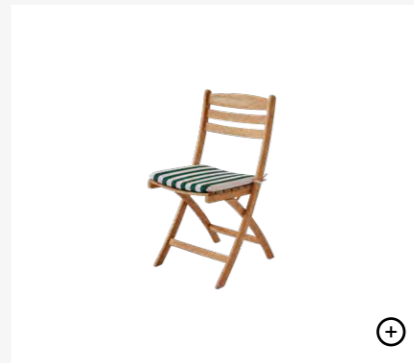
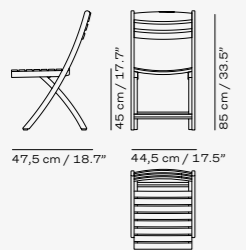

TABLE 75 *Foldable*
Design: Skagerak Design
Material: Teak (FSC™ 100%)



CHAIR *Foldable*
Design: Anders & Lars Hegelund
Material: Teak (FSC™ 100%)



CHAIR CUSHION
Design: Skagerak Design
Material: Outdoor textile / Fast-drying outdoor foam

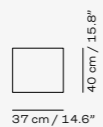

TABLE 147
Design: Skagerak Design
Material: Teak (FSC™ 100%)

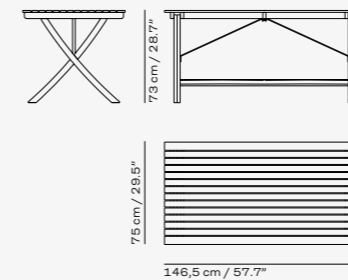
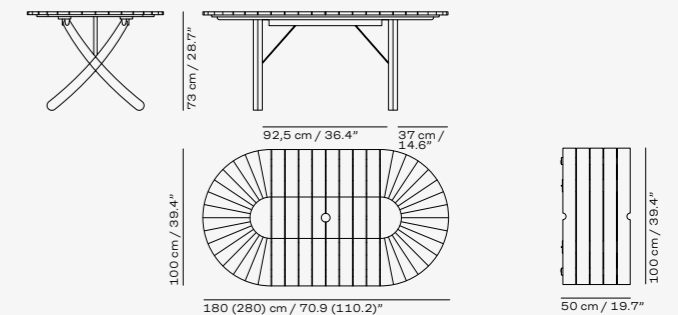

TABLE
Design: Mogens Holmriis
Material: Teak (FSC™ 100%)

Add-on:
Extension plate
(2 pcs.)



SKAGEN

Named after the northernmost tip of Denmark, the Skagen series of outdoor furniture draws inspiration from the region's natural beauty. Characterised by meticulous craftsmanship and elegant silhouettes, the series is shaped in teak, a durable hard wood that patinates to a silver-grey hue over time.



CHAIR
Design: Mogens Holmriis
Material: Teak (FSC™ 100%)

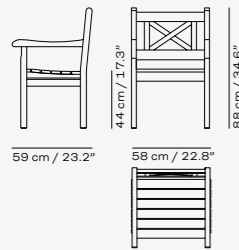

CHAIR CUSHION
Design: Skagerak Design
Material: Outdoor textile / Fast-drying outdoor foam

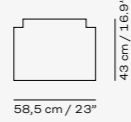

BENCH
Design: Mogens Holmriis
Material: Teak (FSC™ 100%)

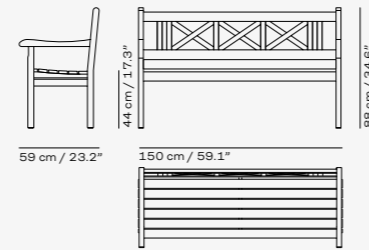

BENCH CUSHION
Design: Skagerak Design
Material: Outdoor textile / Fast-drying outdoor foam

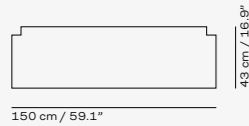
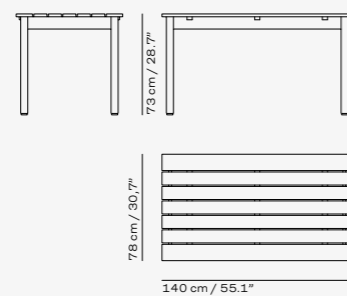

TABLE
Design: Mogens Holmriis
Material: Teak (FSC™ 100%)



STEAMER

The flowing lines of the Steamer Deck Chair are inspired by the curved lines of a cruise ship. The chair has an integrated footrest that folds up easily when not in use. Steamer Deck Chair is crafted from high-quality teak in a clean and light expression with functionality and comfort at the forefront of this Nordic archetype.



DECK CHAIR
Design: Skagerak Design
Material: Teak (FSC™ 100%)

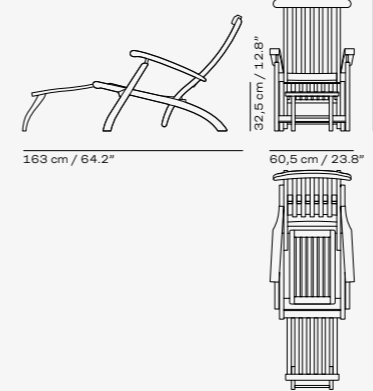

Adjustable
DECK CHAIR CUSHION
Design: Skagerak Design
Material: Outdoor textile / Fast-drying outdoor foam

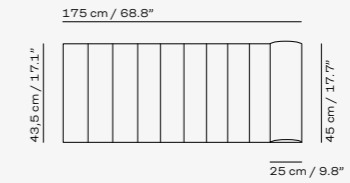

Model: Barriere

TRADITION

The Tradition lounge series brings a refined sophistication to outdoor spaces and the versatility to adapt to any individual needs. Tradition elevates the outdoor lounging experience to new heights in comfort and beauty. Tradition is a modular series open to multiple configurations.



LOUNGE CHAIR
 Design: Povl B. Eskildsen
 Material: Teak (FSC™ 100%) / Outdoor textile /
 Fast-drying outdoor foam / Fibre Filling

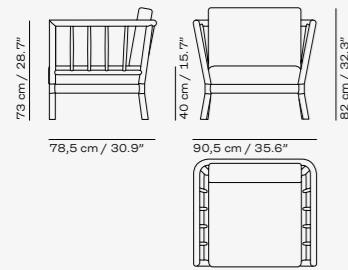

CORNER MODULE
 Design: Povl B. Eskildsen
 Material: Teak (FSC™ 100%) / Outdoor textile /
 Fast-drying outdoor foam / Fibre Filling

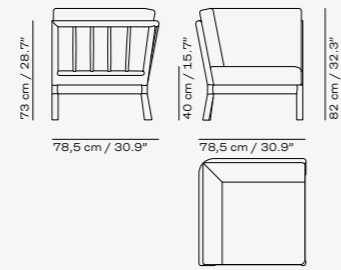

POUF
 Design: Povl B. Eskildsen
 Material: Teak (FSC™ 100%) / Outdoor textile /
 Fast-drying outdoor foam

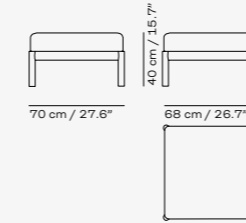

END MODULE
 Design: Povl B. Eskildsen
 Material: Teak (FSC™ 100%) / Outdoor textile /
 Fast-drying outdoor foam / Fibre Filling

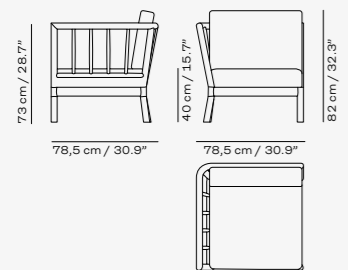

SPACER MODULE
 Design: Povl B. Eskildsen
 Material: Teak (FSC™ 100%) / Outdoor textile /
 Fast-drying outdoor foam / Fibre Filling

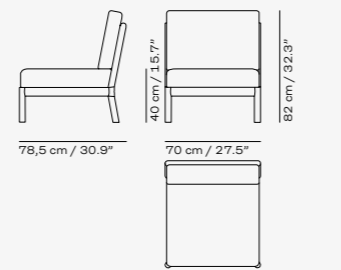

LOUNGE TABLE, H27
 Design: Povl B. Eskildsen
 Material: Teak (FSC™ 100%)

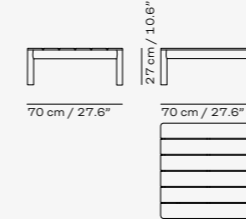

LOUNGE TABLE, H40
 Design: Povl B. Eskildsen
 Material: Teak (FSC™ 100%)

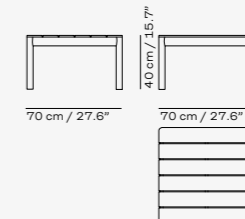

VENDIA

Made with smaller spaces in mind, the Vendia Series delivers all the elegance of traditional garden furniture in a scaled-down design that is ideal for balconies, patios and terraces where space is at a premium. With its small footprint, the chair and table are the ideal choice when space is at a premium.



CHAIR
Design: Mogens Holmriis
Material: Teak (FSC™ 100%)

Foldable

TABLE
Design: Mogens Holmriis
Material: Teak (FSC™ 100%)

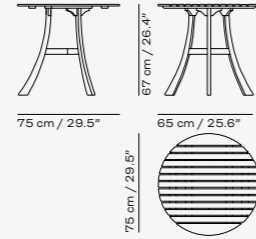
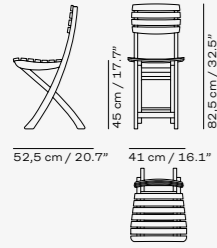

VIND

The Vind Series is an outdoor furniture collection by Kasper Salto, defined by a sculptural lightness inspired by sails and the maritime landscape beside Louisiana Museum of Modern Art. With its contemporary expression and practical functionality, the series brings comfort and elegance to both residential spaces and larger hospitality environments.



ARMCHAIR
Design: Kasper Salto
Material: Powder coated aluminium, Solution-dyed polyester

Stackable

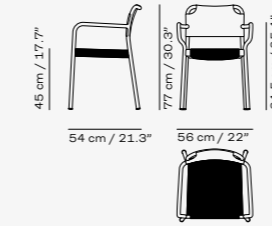

CHAIR
Design: Kasper Salto
Material: Powder coated aluminium, Solution-dyed polyester

Stackable

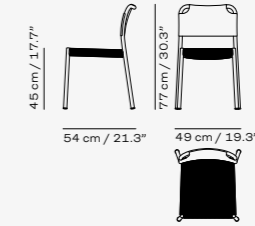
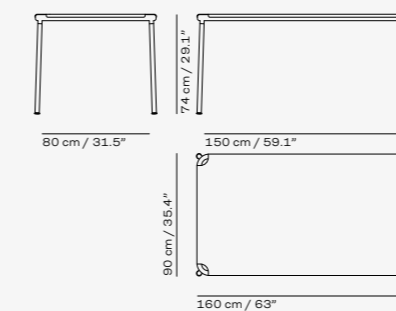

TABLE
Design: Kasper Salto
Material: Powder coated aluminium



VIRKELYST

Virkelyst is a modern outdoor series characterised by clean lines, discreet details and high comfort. The clean lines of Virkelyst's teak frame strike a satisfying contrast with the thick, soft and comfortable cushions. Perfect for enjoying comfortable hours in sunny gardens or terraces.



POUF
Design: SAYS WHO
Material: Teak (FSC™ 100%) / Outdoor textile / Fast-drying outdoor foam

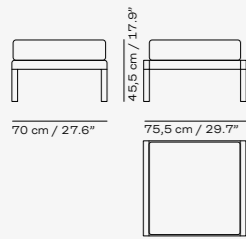

CHAIR
Design: SAYS WHO
Material: Teak (FSC™ 100%) / Outdoor textile / Fast-drying outdoor foam

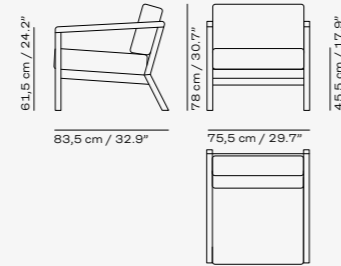

TABLE SMALL
Design: SAYS WHO
Material: Teak (FSC™ 100%)

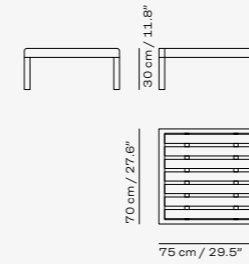
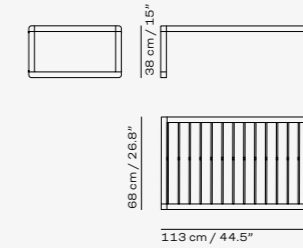
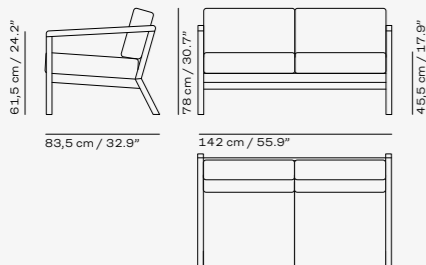

TABLE
Design: SAYS WHO
Material: Teak (FSC™ 100%)



2-SEATER
Design: SAYS WHO
Material: Teak (FSC™ 100%) / Outdoor textile / Fast-drying outdoor foam



3-SEATER
Design: SAYS WHO
Material: Teak (FSC™ 100%) / Outdoor textile / Fast-drying outdoor foam

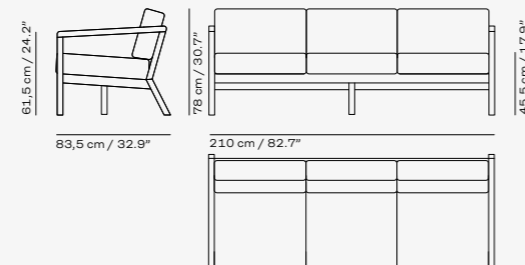
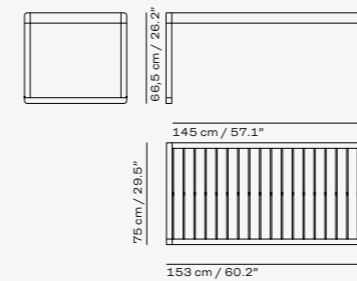

TABLE HIGH
Design: SAYS WHO
Material: Teak (FSC™ 100%)



UMBRELLAS

The umbrellas are beautiful to behold, highly functional, and skilfully crafted from long-lasting materials. The umbrellas are made from water and stain resistant textile with maximum sun protective rating (UPF50+), while the parasol poles are made from durable wood which is able to withstand wind and weather.



ATLANTIS
Design: Skagerak Design
Material: Textile / Kapur (FSC™ 100%)

Ø×H: 330×275 cm
Pole Ø: 4,8 cm
Recommended foot: 50 kg



ATLANTIS
Design: Skagerak Design
Material: Textile / Kapur (FSC™ 100%)

W×H: 330×277 cm
Pole Ø: 4,8 cm
Recommended foot: 50 kg



MESSINA
Design: Skagerak Design
Material: Textile / Kapur (FSC™ 100%)

Ø×H: 210×220 cm
Pole Ø: 3,8 cm
Recommended foot: 30 kg

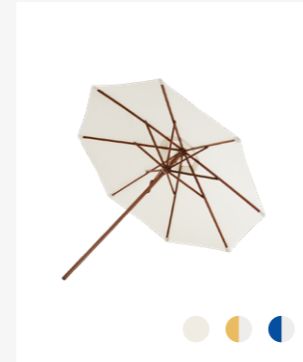

MESSINA
Design: Skagerak Design
Material: Textile / Kapur (FSC™ 100%)

Ø×H: 270×250 cm
Pole Ø: 3,8 cm
Recommended foot: 30 kg

UMBRELLAS

Capri umbrella foot is a functional and long-lasting piece for umbrellas made of steel and concrete. The natural and robust materials will stand firm year after year, while the design allows rain to drain off easily. The smart protective cover for the umbrellas is good for storing safely, especially during the winter.



CAPRI 30 KG
Design: Skagerak Design
Material: Concrete / Stainless Steel

Ø×H: 50×43 cm
Pole max Ø: 4 cm

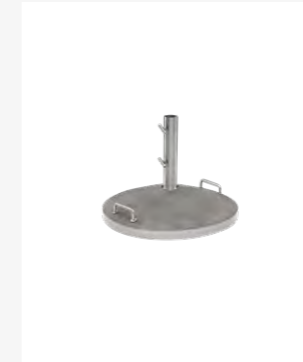

CAPRI 50 KG
Design: Skagerak Design
Material: Concrete / Stainless Steel

Ø×H: 60×45 cm
Pole max Ø: 5 cm



COVER
Design: Skagerak Design
Material: Plastic

Ø×H: 48×250 cm
Compatible for umbrella: 270, 300, 330



COVER
Design: Skagerak Design
Material: Plastic

Ø×H: 47×184 cm
Compatible for umbrella: Ø210, Ø270, Ø300, Ø330



MESSINA
Design: Skagerak Design
Material: Textile / Kapur (FSC™ 100%)

Ø×H: 300×240 cm
Pole Ø: 4,8 cm
Recommended foot: 50 kg



MESSINA
Design: Skagerak Design
Material: Textile / Kapur (FSC™ 100%)

W×H: 270×250 cm
Pole Ø: 3,8 cm
Recommended foot: 50 kg



MESSINA
Design: Skagerak Design
Material: Textile / Kapur (FSC™ 100%)

W×H: 300×270 cm
Pole Ø: 4,8 cm
Recommended foot: 50 kg

OTHER

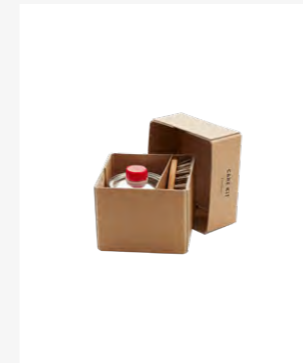

CARE KIT
Wood Cleaner
by Auro

0,5 liter



CURA (OIL)
Treatment for
wood products

0,5 liter

NICE TO KNOW

HEADQUARTERS

FRITZ HANSEN
Allerødvej 8
3450 Allerød
Denmark
Tel: +45 48 17 23 00

GET IN TOUCH

SALES - ASIA & OCEANIA
customerserviceasia@fritzhansen.com
Tel: +81 3 3400 3316

SALES - EUROPE
salesupport@fritzhansen.com
Tel: +45 70 80 70 90

SALES - NORTH AMERICA
americas-contract@fritzhansen.com
Tel: 212 219 3226

PRESS - GLOBAL
press@fritzhansen.com

NEWSLETTER

Sign up at:
fritzhansen.com/sign-up

DOWNLOADS

Find 2D & 3D files, imagery,
product facts and much more
at: downloads.fritzhansen.com

FOLLOW US

INSTAGRAM
[@fritzhansen](https://www.instagram.com/fritzhansen)

PINTEREST
[@fritzhansen](https://www.pinterest.com/fritzhansen)

FACEBOOK
Fritz Hansen

LINKEDIN
Fritz Hansen

[FRITZHANSEN.COM](https://www.fritzhansen.com)

LOOKING FOR MORE INSPIRATION?



Discover home stories featuring
Fritz Hansen Outdoor products in private residences.

F.H.1872