

SKETCH
BOOK
2025

1920 R[®]
MADE IN ITALY



Ogni arredo nasce da un'idea, e ogni idea inizia con uno schizzo. Lo Sketch Book 2025 Riva1920 celebra il processo creativo che nasce come visione nelle menti di architetti e designer e che si traduce successivamente in disegno, fino alla progettazione e alla realizzazione come arredo vero e proprio.

E visto che pensiamo che il design sia condivisione, abbiamo lasciato alcune pagine bianche per te. Prendi nota, disegna, immagina... il tuo schizzo potrebbe diventare il prossimo progetto Riva1920!

Every piece of furniture starts with an idea, and every idea begins with a sketch. The Riva1920 Sketch Book 2025 celebrates the creative process that begins as a vision in the minds of architects and designers, which then translates into a drawing, followed by planning, and ultimately results in the creation of actual furniture.

And since we believe design is about sharing, we've left some blank pages for you. Take notes, draw, imagine... your sketch could become the next Riva1920 project!

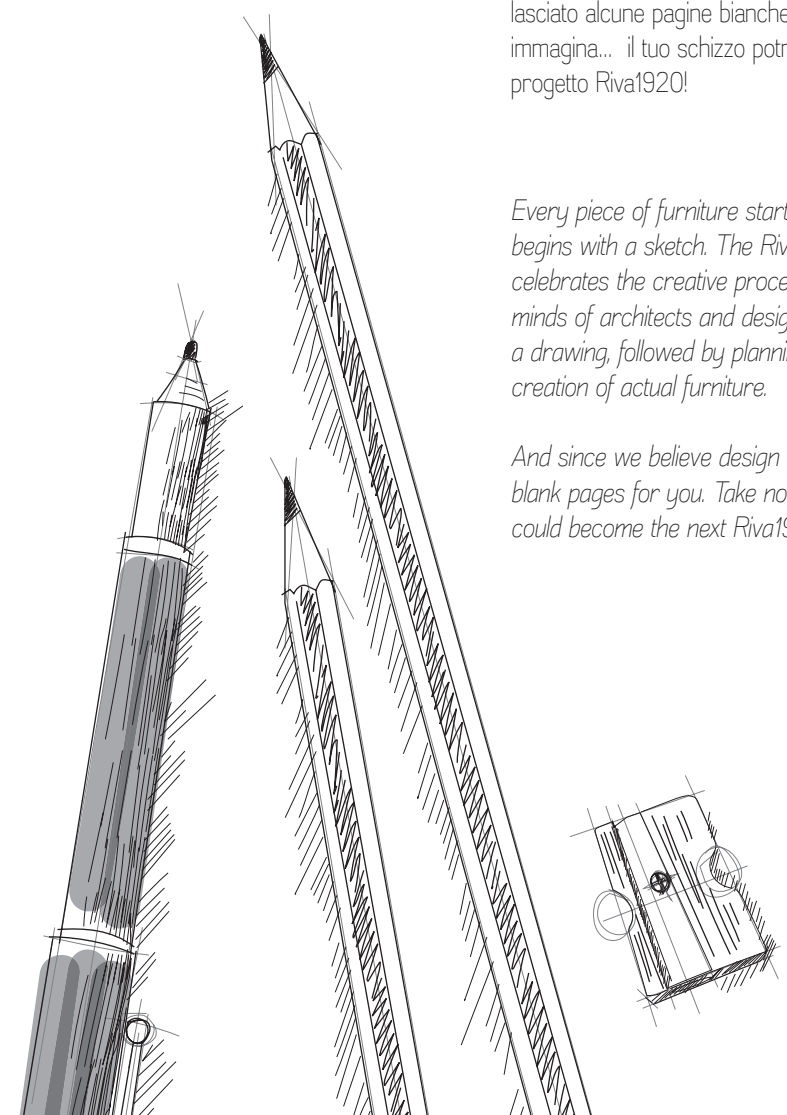

REWOOD COLLECTION

- TABLES
- CHAIR
- DISPLAY & STORAGE UNITS

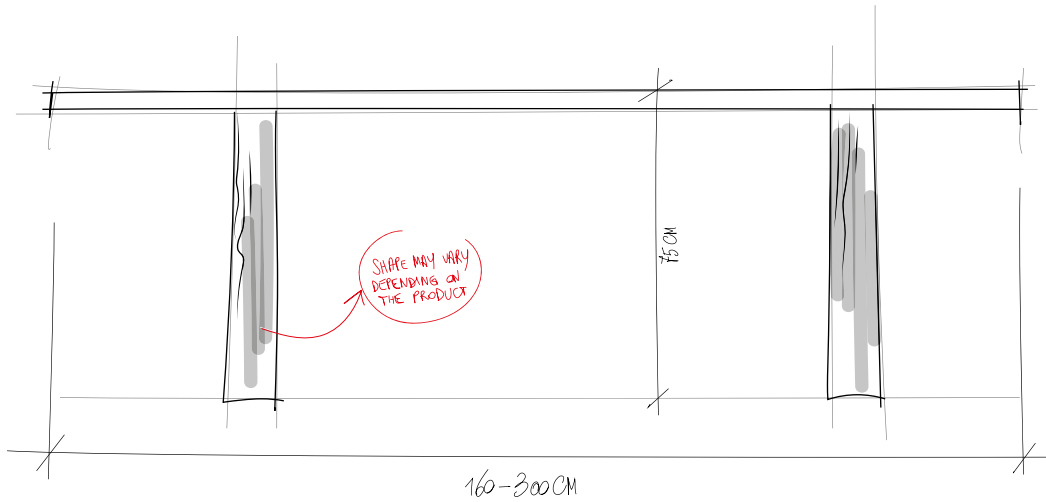

REWOOD EMPTY

design Authentic Design

Tavolo con top in legno massello a liste incollate con bordi squadrati, abbinato a gambe in legno massello a forma di U, per un effetto visivo più dinamico.

Table with a solid wood top made of glued slats with squared edges, paired with U-shaped solid wood legs for a more dynamic visual effect.

REWOOD Full

design Authentic Design

Tavolo con top realizzato in legno massello, caratterizzato da liste incollate con bordi squadrati. La base si compone di gambe in legno massello.

Table with a solid wood top, featuring glued slats with squared edges. The base consists of solid wood legs.



REWOOD Full Double

design Authentic Design

Tavolo con top realizzato in legno massello, caratterizzato da liste incollate con bordi squadrati. La base si compone di gambe in legno massello da 8 cm di spessore, da qui il nome "DOUBLE" perché lo spessore è il doppio del top da 4 cm.

Table with a solid wood top, featuring glued slats with squared edges. The base consists of solid wood legs 8 cm thick, which is why it's called "DOUBLE" — because the thickness is double that of the 4 cm top.

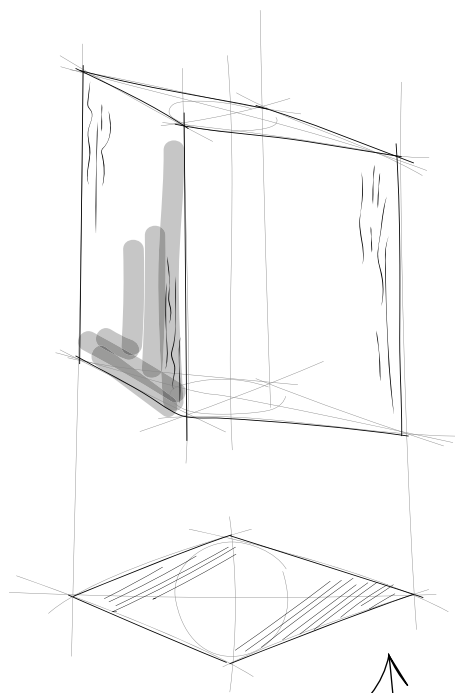

NATURAL SIDES

CENTRAL GAP

REWOOD PYRAMID PLANK

design Authentic Design

Tavolo con top realizzato in legno massello, composto da due tavole uniche allineate con fuga centrale e bordi naturali. La base si compone di gambe in legno massello dalla forma a trapezio che ricorda una piramide.

Table with a solid wood top, consisting of two unique planks aligned with a central gap and natural edges. The base features solid wood trapezoid-shaped legs reminiscent of a pyramid.

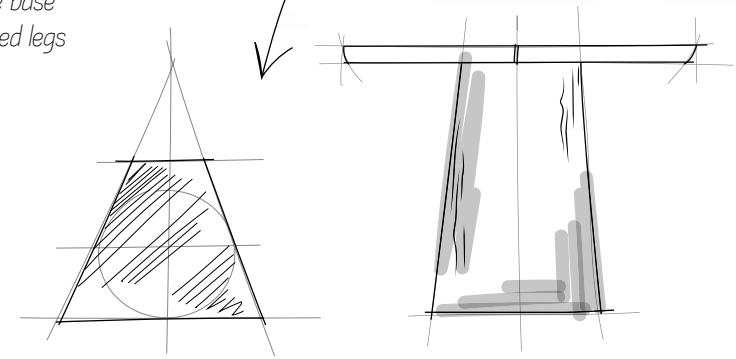

TAPERED EDGES

REWOOD LINE

design Authentic Design

Tavolo con top realizzato in legno massello, caratterizzato da liste incollate con bordi rastremati, in abbinata a gambe in legno massello a forma di rombo.

Table with a solid wood top, featuring glued slats with tapered edges, paired with solid wood rhombus-shaped legs.



TWO UNIQUE PLANKS

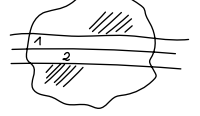

REWOOD SIDE BOARD

design Authentic Design

Credenza bassa in legno massello e multistrato, racchiusa da cornice in legno, caratterizzata da ante a battente con apertura push-pull. Il mobile è rialzato da terra mediante due gambe in legno massello pigmentato nero a forma di rombo.

Sideboard in solid wood and veneered plywood, enclosed by a wooden frame, featuring hinged doors with push-pull opening mechanism. The piece is raised off the floor by two black-pigmented solid wood legs in a rhombus shape.

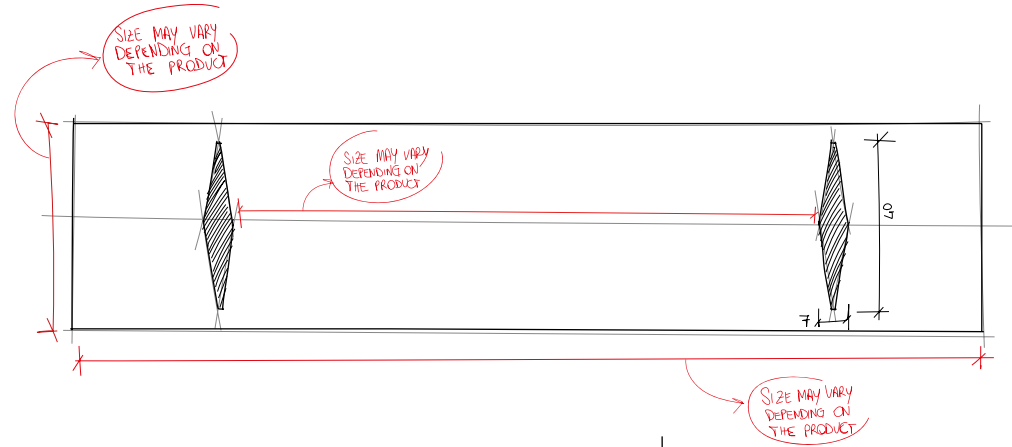

REWOOD HIGH BOARD

design Authentic Design

Credenza alta in legno massello e multistrato, racchiusa da cornice in legno, caratterizzata da due ante a battente con apertura push-pull. Il mobile è rialzato da terra mediante due gambe in legno massello pigmentato nero a forma di rombo.

Highboard in solid wood and veneered plywood, enclosed by a wooden frame, featuring hinged doors with push-pull opening mechanism. The piece is raised off the floor by two black-pigmented solid wood legs in a rhombus shape.



DELTA

design Authentic Design

Tavolini il cui top nasce dall'accostamento di parti in legno massello con inserti in resina, che insieme creano geometrie dinamiche e raffinate, abbinato ad una base in ferro, disponibile in due altezze. Gli spessori assottigliati tramite lavorazione a saponetta del top donano leggerezza e sinuosità.

Small tables featuring tops crafted by combining solid wood sections with resin inlays, creating dynamic and refined geometric patterns. The tops are paired with a metal base, available in two height options. The thin thicknesses, achieved thanks to the bevelled and rounded edges, give it a light and sinuous design.

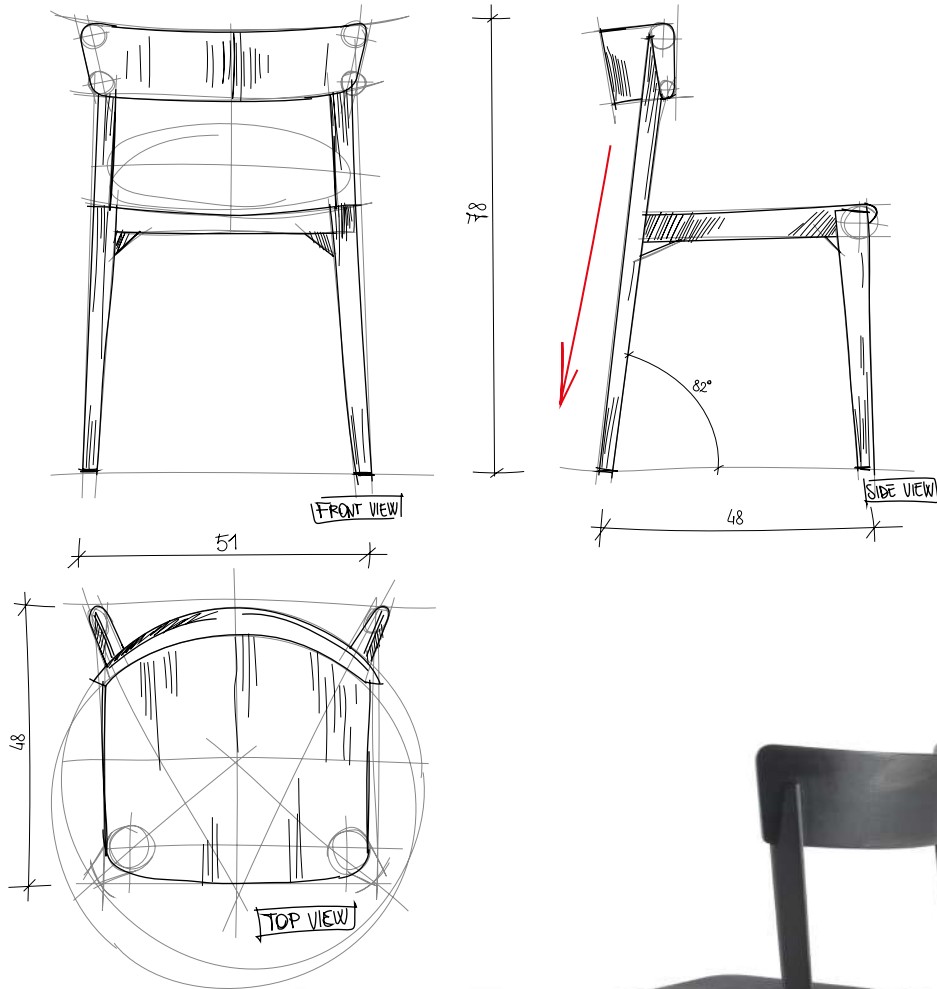
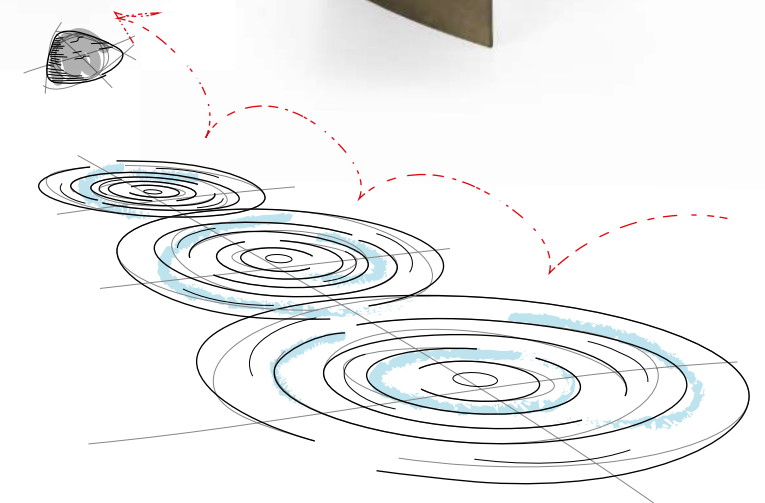

REWOOD

MIA

design Authentic Design

Sedia realizzata totalmente in legno massello di frassino che si ispira alla classica sedia del bistrot tradizionale.

Chair made entirely of solid ash wood, inspired by the classic traditional bistro chair.



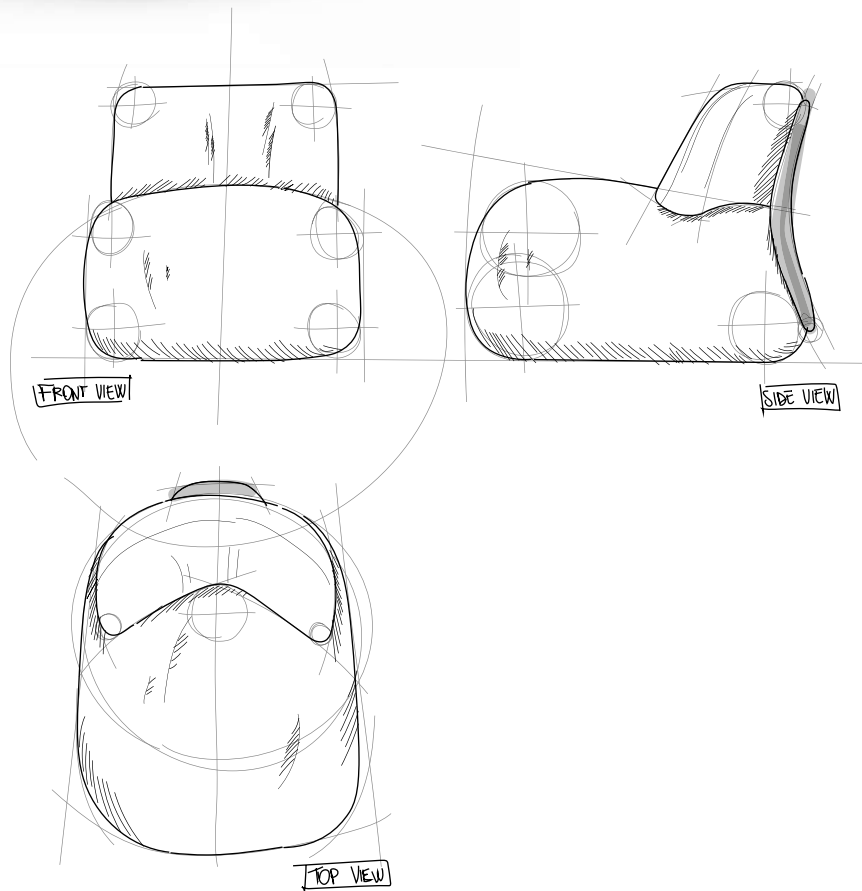

PASSO

design Ronald Sasson

Poltrona imbottita con rivestimento in tessuto o pelle, caratterizzata da un distintivo schienale in legno massello che funge sia da elemento strutturale che decorativo. La solida e sinuosa struttura in legno collega lo schienale alla seduta, creando un dialogo visivo e funzionale tra i due volumi imbottiti. Il design esplora il contrasto tra la morbidezza accogliente della seduta e dello schienale imbottiti e la forza materica del legno.

Upholstered armchair with fabric or leather covering, distinguished by a distinctive solid wood backrest that serves as both a structural and decorative element. The solid and sinuous wooden frame connects the backrest to the seat, creating a visual and functional dialogue between the two upholstered volumes. The design explores the contrast between the welcoming softness of the padded seat and backrest and the material strength of the wood.

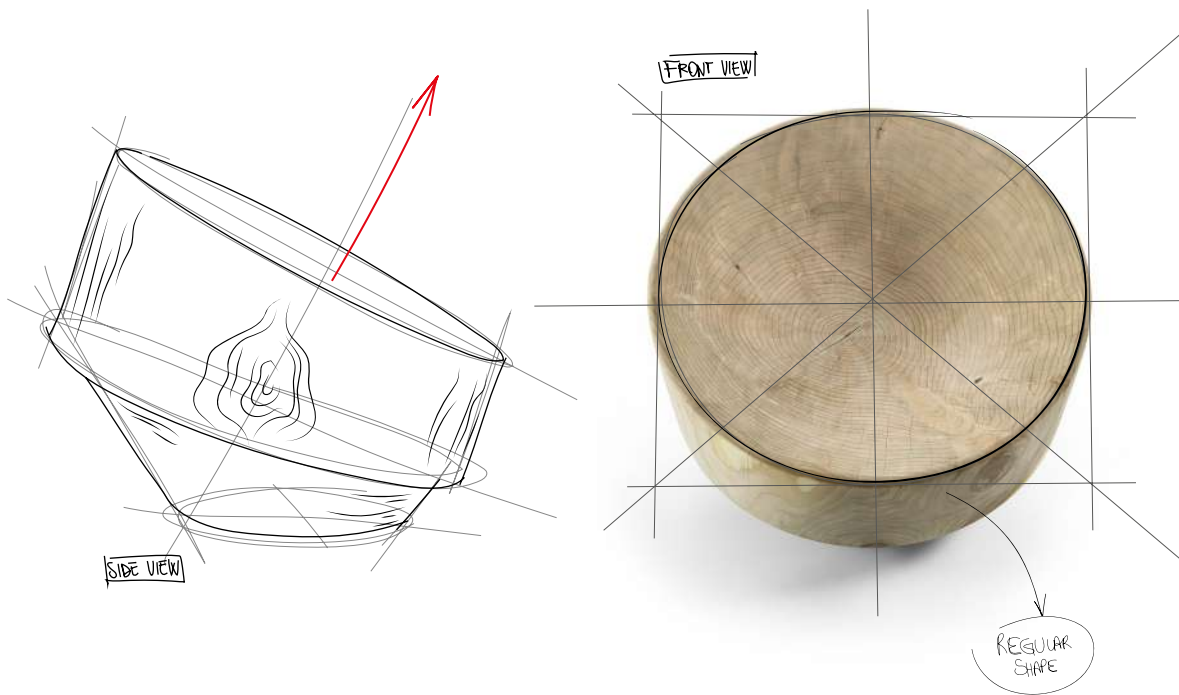

PALIO

design Ronald Sasson

Poltrona in legno massello di cedro profumato lavorata da un blocco unico. Un monolite scultoreo dal design curvilineo caratterizzato da una seduta ergonomica in linea di continuità con lo schienale. Il suo design nasce da un'attenta ricerca sull'impatto delle forme circolari perfette, quasi cinetiche, sui volumi di materia prima.

Armchair in solid aromatic cedar wood, crafted from a single block. A sculptural monolith with a curvilinear design, characterized by an ergonomic seat that flows seamlessly into the backrest. Its design stems from a careful study of the impact of perfect, almost kinetic, circular shapes on raw material volumes.



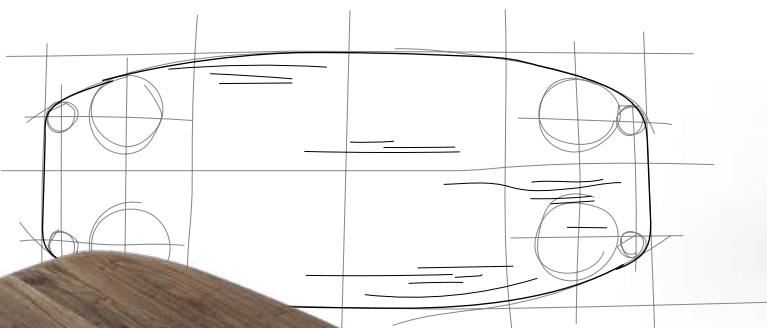
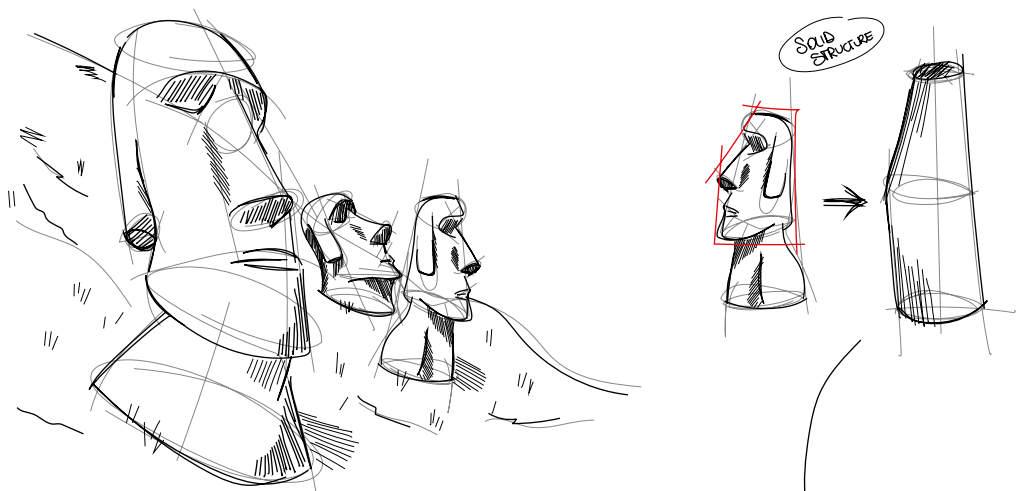

PALMA

design Ronald Sasson

Tavolo con top in legno massello a liste incollate con bordi smussati. Le gambe, dalla forma scultorea, sono concepite come un equilibrio tra due volumi che, pur opponendosi visivamente in modo inaspettato, mantengono una perfetta stabilità.

Table with a solid wood top with glued slats, with rounded edges. The legs, with a sculptural shape, are conceived as a balance between two volumes that, despite visually opposing each other in an unexpected way, maintain perfect stability.

WOOD NATURE COLLECTION



KOMODA

design AC Design

Poltrona in legno massello di cedro profumato dalle linee fluide e avvolgenti. La sua forma organica e ondulata esalta la naturale bellezza della materia prima, mentre l'ergonomia assicura un'esperienza di relax. KOMODA non è solo un elemento d'arredo, ma un invito a riscoprire il lusso della semplicità, in perfetta armonia con la filosofia di bellezza e benessere di Aldo Coppola. Struttura con gamba girevole in acciaio satinato.

Armchair made from solid scented cedar wood, featuring fluid, enveloping lines. Its organic, undulating form, enhances the natural beauty of the raw material, while its ergonomics ensure an experience of relaxation. KOMODA is more than just a piece of furniture; it's an invitation to rediscover the luxury of simplicity, perfectly in tune with Aldo Coppola's philosophy of beauty and well-being. Base with rotating leg in satin steel.

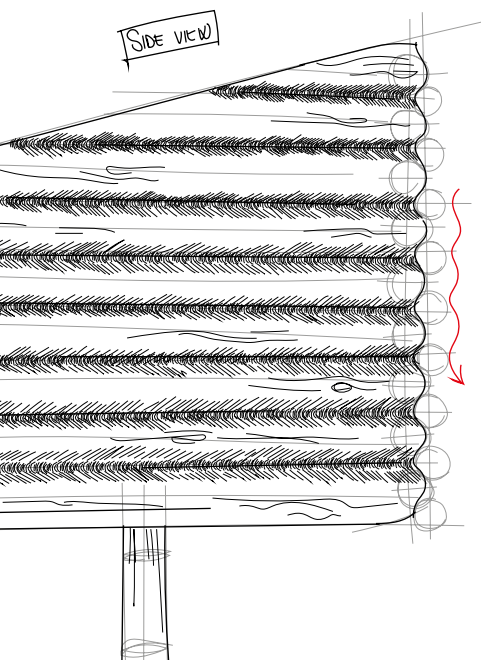

BEKKUCCIO

design AC Design

Specchiera in legno massello di cedro profumato che celebra l'oggetto più iconico nel mondo dell'hairstyling: la molletta. In questa interpretazione visionaria di Aldo Coppola Jr., la molletta diventa una struttura scultorea in legno massello di cedro che sostiene un grande specchio contornato da luci LED integrate.

Mirror crafted from solid scented cedar wood, celebrating one of the most iconic objects in the world of hairstyling; the hair clip. In this visionary interpretation by Aldo Coppola Jr., the hair clip is transformed into a sculptural structure made of solid cedar wood, supporting a large mirror framed by integrated LED lighting.

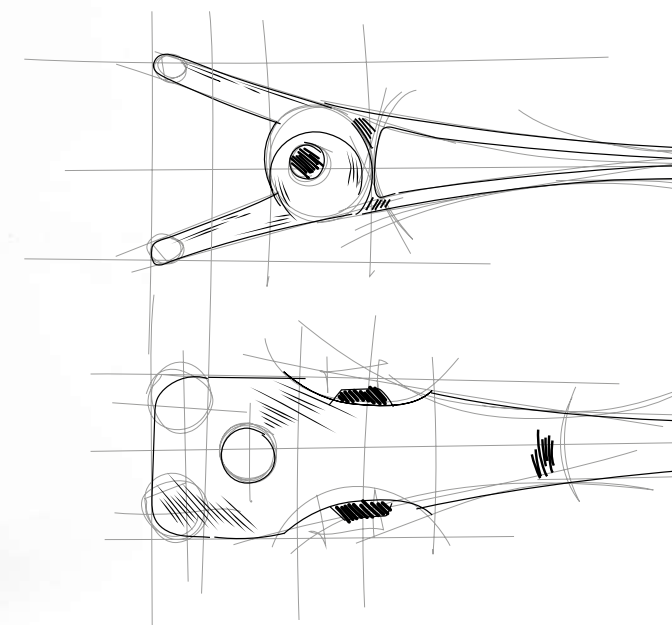

AUDREY

design AC Design

Panca in legno massello di cedro profumato che prende il nome e la forma dall'iconica spazzola Aldo Coppola. Le setole, reinventate in legno massello di cedro, donano alla panca un aspetto unico e immediatamente riconoscibile. La seduta ergonomica offre il massimo del comfort, rendendola perfetta sia per un momento di pausa che come pezzo statement in qualsiasi ambiente.

Bench made of solid scented cedar wood, taking its name and shape from the iconic Aldo Coppola brush. The bristles, reimaged in solid cedar wood, give the bench a distinctive and instantly recognizable look. The ergonomic seat ensures maximum comfort, making it perfect for a moment of relaxation or as a statement piece in any setting.

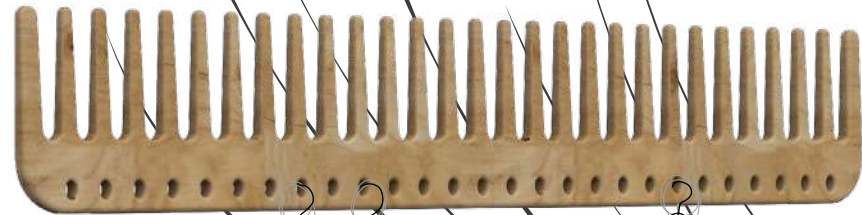
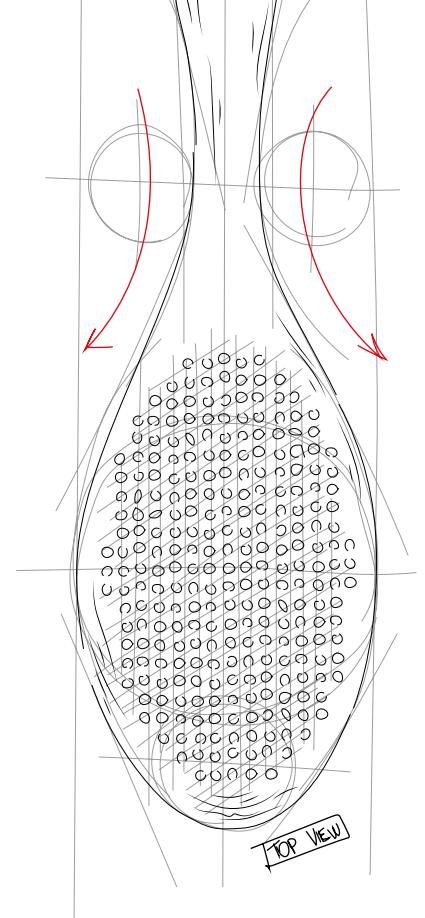

LA PETTINEUSE

design AC Design

Appendiabiti in legno massello di cedro profumato, ispirato alla forma del pettine, strumento essenziale nel mondo dell'hairstyling. Questo pezzo di design reinventa un oggetto quotidiano in una scultura dal forte impatto visivo. LA PETTINEUSE è un tributo all'artigianalità, alla bellezza e alla funzionalità: un complemento d'arredo che racconta la storia di un mestiere.

Coat rack made from solid scented cedar wood, inspired by the shape of the comb—an essential tool in the world of hairstyling. This design piece reinvents an everyday object into a visually striking sculpture. LA PETTINEUSE is a tribute to craftsmanship, beauty, and functionality; a furnishing accessory that tells the story of a profession.

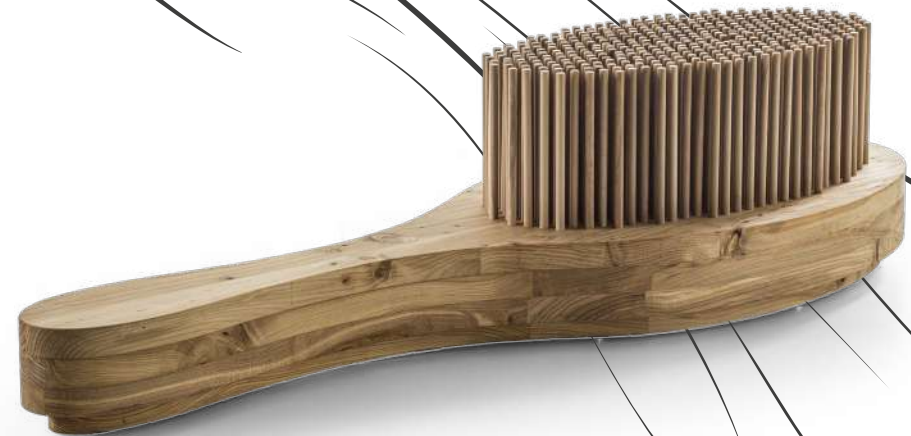

A-BOOK

design **Fabio Di Bartolomei**

Libreria in legno massello, caratterizzata da ripiani sorretti da una struttura verticale a forma di A. Può essere impiegata come elemento divisorio all'interno degli spazi o posizionata contro una parete, fungendo da espositore per oggetti e libri.

Solid wood bookcase, featuring shelves supported by a vertical A-shaped structure. It can be used as a room divider or placed against a wall, serving as a display unit for objects and books.

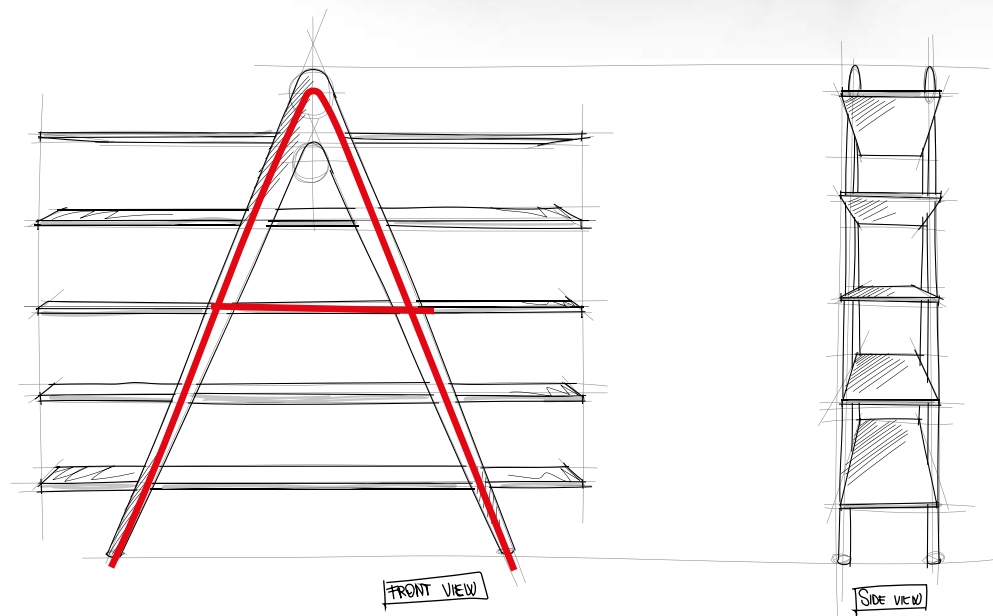

TABLEAU

design Authentic Design

Tavolo con piano e gambe composti da blocchi di legno massello di recupero, ottenuti da sfridi di lavorazione e uniti tramite resina nera. Il design si ispira al celebre Tableau I di Mondrian, a cui il tavolo rende omaggio nel nome.

A table with a top and legs made from solid reclaimed wood blocks, sourced from production offcuts and bonded together with black resin. The design is inspired by Mondrian's iconic Tableau I, paying homage to the artwork through its name.

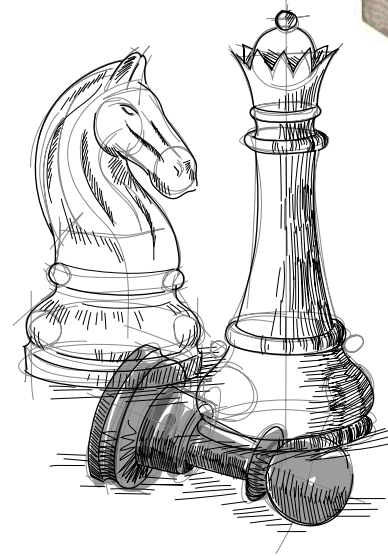

SCACCHIERA

design Authentic Design

Tavolo quadrato con top composto da blocchi di legno massello di cedro di recupero uniti tramite resina nera, il tutto racchiuso in una cornice di legno massello. Base in ferro a forma pentagonale dotata di saldature a vista.

Square table with a top made of reclaimed solid cedar wood blocks joined together with black resin, all enclosed within a solid wood frame. The base is made of iron in a pentagonal shape, featuring visible welds.

WEB

design Authentic Design

Tavolo con top rotondo in legno massello a liste incollate, sostenuto da una base in fibra di carbonio intrecciata. Nonostante la leggerezza del materiale, la struttura della base garantisce un'elevata resistenza, supportando il peso del top in massello.

Table with a round top made of solid wood with glued slats, supported by an interwoven carbon fiber base. Despite the lightweight nature of the material, the base structure ensures high strength and stability, effectively supporting the solid wood top.



WEB SMALL

design Authentic Design

Tavolino con top rotondo in legno massello a liste incollate, sostenuto da una base in fibra di carbonio intrecciata. Nonostante la leggerezza del materiale, la struttura della base garantisce un'elevata resistenza, supportando il peso del top in massello.

Small table with a round top made of solid wood with glued slats, supported by an interwoven carbon fiber base. Despite the lightweight nature of the material, the base structure ensures high strength and stability, effectively supporting the solid wood top.

INCASTRO

design Authentic Design

Tavolo realizzato con top in legno massello a liste incollate, con gambe passanti a vista sul top con un caratteristico incastro. La geometria dell'incastro è ripresa nella sezione del top e delle gambe, in una versione più allungata per garantire coerenza estetica e strutturale.

Table made with a solid wood top composed of glued slats, with visible through legs featuring a characteristic joint. The geometry of the joint is echoed in the cross-section of the top and legs, in a more elongated version to ensure both aesthetic and structural coherence.

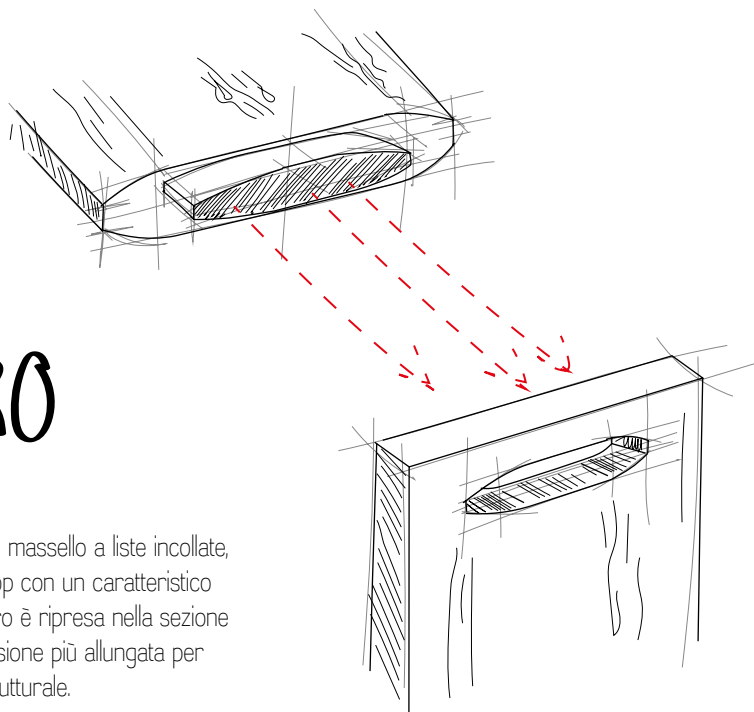

INCASTRO ISOLA

design Authentic Design

Elemento contenitore centro stanza ideale per cabine armadio, in legno massello. Composto da tre ripiani che si intersecano alle spalle mediante incastri a vista. Dotato di sei vani assemblati con incastri a coda di rondine, due per ogni ripiano, con scorrimento legno su legno. Disponibile, su richiesta, teca in vetro da applicare al primo ripiano con funzione vetrina.

Free-standing storage unit, ideal for walk-in closets, made of solid wood. Composed of three shelves that intersect with the side panels through exposed joints. Equipped with six compartments assembled with dovetail joints, two per shelf, featuring traditional wood-on-wood sliding. Optional glass display case available on request, to be placed on the top shelf.



MODULA NIGHT

design Authentic Design

Sistema notte componibile costituito da pannelli boiserie, integrabile con cassetti, mensole e accessori appendiabiti. I pannelli boiserie sono realizzati in listellare impiallacciato e disponibili anche nella versione con lavorazione verticale Fresart. Le mensole sono in listellare impiallacciato, mentre i cassetti presentano tradizionali incastri a coda di rondine. Il sistema prevede la possibilità di integrare strisce LED e specchi nella composizione. Sono inoltre disponibili componenti armadio personalizzabili a disegno.

Modular night system composed of boiserie panels, which can be integrated with drawers, shelves, and clothes-hanging accessories. The boiserie panels are made of veneered blockboard and are also available in the Fresart version featuring vertical detailing. The shelves are made of veneered blockboard, while the drawers are crafted with traditional dovetail joints. The system also offers the option to incorporate LED strips and mirrors into the composition. Custom-designed wardrobe components are also available.

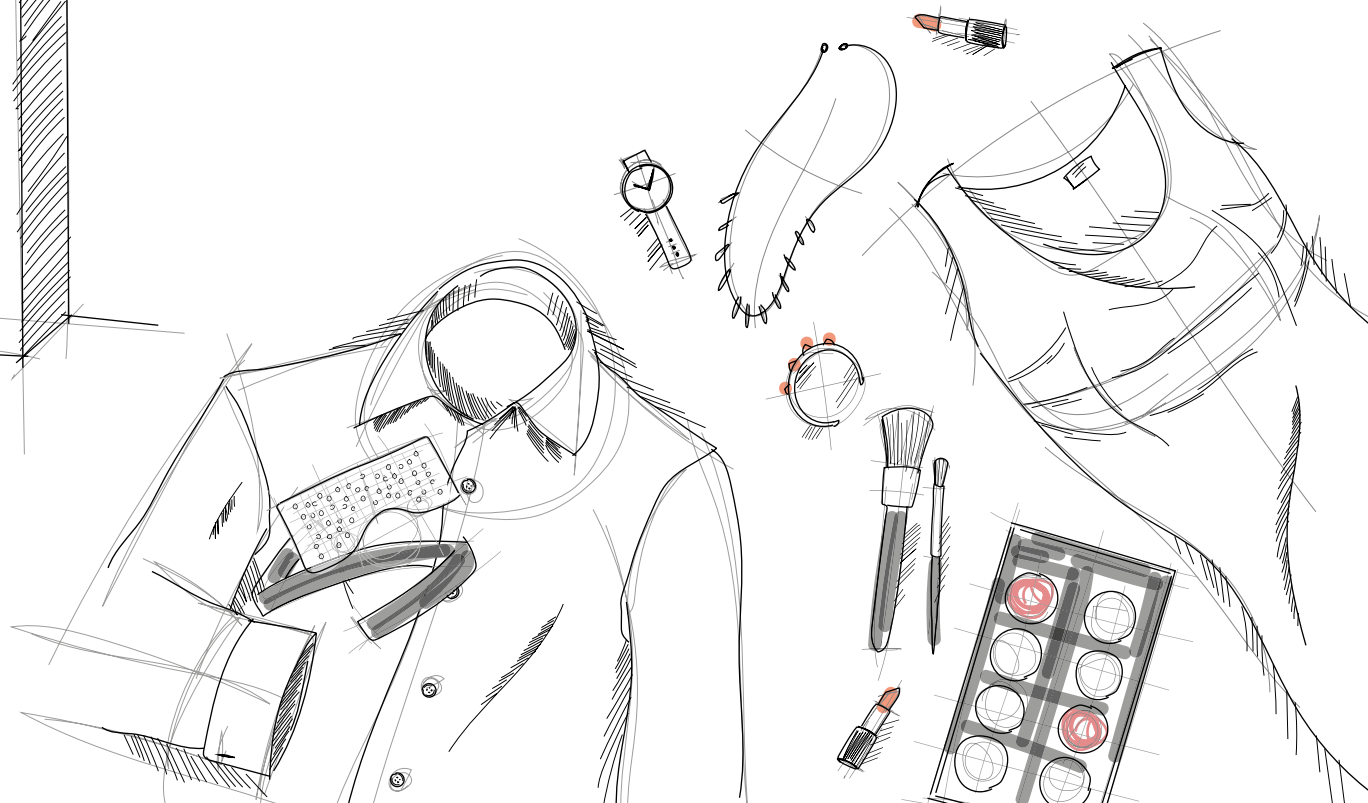

RIGA

design Authentic Design

Armadio in listellare e legno massello, con ante a battente in vetro o legno con telaio in alluminio laccato. Il telaio dell'anta, oltre a svolgere una funzione strutturale, è progettato per fungere anche da maniglia, grazie al posizionamento arretrato del vetro. L'armadio propone un'organizzazione funzionale e componibile dei vari elementi sulla base delle esigenze contenitive e delle dimensioni richieste. Personalizzabile con l'inserimento di appendiabiti, ripiani, cassettiere in legno massello con tradizionale incastro a coda di rondine e accessori vari. Ideale con interni in legno di cedro profumato, naturale rimedio contro le tarme. Illuminazione a LED disponibile su richiesta.

Wardrobe made of veneered blockboard and solid wood, featuring hinged doors in glass or wood with a lacquered aluminum frame. The frame of the door, in addition to providing structural support, is designed to also serve as a handle, thanks to the recessed positioning of the glass. The wardrobe offers a functional and modular organization of the various components, tailored to the storage requirements and dimensions requested. It is customizable with the addition of hangers, shelves, solid wood drawers with traditional dovetail joints, and various accessories. Ideal with cedar wood interiors, a natural deterrent against moths. LED lighting is available upon request.

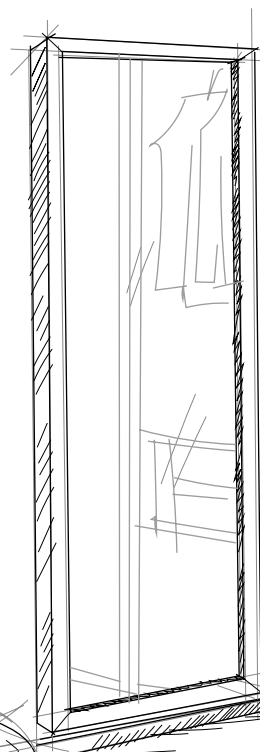
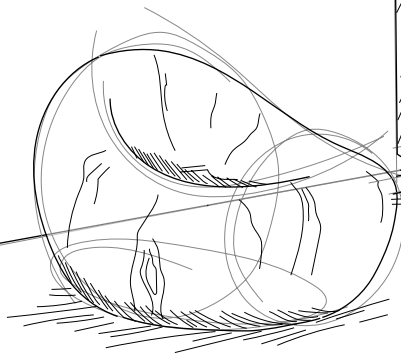
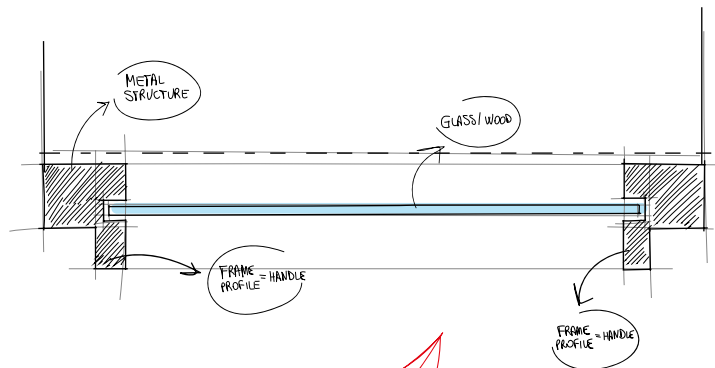

TOTEMICA

design Claudio Bellini

Chaise longue imbottita con seduta ergonomica, modellata secondo le linee naturali del corpo. Rivestimento disponibile in tessuto o pelle. La culla, realizzata con scocca in legno, è inclinata per favorire il relax. La stabilità è garantita da un piedistallo in cedro profumato, ricavato da un unico blocco, con profilo morbido e tondeggiante. Dotata di un poggiatesta imbottito, mantenuto in posizione da un contrappeso in legno di cedro. Disponibile, su richiesta, un accessorio svuotasche in cedro massello, che riprende la forma del piedistallo.

Upholstered chaise longue with an ergonomic seat, shaped to follow the natural contours of the body. Available with fabric or leather upholstery. The recliner, featuring a solid wood shell, is angled to promote relaxation. Stability is ensured by a pedestal base in scented cedar, crafted from a single block with a smooth, rounded profile. Equipped with a padded headrest, held in place by a cedar wood counterweight. An optional solid cedar tray accessory, echoing the shape of the pedestal, is available on request.

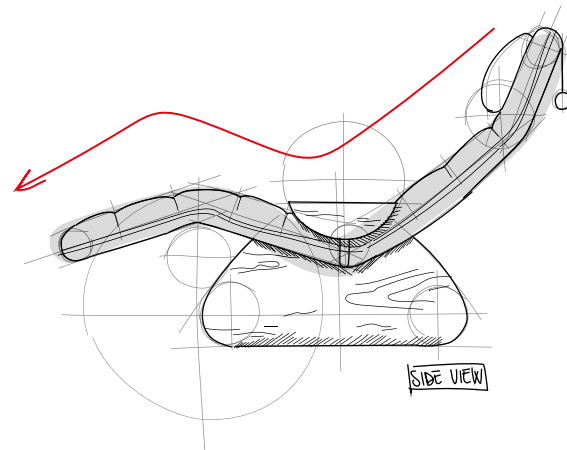
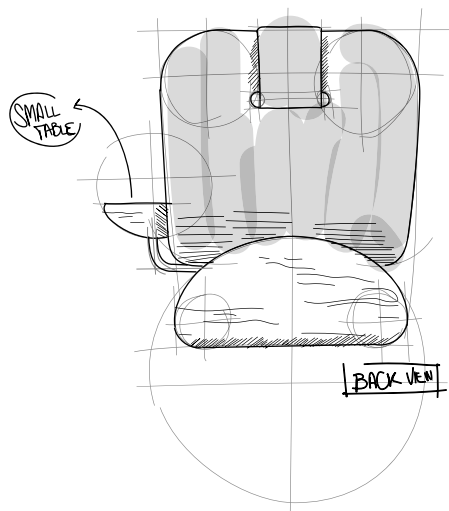

GIACINTO

design AMeBE Design Studio

Panca in legno massello di cedro profumato, lavorata da un unico blocco, caratterizzata da una seduta che richiama la forma di un materasso, creando un contrasto con l'idea di morbidezza, pur offrendo un comfort notevole. La panca è decorata con bottoni in legno di cedro e abbinata a gambe in vetro o ferro.

Bench made of solid scented cedar wood, crafted from a single block, featuring a seat that recalls the shape of a mattress, creating a contrast with the idea of softness while still offering remarkable comfort. The bench is decorated with cedar wood buttons and complemented by glass or iron legs.

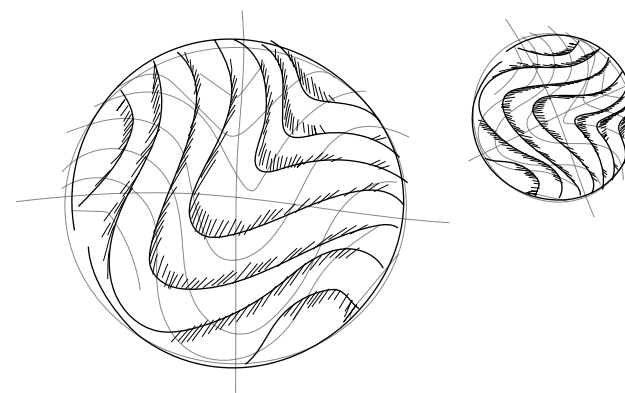

WAVES

design Authentic Design

Sgabello in legno massello di cedro profumato, lavorato da un blocco unico e caratterizzato da un originale design a onde. La seduta è levigata, mentre i lati mantengono una finitura grezza. Ispirato alla forma di un sanitario, ne rappresenta una reinterpretazione innovativa: grazie alla lavorazione del legno, è possibile ottenere morbide ondulazioni, un effetto che la ceramica, solitamente usata per i sanitari, non permette di realizzare.

A stool made from solid, scented cedar wood, crafted from a single block and distinguished by its unique wave-like design. The seat is smooth, while the sides retain a raw finish. Inspired by the shape of a sanitary fixture, it offers an innovative reinterpretation: the use of wood allows for soft, flowing undulations—an effect that would be impossible to achieve with ceramic, the material traditionally used for such fixtures.

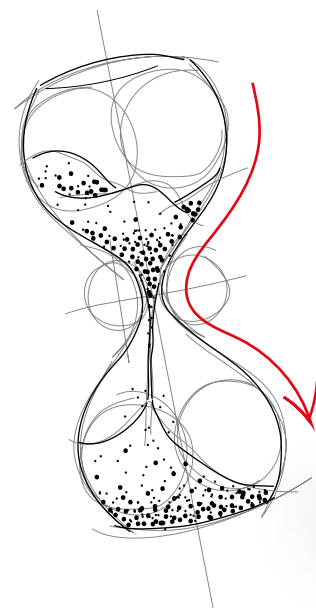

TEMPO

design Authentic Design

Sgabello in legno massello di cedro profumato lavorato da un blocco unico, che si ispira alla forma sinuosa di una clessidra in vetro soffiato dove il raccordo centrale, apparentemente esile, rappresenta in realtà un solido elemento strutturale.

Stool made of solid scented cedar wood, crafted from a single block. The design is inspired by the sinuous shape of a blown glass hourglass, where the central junction, seemingly slender, actually serves as a solid structural element.



MIAO O STOO

design Alessandro Guidolin

Sgabello in legno massello di cedro profumato lavorato da un blocco unico, ottenuto da legno di recupero. Il design si ispira alla zampa di un gatto, evocandone le forme morbide. La seduta è arricchita da cuscinetti imbottiti in tessuto o pelle, sagomati a imitazione dei polpastrelli felini.

Stool made of solid scented cedar wood, crafted from a single block and obtained from reclaimed wood. The design is inspired by a cat's paw, evoking its soft shapes. The seat is enhanced with padded cushions in fabric or leather, shaped to mimic feline paw pads.





Riccio

design Anton Kobrinetz

Panca in legno massello di cedro profumato il cui design si ispira alla forma di un riccio. Gli "aculei" sono composti da tasselli cilindrici di legno massello appoggiati su un cuscinetto ammortizzante, garantendo comfort e flessibilità. Il concept trae origine dalla tradizione oaxaqueña degli *animalitos*, in cui le forme naturali dei rami d'albero vengono intagliate per creare figure animali, arricchite da decorazioni pittoriche ornamentali.

*Bench made of solid aromatic cedar wood, with a design inspired by the shape of a hedgehog. The "spines" are made of cylindrical solid wood dowels resting on a cushioning pad, ensuring comfort and flexibility. The concept is inspired by the Oaxacan tradition of *animalitos*, where the natural shapes of tree branches are carved into animal figures, enriched with ornamental painted decorations.*

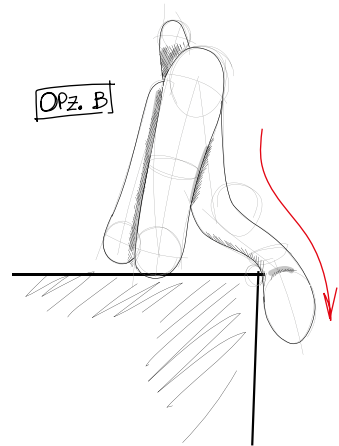
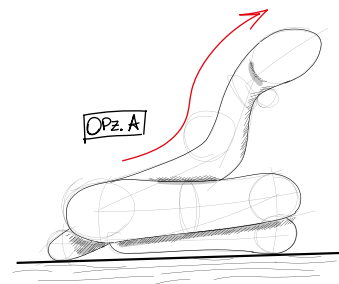
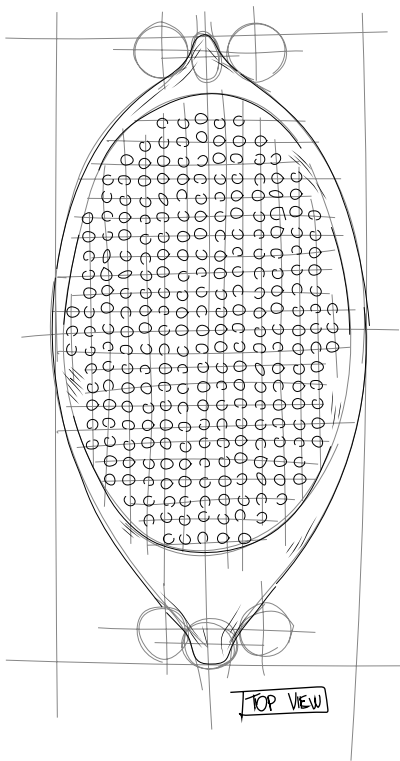

HEBI

design Setsu&Shinobu Ito

Un pregiato complemento d'arredo in legno massello di cedro profumato, il cui design celebra il Capodanno cinese ispirandosi al serpente, simbolo dell'anno lunare 2025. Un oggetto di design che diventa un elemento decorativo per ogni ambiente.

A meticulously crafted furniture piece made from solid, scented cedar wood. Its design pays homage to the Chinese New Year, drawing inspiration from the snake—symbolizing the lunar year 2025. A design object that becomes a decorative element for any space.

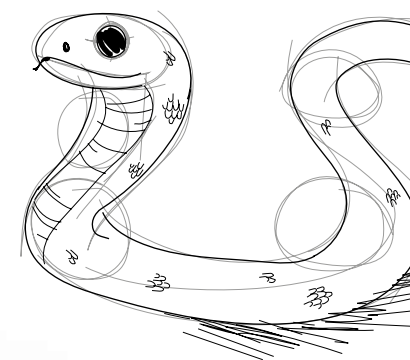

OLAF

design Authentic Design

Complemento d'arredo in cedro profumato che reinterpreta la classica figura del pupazzo di neve. Realizzato in due dimensioni, presenta la tradizionale sagoma composta da tre sfere sovrapposte e completata da un cappellino dalle forme arrotondate.

Furnishing accessory in scented cedar wood that reinterprets the classic snowman figure. Made in two sizes, it features the traditional silhouette composed of three stacked spheres, completed by a rounded hat.

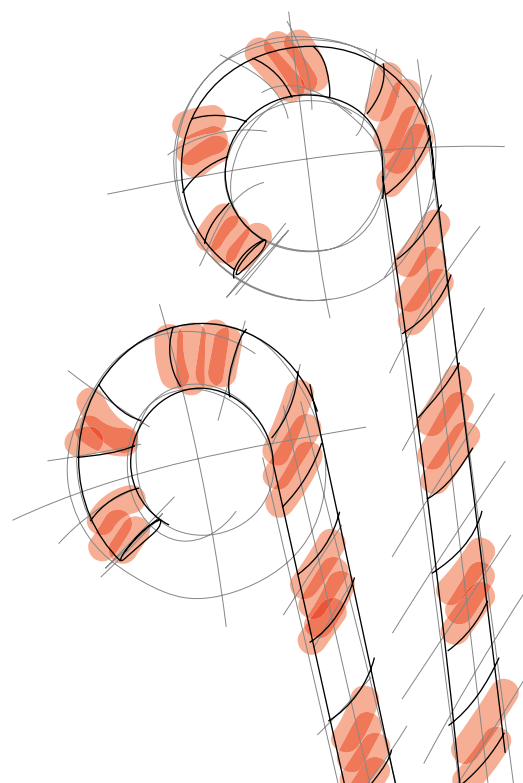
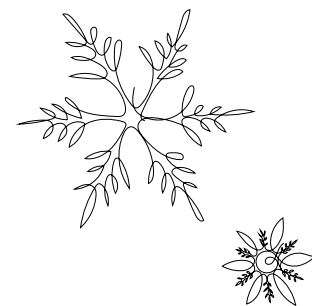
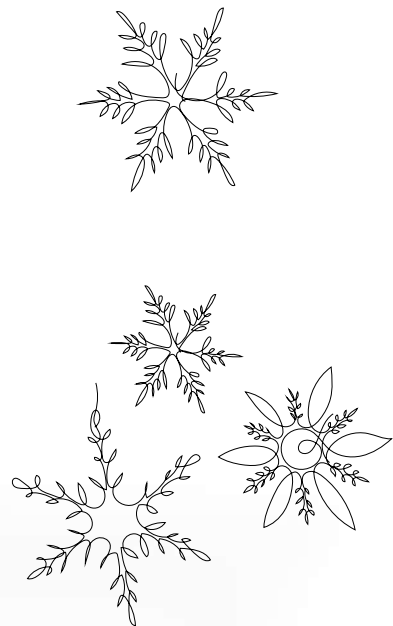

SCHIACCIANOCI

design Authentic Design

Complemento d'arredo in cedro profumato che reinterpreta la tradizionale figura del soldatino Schiaccianoci, simbolo iconico del Natale. La sagoma viene proposta in una versione contemporanea, caratterizzata da volumi morbidi e linee tondeggianti, in un equilibrio tra tradizione e design.

Furnishing accessory in scented cedar wood that reinterprets the traditional figure of the Nutcracker soldier, an iconic symbol of Christmas. The silhouette is presented in a contemporary version, characterized by soft volumes and rounded lines, striking a balance between tradition and modern design.



WWW.RIVA1920.IT

RIVA 1920
Riva Industria Mobili SPA
Via Milano, 137
22063 Cantù
Como · Italy
T. +39 031 73 30 94
F. +39 031 73 34 13
info@riva1920.it

RIVA CENTER
Showroom, Museo del Legno
& Pangea Lab
Via Milano, 110
22063 Cantù
Como · Italy

RIVA ONE
One-of-a-kind Pieces of
Furniture Showroom
Via Genova, 13
22063 Cantù
Como · Italy

RIVA1920 BUILDING
Corso Italia Est | E03
(near Hall 7)
Fiera Milano
Rho · Italy

Production unit - 1
Via Milano, 137
22063 Cantù
Como · Italy

Production unit - 2
Via Genova, 13
22063 Cantù
Como · Italy

Production unit - 3
Via Como, 74
22066 Mariano C.se
Como · Italy