

Night Project

**SANGIACOMO**

Night Project

---

# Night Project

La notte è il tempo in cui la casa diventa il luogo dell'intimità, del relax, del silenzio. È qui che lo spazio prende forma attraverso volumi puri, materiali che dialogano tra loro, dettagli che raccontano la cura di ogni realizzazione. SANGIACOMO ricerca e interpreta questo equilibrio, con armadi progettuali che si sintonizzano con ogni ambiente domestico e gusto personale: sviluppando passaggi fra una stanza e l'altra, proponendo diverse tipologie di apertura, esplorando un'ampia varietà di finiture, integrando il guardaroba con la cabina armadio. La collezione dei letti offre a sua volta una scelta completa di misure e configurazioni, anche con testiere componibili che permettono di personalizzare la zona notte. I contenitori, gli scrittoi e le specchiere contribuiscono a disegnare un insieme coerente e accogliente, in cui la funzionalità e la bellezza convivono in perfetta armonia.

*The night is when the home becomes a place of intimacy, relaxation and silence. This is where space takes shape through pure depth, materials interacting with each other and carefully placed creative details. SANGIACOMO searches and interprets this balance with designer wardrobes that can blend with every home environment and personal taste: developing passages between rooms, with different types of openings, offering a wide variety of finishes, and integrating the wardrobe with the walk-in closet. The bed collection offers a complete range of sizes and configurations, including modular headboards for personalised bedrooms. Arrangements of storage units, desks and mirrors create a coherent and welcoming environment, where functionality and beauty coexist in perfect harmony.*

---

Armadio per l'Architettura	04
Ante per Armadio	98
Panorama Cabina	176
Itala Cabina	200
Letti	212
Contenitori notte	326
Tavolini	364

---

# Armadio per l'Architettura

Passaggi Nexta ante per passaggi <i>/ doors for doorways</i>	06	Odeon vani TV / <i>TV units</i>	66
Scigno ante vetro / <i>glass doors</i>	22	Ponte e ponte pensile <i>bridge &amp; wall-mounted bridge</i>	70
Bellavista cabina armadio / <i>walk-in closet</i>	34	Teche a giorno <i>open display cases</i>	76
Armadi ad angolo e terminali <i>end and corner wardrobes</i>	48	Armadio con Boiserie <i>wardrobe with Boiserie</i>	90
Collage cassettiere esterne <i>/ external drawer units</i>	62	Accessori <i>accessories</i>	162

## Architecture wardrobe system

Armadi che diventano pareti, dividono gli spazi, si adattano alle altezze e alle larghezze degli ambienti, integrandosi con la zona giorno sia nelle dimensioni che nelle finiture. Contenitori invisibili che entrano a fare parte di un unico progetto.

*Wardrobes that become walls, divide spaces, adapt to the heights and widths of rooms, integrating with the living area in both size and finish. Invisible storage units that become part of a single design.*



# Passaggi Nexta

## Nexta passages

Passaggi che creano collegamenti fra un ambiente e l'altro, integrandosi perfettamente con l'architettura d'interni.

*Doorways that create connections between rooms, integrating perfectly with the interior architecture.*



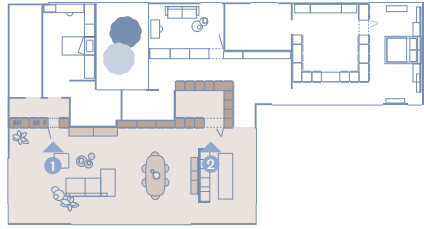

- ▲ 1 Passaggio Nexta battente con soprazzo  
/ Nexta Hinged walk-through with top unit
  
- ▲ 2 Passaggio Nexta pieghevole a 180°  
/ 180° Nexta folding walk-through

Armadio battente bifacciale integrato a TV Unit Domino con boiserie e passaggio Nexta battente, con soprazzo dotato di profilo Sinua. In questa immagine, un passaggio Nexta con anta battente a 90° conduce al soggiorno. Nella zona ingresso, un vano attrezzato consente di riporre abiti e accessori.

*Double-sided hinged wardrobe integrated with Domino TV unit with boiserie and hinged Nexta doorway, with raised section featuring Sinua profile. In this image, a Nexta doorway with 90° hinged door leads to the living room. In the entrance area, a custom compartment provides storage for clothes and accessories.*



Armadio battente P 450 integrato ad ante Scrigno con sopralzo. Boiserie Domino con mensole in metallo tavolo Poliedro con piano sp. 12 in ceramica e sedie Lena in legno.

*Hinged wardrobe D 450 integrated with Scrigno doors and raised top. Domino boiserie with metal shelves, Poliedro table with 12 mm thick ceramic top and Lena wooden chairs.*



Armadio battente bifacciale con passaggio Nexta pieghevole a 180° con profilo Sinua  
/ Double-sided hinged wardrobe with Nexta doorway with 180° folding door and Sinua profile



Armadio battente con sopralzo ed apertura push-pull in continuità con passaggio Nexta con anta Scigno sulla sinistra. Teca a giorno composta da basi Collage con cassetti e moduli ponte, con mensole sottoponte a tutta larghezza fissate agli schienali.

*Hinged wardrobe and compartments above with push-pull opening that continues into a Nexta doorway fitted with a Scigno door on the left. Open display unit composed of Collage base units with drawers and overhead storage modules, featuring full-width unit shelves fixed to the back panels.*



▲ 3 Passaggio Nexta battente con anta Scigno / Nexta Hinged walk-through with Scigno Door

Angolo battente con angolo aperto in continuità / Hinged corner with opening access from both sides



Armadio battente bifacciale in continuità con passaggio Nexta, anta Scigno a 90° e Teca a giorno con moduli Odeon porta TV, con finitura in contrasto.

*Double-sided hinged wardrobe in continuity with Nexta doorway, 90° Scigno door and open display unit with Odeon TV modules detailed with contrasting finish.*



Armadio battente bifacciale con vano cabina Bellavista, dotato di schienale in vetro trasparente che lascia passare la luce solare all'interno dello spazio notte. Testiera attrezzata Ecletto con contenitori e pannelli Boiserie Domino.

*Double-sided hinged wardrobe with Bellavista walk-in closet, fitted with transparent glass back panel that allows sunlight to enter the sleeping space. Ecletto headboard with storage units and Domino Boiserie panels.*



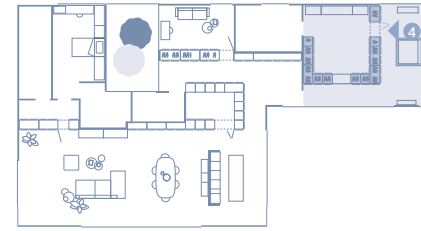

4 Passaggio Nexta pieghevole con anta Scigno / Nexta Folding walk-through with Scigno Door

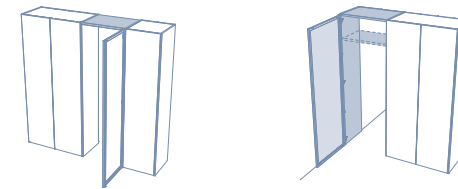

Passaggi NEXTA – con anta battente / NEXTA walk-through – with hinged door

L / W 570 / 720 / 870  
H 2241 / 2401 / 2561 / da 2561 a 2881 su misura / made-to-measure

Tipologia ante / Type of doors  
Liscia con maniglia / with handle  
Trail / Sinua / Ala / Scigno

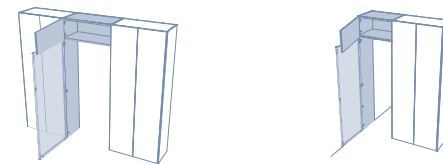

Passaggi NEXTA – battente con anta sopra / NEXTA walk-through – with hinged door on top element

L / W 570 / 720 / 870  
H 2241 / 2401 / 2561 / da 2561 a 2881 su misura / made-to-measure

Tipologia ante / Type of doors  
Liscia con maniglia / with handle  
Trail / Sinua / Ala / Scigno

Anta per sopra / Door for top element  
Push-pull  
Sinua

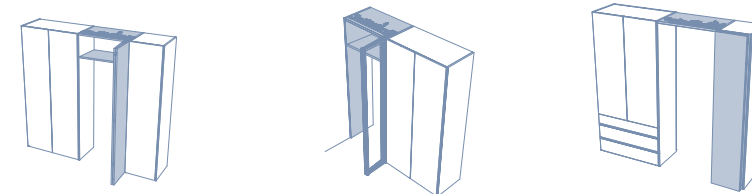

Passaggi NEXTA – con anta pieghevole a 90°/180° / NEXTA walk-through – with folding 90°/180° door

L / W 720 / 870 / 970 / 1170  
H 2241 / 2401 / 2561 / da 2561 a 2881 su misura / made-to-measure

Tipologia ante pieghevoli a 90° / Type of 90° folding doors  
Sinua / Ala / Scigno.

Tipologia ante pieghevoli a 180° / Type of 180° folding doors  
Sinua / Scigno.

# Sistema Scrigno

## Scrigno system

Scrigno è un sistema che prevede ante battenti e scorrevoli, caratterizzate da un telaio in metallo verniciato nelle finiture Brown, Piombo, Palladio e da vetri con diverse finiture. Può dare vita ad armadi classici, oppure diventare un contenitore con fianchi e schiene in vetro che diventano dei veri e propri espositori, resi ancora più suggestivi e irresistibili dal sistema di illuminazione a led interno. Inseriti nei telai, i ripiani in vetro trasparente creano suggestivi giochi di luce e riflessi, trasformando l'armadio in una prestigiosa boutique d'alta moda.

*Scrigno is a system that includes hinged and sliding doors, featuring a metal frame painted in Brown, Piombo, and Palladio finishes with a choice of various glass finishes. It can be used to create classic wardrobes or to become a storage unit with glass sides and backs that become display cases, made even more stunning and elegant by the internal LED lighting system. Inserted into the frames, the transparent glass shelves create striking plays of light and reflections, transforming the wardrobe into a prestigious high-fashion boutique.*



Armadio battente bifacciale Scrigno con ante, schienali e fianchi in vetro trasparente fumè  
/ Double-sided Scrigno hinged wardrobe with doors, back panels and side panels in transparent smoked glass



Armadio battente bifacciale Scigno con ante e fianchi in vetro satinato fumè  
/ *Scigno double-sided hinged wardrobe with doors and sides in smoked satin-finish glass*



Vetro satinato tramato / *Satin-finish tramato*



Vetro satinato cannettato / *Satin-finish cannettato*



Armadio battente con elemento centrale dotato di ante Scrigno, abbinato a moduli laterali con ante Vertigo. Il profilo verticale in comune fra i diversi elementi ne definisce la coerenza formale.

*Hinged wardrobe with central units fitted with Scrigno doors, combined with side modules with Vertigo doors. The consistent vertical profile in the various elements brings an elegant formality to the composition.*



Armadio scorrevole Scrigno con ante in vetro satinato tramato  
/ Scrigno sliding wardrobe with textured satin glass doors





## Sistema Scrigno



### FINITURE VETRO / GLASS FINISHES

Trasparente  
Trasparente Fumè  
Trasparente Bronzato  
Stop sol  
Satinato  
Satinato Fumè  
Satinato Tramato  
Satinato Cannettato

### FINITURE TELAI / FRAME FINISHES

Verniciato Epossidico  
Brown / Piombo / Palladio

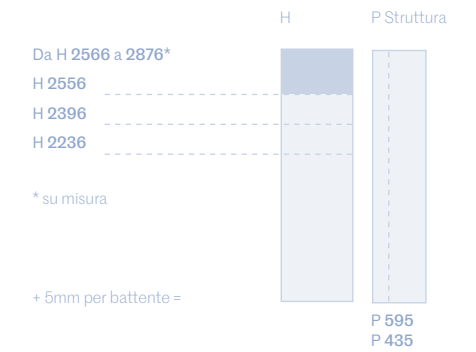

### Sezione / Section

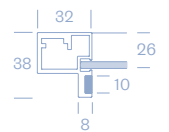

### Battente / Hinged

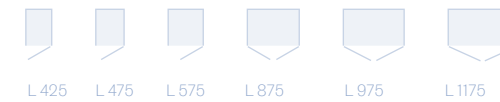

### Angoli / Corners



### Scorrevole / Sliding



### Angolo / Corner



### Struttura Scrigno / Scrigno Structure



- 1 Schienali legno spessore 8 mm per vani battente scorrevole.
- 2 Schienali in vetro per ante battente: trasparente, trasparente fumè, trasparente bronzato, satinato e satinato fumè
- 3 Fianchi laterali e divisioni centrali in legno spessore 25 mm per battente e scorrevole.
- 4 Fianchi laterali in vetro per battente in trasparente fumè, trasparente bronzato, satinato, satinato fumè, satinato tramato, satinato cannettato, stopsol.
- 5 Divisione centrale a telaio per battente Scrigno e per scorrevole in associazione a tutti i tipi di ante.

In continuità con la Cabina Bellavista di cui condivide fianchi, divisori e telai.

- 1 Wooden back panels for hinged and sliding compartments.
- 2 Back panels for hinged doors: in transparent, transparent smoked, transparent bronzed, satin-finish, smoked satin-finish glass.
- 3 Wooden side panels and central partitions th. 25 mm for hinged and sliding wardrobes.
- 4 Glass side panels for hinged wardrobe in transparent smoked, transparent bronzed, satin-finish, satin-finish smoked, satin-finish tramato, satin-finish fluted, stopsol.
- 5 Central framed partition for Scrigno hinged and for sliding wardrobe combined to all types of doors.

In continuity with the Bellavista Walk-in Closet, with which it shares side panels, partitions, and frames.

# Bellavista

## Armadio cabina

La cabina armadio Bellavista interpreta il sistema "Armadio", al quale può essere abbinabile con continuità, alleggerendone i volumi e offrendo la massima libertà di configurazione. La sua struttura modulare permette di creare soluzioni lineari e angolari, con fianchi e divisori a telaio in metallo o in vetro per i fianchi terminali. Se si desidera una maggiore corposità, è possibile scegliere fianchi e divisori in legno con spessore 25 mm o 35 mm. Le finiture sono protagoniste, così come l'attrezzatura disponibile per ogni esigenza: appenderie, cassettiere, ripiani e vassoi estraibili.

*The Bellavista walk-in closet presents a seamlessly combined 'Armadio' system, opening up the space and offering maximum freedom of configuration. Its modular structure allows you to create linear and corner solutions, with partitions and side panels in metal, or partitions, side and end panels in glass. For a more solid look, you can choose 25 mm or 35 mm thick wooden side panels and partitions. Hanging rails, drawers, shelves and pull-out trays become elegant focal points while accommodating every need.*



Cabina Bellavista bifacciale con schienale in vetro. Armadio bifacciale Grace con passaggio Nexta in continuità  
/ Bellavista double-sided walk-in closet with glass back panel. Grace double-sided wardrobe in continuity with Nexta doorway



Cabina armadio Bellavista, con schienale in vetro e moduli Armadio bifacciali con ante battenti Grace. Il passaggio Nexta, integrato nella composizione, è dotato di ante pieghevoli Scrigno con apertura a 180° che introducono al vano guardaroba, coordinato esteticamente con la cabina armadio Panorama racchiusa al suo interno.

*Bellavista walk-in closet with glass back panel and double-sided wardrobe modules with Grace hinged doors. The Nexta doorway, featured in this composition, is equipped with Scrigno folding doors with 180° opening that lead into an aesthetically combined Panorama walk-in closet.*



Cassettiere sospese con top in vetro fumè, cassetto dotato di tappetino con divisori e vaschette in appoggio in ecopelle, luce a led di cortesia dietro al frontale.

*Suspended drawer units with smoked glass top, drawer equipped with mat, partitions and eco-leather trays, LED courtesy light.*



Cabina armadio Bellavista con divisori a telaio, accostata all'armadio battente Scigno  
/ Bellavista walk-in closet with frame partitions, combined with Scigno hinged wardrobe



Armadio battente con anta Liscia e anta Scrigno che diventa espositore, integrato a passaggi Nexta con anta battente a 90°. All'interno, si intravede la cabina armadio Bellavista.

*Liscia door and Scrigno door become a hinged-door display unit. The integrated Nexta 90° hinged door leads into the Bellavista walk-in closet.*



La cabina armadio Bellavista offre vani di grandi dimensioni, anche ad angolo, con cassette integrate. Fianchi e divisori di spessore maggiorato (35 mm anziché 25 mm standard) possono creare una continuità con i ripiani dello stesso spessore.

*The Bellavista walk-in closet offers large compartments, including corner compartments, with integrated drawer units. Extra-thick side panels and partitions (35 mm instead of the standard 25 mm) can create continuity with shelves of the same thickness.*





## Modularità e tipologie Bellavista



- 1 Schienali legno spessore 8 mm
- 2 Schienali in vetro trasparente, trasparente fumè, trasparente bronzato, satinato e satinato fumè (L 350/425/475/575/725/875/975/1175)
- 3 Fianchi laterali e divisori centrali legno spessore 25 o 35 mm
- 4 Fianchi laterali in vetro trasparente, trasparente fumè, trasparente bronzato, satinato, satinato fumè.
- 5 Divisorio centrale a telaio spessore 25 mm

In continuità con la Cabina Bellavista di cui condivide fianchi, divisori e telai.



- 1 Wooden back panels thickness 8 mm
- 2 Back panels in transparent, transparent smoked, transparent bronzed, satin-finish, smoked satin-finish glass (W 350/425/475/575/725/875/975/1175)
- 3 Wooden side panels and central partitions thickness 25 or 35 mm.
- 4 Side panels in transparent, transparent smoked, transparent bronzed, satin-finish, satin-finish smoked glass.
- 5 Central framed partition thickness 25 mm

In continuity with the Bellavista Walk-in closet, with which it shares side panels, partitions, and frames.

### FINITURE STRUTTURA / STRUCTURE FINISHES

Materico Loto / Sketch / Olmo / Econoce / Tramato Lino  
Laccato opaco  
Laccato Metallo

### FINITURE FIANCHI DIVISORI A TELAIO / FRAMED PARTITION FINISHES

Verniciato Epossidico  
Brown / Piombo / Palladio

### MODULARITÀ / MODULARITY



L 350 L 425 L 475 L 575 L 725 L 875 L 975 L 1175 L 1325 L 1475

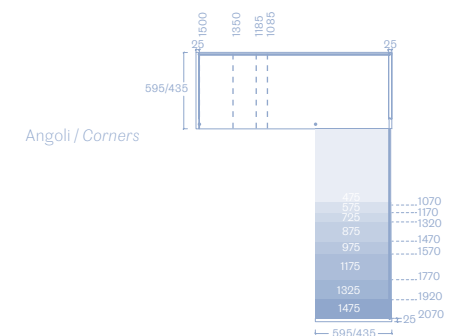
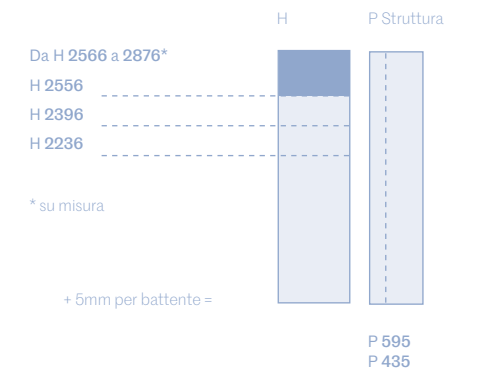

# Armadi ad angolo e terminali

## End and corner wardrobes

Soluzioni inedite permettono di sfruttare tutti gli spazi domestici, anche i più difficili, mantenendo un'estetica al tempo stesso essenziale ed elegante.

*Innovative solutions allow you to make the most of even the most difficult spaces, while maintaining minimalism and elegance.*



Armadio battente con profilo Tape e teca a giorno, base Collage con cassetti. Il modulo battente ad angolo continuo sfrutta e ottimizza in maniera funzionale lo spazio tra l'armadio e il comodino.

*Hinged wardrobe with Tape profile and open Teca cabinet, Collage base unit with drawers. The continuous corner hinged module optimises and functionally uses the space between the wardrobe and the bedside table.*



Armadio battente con angolo e terminale caratterizzato dal profilo Breccia, ante e fianchi rivestiti della stessa finitura delle ante in ecovintage.

*Hinged wardrobe with corner and end panel characterised by the Breccia profile, doors and side panels covered in the same eco-vintage finish.*



Elemento terminale battente.  
/ End unit with hinged door



Elemento angolare battente  
/ Corner unit with hinged door



Armadio battente bifacciale con maniglie Ala mini e passaggio Nexta pieghevole a 90°, angolo spogliatoio attrezzato e dotato di ante specchio dark, terminale aperto con luce led verticale.

*Double-sided hinged wardrobe with Ala mini handles and Nexta 90° folding doorway, a dressing room corner with dark mirror doors, open end shelves fitted with vertical LED light.*



Armadio battente bifacciale con maniglia Beta, in tinta, a incasso. Vano a giorno laterale con appendiabiti estraibile.

*Double-sided hinged wardrobe with same color built-in Beta handles. Side open compartment with pull-out clothes hanging rail.*



Armadio battente bifacciale con moduli dotati di ante Scrigno, abbinati a elementi con ante Vertigo, e sopralzi sono dotati di apertura push-pull  
/ Double-sided hinged wardrobe modules featuring Scrigno doors, combined with modules fitted with Vertigo doors, and top elements equipped with push-pull opening





Nell'immagine a sinistra, armadio battente bifacciale con pannelli di finitura in continuità, armadio con sopralzi e schienale sottoponte attrezzato con pianale e mensole dotate di illuminazione a led. A destra l'elemento ad angolo aperto con ante Scigno e sopralzi con apertura push-pull.

*In the left image, double-sided hinged wardrobe with end panels in a continuous finish, wardrobe with top elements and back panel equipped with shelves and LED lighting. On the right, the open angle unit with Scigno doors and top elements with push-pull opening.*



# Collage

Con il suo gioco di ante e cassetti, Collage offre nuove possibilità funzionali ed estetiche. I vani a giorno Teca, dotati di illuminazione a led integrata, si possono utilizzare per mettere in mostra degli oggetti cari o preziosi, oppure per creare una libreria.

*With its combination of doors and drawers, Collage offers new functional and aesthetic possibilities. The Teca open compartments, equipped with integrated LED lighting, can be used to display cherished or precious objects, or to create a bookcase.*

Armadio battente bifacciale con elementi Collage dotati di cassetti e Teca a giorno, ante battenti con profilo Breccia  
/ Double-sided hinged wardrobe with Collage units fitted with drawers and open Teca cabinet; hinged doors with Breccia profile



Armadio battente con modulo Collage dotati di cassetti e ante battenti con maniglie Ala mini. Il fianco dell'armadio è dotato di specchio  
/ Hinged wardrobe with Collage module fitted with drawers and hinged doors with Ala mini handles. The side of the wardrobe is fitted with a mirror



# Odeon

Il guardaroba Odeon è caratterizzato dall'inserimento di un elemento dedicato all'home entertainment, con porta TV orientabile e comodi vani per una molteplicità di utilizzi. Questa soluzione viene abbinata ad ante battenti e cassetti esterni. Le ante e i cassetti sono disponibili con gola o con maniglia.

*The Odeon wardrobe features a dedicated home entertainment unit with an adjustable TV shelf and convenient compartments for a variety of uses. This solution is combined with hinged doors and external drawers, both of which are available with grip profile or knobs.*

Armadio battente con modulo Odeon dotato di cassetti e vano a giorno  
/ Hinged wardrobe with Odeon module equipped with drawers and open compartment



Armadio scorrevole con modulo Odeon con pannello porta TV dotato di cassetti e vano a giorno per l'alloggiamento degli impianti.

*Sliding wardrobe with Odeon module with a TV panel equipped with drawers and an open compartment for housing equipment.*



# Ponte e ponte pensile

## Bridge & wall-mounted bridge

Armadio battente ad angolo continuo, con maniglie a incasso Beta ed elementi a Ponte con apertura a sormonto. Nel grande volume del guardaroba, gli elementi a ponte creano dei vani che accolgono il letto, le mensole parziali e la zona scrittoio attrezzata.

*Continuous corner hinged wardrobe with Beta recessed handles and overhead units with overlapping opening. Within the wardrobe space, the overhead units create compartments that accommodate the bed, partial shelves and desk area.*



Armadio battente Tratto e Ponte pensile in continuità, nel vano sottostante si inserisce la Boiserie ad angolo con testiera attrezzata Ecletto con contenitori Domino.

*Tratto hinged wardrobe and hanging overhead unit continuously flow into a corner Boiserie featuring the Ecletto equipped headboard and Domino storage units below.*



Armadio battente con Ponte pensile in continuità e modulo sottopensile con vani a giorno laterali. Boiserie Domino a doppio spessore con zona scrittoio integrata ed illuminazione a led, letto Sommier Ecletto per rete da 1200 x 2000 mm.

*Hinged wardrobe with continuous hanging overhead unit and under wall unit module with open side compartments. Double-thickness Domino Boiserie with integrated desk area and LED lighting, Sommier Ecletto bed for 1200 x 2000 mm bed base.*



# Teche a giorno

## Open display cases

Si aprono nuove possibilità d'uso dell'armadio, ricavando fra le ante e i cassetti dei vani a giorno di diverse dimensioni. Teche versatili che si possono utilizzare per mettere in mostra degli oggetti cari o preziosi, oppure creare una libreria o dei vani di servizio. Nell'immagine, armadio battente bifacciale con pannelli retro di finitura in Ecovintage con la stessa finitura di ante e fianchi e Teca con vano libreria.

*New possibilities of wardrobe use are introduced by creating open compartments of various sizes between doors and drawers. Versatile display units can be used to showcase cherished objects, create a bookcase or form storage compartments. The image shows a double-sided hinged wardrobe with Ecovintage finish panels on the back with matching finish on the doors and drawers and a Teca cabinet bookcase.*



Armadio battente composto da moduli stagionali e da ante con pomolo, Teca a giorno con ripiani a telaio con luci al led e basi Collage dotate di cassetti.

*Hinged wardrobe consisting of seasonal modules and doors with knobs, Teca open display unit with framed shelves equipped with LED lighting and Collage base units fitted with drawers.*



Esempi di componibilità: massima flessibilità e ampia scelta di finiture  
/ Examples of modularity: maximum flexibility and a wide choice of finishes

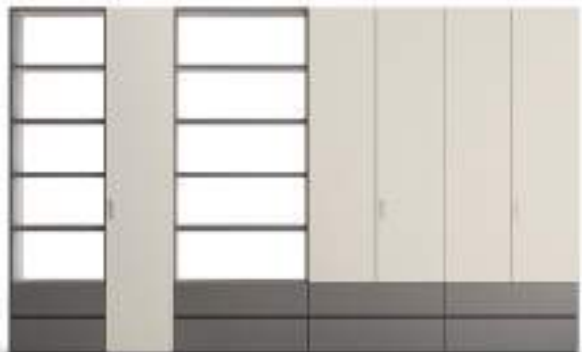

Armadio battente bifacciale con Teca passante completamente autoportante e terminale giorno laterale  
/ Double-sided hinged wardrobe with self-supported Teca cabinet and open-ended side panel



# Collage

## Basi a cassetti / Base units with drawer

### Modularità in altezza / Height modularity

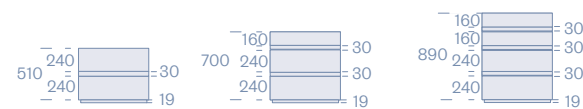

### Modularità in larghezza e profondità / Depth and width modularity



## Moduli Odeon con pannello porta TV, abbinato ad ante battenti o scorrevoli Odeon modules with TV panel, combined with hinged or sliding doors

### Modularità in altezza (cassetti con maniglia centrale e con profilo "collage") / Height modularity (drawers with central handle and with "collage" profile)

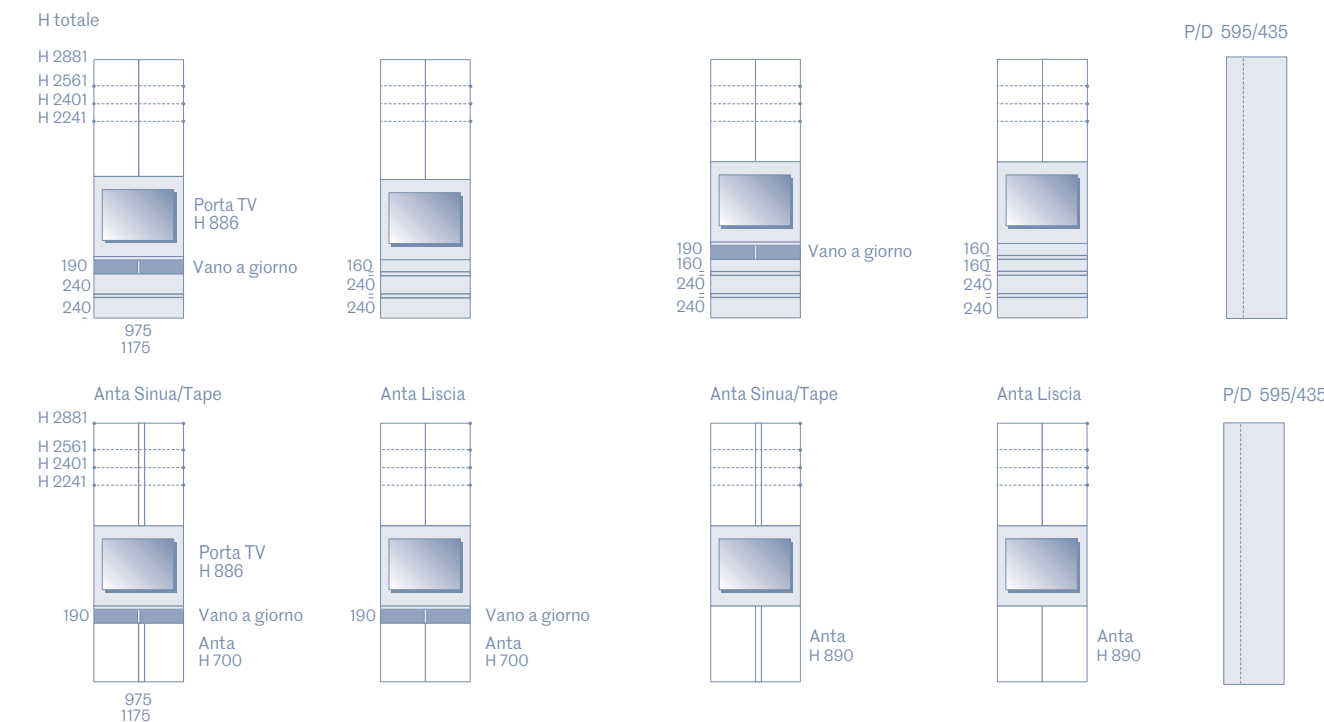

## Basi con ante / Base units with doors

### Modularità in altezza / Height modularity

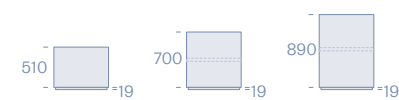
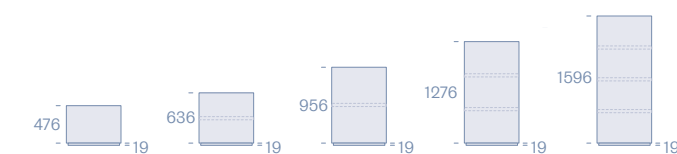

### Modularità in larghezza e profondità / Depth and width modularity

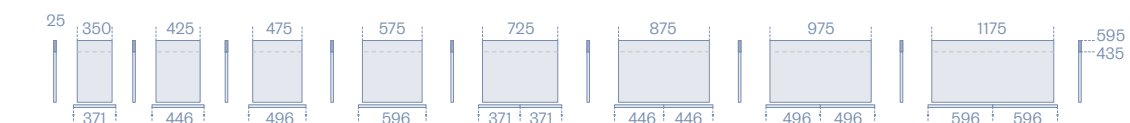

I moduli Collage sono caratterizzati dalla combinazione di ante con cassetti. Le ante possono essere singole o in coppia nelle tipologie con anta Liscia, Breccia, Tape o Sinua. Anche i cassetti, abbinati alle ante singole o in coppia, prevedono due tipologie di apertura, con profilo "Collage" o con maniglia centrale. Ogni modulo è fornito, di serie, di un ripiano con profondità maggiorata a filo davanti, sul quale i frontali vanno a chiudere.

Collage modules feature a combination of doors and drawers. The doors can be single or double in the Liscia, Breccia, Tape or Sinua models. The drawers, combined with single or double doors, also come in two opening types, with a 'Collage' profile or with a central handle. Each module comes standard with an extra-deep shelf at the front, which the fronts close onto.

### Modularità armadio con cassetti esterni collage / Collage wardrobe modularity with external drawers

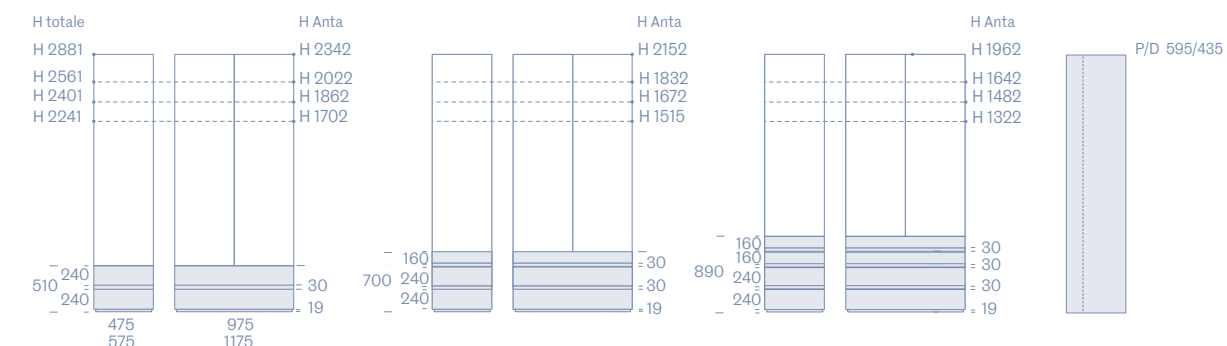

# Teche

Gli elementi Teca sono moduli composti caratterizzati dalla presenza di un vano a giorno in associazione a parti chiuse rappresentate dalle basi Collage con ante o cassetto e dai moduli a ponte sospesi. I vani a giorno possono essere allestiti con ripiani di varie tipologie, tubi appendiabiti e delimitati da schienali disponibili in tutte le finiture. Le configurazioni e le misure che si generano sono molteplici quanto gli utilizzi che se ne possono fare. A seguire una esemplificazione di misure e conformazioni ottenibili.

*Teca elements are composed modules characterised by an open compartment combined with closed sections represented by Collage base units with doors or drawers and suspended overhead modules. The open compartments can be fitted with various types of shelves and clothes hanging rails and are delimited by back panels available in all finishes. Below configurations and sizes.*

H armadio

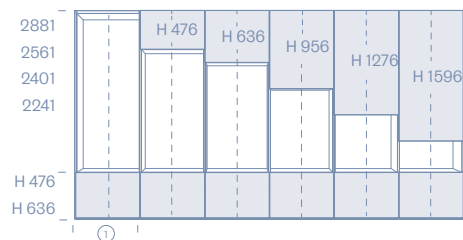

① Moduli L/W 350/725 / Units L/W 425/875 L/W 475/975 L/W 575/1175

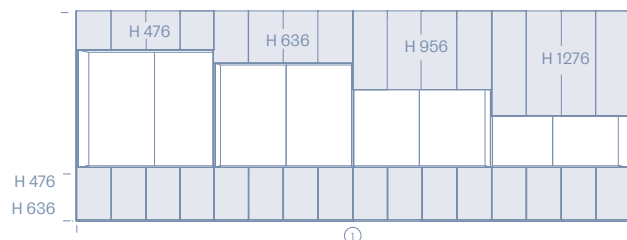

① Moduli L/W 1325/1475/1775/1975 / Units /2075/2175/2375

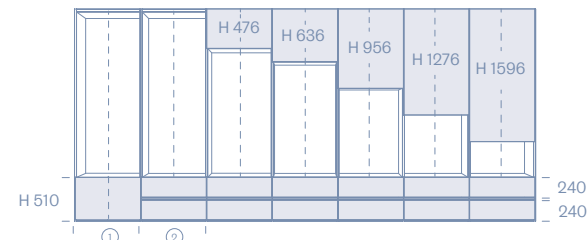

① Moduli L/W 350/725 / Units L/W 425/875 L/W 475/975 L/W 575/1175 ② Moduli cassetti / Drawer units L/W 475/975 L/W 575/1175

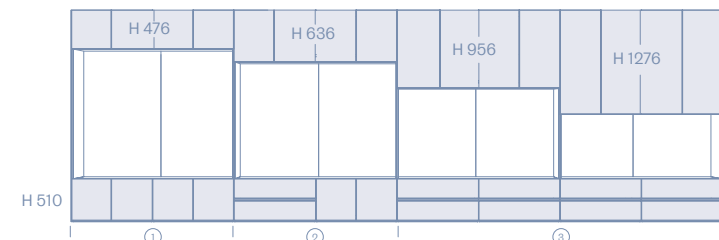

① Moduli / Units 1325/1475/1775/1975 /2075/2175/2375 ② Moduli cassetti e ante / Drawer and door units L/W 1475/1775/1975 /2075/2175/2375 ③ Moduli cassetti / Drawer units L/W 1975/2375

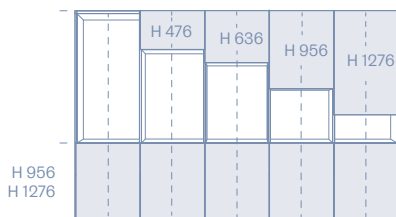

① Moduli L/W 350/725 / Units L/W 425/875 L/W 475/975 L/W 575/1175

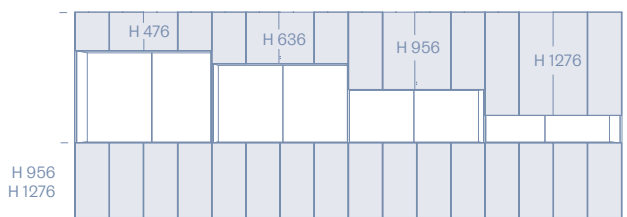

① Moduli L/W 1325/1475/1775/1975 / Units /2075/2175/2375

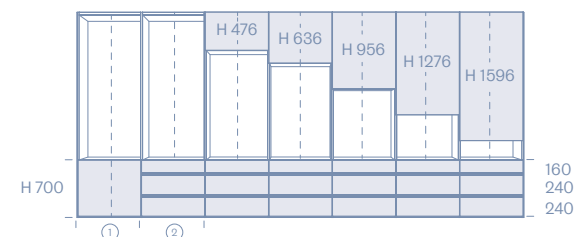

① Moduli L/W 350/725 / Units L/W 425/875 L/W 475/975 L/W 575/1175 ② Moduli cassetti / Drawer units L/W 475/975 L/W 575/1175

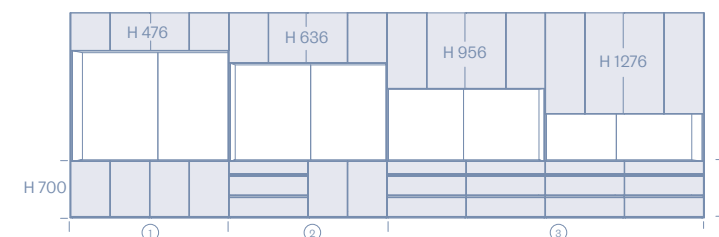

① Moduli / Units 1325/1475/1775/1975 /2075/2175/2375 ② Moduli cassetti e ante / Drawer and door units L/W 1475/1775/1975 /2075/2175/2375 ③ Moduli cassetti / Drawer units L/W 1975/2375

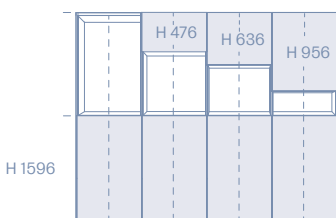

① Moduli L/W 350/725 / Units L/W 425/875 L/W 475/975 L/W 575/1175

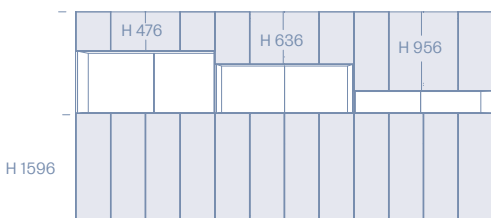

① Moduli L/W 1325/1475/1775/1975 / Units /2075/2175/2375

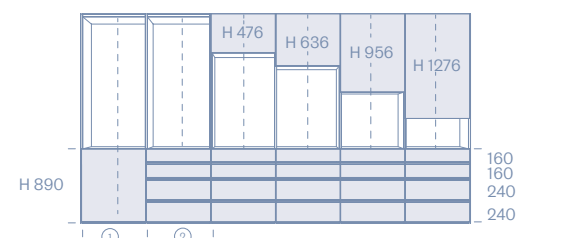

① Moduli L/W 350/725 / Units L/W 425/875 L/W 475/975 L/W 575/1175 ② Moduli cassetti / Drawer units L/W 475/975 L/W 575/1175

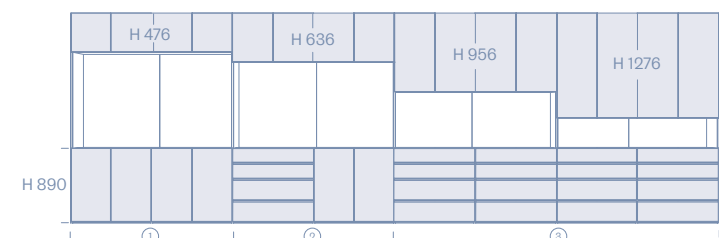

① Moduli / Units 1325/1475/1775/1975 /2075/2175/2375 ② Moduli cassetti e ante / Drawer and door units L/W 1475/1775/1975 /2075/2175/2375 ③ Moduli cassetti / Drawer units L/W 1975/2375

Stagionale battente / Seasonal wardrobe with hinged door

I moduli stagionali con anta divisa in altezza vengono forniti con un ripiano con profondità maggiorata a filo davanti, sul quale le ante divise vanno a chiudere.

Seasonal modules with vertically divided doors are supplied with an extra-deep shelf at the front, onto which the divided doors close.

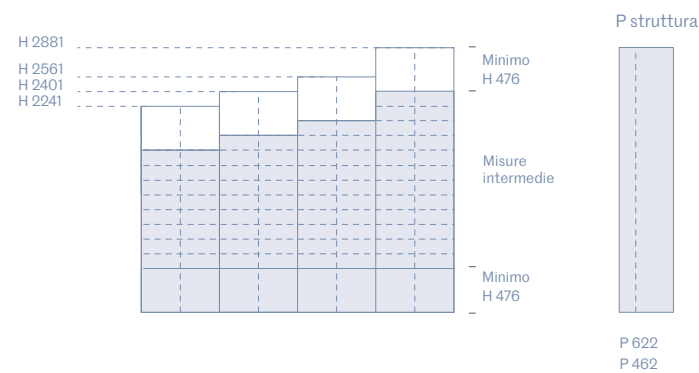

FINITURA ANTA / DOORS FINISH

Materico  
Laccato opaco / Metallo  
Impiallacciato

APERTURE / OPENING SYSTEMS  
LISCIA CON PUSH-PULL

LISCIA CON MANIGLIA / WITH HANDLE

Assisa Mini H120  
Ala Mini H 120  
Trail Mini H 75  
Pomolo  
Finitura: Laccato opaco / Metallo

SINUA – TAPE

Finitura profilo: Laccato opaco / Metallo

Larghezze modulari / Modular widths



Ponte battente / Overhead unit with hinged door

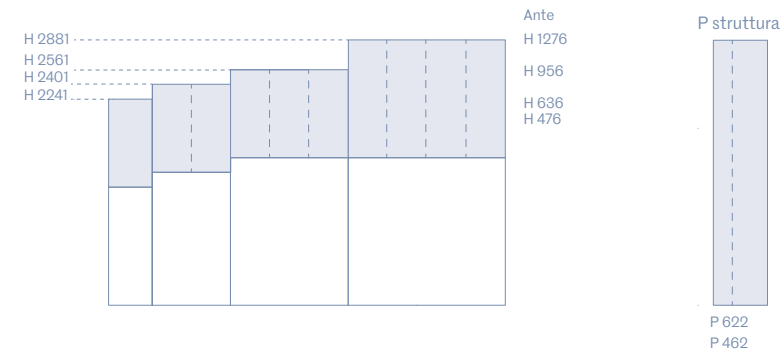

FINITURA ANTA / DOORS FINISH

Materico  
Laccato opaco / Metallo  
Impiallacciato

APERTURE / OPENING SYSTEMS  
LISCIA CON SORMONTO / OVERLAP

LISCIA CON MANIGLIA / WITH HANDLE

Assisa Mini H120  
Ala Mini H 120  
Trail Mini H 75  
Pomolo  
Finitura: Laccato opaco / Metallo

SINUA – TAPE

Finitura profilo: Laccato opaco / Metallo

larghezze modulari ponti singoli / modular widths for single overhead units



Larghezze modulari ponti composti / Modular widths for composed overhead units

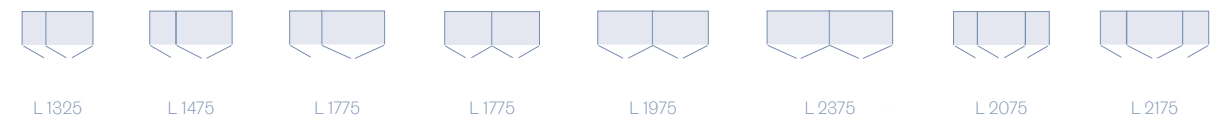

Sopralzo battente / Top element with hinged door

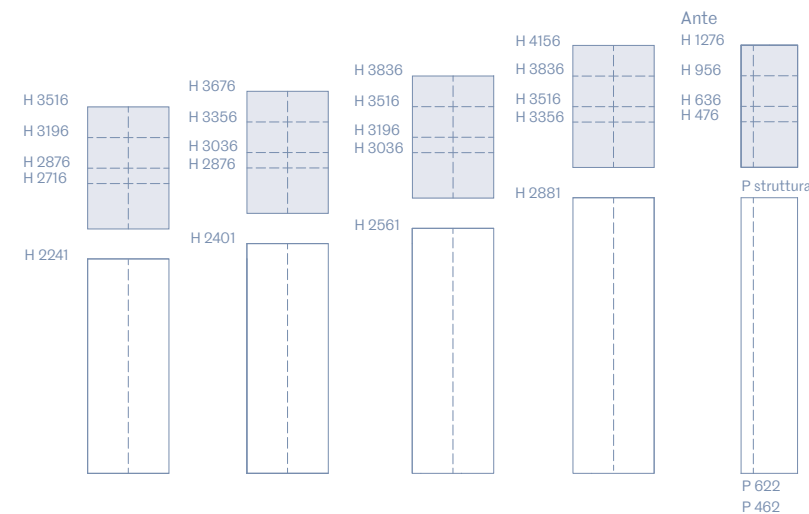

FINITURA ANTA / DOORS FINISH

Materico  
Laccato opaco / Metallo  
Impiallacciato

APERTURE / OPENING SYSTEMS  
LISCIA CON PUSH-PULL

LISCIA CON MANIGLIA / WITH HANDLE

Assisa Mini H120  
Ala Mini H 120  
Trail Mini H 75  
Pomolo  
Finitura: Laccato opaco / Metallo

SINUA – TAPE

Finitura profilo: Laccato opaco / Metallo

Larghezze modulari / Modular widths



Angoli / Corners

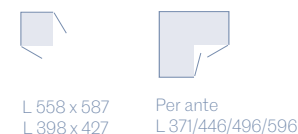

Ponte battente pensile / Wall-mounted overhead unit with hinged door

IN AFFIANCAMENTO ARMADIO / NEXT TO A WARDROBE

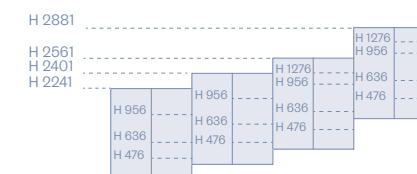

COMPLETAMENTE PENSILE / COMPLETELY HANGING

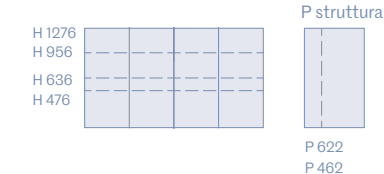

FINITURA ANTA / DOORS FINISH

Materico  
Laccato opaco / Metallo  
Impiallacciato

APERTURE / OPENING SYSTEMS  
LISCIA CON SORMONTO / OVERLAP

LISCIA CON MANIGLIA / WITH HANDLE

Assisa Mini H120  
Ala Mini H 120  
Trail Mini H 75  
Pomolo  
Finitura: Laccato opaco / Metallo

SINUA – TAPE

Finitura profilo: Laccato opaco / Metallo

Larghezze modulari / Modular widths



# Armadio con Boiserie

## Wardrobe with Boiserie

In questa immagine e in quella seguente, la Boiserie Domino con installazione a parete rappresenta un elemento di continuità tra gli armadi, con i quali condivide l'altezza totale. Permette di progettare una zona home office all'interno della zona notte.

*In this and the previous image the Domino Boiserie creates same-height continuity between the wardrobes, allowing for home office concept within the bedroom.*



Fissate ai fianchi degli armadi, le boiserie autoportanti Domino sono composte da pannelli modulari a doppio spessore alternati a cassettiere Domino e mensole: il tutto può essere completato da specchi modulari e da un coperchio di collegamento.

*Attached to the sides of the wardrobes, Domino self-supporting boiserie consists of double-thickness modular panels alternating with Domino drawer units and shelves: it can be completed with modular mirrors and a connecting top panel.*





Esempio di Boiserie autoportanti Domino con zona dedicata al maquillage e specchio modulare dotato di illuminazione a led integrata. Nel dettaglio, vediamo le mensole Domino con vassoio, dotate di funzionale cassetto per cosmetici e accessori. Ante Trail cannettate con gola.

*Example of Domino self-supporting boiserie with a dedicated beauty area and modular mirror with integrated LED lighting. In the detail image, we see the Domino shelves with tray, equipped with a functional drawer for cosmetics and accessories. Cannettato Trail doors with grip profile.*



Armadio battente di profondità 462 mm con ante Ala in vetro satinato. In continuità, la Boiserie Domino ad angolo aperto crea un trait d'union tra l'armadio e l'architettura della casa. Scrivania con piano sagomato Domino con gamba Plinio.

*Hinged wardrobe D 462 mm with Ala satin-finish glass doors. The Domino open corner Boiserie creates a continuous line between the wardrobe and the architecture of the home. Desk with shaped Domino top and Plinio legs.*



















# Ante per Armadio













Legenda / Legend:

 Scorrevole  
Sliding
  Battente  
Hinged
  Complanare  
Coplanar





## Ante per Armadio / Doors for wardrobes

	Grace	100
	Vela	104
	Trail	106
	Tape	110
 	Breccia	112
 	Ala	114
  	Sinua	118
 	Tratto	120
  	Eco	124

## Maniglie per anta Liscia / Handles for smooth door

	Plana	126
	Pomolo	128
 	Wood	130
 	Assisa	132
 	Mia	134
  	Beta	136
  	Deluxe	138

## Ante Maxi / Oversized doors

 	Horizontal	140
 	Sintesi	146
	Meridian	150

## Accessori / Accessories

162

### Wardrobe doors

Le ante sono l'elemento più caratterizzante dell'armadio: maniglie, profili, finiture e lavorazioni determinano la personalità di ogni composizione. Le pagine seguenti offrono un riepilogo delle varie tipologie di ante proposte dal Sistema Armadio: dalle più essenziali alle più ricercate, con cornice perimetrale che funge da presa, oppure con maniglie a incasso che non occupano spazio o sporgenti per una caratterizzazione più pronunciata. Molteplici anche le finiture, per intonarsi a ogni gusto e stile d'interni: laccate, impiallacciate, materiche, in ecopelle, con vetri laccati o specchi. Le ante con apertura battente, scorrevole e complanare possono inoltre essere abbinata a cassetti a vista, vani a giorno o elementi porta TV, per arricchire l'armadio di funzioni e possibilità.

The doors are the most distinctive feature of a wardrobe: handles, profiles, finishes and workmanship determine the personality of each composition. The following pages offer a summary of the various types of doors offered by Wardrobe System: from the most basic to the most sophisticated, with a perimeter frame that acts as a handle, or with recessed handles that do not occupy space or protrude. Available in a wide range of finishes to suit every taste and interior style: lacquered, veneered, textured, eco-leather, with lacquered glass or mirrors. Sliding and coplanar hinged doors can also be combined with open drawers, open compartments or TV units to enhance the wardrobe's functionality and possibilities.



# Grace

Aperture disponibili  
/ Available opening system:



Anta con incavo *Handle with recessed grip*

Lineare e funzionale, l'anta battente Grace è caratterizzata da una presa incavata nello spessore, accuratamente disegnata nella forma e studiata nell'ergonomia: a seconda delle esigenze estetiche e pratiche, può essere singola o doppia.

*Linear and functional, the Grace hinged door features a recessed handle, carefully designed in terms of shape and ergonomics; available as single or double, depending on aesthetic and practical requirements.*





# Vela

Anta con incavo *Handle with recessed grip*

Aperture disponibili  
/ Available opening system:



Ricavata direttamente nel pannello, la maniglia dell'anta Vela crea un piacevole effetto visivo e un morbido gioco di ombre. È possibile scegliere fra due soluzioni, con risultati estetici diversi: coppie di ante con maniglia singola a destra, oppure con maniglie a destra e sinistra.

*Carved directly into the panel, the Vela door handle creates a subtle visual effect using a soft play of shadows. You can choose between two solutions for different aesthetic results: pairs of doors with a single handle on the right, or with handles on both the right and left.*



# Trail

Anta cannettata. *Fluted door*

Aperture disponibili  
/ Available opening system:



Il guardaroba con ante Trail è caratterizzato dalla lavorazione a cannettatura, proposta nei colori laccati o metallici. Disponibile con la maniglia dedicata, incassata parzialmente nell'anta, mostrata nei particolari qui a fianco, oppure con profilo a gola Tape, come nell'immagine seguente.

*The Trail wardrobe doors feature a fluted reed finish, proposed in lacquered or metallic colours. Available with a dedicated handle, partially recessed into the door, shown in detail here; or with a Tape grip profile, as shown in the following image.*





# Tape

Anta con profilo di apertura. *Door with recessed profile*

Aperture disponibili  
/ Available opening system:



Il profilo di apertura verticale dell'anta Tape ha la stessa forma delle prese a gola orizzontali dei cassetti esterni Collage e delle cassettiere interne dell'armadio Tipo B.

Questo crea una perfetta coerenza formale nel dinamico gioco di linee e volumi, vuoti e pieni di questa composizione, nel quale ante con vani a giorno sono abbinata ai cassetti a vista della cabina armadio Bellavista.

*The vertical profile opening of the Tape door has the same shape as the horizontal profile grip on the Collage external drawers and the internal drawer units of the Type B wardrobe.*

*This creates perfect formal consistency in the dynamic interplay of lines and depths, empty and full spaces in this composition, of which doors with open compartments are combined with the visible drawers of the Bellavista walk-in closet.*



# Breccia

Aperture disponibili  
/ Available opening system:



Anta con profilo di apertura. *Door with recessed profile*

L'armadio Breccia rivisita la classica anta liscia: la maniglia scompare alla vista, integrandosi nello spessore grazie a un'insenatura ergonomica in metallo, con una speciale zigrinatura che facilita la presa.

*The Breccia wardrobe revisits the classic smooth door: the handle integrates into the thickness thanks to an ergonomic metal recess with a special moulding that facilitates grip.*



## Ala

Aperture disponibili  
/ Available opening system:



Anta con maniglia esterna *Door with external handle*

L'armadio con ante Ala è caratterizzato dal segno grafico della maniglia, realizzata in metallo verniciato e proposta in versione singola o doppia. La maniglia è disponibile a tutta altezza come nell'immagine, oppure alta 1100 mm o in versione Central 240 mm o Mini 120 mm.

*The wardrobe with Ala doors is characterised by the graphic design of the handle, made of painted metal and available in single or double versions. The handle is available in full height as shown in the image, or 1100 mm high, or in Central 240 mm or Mini 120 mm versions.*





# Sinua

Anta con profilo di apertura. *Door with recessed profile*

Aperture disponibili  
/ Available opening system:



L'armadio Sinua è caratterizzato da un profilo tecnico verticale a gola che facilita l'apertura delle ante. In queste immagini, viene presentato nella configurazione angolare con ante battenti che lo trasforma in un elemento d'interni. La finitura bifacciale consente infatti il suo utilizzo come un divisorio all'interno di spazi open space, garantendo un'estetica perfetta su entrambi i lati.

*The Sinua wardrobe features a vertical grip profile that makes it easy to open the doors. In these images, it is featured as a corner configuration with hinged doors, transforming it into an interior design element. The double-sided finish allows it to be used as a partition in open spaces, ensuring a perfect aesthetic on both sides.*



# Tratto

Aperture disponibili  
/ Available opening system:



Anta con maniglia a incasso parziale *Door with semi-recessed handle*

L'anta Tratto è caratterizzata da una maniglia a incasso parziale in legno massello tinto o laccato. Molteplici sono i giochi di colori e abbinamenti fra l'anta, la maniglia e il fondo della fascia, con finiture in contrasto o tono su tono. In questa immagine, vediamo la versione con l'illuminazione led integrata nel profilo verticale della maniglia. Il letto Abbraccio, con testiera imbottita e cuscini reclinabili, è abbinato ai contenitori notte Cabaret Glass.

*The Tratto door features a partially recessed handle in stained or lacquered solid wood. There are many colour combinations available for the door, the handle and the bottom of the band, with contrasting or tone-on-tone finishes. This image shows Tratto doors with LED lighting integrated into the vertical profile of the handle. The Abbraccio bed, with padded headboard and reclining cushions is combined with Cabaret Glass night storage units.*



Armadio scorrevole Tratto con maniglie in tono con le ante. Cabina Armadio Panorama con cassettiere Atollo  
/ *Tratto sliding wardrobe with matching door handles. Panorama walk-in closet with Atollo drawers*



## Eco

Anta in ecopelle *Eco-leather door*

Aperture disponibili  
/ Available opening system:



Le ante Eco sono rivestite esternamente in ecopelle, con cuciture a contrasto o in tinta che ne definiscono i contorni. Vengono ulteriormente impreziosite dalle eleganti maniglie a incasso Deluxe. Rivestimento e confezione sono disponibili anche per i fianchi a vista dell'armadio.

*Eco doors are covered externally in eco-leather, with contrasting or matching stitching that defines their contours. They are further embellished by elegant Deluxe recessed handles. Cover and trim are also available for the visible sides of the wardrobe.*



# Plana

Maniglia esterna per anta Liscia. *External handle for Liscia door*

Aperture disponibili  
/ Available opening system:



L'armadio battente con anta Liscia è caratterizzato dalla maniglia Plana, simile a un segno grafico orizzontale o verticale. Disponibile singola o doppia, Plana offre un'impugnatura ergonomica ed è realizzata in metallo laccato opaco o con finitura metallo. La Cabina Armadio Panorama con specchio parziale, inserita tra i due volumi dell'armadio, ne riprende le finiture.

*The hinged wardrobe with smooth doors features the Plana handle, similar to a horizontal or vertical graphic mark. Available in single or double versions, Plana offers an ergonomic grip and is made of matt lacquered metal or with a metal finish. The Panorama walk-in closet with partial mirror, inserted between the two depths of the wardrobe, echoes its finishes.*



# Pomolo

Per anta Liscia / For Liscia door

Aperture disponibili  
/ Available opening system:



L'armadio battente con anta Liscia è caratterizzato da un disegno essenziale e funzionale, con il Pomolo in acciaio tornito che rappresenta un prezioso elemento minimalista. Nell'immagine, l'armadio battente realizzato su misura, con Pomolo in tinta con le ante e con la Cabina Panorama Free inserita nell'ambiente.

*The hinged wardrobe with smooth doors features a simple, functional design, with a round steel knob that adds a precious minimalist touch. The image shows a custom-made hinged wardrobe with knobs matching the doors and a Panorama Free walk-in closet integrated into the room.*



# Wood

Aperture disponibili  
/ Available opening system:



Maniglia esterna per anta Liscia. *External handle for Liscia door*

L'armadio con anta Liscia, in tipologia battente o scorrevole, è caratterizzato dalla maniglia Wood scorrevole, è caratterizzato dalla maniglia Wood con particolare sagomatura. Realizzata in legno tinto, ha una calda presenza materica, ripresa anche nella finitura della cassettera Valeo.

*The wardrobe with smooth doors, either hinged or sliding, features a particular shaped Wood handle. Made of stained wood, it has a warm, textured appearance, which is also reflected in the finish of the Valeo drawer unit.*



# Assisa

Aperture disponibili  
/ Available opening system:



Maniglia esterna per anta Liscia. *External handle for Liscia door*

L'anta Liscia è qui abbinata alla maniglia Assisa, realizzata in metallo come segno verticale, è disponibile in varie finiture della gamma dei laccati opachi e metallo, disponibile per anta battente o scorrevole con altezza 1218 mm, 240 mm e 120 mm.

*The Liscia door is combined here with the Assisa handle, made of metal as a vertical feature. Available in various finishes from the range of matt lacquers and metals. Available for hinged or sliding doors with heights of 1218 mm, 240 mm and 120 mm.*



## Mia

Maniglia esterna per anta Liscia *External handle for Liscia door*

Aperture disponibili  
/ Available opening system:



L'anta Liscia è un pannello assolutamente essenziale, impreziosito in questo caso dalla maniglia metallica Mia con altezza 300 mm o 600 mm. Le ante sono disponibili nella tipologia battente e scorrevole, in un'ampia modularità di dimensioni.

*The Liscia door is an absolutely essential panel, embellished in this case by the Mia metal handle with a height of 300 mm or 600 mm. The doors are available in hinged and sliding versions, in a wide range of sizes.*



# Beta

Aperture disponibili  
/ Available opening system:



Maniglia incassata per anta Liscia *Recessed handle for Liscia door*

L'anta Liscia è abbinata alla maniglia a incasso Beta, con un effetto di piacevole pulizia formale e funzionale, per abbinamenti con finiture in contrasto o tono su tono.

*The Liscia door is combined with the Beta recessed handle, creating a clean and functional effect, for combinations with contrasting or tone-on-tone finishes.*



# Deluxe

Maniglia incassata per anta Liscia. *Recessed handle for Liscia door*

Aperture disponibili  
/ Available opening system:



Caratterizzata da pregevoli venature orizzontali, l'anta Liscia in finitura Rovere Carbone è ulteriormente impreziosita dalla maniglia Deluxe, realizzata con una vaschetta in metallo a incasso, completata da una presa rivestita in Ecopelle o Ecovintage che la rende raffinata alla vista e piacevole al tatto. Il letto Aliante 1.0 è abbinato al tavolino Lotus.

*Characterised by horizontal grain, the Liscia door in Carbone Oak finish is further embellished by the Deluxe handle, made with a recessed metal tray, completed by a grip covered in Eco-leather or Ecovintage, pleasing both to the eye and to the touch. The Aliante 1.0 bed is combined with the Lotus side table.*



# Horizontal

Aperture disponibili  
/ Available opening system:



Anta a telaio con gola orizzontale *Framed door with horizontal recessed grip*

L'anta Horizontal è caratterizzata dalla gola che la attraversa orizzontalmente in larghezza, fungendo da presa per l'apertura. La finitura può essere in contrasto per creare un effetto grafico deciso, oppure in tinta per chi preferisce una totale pulizia formale.

*The Horizontal door is characterised by a grip profile that runs horizontally across its width, as a handle for opening. The finish can be contrasting to create a bold graphic effect, or matching for those who prefer a completely clean look.*





Nelle immagini qui sopra, vediamo i dettagli della lavorazione a 45° dell'anta in legno, nella quale sottili pannelli disegnano il perimetro, sporgendo frontalmente rispetto al profilo verticale. Questa unione crea sull'armadio i giochi di ombre caratteristici di alcuni complementi della zona notte, come Domino, Cidori e Abaco. La fascia centrale che funge da maniglia rivela una cura artigianale della realizzazione e può essere in tinta o in contrasto con l'anta.

*In the images above, we can see the details of the bevelled edge processing of the wooden door, in which thin panels protrude out from the vertical profile. This detail creates a shadow effect on the wardrobe, typical of certain bedroom accessories such as Domino, Cidori and Abaco. The central groove that acts as a handle reveals the craftsmanship utilized in its creation. It can be painted in the same colour or contrasting with the door.*



Nell'anta Horizontal in vetro, le lastre sono posate frontalmente a filo del profilo laterale, evidenziando i sottili contorni dell'anta. In queste immagini, l'armadio scorrevole con ante in vetro laccato satinato, maniglia e profili in tinta.

*In the Horizontal glass door, the panels are positioned flush with the side profile, highlighting the slim contours of the door. In these images, the sliding wardrobe features satin-lacquered glass doors, handles and profiles in the same colour.*



# Sintesi

Anta con profilo di apertura. *Door with recessed profile*

Aperture disponibili  
/ Available opening system:



Un sistema di ante in varie misure e con molteplici finiture: dal materico, al laccato opaco, vetro o specchio, per armadi con ante scorrevoli e coplanari. Le diverse finiture si alternano in uno slancio verticale ritmato dal profilo a tutta altezza. La realizzazione con pannelli smontabili permette un facile trasporto. In questa immagine: armadio con due vani da 1475 mm, ante composte da pannelli di larghezza 920 mm. Maniglie centrali per apertura coplanare.

*A system of doors in various sizes and with multiple finishes: from textured to matt lacquered, glass or mirror, for wardrobes with sliding and coplanar doors. The different finishes alternate in a vertical rhythm punctuated by the full-height profile. The removable panels make it easy to transport. In this image: wardrobe with two 1475 mm compartments, doors composed of 920 mm wide panels. Central handles for coplanar opening.*



L'ampio vano interno è suddiviso in due aree, per una perfetta organizzazione dello spazio: da un lato l'appendiabiti, a fianco le cassettiere a terra o sospese, con una serie di ripiani per ogni esigenza di contenimento.

*The spacious interior is divided into two sections for perfect organisation of space: on one side is the clothes rail; the other side, floor-standing or wall-mounted drawer units with a series of shelves for all your storage needs.*



# Meridian

Anta a telaio con presa verticale *Glass door with vertical grip*

Aperture disponibili  
/ Available opening system:



Le ante scorrevoli Meridian giocano con varianti di finitura, oppure con l'eleganza dei laccati opachi in tinta. Le fasce scandiscono le superfici piatte dei pannelli, invitando a sperimentare accostamenti e combinazioni. Dettagli di pregio sono le maniglie a incasso, in posizione mediana, ricavate in continuità con il profilo strutturale. Il fondino può essere con la stessa finitura dell'anta laccata, oppure in contrasto con finitura in legno.

*Meridian sliding doors play with different finishes or with the elegance of matching matt lacquers. The central horizontal grooves punctuate the flat surfaces of the panels, inviting you to experiment with combinations. The recessed handles, positioned in the middle and carved out of the structural profile, add a sophisticated detail. The groove panel can have the same finish as the lacquered door or contrast with a wood finish.*



Armadio scorrevole Meridian laccato opaco con fascia centrale impiallacciata. Letto Folio in abbinamento a comodini Cabaret Glass  
/ Meridian sliding wardrobe in matt lacquer with veneered central panel. Folio bed combined with Cabaret Glass bedside tables





## Tape

### FINITURA ANTA / DOOR FINISH

Materico  
Laccato opaco / lucido / Metallo  
Impiallacciato  
Vetro laccato Lucido / Satinato  
Specchio Dark / Argento / Stopsol  
Ecopelle / Ecovintage

### FINITURA PROFILO / PROFILE FINISH

Laccato opaco / Metallo

#### Sezione / Section

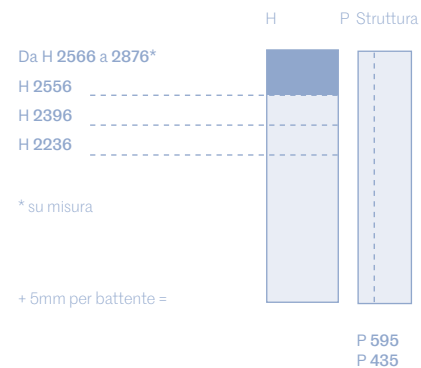

#### Battente / Hinged



#### Angoli / Corners



## Breccia

### FINITURA ANTA / DOOR FINISH

Materico  
Laccato opaco / lucido / Metallo  
Impiallacciato  
Vetro laccato Lucido / Satinato  
Specchio Dark / Argento / Stopsol  
Ecopelle / Ecovintage

### FINITURA PROFILO / PROFILE FINISH

Laccato opaco / Metallo

#### Sezione / Section

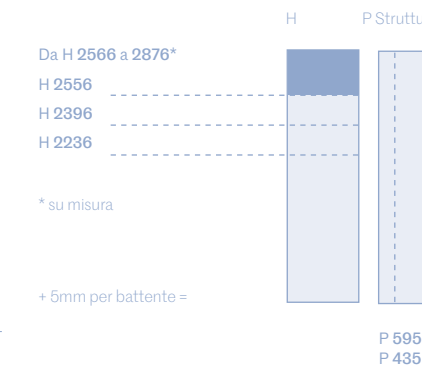

#### Battente / Hinged

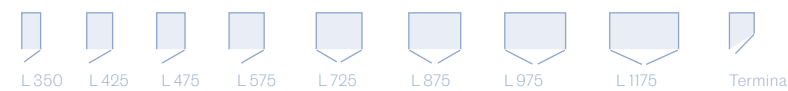

#### Angoli / Corners



#### Scorrevole / Sliding

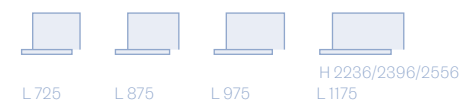

#### Angolo / Corner



## Sinua

### FINITURA ANTA / DOOR FINISH

Materico  
Laccato opaco / lucido / Metallo  
Impiallacciato  
Vetro laccato Lucido / Satinato  
Specchio Dark / Argento / Stopsol  
Ecopelle / Ecovintage

### FINITURA PROFILO / PROFILE FINISH

Laccato opaco / Metallo

#### Sezione / Section

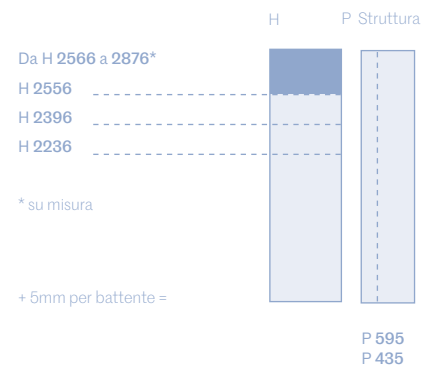

#### Battente / Hinged

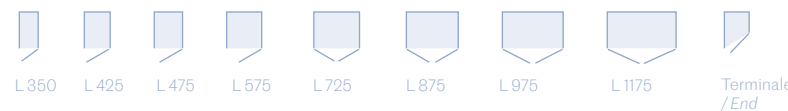

#### Angoli / Corners



#### Scorrevole / Sliding



#### Complanare / Coplanar



## Tratto

### FINITURA ANTA / DOOR FINISH

Materico  
Laccato opaco / Metallo  
Impiallacciato

### MANIGLIA E FONDO / HANDLE AND BOTTOM FINISH

Laccato opaco / Metallo  
Impiallacciato

#### Sezione / Section

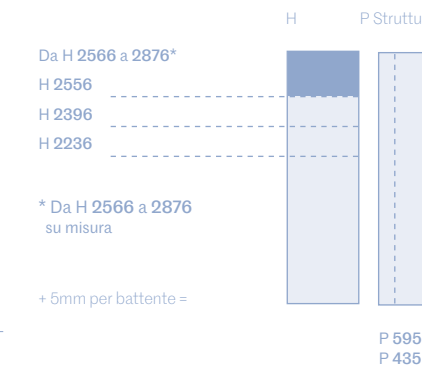
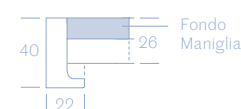

#### Battente / Hinged



#### Angoli / Corners



#### Scorrevole / Sliding

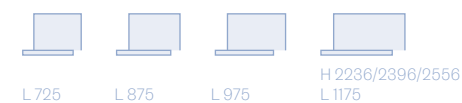

#### Complanare / Coplanar





## Grace

FINITURA ANTA / DOOR FINISH  
Laccato opaco

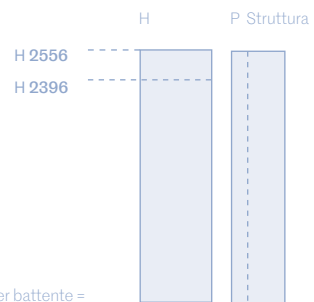

Sezione / Section



P 595  
P 435



## Trail con maniglia

FINITURA ANTA / DOOR FINISH  
Laccato opaco / Metallo

FINITURA MANIGLIA / HANDLE FINISH  
Laccato opaco / Metallo

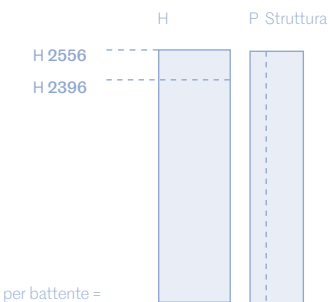

Sezione / Section

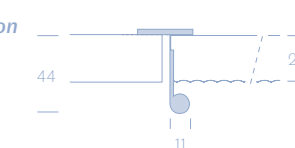

P 595  
P 435

Battente / Hinged

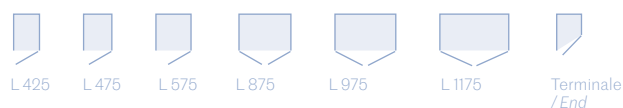

Angoli / Corners



Battente / Hinged

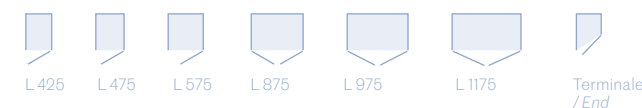

Angoli / Corners



## Vela

FINITURA ANTA / DOOR FINISH  
Laccato opaco

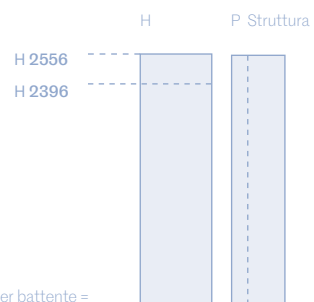

Sezione / Section

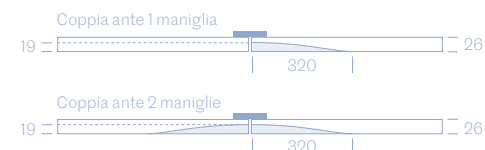

P 595  
P 435



## Trail con gola

FINITURA ANTA / DOOR FINISH  
Laccato opaco / Metallo

FINITURA PROFILO / PROFILE FINISH  
Laccato opaco / Metallo

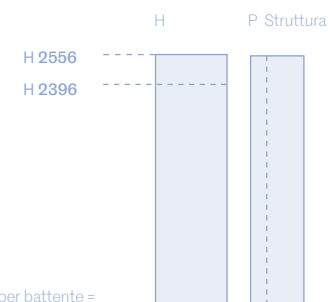

Sezione / Section

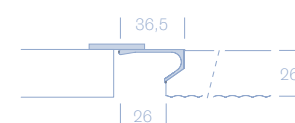

P 595  
P 435

Battente / Hinged

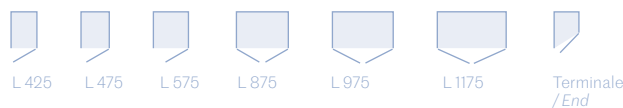

Angoli / Corners



Battente / Hinged



Angoli / Corners

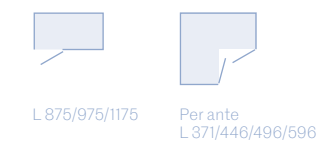



## Liscia

### FINITURA ANTA / DOOR FINISH

Materico  
Laccato opaco / lucido / Metallo  
Impiallacciato

### Sezione / Section

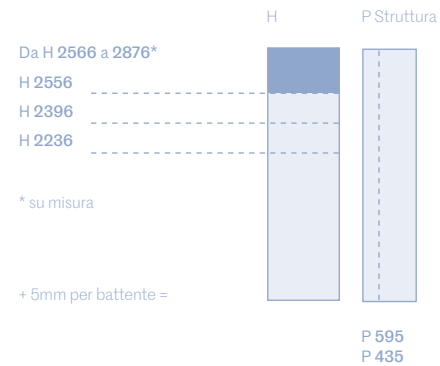

### Battente / Hinged



### Angoli / Corners



### Scorrevole / Sliding

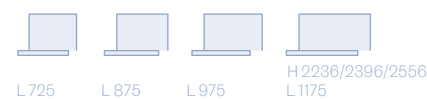

### Angolo / Corner



### Complanare / Coplanar – maniglia Beta, Deluxe



## Maniglie Handles

### ASSISA

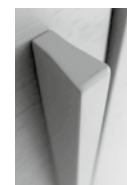

H 120 / 240 / 1218  
FINITURA / FINISH  
Laccato opaco  
Laccato Metallo

### TRAIL



H 75 / 150  
FINITURA / FINISH  
Laccato opaco  
Laccato Metallo

### PRESA



H 166  
FINITURA / FINISH  
Laccato opaco  
Laccato Metallo

### WOOD



H 1218  
FINITURA / FINISH  
Massello Frassino Tinto  
Carbone / Grigio / Avana /  
Argilla / Cuba

### DELUXE



H 160  
FINITURA / FINISH  
Laccato opaco  
Laccato Metallo  
IMPUGNATURA  
/ HANDLE GRIP  
Ecopelle / Ecovintage

### BETA



H 160  
FINITURA / FINISH  
Laccato opaco  
Laccato Metallo

### MIA



H 300 / 600  
FINITURA / FINISH  
Laccato opaco  
Laccato Metallo

### POMOLO



H 21 ø 25  
FINITURA / FINISH  
Laccato opaco  
Laccato Metallo

### PLANA



H 30 x 165  
FINITURA / FINISH  
Laccato opaco  
Laccato Metallo



## Ala

### FINITURA ANTA / DOOR FINISH

Materico  
Laccato opaco / lucido / Metallo  
Impiallacciato

Vetro laccato Lucido / Satinato  
Specchio Dark / Argento / Stopsol

### FINITURA MANIGLIA E PROFILO / HANDLE AND PROFILE FINISH

Laccato opaco / Metallo

### Sezione / Section

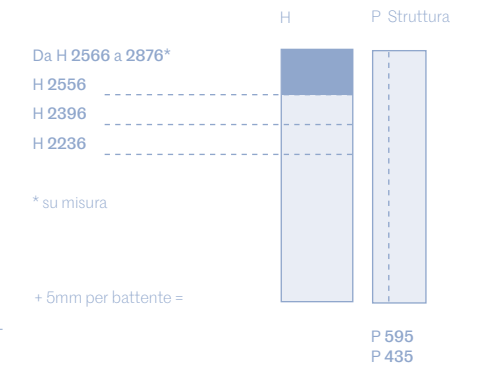

### Battente / Hinged

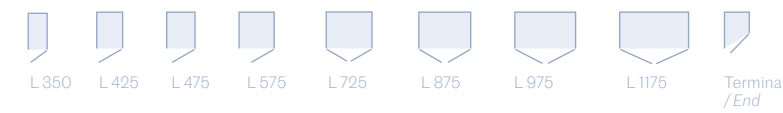

### Angoli / Corners



### Scorrevole / Sliding

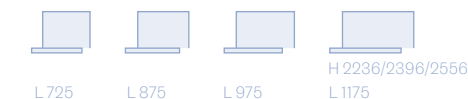

### Angolo / Corner



## Eco

### FINITURA ANTA E IMPUGNATURA / DOOR AND GRIP FINISHES

Ecopelle  
Ecovintage

### FINITURA PROFILO E MANIGLIA / PROFILE AND HANDLE FINISH

Laccato opaco / Metallo

### Sezione / Section

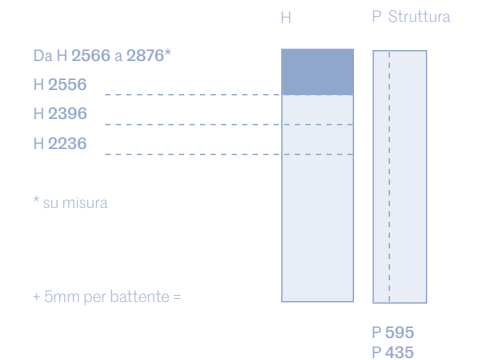

### Battente / Hinged



### Angoli / Corners

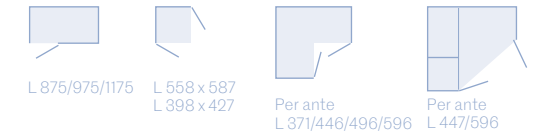

### Scorrevole / Sliding

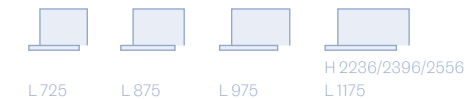

### Angolo / Corner



### Complanare / Coplanar





## Horizontal

### FINITURA ANTA / DOOR FINISH

Materico  
Laccato opaco / Metallo  
Vetro Lucido / Satinato  
Specchio Dark / Argento / Stopsol

### FINITURA GOLA / HANDLE PROFILE FINISH

Impiallacciato / laccato opaco / Metallo

### FINITURA TELAIO / FRAME FINISH

Laccato opaco / Metallo

### Sezione / Section

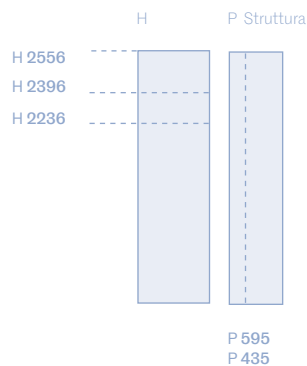
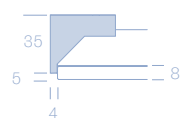

### Scorrevole / Sliding



L 975 | L 1175 | L 1375 | L 1475

### Complanare / Coplanar



L 975 | L 1175 | L 1375 | L 1475



## Sintesi

### FINITURA ANTA / DOOR FINISH

Materico  
Laccato opaco / Metallo  
Vetro laccato Lucido / Satinato  
Specchio Dark / Argento

### FINITURA PROFILO / PROFILE FINISH

Laccato opaco / Metallo

### Sezione / Section

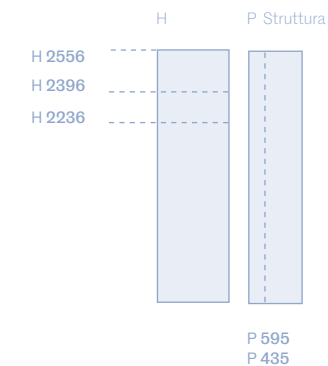

### Scorrevole / Sliding



L 1375 | L 1475

### Complanare / Coplanar



L 1375 | L 1475



## Meridian

### FINITURA ANTA / DOOR FINISH

Materico  
Laccato opaco / Metallo  
Impiallacciato per il fondello della maniglia  
e/o fascia centrale

### Sezione / Section

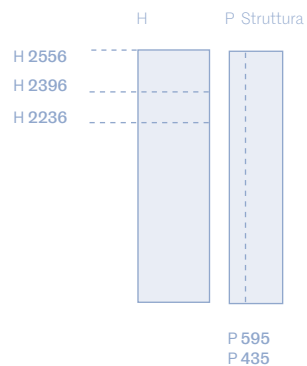
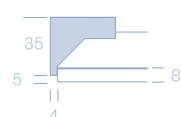

### Scorrevole / Sliding



L 975 | L 1175 | L 1375 | L 1475

# Finiture interne Armadio, Bellavista

## Internal finishes

Sketch Sabbia con schienali rigati  
/ Sketch Sabbia with fluted back panels



Sketch Roccia con schienali rigati  
/ Sketch Roccia with fluted back panels



Sketch Tabacco con schienali rigati  
/ Sketch Tabacco with fluted back panels



Tramato Lino



Laccato Opaco  
/ Matt lacquered



Loto Natura



Loto Tortora



Loto Terra



Econoce



Olmo Medio



Olmo Scuro



## Ripiani interni Internal shelves

Ripiani legno P 510/375 / Wooden shelves D 510/375



## Ripiani estraibili Pull-out trays

Vassoi estraibili P 535 / Pull-out trays D 535



## Portascarpe Shoes shelves

Ripiano portascarpe inclinato con battitacco P 375  
/ Inclined shelf with front trim D 375



Sanificatore (solo per Armadio)  
/ Sanitizer unit (Armadio only)



Ripiani a telaio con vetro P 510/375  
/ Framed glass shelves D 510/375



Vassoi estraibili P 535 con tappetino in ecopelle  
/ Pull-out trays D 535 with eco-leather mat



Ripiano portascarpe inclinato con battitacco P 535  
/ Inclined shelf with front trim D 535



Cassetto Portascarpe H 288 / Shoe drawer



Vassoi estraibili composti P 535 modulare alle cassettiere  
/ Modular pull-out tray D 535 for drawer units



Vassoi estraibili composti P 535 con tappetino in ecopelle  
/ Modular pull-out tray D 535 for drawers with eco-leather mat



Ripiano portascarpe estraibile con battitacco P 535  
/ Pull-out shelf with front trim D 535



## Specchi Mirrors

Specchio estraibile per armadio scorrevole  
/ Pull-out mirror



Specchio fisso per anta battente  
/ Fixed door-mounted mirror



Specchio per fianco armadio  
/ Side-panel mirror



## Illuminazione Lighting

Luci a led verticali sul fianco o divisione  
/ Vertical led lights on side panel



Led su coperchio  
/ LED on top cover



Led su ripiano  
/ LED on shelf



Led su ripiano metallo  
/ LED on metal shelf



# Cassettiere Drawer units

# Accessori per cassetto Drawer accessories

Cassettiere a terra  
/ Freestanding drawer Units



Cassettiere sospese  
/ Suspended drawer units



Cassettiere con raster  
/ Drawer units with raster system



Cassettiere parziali  
/ Partial drawer units



Cassetti con tappetino e separatori  
/ Drawers with mat and partitions



Cassetto con divisori interni  
/ Internal partitions for drawer



Coperchio legno  
/ Wooden top



Coperchio con svuotatasche e separatore  
/ Top with catch-all tray & divider



# Tipologie di cassettiere

## Drawer unit types

Cassetti tipo A con foro di apertura  
/ Type A drawer with opening



Cassetti tipo B con profilo metallo  
/ Type B drawer with metal profile



Cassetti tipo C con frontale vetro  
/ Type C drawer with glass front



Cassetti tipo E con maniglia sporgente  
/ Type E drawer with protruding handle



Portapantaloni  
/ Trousers rack



Top in vetro  
/ Glass top



## Armadio / Bellavista

Cassettiere interne / Internal drawer units  
P/D 535/498 – 375/388 L/W 575/725/875/975/1175

SCocca - FRONTALI / CARCASE - FRONTS  
Materico Tramato Lino / Loto / Sketch  
/ Olmo / Econoce  
Laccato opaco

Tipologia	H 144	H 192	H 288	H 288	H 336	H 384	H 432	H 480	H 480	H 576	H 576	H 576
A B E												
C												
A/C B/C												
Vassoi estraibili / Pull-out trays												
Portapantaloni / Trousers rack												
Coperchio vetro / Glass top panel												
Cassettiere sovrapposte / Overlapped drawer units												
Cassettiere accostate / Side by side drawer units												
L/W 1325												
L/W 1475												

# Raster

## Raster system

Raster H 144  
192 con 2 vani



Raster su ripiano P 375  
/ Raster on shelf D 375



Raster H 144  
192 con 3 vani



Raster su ripiano P 510  
/ Raster on shelf D 510



Raster H 144  
192 con 4 vani



Raster con svuotatasche  
/ Raster with catch-all tray



# Appendiera

## Hanging system

Tubo Appendiabiti  
/ Clothes hanging rail



Perno estraibile  
/ Pull-out peg



Tubo Appendiabiti estraibile P 435  
/ Pull-out clothes rail D 435



Portacinture fisso



Servetto  
/ Servetto valet



Portacinture estraibile



Portacravatte fisso/estraibile



# Cabine Armadio

Bellavista cabina armadio / walk-in closet	34	Atollo isola / island	204
Panorama cabina / walk-in closet	176	Bacheca Atollo isola / island	208
Itala cabina / walk-in closet	200		

La cabina armadio ha un ruolo sempre più centrale nella casa contemporanea: non è solo un contenitore ma uno spazio da vivere, un'espressione del proprio stile, un ambiente scenografico nel quale ogni gesto diventa un rituale intimo, dedicato all'eleganza e alla cura di sé. Sangiacomo propone una scelta di soluzioni che si integrano con il Sistema "Armadio", ampliandone le funzionalità e le possibilità. Bellavista trasforma la cabina armadio in una seducente boutique d'alta moda. Panorama crea una perfetta continuità di finiture e sensazioni nel paesaggio domestico, integrandosi con l'architettura. La cassetiera Atollo è un'isola a centro stanza che unisce fascino e funzionalità, mentre la bacheca Atollo diventa una raffinata esposizione di oggetti preziosi. Itala è invece un sistema di montanti in alluminio sui quali fissare contenitori, ripiani, specchiere e altri accessori, in assoluta libertà.

## Walk-in closet

*The walk-in closet plays an increasingly central role in contemporary homes: it is not just a storage space but a living space, an expression of personal style, a scenographic environment in which every gesture becomes an intimate ritual dedicated to elegance and self-care. Sangiacomo offers a range of solutions that integrate with the Armadio system, expanding its functionality and possibilities. Bellavista transforms the walk-in wardrobe into a seductive high-fashion boutique. Panorama creates perfect continuity of finishes and sensations in the domestic landscape, integrating with the architecture. The Atollo drawer units is an island in the centre of the room that combines charm and functionality, while the Atollo display case becomes a refined display of precious objects. Itala, on the other hand, is a system of aluminium uprights on which containers, shelves, mirrors and other accessories can be fixed with complete freedom.*



# Panorama

Cabina armadio Panorama con cassettiere top vetro allineate ai ripiani. A delimitare il perimetro della cabina i pannelli Boiserie che nelle finiture Sketch possono essere anche rigati come in foto.

*Panorama walk-in closet with drawer units with glass tops aligned with the shelves. The perimeter of the wardrobe is defined by Boiserie panels, which in the Sketch finishes can also be striped as shown in the photo.*



Cabina armadio Panorama con vassoi estraibili con guide ad estrazione totale e possono essere muniti di tappetino in ecopelle  
/ Panorama walk-in closet with pull-out trays with full extension runners, which can be fitted with eco-leather mats



Attrezzabile con una zona dedicata alla toeletta o all'home office, la Cabina armadio Panorama si integra perfettamente con il sistema armadio Scrigno, grazie alla trasversalità delle finiture, delle dimensioni e delle attrezzature coordinate. Qui sotto il ripiano in vetro rivestito in ecopelle e telaio in metallo.

*The Panorama walk-in closet can be fitted with a dressing area or home office and integrates perfectly with the Scrigno wardrobe system thanks to its versatile finishes, dimensions and coordinated accessories. Below is the glass shelf covered in eco-leather with a metal frame.*



Cabina armadio Panorama dotata di sistema di chiusura Scorrevole a due ante, con trave posizionata a soffitto. Una soluzione progettuale per dividere la cabina armadio dalla camera da letto.

*Panorama walk-in closet fitted with a two-door sliding closing system, with a beam positioned on the ceiling. A design solution to separate the walk-in closet from the bedroom.*

Vetro trasparente Fumè / Transparent Smoked



Vetro satinato cannettato / Satin-finish cannettato



Sistema Scorrevole di chiusura a due ante, integrato al sistema boiserie a parete. Letto Sissi con testiera imbottita e tavolini Uno con piano nella stessa finitura della struttura del letto.

*Two-door sliding system, integrated into the boiserie wall arrangement. Sissi bed with padded headboard and Uno side tables with tops in the same finish as the bed frame.*



Insieme al sistema Armadio, la cabina armadio Panorama si adatta all'architettura di ogni ambiente  
*/ Together with the Wardrobe system, the Panorama walk-in closet adapts to the architecture of any environment*





Panorama Free è un concetto di essenzialità assoluta e libertà di composizione che prende forma. Attrezzata come una cabina armadio, non utilizza schienali ma colloca i ripiani, i contenitori e gli accessori direttamente sui profili, con cremagliere che rimangono a vista, come viene mostrato nel dettaglio qui sotto.

*Panorama Free is a concept of absolute simplicity and freedom of composition. Equipped like a walk-in closet, it does not use back panels but places shelves, storage units and accessories directly on the profiles, with exposed racks, as shown in the detail below.*



## Panorama Boiserie

### POSIZIONAMENTO STAFFE PER RIPIANI / POSITION OF BRACKETS FOR SHELVES

- A – Ripiani Legno P 510 sp. 35  
/ Wooden shelves D 510 th. 35
- B – Ripiani Legno P 375 sp. 35  
/ Wooden shelves D 375 th. 35
- C – Ripiani Vetro/Telaio P 510 sp. 35  
/ Glass/frame shelves D 510 th. 35
- D – Pedana con piedino H 15  
/ Platform with foot H 15
- E – Ripiano inclinato portascarpe P 375  
/ Shoe inclined shelf D 375
- F – Ripiano inclinato portascarpe P 535  
/ Shoe inclined shelf D 535
- G – Montante per cremagliere  
/ Upright for rack systems
- H – Staffa Inclinata / Inclined bracket
- L – Staffa Terminale / End bracket
- M – Staffa Intermedia / Intermediate bracket
- S – Pannello specchio parziale tra due ripiani  
/ Partial mirror panel between two shelves
- Z – Pannelli a muro / Wall panels

### FINITURA STAFFE / BRACKET FINISH

- Brown
- Piombo
- Palladio

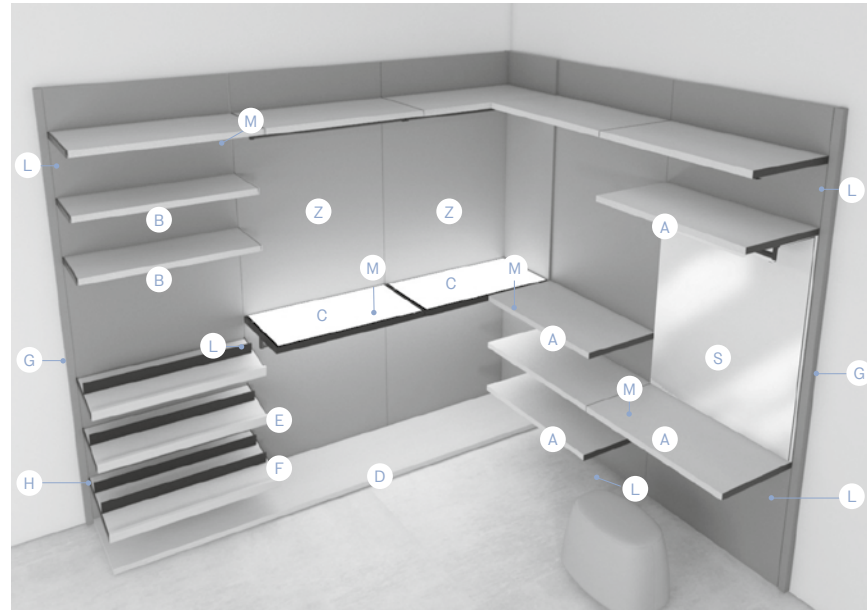

### FISSAGGIO ATTREZZATURE / FITTING FIXING

- 1 – Servetto / Pull-out clothes hanger rail
- 2 – Tubo appendiabiti / Clothes hanger rail
- 3 – Raster in appoggio / Raised Raster
- 4 – Raster sospeso con staffa  
/ Suspended Raster with bracket
- 5 – Cassettiera sospesa con coperchio  
/ Hanging drawer unit with top panel
- 6 – Cassettiera sovrapposta a pedana  
/ Superimposed drawer unit
- 7 – Cassettiera a terra  
/ Floor-standing drawer unit
- 8 – Cassettiera con portapantaloni  
/ Drawer unit for trouser rack
- 9 – Coperchio con svuotatasche  
/ Top panel with coin tray
- 10 – Pannello specchio totale  
/ Total mirror panel

### FINITURA RIPIANI/ACCESSORI/PANNELLI / SHELVES/ACCESSORIES/PANELS FINISH

- Materico / Melamine finish**
- Tramato Lino
- Loto Natura / Tortora / Terra
- Sketch Sabbia / Roccia / Tabacco  
(anche in versione rigata per pannelli)
- Olmo Medio / Scuro
- Econoce

Laccato opaco / Matt lacquered

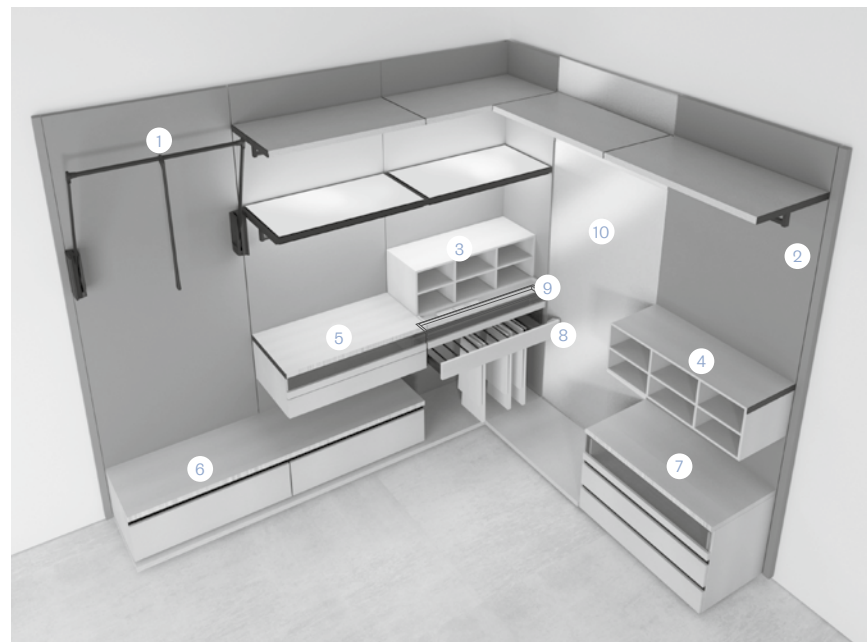

## Panorama Free

### POSIZIONAMENTO STAFFE PER RIPIANI / POSITION OF BRACKETS FOR SHELVES

- A – Ripiani Legno P 510 sp. 35  
/ Wooden shelves D 510 th. 35
- B – Ripiani Legno P 375 sp. 35  
/ Wooden shelves D 375 th. 35
- C – Ripiani Vetro/Telaio P 510 sp. 35  
/ Glass/frame shelves D 510 th. 35
- D – Pedana con piedino H 15  
/ Platform with foot H 15
- E – Ripiano inclinato portascarpe P 375  
/ Shoe inclined shelf D 375
- F – Ripiano inclinato portascarpe P 535  
/ Shoe inclined shelf D 535
- G – Cremagliera a vista (anche elettrica)  
/ Visible rack system (also electrified)
- H – Staffa Inclinata / Inclined bracket
- L – Staffa Terminale / End bracket
- M – Staffa Intermedia / Intermediate bracket
- P – Profilo con cremagliera sovrapposto a pedana  
/ Rack profile on platform

### FINITURA CREMAGLIERE E STAFFE / FINISH FOR RACK SYSTEMS AND BRACKETS

- Brown
- Piombo
- Palladio

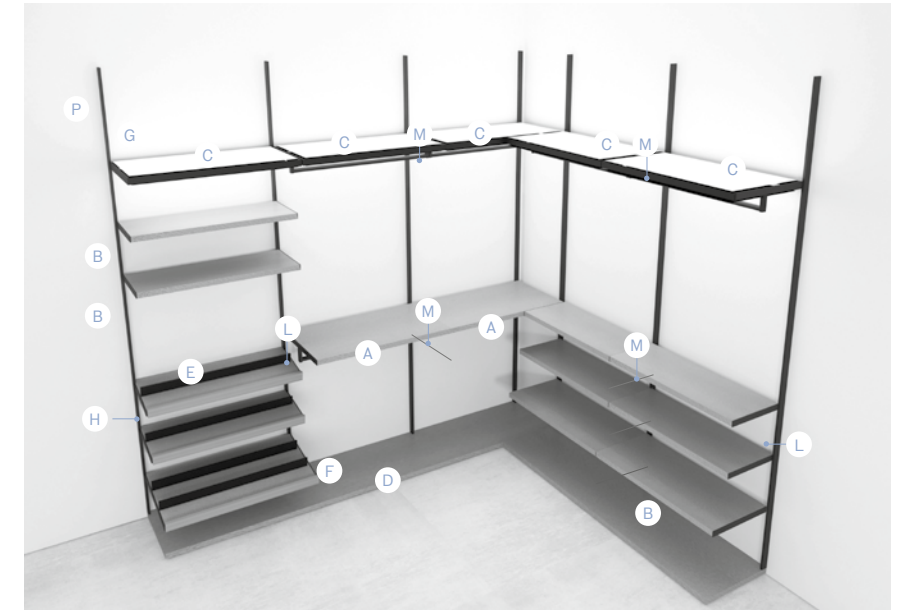

### FISSAGGIO ATTREZZATURE / FITTING FIXING

- 1 – Profilo con cremagliera a terra  
/ Floor-standing rack system profile
- 2 – Tubo appendiabiti / Clothes hanger rail
- 3 – Raster in appoggio / Raised Raster
- 4 – Raster sospeso / Suspended Raster
- 5 – Cassettiera sospesa con coperchio  
/ Hanging drawer unit with top panel
- 6 – Cassettiera con portapantaloni  
/ Drawer unit for trouser rack
- 7 – Coperchio con svuotatasche  
/ Top panel with coin tray

### FINITURA RIPIANI/ACCESSORI / SHELVES/ACCESSORIES FINISH

- Materico / Melamine finish**
- Tramato Lino
- Loto Natura / Tortora / Terra
- Sketch Sabbia / Roccia / Tabacco
- Olmo Medio / Scuro
- Econoce

Laccato opaco / Matt lacquered

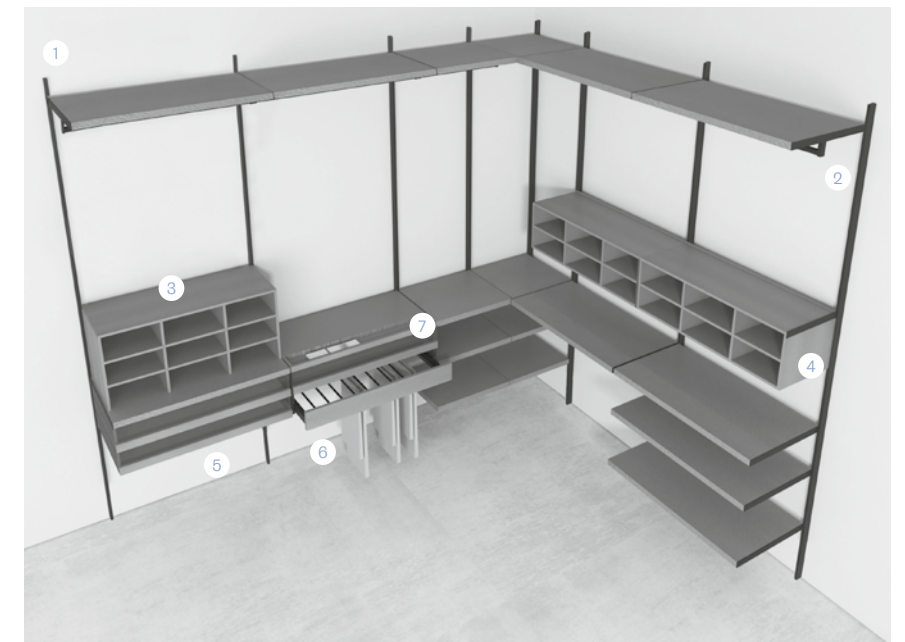

# Finiture cabina Panorama

## Panorama finishes

Sketch Sabbia con schienali rigati  
/ Sketch Sabbia with fluted back panels



Sketch Roccia con schienali rigati  
/ Sketch Roccia with fluted back panels



Sketch Tabacco con schienali rigati  
/ Sketch Tabacco with fluted back panels



Tramato Lino



Laccato Opaco  
/ Matt lacquered



Loto Natura



Loto Tortora



Loto Terra



Econoce



Olmo Medio



Olmo Scuro



## Ripiani Shelves

Ripiani Legno P 510  
/ Wooden shelves D 510



Vassoi estraibili su cassettera P 510  
/ Pull-out trays on drawer unit D 510



Vassoi estraibili su cassettera P 510 con tappetino in ecopelle  
/ Pull-out trays on drawer unit D 510 with Eco-Leather mat



Ripiani a telaio con vetro P 510  
/ Shelves with metal frame D 510



Ripiano portascarpe inclinato con battitacco P 375  
/ Inclined shoe shelf D 375



Ripiano portascarpe inclinato con doppio battitacco P 510  
/ Inclined shoe shelf D 510



## Appenderia Hanging system

Tubo appendiabiti  
/ Clothes hanging rail



Perno estraibile  
/ Pull-out hanger



Servetto  
/ Pull-out clothes hanging rail



## Illuminazione Lighting

Led su ripiano  
/ Led on shelf



Led su ripiano a telaio con vetro  
/ Metal shelf with led



Led su specchio  
/ Led on mirror



# Raster

## Raster system

Vani H 144 P 375  
/ Compartments H 144 D 375



Vani H 192 P 375  
/ Compartments H 192 D 375



Vani H 144 P 375  
/ Compartments H 144 D 375



# Coperchi e separatori

## Tops and partitions

Cassetti con tappetino e separatori  
/ Drawers with mat and partitions



Coperchio in legno  
/ Wooden top



Top in vetro  
/ Glass top



Coperchio con svuotatasche e separatore  
/ Top with coin tray & divider



Cassetto con divisori interni  
/ Internal partitions for drawer



# Tipologia di cassetti

## Types of drawer unit

Cassetti tipo A con foro di apertura  
/ Type A drawer with opening



Portapantaloni  
/ Trousers rack



Cassetti tipo B con profilo metallo  
/ Type B drawer with metal profile



Cassetti tipo C con frontale vetro  
/ Type C drawer with glass front



Cassetti tipo E con maniglia sporgente  
/ Type E drawer with protruding handle



Top in vetro  
/ Glass top



## Panorama

Cassettiere a terra o su pedane / Drawer units on floor or on benches  
P/D 510 L/W 575/725/975

SCocca - FRONTALI / CARCASE - FRONTS  
Materico Tramato Lino / Loto / Sketch  
/ Econoco  
Laccato opaco

Tipologia	H 288	H 336	H 384	H 432	H 480	H 480	H 576	H 576	H 672	H 768	H 960	H 960
A B E												
							Top vetro		Top vetro	Top vetro	Top vetro	Top vetro
C												
							Top vetro		Top vetro	Top vetro	Top vetro	Top vetro
A/C B/C												

Cassettiere pensili / Wall-mounted drawer units  
P/D 510 L/W 575/725/975

Tipologia	H 179	H 227	H 323	H 323	H 371	H 419	H 467	H 515	H 515	H 611	H 611	H 611
A B E												
							Top vetro		Top vetro	Top vetro	Top vetro	Top vetro
C												
							Top vetro		Top vetro	Top vetro	Top vetro	Top vetro
A/C B/C												

Vassoi estraibili / Pull-out trays

Portapantaloni / Trousers rack



# Itala Cabina

La cabina Itala è un espositore a vista, composto da un sistema di montanti in alluminio che permettono il fissaggio di diverse attrezzature, come ripiani di spessore 35 mm, cassettiere, appendiabiti e specchiere orientabili, senza vincoli di posizione grazie agli attacchi a scomparsa. Dotati di piedi regolabili, i montanti possono essere posizionati a parete o fissati al soffitto per un utilizzo anche bifacciale. L'illuminazione a led può essere inserita verticalmente nei montanti, oppure orizzontalmente nei ripiani.

*The Itala walk-in closet is an open display unit consisting of a system of aluminium uprights that allow various items of equipment to be attached, such as 35 mm thick shelves, drawers, clothes hanging rails and adjustable mirrors, with no positioning restrictions thanks to the concealed attachments. Equipped with adjustable ends, the uprights can be positioned against a wall or fixed to the ceiling for double-sided use. Led lighting can be inserted vertically into the uprights or horizontally into the shelves.*



# Itala Cabina

**MONTANTI / UPRIGHTS**  
Palladio / Brown

**SCocca - FRONTALI / CARCASE - FRONTS**  
Materico Tramato Lino / Loto / Sketch / Olmo / Econoce  
Laccato opaco / Metallo

Montante a soffitto / *Ceiling upright*

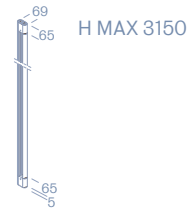

Montante a parete / *Wall mounted*

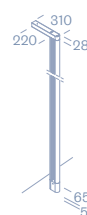

Mensole sp. 35 / *Shelves th. 35*



ESPLOSO / *EXPLODED VIEW*

- ① Escursione piedino 25 mm max
- ② Montante con supporto a soffitto
- ③ Montante con supporto a parete
- ④ Specchiera Ø 600
- ⑤ Led incassato su ripiano sp. 35
- ⑥ Tubo appendiabiti
- ⑦ Attacco con viti per ripiani sp. 35
- ⑧ Alimentatore sottoripiano o sottocontenitore
- ⑨ Attacco a scomparsa per tubo appendiabiti
- ⑩ Specchiera H 1500x500

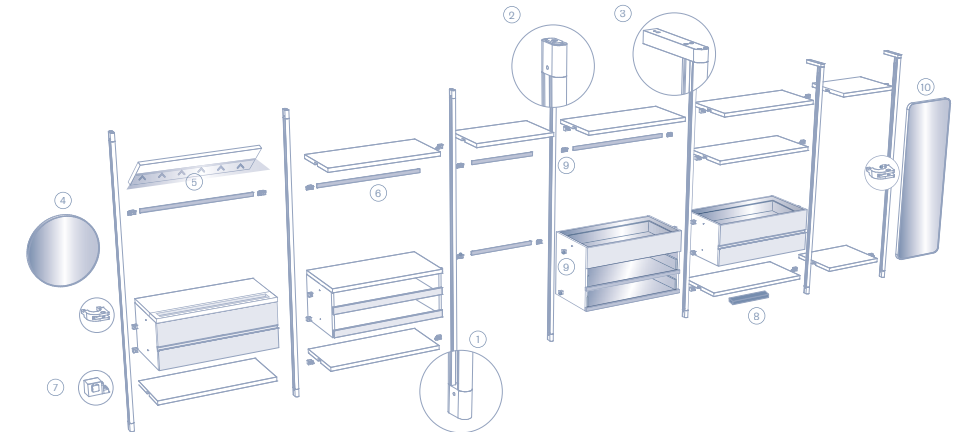

- ① Foot excursion 25 mm max
- ② Upright with ceiling support
- ③ Upright with wall support
- ④ Mirror Ø 600
- ⑤ Recessed LED on shelf th. 35
- ⑥ Clothes hanging rail
- ⑦ Screw attachment for shelves th. 35
- ⑧ Under-shelf or under storage unit power supply
- ⑨ Concealed attachment for clothes hanging rail
- ⑩ Mirror H 1500x500

- **Le composizioni Itala devono essere composte con un minimo di 3 montanti verticali e 4 attacchi per ripiani o contenitori per vano. Per ulteriori esigenze contattare il nostro ufficio tecnico.**

- I montanti, composti da due profili accoppiati, sono alti max 3150 mm e vengono realizzati di volta in volta a misura. Per altezze superiori, fino a un max di 3500 mm, vengono realizzati su specifica richiesta.
- Il sistema prevede l'ancoraggio dei montanti a pavimento, a soffitto o a parete. Si rimanda al rivenditore la valutazione della resistenza della parete per poter scegliere i tasselli di fissaggio più idonei. Per la realizzazione dei montanti a soffitto comunicare l'altezza del locale. In caso di quote non allineate verificare le tolleranze riportate.  
\* (escursione piedino 25 mm max)
- Mensole sp. 35 fissate agli attacchi a scomparsa ad espansione con un attacco con viti. Questo permette il posizionamento in altezza di ripiani e cassettiere a discrezione del Cliente.
- Le cassette prevedono un ulteriore attacco di stabilizzazione in prossimità del bordo superiore.
- Le composizioni con illuminazione devono avere per ogni modulo un ripiano o un contenitore a non più di 400 mm da terra. Questi elementi devono essere allineati in quanto necessari al collegamento elettrico.
- I montanti possono essere accessoriati con illuminazione led incassata verticalmente nel profilo posteriore. I cavi, con uscita alla estremità inferiore, vengono collegati agli alimentatori posizionati sotto i ripiani e contenitori a 400 mm da terra.
- Le mensole e il cassetto superiore delle cassette con top vetro possono essere accessoriati con illuminazione led incassata. In questo caso i montanti vengono cablati con una canalina elettrificata. Questo permette di inserire più contatti e di poter spostare a piacere in altezza ripiani e cassette.
- L'impianto elettrico prevede la partenza dal montante sx del modulo che si vuole elettrificare. Il costo degli alimentatori è già comprensivo nel costo dei led e ognuno supporta max 75 W.
- È possibile richiedere montanti dotati sia di illuminazione a led verticali che di canalina elettrificata per illuminazione orizzontale di ripiani e contenitori.
- Le piastre girevoli agganciate ai montanti possono ospitare le specchiere girevoli.

- **Itala compositions must be composed of a minimum of 3 vertical uprights and 4 attachments for shelves or storage units per compartment.**

- **For further requirements, please contact our technical department.**
- The uprights, composed of two coupled profiles, are max 3150 mm high and are made to measure each time. For greater heights, up to a maximum of 3500 mm, they are made to specific request.
- The system provides for the anchoring of the uprights to the floor, ceiling or wall. Please consult your retailer to assess the strength of the wall in order to choose the most suitable fixing plugs. For the installation of ceiling uprights, please provide the height of the room. In the case of non-aligned dimensions, check the tolerances indicated.\* (foot range 25 mm max)
- Shelves Th 35 shelves are fixed to concealed expansion brackets with screws. This allows the customer to position shelves and drawers at any height.
- The drawer units have an additional stabilising bracket near the top edge.
- Compositions with lighting must have a shelf or storage unit no more than 400 mm from the floor for each module. These elements must be aligned as they are necessary for the electrical connection.
- The uprights can be fitted with LED lighting recessed vertically into the rear profile. The cables, with outlets at the bottom, are connected to power supplies positioned under the shelves and storage units 400 mm from the floor.
- The shelves and top drawer of drawer unit with glass top can be fitted with recessed LED lighting. In this case, the uprights are wired with an electrified cable duct. This allows for the insertion of multiple contacts and the ability to move shelves and drawers to any height.
- The electrical system starts from the left-hand side of the module to be electrified. The cost of the power supplies is already included in the cost of the LEDs, and each one supports a maximum of 75 W.
- It is possible to request uprights equipped with both vertical LED lighting and an electrified channel for horizontal lighting of shelves and storage units.
- The swivelling plates attached to the uprights can accommodate swivelling mirrors.

Tipologia	H 227	H 323	H 371	H 419	H 467	H 515	H 611
-----------	-------	-------	-------	-------	-------	-------	-------

Cassettiere pensili / *Wall-mounted drawer units P/D 510*

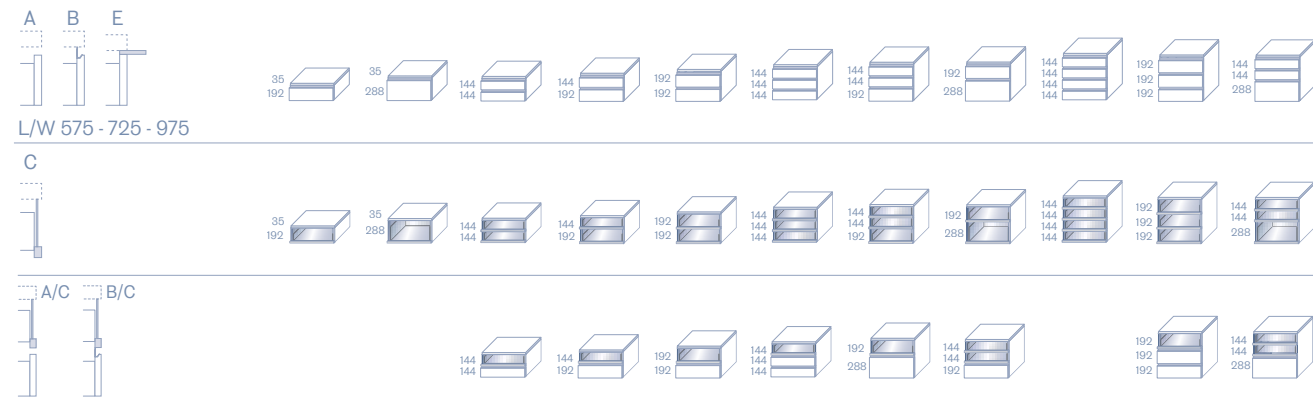

Vassoi estraibili / *Pull-out trays*

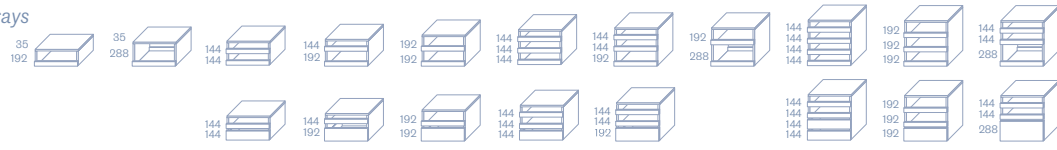

Portapantaloni / *Trouser rack* H 179 H 323

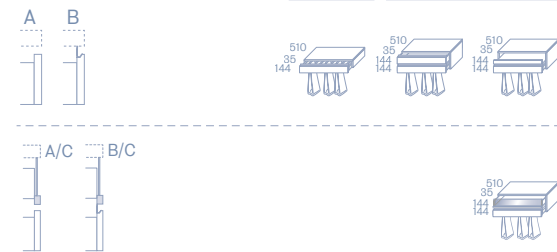

Top Vetro / *Glass top panel*

H 390 H 582

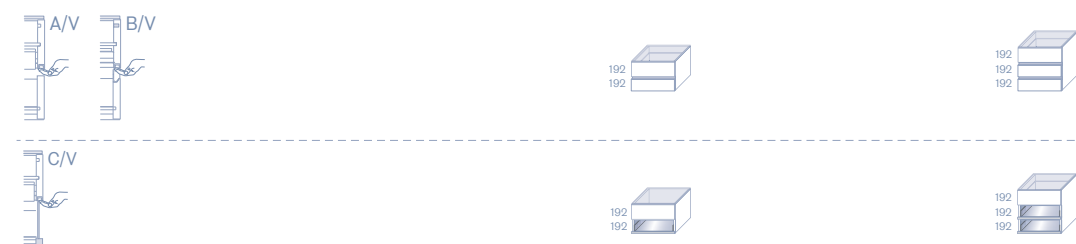

# Atollo

## Tipologie di cassettiere Atollo / Types of Atollo drawer units

FINITURE / FINISHES  
Materico Tramato Lino / Loto / Sketch / Olmo  
/ Econoce

Moduli singoli, con piano in vetro trasparente  
/ Single modules, with transparent glass top

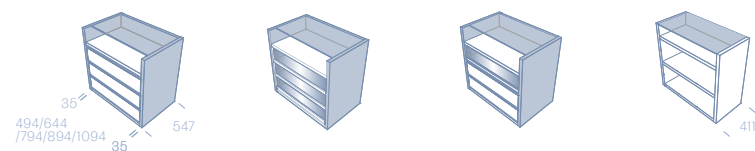

Moduli singoli, con coperchio di finitura  
/ Single modules, with finishing top panel

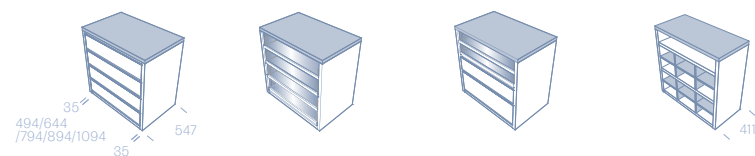

Moduli accostati o con verso contrario  
/ Modules placed side by side or in opposite direction

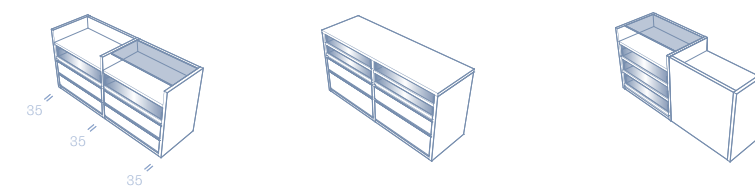

Moduli contrapposti e accostati bifacciali  
/ Opposite and side-by-side double-sided modules

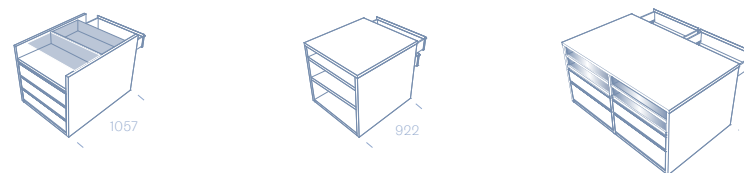

La cabina armadio si arricchisce delle cassettiere Atollo in configurazione a isola che completano con eleganza e funzionalità l'ambiente guardaroba. Ideali come centro stanza, sono contenitori ed espositori allo stesso tempo, grazie a molteplici combinazioni di attrezzature e configurazioni, con frontali dei cassetti in legno o vetro.

The walk-in closet is enhanced with Atollo drawer units in an island configuration, which add elegance and functionality to the wardrobe area. Ideal as a centrepiece, they serve as both storage and display units, thanks to a wide range of combinations of fittings and configurations, with drawer fronts in wood or glass.



Cassettiera Atollo con moduli contrapposti e affiancati, per creare un'isola bifacciale a centro stanza, dotata di cassetti in legno e vetro.

*Atollo drawer units with opposite and side by side modules to create a double-sided island in the centre of the room, equipped with wooden and glass drawers.*



# Bacheca Atollo



## Tipologie di cassettiere Bacheca Atollo / *Bacheca Atollo drawer units*

**FINITURE / FINISHES**  
Materico Tramato Lino / Loto / Sketch  
/ Olmo / Econoce  
Laccato opaco / Metallo

Moduli singoli con top vetro  
/ *Single modules with glass top*

Moduli accostati con top vetro unico  
/ *Side by side modules with single glass top*

Moduli bifacciali con top vetro unico  
/ *Double-sided modules with single glass top*

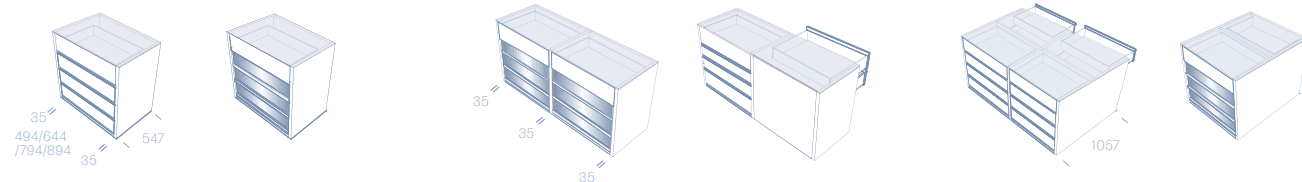

Cassettiera Bacheca Atollo con moduli componibili e piano superiore in vetro. I suoi cassetti superiori diventano in questo modo delle bacheche da esposizione e possono essere dotati di attrezzature e luce led sul retro-frontale, per dare risalto agli oggetti più preziosi e speciali.

*Atollo display unit with modular components and glass top. Its upper drawers thus become display units and can be equipped with partitions and Led lighting at the back and front to highlight the most precious and special items.*



Nella Bachea Atollo ogni cassetto può essere dotato di tappetino lineare in ecopelle, con cuciture di finitura, oppure di divisori che a loro volta possono essere suddivisi da vaschette in appoggio, sempre in ecopelle. In alternativa, si possono inserire dei divisori laccati che organizzano lo spazio in forme regolari e possono essere utilizzati da soli, oppure insieme al tappetino lineare.

*The Bachea Atollo display unit, each drawer can be fitted with a linear eco-leather mat with decorative stitching, or with partitions that can be divided by eco-leather trays. As an alternative, lacquered partitions can be inserted to organise the space into square and rectangular shapes, and can be used as is, or together with the linear mat.*



Cassetti con tappetino e separatori  
/ Drawers with mat and partitions



Cassetto con divisori interni  
/ Internal partitions for drawer



# Letti

Sistema Ecletto	214	Nest	282
Sissi	232	Nest Imbottito	288
Abbraccio	242	Milo	290
Abbraccio Grafic	248	Decor	294
Folio	252	Cosy	298
Folio Grafic	258	Dorian	304
Febo 1.0	262	Dorian Plano	308
Febo 2.0	266	Peplo	312
Aliante 1.0	270	Peplo Imbottito	316
Aliante 2.0	274	Gaston	320

## Beds

Nel cuore della zona notte, il letto caratterizza lo spazio con le sue proporzioni misurate e armonie di materiali. È un elemento architettonico che dialoga con boiserie, contenitori e pareti, creando continuità visiva e coerenza stilistica. Le superfici si incontrano come componenti di un unico progetto, mentre il calore del legno, la profondità dei laccati, la morbidezza dei tessuti e delle pelli danno vita a una dimensione intima e accogliente. Ogni letto SANGIACOMO nasce per unire forma ed emozione, equilibrio e comfort, traducendo l'idea di bellezza in un gesto quotidiano, affascinante e senza tempo.

*In the heart of the sleeping area, the bed characterises the space with its measured proportions and harmonious materials. It is an architectural element that interacts with boiserie, storage unit and walls, creating visual continuity and stylistic coherence. The surfaces come together as components of a single design, while the warmth of the wood, the depth of lacquered finishes and the softness of the fabrics and leathers create an intimate and welcoming atmosphere. Every SANGIACOMO bed is designed to combine form and emotion, balance and comfort, translating the idea of beauty into an inviting and timeless everyday gesture.*



# Sistema Ecletto

Un sistema versatile caratterizzato da testiere composte da pannelli boiserie imbottiti o in legno. La sua modularità, che consente di disporre i pannelli liberamente in verticale o in orizzontale, permette un'elevata flessibilità progettuale, arricchita dall'integrazione di contenitori e mensole Domino in legno o vetro. Un retropannello unifica la composizione e permette l'inserimento di un impianto LED perimetrale, creando un raffinato effetto luminoso.

*A versatile system featuring headboards consisting of padded or wooden boiserie panels. Its modularity, which allows the panels to be freely arranged vertically or horizontally, offers great design flexibility, enhanced by the integration of Domino storage units and shelves in wood or glass. A back panel unifies the composition and allows for the insertion of a perimeter Led system, creating a soft lighting effect.*



I componenti Domino Giro sono di forma quadrata (450 x 450 mm, H 150 o 225 mm) e ruotano in maniera indipendente attorno a un perno centrale, permettendo di creare infinite variazioni.

*Domino Giro components are square (450 x 450 mm, H 150 or 225 mm) and rotate independently around a central pivot, allowing for endless variations.*



Letto Ecletto con ring imbottito e testiera attrezzata con pensili e mensole, dotata di illuminazione a led perimetrale  
/ Ecletto bed with padded frame and headboard equipped with wall units and shelves, fitted with perimeter Led lighting





Contenitori Domino sovrapposti e sfalsati con piano scrittoio sagomato orientabile  
 / Overlapped and staggered Domino storage units with shaped desktop



Testiera attrezzata Eceletto con un accostamento di pannelli boiserie imbottiti e piatti in ecopelle. In questa configurazione, vediamo i contenitori pensili con cassetto, profondi 452 mm, abbinati alla mensola Domino con profondità 245 mm.

*Eceletto headboard with a combination of padded boiserie panels and flat eco-leather panels. In this configuration, wall-mounted storage units with 452 mm deep drawers combined with the 245 mm deep Domino shelf.*



Letto imbottito Dorian accostato alle boiserie Eceletto è predisposto per accogliere le pedane Diletto e i contenitori Domino  
/ The Dorian padded bed combined with the Eceletto boiserie is designed to accommodate the Diletto platform and Domino storage units



Sistema Ecletto con boiserie, pedane Diletto e contenitori Domino  
/ Ecletto System with boiserie, Diletto benches and Domino storage units

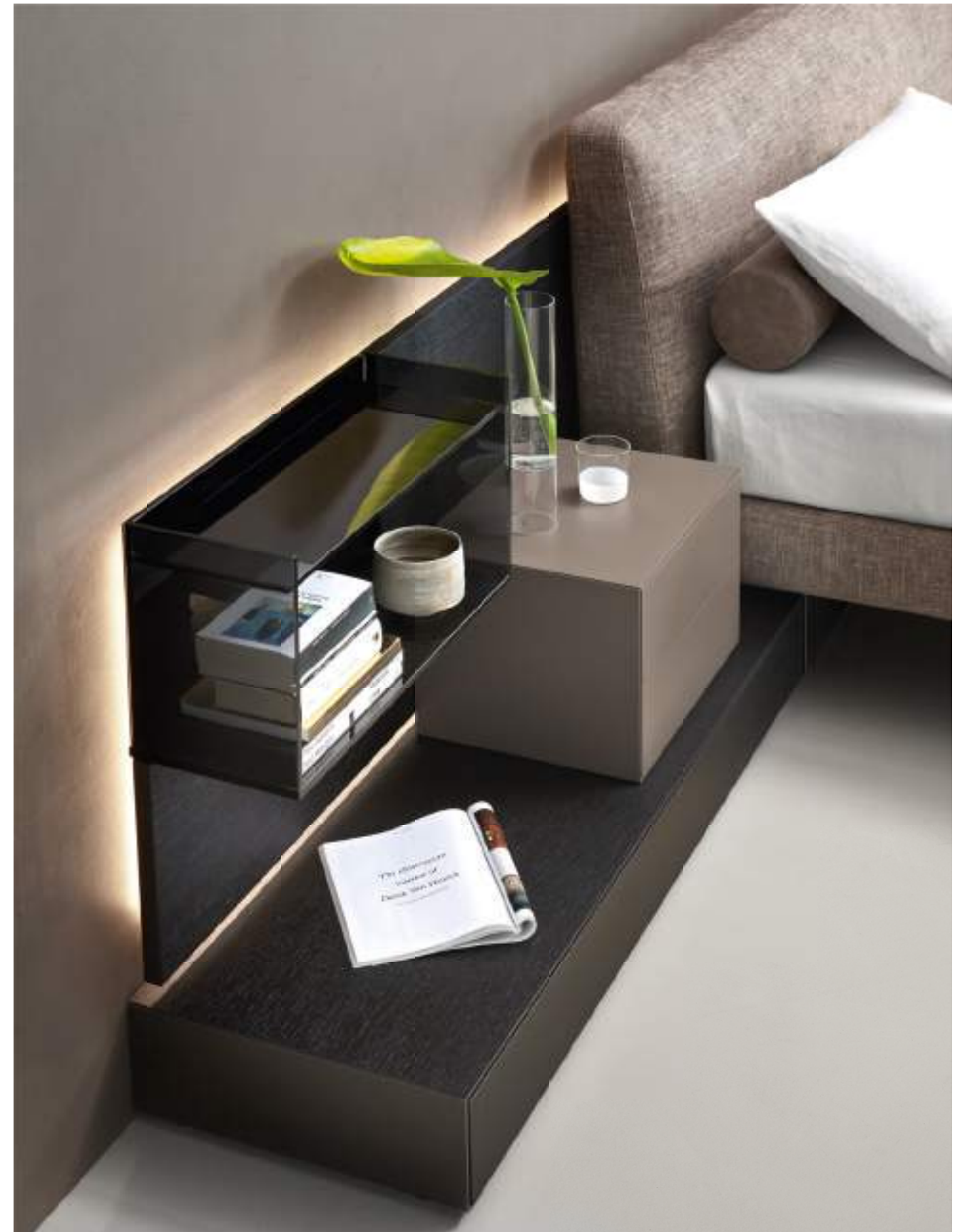

## Sistema Ecletto

Boiserie per testiere attrezzate  
/ Boiserie for equipped headboards

## CARATTERISTICHE

I pannelli per boiserie attrezzate o per testiere letto, le mensole e i contenitori Domino pensili vengono appesi tramite UN RETRO PANNELLO IN MDF NERO SPESSORE 19 che viene fornito con tutte le predisposizioni e ferramenta per appendere, ed è già compreso nel prezzo delle boiserie. Può essere completato con una luce Led perimetrale annegata nello spessore. I pannelli boiserie e le mensole risultano distanziati 24 mm dal muro. Il retro pannello viene suddiviso di volta in volta in base alla dimensione della composizione per agevolare il suo trasporto e di norma i tagli sono sempre in corrispondenza di inizio o fine di un pannello boiserie o di un contenitore. I contenitori Domino e le mensole metallo vengono montati aderenti al retro pannello mentre le boiserie e le mensole Domino rimangono distanziate di 5 mm formando un'intercapedine necessaria al cablaggio.

## FEATURES

The panels for fitted boiserie or headboards, shelves and Domino wall-mounted storage units are hung using A 19 mm THICK BLACK MDF BACK PANEL, which is supplied with all the necessary fittings and hardware for hanging and is already included in the price of the boiserie. It can be completed with a perimeter LED light recessed into the thickness. The panelling and shelves are 24 mm away from the wall. The back panel is divided from time to time according to the size of the composition to facilitate its transport, and as a rule, the cuts are always at the beginning or end of a panel or storage unit. Domino storage units and metal shelves are mounted flush with the back of the panel, while Domino panelling and shelves remain 5 mm away, forming a cavity necessary for wiring.

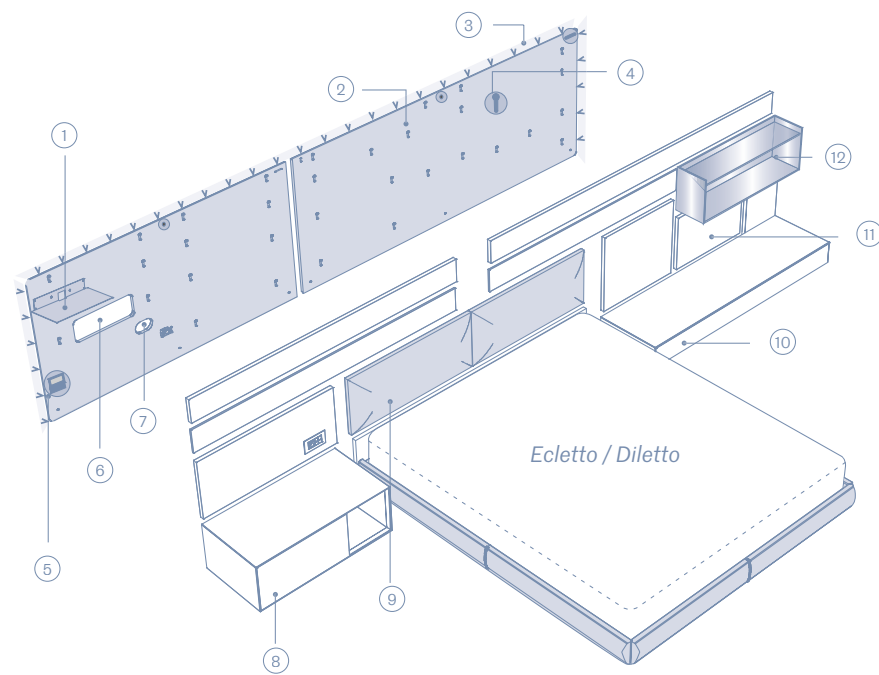

- ① Mensola in metallo montata
- ② Retro pannello a parete
- ③ Luce led perimetrale
- ④ Asole per fissaggio boiserie e mensole Domino
- ⑤ Attaccaglie per contenitore Domino pensile
- ⑥ Tasca alloggiamento alimentatore
- ⑦ Foro per scatola di derivazione elettrica
- ⑧ Contenitore Domino pensile
- ⑨ Pannelli testiera
- ⑩ Pedana Diletto a terra
- ⑪ Pannelli boiserie attrezzati
- ⑫ Mensola Domino

- ① Metal shelf
- ② Wall back pane
- ③ Perimetric led light
- ④ Slots for boiserie and Domino shelves
- ⑤ Brackets for wall-mounted Domino storage unit
- ⑥ Power supply housing
- ⑦ Hole for electrical box
- ⑧ Wall-mounted Domino storage unit
- ⑨ Headboard panels
- ⑩ Floor-standing Diletto bench
- ⑪ Equipped boiserie panels
- ⑫ Domino shelf

## Domino

Contenitori / Storage units P/D 452

CONTENITORI MONOTINTA P 452  
/ ONE COLOUR UNITS D 452  
Laccato opaco / Metallo

CONTENITORI DOPPIA TINTA P 452  
/ TWO COLOUR UNITS D 452  
ESTERNO Rovere Imp. Carbone / Grigio  
/ Avana / Argilla / Cuba  
INTERNO Laccato opaco / Metallo

Boiserie per testiere attrezzate  
/ Domino units for equipped headboards

	L/W 300	L/W 450	L/W 600	L/W 900
H 150				450 450
H 225				
H 300			118 EGO P/D 356/456	118 EGO P/D 356/456

Mensole legno sp. 10 o vetro sp. 8 P 254  
/ Wooden shelves th. 10 or glass shelves th. 8 D 254

	L/W 300	L/W 450	L/W 600	L/W 900
H 225				884
H 300		93	93	
		40  93	40  93	40

Un sistema versatile per creare molteplici varianti, con giroletto in finitura legno H 90 mm o H 150 mm, imbottito H 150 o H 300 sovrapponendo i pannelli modulari per testiera in varie altezze e combinandoli per tipologia (imbottiti o finitura legno). È inoltre possibile avere una modularità in larghezza, sia a filo ring che sporgente.

A versatile system for creating multiple variations, with bed frame in wood finish H 90 mm or H 150 mm, upholstered H 150 or H 300 by overlapping the modular headboard panels in various heights and combining them by type (upholstered or wood finish). It is also possible to have modularity in width, both flush with the ring and protruding.

Giroletto legno / Wooden bed frame

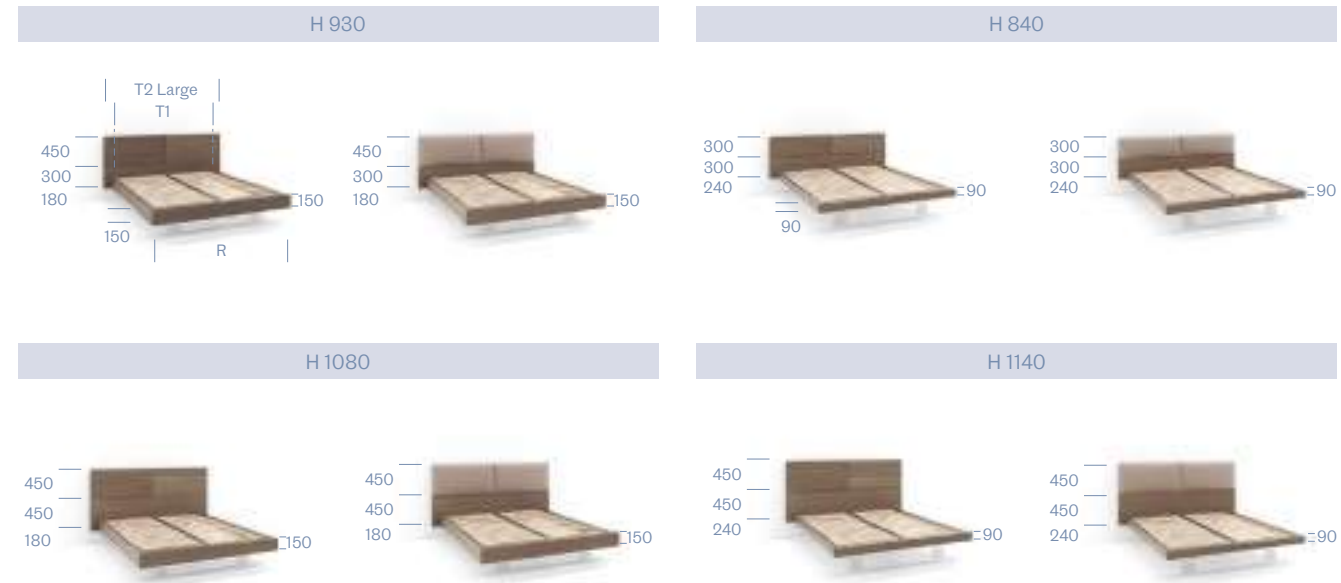

Giroletto imbottito / Upholstered bed frame

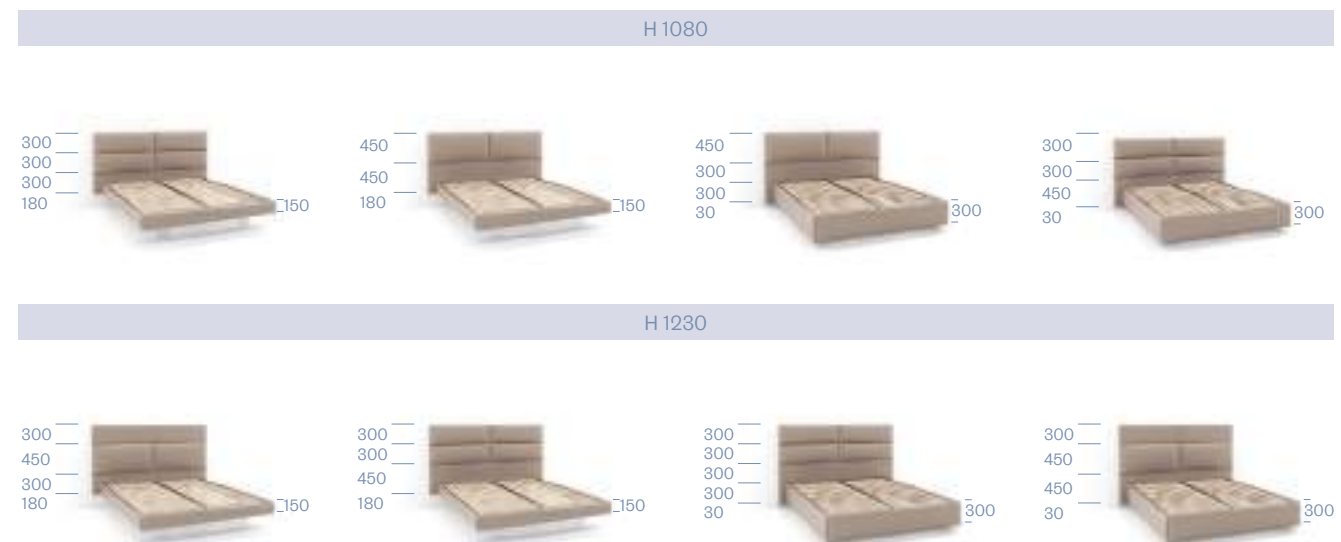

Modularità Boiserie Domino per attrezzatura testiere Ecletto / Domino Boiserie modularity for Ecletto headboard fittings

- sp. 10 e 25\*  
Rovere Tinto / Termotrattato  
Noce Canaletto
- sp. 25\*  
Materico Sketch / Olmo / Econoce
- sp. 10 e 25  
Laccato opaco / Metallo
- sp. 27  
Ecopelle / Ecovintage
- sp. 25  
Specchio Dark
- sp. 25  
Materico Loto

- sp. 27  
Tessuto
- sp. 27 — —  
Pelle / Pelle Vintage

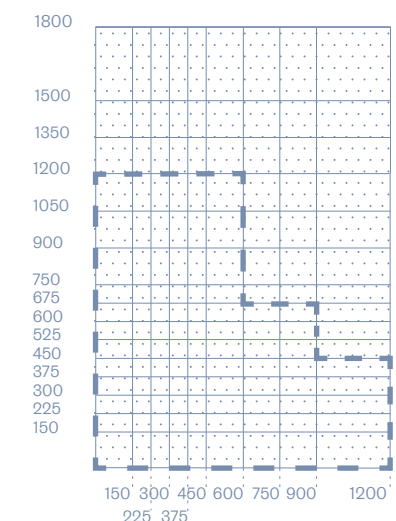
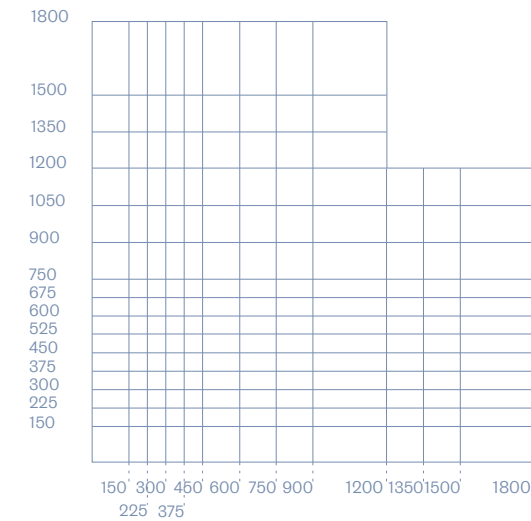

\* Venatura orizzontale e verticale / Horizontal and vertical grain

Pannelli Boiserie per testiere / Boiserie panels for headboards

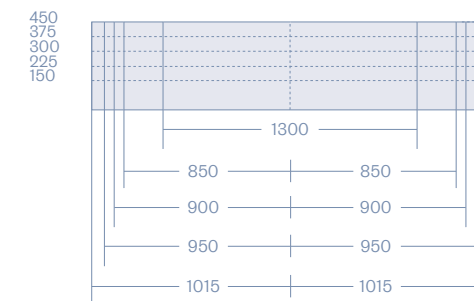

In tutte le finiture / In all finishes

- Rete / Slat L/W 1200
- Rete / Slat L/W 1600
- Rete / Slat L/W 1700
- Rete / Slat L/W 1800
- Rete / Slat King Size

## Sissi



## PIEDI LEGNO



Misure materasso L/W x P/D	Ingombro letto L/W x P/D	
1500 x 1900	1661 x 2149	Con compensativo
1600 x 1900	1731 x 2149	
1600 x 2000	1731 x 2249	
1800 x 1900	1931 x 2149	
1800 x 2100	1931 x 2349	
1530 x 2030	1661 x 2279	Queen size
1930 x 2030	2061 x 2279	King size

Misure espresse in mm

Piacevolmente ergonomico, questo letto ha una struttura in legno e derivati ricoperta con poliuretano espanso a quote differenziate con pre-rivestimento in ovatta di poliestere. Il rivestimento è sfoderabile in tessuto oppure non sfoderabile in ecopelle o pelle. Quest'ultimo è disponibile con retrotestiera in tela tecnica, oppure completamente in pelle. Montanti laterali, giroletto e piedi sono realizzati in legno massello impiallacciato in Rovere o Noce.

*Pleasantly ergonomic, this bed has a wood and wood-based structure covered with polyurethane foam of varying densities with a polyester batting pre-cover. Removable fabric cover or non-removable eco-leather and leather cover. The latter is available with a technical fabric backrest or completely in leather. The side posts, bed frame and legs are made in solid wood veneered Oak or Walnut.*





Letto Sissi con testiera ergonomica imbottita in poliuretano espanso a quote differenziate  
/ Sissi bed with ergonomic padded headboard with polyurethane foam of varying densities



Ambiente notte con Letto Sissi abbinato a tavolini Uno e cassetiera Cidori, armadio scorrevole Meridian accostato alla Cabina armadio Itala  
/ Sleeping area with Sissi bed combined with Uno side tables and Cidori drawer unit, Meridian sliding wardrobe next to the Itala walk-in closet



A completamento dell'ambiente notte, la parete è rivestita con Boiserie modulare Domino a doppio spessore con una serie verticale di mensole in metallo, con luce a led orizzontale.

*To complete the bedroom, the wall is covered with double-thickness Domino modular Boiserie with a vertical series of metal shelves and horizontal Led lighting.*



# Abbraccio



PIEDE – P – LEGNO



Misure materasso  
L/W x P/D

Misure materasso L/W x P/D	Ingombro letto L/W x P/D
1500 x 1900	1741 x 2292
1500 x 2000	1741 x 2392
1600 x 1900	1841 x 2292
1600 x 2000	1841 x 2392
1800 x 2000	2041 x 2392

PIEDE – V – METALLO



Misure materasso  
L/W x P/D

Misure materasso L/W x P/D	Ingombro letto L/W x P/D
1500 x 1900	1741 x 2292
1500 x 2000	1741 x 2392
1600 x 1900	1841 x 2292
1600 x 2000	1841 x 2392
1800 x 2000	2041 x 2392

CONTENITORE LEGNO



Misure materasso  
L/W x P/D

Misure materasso L/W x P/D	Ingombro letto L/W x P/D
1600 x 1900	1841 x 2292
1600 x 2000	1841 x 2392
1800 x 2000	2041 x 2392

Misure espresse in mm

Soffice e accogliente, questo letto ha la retrotestiera in particelle di legno a media densità, sagomata a 45° lungo i bordi e impiallacciata in Rovere o Noce. Cuscini imbottiti con poliuretano espanso e pre-rivestimento in ovatta di poliestere, con rivestimento sfoderabile in tessuto o ecopelle. Rivestimento sfoderabile disponibile anche in pelle, con retro in tela tecnica. Giroletto per piedi spessore 100 mm in legno massello tinto sagomato, rivestito sulla faccia superiore, giroletto per contenitore spessore 40 mm con sponde rientranti e giunzione a 45° negli angoli, impiallacciata in Rovere e Noce.

*Soft and cosy, this bed has a headboard in medium density particle board and bevelled edges in Oak and Walnut veneer. Polyurethane foam padded cushions and polyester batting pre-cover with removable fabric or eco-leather covers. Removable cover also available in leather, with technical fabric back. 100 mm thick bedframe in shaped stained solid wood, covered on the upper side. 40 mm thick storage bed frame with recessed sides and 45° corner joints, veneered Oak and Walnut.*





Il disimpegno della zona notte può essere arredato con la cassetiera Cabaret con altezza di 595 mm e i contenitori Lampo dotati di maniglie Collage.

*The spaces near the sleeping area can be furnished with 595 mm high Cabaret drawers and Lampo storage units fitted with Collage handles.*



# Abbraccio Grafic



PIEDE – V – METALLO



Misure materasso L/W x P/D	Ingombro letto L/W x P/D
1600 x 1900	1758 x 2232
1600 x 2000	1758 x 2332

CONTENITORE LEGNO



Misure materasso L/W x P/D	Ingombro letto L/W x P/D
1600 x 1900	1758 x 2232
1600 x 2000	1758 x 2332

Misure espresse in mm

Questa versione è caratterizzata da un particolare fascino "materico". Retrotestiera in particelle di legno a media densità, sagomata a 45° lungo i bordi e nobilitata con effetto legno, calce o laccato opaco. Cuscini imbottiti con poliuretano espanso e pre-rivestimento in ovatta di poliestere, con rivestimento sfoderabile in tessuto o ecopelle. Rivestimento sfoderabile disponibile anche in pelle, con retro in tela tecnica. Giroletto per piedi spessore 100 mm in legno massello tinto sagomato, rivestito sulla faccia superiore e giroletto per contenitore spessore 40 mm con sponde rientranti e giunzione a 45° negli angoli, nobilitato con effetto legno, calce e metallo o laccato opaco.

*This version has a distinctive "melamine" appeal. Back of headboard in medium density wood particle with bevelled edges and finished with a wood, lime or matt lacquered effect. Cushions padded with polyurethane foam and pre-covered with polyester batting with removable fabric or eco-leather cover. Removable cover also available in leather, with technical fabric back. 100 mm thick bedframe in shaped stained solid wood, covered on the upper side. 40 mm thick storage bed frame with recessed sides and 45° corner joints, finished with wood, lime and metal effect or lacquered matt.*



Il letto Abbraccio Grafic permette molteplici soluzioni grazie all'abbinamento delle finiture "materiche", in questo caso tra il ring e il perimetro esterno dei contenitori notte Filo.

*The Abbraccio Grafic bed offers multiple solutions thanks to the combination of "melamine" finishes, as shown here between the frame and the outer perimeter of the Filo night storage units.*



# Folio



PIEDE – P – LEGNO



Misure materasso  
L/W x P/D

Misure materasso L/W x P/D	Ingombro letto L/W x P/D
1500 x 1900	1741 x 2110
1500 x 2000	1741 x 2210
1600 x 1900	1841 x 2110
1600 x 2000	1841 x 2210
1800 x 2000	2041 x 2210

PIEDE – V – METALLO



Misure materasso  
L/W x P/D

Misure materasso L/W x P/D	Ingombro letto L/W x P/D
1500 x 1900	1741 x 2110
1500 x 2000	1741 x 2210
1600 x 1900	1841 x 2110
1600 x 2000	1841 x 2210
1800 x 2000	2041 x 2210

CONTENITORE LEGNO



Misure materasso  
L/W x P/D

Misure materasso L/W x P/D	Ingombro letto L/W x P/D
1600 x 1900	1841 x 2071
1600 x 2000	1841 x 2171
1800 x 2000	2041 x 2171

Misure espresse in mm

Raffinatamente essenziale, questo letto ha la testiera in particelle di legno di media densità sagomata a 45° lungo i bordi e impiallacciata in Rovere o Noce. Giroletto per piedi spessore 100 mm in legno massello tinto, sagomato e rivestito sulla faccia superiore. Giroletto per contenitore spessore 40 mm, con sponde rientranti e giunzione a 45° negli angoli, impiallacciato in Rovere e Noce.

*Refined and minimalist, this bed has a headboard in medium-density particle board with bevelled edges in Oak or Walnut veneer. 100 mm thick bedframe in shaped stained solid wood, covered on the upper side. 40 mm thick storage bed frame with recessed sides and 45° corner joints, veneered in Oak or Walnut.*







La versatilità dei contenitori Cidori si esprime anche nella possibilità di realizzare delle composizioni bifacciali, con schienali e frontali rifiniti a 45°. Utilizzando moduli di uguale profondità e larghezza, è possibile sovrapporre più elementi anche di altezze diverse, orientando a piacere il senso di apertura dei cassetti.

*The versatility of Cidori storage units is realized in the possibility of creating double-sided compositions, with back and front panels finished with bevelled edges. Using modules of equal depth and width, it is possible to stack several elements of different heights, oriented to the opening direction of the drawer.*



## Folio Grafic



## PIEDE - V - METALLO



Misure materasso L/W x P/D	Ingombro letto L/W x P/D
1600 x 1900	1758 x 2050
1600 x 2000	1758 x 2150

## CONTENITORE LEGNO



Misure materasso L/W x P/D	Ingombro letto L/W x P/D
1600 x 1900	1758 x 2071
1600 x 2000	1758 x 2171

Misure espresse in mm

Il minimalismo di questo letto si arricchisce di particolari finiture "materiche". Testiera in particelle di legno di media densità sagomata a 45° lungo i bordi e nobilitata con effetto legno, calce o laccato opaco. Giroletto per piedi o contenitore spessore 40 mm, con sponde rientranti e giunzione a 45° negli angoli, nobilitato con effetto legno, calce o laccato opaco.

*The minimalism of this bed is enriched by special 'melamine' finishes. Head-board in medium-density particle board with bevelled edges and finished with a wood effect, lime wash or matt lacquer. 40 mm thick bed frame for storage with recessed sides and 45° corner joints, finished with a wood effect, lime wash or matt lacquer.*



Letto Folio Grafic con contenitori notte Insieme / Folio Grafic bed with Insieme night storage units



# Febo 1.0



PIEDI LEGNO



Misure materasso L/W x P/D	Ingombro letto L/W x P/D
1600 x 1900	1695 x 2140
1600 x 2000	1695 x 2240
1800 x 2000	1895 x 2240

PIEDI - X - METALLO



Misure materasso L/W x P/D	Ingombro letto L/W x P/D
1600 x 1900	1695 x 2140
1600 x 2000	1695 x 2240
1800 x 2000	1895 x 2240

CONTENITORE LEGNO



Misure materasso L/W x P/D	Ingombro letto L/W x P/D
1600 x 1900	1695 x 2140
1600 x 2000	1695 x 2240
1800 x 2000	1895 x 2240

Misure espresse in mm

Geometrie rigorose per questo letto con montanti laterali della testiera e del giroletto, anche per contenitore con sponde rientranti, realizzati in legno massello spessore 40 mm e impiallacciati in Rovere, con giunzioni a 45° tra pediera, longheroni e testiera. Le sagomature perimetrali del giroletto creano un piano inclinato verso l'interno che accoglie orizzontalmente la rete e verticalmente la testiera in particelle di legno a media densità, sempre impiallacciato Rovere.

*This bed features clean lines with side posts on the headboard and bed frame, also available in storage space option with recessed sides, made from 40 mm thick solid wood and oak veneer, with 45° joints between the footboard, side rails and headboard. The perimeter shapes create an inward sloping surface that horizontally accommodates the bed base and vertically accommodates the headboard, in medium density wood particles, in medium density wood particles and veneered in Oak.*



Letto Febo 1.0 in versione con o senza contenitore. Abbinamento con gruppo letto Abaco o con tavolini Trio  
/ Febo 1.0 bed in versions with or without storage unit. Combination with Abaco bed set or Trio side tables



# Febo 2.0 / Febo 2.0 High

Letto Febo 2.0 con contenitori notte Abaco / Febo 2.0 bed with Abaco night storage unit



Testiera in due versioni: la High è più alta per offrire il massimo comfort.  
/ Headboard in two versions: the High version is taller to offer maximum comfort

## PIEDI LEGNO



Misure materasso L/W x P/D	Ingombro letto L/W x P/D
1600 x 1900	1695 x 2160
1600 x 2000	1695 x 2260
1800 x 2000	1895 x 2260

## PIEDI - X - METALLO



Misure materasso L/W x P/D	Ingombro letto L/W x P/D
1600 x 1900	1695 x 2160
1600 x 2000	1695 x 2260
1800 x 2000	1895 x 2260

## CONTENITORE LEGNO



Misure materasso L/W x P/D	Ingombro letto L/W x P/D
1600 x 1900	1695 x 2160
1600 x 2000	1695 x 2260
1800 x 2000	1895 x 2260

Misure espresse in mm

Letto con montanti laterali della testiera e del giroletto, anche per contenitore con sponde rientranti, realizzati in legno massello spessore 40 mm, impiallacciato Rovere, con giunzioni a 45° tra pediera, longheroni e testiera. Le sagomature perimetrali creano un piano inclinato verso l'interno che accoglie orizzontalmente la rete e verticalmente la testata in particelle di legno a media densità. Quest'ultima è imbottita in poliuretano espanso sagomato, con rivestimento sfoderabile in tessuto, oppure non sfoderabile in ecopelle o pelle, con cuciture verticali e retrotestiera impiallacciata.

*Bed with side posts on the headboard and bed frame, also available with storage and recessed sides, made of 40 mm thick solid wood with 45° joints between the footboard, side rails and headboard, veneered in oak. The perimeter shapes create an inward sloping surface that horizontally accommodates the bed base and vertically accommodates the headboard, in medium density wood particles. The headboard is padded with shaped polyurethane foam, with a removable fabric cover, or a non-removable eco-leather or leather cover, with vertical stitching and a veneered back.*





## Aliante 1.0



## PIEDI LEGNO



Misure materasso L/W x P/D	Ingombro letto L/W x P/D
1600 x 1900	1772 x 2079
1600 x 2000	1772 x 2179
1800 x 2000	1972 x 2179

## PIEDI - X- METALLO - RING H90



Misure materasso L/W x P/D	Ingombro letto L/W x P/D
1600 x 1900	1772 x 2079
1600 x 2000	1772 x 2179
1800 x 2000	1972 x 2179

## PIEDI - X- METALLO - RING H150



Misure materasso L/W x P/D	Ingombro letto L/W x P/D
1600 x 1900	1772 x 2079
1600 x 2000	1772 x 2179
1800 x 2000	1972 x 2179

Misure espresse in mm

Linee fluide e morbide caratterizzano questo letto con testiera in multistrato, con doppia curvatura concava e convessa in senso sia orizzontale che verticale, impiallacciata in Rovere o Noce. Giroletto in particelle di legno a media densità, sempre impiallacciato Rovere o Noce: le sagomature perimetrali creano un piano inclinato verso l'interno che accoglie la rete.

*Fluid, soft lines characterise this bed with a multi-layer headboard, with double concave and convex curvature in both the horizontal and vertical directions, veneered in Oak or Walnut. Bed frame in medium density wood particles, veneered in Oak or Walnut: the perimeter shapes create an inward sloping surface that accommodates the bed base.*



Letto Aliante 1.0 retrofinito con contenitori notte Babila ugualmente retrofiniti / *Retro-finished Aliante 1.0 bed with Babila night storage units with same retro-finish*



# Aliante 2.0



PIEDE LEGNO  
– GIROLETTO H 90 IMPIALLACCIATO



Misure materasso L/W x P/D      Ingombro letto L/W x P/D

1600 x 1900	1780 x 2079
1600 x 2000	1780 x 2179
1800 x 2000	1980 x 2179

PIEDI – X– METALLO  
– GIROLETTO H 90 LACCATO O IMPIALLACCIATO



Misure materasso L/W x P/D      Ingombro letto L/W x P/D

1600 x 1900	1780 x 2079
1600 x 2000	1780 x 2179
1800 x 2000	1980 x 2179

PIEDI – X– METALLO  
– GIROLETTO H 150 LACCATO O IMPIALLACCIATO



Misure materasso L/W x P/D      Ingombro letto L/W x P/D

1600 x 1900	1780 x 2079
1600 x 2000	1780 x 2179
1800 x 2000	1980 x 2179

Misure espresse in mm

La testiera in multistrato, con doppia curvatura concava e convessa in senso sia orizzontale che verticale, è impiallacciata sui bordi in Rovere e Noce, laccata posteriormente e rivestita frontalmente in poliuretano espanso sagomato, con rivestimento non sfoderabile in ecopelle o pelle. Giroletto in particelle di legno a media densità impiallacciato Rovere, Noce o laccato, con sagomature perimetrali che creano un piano inclinato verso l'interno per accogliere la rete.

The multi-layer headboard with double concave and convex curvature in both horizontal and vertical directions is veneered on the edges in oak and walnut, lacquered on the back and covered on the front with shaped polyurethane foam, with a non-removable cover in eco-leather or leather. The bed frame is made of medium density wood particles veneered in oak, walnut or lacquered, with shaped edges that create an inward sloping surface to accommodate the bed base.





Letto Aliante 2.0 con contenitori notte Domino con maniglia dedicata / Aliante 2.0 bed with Domino night storage units with dedicated handle





## Nest



PIEDE LEGNO  
– GIROLETTO H 90 IMPIALLACCIATO



Misure materasso L/W x P/D	Ingombro letto L/W x P/D
1600 x 1900	1720 x 2039
1600 x 2000	1720 x 2139
1800 x 2000	1920 x 2139

PIEDI – X – METALLO  
– GIROLETTO H 90 LACCATO O IMPIALLACCIATO



Misure materasso L/W x P/D	Ingombro letto L/W x P/D
1600 x 1900	1720 x 2039
1600 x 2000	1720 x 2139
1800 x 2000	1920 x 2139

PIEDI – X – METALLO  
– GIROLETTO H 150 LACCATO O IMPIALLACCIATO



Misure materasso L/W x P/D	Ingombro letto L/W x P/D
1600 x 1900	1720 x 2039
1600 x 2000	1720 x 2139
1800 x 2000	1920 x 2139

Misure espresse in mm

È intimo e accogliente questo letto con testiera in legno e derivati, imbottita con poliuretano espanso a quote differenziate. Pre-rivestimento in ovatta di poliestere e rivestimento sfoderabile in tessuto, oppure non sfoderabile in ecopelle o pelle. Testiera confezionata con una cucitura longitudinale a cordoncino in corrispondenza delle bombature. Il rivestimento in pelle è in versione con retro testiera in tela tecnica o completamente in pelle. Giroletto in particelle di legno a media densità, impiallacciato Rovere o Noce oppure laccato opaco. Le sagomature perimetrali creano un piano inclinato verso l'interno che accoglie la rete.

*Intimate and inviting, this bed has a headboard crafted with wood and wood-derivatives, covered with polyurethane foam of differentiated thickness and polyester batting. Removable fabric or non-removable eco-leather or leather upholstery detailed with longitudinal piped seams that delineate the padding. The leather upholstery is available with a technical fabric back or entirely in leather. Bedframe is made with wood particles veneered in Oak or Walnut or matt lacquered. The perimeter shape creates an inward curvature that connects to the bedframe.*





Contenitori notte Virgola con top in vetro lucido / *Virgola night storage units with glossy glass top*



# Nest Imbottito



## PIEDI -X- METALLO



Misure materasso L/W x P/D	Ingombro letto L/W x P/D
1600 x 1900	1720 x 2039
1600 x 2000	1720 x 2139
1800 x 2000	1920 x 2139
1800 x 2100	1920 x 2239

## IMBOTTITO A TERRA



Misure materasso L/W x P/D	Ingombro letto L/W x P/D
1600 x 1900	1720 x 2039
1600 x 2000	1720 x 2139
1800 x 2000	1920 x 2139
1800 x 2100	1920 x 2239

## IMBOTTITO CON CONTENITORE



Misure materasso L/W x P/D	Ingombro letto L/W x P/D
1600 x 1900	1720 x 2039
1600 x 2000	1720 x 2139
1800 x 2000	1920 x 2139

Misure espresse in mm

Letto con testiera e giroletto, anche per contenitore, in legno e derivati, imbottiti con poliuretano espanso a quote differenziate, con pre-rivestimento in ovatta di poliestere.

Rivestimento sfoderabile in tessuto o non sfoderabile in ecopelle e pelle. Testiera confezionata con una cucitura longitudinale a cordoncino in corrispondenza delle bombature. Il rivestimento in pelle è in versione con retro testiera in tela tecnica o completamente in pelle. Giroletto con rivestimento sfoderabile in tessuto oppure non sfoderabile in ecopelle o pelle, con longheroni e pediera confezionati singolarmente.

Bed with headboard and bed frame, also suitable for a storage unit, made with wood and wood derivatives, padded with polyurethane foam of differentiated thicknesses and polyester batting.

Removable fabric or non-removable eco-leather and leather upholstery. Headboard with longitudinal piped seam that delineates the padding. The leather upholstery is available with a technical fabric back or entirely in leather. Bed frame with removable fabric cover or non-removable eco-leather or leather upholstery, with separate side rails and footboard.



# Milo



PIEDI – V – METALLO



Misure materasso L/W x P/D	Ingombro letto L/W x P/D
1600 x 1900	1841 x 2145
1600 x 2000	1841 x 2245
1800 x 2000	2041 x 2245
1800 x 2100	2041 x 2345

PIEDI – X – METALLO



Misure materasso L/W x P/D	Ingombro letto L/W x P/D
1600 x 1900	1841 x 2145
1600 x 2000	1841 x 2245
1800 x 2000	2041 x 2245
1800 x 2100	2041 x 2345

CONTENITORE LEGNO



Misure materasso L/W x P/D	Ingombro letto L/W x P/D
1600 x 1900	1841 x 2145
1600 x 2000	1841 x 2245
1800 x 2000	2041 x 2245
1800 x 2100	2041 x 2345

Misure espresse in mm

Letto con testiera in legno e derivati, composta da due maxi cuscini con meccanismo reclinabile a frizione, in poliuretano espanso a quote differenziate con pre-rivestimento in ovatta di poliestere. Rivestimento sfoderabile in tessuto, ecopelle o pelle. Cuscini confezionati con un cordoncino perimetrale, riportato anche nella cucitura longitudinale, che ne determina la bombatura. Giroletto spessore 40 mm per piede o per contenitore con sponde rientranti in particelle di legno a media densità, impiallacciato Rovere o Noce, nobilitato effetto legno, calce e metallo, oppure laccato opaco con unione a 45° negli angoli.

*Bed with headboard crafted with wood and wood derivatives, composed of two large cushions with a friction reclining clutch mechanism, padded with polyurethane foam of differentiated thickness and polyester batting. Removable cover in fabric, eco-leather and leather upholstery. Cushions crafted with a piped edge trim, repeated on the longitudinal seam of the padding. 40mm thick wood particle board bed frame for legs or storage unit with retracted sides, with 45° corner joints. Choices of finishes: Oak or Walnut, melamine faced limewashed wood effect, or matt lacquered.*





# Decor



### PIEDE IN METALLO



Misure materasso L/W x P/D	Ingombro letto L/W x P/D
1600 x 1900	1742 x 2144
1600 x 2000	1742 x 2244
1800 x 2000	1942 x 2244
1800 x 2100	1942 x 2344

### IMBOTTITO A TERRA



Misure materasso L/W x P/D	Ingombro letto L/W x P/D
1600 x 1900	1742 x 2144
1600 x 2000	1742 x 2244
1800 x 2000	1942 x 2244
1800 x 2100	1942 x 2344

### IMBOTTITO CON CONTENITORE



Misure materasso L/W x P/D	Ingombro letto L/W x P/D
1600 x 1900	1742 x 2144
1600 x 2000	1742 x 2244
1800 x 2000	1942 x 2244

Misure espresse in mm

Letto con testiera e giroletto, anche per contenitore, in legno e derivati, con imbottitura in poliuretano espanso a quote differenziate e pre-rivestimento in ovatta di poliestere. Rivestimento sfoderabile in tessuto o non sfoderabile in ecopelle e pelle. Rivestimento in pelle con retro testiera in tela tecnica, disponibile anche completamente in pelle. Cornice per testiera e piattine dei piedi anteriori in acciaio sagomato con taglio laser, impiallacciate in Rovere e Noce oppure verniciate metallo.

*Bed with headboard and bed frame, also available with storage, made with wood and wood derivatives, polyurethane foam padding of varying thicknesses and polyester batting. Removable fabric or non-removable eco-leather and leather upholstery. Leather upholstery available with technical fabric back or entirely in leather. Headboard frame and front foot plates in laser-cut shaped steel, veneered in Oak and Walnut or painted metal.*



Letto Decor con contenitori notte Status con top in ceramica / Decor bed with Status night storage units with ceramic top



## Cosy



## LETTO IMBOTTITO



Misure materasso  
L/W x P/D

1500 x 1900	2030 x 2210
1600 x 1900	2100 x 2210
1600 x 2000	2100 x 2310
1800 x 2000	2300 x 2310
1800 x 2100	2300 x 2410
1530 x 2030	2030 x 2340
1930 x 2030	2430 x 2340

## IMBOTTITO CON CONTENITORE



Misure materasso  
L/W x P/D

1600 x 1900	2100 x 2210
1600 x 2000	2100 x 2310
1800 x 2000	2300 x 2310

Con compensativo

Queen size  
King size

Misure espresse in mm

Ha una morbida presenza questo letto con struttura in legno e derivati, imbottita con poliuretano espanso a quote differenziate, con pre-rivestimento in ovatta di poliestere. Rivestimento sfoderabile in tessuto o non sfoderabile in ecopelle o pelle. Rivestimento in pelle con retro testiera in tela tecnica, disponibile anche completamente in pelle. Giroletto, anche per contenitore, in legno e derivati imbottito con poliuretano espanso a quote differenziate, con pre-rivestimento in ovatta di poliestere e rivestimento sfoderabile in tessuto, ecopelle o pelle.

*This bed has a soft presence with its wooden and wood-based frame, padded with polyurethane foam of differentiated thicknesses and polyester batting. Removable fabric or non-removable eco-leather or leather upholstery. Leather upholstery available with technical fabric back or entirely in leather. Bed frame, also available with storage unit, is made with wood particle board, padded with polyurethane foam of differentiated thicknesses and polyester batting with removable fabric, eco-leather or leather cover.*



Letto Cosy con contenitori notte Rondo. Sulla parete retrostante la boiserie a doppia profondità con luci a led verticali  
Di lato la composizione Itala Domino bifacciale

/ Cosy bed with Rondo nightstand storage units. On the wall behind, double-depth boiserie with vertical LED lights  
Adjacent, the double-sided Itala Domino composition





# Dorian



CON BASAMENTO IN METALLO



Misure materasso L/W x P/D	Ingombro letto L/W x P/D	
1500 x 1900	1655 x 2179	con compensativo
1600 x 1900	1725 x 2179	
1600 x 2000	1725 x 2279	
1800 x 2000	1925 x 2279	
1530 x 2030	1655 x 2309	Queen size
1930 x 2030	2055 x 2309	King size

IMBOTTITO CON CORNICE



Misure materasso L/W x P/D	Ingombro letto L/W x P/D	
1500 x 1900	1655 x 2179	con compensativo
1600 x 1900	1725 x 2179	
1600 x 2000	1725 x 2279	
1800 x 2000	1925 x 2279	
1530 x 2030	1655 x 2309	Queen size
1930 x 2030	2055 x 2309	King size

CONTENITORE CON CORNICE



Misure materasso L/W x P/D	Ingombro letto L/W x P/D
1600 x 1900	1725 x 2179
1600 x 2000	1725 x 2279
1800 x 2000	1925 x 2279

Misure espresse in mm

Un'estetica senza tempo caratterizza questo letto con testiera e giroletto, anche per contenitore, in legno e derivati, imbottiti con poliuretano espanso a quote differenziate con pre-rivestimento in ovatta di poliestere. Rivestimento sfoderabile in tessuto, ecopelle o pelle. Rivestimento in pelle con retro testiera in tela tecnica, disponibile anche completamente in pelle. Giroletto rastremato in altezza con rivestimento continuo. Basamento e cornice in alluminio estruso, con piedi in alluminio pressofuso in diverse finiture.

*Timeless aesthetic best describes this bed, with a headboard and footboard, also available with storage unit, made of wood and wood derivatives, polyurethane foam padding of differentiating thicknesses and polyester batting. Removable upholstery in fabric, eco-leather or leather. Leather upholstery is available with technical fabric back or entirely in leather. Bed frame has a tapered in height and continuous cover. Base and frame in extruded aluminium, with die-cast aluminium feet in various finishes.*



Letto Dorian con basamento in metallo sagomato e contenitori notte Rondo e specchiera Tape. Pareti rivestite con Boiserie modulare laccata opaca  
/ Dorian bed with shaped metal base, Rondo night storage units and Tape mirror. Walls covered with matt lacquered modular Boiserie



# Dorian Plano



## PIEDI IN METACRILATO O METALLO



## IMBOTTITO A TERRA



## IMBOTTITO CON CONTENITORE



Misure materasso  
L/W x P/D

Ingombro letto  
L/W x P/D

con compensativo

1500 x 1900	1637 x 2170
1600 x 1900	1707 x 2170
1600 x 2000	1707 x 2270
1800 x 2000	1907 x 2270
1800 x 2100	1907 x 2370
1530 x 2030	1637 x 2300
1930 x 2030	2037 x 2300

Misure materasso  
L/W x P/D

Ingombro letto  
L/W x P/D

con compensativo

1500 x 1900	1637 x 2170
1600 x 1900	1707 x 2170
1600 x 2000	1707 x 2270
1800 x 2000	1907 x 2270
1800 x 2100	1907 x 2370
1530 x 2030	1637 x 2300
1930 x 2030	2037 x 2300

Misure materasso  
L/W x P/D

Ingombro letto  
L/W x P/D

1600 x 1900	1707 x 2170
1600 x 2000	1707 x 2270
1800 x 2000	1907 x 2270

Misure espresse in mm

Letto con testiera e giroletto, anche per contenitore, in legno e derivati, imbottiti con poliuretano espanso a quote differenziate con pre-rivestimento in ovatta di poliestere. Rivestimento sfoderabile in tessuto, ecopelle o pelle. Rivestimento in pelle con retro testiera in tela tecnica, disponibile anche completamente in pelle. Giroletto squadrato con cucitura perimetrale.

Bed with headboard and bed frame, also suitable for storage, in wood and wood derivatives, padded with polyurethane foam of varying thicknesses and polyester batting. Removable cover in fabric, eco-leather or leather. Leather cover available with technical fabric back or entirely in leather. Square bed frame with edge stitching.





# Peplo



PIEDE – P – LEGNO



PIEDE – V – METALLO



Misure materasso  
L/W x P/D

Ingombro letto  
L/W x P/D

1500 x 1900	1967 x 2262	con compensativo
1600 x 1900	2037 x 2262	
1600 x 2000	2037 x 2362	
1800 x 2000	2237 x 2362	
1800 x 2100	2237 x 2462	
1530 x 2030	1967 x 2392	Queen size
1930 x 2030	2367 x 2392	King size

Misure materasso  
L/W x P/D

Ingombro letto  
L/W x P/D

1500 x 1900	1967 x 2262	
1600 x 1900	2037 x 2262	
1600 x 2000	2037 x 2362	
1800 x 2000	2237 x 2362	
1800 x 2100	2237 x 2462	
1530 x 2030	1967 x 2392	Queen size
1930 x 2030	2367 x 2392	King size

Misure espresse in mm

Realizzazione sartoriale per questo letto con testiera in legno e derivati, imbottita con poliuretano espanso a quote differenziate, con pre-rivestimento in ovatta di poliestere.

Rivestimento testiera sfoderabile in tessuto o non sfoderabile in ecopelle o pelle, con cuciture verticali e confezione con "reverse" perimetrale. Rivestimento in pelle con retro testiera in tela tecnica, disponibile anche completamente in pelle. Giroletto per piede di spessore 100 mm in legno massello tinto sagomato, lato superiore imbottito in poliuretano espanso con rivestimento non sfoderabile in tessuto continuo, oppure ecopelle o pelle con cuciture aggiuntive.

*This bed is tailor-made with a headboard in wood and wood derivatives, padded with polyurethane foam of varying thicknesses and polyester batting. The headboard cover is available in removable fabric or non-removable eco-leather or leather, with vertical stitching and "reverse" edge finish. Leather upholstery is available with technical fabric back or entirely in leather. 100 mm thick bed frame in shaped stained solid wood, upper side padded with polyurethane foam with non-removable upholstery in continuous fabric, or eco-leather or leather with additional stitching.*





# Peplo Imbottito



## GIROLETTO IMBOTTITO



Misure materasso L/W x P/D	Ingombro letto L/W x P/D
1500 x 1900	1967 x 2266
1600 x 1900	2037 x 2266
1600 x 2000	2037 x 2366
1800 x 2000	2237 x 2366
1800 x 2100	2237 x 2466
1530 x 2030	1967 x 2396
1930 x 2030	2367 x 2396

Misure espresse in mm

## GIROLETTO IMBOTTITO CON CONTENITORE



Misure materasso L/W x P/D	Ingombro letto L/W x P/D
1600 x 1900	2037 x 2266
1600 x 2000	2037 x 2366
1800 x 2000	2237 x 2366

Letto con testiera in legno e derivati, imbottita con poliuretano espanso a quote differenziate, con pre-rivestimento in ovatta di poliestere. Rivestimento testiera sfoderabile in tessuto o non sfoderabile in ecopelle o pelle, con cuciture verticali e confezione con "reverse" perimetrale. Rivestimento in pelle con retro testiera in tela tecnica, disponibile anche completamente in pelle. Giroletto con rivestimento sfoderabile in tessuto, ecopelle o pelle.

*Bed with headboard in wood and wood derivatives, padded with polyurethane foam of varying thicknesses and polyester batting. Headboard cover in removable fabric or non-removable eco-leather or leather, with vertical stitching and 'reverse' edge finish. Leather cover available with a technical fabric back or entirely in leather. Bed frame with removable cover in fabric, eco-leather or leather.*



Letto Peplo Imbottito con contenitori notte Valeo / Padded Peplo bed with Valeo night storage units



# Gaston



CON BASAMENTO IN METALLO



Misure materasso  
L/W x P/D

Misure materasso L/W x P/D	Ingombro letto L/W x P/D	con compensativo
1500 x 1900	1980 x 2109	
1600 x 1900	2050 x 2109	
1600 x 2000	2050 x 2209	
1800 x 2000	2250 x 2209	
1800 x 2100	2250 x 2309	
1530 x 2030	1980 x 2239	Queen size
1930 x 2030	2380 x 2239	King size

IMBOTTITO CON CORNICE



Misure materasso  
L/W x P/D

Misure materasso L/W x P/D	Ingombro letto L/W x P/D	con compensativo
1500 x 1900	1980 x 2109	
1600 x 1900	2050 x 2109	
1600 x 2000	2050 x 2209	
1800 x 2000	2250 x 2209	
1800 x 2100	2250 x 2309	
1530 x 2030	1980 x 2239	Queen size
1930 x 2030	2380 x 2239	King size

CONTENITORE CON CORNICE



Misure materasso  
L/W x P/D

Misure materasso L/W x P/D	Ingombro letto L/W x P/D
1600 x 1900	2050 x 2109
1600 x 2000	2050 x 2209
1530 x 2030	2250 x 2209

Misure espresse in mm

Letto con testiera in legno e derivati, imbottita con poliuretano espanso a quote differenziate, con pre-rivestimento in ovatta di poliestere. Rivestimento sfoderabile in tessuto, ecopelle o pelle con cuciture verticali e confezione con "reverse" perimetrale. Rivestimento in pelle con retro testiera in tela tecnica, disponibile anche completamente in pelle. Giroletto rastremato in altezza con rivestimento continuo. Basamento e cornice in alluminio estruso, con piedi di alluminio pressofuso in diverse finiture.

Bed with headboard in wood and wood derivatives, padded with polyurethane foam of varying thicknesses and polyester batting. Removable cover in fabric, eco-leather or leather with vertical stitching and "reverse" edge finish. Leather cover available with technical fabric back or entirely in leather. Tapered bed frame with continuous cover. Extruded aluminium base and frame, with die-cast aluminium legs in various finishes.



Letto Gaston con basamento in metallo sagomato e contenitori notte Domino / Gaston bed with shaped metal base Domino night storage units



# Gaston Plano



PIEDE METACRILATO O METALLO



IMBOTTITO CON CORNICE



CONTENITORE CON CORNICE



Misure materasso L/W x P/D  
Ingombro letto L/W x P/D

1500 x 1900	1980 x 2100	con compensativo
1600 x 1900	2050 x 2100	
1600 x 2000	2050 x 2200	
1800 x 2000	2250 x 2200	
1800 x 2100	2250 x 2300	
1530 x 2030	1980 x 2230	Queen size
1930 x 2030	2380 x 2230	King size

Misure materasso L/W x P/D  
Ingombro letto L/W x P/D

1500 x 1900	1980 x 2100	con compensativo
1600 x 1900	2050 x 2100	
1600 x 2000	2050 x 2200	
1800 x 2000	2250 x 2200	
1800 x 2100	2250 x 2300	
1530 x 2030	1980 x 2230	Queen size
1930 x 2030	2380 x 2230	King size

Misure materasso L/W x P/D  
Ingombro letto L/W x P/D

1600 x 1900	2050 x 2100
1600 x 2000	2050 x 2200
1800 x 2000	2250 x 2200

Misure espresse in mm

Letto con testiera e giroletto, anche per contenitore, in legno e derivati imbottiti con poliuretano espanso a quote differenziate con pre-rivestimento in ovatta di poliestere. Rivestimento sfoderabile in tessuto, ecopelle e pelle. Testiera confezionata con una cucitura longitudinale in corrispondenza delle bombature. Rivestimento in pelle con retro testiera in tela tecnica disponibile anche con la stessa finitura della parte frontale. Giroletto squadrato con cucitura perimetrale.

Bed with headboard and bed frame, also available with storage unit, in wood and derivatives padded with polyurethane foam of different thicknesses and polyester batting. Removable cover in fabric, eco-leather and leather. Leather upholstery is available with a technical fabric back or entirely in leather. Headboard made with a longitudinal seam at the curves. Square bed frame with edge stitching.



# Contenitori notte

Domino Mono	328	Cabaret One	348
Domino Componibile	330	Cabaret Glass	350
Cidori Mono	336	Rondo	352
Cidori Componibile	338	Virgola	354
Abaco	340	Babila	356
Filo Mono	342	Valeo	358
Filo Open	344	Status	360
Filo Componibile	346	Insieme	362



Domino Notte  
L/W 1500 x H 825 x P/D 546



# Domimo Mono

Comodini a 2 cassetti

H 327 L/W 450/600/900 P/D 452  
H 402 L/W 450/600/900 P/D 452  
H 477 L/W 450/600/900 P/D 452

Comodini a 3 cassetti

H 477 L/W 450/600 P/D 452

Cassettoni verticali

H 1152 L/W 450/600 P/D 452

Cassettoni

H 627 L/W 900/1200/1500 P/D 546  
H 702 L/W 900/1200/1500 P/D 546

Ingombri in altezza calcolati  
con piedini H 27 mm



Volumi corposi ed essenziali, sottolineati da giunzioni a 45°, caratterizzano la collezione Domimo. L'angolazione enfatizza la presenza monolitica dei contenitori, addolcita da sottili rientri che nella versione impiallacciata possono essere evidenziati da finiture in contrasto, oppure quasi scomparire con finiture in tinta. La possibilità di aggiungere degli affusolati piedini metallici arricchisce ulteriormente il contenitore.

*Essential generous volumes, emphasised by 45° joints delineates the Domimo collection. The angle emphasises the monolithic presence of the units, softened by subtle recesses which, in the veneered version, can be accentuated by contrasting finishes or almost disappear with matching finishes. The option of adding tapered metal legs further enhances the unit.*

Domino Notte 24N  
L/W 1500 x H 750 x P/D 546

## Domino Componibile



Moduli sovrapposti o accostati differenziano l'estetica e l'utilizzo dei vari cassetti, permettendo di individuare a prima vista i contenuti, ma anche di creare dei complementi d'arredo di forte e originale carattere, con contrasti decisi tra le finiture e i colori. I piedini metallici possono aggiungere un ulteriore elemento di personalità, enfatizzando lo slancio verticale dell'insieme.

*Stacked or side-by-side modules appropriates the look and use of the various drawers, allowing you to identify contents at a glance, and at the same time create original and bold pieces, with striking contrasts between finishes and colours. Adding metal legs can further emphasize the vertical structure of the composition.*

# Dominio componibile notte

	L/W 450	L/W 600	L/W 750	L/W 900
H 150				
H 225				
H 300				
H 375				
H 450				
H 600				
H 675				

L/W 1200	L/W 1500	L/W 1800 / 2100

Progettato per la zona notte, questo raffinato sistema di contenitori con cassetti trova spazio e utilizzo anche nella zona giorno, con l'aggiunta di contenitori con ante dal disegno classico e minimale al tempo stesso. Singoli elementi possono essere accostati o sovrapposti, per creare architetture domestiche in scala ridotta.

*Designed for the bedroom, this refined system of storage units with drawers can also be used in the living area, with the addition of classic minimalist doors. Individual elements can be placed side by side or stacked on top of each other to create small architectural compositions.*



Cassettone Cidori Mono  
L/W 1200 x H 735 x P/D 537



# Cidori Mono

Comodini a 2 cassetti

H 390 L/W 450/537/600/900 P/D 450  
H 470 L/W 450/537/600/900 P/D 450

Cassettoni verticali

H 1190 L/W 450/537/600/900 P/D 450

Cassettoni

H 735 L/W 900/1200 P/D 537

Cassettone curvo con cassetto

H 318 P/D 512



I contenitori Cidori sono caratterizzati da frontali e schienali rialzati che incorniciano, come in un vassoio personalizzabile, il top in vetro laccato lucido o satinato. Nella versione Cidori Mono, i fianchi sono interi e i cassetti con apertura a gola creano delle linee orizzontali che diventano il leitmotiv estetico dell'intera collezione.

*Cidori storage units feature raised front and back panels that frame the glossy or satin-finish lacquered glass top to create a customisable tray. The Cidori Mono version has full side panels and drawers with a grip profile, creating horizontal lines that become the aesthetic leitmotif of the entire collection.*

Cassettoni Cidori Componibile

L/W 900 x H 165 x P/D 450

L/W 1800 x H 165 x P/D 450

L/W 1200 x H 280 x P/D 450



# Cidori Componibile

Monocassetti componibili

H 165/200 L/W 450/537/600/900/1200/1500/1800/2400 P/D 450/537

H 245/280 L/W 450/537/600/900/1200/1500/1800/2400 P/D 450/537



Cidori si ispira liberamente a un tradizionale sistema giapponese di costruzioni. Gli elementi combinati l'uno con l'altro creano sovrapposizioni di volumi e composizioni solo apparentemente casuali, dall'appeal originale e irresistibile. I moduli impilati sono dotati di bordi gommosi a forte attrito, atti ad evitare lo spostamento accidentale dei singoli elementi.

*Inspired by a traditional Japanese building system, the Cidori elements combine to create overlapping volumes and seemingly random compositions with original and irresistible appeal. The stacked modules have rubber edges designed to prevent movement of the individual elements.*

Cassettone Abaco  
L/W 1380 x H 700 x P/D 537



# Abaco

Comodini a 2 cassetti

H 370 L/W 450/600 P/D 450  
H 450 L/W 450/600 P/D 450

Comodini a 3 cassetti

H 535 L/W 450/600 P/D 450

Cassettoni verticali

H 1112 L/W 450/600/750 P/D 450

Cassettoni

H 700 L/W 1380/1530 P/D 537  
H 780 L/W 1380/1530 P/D 537



Un'articolata famiglia di contenitori, contrassegnati da inserti verticali con finitura laccata o in legno. I segni a 45° che indicano l'apertura dei cassetti possono essere decisi, con l'utilizzo di colori a contrasto, oppure diventare giochi d'ombra scanditi dalla matericità dell'essenza tono su tono.

*A versatile family of storage units, featuring vertical grooves with a lacquered or wood finish. The drawer-opening profiles can be bold, using contrasting colours, or create a shadow effect with the texture of tone-on-tone wood.*

Cassettone Filo mono  
L/W 1490 x H 765 x P/D 527



## Filo Mono

Comodini a 2 cassetti

H 435 L/W 440/590/740 P/D 440

Cassettone verticale

H 1185 L/W 440/590/740 P/D 440

Cassettoni

H 685 L/W 1190/1490 P/D 527

H 765 L/W 1190/1490 P/D 527



Un linguaggio contemporaneo ed essenziale definisce questi contenitori, nei quali il top e i fianchi a filo dei cassetti si vestono con finiture materiche e laccate. I frontali sono interrotti dal semplice e delicato segno orizzontale delle maniglie, con finitura in tinta oppure a contrasto. Un concetto declinato nei volumi e nelle tipologie tipiche dell'ambiente notte: comodini, comò e cassettiere verticali. Il perimetro esterno è proposto nelle finiture materiche e laccate, mentre il top e lo zoccolo sono in finitura materica, essenza o laccato.

*Contemporary and essential describe these storage units, in which the top and sides flush with the drawers with melamine and lacquered finishes. The fronts are visually interrupted by the simple delicate horizontal line of the handles, with matching or contrasting finishes. A concept developed for the spaces and arrangements of typical bedrooms: bedside tables, chests of drawers and vertical drawer units. The external perimeter is available in melamine and lacquered finishes, while the top and base are available in melamine, wood or lacquered finishes.*

Cassettone Filo open  
L/W 1190 x H 935 x P/D 527



# Filo Open

Comodini a 2 cassetti con vano a giorno

H 435 L/W 740/890 P/D 440

Cassettoni con vano a giorno

H 765 L/W 1190/1340/1640 P/D 440/527  
H 935 L/W 1040/1190 P/D 440/527



Una sequenza di pieni e di vuoti, caratterizzata dall'alternarsi delle finiture, è il concetto che guida questa famiglia di comodini e cassetiere orizzontali o verticali. I generosi vani a giorno possono essere a loro volta suddivisi in spazi più piccoli, dedicati a specifiche necessità di contenimento. I cassetti, dotati di presa laterale per l'apertura, contribuiscono all'estetica e alla funzionalità dell'insieme.

*A sequence of covered and empty spaces, characterised by alternating finishes, is the distinguishing concept of this family of bedside tables and horizontal or vertical drawer units. The generous open compartments can be subdivided into smaller spaces for specific storage needs. The drawers, equipped with grip profiles for opening, contribute to the overall aesthetics and functionality of the piece.*

Cassettone Filo componibile  
L/W 1490 x H 806 x P/D 527



# Filo Componibile

Monocassetti componibili

H 165/190 L/W 440/590/740/890/1190/1490 P/D 440/527  
H 245/270 L/W 440/590/740/890/1190/1490 P/D 440/527



Volumi minimali, monolitici o disallineati che arredano lo spazio notte ma si prestano anche a diverse altre ambientazioni, grazie alla loro essenzialità e alla possibilità di utilizzare materiali tecnici che li rendono multiuso.

*Minimalist, stacked or staggered elements furnish the bedroom, but are also suitable for various settings, thanks to their simplicity and options of technical materials for multi-purpose use.*

Cassettiera Cabaret  
L/W 1520 x H 755 x P/D 570



# Cabaret One

Comodini monocassetto con vano a giorno

H 462/515 L/W 470/620/770 P/D 475

Comodini a 2 cassetti

H 382/435 L/W 470/620/770 P/D 475  
H 462/515 L/W 470/620/770 P/D 475

Cassettiere pensili

H 355 L/W 470/620/770 P/D 495  
H 515 L/W 920/1220/1520/1820 P/D 495

Cassettoni

H 702/755 L/W 1220/1520/1820 P/D 570  
H 782/835 L/W 1220/1520/1820 P/D 570

Cassettoni verticali

H 1182/1235 L/W 470/620/770 P/D 475



Un'ampia famiglia di contenitori che nonostante il loro sapiente rigore formale, permettono numerose variazioni cromatiche e abbinamenti di finiture. La loro principale caratteristica è il perimetro rialzato che incornicia il top sui fianchi e sul retro, creando una specie di vassoio. Il primo cassetto e la scocca possono avere una finitura diversa, aumentando la percezione di orizzontalità dell'elemento. Disponibili in versione con appoggio a terra, su piedini sagomati oppure pensile.

*A large family of storage units balancing precise form with numerous combinations of colour variations and finishes. Their main feature is the raised edge that frames the top on the sides and back, creating a tray effect. The first drawer and the top can have different finishes, enhancing the horizontal perception of the element. Available in floor-standing, shaped foot or wall-mounted versions.*

Cassettiera Cabaret glass  
L/W 920 x H 1235 x P/D 475



## Cabaret Glass

### Comodini monocassetto

H 427/480 L/W 470/620/920 P/D 475

### Cassettiere pensili

H 320 L/W 470/620/770 P/D 495  
H 400 L/W 470/620/770 P/D 495  
H 515 L/W 1220/1520/1820/212 P/D 495

### Comodini a 2 cassetti

H 507/560 L/W 470/620/920 P/D 475

### Cassettoni

H 702/755 L/W 1220/1520/1820 P/D 570  
H 782/835 L/W 1220/1520/1820 P/D 570

### Cassettoni verticali

H 1182/1235 L/W 470/620/920 P/D 475



Linee essenziali e armoniose proporzioni fra pieni e vuoti, si arricchiscono di un elemento in più: il piano in vetro a tutta larghezza che crea una raffinata teca, nella quale gli oggetti più preziosi e speciali si mettono in bella vista. Disponibile in diverse dimensioni e configurazioni, grazie alla modularità del sistema, in versione a terra, con piedini sagomati o pensile.

*Essential lines and harmonious proportions between solid and empty spaces are enriched by an additional element: the full-width glass top that creates a refined display case in which your most precious and special objects can be beautifully showcased. Available in different sizes and configurations thanks to the modularity of the system, as a floor-standing version with shaped feet or as a wall-mounted unit.*



# Rondo

Comodino

H 490    Ø 465

Cassettone

H 752    L/W 1500    P/D 514



Una versatile collezione di contenitori dai volumi arrotondati, con perimetro esterno in multistrato curvato. Lo zoccolo è dotato di piedini regolabili annessi nello spessore ed è rivestito con una nobilitazione sintetica. Il top, in particelle di legno a media densità, è anch'esso nobilitato in diverse tonalità laccate opaco, lucido o metallo, oppure in ceramica. I contenitori sono finiti anche sul retro e quindi possono essere posizionati in centro stanza.

*A versatile collection of storage units with rounded form and curved plywood edges. The base is fitted with adjustable legs and covered with a synthetic finish. The top, crafted with wood particle board, is finished in various matt, glossy or metallic lacquered shades, or available in ceramic. The storage units are fully finished, even on the back, perfect for center of the room arrangement.*

Cassettiera Virgola  
L/W 1520 x H 755 x P/D 570



# Virgola

Comodini 2 cassetti

H 494 L/W 560 P/D 460

Cassettone 4 cassetti

H 714 L/W 1520 P/D 566

Cassetto 6 cassetti

H 767 L/W 1520 P/D 566



Hanno una personalità speciale questi contenitori con frontali in multistrato curvato e fianchi in legno a media densità, impiallacciati in legno con venature verticali che creano un dinamico effetto visivo. I top sono disponibili in ceramica oppure in vetro laccato satinato o lucido. L'apertura del primo cassetto è ricavata dallo scuretto superiore che si crea tra top e frontale, mentre gli altri cassetti vengono aperti con un meccanismo push-pull.

*These storage units have a special personality, with curved multilayer fronts and medium density wood sides, veneered with vertical wood grain to create a dynamic visual effect. The tops are available in ceramic or satin or glossy lacquered glass. The first drawer is opened by lifting the upper flap between the top and the front, while the other drawers are opened with a push-pull mechanism.*

Cassettone Babila  
L/W 1298 x H 765 x P/D 556



# Babila

Comodino

H 465 L/W 580 P/D 469

Cassettone

H 765 L/W 1298 P/D 556

Cassettone verticale

H 1185 L/W 580 P/D 469



I contenitori Babila sono contraddistinti dalle forme arrotondate e dal profilo superiore a salire rispetto al top, il quale a sua volta mette in evidenza il suo spessore, sporgendo rispetto al bordo del cassetto superiore. Il taglio verticale per l'apertura dei cassetti è un altro segno distintivo di questo progetto. L'impiallacciatura in legno avvolge completamente il mobile, abbracciandolo senza soluzione di continuità.

*Babila storage units feature rounded forms and a raised upper profile with a pronounced thickness that protrudes from the edge of the top drawer. Vertical grip profiles allow for easy drawer opening, while distinct wood veneer wraps the unit in a continuous embrace.*

Cassettone Valeo  
L/W 1500 x H 720 x P/D 569



# Valeo

Contenitori a 1 cassetto

H 240/267 L/W 450/600/750/900/1200/1500 P/D 473/569

Contenitori a 3 cassetti

H 480/507 L/W 450/600/750 P/D 473/569

Cassettoni verticali

H 1227 L/W 450/600 P/D 473

Contenitori a 2 cassetti

H 320/347 L/W 450/600/750 P/D 473  
H 400/427 L/W 450/600/750 P/D 473

Cassettoni

H 667 L/W 1200/1500 P/D 569  
H 747 L/W 1200/1500 P/D 569



Estetica minimale per questa serie di cassettiere modulari, in cui elementi singoli o composti possono sviluppare forme d'arredo originali. Gli spessori generosi dei frontali si abbinano a piani sottili, con un effetto armonioso e piacevole.

*Minimalist but creative series of modular drawer units, in which individual or composite elements can be used to create original storage solutions. The generous thickness of the fronts combined with thin tops create a harmonious and versatile effect.*

Cassettone Status  
L/W 1200 x H 747 x P/D 569



# Status

Comodini a 2 cassetti

H 427 L/W 600/750 P/D 473

Cassettoni

H 747 L/W 1200/1500 P/D 569

Cassettone verticale

H 1227 L/W 450/600 P/D 473



Cassettiere dal design sobrio ed elegante, caratterizzate dai frontali di forte spessore con presa laterale per l'apertura e dal top in ceramica, materiale resistente all'usura, ai graffi e agli agenti esterni, in un'ampia gamma di finiture che riprendono l'estetica del marmo e della pietra. Molteplici sono gli abbinamenti possibili con colori laccati ed essenze, per armonizzarsi con ogni contesto stilistico e desiderio personale.

*A simple and elegant collection of draw units, featuring thick fronts, lateral grip profiles and ceramic tops, a material resistant to wear, scratches and the environment. Available in a wide range of finishes that recall the marble and stone aesthetic, with many possible combinations of lacquered colours and woods to guarantee a harmonious complement to any style or preference.*

Cassettone Insieme  
L/W 1500 x H 667 x P/D 569



# Insieme

Comodini a 2 cassetti

H 427 L/W 450/600 P/D 473

Cassettone verticale

H 987 L/W 900 P/D 473

Cassettoni

H 667 L/W 1200/1500 P/D 569  
H 747 L/W 1200/1500 P/D 569



La collezione Insieme definisce la sua forza espressiva nella variabilità degli spessori dei frontali e la sua originalità nell'accostamento dei materiali cromatici e materici. Insieme è versatile anche nelle altezze dei capienti cassetti, pensati per mantenere in perfetto ordine il loro contenuto.

*The Insieme collection is defined by the various front thicknesses and original combinations of colours and materials. Insieme also offers various available heights and spacious drawers, designed for perfect content organisation.*

# Tavolini



# Fiocco

**BASAMENTO / BASE**  
Laccato opaco

**PIANO / TOP**  
Rovere Tinto / Termotrattato  
Noce Canaletto  
Laccato opaco  
Ceramica

Tavolino Fiocco alto / *high*  
Ø 450 x H 460

Tavolino Fiocco medio / *medium*  
Ø 600 x H 370

Tavolino Fiocco alto / *high*  
Ø 500 x H 460

Tavolino Fiocco basso / *low*  
Ø 900 x H 300

# Lotus



**BASAMENTO / BASE**  
Epossidico Brown / Palladio / Piombo  
Verniciato Brown / Palladio / Piombo

**PIANO / TOP**  
Rovere Tinto / Termotrattato  
Noce Canaletto  
Laccato opaco / lucido / Metallo  
Ceramica

**VASSOIO METALLO / METAL TRAY**  
Epossidico Brown / Palladio / Piombo  
Verniciato Brown / Palladio / Piombo

Tavolino Lotus alto / *high*  
Ø 500 x H 500

Tavolino Lotus basso / *low*  
Ø 900 x H 365

Tavolino Lotus medio / *medium*  
Ø 600 x H 440

Tavolino Lotus con vassoio / *with tray*  
Ø 515 x H 440  
Ø 515 x H 500

# Uno



**BASAMENTO / BASE**  
Laccato opaco

**PIANO CON BORDO SAGOMATO / TOP WITH ROUNDED EDGE**  
Rovere Tinto  
Laccato opaco  
**SOTTOPIANO E BORDO / UNDERSIDE AND EDGE**  
Laccato Opaco

**PIANO CON BORDO SMUSSATO / TOP WITH BEVELED EDGE**  
Ceramica

Tavolino Uno alto / *high*  
Ø 450 x H 430

Tavolino Uno basso / *low*  
Ø 900 x H 285

Tavolino Uno medio / *medium*  
Ø 600 x H 380

# Iris



**BASAMENTO / BASE**  
Epossidico Brown / Palladio / Piombo  
Verniciato Brown / Palladio / Piombo  
Nikel black lucido

**PIANO / TOP**  
Rovere Tinto / Termotrattato  
Noce Canaletto  
Laccato opaco / lucido / Metallo  
Ceramica

Tavolino Iris  
L/W 1400 x H 475 x P/D 700

Tavolino Iris medio / *medium*  
Ø 600 x H 475

Tavolino Iris alto / *high*  
Ø 500 x H 525

## Trio

PIANO E PIEDI / *TOP AND FEET*  
Laccato opaco / Metallo



Tavolino Trio alto / *high*  
Ø 500 × H 464

Tavolino Trio basso / *low*  
Ø 900 × H 305

Tavolino Trio medio / *medium*  
Ø 600 × H 400

## Giro

PIANO E PIEDI / *TOP AND FEET*  
Laccato opaco / Metallo



Tavolino Giro  
Ø 440 × H 550

## Madera

BASAMENTO E PIANO / *BASE AND TOP*  
Rovere Termotrattato



Tavolino Madera alto / *high*  
Ø 460 × H 510

Tavolino Madera basso / *low*  
Ø 610 × H 370

**ART DIRECTION**

Nicoletta Cappello

**GRAPHIC DESIGN**

studio FM milano

**PHOTOGRAPHY**

Franco Chimenti

Marco Covi

Riccardo Pasciucco

**IMAGES**

Nudesign

Inside

**COLOUR SEPARATION**

Lucegroup

**PRINT**

Grafiche Antiga



Le misure riportate delle composizioni riguardano l'ingombro totale da terra e sono espresse in millimetri.

*The measurements shown for the compositions refer to the total size and are expressed in millimetres.*

**MOBILIFICIO  
SANGIACOMO SPA**

Via Gallopat, n° 33  
Cecchini di Pasiano  
33087 – (PN) Italia

**T** +39 0434 6291 r.a.

**E** [sg\\_info@msg.it](mailto:sg_info@msg.it)

**W** [www.msg.it](http://www.msg.it)

Servizio Clienti

**E** [ordinisg@msg.it](mailto:ordinisg@msg.it)

International Department

**E** [sg\\_int@msg.it](mailto:sg_int@msg.it)

L'azienda si riserva di introdurre senza preavviso eventuali modifiche tecnico-costruttive sul prodotto e sulle composizioni presentate.

*The Company reserves the right to make any technical or construction modifications to the products or to the layouts shown without prior notice.*

199C8MA02 Night Project



