

Day Collection

Complements

SANGIACOMO

Day Collection Complements

SANGIACOMO presenta la sua collezione di complementi: madie, tavoli, sedie, tavolini e scrittoi pensati per completare la zona giorno, valorizzandone l'estetica e arricchendone la vivibilità. Una proposta che esplora diverse correnti stilistiche: dal molteplice gioco di linee e volumi, vuoti e pieni delle madie Domino, alla raffinata eleganza e dinamica versatilità delle madie Cabaret, alle altre madie presentate in inedite versioni, con piedi in varie tipologie, dimensioni e finiture a seconda del modello. Anche i materiali offrono una scelta completa e attuale, spaziando dalle finiture metalliche, ai top e frontali in ceramica, ai nuovi e seducenti colori. Tavoli caratterizzati da forme essenziali e finiture pregiate, sedute che uniscono design e comfort, scrittoi che introducono diverse funzioni nello spazio living, sono gli altri complementi di un progetto coordinato, armonioso e ricchissimo di idee.

SANGIACOMO presents its collection of accessories: sideboards, tables, chairs, small tables and desks designed to complete the living area, enhancing its aesthetics and enriching its liveability. A collection that explores different stylistic trends: from the multiple play of lines and volumes, empty and solid areas of Domino sideboards, to the refined elegance and dynamic versatility of Cabaret sideboards, to the other sideboards presented in new versions, with various types, sizes and finishes of feet, depending on the model. There is also a complete, contemporary choice of materials, ranging from metallic finishes, to ceramic tops and front panels, to new and seductive colours. Tables with minimalist forms and fine finishes, seating that combines design and comfort, desks that introduce diverse functions to the living space - these are the other accessories of a coordinated, harmonious project full of ideas.

Indice / Index



Domino Clino
p 4



Domino Mono
p 14



Domino IN.2
p 26



Domino IN.3
p 44



Domino Più
p 54



Domino Giro
p 62



Cabaret
p 72



Cabaret Ceramica
p 102



Cidori
p 110



Abaco
p 120



Vela
p 128



Scrigno
p 142



Incontro
p 152



Lampo Deluxe
p 168



Lampo Basic
p 174



Lampo Open
p 178



Obi - Vertigo
p 188 - 200



Bistrot
p 212



Desco
p 220



Iron
p 234



Convivio
p 244



Linda
p 256



Eva
p 258



Eva con Braccioli
p 260



Alice
p 262



Charlotte
p 264



Lotus
p 266



Iris
p 272



Trio
p 276



Madera
p 280



Giro
p 284



Desk
p 286



Segreto
p 290

Domino clino

Caratterizzati dall'inclinazione che crea un originale gioco visivo, i contenitori Domino Clino possono essere interpretati come elementi singoli o componibili a piacere, anche grazie alla possibilità di disporli su due versi. I frontali sono in modularità L 300 – 375 mm, con altezze H 1200 e 1500 mm. Nell'immagine, un abbinamento di sapore glamour fra l'esterno in finitura Rovere Carbone e l'interno laccato Ottone.

Featuring a slanting angle that creates an original visual effect, Domino Clino storage units can be interpreted as single or modular elements as preferred, thanks to the possibility of mounting them on either direction. The front panels are modular W 300 – 375 mm, with heights H 1200 and 1500 mm. In the image, a glamorous combination of the exterior in Rovere Carbone finish and the interior in Ottone lacquer.





Domino Clino è un progetto concepito per creare le più diverse composizioni, caratterizzando qualsiasi spazio con la sua scenografica presenza, in un gioco di volumi e geometrie sfalsate. La finitura metallica laccato Bronzo ricorda un'opera d'arte contemporanea.

Domino Clino is a design conceived to create the most diverse compositions, bringing its striking presence to any space, in a play of staggered volumes and geometries. The lacquered metallic finish in Bronzo recalls a contemporary work of art.



Un progetto dinamico che si presta alle più diverse composizioni di colori e volumi. In questo caso abbiamo una giustapposizione di elementi in finitura laccato opaco Grigio Corda, Avio, Salvia, Visone e Terranova.

A dynamic design suited to the most widely differing compositions of colours and volumes. In this case, we have a juxtaposition of elements in matt lacquer finish in Grigio Corda, Avio, Salvia, Visone e Terranova.



Domino Clino
L / W 1732 x H 1200 x P / D 387 / 418
Corda



Domino Clino
L / W 1732 x H 1500 x P / D 387 / 418
Corda

Due elementi pensili con inclinazione opposta e colori diversi: quello rivolto a destra è in laccato opaco Ferro, mentre quello rivolto a sinistra è in laccato opaco Creta.

Two wall-mounted elements with opposite slant and different colours. The one facing right is in Ferro, matt lacquer finish, while the one facing left is in Creta, matt lacquer finish.



Grazie alla modularità degli elementi che creano volumi compositi ma dissimulati, i contenitori Domino Clino si adattano a qualsiasi tipologia di ambiente e contesto stilistico, inserendosi anche in spazi di dimensioni ridotte come corridoi o bagni di servizio. Nell'immagine vediamo delle composizioni laccate Grigio Corda opaco a destra e Ardesia a sinistra.

Thanks to the modularity of the elements that create composite but concealed volumes, Domino Clino storage units adapt to all types of rooms and stylistic contexts, even fitting into small spaces such as corridors or extra bathrooms. In the image we see some configurations in matt lacquered Grigio Corda (right) and Ardesia (left).



Domino mono



Domino Mono 16M
L / W 1792 x H 750 x P / D 546

I contenitori Domino Mono sono una serie di elementi con un'unica struttura che può vestirsi con molteplici combinazioni di tonalità e finiture: con esterno impiallacciato e interno laccato, completamente laccata, oppure con esterno impiallacciato e cassetti laccati. Nell'immagine, un abbinamento fra l'esterno in finitura Rovere Argilla con cassetto e interno laccati Ardesia e piedi finitura Piombo.

Domino Mono storage units are a series of elements with a single structure that can be configured in multiple combinations of shades and finishes: with veneered exterior and lacquered interior, entirely lacquered, or with veneered exterior and drawers lacquered. In the image, a combination of exterior in Rovere Argilla with Ardesia interior and lacquered drawer and feet in Piombo.

Domino Mono 19M dx
L / W 1792 x H 750 x P / D 546

Domino Mono può introdurre un gioco di finiture diverse sui frontali dei cassetti, per rendere ancora più speciale e interessante la media. In questa immagine, vengono abbinati l'essenza Rovere Carbone, con piedi ed interno contenitori Brown, e la tonalità laccata opaca Avio.

Domino Mono can introduce a play of different finishes on the front panels of the drawers, to make the sideboard even more special and interesting. In this image are combined Rovere Carbone wood, with feet and container interior in Brown, and matt lacquer Avio.





Domino Mono 11M sx
L / W 1192 x H 750 x P / D 546
Avio • piedi / feet Piombo



Domino Mono 14M sx
L / W 1492 x H 750 x P / D 546
Rovere Carbone-Brown • cassetti / drawers Creta
• piedi / feet Brown



Domino Mono 22M sx
L / W 2092 x H 750 x P / D 546
Terracotta • piedi / feet Piombo

Queste immagini fanno nettamente percepire la particolare lavorazione a 45° degli elementi a giorno, oltre al raffinato contrasto cromatico che si viene a creare fra l'esterno in Rovere Carbone e l'interno laccato Avio.

These images give a clear idea of the special 45° effect of the open elements, as well as the sophisticated colour contrast created between the exterior in Rovere Carbone and the interior in lacquered Avio.





Domino Mono 20M
L / W 2084 x H 750 x P / D 546
piedi / feet Piombo

Estrema quanto piacevole pulizia formale, per la madia Domino Mono completamente laccata Visone opaco, un sobrio ma elegante complemento per qualsiasi ambiente classico o contemporaneo.

Extreme yet equally pleasing clean lines for the Domino Mono sideboard entirely lacquered in matt Visone, an understated but elegant complement to any classic or contemporary setting.



L'anta a ribalta è dotata di esclusiva cerniera regolabile, incassata nello spessore della scocca e dei frontali, dotata di meccanismo Winch che annulla il peso dell'anta durante la chiusura.

The fold-down door has an exclusive adjustable hinge, integrated into the thickness of the shell and the front panels, equipped with a Winch mechanism which cancels out the weight of the door when closing.





Domino Mono 17M
L / W 1794 x H 750 x P / D 546

La scelta fra diverse nuance naturali che vanno dal Terracotta, al Creta, al Bronzo, al Rovere Argilla, permette di realizzare soluzioni ogni volta personalizzate, mantenendo la personalità armoniosa e il sapiente disegno di questo elemento d'arredo. Nell'immagine a fianco, vediamo la finitura Rovere Carbone con interno laccato Brown e gambe verniciate Bronzo.

The choice of various natural shades ranging from Terracotta, to Creta, to Bronzo, to Rovere Argilla, allows one to create customised solutions each time, while maintaining the harmonious personality and skilful design of this piece of furniture. In this image, we see the Rovere Carbone finish with Brown lacquered interior and Bronzo coated legs.



Domino Mono 12M
L / W 1500 x H 750 x P / D 546
Terracotta • piedi / feet Brown



Domino Mono 18M
L / W 1784 x H 750 x P / D 546
Rovere Argilla-Terranova • cassetti / drawers
Visone • piedi / feet Piombo



Domino Mono 21M
L / W 2094 x H 750 x P / D 546
Rovere Argilla-Terranova • cassetto / drawer Bronzo
• piedi / feet Bronzo



Domino ⁱⁿ

Domino IN.2 25l sx
L / W 1200 x H 1200 x P / D 452

Nelle versioni Domino IN.2 e Domino IN.3, la sovrapposizione di due o tre elementi permette di ottenere un'ampia gamma di composizioni, scegliendo fra diverse altezze e molteplici soluzioni cromatiche. In questa immagine la madia si presenta in un raffinato abbinamento fra il Rovere Carbone e il laccato metallo Ottone.

In the Domino IN.2 and Domino IN.3 versions, the superimposition of two or three elements allows a wide range of configurations to be created, choosing between different heights and multiple colour solutions. In this image, the sideboard is shown in a refined combination of Rovere Carbone and Ottone lacquered metal.



Prezioso e sottile il dialogo fra la scura tonalità del Rovere Carbone, percorso da sinuose venature, e la finitura metallica dell'interno, dei profili e dei piedini metallici. Nell'immagine a destra si evidenzia la sovrapposizione di due elementi Domino In.

The interaction between the dark tones of Rovere Carbone, crossed by sinuous veining, and the metallic finish of the interior, profiles and feet in metal is luxurious and subtle. Opposite, two superimposed elements of Domino In are shown.



Domino IN.2 47l
L / W 1200 x H 1425 x P / D 452

Domino IN.3 10N dx
L / W 1200 x H 1425 x P / D 452

Le forme modernamente essenziali degli arredi e dei complementi si inseriscono alla perfezione anche negli ambienti più classici, evocando un senso di bellezza che va oltre il tempo. Nell'immagine vediamo Domino IN.2 e Domino IN.3 in Rovere Carbone, abbinato al laccato Bronzo e al laccato Rame.

The modern, minimalist shapes of the furnishings and accessories fit perfectly into even the most classic of rooms, evoking a sense of beauty that goes beyond time. In the image we see Domino IN.2 and Domino IN.3 in Rovere Carbone, combined with lacquered Bronze and lacquered Rame.





Domino IN.2 401
L / W 900 x H 1275 x P / D 452
Terracotta • piedi / feet Brown

Domino IN.2 471
L / W 1200 x H 1425 x P / D 452

Nella zona bar domestica, i vani a giorno con schiena a specchio creano l'atmosfera di un raffinato locale. Le loro dimensioni generose (H 375 mm per il vano superiore) permettono di collocare comodamente qualsiasi bottiglia. L'anta a ribalta offre a sua volta un comodo piano di servizio.

In the home bar area, the open shelving with mirrored back creates the atmosphere of a refined venue. Its generous dimensions (H 375 mm for the upper compartment) allow you to comfortably store any bottle. The fold-down door becomes a useful serving table.



Domino IN.2 441
L / W 1200 x H 1275 x P / D 452
Ardesia • piedi / feet Piombo



Domino IN.2 381
L / W 1200 x H 1350 x P / D 452
Rovere Argilla-Terranova
• piedi / feet Brown



Domino IN.2 461
L / W 1200 x H 1350 x P / D 452
Rovere Argilla-Ombra
• piedi / feet Brown

Domino IN.2 361
L / W 1200 x H 1350 x P / D 452

Il Creta Opaco, con la sua naturale personalità cromatica, caratterizza questa composizione che si staglia nello spazio circostante.

Creta Opaco, with its natural chromatic personality, characterises this composition that stands out in its surrounding space.





Domino IN.2 191
L / W 900 x H 1200 x P / D 452
Zenzero • piedi / feet Piombo



Domino IN.2 281
L / W 1200 x H 1200 x P / D 452
Antracite • piedi / feet Piombo



Domino IN.2 341
L / W 1200 x H 1350 x P / D 452
Dune • piedi / feet Piombo



Domino IN.2 351
L / W 1200 x H 1350 x P / D 452
Visone • piedi / feet Piombo

Gli interni dei vani possono essere illuminati con led verticali, oppure con un faretto removibile, dotato di sensore di movimento per l'accensione e connessione usb per la ricarica.

The interior of the compartments can be illuminated with vertical LEDs, or with a removable spotlight, with motion sensor for switching on and USB charging.



Domino IN.2 111
L / W 2100 x H 825 x P / D 452

Citazioni vintage e cromatismi chic caratterizzano un ambiente da vivere con naturalezza e interpretare con passione artistica. Nell'immagine, Domino IN.2 si presenta in un abbinamento Rovere Carbone e Amarena opaco, piedi Brown.

Vintage references and chic colours characterise an environment to be lived in naturally and interpreted with artistic passion. In the image, Domino IN.2 is shown in a combination of Rovere Carbone and matt Amarena, feet in Brown.



La lavorazione a 45° è ben visibile in questa immagine, nella quale spicca anche l'incontro fra la scura tonalità del Rovere Carbone e il caldo colore laccato Amarena opaco.

The 45° effect is clearly visible in this image, which underlines the encounter between the dark shade of Rovere Carbone and the warm matt colour of lacquered Amarena.



Domino IN.2 6l dx
L / W 1800 x H 900 x P / D 452

I toni caldi e materici del Rovere Argilla creano un contrasto con la finitura Piombo della scocca interna, dei profili a vista e dei piedini metallici, creando un effetto che affascina e sorprende.

The warm, textural shades of Rovere Argilla create a contrast with the Piombo metallic finish of the shell, visible profiles and metal feet, creating an appealing and surprising effect.



Domino IN.3 6N
L / W 1200 x H 1200 x P / D 452

Sovrapponendo tre elementi, Domino IN.3 spezza il volume compatto della madia, con un inserimento centrale dalla forte presenza grafica. L'immagine mostra il raffinato abbinamento fra il Rovere Carbone e il laccato metallo Bronzo.

By superimposing three elements, Domino IN.3 breaks up the solid volume of the sideboard, with the strong graphic presence of a central insert. The image shows the refined combination of Rovere Carbone and metal lacquered Bronze.

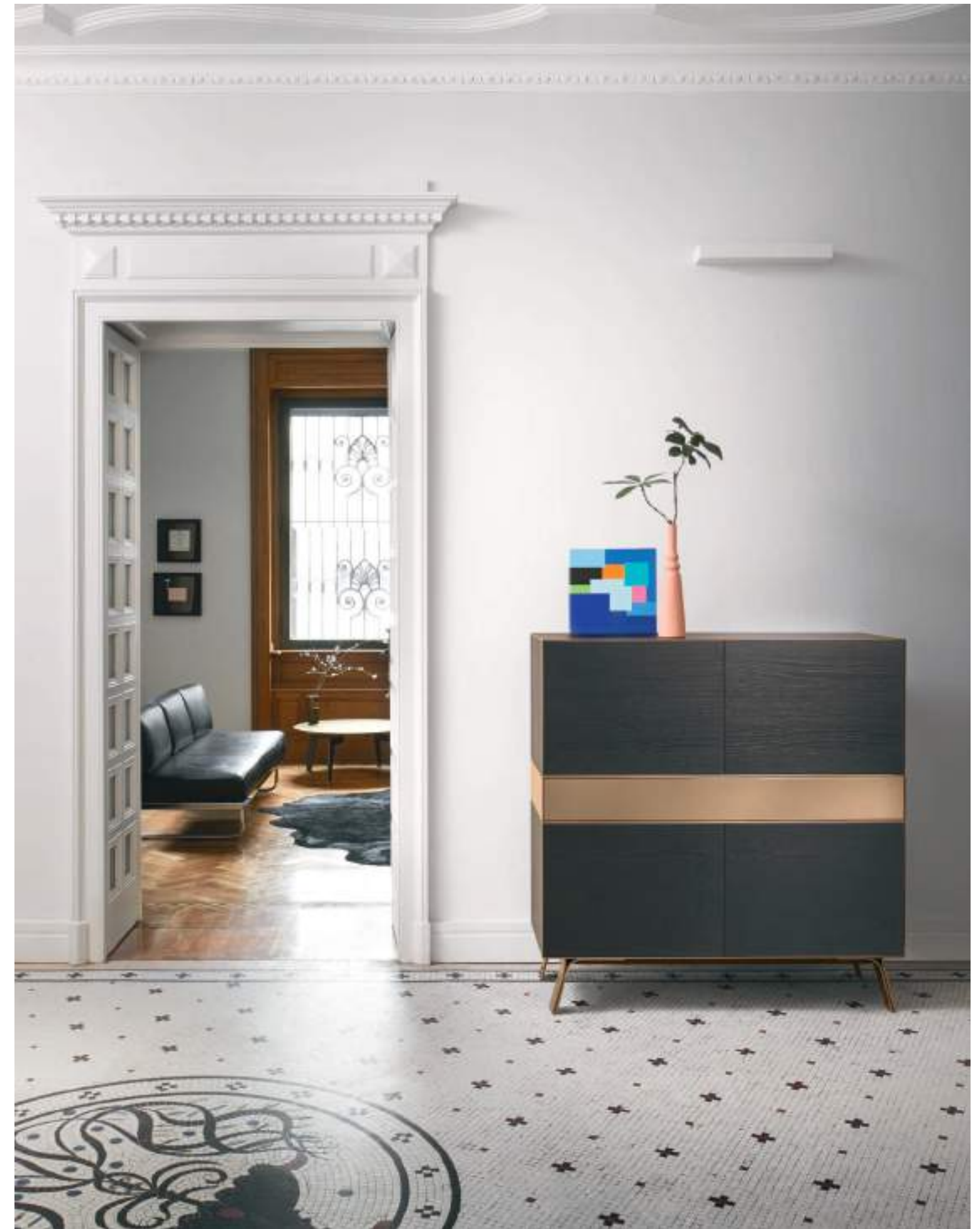

Domino IN.3 7N sx
L / W 1200 x H 1275 x P / D 452

Domino IN.3 8N sx
L / W 1200 x H 1275 x P / D 452

Pochi elementi sapientemente accostati danno vita a una composizione di ampio respiro e profondo prestigio. Le due madie in finitura Rovere Carbone e laccato metallico Bronzo si diversificano lievemente, creando un ritmo particolare di vuoti e di pieni.

A few skilfully matched elements create a wide-ranging composition of considerable prestige. The two sideboards in Rovere Carbone finish and Bronzo metallic lacquer are slightly different, creating a special rhythm of empty and solid elements.





Domino IN.3 10N dx
L / W 1200 x H 1425 x P / D 452

La madia diventa un mobile bar, grazie al vano attrezzato con mensola in vetro di profondità ridotta che permette di accogliere sia i bicchieri che le bottiglie. Il vano a giorno aggiunge un ulteriore elemento caratterizzante a questa composizione in Rovere Argilla e Piombo.

The sideboard becomes a bar, thanks to the compartment equipped with a narrow glass shelf that can hold both glasses and bottles. An open compartment adds an additional touch of character to this composition in Rovere Argilla and Piombo.





Domino IN.3 15N dx
L / W 1800 x H 1275 x P / D 452
piedi / feet Rame

Nella sovrapposizione degli elementi, è possibile abbinare diverse finiture esterne ed interne, come ad esempio in questo caso il Rovere Argilla e i laccati metallici Bronzo, Rame ed Ottone, con un effetto finale particolarmente raffinato.

In combining the elements, it is possible to have different external and internal finishes, such as in this case the Rovere Argilla and the Bronzo, Rame and Ottone metal lacquers, for a particularly refined final effect.

Domino IN.3 4N
L / W 900 x H 1350 x P / D 452

Fra una madia e l'altra, le diverse finiture creano un effetto di positivo e negativo, in un raffinato abbinamento tra il Grigio Corda e Creta opaco, i piedi sagomati sono finitura Piombo.

Between one sideboard and another, the different finishes create a positive-negative effect, in a sophisticated combination of Grigio Corda and matt Creta with shaped feet in Piombo.





Domino più

Domino Più 18P sx
L / W 2400 x H 750 x P / D 452 / 546

Domino Più, ovvero più elementi che si accostano l'uno con l'altro, in un susseguirsi cromatico che si sviluppa in senso orizzontale, qui proposto in laccato opaco Ferro, Ardesia, Terracotta, con piedi metallici finitura Piombo.

'Più' is Italian for more! And in Domino Più, more elements are combined in horizontal succession, shown here in matt lacquer Ferro, Ardesia and Terracotta, with metallic feet in Piombo.



Domino Più 16P
L / W 1800 x H 750 x P / D 546

Accostandosi fra loro, gli elementi della madia creano un gioco cromatico fra le diverse finiture che continua sul top e sui lati. Nell'immagine, vediamo un abbinamento tra il Rovere Carbone e il laccato opaco Ferro, con piedi Brown.

Seen together, the elements of the sideboard create a colour play between the different finishes, which continues on the top and on the sides. In the image, we see Rovere Carbone matched with matt lacquer Ferro, with feet in Brown.



Domino Più 15P sx
L / W 2700 x H 600 x P / D 452

Una sequenza di elementi affiancati, con nuance diverse che variano dal Rovere Carbone con interno Brown, al laccato opaco Ardesia e Visone, come in una scala cromatica. I piedi in metallo sono in finitura Piombo.

A sequence of adjacent elements in different shades ranging from Rovere Carbone with Brown interior, to matt lacquer Ardesia and Visone, as in a chromatic scale. The metal feet are in Piombo finish.





Domino Più 6L sx
L / W 2400 x H 750 x P / D 546

Su richiesta, le madie Domino possono essere finite anche sul retro, in modo da essere utilizzabili come elemento a centro stanza. I vari elementi possono essere sovrapposti e accostati anche in maniera asimmetrica. In queste immagini spicca l'abbinamento fra il laccato opaco Pervinca ed il Rovere Argilla, con l'interno laccato nella stessa tinta e piedi metallici in finitura Piombo.

On request the Domino sideboards can also be finished on the back, so they can stand in the centre of the room. The different elements can be superimposed or matched even asymmetrically. In these images, the combination of Pervinca matt lacquer and Rovere Argilla is striking, with matching lacquered interior and metal feet in Piombo.

Domino giro



Domino Giro 29G
L / W 450 x H 1192 x P / D 450

Dinamico e particolare, Domino Giro si distingue per la sovrapposizione di singoli elementi con cassetti, vani a giorno o ante, di altezza diversa (H 150 / 225 / 450 mm) ma con larghezza e profondità uguale (450 mm), perciò ruotabili e fruibili su tutti e quattro i lati. In foto l'abbinamento del Rovere Carbone con lo Zenzero opaco.

Dynamic and unusual, Domino Giro is distinctive for its stacking of single elements with drawers, open units or doors, of different heights (H 150 / 225 / 450 mm) but with the same width and depth (450 mm), therefore rotatable and usable on all four sides. In the photo a combination of Rovere Carbone with matt Zenzero.

Domino Giro 04G
L / W 450 x H 478 x P / D 450

Domino Giro 27G
L / W 450 x H 1143 x P / D 450

Con Domino Giro è possibile realizzare soluzioni con altezze diverse, per soddisfare molteplici esigenze d'uso e ambientazione. In questo ambiente, dallo stile fra l'informale e il glamour, gli elementi sono in laccato metallico Bronzo con esterno delle cassettiere in Rovere Carbone.

With Domino Giro, solutions with different heights can be created to meet multiple needs of use and interior layouts. In this space, with its style midway between informal and glamour, the elements are in metallic lacquer Bronze with the exterior of the drawers in Rovere Carbone.





Domino Giro 15G
L / W 450 x H 1166 x P / D 450

Domino Giro 17G
L / W 450 x H 1404 x P / D 450

Quasi come in una scultura razionalista, una sovrapposizione di volumi girevoli presenta una serie di temi cromatici che vanno dall'Ardesia, al Dune, al Brown opaco.

Almost as if in a rationalist sculpture, a tower of revolving cubes is a vertical progression of colour shades ranging from Ardesia, to Dune, to matt Brown.



Domino Giro 16G
L / W 450 x H 1254 x P / D 450

Domino Giro è una presenza inusuale nello spazio domestico, resa ancora più originale dall'abbinamento fra le venature del Rovere Carbone con interno Brown e la tonalità del Ardesia opaco.

Domino Giro is an unusual presence in the home, made even more original by the combination of the veining of Rovere Carbone with interior in Brown and the shade of matt Ardesia.



Domino Giro 24G
L / W 450 x H 980 x P / D 450

Una sovrapposizione di elementi uguali nel volume ma diversi nelle finiture: Rovere Argilla con interno Terranova, Ombra, Corda e Visone creano un ritmo cromatico ascendente.

A tower of elements with the same volume but different finishes: Rovere Argilla with interior in Terranova, Ombra, Corda and Visone create an ascending chromatic rhythm.



Cabaret

Cabaret 56B sx
L / W 2420 x H 695 x P / D 570 – Teca H 240

Caratterizzato dal perimetro spesso 10 mm, Cabaret ha un'eleganza classica ma sempre attuale, giocata sull'abbinamento di volumi, superfici di vetro e vani a giorno. Gli elementi con diverse altezze consentono di creare diverse composizioni, con teche espositive di varie dimensioni. Molteplici anche le possibilità di appoggio del mobile: su piedi, a terra su piedi bassi oppure pensili. Nella foto la madia è tutta impiallacciata Noce, con top in ceramica Noir Desir e piedi cilindrici altezza 180 mm Brown.

With its 10 mm thick perimeter, Cabaret has an elegance that is classic but always on trend, playing on a combination of volumes, glass surfaces and open compartments. The elements with different heights allow you to create different configurations, with display spaces of various sizes. There are also many possibilities for supporting the furniture: on feet, on the ground on low feet or wall-hung. In the photo, the sideboard is entirely in Noce veneer, with Noir Desir ceramic top and cylindrical feet, height 180 mm in Brown.





Cabaret 14A dx
L / W 2120 x H 695 x P / D 570
Creta • top Nero Greco • piedi / feet H 180 Brown



Cabaret 54C
L / W 2120 x H 695 x P / D 570 – Teca H 240
Noce • Ombra • piedi / feet H 180 Brown



Cabaret 15A
L / W 2420 x H 695 x P / D 570
Rovere Argilla • Rame • piedi / feet H 180 Rame

Cabaret 56B sx
L / W 2420 x H 695 x P / D 570

Un unico elemento d'arredo, più varianti compositive e materiche: con top in ceramica, con ripiano laterale in vetro, oppure con un gioco armonioso di volumi e finiture. Nell'immagine un esempio in laccato Antracite opaco, abbinato a un top in ceramica con finitura Statuarietto. Piedi cilindrici H 180 mm Brown.

One single piece of furniture, several variations of configuration and texture: with ceramic top, with a glass shelf on one side, or with a harmonious play of volumes and finishes. In the image an example in matt lacquered Brown, combined with a ceramic top with Statuarietto finish. Cylindrical feet H 180 mm Brown.





Cabaret 53B SX
L / W 1820 x H 515 x P / D 495 – Teca H 240

La madia pensile Cabaret può risolvere con uno stile raffinato e suggestivo una zona di disimpegno, un corridoio, un ingresso. Le immagini mostrano un abbinamento fra i contenitori in Rovere carbone e il top in ceramica Nero Greco, con perimetro esterno metallico in finitura Piombo.

The Cabaret wall-mounted sideboard can bring refined and evocative style to a hallway, a corridor or an entrance space. The images show a combination of containers in Rovere Carbone and Nero Greco ceramic top, with a metallic external perimeter in Piombo.





Rifinite su tutti i lati, le madie Cabaret possono essere posizionate anche a centro stanza, oppure collocate dietro allo schienale di un divano, come in queste immagini che propongono una versione in Rovere Carbone con piano ceramica finitura Savoia Antracite e piedi sagomati in metallo Brown.

Finished all round, Cabaret sideboards can also be positioned in the centre of the room, or placed at the back of a sofa, as in these images showing a version in Rovere Carbone with ceramic top in Savoia Antracite and shaped feet in Brown metal.

Cabaret 16C
L / W 2720 x H 595 x P / D 570 – Teca H 160



Cabaret 84B sx
L / W 2420 x H 675 x P / D 495 – Teca H 320

Grazie alla loro modularità le madie Cabaret si prestano a diverse configurazioni: in questo caso, il vano a giorno è posizionato lateralmente, nell'ambito di una combinazione fra cassetti e ribalte. Le madie Cabaret si possono anche collocare sospese a parete e possono avere una luce al led perimetrale che crea una suggestiva atmosfera. Nell'immagine, il perimetro della madia è in Rovere Carbone, e i contenitori in laccato Antracite opaco.

Thanks to their modularity, Cabaret sideboards lend themselves to different configurations: in this case, the open compartment is positioned laterally, as part of a combination of drawers and fold-down doors. Cabaret sideboards can also be wall-hung and can have perimeter LED lighting, which creates a special atmosphere. In the image, the perimeter of the sideboard is in Rovere Carbone, and the containers in matt lacquer Antracite.





Cabaret 80B sx
L / W 1820 x H 795 x P / D 570 – Teca H 240
Zenzero • piedi metacrilato / methacrylate feet H 120



Cabaret 80C
L / W 2120 x H 795 x P / D 570 – Teca H 320
Ferro • piedi metacrilato / methacrylate feet H 120



Cabaret 83B sx
L / W 2420 x H 690 x P / D 570 – Teca H 320
Ombra

Grazie alla loro modularità, le madie Cabaret permettono di creare soluzioni diverse in quanto a dimensioni e configurazioni, con vano a giorno centrale o decentrato. Sia le madie a terra che quelle pensili possono essere dotate di suggestiva illuminazione sul retro.

Thanks to their modularity, Cabaret sideboards make a variety of solutions possible in terms of dimensions and configurations, with the open compartment central or off-centre. Both the freestanding and wall-hung sideboards can be fitted with evocative back-lighting.





Cabaret 20C
L / W 2120 x H 755 x P / D 570 – Teca H 160

La madia Cabaret, grazie alla finitura su tutti i lati, può essere utilizzata anche come elemento di suddivisione e organizzazione dello spazio. Qui viene proposta in Rovere Termotrattato con top in Ceramica finitura Statuarietto opaco e piano in vetro, con piedi sagomati.

The Cabaret sideboard can also be used as an element to divide and organise the space thanks to the finish on all sides. Here it is shown in heat-treated Rovere with Ceramica top in matt Statuarietto finish and glass shelf, with shaped feet.



Cabaret 22B sx
L / W 2120 x H 755 x P / D 570 – Teca H 160

Grazie alla loro modularità le madie Cabaret si prestano a diverse configurazioni: in questo caso, il vano a giorno è posizionato lateralmente, nell'ambito di una combinazione fra cassetti e ante.

Thanks to their modularity, Cabaret sideboards are suitable for different configurations. In this case, the open compartment is positioned laterally, as part of a combination of drawers and doors.





Cabaret 19D sx
L / W 1520 x H 755 x P / D 570 – Step H 160

Il gioco dei volumi in altezza determina spazi espositivi diversi, per appoggiare semplicemente degli oggetti o per valorizzarli all'interno di una prestigiosa cornice. Nelle immagini, vediamo l'abbinamento fra il laccato Antracite lucido e la finitura impiallacciato Noce Canaletto.

The variety in height of the volumes results in different display spaces, where objects can be simply placed, or framed inside an elegant setting. In the images, we see a combination of gloss lacquered Antracite and Noce Canaletto veneer finish.





Cabaret 22A
L / W 2420 x H 755 x P / D 570

Essenziale fuori, attrezzata dentro: la madia Cabaret a 4 ante, in Rovere Carbone con piano in Ceramica finitura Noir Desir, svela dei funzionali cassetti estraibili al proprio interno, tutto sospeso su piedi sagomati Brown.

Minimalist outside, fully fitted inside: the Cabaret sideboard with 4 doors, in Rovere Carbone with ceramic top in Noir Desir, reveals functional pull-out drawers inside, the whole suspended on shaped feet in Brown.





Cabaret 20A
L / W 1820 x H 755 x P / D 570
Rovere Carbone • Ombra • piedi sagomati / shaped feet Brown



Cabaret 21A sx
L / W 2120 x H 755 x P / D 570
Piombo • Antracite • piedi sagomati / shaped feet Piombo



Cabaret 24A
L / W 2420 x H 755 x P / D 570
Rovere Carbone • Rame • piedi sagomati / shaped feet Rame

Cabaret 35A
L / W 2420 x H 755 x P / D 570

Diverse composizioni per la madia Cabaret, giocate sull'abbinamento in contrasto fra il colore del perimetro esterno e la finitura del top e dei frontali, oppure sulla sovrapposizione di finiture diverse. L'immagine a destra presenta l'abbinamento dell'impiallacciato Noce e laccato Visone opaco, con piedi sagomati Rame.

Various configurations for the Cabaret sideboard, playing on contrast between the colour of the external perimeter and the finish of the top and front panels, or on the superimposition of different finishes. The image on the right shows a combination of Noce veneer and matt Visone lacquer, with shaped feet in Rame.





Cabaret 28A
L / W 920 x H 1315 x P / D 475

Cabaret 38C
L / W 920 x H 1315 x P / D 475 - Teca H 400

Il mobile bar rivisitato e la madia dotata di ampio vano a giorno (H 400 mm) e top in vetro, contribuiscono a creare un'atmosfera raffinata, in equilibrio fra memorie del passato e seducenti tendenze contemporanee. Le Madie hanno perimetro e struttura degli elementi in Rovere Argilla, mentre i frontali e i piedi sagomati Piombo.

The home bar revisited and the sideboard with large open compartment (H 400 mm) and glass top help to create a refined atmosphere, balanced between memories of the past and seductive contemporary trends. The perimeter and structure of the sideboard elements are in Rovere Argilla, while front panels and shaped feet are in Piombo.



Cabaret 28A
L / W 920 x H 1315 x P / D 475
Terracotta • piedi sagomati
/ shaped feet Piombo



Cabaret 26A
L / W 920 x H 1315 x P / D 475
Piombo • piedi sagomati
/ shaped feet Piombo



Cabaret 35C
L / W 920 x H 1315 x P / D 475 – Teca H 240
Rovere Argilla • Brown • piedi sagomati
/ shaped feet Piombo



Cabaret 37C
L / W 920 x H 1315 x P / D 475 – Teca H 320
Rovere Argilla • Ferro • piedi sagomati
/ shaped feet Piombo

Nell'immagine a destra, spicca la luminosità del vano grazie alla luce naturale che filtra attraverso il piano in vetro trasparente.

In the image on the right, the brightness of the compartment stands out thanks to natural light filtering through the transparent glass top.



Cabaret 33C
L / W 1220 x H 1315 x P / D 475

Grazie alla loro modularità le madie Cabaret si prestano a diverse configurazioni, con vani a giorno di diversa altezza: H 160 mm per creare teche destinate agli oggetti più preziosi, H 240 mm per gli oggetti più comuni e H 320/400 mm per vasi e bottiglie. Nell'immagine a destra, la madia è in finitura impiallacciata Noce Canaletto, con Teca H 240 e top in ceramica Noir Desir e piedi sagomati H 80 mm Rame.

Thanks to their modularity, Cabaret sideboards lend themselves to different configurations, with open compartments of various heights: H 160 mm to create display spaces for highly precious objects, H 240 mm for more everyday items and H 320 / 400 mm for vases and bottles. In the image on the right, the sideboard is in Noce Canaletto veneer, with Teca H 240, Noir Desir ceramic top and shaped feet H 80 mm in Rame.





Cabaret 29C
L / W 1220 x H 1315 x P / D 475 – Teca H 160
Noce • Ombra • piedi sagomati
/ shaped feet Brown



Cabaret 32C
L / W 1220 x H 1315 x P / D 475 – Teca H 240
Noce • Creta • piedi sagomati
/ shaped feet Brown



Cabaret 32A
L / W 1220 x H 1315 x P / D 475
Noce • Zenzero • piedi sagomati
/ shaped feet Brown



Cabaret 34A
L / W 1220 x H 1315 x P / D 475
Noce • Brown • piedi sagomati
/ shaped feet Brown

In questa pagina, altri esempi di configurazioni:
con teca in vetro H 160 mm, esterno in Noce
impiallacciato e interno laccato Ombra opaco;
con teca in vetro H 240 mm, esterno in Noce
impiallacciato e interno laccato Creta opaco;
con esterno in Noce impiallacciato e interno
laccato Zenzero opaco o Brown opaco. Piedi
sagomati Brown.

On this page, more examples of configurations:
with glass display space H 160 mm, exterior
in Noce veneer and interior in matt lacquered
Ombra; with glass case H 240 mm, exterior
in Noce veneer and interior in matt lacquered
Creta; with exterior in Noce veneer and interior
in matt lacquered Zenzero or matt Brown.
Shaped feet in Brown.



Cabaret ceramica

Cabaret Ceramica 6E
L / W 2420 x H 755 x P / D 570

Cabaret Ceramica interpreta in stile contemporaneo la ceramica porcellanata, vestendo le forme essenziali e modulari di questa famiglia di madie con le emozioni di un materiale che evoca le venature e i colori del marmo. Questo fascino materico è presente sui frontali, in maniera specifica sulle ante battenti e le ribalte. Si tratta di una realizzazione sartoriale, perché ricavata da una lastra unica, seguendo in continuo il disegno dell'intero frontale.

Cabaret Ceramica interprets porcelain ceramic in contemporary style, dressing the minimalist, modular shapes of this family of sideboards with the emotions of a material that evokes the veining and colours of marble. This fascinating texture is used on front panels, specifically on hinged doors and fold-down doors. This is a tailor-made element, because it is obtained from a single slab, continuously following the design of the entire front.



I frontali in Ceramica con effetto Nero Greco o Statuarietto in abbinamento alla finitura Rovere Carbone, rendono particolarmente suggestivo questo elemento d'arredo, conferendogli un particolare carattere estetico. Telaio delle ante e piedi sagomati Brown o Piombo.

The ceramic front panels with Nero Greco or Statuarietto effect, combined with the Rovere Carbone finish, give this unit a particular sense of poetry and a distinctive aesthetic character. Doors frame and shaped feet in Brown or Piombo.

Base Cabaret 5E
L / W 2420 x H 515 x P / D 495

Sospesa a parete, la madia Cabaret si presenta con fianchi e top in Noce impiallacciato e frontali in Ceramica Noir Desir. L'illuminazione perimetrale, presente anche nell'elemento a giorno in vetro, crea un effetto suggestivo.

Hung on the wall, the Cabaret sideboard has sides and top in Noce veneer and front panels in Noir Desir ceramic. The perimeter lighting, also present in the open glass compartment, creates a special effect.



Il sistema di illuminazione a led perimetrale trasforma gli elementi pensili, realizzati in vetro Fumé, quasi in un'installazione d'arte contemporanea.

The perimeter LED lighting system transforms the hanging elements, made of smoked glass, almost into a contemporary art installation.





Cidori

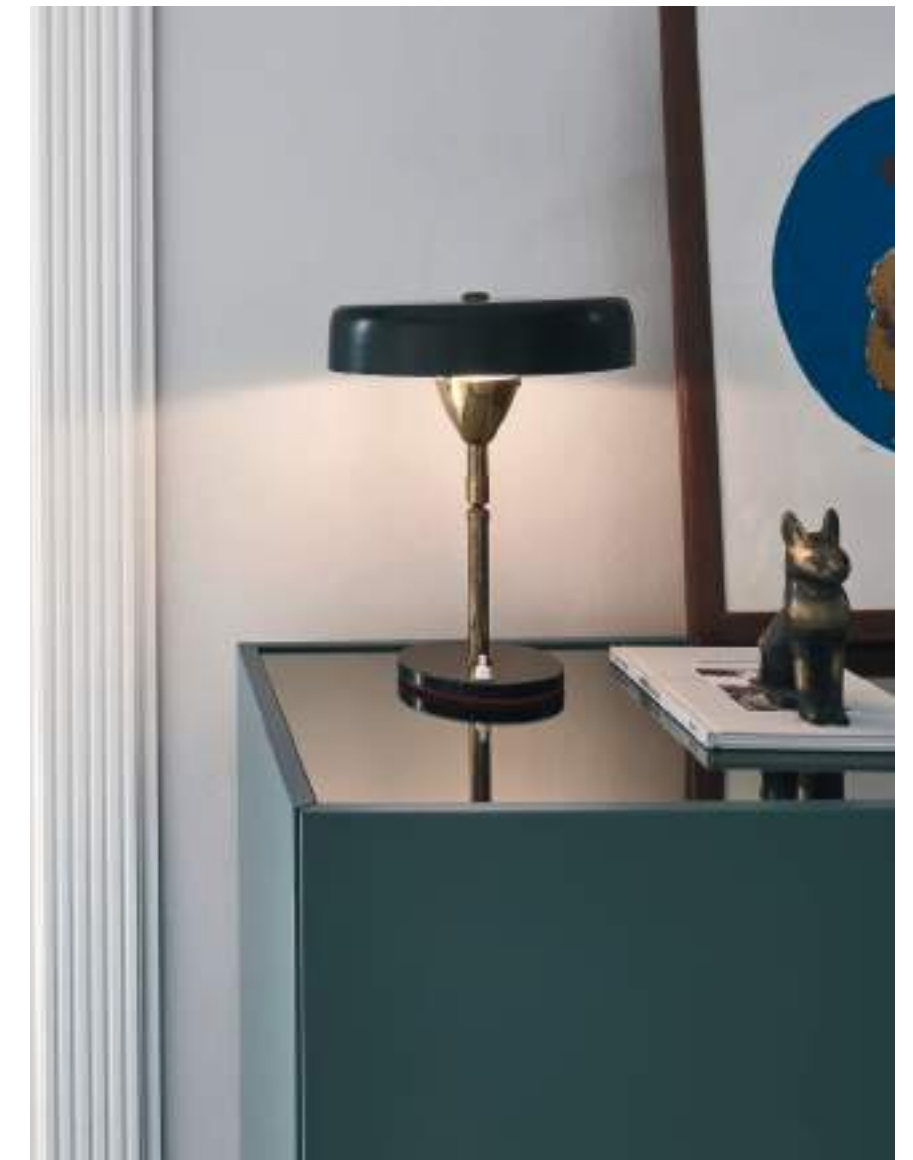

Cidori 10
L / W 1200 x H 1260 x P / D 451

Gli elementi Cidori si contraddistinguono per l'unione del fianco al frontale a 45° e per il top lievemente ribassato che consente di ricavare un vassoio. Questa peculiarità permette di rifinire il mobile con un top in vetro, oppure in alternativa di sovrapporre più elementi in maniera impeccabile, ottenendo volumi e altezze diverse. Nelle immagini, la madia Cidori si presenta in versione laccata opaca Avio, con top in specchio Dark.

Cidori units are distinguished by the 45° jointing of side to front panel and by the slightly lowered top which can be used as a tray. This special feature allows the unit to be finished with a glass top or, alternatively, to stack several units in an impeccable way, obtaining different volumes and heights. In the images, the Cidori sideboard is shown in matt lacquered Avio, with Dark mirror top.



Cidori 9
L / W 900 x H 1260 x P / D 451

Le madie Cidori sono disponibili anche con larghezza 90 cm, per sfruttare al meglio uno spazio ridotto, anche creando composizioni multiple. In queste immagini la finitura è il laccato opaco Visone, con top e zoccolo in Rovere Argilla.

Cidori sideboards are also available with a width of 90 cm, for optimum use of a smaller space, also creating multiple compositions. In these images the finish is Visone matt lacquer, with top and plinth in Rovere Argilla.





Cidori 2
L / W 1800 x H 727 x P / D 537

La gola che circonda la madia svolge anche la funzione di presa per l'apertura dei cassetti. Essendo rifiniti anche sul retro, gli elementi Cidori sono posizionabili anche a centro stanza. Nell'immagine viene presentato l'abbinamento fra il Rovere Carbone e il top in vetro laccato lucido Brown.

The groove surrounding the sideboard also acts as a grip for opening the drawers. Cidori sideboards can also be placed in the centre of the room, being finished on all four sides. The image shows the combination between Rovere Carbone and the gloss lacquered glass top in Brown.



Cidori 4
L / W 2400 x H 727 x P / D 537

Oltre che sui frontali, è possibile richiedere la lavorazione a 45° anche sul retro. Nelle immagini, effetto tono su tono fra il perimetro esterno laccato lucido Juta, con il top e zoccolo in laccato opaco Juta.

A 45° finish on the back, as on the front panels, can also be specified. In the images, tone-on-tone effect between the outer perimeter in gloss lacquered Juta, with the top and plinth in matt lacquered Juta.





Cidori
L / W 2400 x H 540 x P / D 537

Un palazzo storico interpretato alla luce del design contemporaneo è lo scenario in cui viene ambientata questa media Cidori con raffinata finitura Bianco 10, abbinata al top ed allo zoccolo in Rovere Argilla.

A historical palazzo interpreted in light of contemporary design is the stage on which this Cidori sideboard is set, with the refined Bianco 10 finish, combined with top and plinth in Rovere Argilla.





Abaco

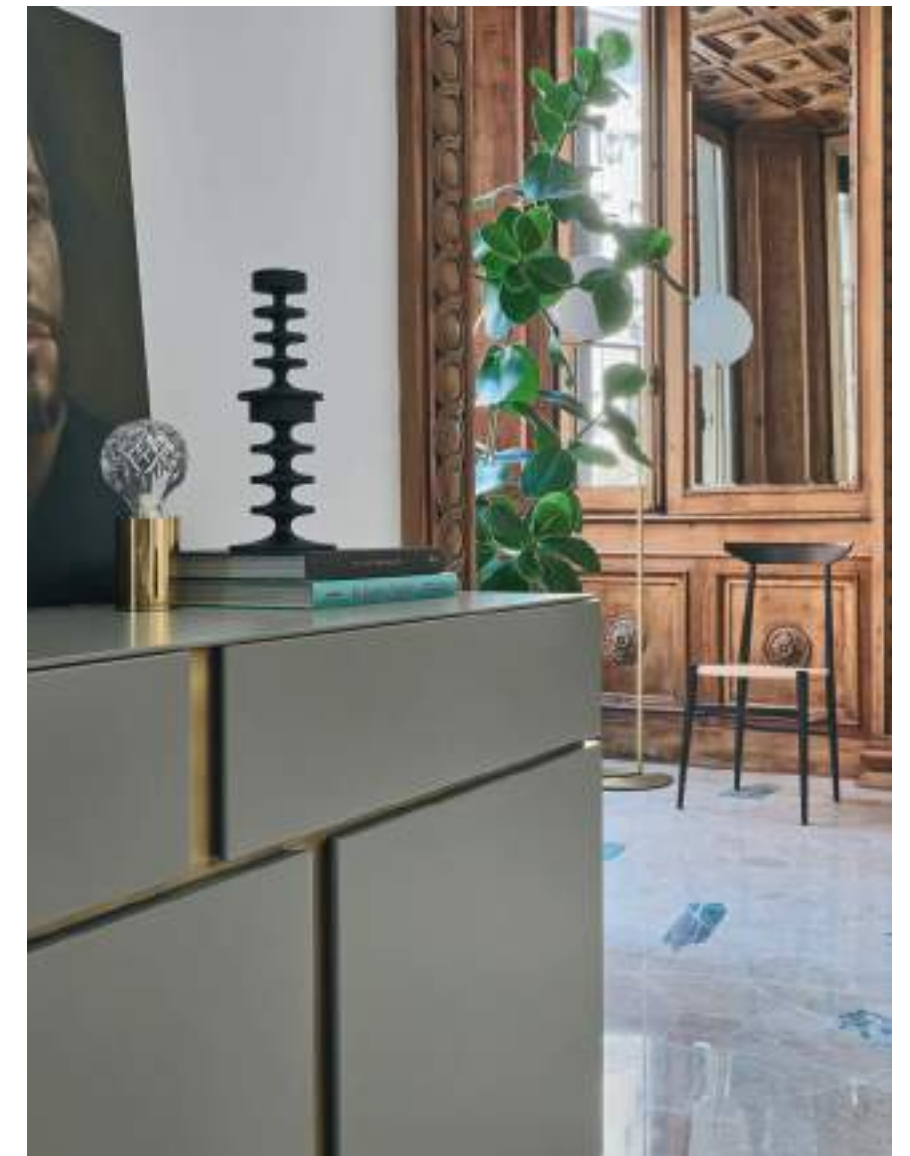

Abaco 6 dx
L / W 1858 x H 814 x P / D 538

Le madie Abaco nascono dalla sovrapposizione dei cassetti e delle ante battenti, abbinati in maniera simmetrica o asimmetrica per creare delle relazioni fra linee e superfici decisamente originali e di forte effetto. Le gole con finitura metallica Ottone come i piedi cilindrici, aggiungono un tocco prezioso all'insieme, abbinandosi alle superfici in laccato opaco Salvia.

Abaco sideboards are created by superimposing drawers and side-hinged doors, combined symmetrically or asymmetrically to create relationships between lines and surfaces that are undoubtedly original and strongly effective. The grooves with Ottone metal finish, like the cylindrical feet, add a precious touch to the whole, matching the matt lacquered surfaces in Salvia.



Abaco 9
L / W 2458 x H 814 x P / D 538

La madia Abaco è contraddistinta dal gioco di tonalità e profondità fra i frontali e le gole. Qui a fianco si presenta in versione Rovere Termotrattato e laccato Amarena, con piedi cilindrici Brown che completano l'insieme.

The Abaco sideboard is notable for the play of tonalities and depths between front panels and grooves. Opposite, version in heat-treated Rovere and Amarena lacquer, with cylindrical feet in Brown that complete the whole.



Abaco 13
L / W 1078 x H 1231 x P / D 451

La lavorazione a 45° fra il fianco e il frontale della madia Abaco, testimonia la cura dei dettagli e la qualità della realizzazione, tipica dell'intera collezione Sangiacomo. Nelle immagini, la madia è in laccato Bianco 10 opaco con gole Antracite opaco.

The 45° finish between side and front panel of the Abaco sideboard bears witness to the crafting of details and quality of production typical of the entire Sangiacomo collection. In the images, the sideboard is in matt lacquered Bianco 10 with matt Antracite grooves.



Abaco 18 dx
L / W 1078 x H 1575 x P / D 451

Atmosfere raffinate dove ogni dettaglio è protagonista. Le superfici laccate della madia lasciano appena intravedere le venature dell'essenza all'interno delle gole, in un gioco che è allo stesso tempo grafico e materico. Nelle immagini vediamo l'abbinamento contrastante fra le superfici in laccato opaco Grigio Corda e le gole in Rovere Carbone.

Refined atmospheres where every detail is significant. The lacquered surfaces of the sideboard allow a glimpse of the veining of the wood inside the grooves, in a play that is graphic and textural at the same time. In the images we see the contrasting combination between the matt lacquered Grigio Corda surfaces and the grooves in Rovere Carbone.





Vela



Le madie Vela sono caratterizzate dal perimetro elegantemente sottile (10 mm) con giunzioni a 45°, che racchiude ante di spessore 25 mm, con maniglia scavata direttamente nel bordo superiore.

Vela sideboards feature an elegantly slim perimeter (10 mm) with 45° joints, which encloses 25 mm thick doors with handle hollowed out directly in the upper edge.

Vela 16
L / W 1230 x H 1380 x P / D 565

Dettagli inconfondibili: dalla maniglia a presa concepita come parte integrante dell'anta, ai piedi in metallo sagomato. Qui vediamo due madie abbinate in finitura laccato lucido Ardesia, con piedi sagomati in metallo Brown.

Unmistakeable details: from the grip handle designed as an integral part of the door, to the feet in shaped metal. Here we see two sideboards placed together, in gloss Ardesia lacquer finish, with shaped feet in Brown metal.



Vela 13

L / W 2430 x H 740 x P / D 565

La madia Vela è qui in versione impiallacciata in Rovere Termotrattato, sempre con maniglia a presa scavata nello spessore dell'anta. I piedi sono in metallo Brown.

The Vela sideboard is here in a version veneered in heat-treated Rovere, again with grip handle hollowed out in the thickness of the door. The feet are in Brown metal.





Dietro alle ante impreziosite dalla lavorazione a gola sul bordo superiore, anche l'interno della madia rivela un'alta qualità della realizzazione, con cassetto interno, ripiani in vetro ed una finitura in contrasto per valori materici e cromatici.

Behind the doors embellished with the groove finish on the upper edge, the interior of the sideboard also reveals a high quality of manufacture, with inside drawer, glass shelves and a contrast finish in terms of textures and colours.





Vela 9
L / W 1820 x H 740 x P / D 565

La finitura Ardesia opaco rende la madia adatta a qualsiasi ambiente, evocando un senso di naturale tranquillità domestica. La particolare lavorazione delle ante aggiunge un tocco di morbido dinamismo.

The matt Ardesia finish makes the sideboard suitable for any setting, evoking a sense of natural domestic tranquility. The particular decoration of the doors adds a touch of soft dynamism.



Vela 12 sx
L / W 2120 x H 740 x P / D 565

Una situazione d'arredo ispirata a una raffinata cultura del progetto, con colori ed emozioni che si ispirano al paesaggio mediterraneo. La sedia è proposta in Magnolia opaco con piedi sagomati Piombo.

An interior deriving from a refined design culture, with colours and emotions inspired by the Mediterranean landscape. The sideboard is available in matt Magnolia with shaped feet in Piombo.



Spirito contemporaneo che non passa mai di moda, per questa versione della madia Vela, cassetto e ribalta inferiore che offrono ampie e funzionali capacità di contenimento.

A contemporary spirit that never goes out of fashion for this version of the Vela sideboard, with drawer and lower flap providing ample, practical storage capacities.



Scrigno

Scrigno 20
L / W 1200 x H 1695 x P / D 465

Scrigno, versatili e affascinanti elementi d'arredo che uniscono la funzione del contenimento con quella dell'esposizione. Tutto questo con una visibile qualità anche nei particolari del telaio metallico che racchiude l'anta in vetro, aggiungendo una nota elegantemente preziosa all'insieme. Nell'immagine, la struttura e i telai in metallo e i piedi sagomati sono in finitura Opaco Brown.

Scrigno, versatile and appealing furniture, which combines the function of storage with that of display. All this with quality visible in the details too with 45° joints, to the metal frame that surrounds the glass door, adding an elegantly precious note to the whole. In the image, metal structure and frames and shaped feet are in Opaco Brown.



Scigno 18
L / W 1200 x H 1375 x P / D 465

La madia Scigno è qui proposta con struttura in laccato opaco Brown, ante delle vetrine con telaio Scigno in metallo verniciato Brown e vetro trasparente. La vetrina è provvista di cassetti interni con altezza 126 mm, nella stessa finitura della struttura, con piedi in metallo Brown.

The Scigno sideboard is shown here with a matt lacquered Brown structure, cabinet doors with Scigno frame in Brown coated metal and transparent glass. The glass case has internal drawers with a height of 126 mm, in the same finish as the structure, with feet in Brown metal.





Scrigno 306 sx
L / W 2415 x H 790 x P / D 561

In queste immagini, la madia Scrigno con fianco e perimetro esterno a 3 lati di spessore 15 mm, con giunzioni a 45°, allineato con lo spessore delle ante Scrigno da 35 mm; anta di spessore 20 mm in Rovere Termotrattato. Ante delle vetrine con telaio Scrigno in metallo verniciato Brown e vetro Fumé, interno con faretto led a incasso. Piedi cilindrici in metallo Brown.

In these images, the Scrigno sideboard, with side and outer perimeter on 3 sides 15 mm thick, and with 45° joints, aligned with the thickness of the 35 mm Scrigno doors. Doors 20 mm thick in heat-treated Rovere. Doors of the glass cases with Scrigno frame in Brown coated metal and Fumé glass, interior with recessed LED spotlight. Cylindrical feet in Brown metal.

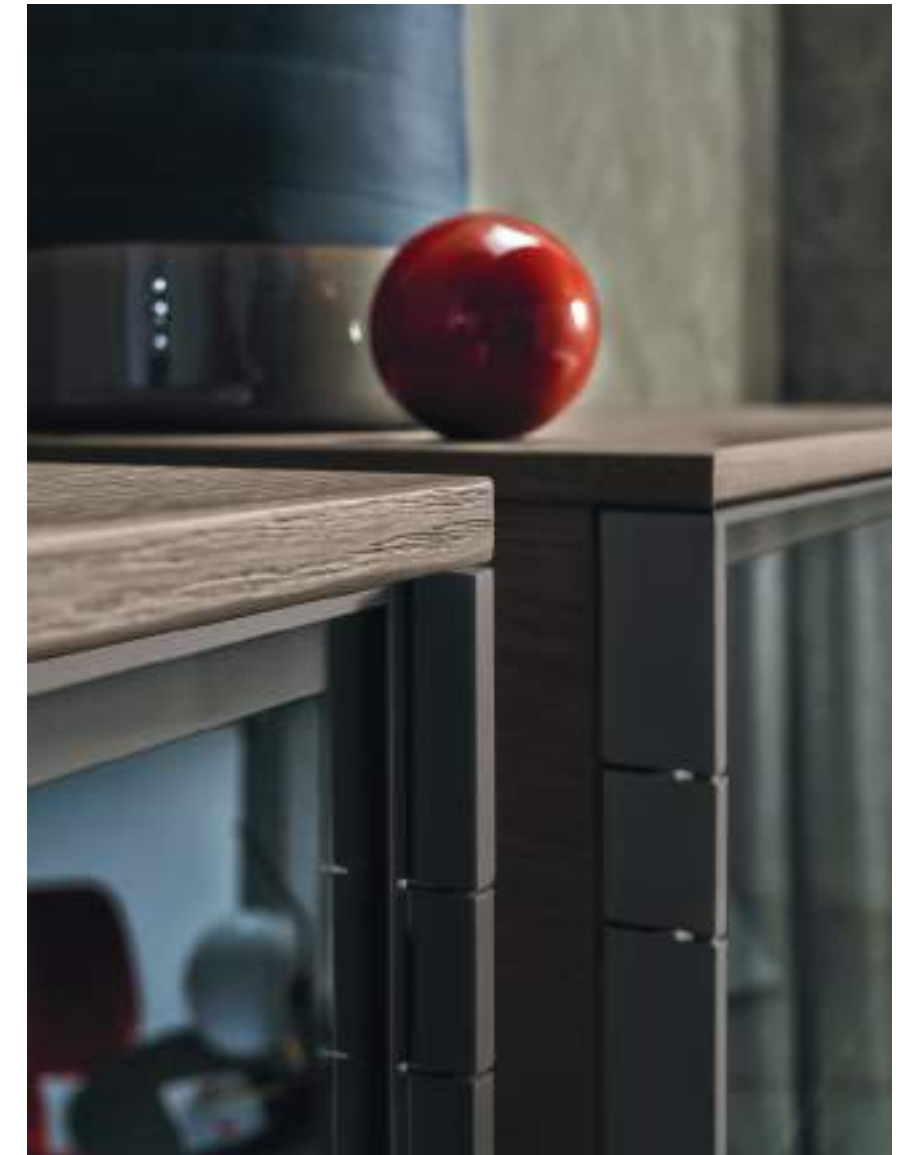

Scrigno 13 sx / dx
L / W 900 x H 1295 x P / D 465

Il telaio Scrigno si distingue per la particolare tecnologia delle cerniere, integrate nella cornice della vetrina: un dettaglio di alta qualità estetica, in un elemento d'arredo concepito per esporre gli oggetti più artistici e preziosi. Nelle immagini, si apprezza l'abbinamento fra le finiture Rovere Argilla della struttura con il telaio verniciato Piombo.

The Scrigno frame is notable for the particular technology of the hinges, integrated into the frame of the glass case: a detail of high aesthetic quality, in an item of furniture designed to display the most artistic and precious objects. In the images, one can admire the combination of the Rovere Argilla finish of the structure with the Piombo coated frame.



Scigno 316 dx
L / W 1065 x H 1330 x P / D 465

Il perimetro esterno delle madie Scigno può essere su quattro lati oppure, come in questa versione, su tre lati, con il quarto comprendente il telaio con anta Scigno e anta spessore 35 mm. Il cassetto interno opzionale può completare le possibilità di contenimento e organizzazione degli oggetti. Le immagini mostrano un abbinamento di sapore grafico fra le finiture Loto Natura e Piombo.

The outer perimeter of Scigno sideboards can be on four sides or, as in this version, on three sides, with the fourth comprising the frame with Scigno door and 35 mm thick door. The optional internal drawer offers further possibilities for storing and organising objects. The images show a graphic-inspired combination of the Loto Natura and Piombo.



Incontro

Incontro 42
L / W 1050 x H 1255 x P / D 465

Interpretazioni contemporanee di un elemento d'arredo tradizionale, le madie Incontro hanno strutture di dimensioni definite sulle quali vengono inseriti frontali di spessore 20 mm o 35 mm, con diverse finiture. Questo permette le più ampie caratterizzazioni: tono su tono oppure in contrasto, a seconda dei colori e dei materiali. Anche le aperture sono diversificate in base alla posizione del frontale: cassetti, anta battente o anta a ribalta. L'immagine a fianco presenta un abbinamento fra il laccato Brown e il Noce con frontali di spessore 35 mm.

Contemporary interpretations of a traditional item of furniture, Incontro sideboards have structures of defined dimensions on which front panels 20 mm or 35 mm thick are inserted, with different finishes. This allows the widest ranges of specifications – tonal or contrast, depending on the colours and the materials. The openings are also diversified based on the position of the front panel – drawers, side-hinged or flap door. The image opposite shows a combination of Brown lacquer and Noce with 35 mm thick front panels.



Incontro 42
L / W 1050 x H 1255 x P / D 465

Incontro 43
L / W 1050 x H 1255 x P / D 465



In questa pagina e nella precedente, due composizioni con Madie Incontro. Nella prima troviamo struttura e ante spessore 20 mm in laccato Brown opaco ed ante spessore 35 mm in impiallacciato Rovere nodato tinto Caramello. Nella seconda il gioco degli spessori dei frontali è inverso: struttura e ante spessore 35 mm in Magnolia opaco ed ante spessore 20 mm in impiallacciato Rovere nodato tinto Caramello. Le madie sono provviste di piedi cilindrici in metallo Brown.

On this page and the previous one, two compositions with Incontro sideboards. In the first, structure and doors 20 mm thick in matt Brown lacquer finish and doors 35 mm thick in Rovere Nodato veneer stained Caramello. In the second, the play on thicknesses of the front panels is reversed, with structure and doors 35 mm thick in matt Magnolia and doors 20 mm thick in Rovere Nodato veneer stained Caramello. The sideboards have cylindrical feet in Brown metal.

Incontro 11
L / W 2100 x H 775 x P / D 465

Come sospesa su supporti in metacrilato trasparenti, questa versione della madia Incontro ha struttura e frontali spessore 20 mm in laccato Terranova opaco ed ante spessore 35 mm in impiallacciato Rovere nodato Naturale.

As if suspended on supports in transparent methacrylate, this version of the Incontro sideboard has structure and front panels 20 mm thick in matt Terranova lacquer finish and doors 35 mm thick in Rovere Nodato Naturale veneer.





Incontro 12 pensile
L / W 2100 x H 655 x P / D 465

Incontro 18
L / W 2100 x H 670 x P / D 465

Giochi di superfici e tonalità scaturiscono dal diverso spessore dei frontali da 20 o 35 mm, in queste composizioni che presentano due diverse possibilità di ambientazione: sospesa a parete, oppure a terra. Nell'immagine a sinistra, le finiture sono Rovere Grigio e Ardesia opaco, in quella qui sopra Creta opaco e Canapa opaco.

Plays on surfaces and tones arise from the different thickness of the front panels of 20 or 35 mm, in these configurations with two possible choices of setting: wall-hung, or freestanding. In the image on the left, the finishes are Rovere Grigio and matt Ardesia, in the one above, matt Creta and matt Canapa.

Incontro 41 sx
L / W 1050 x H 1150 x P / D 465

Incontro 40 sx
L / W 1050 x H 1150 x P / D 465

Le madie Incontro consentono di creare i più diversi abbinamenti di finiture e superfici, come ad esempio una combinazione fra il Rovere Argilla impiallacciato con il laccato opaco Ardesia.

Incontro sideboards enable the creation of various combinations of finishes and surfaces, as for example a combination of Rovere Argilla veneer with matt lacquer Ardesia.





Incontro 31
L / W 2250 x H 935 x P / D 465

I frontali della media Incontro formano una geometria regolare, dall'effetto decorativo. Struttura e ante spessore 20 mm in laccato opaco Magnolia e frontali spessore 35 mm in laccato lucido Grigio corda, i piedi cilindrici sono in finitura Piombo.

The front panels of the Incontro sideboard form a regular geometry with decorative effect. Structure and doors 20 mm thick in matt Magnolia lacquer and front panels 35 mm thick in gloss Grigio Corda lacquer, while the cylindrical feet are in Piombo finish.



Incontro 33
L / W 1350 x H 1395 x P / D 465

Sul frontale della madia, un gioco geometrico che mette in scacco la monotonia, abbinando ante di spessore 35 mm in Rovere Argilla, con ante di spessore 20 mm in Juta opaco. Il tutto sostenuto da piedi in metallo Brown.

On the front panel of the sideboard, a geometric play drives boredom away, combining doors 35 mm thick in Rovere Argilla with doors 20 mm thick in matt Juta. All this is supported by feet in Brown metal.





Incontro 306 sx
L / W 2415 x H 790 x P / D 561

Dinamiche simmetrie per questa composizione con frontali di spessore 35 mm in impiallacciato Noce, abbinati a frontali di spessore 20 mm in laccato Canapa lucido. La madia è provvista di piedi cilindrici in metallo con finitura Brown.

Dynamic symmetries for this configuration with 35 mm thick front panels in Noce veneer, combined with 20 mm thick front panels in gloss lacquered Canapa. The sideboard has cylindrical metal feet with Brown finish.



Lampo deluxe

Lampo Deluxe 21
L / W 2100 x H 720 x P / D 561

Nel progetto Lampo Deluxe, gli essenziali e versatili elementi Lampo sono impreziositi dalle maniglie Skin in metallo, con impugnatura in Ecovintage: per un ambiente elegante e particolare. L'immagine mostra un esempio di madia in finitura Rovere Argilla.

In the Lampo Deluxe design, Lampo's minimalist, versatile elements are embellished by the metal Skin handles, with Ecovintage grip, for an elegant, special setting. The image shows an example of sideboard in Rovere Argilla finish.





Essenzialità che diventa pura bellezza. La maniglia Skin è un dettaglio di classe che si porge alla mano, mentre l'interno dei cassetti, attrezzati con divisori, rivela una sapiente funzionalità.

Understatement that becomes pure beauty. The Skin handle is a class detail within easy reach, while the interior of the drawers, fitted with dividers, reveals a clever practicality.





Lampo Deluxe 24
L / W 1200 x H 1200 x P / D 465

La maniglia Skin si presta ad interpretazioni decisamente originali e ricche di fascino, come questa versione con finitura metallica Bronzo e rivestimento in Ecovintage 19. La madia nelle immagini è in finitura Brown opaco con piedi sagomati.

The Skin handle offers decidedly original interpretations, rich in appeal, such as this version with Bronzo metallic finish and covering in Ecovintage 19. The sideboard in the images is in matt Brown finish with shaped feet.





Lampo basic

Base Lampo Basic 11
L / W 2400 x H 670 x P / D 542

Lampo Basic è un progetto che non lascia nulla al superfluo, ma allo stesso tempo genera una piacevole sensazione di calore e di eleganza naturale, inserendosi armoniosamente nell'architettura domestica. L'immagine mostra una composizione con madia laccata Antracite lucido e pensili laccati Corda opaco e Vinaccia opaco.

Lampo Basic is a design that leaves nothing superfluous, but at the same time generates a pleasant sensation of warmth and natural elegance, blending harmoniously into domestic architecture. The image shows a configuration with gloss lacquered Antracite sideboard and matt Corda and Vinaccia lacquered wall units.



Lampo Basic 12
L / W 1200 x H 1215 x P / D 450

Cambiando l'estetica della maniglia, il mobile si trasforma. In questo caso vediamo la madia Lampo in finitura Brown opaco con la maniglia Star orizzontale, come un segno grafico dominante, impreziosito dalla finitura metallica Ottone.

By changing the aesthetics of the handle, the unit is transformed. In this case we see the Lampo sideboard in matt Brown finish with the horizontal Star handle, as a dominant graphic sign, embellished by the Ottone metal finish.





Lampo open

Lampo Open 35 dx
L / W 1200 x H 1280 x P / D 350

Contenere ed esporre, due esigenze che la madia Open risolve nel segno di una moderna essenzialità e di una totale flessibilità. I vani a giorno, realizzati con giunzioni a 45°, offrono un'ampia scelta di misure modulari: in larghezza, altezza e profondità.

Storage and display, two requirements solved by the Open sideboard with modern understatement and total flexibility. The open compartments, made with 45° joints, offer a wide choice of modular sizes – width, height and depth.



Lampo Open 24
L / W 2400 x H 740 x P / D 450

Nella pagina precedente, la madia Open è proposta in vetro lucido Juta, laccato opaco Brown e Bianco 10 opaco. In queste pagine viene invece presentata in laccato opaco Ferro, Ardesia e Rovere Carbone, con base in metallo Brown.

On the previous page, the Open sideboard is shown in Juta polished glass, Brown matt lacquer finish and matt Bianco 10. On these pages, it is shown in Ferro, Ardesia and Rovere Carbone matt lacquer finish, with base in Brown metal.





Lampo Open 44
L / W 2130 x H 850 x P / D 465
Ombra • Rovere Carbone • piedi / feet H 180 Brown



Lampo Open 46
L / W 2130 x H 850 x P / D 465
Grigio Corda • Rovere Carbone • piedi / feet H 180 Brown



Lampo Open 43
L / W 2130 x H 850 x P / D 465

Un perimetro esterno che racchiude molteplici combinazioni dei frontali e del vano a giorno. In queste immagini, le medie Open si presentano con tre possibili abbinamenti fra il Rovere Carbone e il laccato Ferro, Ombra e Corda, sempre con basamento in finitura Brown.

An external perimeter that encloses multiple combinations of the front panels and the open compartment. In these images, Open sideboards are shown in three possible combinations of Rovere Carbone and lacquered Ferro, Ombra and Corda, always with base in Brown.

Lampo Open 33
L / W 900 x H 640 x P / D 450



Lampo Open 32
L / W 900 x H 640 x P / D 450

Lampo Open 31
L / W 900 x H 640 x P / D 450



Gli elementi Open Laterale permettono di aggiungere dei vani a giorno anche sul fianco della madia, permettendo la massima versatilità e libertà di utilizzo. Le immagini mostrano diverse composizioni con finiture Terracotta opaco, Grigio Corda e Magnolia.

The Open Laterale elements allow you to add open compartments on the side of the sideboard, too, allowing maximum versatility and freedom of use. The images show different configurations with matt Terracotta, Grigio Corda and Magnolia finishes.

Uno stile nordico che si propone con i colori della tradizione e un fascino senza confini. Dal Noce al laccato opaco Bianco 10, Grigio Corda e Terracotta, Timo, Oltremare e Pervinca opaco, le immagini mostrano molteplici giochi di tonalità in diverse varianti. Piedi cilindrici Piombo.

A Nordic style that offers the colours of tradition and boundless charm. From Noce to matt lacquered Bianco 10, Grigio Corda and Terracotta, Timo, Oltremare and matt Pervinca, the images show multiple plays on tones in different variations. Cylindrical feet in Piombo.

Lampo Open 47
L / W 1230 x H 1330 x P / D 465



Lampo Open 47
L / W 1230 x H 1330 x P / D 465



Lampo Open 47
L / W 1230 x H 1330 x P / D 465

Obi



Il basamento del tavolo Obi, dal dinamico design, è in metallo verniciato e può supportare diversi piani, sia ovali che rettangolari, disponibili in materico, in essenza, in vetro o in varie finiture. Ceramica: ogni piano ha diversi dettagli nella lavorazione, a seconda della variante. In questa immagine il piano L 2450 mm è in ceramica Statuarietto con basamento in metallo finitura Piombo.

The base of the Obi table, with its dynamic design, is in coated metal and can support different tops, both oval and rectangular, available in textural finish, wood, glass or various Ceramic finishes: each top is made differently, depending on the variant. In this image, the W 2450 mm top is in Statuarietto ceramic with a metal base in Piombo.

Tavolo Obi

L / W 2450 x H 732 x P / D 1020

Il tavolo Obi è qui presentato nella versione L 2450 mm, con piano in ceramica Statuarietto e basamento in metallo con finitura Ottone, abbinato alle sedie Alice con struttura in Rovere Carbone, sedile e schienale con rivestimento in ecopelle Talpa. Nella pagina precedente il tavolo Obi è presentato sempre con piano Statuarietto con basamento Piombo.

Obi table is shown here in L 2450 mm, with Statuarietto ceramic top and metal base in Ottone, combined with Alice chairs with Rovere Carbone structure, seat and backrest covered in Talpa eco-leather. On the previous page, Obi table shown again with Statuarietto top and base in Piombo.





Tavolo Obi
L / W 2100 x H 750 x P / D 1020

In questa variante, il piano ovale del tavolo Obi è in finitura Rovere Termotrattato con lavorazione a saponetta sui bordi e basamento in metallo Piombo. In abbinamento troviamo le sedute Eva, nella versione senza braccioli con gambe in massello tinto Rovere Termotrattato e seduta in pelle Grigio.

In this version, the oval top of the Obi table is in heat-treated Rovere finish with rounded edges and base in Piombo metal. It is coordinated with Eva chairs, in the version without armrests with solid wood legs stained in heat-treated Rovere and seat in Grigio leather.





Tavolo Obi
L / W 2000 x H 750 x P / D 1020

Stile nordico per questa versione del tavolo Obi, caratterizzata dal piano ovale in Rovere Nodato naturale di spessore 30 mm con bordo dritto e basamento in metallo Brown. Le sedute Eva sono qui proposte nella versione con braccioli con gambe in tinta Rovere Carbone e seduta in ecopelle Sahara.

Nordic style for this version of the Obi table, featuring the oval top in natural Rovere Nodato 30 mm thick, straight edged, and base in Brown metal. The Eva chairs shown here are in the version with armrests, with matching Rovere Carbone legs and seat in Sahara eco-leather.



Tavolo Obi
L / W 2450 x H 732 x P / D 1020

Il vetro Fumé crea un gioco di trasparenze e ombre con la struttura metallica, a sua volta caratterizzata da geometrie eleganti e attentamente studiate. Basamento in metallo Brown. Sedia Linda sfoderabile in ecopelle Grafite.

The Fumé glass creates a play on transparencies and shadows with the metal structure, which has elegant, carefully designed geometries. Base in Brown metal. Linda chair with removable cover in Grafite eco-leather.





Obi

Piano in vetro fumè trasparente temperato
Transparent tempered smoked glass top

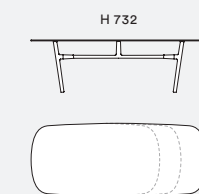

L/W 1800 x P/D 1020
L/W 2100 x P/D 1020
L/W 2450 x P/D 1020

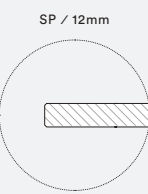

Piano in legno impiallacciato bordo sagomato
Top in veneered wood with shaped edge

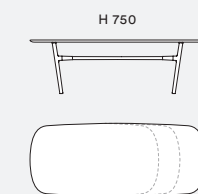

L/W 1800 x P/D 1020
L/W 2100 x P/D 1020
L/W 2450 x P/D 1020

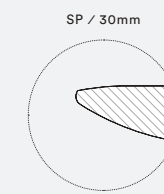

Piano in legno impiallacciato o materico bordo dritto
Top in veneered or textural finish with straight edge

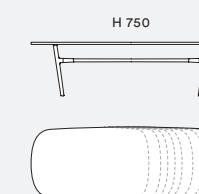

L/W 1800 x P/D 1020
L/W 1900 x P/D 1020
L/W 2000 x P/D 1020
L/W 2100 x P/D 1020
L/W 2200 x P/D 1020
L/W 2300 x P/D 1020
L/W 2450 x P/D 1020
L/W 2600 x P/D 1020
L/W 2800 x P/D 1020

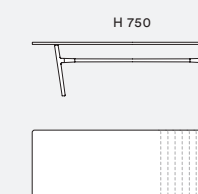

L/W 1800 x P/D 870
L/W 1900 x P/D 870
L/W 2000 x P/D 870
L/W 2100 x P/D 870
L/W 2200 x P/D 870
L/W 2300 x P/D 870
L/W 2450 x P/D 870
L/W 2600 x P/D 870
L/W 2800 x P/D 870

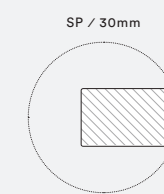

Piano in ceramica bordo smussato
Rounded edge ceramic top

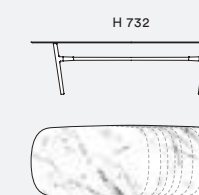

L/W 1800 x P/D 1020
L/W 1900 x P/D 1020
L/W 2000 x P/D 1020
L/W 2100 x P/D 1020
L/W 2200 x P/D 1020
L/W 2300 x P/D 1020
L/W 2450 x P/D 1020
L/W 2600 x P/D 1020
L/W 2800 x P/D 1020

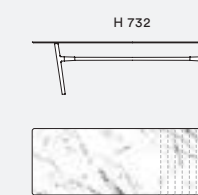

L/W 1800 x P/D 870
L/W 1900 x P/D 870
L/W 2000 x P/D 870
L/W 2100 x P/D 870
L/W 2200 x P/D 870
L/W 2300 x P/D 870
L/W 2450 x P/D 870
L/W 2600 x P/D 870
L/W 2800 x P/D 870

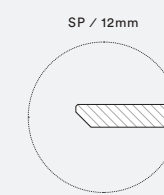

Tavolo Obi
L / W 2100 x H 732 x P / D 1020

Il tavolo Obi trova un'espressione di alta raffinatezza, da autentico protagonista dell'ambiente, nella versione con piano ovale in vetro Fumé trasparente L 2100 mm e basamento in finitura Piombo. Sedie Linda sfoderabili in ecopelle Grafite.

The Obi table achieves an expression of high sophistication, as the real star of the room, in the version with oval top in transparent Fumé glass L 2100 mm and base in Piombo finish. Linda chairs with removable cover in Grafite eco-leather.



Vertigo

Tavolo Vertigo
L / W 2450 x H 750 x P / D 1020

Il tavolo Vertigo ha un basamento in metallo verniciato che si allarga verso il basso, fornendo un ampio appoggio. Questa struttura può supportare diversi piani, sia ovali che rettangolari, disponibili in materico, impiallacciato o in varie finiture ceramica con bordi smussati e diverse caratteristiche nella lavorazione, a seconda della variante.

The Vertigo table has a coated metal base that widens downwards, providing ample support. This structure can support different tops, both oval and rectangular, available in textural finish, veneer or in various ceramic finishes with rounded edges and different processing characteristics, depending on the variant.



Tavolo Vertigo
L / W 2450 x H 750 x P / D 1020

Il tavolo Vertigo è contraddistinto dal design del basamento in metallo, mentre il piano può avere diverse forme e finiture. Qui è in Rovere Argilla di forma ovale, con bordo sagomato a saponetta e dimensione L 2450 mm con basamento Piombo. Sedie Eva con gambe in rovere tinto Argilla e rivestimento in ecopelle Fumo.

The Vertigo table is distinctive in the design of its metal base, while the top can have various shapes and finishes. Here it is in Rovere Argilla, oval in shape with rounded edge, L 2450 mm, with base in Piombo. Eva chairs with oak legs stained in Argilla and Fumo eco-leather upholstery.



Tavolo Vertigo

L / W 2100 x H 750 x P / D 870

Caratterizzato dal disegno geometrico del basamento, Vertigo è pensato per inserirsi in qualsiasi ambiente e permettere un abbinamento ideale con molteplici tipologie di sedute, grazie alle sue linee essenziali e armoniose.

Characterized by the geometric design of its base, Vertigo is designed to fit into any environment and allow an ideal combination with multiple types of seating, thanks to its minimalist, harmonious lines.





Nell'immagine a fianco, Vertigo si presenta con piano in Rovere Termotrattato, con angoli arrotondati, basamento in metallo Brown ed è abbinato alle sedute Eva senza braccioli, con rivestimento in pelle Grigio e gambe in tinta.

In the image opposite, Vertigo has a heat-treated Rovere top, with rounded corners, base in Brown metal and is combined with Eva chairs without armrests, with Grigio leather upholstery and matching legs.



L'immagine mostra il tavolo Vertigo con piano L 2600 mm in ceramica finitura Noir Desir, di spessore 12 mm, con bordo smussato e basamento Bronzo. Un elemento d'arredo prezioso e importante, completato dalle morbide e avvolgenti sedie Eva con gambe in Rovere Carbone e rivestimento in pelle Marna.

The image shows the Vertigo table with L 2600 mm ceramic top in Noir Desir finish, 12 mm thick, with rounded edge and base in Bronzo. A precious and important piece of furniture, completed by soft, comfortable Eva seating with legs in Rovere Carbone and upholstery in Marna leather.



Vertigo

Piano in legno impiallacciato bordo sagomato Top in veneered wood with shaped edge

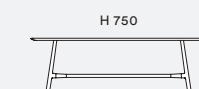

L/W 1800 x P/D 1020
L/W 2100 x P/D 1020
L/W 2450 x P/D 1020

SP / 30mm

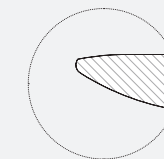

Piano in legno impiallacciato o materico bordo dritto Top in veneered or textural finish with straight edge

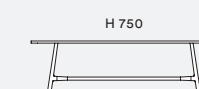

L/W 1650 x P/D 1020
L/W 1800 x P/D 1020
L/W 1900 x P/D 1020
L/W 2000 x P/D 1020
L/W 2100 x P/D 1020
L/W 2250 x P/D 1020
L/W 2400 x P/D 1020
L/W 2600 x P/D 1020

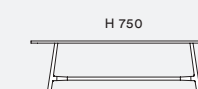

L/W 1650 x P/D 870
L/W 1800 x P/D 870
L/W 1900 x P/D 870
L/W 2000 x P/D 870
L/W 2100 x P/D 870
L/W 2250 x P/D 870
L/W 2400 x P/D 870
L/W 2600 x P/D 870

SP / 30mm

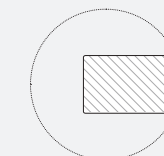

Piano in ceramica bordo smussato Rounded edge ceramic top

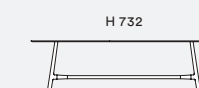

L/W 1650 x P/D 1020
L/W 1800 x P/D 1020
L/W 1900 x P/D 1020
L/W 2000 x P/D 1020
L/W 2100 x P/D 1020
L/W 2250 x P/D 1020
L/W 2400 x P/D 1020
L/W 2600 x P/D 1020

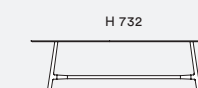

L/W 1650 x P/D 870
L/W 1800 x P/D 870
L/W 1900 x P/D 870
L/W 2000 x P/D 870
L/W 2100 x P/D 870
L/W 2250 x P/D 870
L/W 2400 x P/D 870
L/W 2600 x P/D 870

SP / 12mm

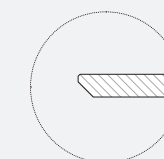



Bistrot

Tavolo Bistrot
Ø 1400 x H 750

Il tavolo Bistrot è caratterizzato dalle gambe sagomate e inclinate per dare supporto a vari tipi di piano: rotondo, quadrato, rettangolare e ovale, in finitura materica, impiallacciato o in ceramica con bordo smussato. In questa immagine vediamo il piano rotondo, con piano in impiallacciatura di Rovere Termotrattato. Sedie Charlotte con rivestimento in ecopelle Ghiaia e gambe in finitura Rovere Termotrattato.

The Bistrot table features shaped legs, slanted to support various types of tops: round, square, rectangular and oval, in textural finish, veneered or in ceramic with rounded edge. In this image we see the round top, with heat-treated Rovere veneer top. Charlotte chairs upholstered in Ghiaia eco-leather and legs in heat-treated Rovere finish.



Tavolo Bistrot
Ø 1300 x H 732

È adatto a molte situazioni diverse, sempre con una personalità inconfondibile, il tavolo Bistrot rotondo con piano da 1300 mm di diametro in finitura ceramica Ossido Bruno e gambe in frassino tinto Noce. Le gambe delle sedie Charlotte, con scocca rivestita in pelle Canapa, hanno la stessa particolare sagomatura di quelle del tavolo.

Suitable for many different situations, always with an impeccable appearance, Bistrot round table with 1400 mm diameter top, in ceramic Ossido Bruno finish and Frassino Noce-stained legs. The legs of the Charlotte chairs, with shell covered in Canapa leather, have the same unusual shape as those of the table.



Tavolo Bistrot

L / W 1800 x H 750 x P / D 870

Il tavolo Bistrot, con piano ovale L 1800 mm, è qui in versione con bordo dritto di spessore 30 mm, in finitura Rovere nodato caramello. L'abbinamento è con le snelle ed accoglienti sedute Charlotte con gambe in Rovere tinta Caramello e rivestimento in ecopelle Testa di moro.

The Bistrot table, with oval top L 1800 mm, here in the version with straight edge 30 mm thick, in Rovere Nodato Caramello finish. The combination is with the slim, comfortable Charlotte chairs with Caramello-stained oak legs and upholstery in Testa di Moro eco-leather.





Bistrot

Piano in legno impiallacciato o materico bordo dritto
Top in veneered or textural finish with straight edge

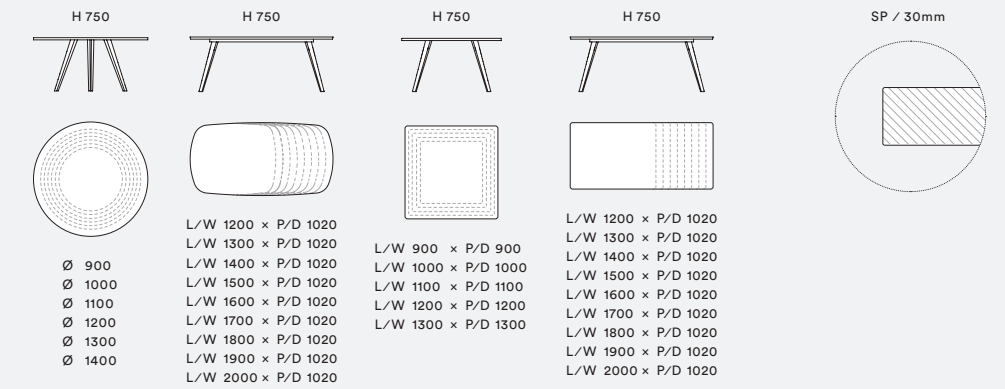

Piano in ceramica bordo smussato
Rounded edge ceramic top

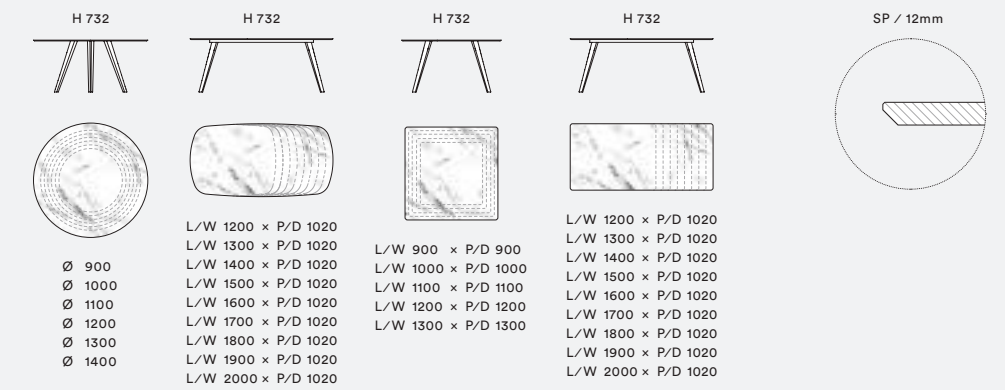

Tavolo Bistrot
L / W 1300 x H 750 x P / D 1300

Ricorda il razionalismo nordico questa versione di Bistrot in Noce impiallacciato, con piano di spessore 30 mm caratterizzato dal bordo leggermente arrotondato. Sedie Linda con rivestimento sfoderabile in pelle Caffè.

This version of Bistrot in Noce veneer references Nordic rationalism, with a 30 mm thick top having a slightly rounded edge. Linda chairs with removable cover in Caffè leather.

Desco



Il tavolo Desco è caratterizzato dalle gambe sagomate in legno che si ispirano alla tradizione, senza rinunciare a un retrogusto contemporaneo. Il piano, quadrato o rettangolare, può essere impiallacciato con spessore 25 mm e bordo smussato, oppure in ceramica con spessore 12 mm, sempre con bordi smussati e in versione fissa o allungabile. Sedie Alice in Rovere Carbone con rivestimento in ecopelle Talpa.

The Desco table is notable for its shaped wooden legs that are inspired by tradition, without renouncing a hint of the contemporary. The top, square or rectangular, can be veneered with a thickness of 25 mm and a rounded edge, or in ceramic with a thickness of 12 mm, also with rounded edges and in a fixed or extendable version. Alice chairs in Rovere Carbone with Talpa eco-leather upholstery.



Tavolo Desco quadrato fisso
L / W 1400 x H 742 x P / D 1400

Dettagli della gamba sagomata in legno e del piano in ceramica, di spessore 12 mm e lavorazione del bordo a 45° che crea un effetto di raffinata leggerezza.

Details of the shaped wooden leg and the ceramic top, 12 mm thick and edge cut at 45°, which creates an effect of refined lightness.

Nel tavolo Desco la lavorazione del piano e le gambe dal volume generoso creano un effetto estetico che caratterizza qualsiasi scenario domestico, adattandosi a una varietà di stili e situazioni. Sedie Alice in Rovere Carbone con rivestimento in pelle Tabacco.

In the Desco table, the manufacture of the top and the generously-sized legs create an aesthetic effect that characterises any type of home, adapting to a variety of styles and situations. Alice chairs in Rovere Carbone with Tabacco eco-leather upholstery.





Tavolo Desco quadrato allungabile
L / W 1250+700 x H 755 x P / D 1250

Il tavolo Desco quadrato, qui in versione Rovere Carbone, è dotato di un meccanismo di allungo a libro che permette di trasformarlo in un tavolo rettangolare, con pochi e semplici gesti.

The square Desco table, here in Rovere Carbone version, has a folding leaf mechanism, which allows it to be transformed into a rectangular table, with a few, simple gestures.





Tavolo Desco
L / W 2050 x H 745 x P / D 950

Piacevolmente austero, il tavolo Desco rettangolare, presentato in Rovere Argilla e abbinato alle sedute Eva senza braccioli, con gambe in tinta e rivestimento in ecopelle Limo.

Pleasingly understated, the rectangular Desco table, shown in Rovere Argilla and combined with Eva chairs without armrests, with matching legs and Limo eco-leather upholstery.



Tavolo Desco rettangolare allungabile
L / W 2050+500+500 x H 755 x P / D 950

Il tavolo Desco rettangolare, che vediamo in versione Rovere Argilla, comprende due allunghi collocati in un apposito alloggiamento sotto il piano, facilmente estraibili all'occorrenza.

The rectangular Desco table, which we see here in the Rovere Argilla version, has two leaves placed in a special housing under the top, that can easily be pulled out if needed.





Desco

Piano in legno impiallacciato bordo smussato
Top in veneered wood with rounded edge

Fisso

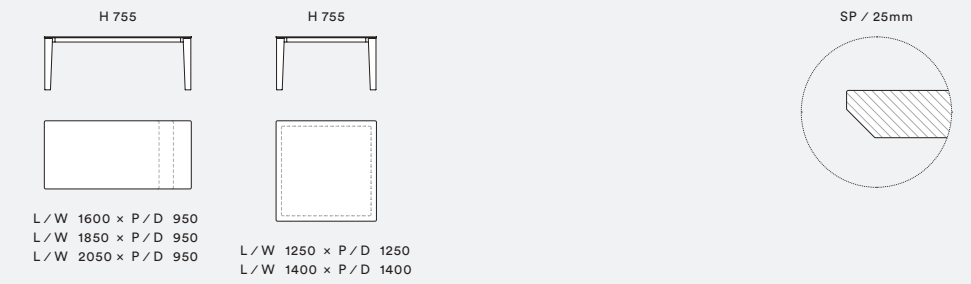

Allungabile

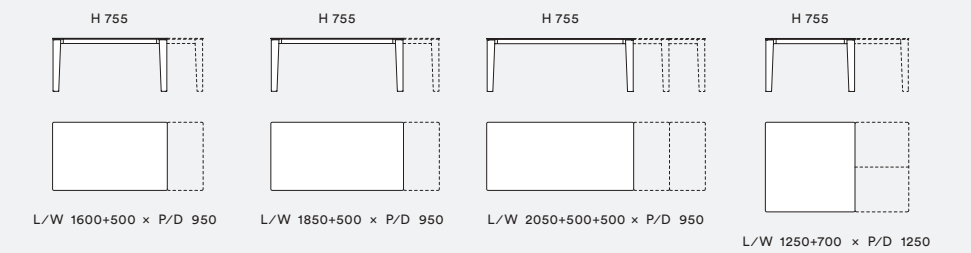

Piano in ceramica bordo smussato
Rounded edge ceramic top

Fisso

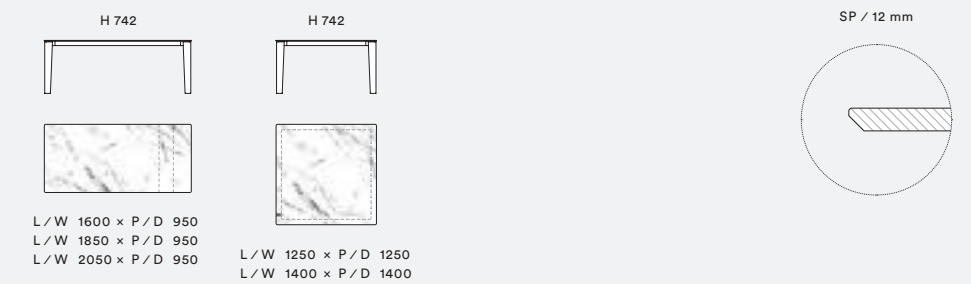

Allungabile

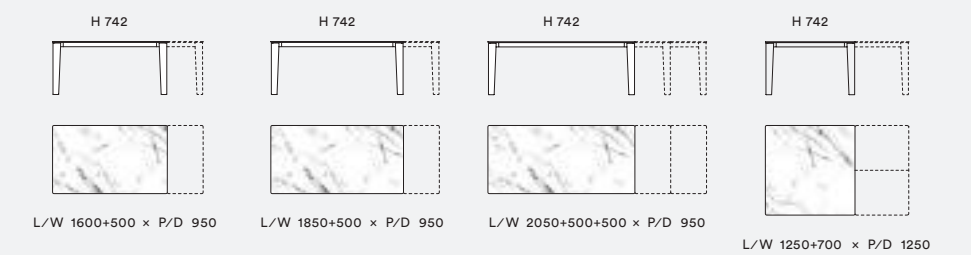

Tavolo Desco
L / W 1850 x H 742 x P / D 950

I tavoli Desco si distinguono per il contrasto fra le gambe corpose e il piano sottile, quadrato o rettangolare, in versione fissa o allungabile. La scelta fra diverse finiture del piano e delle gambe, permette di dare vita a molteplici possibilità cromatiche e stilistiche. Nell'immagine, un esempio con piano in ceramica Nero Greco lucido e gambe Creta laccato lucido, in abbinamento alle sedie Linda rivestite in pelle Grigio.

Desco tables are striking for the contrast between the full-bodied legs and the slender top, square or rectangular, in fixed or extendable version. The choice between different finishes of top and legs allows for multiple chromatic and stylistic possibilities. In the image, an example with gloss Nero Greco ceramic top and gloss lacquered Creta legs, combined with Linda chairs covered in Grigio leather.



Iron

Iron, una proposta di tavoli fissi con basamento in acciaio sagomato al laser con bordi raggati, disponibile in varie finiture di metallo verniciato come il Brown, Piombo, Bronzo, Ottone, Rame. Il piano ha una presenza importante e corposa nella versione impiallacciata, di spessore 30/35 mm, con faccia inferiore sagomata sui bordi, laccata e verniciata. Più lineare e leggero il piano nella versione in ceramica, di spessore 12 mm con bordo smussato.

Iron, a range of fixed tables with laser-shaped steel base with rounded edges, available in various coated metal finishes such as Brown, Piombo, Bronzo, Ottone, Rame. The top has a strong, voluminous presence in the veneered version, 35 mm thick, with the lower surface shaped on the edges, lacquered and coated. The top in ceramic version, 12 mm thick, with rounded edge, is more linear and lightweight.



Tavolo Iron
L / W 2750 x H 750 x P / D 1140

Dimensioni importanti per questa variante del tavolo Iron: ben 2750 mm di lunghezza per un elemento che caratterizza l'intero spazio circostante. Il top è impiallacciato in Rovere Termotrattato, mentre il sottopiano è in laccato opaco Brown, con basamento metallico in tinta. Le sedie Linda con rivestimento in pelle Marna sono sfoderabili.

Large dimensions for this version of the Iron table – 2750 mm of length for a furniture item that is a feature of the entire surrounding space. The top is veneered in heat-treated Rovere while the lower surface is in matt Brown lacquer finish with same colour metal base. Linda chairs with Marna leather upholstery have removable covers.



Tavolo Iron
Ø 1400 x H 750

Perfettamente a suo agio anche in un contesto romantico, il tavolo Iron rotondo con piano impiallacciato Rovere Termotrattato, sottopiano e gambe in finitura metallo Ottone. Sedie Alice con struttura in finitura Rovere Carbone e rivestimento in pelle Nocciola.

Perfectly at ease also in a romantic setting, the round Iron table with heat-treated Rovere veneer top, sub-top and legs in Ottone metal finish. Alice chairs with structure in Rovere Carbone and Nocciola leather upholstery.



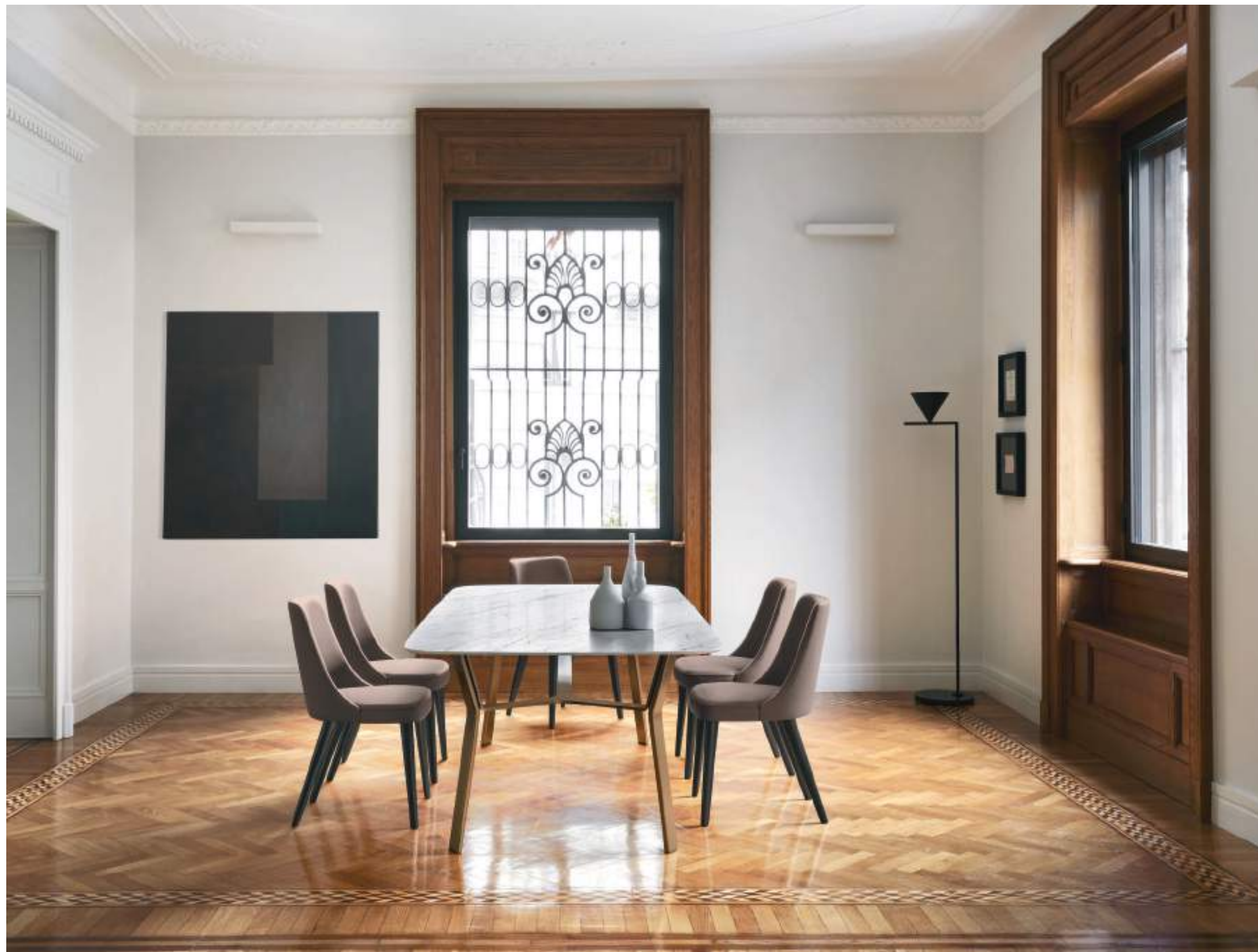

Tavolo Iron
L / W 2250 x H 727 x P / D 1140

In totale sintonia con il contesto architettonico d'interni, il tavolo Iron con piano in ceramica e basamento metallico in finitura Bronzo. La ceramica Statuarietto, con le sue rade e sottili venature grigie sul fondo chiaro, impreziosisce il piano dai bordi piacevolmente smussati. Sedie Eva in Rovere Carbone con rivestimento in ecopelle Talpa.

Totally in tune with the interior architectural context, the Iron table with ceramic top and metal base in Bronzo finish. The Statuarietto ceramic, with its sparse, fine grey veining on a light background, embellishes the top with pleasingly rounded edges. Alice chairs in Rovere Carbone with Talpa eco-leather upholstery.



Iron

Piano in legno impiallacciato bordo sagomato laccato
Top in veneered wood with lacquered shaped edge

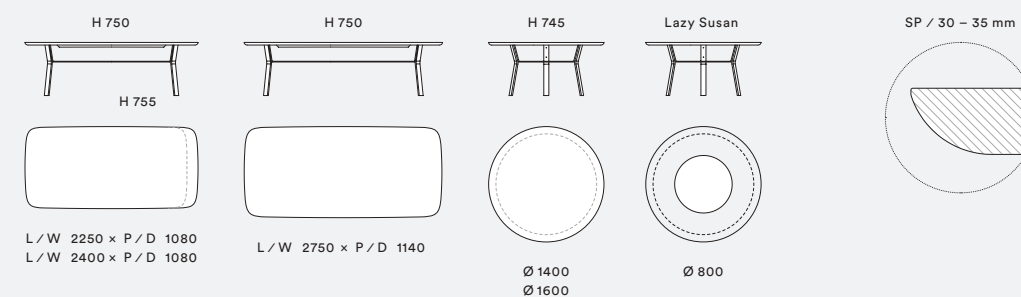

Piano in ceramica bordo smussato
Rounded edge ceramic top

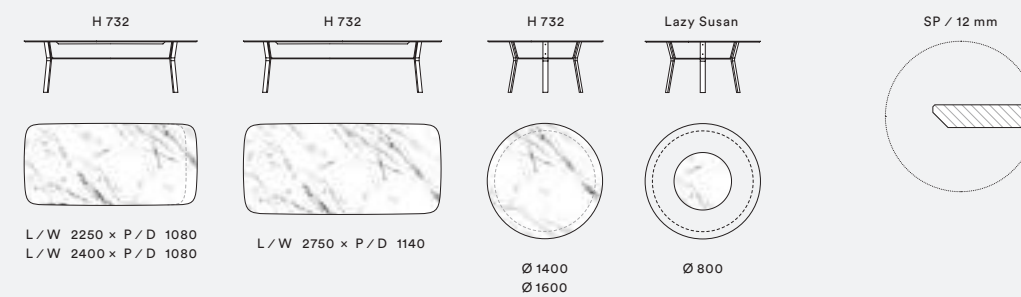



Convivio



Gambe corpose e arrotondate per Convivio, un tavolo che gioca un ruolo centrale nello spazio. Può essere in versione con piano impiallacciato e bordi sagomati in finitura laccata, di spessore 35 mm, oppure in ceramica di spessore 12 mm, più lineare e leggero.

Large rounded legs for Convivio, a table that plays a central role in its space. Available with a veneer top and shaped edges in lacquer finish, 35 mm thick, or in 12 mm thick ceramic, which is more linear and lighter.



Tavolo Convivio
L / W 2750 x H 750 x P / D 1140

Signorile e moderno allo stesso tempo, con le sue forme piacevolmente arrotondate, il tavolo Convivio è qui presentato in Rovere Carbone con sottopiano Piombo. Sedie Alice con struttura in Rovere Carbone e rivestimento in pelle Smoke.

Aristocratic and modern at the same time, with its pleasingly rounded shapes, the Convivio table is shown here in Rovere Carbone with Piombo sub-top. Alice chairs with structure in Rovere Carbone and Smoke leather upholstery.



Tavolo Convivio
L / W 2250 x H 727 x P / D 1140

Raffinata e contemporanea questa versione del tavolo Convivio con piano L 2250 mm in Ceramica Noir Desir lucido, gambe in Rovere Carbone e sedute Linda completamente rivestite in pelle Grigio.

Refined, contemporary version of the Convivio table with L 2250 mm top in gloss Noir Desir Ceramic, legs in Rovere Carbone and Linda seats completely upholstered in Grigio leather.



Il tavolo Convivio si presenta qui in versione rotonda, con piano in Rovere Termotrattato di diametro 1600 mm e bordo sagomato laccato Brown. Le gambe sono in Rovere Carbone, come la struttura delle sedie Alice, con seduta e schienale in pelle Marna.

The Convivio table is shown here in a round version, with 1600 mm diameter heat-treated Rovere top and shaped edge lacquered in Brown. The legs are in Rovere Carbone, as is the structure of the Alice chairs, with seat and back in Marna leather.



Il tavolo rotondo Convivio è qui presentato con il piano girevole Lazy Susan, un optional che arricchisce il piacere di stare insieme e contribuisce a rendere ancora più interessante e originale questo elemento d'arredo.

The Convivio round table is shown here with a Lazy Susan turntable, an option that adds to the pleasure of being in company and contributes to making this piece of furniture even more interesting and original.





Convivio

Piano in legno impiallacciato bordo sagomato laccato
Top in veneered wood with lacquered shaped edge

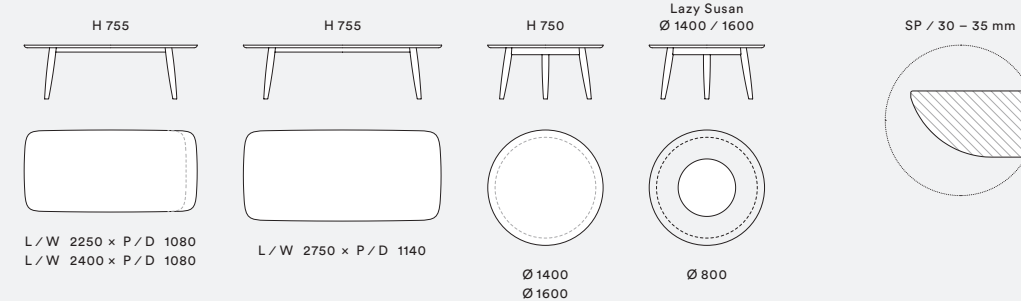

Piano in ceramica bordo smussato
Rounded edge ceramic top

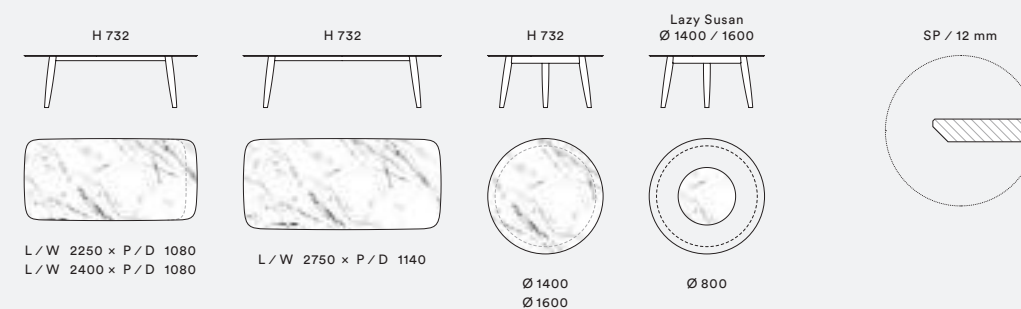

Tavolo Convivio
Ø 1400 x H 755

Nell'ambientazione qui a fianco, vediamo il tavolo rotondo Convivio con basamento in Rovere Carbone e piano in ceramica Statuarietto, con lavorazione smussata dei bordi. Sedie Eva con braccioli in Rovere Carbone e rivestimento in Ecopelle Limo.

In the setting opposite, we see the round Convivio table with base in Rovere Carbone and top in Statuarietto ceramic, with rounded edges. Eva chairs in Rovere Carbone with Limo eco-leather upholstery.



Linda

Sedia Linda
L / W 460 x H 840 x P / D 550

Morbida e allo stesso tempo elegantemente essenziale, la sedia Linda ha una struttura interna in metallo, con rivestimento sfoderabile in tessuto, ecopelle o pelle.

Soft and at the same time elegantly minimalist, the Linda chair has an internal metal structure, with removable cover in fabric, eco-leather or leather.



Eva

Sedia Eva
L / W 460 x H 460 / 810 x P / D 500

La sedia Eva associa linee avvolgenti e dinamica versatilità d'uso. La struttura è in massello di Frassino tinto Rovere o tinto Noce, lo schienale è in multistrato di betulla curvato, il rivestimento non sfoderabile è in tessuto, ecopelle o pelle.

The Eva chair associates wraparound lines with dynamic versatility of use. The structure is in solid ashwood stained Rovere or Noce, with backrest in curved birch plywood, and non-removable cover in fabric, eco-leather or leather.



Eva con braccioli

Sedia Eva con braccioli
L / W 500 x H 460 / 810 x P / D 500



La sedia Eva è disponibile anche in versione con braccioli, sempre con un design avvolgente. La struttura è in massello di Frassino tinto Rovere o tinto Noce, lo schienale è in multistrato di Betulla curvato, il rivestimento non sfoderabile è in tessuto, ecopelle o pelle.

The Eva chair is also available in a version with armrests, always with wraparound design. The structure is in solid ashwood stained Rovere or Noce, with backrest in curved birch plywood, and non-removable cover in fabric, eco-leather or leather.



Alice

Sedia Alice
L / W 500 x H 480 / 810 x P / D 550

La sedia Alice offre un piacevole comfort.
La struttura è in massello di Frassino tinto Rovere
o tinto Noce, lo schienale è in multistrato di Betulla
curvato, il rivestimento non sfoderabile è in tessuto,
ecopelle e pelle.

The Alice chair is wonderfully comfortable.
The structure is in solid ashwood stained Rovere
or Noce, with backrest in curved birch plywood,
and non-removable cover in fabric,
eco-leather or leather.



Charlotte

Sedia Charlotte
L / W 470 x H 470 / 840 x P / D 550



La sedia Charlotte unisce semplicità e comfort, con uno stile elegante. La struttura è in massello di Frassino tinto Rovere o tinto Noce, la scocca è in Betulla curvato, il rivestimento non sfoderabile è in tessuto, ecopelle e pelle.

The Charlotte chair combines simplicity and comfort with elegant style. The structure is in solid ashwood stained Rovere or Noce, with shell in curved birch plywood, and non-removable cover in fabric, eco-leather or leather.



Lotus

Tavolino Lotus alto
Ø 500 × H 500

Tavolino Lotus medio
Ø 600 × H 440

Tavolino Lotus basso
Ø 900 × H 365

Tavolino Lotus con vassoio
Ø 515 × H 440
Ø 515 × H 500

Lotus, versatili tavolini dal sapore vintage disponibili con piano in legno laccato o impiallacciato di spessore 20 mm, in ceramica con bordo smussato spessore 12 mm, o completamente in metallo. Il basamento è realizzato in metallo laccato Brown, Piombo, Bronzo, Ottone, Rame.

Lotus, versatile small tables with a vintage flavour available with top in lacquered or veneered wood 20 mm thick, or in ceramic with 12 mm thick rounded edge. The base is made of Brown, Piombo, Bronzo, Ottone or Rame lacquered metal.



I tavolini Lotus si arricchiscono di ulteriori finiture e materiali: a sinistra i piani laccati con effetto metallico, a destra i piani Ceramica in finitura Noir Desir lucido.

Lotus small tables are enriched by additional finishes and materials. On the left, the lacquer finish tops with metallic effect, on the right, the ceramic tops in gloss Noir Desir finish.



Tavolino Lotus alto con vassoio in metallo
 Ø 515 x H 500

Tavolino Lotus basso con vassoio in metallo
 Ø 515 x H 440

Servizievoli e chic, i tavolini Lotus in versione con piano a vassoio, dai bordi rialzati, si propongono in versione laccata metallica Rame, Ottone, Piombo, Bronzo e Brown.

Handy and chic, Lotus small tables with raised-edge tray tops are available in Rame, Ottone, Piombo, Bronzo and Brown metallic lacquered finish.



Tavolino Lotus medio con piano sagomato
 Ø 515 x H 440



Iris

Tavolino Iris
L / W 1400 x H 475 x P / D 700

Tavolino Iris alto
Ø 500 x H 525

Tavolino Iris medio
Ø 600 x H 475

Ispirazione retrò ma funzionalità contemporanea per i tavolini Iris, disponibili con piano in legno laccato o impiallacciato di spessore 20 mm, oppure in ceramica con bordo smussato di spessore 12 mm. Il basamento è realizzato in fusione di alluminio in finitura Nickel Black lucido o laccato metallico Brown, Piombo, Bronzo, Ottone, Rame.

Retro inspiration but contemporary functionality for the Iris small tables, available with top in lacquered or veneered wood 20 mm thick, or in ceramic with 12 mm thick rounded edge. The base is made of cast aluminium in gloss Nickel Black or metallic lacquer Brown, Piombo, Bronzo, Ottone or Rame.



La raffinata matericità del piano in ceramica con finitura Noir Desir, disponibile anche nelle varianti Ossido Bruno, Pietra Savoia Antracite, Nero Greco, Statuarietto, Emperador Extra.

The refined texture of the ceramic top with Noir Desir finish, also available in the variants Ossido Bruno, Pietra Savoia Antracite, Nero Greco, Statuarietto, Emperador Extra.





Trio

Tavolino Trio alto
Ø 500 x H 464

Tavolino Trio medio
Ø 600 x H 400

Tavolino Trio basso
Ø 900 x H 305

Con i tavolini Trio, gioco e colore si introducono nella zona giorno o nello spazio notte. Disponibili con piano in tre dimensioni, in finitura laccato opaco, permettono di creare le più diverse composizioni.

With the Trio small tables, playfulness and colour are brought to the living area or bedroom. Available with three dimensions of top, in matt lacquered finish, they allow one to create the most diverse configurations.



Da soli, in coppia, in tre, i tavolini Trio si prestano a creare le più diverse combinazioni di colori e dimensioni, a seconda delle esigenze dell'ispirazione del momento.

Alone, in pairs, in three, the Trio coffee tables lend themselves to creating very different combinations of colour and dimension, according to requirements or the inspiration of the moment.



Madera

Questi tavolini nascono per esaltare il legno (Rovere nodato Naturale e Caramello, oppure Rovere Termotrattato) unendo forme moderne e lavorazione tradizionale. Hanno due diverse misure di altezza e diametro, per rispondere alle varie necessità dell'abitare (H 520 mm con diametro 450 mm / H 375 mm con diametro 600 mm) e possono vivere singolarmente o in composizioni multiple.



These small tables were created to enhance the wood (Rovere Nodato Naturale and Caramello, or heat-treated Rovere), combining modern shapes and traditional manufacture. They have two different heights and diameter, to meet different lifestyle needs (H 520 mm with diameter 450 mm / H 375 mm with diameter 600 mm) and can stand alone or in multiple compositions.



In queste pagine i tavolini Madera con piano impiallacciato in Rovere Termotrattato, Rovere nodato Naturale o Cramello: tre varianti che evidenziano le diverse personalità delle varie essenze.

On these pages, Madera small tables with top veneered in heat-treated Rovere, Rovere Nodato Naturale or Caramello: three versions which show the different personalities of the various wood types.

Tavolino Madera alto
Ø 460 x H 510

Tavolino Madera basso
Ø 610 x H 370





Giro

Tavolino Giro alto
Ø 440 x H 550

I tavolini Giro sono l'espressione della libertà di muoversi nello spazio senza vincoli o schemi. Il loro basamento in metallo si conclude con un originale piano circolare laccato in tinta. Versatili e colorati, arredano con vitalità la zona giorno e la zona notte.

Giro small tables are an expression of freedom of movement in space without restraints or rules. Their metal base ends in an original circular top with same colour of lacquer finish. Versatile and colourful, they are lively furniture items for the living area or bedroom.



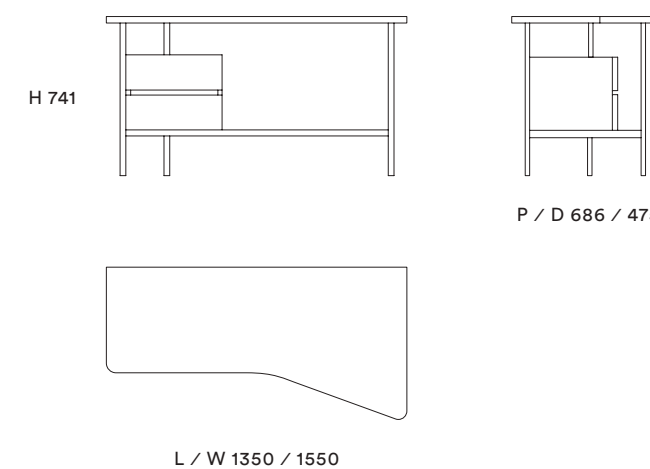

Desk

Per chi desidera creare un piccolo studio domestico o un home office, la scrivania Desk, caratterizzata dalle forme arrotondate e dal mix legno / metallo, è una soluzione ideale: struttura in metallo con montanti arrotondati e piano sagomato in legno rifinito su tutti i lati. Grazie alla combinazione dei colori, si adatta perfettamente anche alla camera dei ragazzi. Il contenimento e la funzionalità sono assicurati dalla cassettera, con vassoio superiore disponibile anche con vetro di protezione.

For those who seek to create a small home studio or home office, Desk, with its rounded shapes and wood/metal mix, is an ideal solution: metal structure with rounded uprights and shaped top in wood finished on all sides. Thanks to the combination of colours, it adapts perfectly also to the kids' room. Storage and function are ensured by the drawer unit with upper tray available also with protective glass.



Il piano scrivania sagomato, in finitura Rovere grigio è abbinato a una cassetiera sospesa nella stessa tonalità. Entrambi sono disponibili con perimetro in materico, laccato opaco, laccato lucido o legno impiallacciato. La struttura in metallo è disponibile in finitura Brown o Piombo.

The shaped desk top in Rovere Grigio finish is matched with a suspended drawer unit in the same shade. Both are available with perimeter in textural finish, matt lacquer, gloss lacquer or veneered wood. The metal structure is available in Brown or Piombo finish.



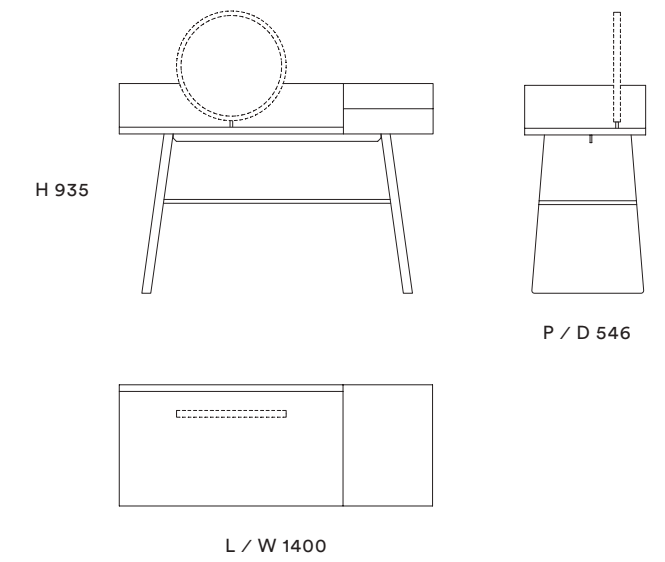

Segreto

Utilizzabile come "vanity table" o come scrittoio nella versione senza specchio, Segreto può diventare un pratico scrittoio per organizzare un home office o uno spazio dedicato alla lettura, agli appunti ed alla meditazione, esprimendo una raffinata cultura dell'arredo.

Usable as a dressing table or as a desk in the version without mirror, Segreto can become a practical desk for organising a home office or a space dedicated to reading, taking notes and meditation, expressing a refined culture of interior décor.

Scrivania Segreto

L / W 1400 x H 935 x P / D 546

Due scrivanie Segreto in laccato metallo Piombo con cassetto laccato opaco Timo, per uno studio domestico ispirato a un senso di eleganza, funzionalità e intimità.

Two Segreto desks in Piombo metal lacquer with matt lacquered Timo drawer, for a home study inspired by a sense of elegance, functionality and intimacy.



MOBILIFICIO
SANGIACOMO SPA

Indirizzo / address

Via Gallopat, n° 33
Cecchini di Pasiano
33087 — (PN) Italia
T +39 0434 6291 r.a
E sg_info@msg.it
W www.msg.it

Servizio Clienti

T +39 0434 629336 r.a.
F +39 0434 621526
E [ordini / ordini@msg.it](mailto:ordini@msg.it)

International Department

T +39 0434 6291
F +39 0434 629250
E sg_int@msg.it

Credits

Art Direction
Nicoletta Cappello

Cover Design
Studio FM milano

Photography
Franco Chimenti
Marco Covi

Rendering
Nudesign

Colour Separation
Lucegroup

Print
Lucegroup

Translation
Studio Intra

Thanks to
Laminam

L'azienda si riserva di introdurre senza preavviso
eventuali modifiche tecnico-costruttive sul prodotto
e sulle composizioni presentate. / The Company
reserves the right to make any technical or construction
modifications to the products or to the layouts shown
without prior notice.



199C2CO02



Catalogo Complementi

